

Use & Care Guide
Guía de uso y cuidada
English / Español

Model/Modelos: 790.7050*, 7060*, 7323*, 7343*

Kenmore[®]

Gas Range

Estufa de gas

* = color number, código de color

P/N 316901009 Rev D

Sears Brands Management Corporation
Hoffman Estates, IL 60179 U.S.A.

www.kenmore.com
www.sears.com



Table of Contents

Kenmore Limited Warranty	2	Setting Timer	12
IMPORTANT SAFETY INSTRUCTIONS.....	3-6	Setting Bake	12
Before Setting Oven Controls.....	7	Setting Broil	13
Before Setting Surface Controls.....	8-9	Adjusting oven temperature	14
Setting Surface Controls	10	Care & Cleaning	15-18
Oven Controls Functions	11	Before You Call - Solutions to common problems	19-20
Setting Oven Controls	12-14	Protection Agreements	21
Setting Clock.....	11	Sears Service	Back Cover

Kenmore Limited Warranty

When installed, operated and maintained according to all instructions supplied with the product, if this appliance fails due to a defect in material and workmanship within one year from the date of purchase, call 1-800-4-MY-HOME® to arrange for free repair. This warranty applies for only 90 days from the date of purchase if this appliance is ever used for other than private family purposes.

This warranty covers only defects in material and workmanship. Sears will NOT pay for:

1. Cracks in a ceramic glass cooktop that are not a result of thermal shock.
2. Stains and scratches on a ceramic glass cooktop resulting from failure to maintain it properly according to all instructions supplied with the product.
3. Expendable items that can wear out from normal use, including but not limited to filters, belts, light bulbs, and bags.
4. A service technician to instruct the user in correct product installation, operation or maintenance.
5. A service technician to clean or maintain this product.
6. Damage to or failure of this product if it is not installed, operated or maintained according to all instructions supplied with the product.
7. Damage to or failure of this product resulting from accident, abuse, misuse or use for other than its intended purpose.
8. Damage to or failure of this product caused by the use of detergents, cleaners, chemicals or utensils other than those recommended in all instructions supplied with the product.
9. Damage to or failure of parts or systems resulting from unauthorized modifications made to this product.

Disclaimer of implied warranties; limitation of remedies

Customer's sole and exclusive remedy under this limited warranty shall be product repair as provided herein. Implied warranties, including warranties of merchantability or fitness for a particular purpose, are limited to one year or the shortest period allowed by law. Sears shall not be liable for incidental or consequential damages. Some states and provinces do not allow the exclusion or limitation of incidental or consequential damages, or limitation on the duration of implied warranties of merchantability or fitness, so these exclusions or limitations may not apply to you.

This warranty applies only while this appliance is used in the United States.

This warranty gives you specific legal rights, and you may also have other rights which vary from state to state.

Sears Brands Management Corporation, Hoffman Estates, IL 60179 U.S.A.

Product Record

In this space below, record the date of purchase, model and serial number of your product. You will find the model and serial number printed on an identification plate. **See bottom of this page** for serial plate location.

Model No. 790.

Serial No. _____

Date of Purchase _____

Save sales receipt for future reference.

Serial Plate Location

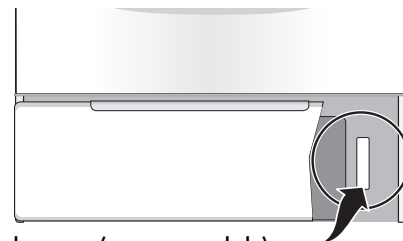

Open broiler drawer (some models) or storage drawer (some models).

All rights reserved. Printed in the USA.

Important Safety Instructions

Read all instructions before using this appliance.

This manual contains important safety symbols and instructions. Please pay attention to these symbols and follow all instructions given.

Definitions

⚠ This is the safety alert symbol. It is used to alert you to potential personal injury hazards. Obey all safety messages that follow this symbol to avoid possible injury or death.

Do not attempt to install or operate your appliance until you have read the safety precautions in this manual. Safety items throughout this manual are labeled with a **WARNING** or **CAUTION** statement based on the risk type.

⚠ WARNING - indicates a potentially hazardous situation which, if not avoided, may result in death or serious injury.

⚠ CAUTION - indicates a potentially hazardous situation which, if not avoided, may result in minor or moderate injury.

- **Remove all tape and packaging before using the range.**
Destroy the carton and plastic bags after unpacking the range. Never allow children to play with packaging material.
- **Proper Installation—Be sure your appliance is properly installed and grounded by a qualified technician in accordance with the National Fuel Gas Code ANSI Z223.- latest edition, or in Canada CAN/CGA B149.1, and CAN/CGA B149.2, and the National Electrical Code ANSI/NFPA No.70-latest edition, or in Canada CSA Standard C22.1, Canadian Electrical Code, Part 1, and local code requirements.** Install only per installation instructions provided in the literature package for this range. Ask your dealer to recommend a qualified technician and an authorized repair service. Know how to disconnect the power to the range at the circuit breaker or fuse box in case of an emergency.
- **User servicing—Do not repair or replace any part of the appliance unless specifically recommended in the manuals.** All other servicing should be done only by a qualified technician. This may reduce the risk of personal injury and damage to the range.
- **Never modify or alter the construction of a range by removing the leveling legs, panels, wire covers, anti-tip brackets/screws, or any other part of the range.**
- Remove the oven door from any unused range if it is to be stored or discarded.

⚠ WARNING If the information in this manual is not followed exactly, a fire or explosion may result causing property damage, personal injury or death.

FOR YOUR SAFETY:

- Do not store or use gasoline or other flammable vapors and liquids in the vicinity of this or any other appliance.
- **WHAT TO DO IF YOU SMELL GAS:**
 - Do not try to light any appliance.
 - Do not touch any electrical switch; do not use any phone in your building.
 - Immediately call your gas supplier from a neighbor's phone. Follow the gas supplier's instructions.
 - If you cannot reach your gas supplier, call the fire department.
- Installation and service must be performed by a qualified installer, servicer or the gas supplier.

⚠ WARNING

Tip Over Hazard



- A child or adult can tip the range and be killed.
- Verify the anti-tip device has been installed to floor or wall.

- Ensure the anti-tip device is re-engaged when the range is moved to floor or wall.
- Do not operate the range without the anti-tip device in place and engaged.
- Failure to follow these instructions can result in death or serious burns to children and adults.

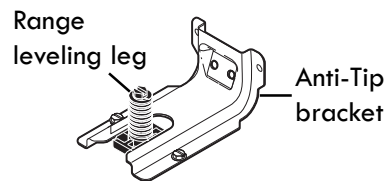

To check if the anti-tip bracket is installed properly, use both arms and grasp the rear edge of range back. Carefully attempt to tilt range forward. When properly installed, the range should not tilt forward.

Refer to the anti-tip bracket **installation instructions** supplied with your range for proper installation.

Save these instructions for future reference.

Important Safety Instructions

Air curtain or other overhead range hoods, which operate by blowing a downward air flow on to a range, shall not be used in conjunction with gas ranges other than when the hood and range have been designed, tested and listed by an independent test laboratory for use in combination with each other.

For electric ignition models only: Do not attempt to operate the range during a power failure. If the power fails, always turn off the range. If the range is not turned off and the power resumes, the range will begin to operate again. Once the power resumes, reset the clock and oven function.

Important Safety Notice

The California Safe Drinking Water and Toxic Enforcement Act requires the Governor of California to publish a list of substances known to the state to cause cancer, birth defects or other reproductive harm, and requires businesses to warn customers of potential exposure to such substances.

⚠ WARNING NEVER use this appliance as a space heater to heat or warm the room. Doing so may result in CARBON MONOXIDE poisoning.

⚠ WARNING NEVER cover any slots, holes or passages in the oven bottom or cover an entire oven rack with materials such as aluminum foil. Doing so blocks air flow through the oven and may cause CARBON MONOXIDE poisoning. Aluminum foil linings may trap heat, causing a fire hazard.

⚠ WARNING Stepping, leaning or sitting on the door or drawers of a range can result in serious injuries and also cause damage to the appliance. DO NOT allow children to climb or play around the range. The weight of a child on an open oven door may cause the range to tip, resulting in serious burns or other injury.

⚠ WARNING Storage in or on appliance — flammable materials should not be stored in an oven, near surface units or in the storage drawer, warmer drawer or lower oven. This includes paper, plastic and cloth items, such as cookbooks, plasticware and towels, as well as flammable liquids. Do not store explosives, such as aerosol cans, on or near the range.

⚠ CAUTION Do not store items of interest to children in the cabinets above a range or on the backguard of the range. Children climbing on the range to reach items could be seriously injured.

⚠ WARNING DO NOT LEAVE CHILDREN ALONE — children should not be left alone or unattended in the area where appliance is in use. They should never be allowed to sit or stand on any part of the appliance, including the storage drawer, lower broiler drawer, warmer drawer or lower double oven.

⚠ CAUTION DO NOT TOUCH SURFACE BURNERS, AREAS NEAR THESE BURNERS, OVEN BURNERS OR INTERIOR SURFACES OF THE OVEN. Both surface and oven burners may be hot even though flames are not visible. Areas near surface burners may become hot enough to cause burns. During and after use, do not touch, or let clothing or other flammable materials touch these areas until they have had sufficient time to cool. Among these areas are the cook top, surfaces facing the cook top, the oven vent openings and surfaces near these openings, oven door and window.

⚠ CAUTION Wear proper apparel — loose-fitting or hanging garments should never be worn while using the appliance. Do not let clothing or other flammable materials contact hot surfaces or open flames.

⚠ CAUTION Do not use water or flour on grease fires — smother the fire with a pan lid, or use baking soda, a dry chemical or foam-type extinguisher.

⚠ CAUTION When heating fat or grease, watch it closely. Fat or grease may catch fire if allowed to become too hot.

⚠ CAUTION Use dry potholders — moist or damp potholders on hot surfaces may result in burns from steam. Do not let potholders touch hot heating elements. Do not use a towel or other bulky cloth instead of a potholder.

⚠ CAUTION Do not heat unopened food containers — buildup of pressure may cause container to burst and result in injury.

Important Safety Instructions

IMPORTANT INSTRUCTIONS FOR USING YOUR COOKTOP

⚠ WARNING Use Proper Flame Size — Adjust flame size so it does not extend beyond the edge of the utensil. The use of undersized utensils will expose a portion of the burner flame to direct contact and may result in ignition of clothing. Proper relationship of utensil to flame will also improve efficiency.

- **Know which knob controls each surface burner.** Place a pan of food on the burner before turning it on, and turn the burner off before removing the pan.
- **Always turn knob to the full LITE position when igniting top burners.** Visually check that burner has lit. Then adjust the flame so it does not extend beyond the edge of the utensil.
- **Utensil handles should be turned inward and not extend over adjacent surface burners** — To reduce the risk of burns, ignition of flammable materials, and spillage due to unintentional contact with the utensil, the handle of the utensil should be positioned so that it is turned inward, and does not extend over adjacent surface burners.
- **Never leave surface burners unattended at high heat settings** — Boilovers cause smoking and greasy spillovers that may ignite, or a pan that has boiled dry may melt.
- **Glazed cooking utensils** — Only certain types of glass, glass/ceramic, ceramic, earthenware, or other glazed utensils are suitable for cook top service without breaking due to the sudden change in temperature. Check the manufacturer's recommendations for cook top use.
- **When flaming foods under a ventilating hood, turn the fan on.**

IMPORTANT INSTRUCTIONS FOR USING YOUR OVEN

⚠ CAUTION Protective Liners — **DO NOT use aluminum foil to line the oven bottom.** Only use aluminum foil as recommended in this manual. Improper installation of these liners may result in risk of electric shock, or fire.

- **Use care when opening oven door , warmer drawer or lower oven door** — Stand to the side of the range when opening the door of a hot oven. Let hot air or steam escape before you remove or replace food in the oven.
- **Keep oven vent ducts unobstructed.** The oven vent is located below the backguard. Touching the surfaces in this area when the oven is operating may cause severe burns. Also, do not place plastic or heat-sensitive items on or near the oven vent. These items could melt or ignite.
- **Placement of Oven Racks.** Always place oven racks in desired location while oven is cool. If rack must be moved while oven is hot use extreme caution. Use potholders and grasp the rack with both hands to reposition. Do not let potholders contact the hot heating elements in the oven. Remove all utensils from the rack before moving.
- **Do not use the broiler pan without its insert.** The broiler pan and its insert allow dripping fat to drain and be kept away from the high heat of the broiler.
- **Do not cover the broiler insert with aluminum foil.** Exposed fat and grease could ignite.

Important Safety Instructions

IMPORTANT INSTRUCTIONS FOR CLEANING YOUR RANGE

⚠ CAUTION Before manually cleaning any part of the range, be sure all controls are turned OFF and the range is COOL. The range may be hot and can cause burns.

- Clean the range regularly to keep all parts free of grease that could catch fire. Pay particular attention to the area around each surface burner. Do not allow grease to accumulate.
- Kitchen cleaners and aerosols — Always follow the manufacturer's recommended directions for use. Be aware that excess residue from cleaners and aerosols may ignite causing damage and injury.
- Clean ventilating hoods frequently — Grease should not be allowed to accumulate on the hood or filter. Follow the manufacturer's instructions for cleaning hoods.

Grounding Instructions

⚠ WARNING Avoid fire hazard or electrical shock. DO NOT use an adapter plug, an extension cord, or remove grounding prong from electrical power cord. Failure to follow this warning can cause serious injury, fire or death.

This appliance is equipped with a 3-prong grounding plug for your protection against shock hazard and should be plugged directly into a properly grounded receptacle. DO NOT cut or remove the grounding prong from this plug.

For personal safety, the range must be properly grounded. For maximum safety, the power cord must be plugged into an electrical outlet that is correctly polarized and properly grounded.

If a 2-prong wall receptacle is the only available outlet, it is the personal responsibility of the consumer to have it replaced with a properly grounded 3-prong wall receptacle installed by a qualified electrician.

See the INSTALLATION INSTRUCTIONS packaged with this range for complete installation and grounding instructions.

Grounding type wall receptacle

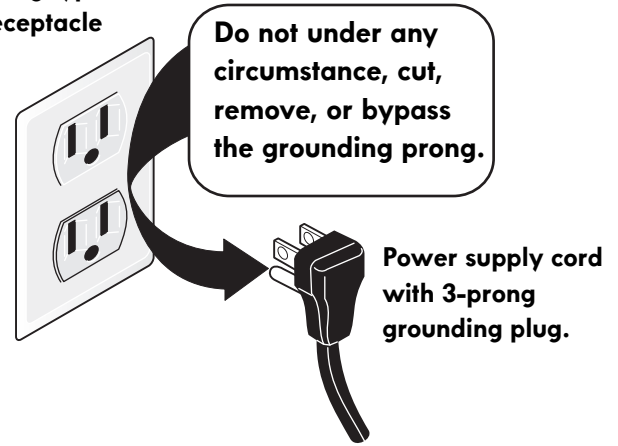

Conversion to L.P. Gas

⚠ WARNING Personal injury or death from electrical shock may occur if the range is not installed by a qualified installer or electrician.

⚠ WARNING Any additions, changes or conversions required in order for this appliance to satisfactorily meet the application needs must be made by a qualified technician.

This appliance allows for conversion to Liquefied Petroleum (L.P.) Gas.

If L.P. conversion is needed, contact your local L.P. Gas provider for assistance. The L.P. conversion kit is provided with this appliance and is located on the lower REAR (back side) panel of the range. Before installing the kit be sure to follow the L.P. Installation Instructions carefully.

Before Setting Oven Controls

Oven vent location

The oven vent is located **below the control panel** (Refer to Fig. 1). When the oven is on, warm air passes through this vent. This venting is necessary for proper air circulation in the oven and good baking results. **Do not block the oven vent.**

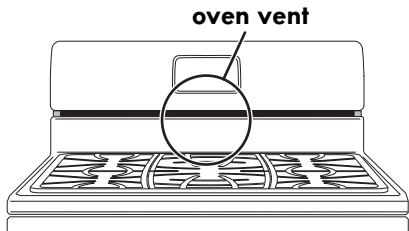

Fig. 1

Removing, replacing and arranging racks

CAUTION Always use oven mitts when using the oven. When cooking using the oven, the oven interior, oven racks and cooktop will become very hot which can cause burns.

Arranging - always arrange the oven racks when the oven is cool (prior to operating the oven).

To remove - pull the rack forward until it stops. Lift up front of rack and slide out.

To replace - fit the rack onto the guides on the oven walls. Tilt the front of the rack upward and slide the rack back into place.

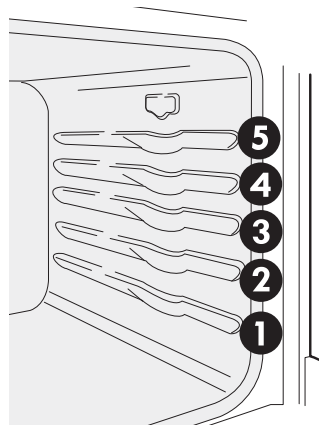

Fig. 2

Recommended oven rack positions by food type:

(Refer to Fig. 2 for oven rack positions)

Food type	Position
Broiling	See broil
Cookies, cakes, pies, biscuits & muffins	2 or 3
Frozen pies, angel food cake, yeast, bread and casseroles	1 or 2
Small cuts of meat or poultry	1 or 2
Turkey, roast or ham	1

Types of oven racks

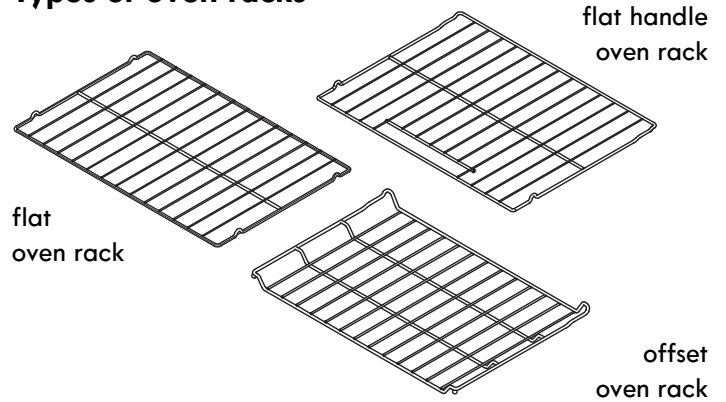

The flat oven rack or flat handle oven rack (on some models) may be used for most cooking needs.

The offset oven rack (on some models) will place the base of the rack about 1/2 of a rack position lower than a flat oven rack. This feature provides several additional possible oven rack positions.

Air circulation in the oven

For best baking results allow 2-4" (5-10 cm) around the cookware for proper air circulation and be sure pans and cookware do not touch each other, the oven door, sides or back of the oven cavity. Hot air must be able to circulate around the pans and cookware in the oven for even heat to reach around the food.

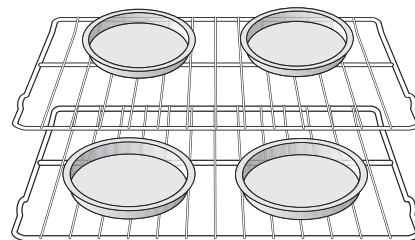

Before Setting Surface Controls

Check burner cap placement before operating the surface burners

⚠ WARNING To prevent flare-ups and avoid creation of harmful by-products, **do not** use the cooktop without all burner caps properly installed to insure proper ignition and gas flame size.

It is **very important** to be sure that all surface burner caps and burner grates are properly installed and in the correct locations **BEFORE** operating the cooktop burners.

Remember:

- **Always** keep surface burner caps in place **whenever using a surface burner**.
- When placing the burner caps, be sure that all burner caps are **seated firmly and rest level on top of burner heads**.
- For proper flow of gas and ignition of burners **DO NOT** allow spills, food, cleaning agents or any other material to enter the gas orifice port opening.

On **round** style burners, the burner cap lip (See Fig. 1) should fit snug into the center of burner head and rest level. Refer to Figs. 2 & 3 for correct and incorrect burner cap placement. Once in place, you may check the fit by gently sliding the burner cap from side to side (Fig. 4) to be sure it is centered and firmly seated. When the burner cap lip makes contact inside the center of the burner head you will be able to hear the burner cap click. Please note that the burner cap should **NOT** move off the center of the burner head when sliding from side to side.

Check and be sure that all **oval** style (some models) burner caps are correctly in place on oval burner heads.

Installing burner grates

⚠ CAUTION Do not use the surface burners without the burner caps and burner grates properly installed. Missing pieces or improper installation may lead to spills, burns, or damage to your range and cookware.

Make sure the burner grates are properly placed on the cooktop before using the surface burners. The grates are designed to rest inside the recess on the cooktop.

To install burner grates, place grates flat-side down and align into the cooktop recess. Grates should rest flush against each other and against the sides of the recess.

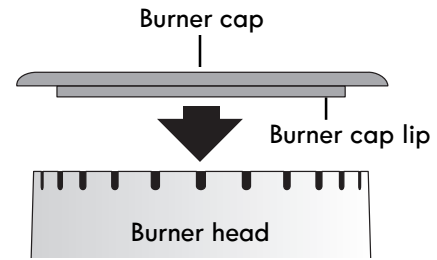
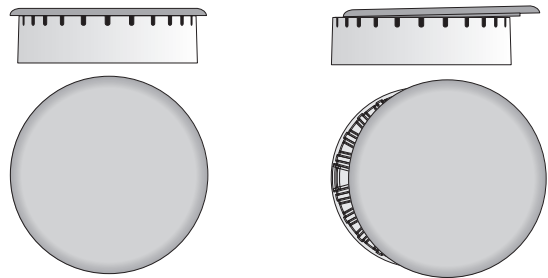

Fig. 1



Correct burner cap placement

Fig. 2

Incorrect burner cap placement

Fig. 3

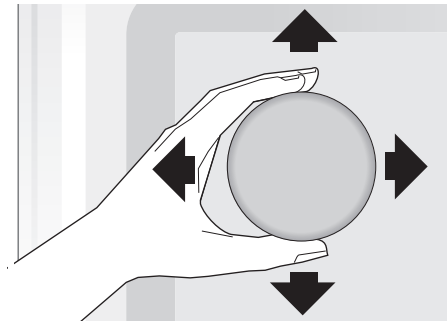

Fig. 4

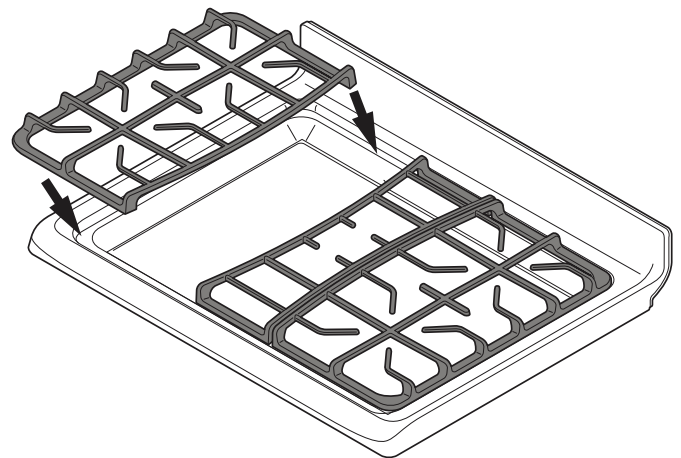

Fig. 5

Before Setting Surface Controls

Using proper cookware

⚠ CAUTION DO NOT place flammable items such as plastic salt and pepper shakers, spoon holders or plastic wrappings on the cooktop when it is in use. These items could melt or ignite. Potholders, towels or wooden spoons could catch fire if placed too close to the range cooktop.

Important: DO NOT place aluminum foil, or ANY material that can melt on the range cooktop. If these items melt they may damage the cooktop.

For best cooking results, cookware should have flat bottoms that rest level on the burner grate. Before using cookware, check for flatness by rotating a ruler across the bottom of the cookware (Fig. 1).

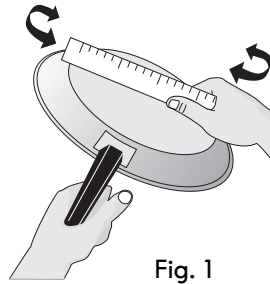

Please note: The size and type of utensil used, and the amount and type of food being cooked will influence the burner flame setting needed for best cooking results.

Cookware material types

The most popular materials available are:

Aluminum - Excellent heat conductor. Some types of food will cause it to darken (Anodized aluminum cookware resists staining & pitting).

Copper - Excellent heat conductor but discolors easily.

Stainless - Slow heat conductor with uneven cooking results. Is durable, easy to clean and resists staining.

Cast Iron - A slow heat conductor however will retain heat very well. Cooks evenly once cooking temperature is reached.

Porcelain-enamel on metal - Heating characteristics will vary depending on base material.

Glass - Slow heat conductor.

Setting proper burner flame size

⚠ CAUTION Never extend the flame beyond the outer edge of the cooking utensil. A higher flame wastes energy, and increases your risk of being burned by the flame.

The color of the flame is the key to proper burner adjustment. A good flame is clear, blue and hardly visible in a well-lighted room. Each cone of flame should be steady and sharp. Adjust or clean burner if flame is yellow-orange.

For most cooking; start on the highest setting and then turn to a lower setting to complete the process. Use the recommendations below as a guide for determining proper flame size for various types of cooking (Fig. 2)

For deep fat frying; use a thermometer and adjust the surface knob accordingly. If the fat is too cool, the food will absorb the fat and be greasy. If the fat is too hot, the food will brown so quickly that the center will be under cooked. Do not attempt to deep fat fry too much food at once as the food will neither brown or cook properly.

Flame size*	Type of cooking
High flame	Start most foods; bring water to a boil; pan broiling.
Medium flame	Maintain a slow boil; thicken sauces, gravies; steaming.
Low flame	Keep foods cooking; poach; stewing.

Fig. 2

*These settings are based for medium-weight metal or aluminum pans with lids. Settings may vary when using other types of pans.

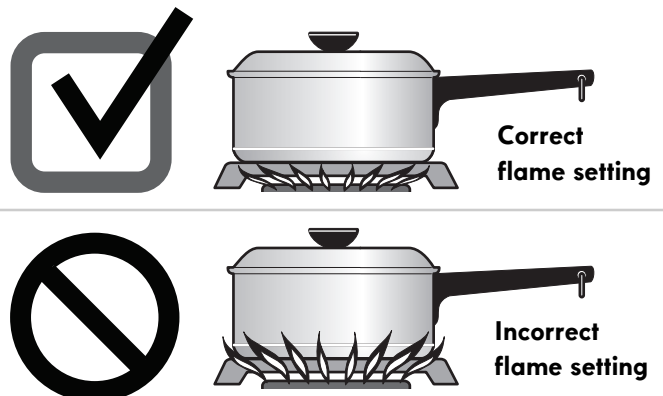

Setting Surface Controls

Setting surface burners

Your gas appliance may be equipped with different sized surface burners. The ability to heat food quicker and in larger volumes increases as the burner size increases. It is important to select cookware that is suitable for the amount and type of food being prepared.

The smaller **SIMMER** burner (on some models) is best suited for simmering delicate sauces, etc.

The **standard** size burners may be used for most surface cooking needs. Some models are equipped with a center burner.

The larger **POWER** burners (on some models) or **TURBO BOIL** burner (on some models) are recommended for bringing large quantities of liquid to temperature and when preparing larger quantities of food.

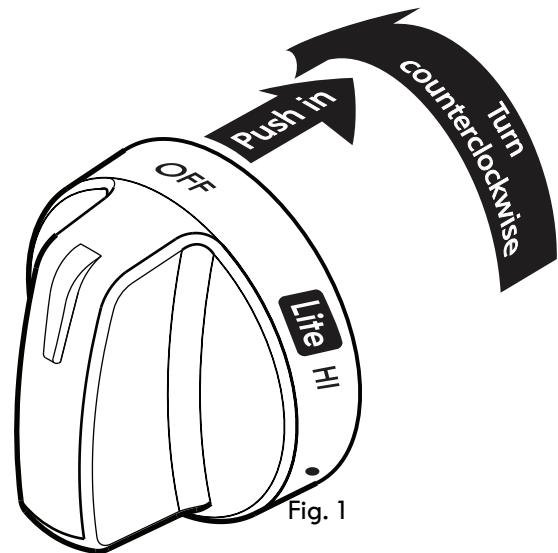

Fig. 1

To set surface burners:

1. Place cooking utensil on center of surface burner grate. Be sure the cooking utensil sets stable on the burner grate.
2. Push the desired surface control knob in and turn counterclockwise out of the **OFF** position (Fig. 1).
3. Release the surface control knob and rotate to the **LITE** position. Visually check that the burner has lit.
4. Once the burner has a flame, push the control knob in and turn counterclockwise to the desired flame size. Use the control knob markings and adjust the flame as needed.

Important notes:

- **DO NOT** cook with the surface control knob left in the LITE position. The electronic ignitor will continue to spark if the control knob setting remains in the LITE position .
- When setting any surface control knob to the LITE position, all electronic surface ignitors will spark at the same time. However, only the surface burner you are setting will ignite.
- **NEVER** place or straddle a cooking utensil over 2 different surface cooking areas at the same time. This can cause uneven heating results.
- In the event of an electrical power outage, the surface burners can be lit manually. Use caution when lighting surface burners manually. To light a surface burner, hold a lit match to the burner head, then slowly turn the surface control knob to LITE. After burner lights push in and turn knob to desired setting.
- When operating the oven, it is possible for residual heat from the oven to build-up and over time to eventually transfer to the surface control knobs located directly above the oven door.

⚠ CAUTION Do not place flammable items such as plastic salt and pepper shakers, spoon holders or plastic wrappings on the cooktop when it is in use. These items could melt or ignite. Potholders, towels or wooden spoons could catch fire if placed too close to the range cooktop.

⚠ CAUTION Do not place aluminum foil, or ANY material that can melt on the range cooktop. If these items melt they may permanently damage the cooktop surface.

Home Canning

Be sure to read and observe all the following points when home canning with your appliance. Check with the USDA (United States Department of Agriculture) website and be sure to read all the information they have available as well as follow their recommendations for home canning procedures.

- Use only quality flat bottom canners when home canning. Use a straight-edge to check canner bottom.
- Use only a completely flat bottom canner.
- Make sure the diameter of the canner does not exceed 1 inch beyond the surface element markings or burner.
- Start with hot tap water to bring water to boil more quickly.
- Use the highest heat setting when first bringing the water to a boil. Once boiling is achieved, reduce heat to lowest possible setting to maintain that boil.

Oven Control Features

For satisfactory use of your oven, become familiar with the various pad features and functions of the oven as described below.

Function indicator lights - These indicator lights glow when a function is active.

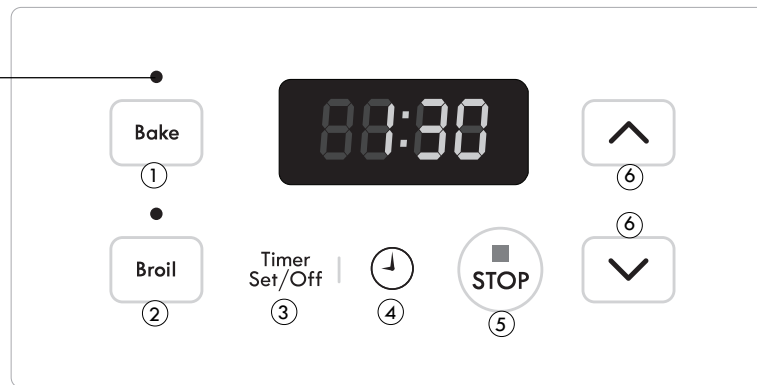

Oven control keypads

1. **Bake** - Use to select Bake function.
2. **Broil** - Use to select variable broil function.
3. **Timer Set/Off** - Use to set or cancel the timer. Timer Set/Off is used to set the continuous bake feature.
4. **Clock** - Use to set the time of day.
5. **STOP** - Use to cancel any active oven function except clock or timer.
6. **Up / Down** arrow key pads - Use with the function key pads to accept settings and to adjust temperature and times.



Setting Oven Controls

Setting Clock

When the appliance is first plugged in or when the power supply to the appliance has been interrupted, the display will flash "12:00".

You must set the clock for the time of day before using the appliance.



To set the clock:

1. Press  key pad once (do not hold key pad down).
2. Within 5 seconds, press and hold the  or  key pad until the correct time of day appears in the display and release key pad.
3. The clock should display the correct time of day.

Changing temperature display mode (°F or °C)

The electronic oven control is set to display °F (Fahrenheit) when shipped from the factory. The display may be changed to show either Fahrenheit or Celsius oven temperatures.

To change temperature display mode from °F to °C (Celsius) or from °C to °F (Fahrenheit):

1. Press and hold **Broil** key pad (for 6-8 seconds) until F or C appears in the display. At this time the display will show the current temperature display mode whether set for F or C. Before proceeding read the notes below.
2. Press either  or  key pad to toggle between **F** (Fahrenheit) or **C** (Celsius) mode choices.
3. To accept the change, wait until the oven control provides the acceptance beep (See Notes below).
4. The display will return to the time of day with the temperature display mode changed the next time the oven is set for Bake or Broil.

Important notes:

If at any time during the process of changing the temperature display mode you decide not to change the mode, press the  key pad once before the acceptance beep.



The temperature display mode cannot be changed when Bake or Broil is active.

Setting Oven Controls

Setting Timer

The timer allows you to track your cooking times without interfering the cooking process. The timer may be set from 1 minute up to 11 hours and 59 minutes.

To set Timer:

1. Press **Timer Set/Off**.
2. Press the  to increase the time in one minute increments. Press and hold the  to increase the time in 10 minute increments. The timer can be set for any amount of time from 1 minute to 11 hours and 59 minutes.

Note: If the  pad is pressed first, the timer will advance to 11 hours and 59 minutes.



3. When the set time has run out, the timer will sound a 3 second tone . 0:00 will show in the display until **Timer Set/Off** is pressed.

Important notes:

The Timer **will not** start or stop the cooking process. It serves as an extra timer in the kitchen that will beep when the set time has run out. The minute timer can be used alone or when Bake or Broil is active.

If another feature is active when the Timer is running, the minute timer will show in the display. To view information about other active features, press the key pad for that feature.

To change the time remaining in Timer:

While the timer is active, press and hold the  or  key pad to increase or decrease the time remaining.







To cancel the Timer before the set time has run out:

Press **Timer Set/Off** key pad once.

Setting Bake

The oven may be programmed to Bake at any temperature from 170°F to 550°F (77°C to 287°C). The factory preset bake temperature is 350°F (177°C).

To set Bake:



1. Press **Bake** key pad.  appears in display.
2. Within 5 seconds, press  or  key pad. The display will show 350°F (177°C). By pressing and holding  or  key pad, the temperature can be adjusted in 5°F increments (1°C if the control is set to display Celsius).
3. As soon as the  or  key pad is released, the oven will begin preheating to the selected temperature. As a reminder the control will beep when the oven reaches the set baking temperature.

Important notes:

To cancel Bake at any time press the  key pad.

Important: Dark or dull pans absorb more heat than shiny bakeware resulting in dark or overbrowning of foods. It may be necessary to reduce the oven temperature or cook time to prevent overbrowning of some foods. Dark pans are recommended for pies. Shiny pans are recommended for cakes, cookies and muffins.

To change oven temperature after Bake has started:

1. Press **Bake** key pad once. Visually check the bake temperature and that it needs to be changed.
2. Press the  or  key pad to increase or decrease the set temperature to the desired new oven temperature.

Setting Oven Controls

Broil

Use the Broil feature to cook meats that require direct exposure to flame heat for optimum browning. Use the broiler drawer and rack along with the broil pan and insert when broiling. The broiler drawer offers 3 different broil rack positions.

⚠ WARNING **DO NOT** use oven or broiler drawer for storage. Items placed in oven or broiler drawer will catch fire.

⚠ WARNING Should an oven fire occur, close the door and drawer and turn the oven **OFF**. If the fire continues, use a fire extinguisher. **DO NOT** put water or flour on the fire. Flour may be explosive.

⚠ CAUTION Always use oven mitts when using the oven or broiler drawer. When cooking, the oven, cooktop, broiler drawer and racks will become very hot which can cause burns.

⚠ CAUTION The broil pan and insert allows grease to drain and be kept away from high heat of the broiler. **DO NOT** use broil pan without insert. **DO NOT** cover insert with **aluminum foil**; the exposed grease could ignite.

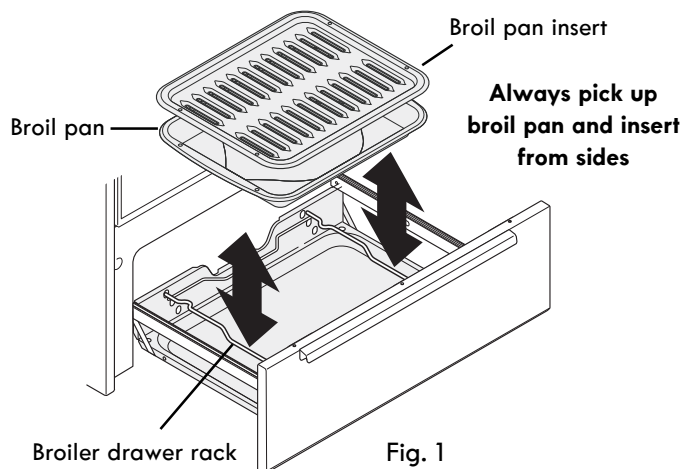



Important notes:

For medium doneness, position the broiler rack close to the oven burner (upper or middle positions). For well-done foods such as chicken, lobster tails or thick cuts of meat, position rack further away from oven burner (lower position).

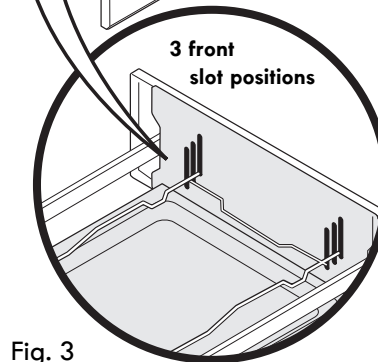
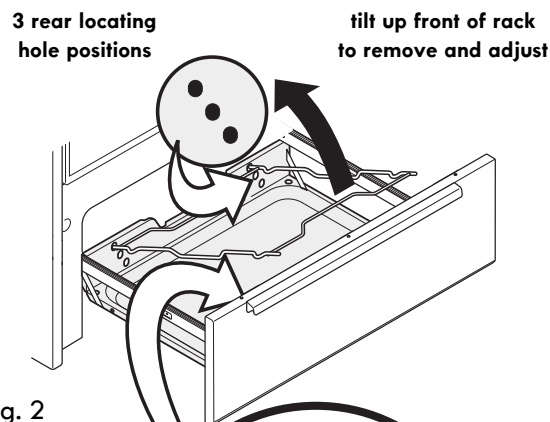
For optimum browning, close broiler drawer and **preheat broiler 5 minutes** before adding food.



To set broil:



1. Slide broiler drawer out until drawer stops.
2. Remove broiler pan and insert (See Fig. 1).
3. If needed, reposition broiler rack in broiler drawer while the range is still cool. Be sure to read broiler rack position recommendations (See **Notes**).
4. If needed, change broiler rack position by tilting front of rack up & pulling rack completely out from locating holes in rear of broiler drawer (See Fig. 2). Reposition back of rack in one of 3 locating holes and allow front of rack to slide down into the corresponding slots in front of broiler drawer (Fig. 3). Be sure rack is level before broiling.
5. Place insert on broiler pan and place prepared food on insert. Place broiler pan and insert with food into broiler on drawer rack as shown (See Fig. 1). Slide broiler drawer completely into range.
6. Press **Broil** key pad.
7. Press the  or  key pad until the desired broil setting level appears in the display. **nor** is for normal, **hi** for high and **lo** is for low setting. Most foods can be broiled at the **hi** broil setting. Select the **lo** broil setting to avoid excess browning or drying of foods that should be broiled to the well-done stage.
8. Broil on one side until food is browned; turn and broil on other side.
9. When finished broiling or to cancel broil at any time press  key pad.

Setting Oven Controls



Adjusting oven temperature

Your appliance has been factory calibrated and tested to ensure an accurate baking temperature. For the first few uses, follow your recipe times and temperature recommendations carefully. If you think the oven is cooking too hot or too cool for your recipe times, you can adjust the control so the oven cooks hotter or cooler than the temperature displayed.

To adjust oven temperature:

1. Press & hold the **Bake** key pad and release after the display shows the factory temperature setting of 00. If the oven temperature has been previously adjusted from the factory setting, the latest adjusted value will appear in the display instead.
2. You may increase the oven temperature in 5°F increments with each press of the  key pad. You may also adjust the oven temperature downward in 5°F increments with each press of the  key pad (total adjustment range is +35°F to -35°F).
3. To accept the change, wait until the oven control provides the acceptance beep (See Notes).
4. The oven temperature adjustment has been accepted by the oven control and the display will return to the time of day.

Important notes:

- If at any time during the process of adjusting the oven temperature feature you decide not to make the change, press the  key pad once before the acceptance beep tone.
- The oven temperature adjustment feature can not be modified if Bake or Broil is active.
- The oven temperature adjustment may be made if your oven control has been set for °C (Celsius) temperature display mode. In this case each press of the  or  key pad will adjust in 1°C increments upward (maximum +18°C) or downward (maximum -18°C), depending on which arrow key pad is pressed.
- **DO NOT USE** oven thermometers such as those found in grocery stores to check the temperature settings inside your oven. These oven thermometers may vary as much as 20 to 40°F from actual temperatures.

Operating oven light (on some models)

The interior oven light will automatically turn ON when the oven door is opened. Press the oven light switch located on the upper left control panel to turn the interior oven light ON and OFF whenever the oven door is closed.

If your model is equipped with an interior oven light, the light is located at the upper left rear wall of the oven interior. To replace the interior oven light, see the **Care & Cleaning** section for more information.

Care & Cleaning

Cleaning recommendation table

Surface type	Recommendation
Control knobs Painted body parts Painted decorative trim Aluminum, plastic or vinyl trim pieces	For general cleaning, use hot, soapy water and a cloth. For more difficult soils and built-up grease, apply a liquid detergent directly onto the soil. Leave on soil for 30-60 minutes. Rinse with a damp cloth and dry. Do not use abrasive cleaners on any of these materials; they can scratch. To remove control knobs, turn to OFF position; grasp firmly and pull straight off the shaft. To replace knobs after cleaning, line up the flat sides of both knob and shaft; then push knob into place.
Control panel Control key pad membrane Decorative trim (some models)	Before cleaning the control panel, turn all controls OFF, activate oven lockout (on some models) and if needed remove any knobs from panel. Clean using hot, soapy water and a dishcloth. Be sure to squeeze excess water from dishcloth before wiping control panel; especially when wiping around the controls area. Excess water in or around the controls may cause damage to the appliance. When rinsing, use clean water and a dishcloth and be sure to squeeze excess water from dishcloth before wiping the control panel.
Oven interior & door liner Porcelain enamel broil pan and broil pan insert (some models)	<p>Gentle scrubbing with a soapy no-scratch cleaning pad will remove most spots. Rinse with a 1:1 solution of clear water and ammonia. If necessary, cover difficult spots with an ammonia-soaked paper towel for 30 to 40 minutes. Rinse with clean water and a damp cloth, and then scrub with a soap-filled no-scratch cleaning pad. Rinse and wipe dry with a clean cloth. Do not allow food spills with high sugar or acid content (milk, tomatoes, sauerkraut, fruit juices or pie filling) to remain on the surface; they may cause a dull spot even after cleaning.</p> <p>The oven interior is porcelain coated and safe to clean with oven cleaners following manufacturer's instructions. After cleaning, remove any oven cleaner or the porcelain may become damaged during future heating. Do not spray oven cleaner on any electrical controls or switches. Do not spray or allow oven cleaner to build up on oven temperature sensing bulb. Do not spray cleaner on oven door trim, door gasket, plastic drawer glides, handles or any exterior surfaces of the range. Clean any soils from oven frame and door liner outside the oven door gasket. Clean with hot, soapy water. Rinse using clean water and a cloth. For additional cleaning information see General cleaning in the Care & Cleaning section.</p>
Oven racks	Remove oven racks from oven cavity before cleaning. Clean by using a mild, abrasive cleaner following manufacturer's instructions. Rinse with clean water, dry and then replace in oven.
Oven door	Use soap & water to thoroughly clean the top, sides and front of the oven door. Rinse well. You may use a glass cleaner on the outside glass of the oven door. Do not immerse the door in water. Do not spray or allow water or the glass cleaner to enter the door vents. Do not use oven cleaners, cleaning powders or any harsh abrasive cleaning materials on the outside of the oven door.
Stainless Steel (on some models)	Only use cleaners and polishes that are specifically manufactured for cleaning stainless steel. Always rub in direction of metal grain to avoid damaging. Do not use cleaners with high concentrations of chlorides or chlorine. Do not use harsh scrubbing cleaners. Polish with a lint-free cloth. Always be sure to wipe excess cleaner/polish off from the metal surface as bluish stains may occur during future oven heating that cannot be removed. Clean heavier soils with hot, soapy water and a dishcloth. Rinse and dry using clean water and a cloth.
Cooktop surface Surface burners Burner grates	Do not use spray oven cleaners on the cooktop. See Cleaning the cooktop and burner grates instructions provided in the Care & Cleaning section.

Care & Cleaning

General cleaning

⚠ CAUTION Ammonia must be rinsed before operating the oven. Provide adequate ventilation.

⚠ CAUTION Before manually cleaning any part of the range, be sure all controls are turned OFF and the range is COOL. **The range may be hot** and can cause burns.

Remove soils using hot, soapy water. Do not allow food spills with a high sugar or acid content (such as milk, tomatoes, sauerkraut, fruit juices or pie filling) to remain on the surface as they may cause a dull spot even after cleaning. Remove spillovers and heavy soiling as soon as possible. Regular cleaning will reduce the effort required for major cleaning later.

Follow these cleaning precautions:

- Allow the oven to cool before cleaning.
- Wear rubber gloves when cleaning the appliance manually.

Cleaning porcelain enamel oven and broiler drawer:

The oven interior is porcelain on steel, it is safe to clean using oven cleaners.

Adhere to the following precautions when using spray oven cleaners:

- **DO NOT** spray cleaner on the electrical controls or switches because it could cause a short circuit and result in sparking or fire.
- **DO NOT** allow a film from the cleaner to build up on the temperature sensing bulb; it could cause the oven to heat improperly. The bulb is located in the rear of the oven. Carefully wipe the bulb clean after each oven cleaning, being careful not to move the bulb. A change in its position could affect how the oven bakes. Avoid bending the bulb and capillary tube.
- **DO NOT** spray any cleaner on the oven door trim or gasket, broiler drawer glides, handles or any exterior surfaces of the range, plastic or painted surfaces. The cleaner can damage these surfaces.

To remove heavy soil:

1. Allow a dish of ammonia to sit in the oven overnight or for several hours with the oven door closed. Clean softened dirt spots using hot, soapy water. Rinse well with water and a clean cloth.
2. If soil remains, use a nonabrasive scouring pad or a nonabrasive cleaner. If necessary, use an oven cleaner following manufacturer's instructions. **DO NOT** mix ammonia with other cleaners.
3. Clean any soil from the oven frame, the door liner outside the oven door gasket and the small area at the front center of the oven bottom. Clean with hot, soapy water. Rinse well using clean water and a cloth.

Aluminum foil and utensils

⚠ WARNING NEVER cover any slots, holes or passages in the oven bottom or cover an entire oven rack with materials such as aluminum foil. Doing so blocks air flow through the oven and may cause **CARBON MONOXIDE poisoning**.

Aluminum foil linings may trap heat, causing a fire hazard.

- **Aluminum foil** - Use of aluminum foil on a hot cooktop can damage the cooktop. Do not use thin aluminum cooking utensils or allow aluminum foil to touch the surface burners under ANY circumstances.
- **Aluminum utensils** - The melting point of aluminum is much lower than that of other metals. Care must be taken when aluminum pots or pans are used on the cooktop. If aluminum pans are allowed to boil dry when using the cooktop, the utensil may be damaged or destroyed.

Cleaning oven bottom (some models)

The oven bottom is porcelain enamel and on some models may be removed for easier cleaning.

Gentle scouring with a soapy nonabrasive plastic scrubbing pad will remove most spots. Rinse with a 1:1 solution of clear water and ammonia.

If necessary, cover difficult spots with an ammonia-soaked paper towel for 30 to 40 minutes. Rinse with clean water and a damp cloth, and then scrub with a soap-filled non-abrasive scouring pad. Rinse and wipe dry with a clean cloth.

⚠ CAUTION Ammonia must be rinsed before operating the oven. Provide adequate ventilation.

Replacing oven light (on some models)

To replace the oven light:

1. Turn electrical power off at the main source or unplug the range.
2. Replace bulb with a new 40 watt appliance bulb.
3. Turn power back on again at the main source (or plug the range back in).
4. The clock will then need to be reset. To reset see "Setting clock".

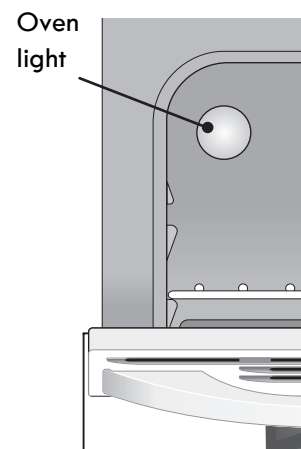

⚠ CAUTION Be sure the range is unplugged and all parts are COOL before replacing oven light. Wear a leather-faced glove for protection against possible broken glass.

Care & Cleaning

Cleaning the cooktop and surface burners

⚠ CAUTION To avoid possible burns **DO NOT** attempt any of the cooktop cleaning instructions provided before turning OFF all of the surface burners and allow them to completely cool.

⚠ CAUTION Any additions, changes or conversions required in order for this appliance to satisfactorily meet the application needs must be made by an authorized qualified agency.

Routinely clean the cooktop. Wipe with a clean, damp cloth and wipe dry to avoid scratches.

Keeping the surface burner head ports and slots clean will prevent improper ignition and an uneven flame. See the following sections for more instructions.

Cleaning recessed and contoured areas of cooktop

If a spill occurs on or in the recessed or contoured areas, blot up spill with an absorbent cloth. Rinse with a clean, damp cloth and wipe dry.

Cleaning surface burner grates

- Clean only after the grates are completely cool.
- Use nonabrasive plastic scrubbing pad and mild abrasive cleanser or clean in the dishwasher.
- Food soils containing acids may affect the finish. Clean immediately after the grates are cool.
- Thoroughly dry grates **immediately** following cleaning.

Cleaning burner caps

- Remove caps from burner heads after they have cooled.
- Clean heavy soils with a plastic scrubbing pad and absorbent cloth.
- Thoroughly dry burner caps immediately following cleaning including the bottom and inside of cap.
- Do not use abrasive cleaners. They can scratch porcelain.
- Do not clean burner caps in the dishwasher.
- **Do not operate surface burners without burner caps properly in place. Read important notes.**

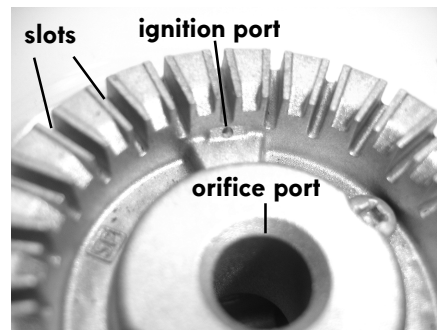

Fig. 1 - Cooktop burner head

Cleaning surface burner heads

For proper gas flow it may be necessary to clean the burner head and slots. To clean, first use a clean DAMP cloth to soak up any spills. Remove any food from between the burner slots using a small nonabrasive brush like a toothbrush and afterwards wipe up using a damp cloth. For stubborn soils located in the slots, use a small-gauge wire or needle to clean.

Any spill on or around the electrode must be carefully cleaned. Take care not to hit the electrode with anything hard or it could be damaged.

To clean the burner head ignition ports

Each burner head has a small ignition port located as shown. Should you experience ignition problems it may be that this port hole is partially blocked with soil. With the burner head in place, use a small wire gauge needle or the end of a paper clip to clear the ignition port (See Fig. 1; round style shown; oval burner on some models not shown).

Important notes:

- The surface burner heads are secured to the cooktop and must be cleaned in place on the cooktop.
- **Always** keep the surface burner caps in place **whenever a surface burner is in use.**
- When replacing the burner caps, be sure the burner caps are **seated firmly on top of the burner heads.**
- For proper flow of gas and ignition of burners **DO NOT** allow spills, food, cleaning agents or any other material to enter the gas orifice port opening.

Care & Cleaning

Removing and replacing lift-off oven door

⚠ CAUTION To avoid possible injury when removing or replacing the oven door, follow the instructions below carefully and always hold the oven door with both hands positioned away from the door hinge area.

⚠ CAUTION The door is heavy. For safe, temporary storage, lay the door flat with the inside of the door facing down.

To remove oven door:

1. Open oven door completely (horizontal with floor - See Fig. 1).
2. Remove 2 screws located on the inside of the oven door liner (See A Fig. 2).
3. Insert the 2 screws into the door hinge holes located on the side of the hinge arm, one into each hinge (See B Fig. 2).
4. Close oven door until the door stops, (do not force the door to close any further). The placement of these screws should keep door open in about a 45 degree position.
5. Grasp oven door firmly on both sides and slide door up and off hinges at the same angle (See Fig. 3).
6. To clean oven door, follow the instructions provided listed in the cleaning chart under "oven door".

To replace oven door:

1. Be sure the hinge arms remain at the 45 degree angle position. Be sure the screws are still locking the hinge arms from moving. If the screws fall out of the hinge holes, the hinge(s) may snap back against the oven frame and could pinch fingers or chip the porcelain finish on the oven front frame.
2. Hold door at the sides near the top while resting the lower front of door on your knee. Insert the door channels at the bottom of door over the door hinges, (See Fig. 3).
3. Allow the door to slide down into the door hinges evenly at the same 45 degree angle. The hinge arms should be inserted into the bottom corners as far as they can go.
4. Open door completely (horizontal with floor) and remove both screws from holes in door hinges.
5. Reinstall the 2 screws into the door liner (See C Fig. 2).
6. If the door is not in alignment with the oven frame, remove door and repeat the above steps.

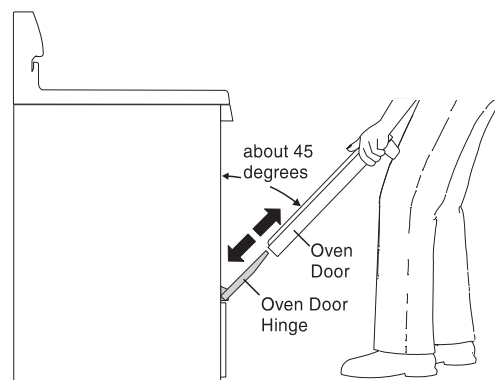
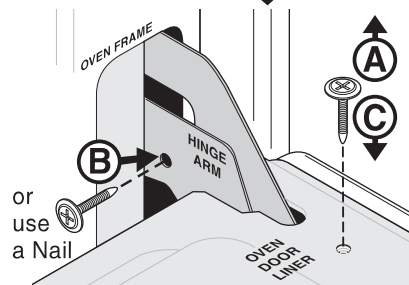
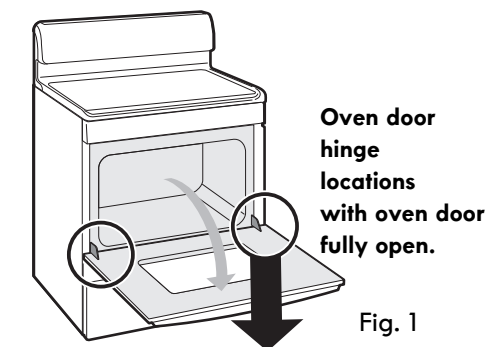

Special door care instructions -

Most oven doors contain glass that can break. Read the following recommendations:





- Do not close the oven door until all the oven racks are fully in place.
- Do not hit the oven door glass (if equipped) with pots, pans, or any other object.
- Scratching, hitting, jarring or stressing the oven door glass (if equipped) may weaken the door structure causing an increased risk of breakage at a later time.

Before You Call • Solutions to common problems

Before you call for service, review this list. It may save you time and expense.

Problem	Solution
Poor baking results.	<ul style="list-style-type: none">• Many factors affect baking results. Make sure the proper oven rack position is used. Center food in the oven and space pans to allow air to circulate. Allow the oven to preheat to the set temperature before placing food in the oven. Try adjusting the recipe's recommended temperature or baking time. If you feel the oven is too hot or cool, see Adjusting oven temperature in Setting Oven Controls section.
Entire appliance does not operate.	<ul style="list-style-type: none">• The time of day is not set. The time of day must first be set in order to operate the oven. See Setting the clock in Setting Oven Controls section.• Make sure power cord is plugged properly into outlet.• Electrical power outage. Check house lights to be sure. Call your local electric company for service outage information.• Service wiring is not complete. Call 1-800-4-MY-HOME® for assistance (See back cover).
Oven portion of appliance does not operate.	<ul style="list-style-type: none">• Be sure regulator gas valve is turned to ON. See installation instructions. The time of day is not set. The time of day must first be set in order to operate the oven. See Setting clock in Setting Oven Controls section.• Be sure the oven controls are set properly for the desired function. See Setting Oven Controls section and review instructions for the desired cooking function in this manual or see "Entire appliance does not operate" in this checklist.
Surface burners do not ignite.	<ul style="list-style-type: none">• Surface control knob was not completely turned to LITE. Push in & turn the surface control knob to LITE until burner ignites and then turn control knob to desired flame size.• Burner ports are clogged. With the burner OFF, use a small-gauge wire or needle to burner head slots and ignition ports. See Cleaning the cooktop and surface burners in the Care & Cleaning section for additional cleaning instructions.• Range power cord is disconnected from outlet (electric ignition models only). Be sure power cord is securely plugged into the power outlet.• Electrical power outage. Burners may be lit manually. See section on Setting Surface Controls.
Surface burner flame only part way around burner cap.	<ul style="list-style-type: none">• Burner slots or ports are clogged. With the surface burner OFF, clean ports with a small-gauge wire or needle.• Moisture is present after cleaning. Lightly fan the flame and allow burner to operate until flame is full.
Surface burner flame is orange.	<ul style="list-style-type: none">• Dust particles in main gas line. Allow the burner to operate a few minutes until flame turns blue. In coastal areas, a slightly orange flame is unavoidable due to salt content in air.
Oven light does not work (on some models).	<ul style="list-style-type: none">• Be sure the oven light is secure in the socket. Also see Replacing oven light in Care & Cleaning section.

Before You Call • Solutions to common problems

Problem	Solution
Oven smokes excessively during broiling.	<ul style="list-style-type: none">• Incorrect setting. Follow broil instructions in Setting Oven Controls.• Broiler drawer is open. Be sure broiler drawer is closed.• Meat too close to broil burner. Reposition the broiler drawer rack to provide proper clearance between the meat & the burner.• Meat not properly prepared. Remove excess fat from meat. Cut remaining fatty edges to prevent curling, but do not cut into lean.• Broiler pan and insert wrong side up and grease not draining. Always place insert on the broiler pan with ribs up & slots down to allow grease to drip into pan.• Grease built up on drawer surfaces. Regular cleaning is necessary when broiling frequently. Old grease or food spatters cause excessive smoking.
Flames inside oven or smoking from oven vent.	<ul style="list-style-type: none">• Excessive spillovers in oven. For example this will happen for pie spillovers or large amounts of grease left on the oven bottom. Wipe up excessive spillovers before starting oven. If flames or excessive smoke are present see Broil in Setting Oven Controls section.
Oven control panel beeps & displays any F code error.	<ul style="list-style-type: none">• Oven control has detected a fault or error condition. Press  to clear the error code. Try the Bake or Broil feature again. If the F code error repeats, remove power from appliance, wait 5 minutes and then repower appliance and set clock for the time of day. Try the Bake or Broil feature again. If the fault recurs, press the  key pad to clear. Call 1-800-4-MY-HOME® for assistance (See back cover).
Appliance is not level.	<ul style="list-style-type: none">• Be sure floor is level, strong & stable enough to adequately support range.• If floor is sagging or sloping, contact a carpenter to correct the situation.• Poor installation. Place oven rack in center of oven. Place a level on the oven rack. Adjust leveling legs at base of appliance until the rack is level.• Kitchen cabinet alignment may make range appear not level. Be sure cabinets are square & have sufficient room for appliance clearance.
Cannot move appliance easily. Appliance must be accessible for service.	<ul style="list-style-type: none">• Cabinets not square or are built in too tightly. Contact builder or installer to make appliance accessible.• Carpet interferes with appliance. Provide sufficient space so appliance can be lifted over carpet.• Gas line is hard-plumbed. Have a flexible CSA International approved metal appliance connector installed.
Oven control beeps and displays F code error.	<ul style="list-style-type: none">• Oven control has detected a fault or error condition. Press  key pad to clear the error code. Try Bake or Broil function. If the F code error repeats, remove power from appliance, wait 5 minutes and then repower appliance and set clock with the correct time of day. Try Bake or Broil function again. If the fault recurs, press  to clear and call 1-800-4-MY-HOME® for assistance (See back cover).

Protection Agreements

Acuerdos de protección

Master Protection Agreements

Congratulations on making a smart purchase. Your new Kenmore® product is designed and manufactured for years of dependable operation. But like all products, it may require preventive maintenance or repair from time to time. That's when having a Master Protection Agreement can save you money and aggravation.

The Master Protection Agreement also helps extend the life of your new product. Here's what the Agreement* includes:

- ☑ **Parts and labor** needed to help keep products operating properly **under normal use**, not just defects. Our coverage goes **well beyond the product warranty**. No deductibles, no functional failure excluded from coverage – **real protection**.
- ☑ **Expert service** by a force of more than **10,000 authorized Sears service technicians**, which means someone you can trust will be working on your product.
- ☑ **Unlimited service calls and nationwide service**, as often as you want us, whenever you want us.
- ☑ **"No-lemon" guarantee** – replacement of your covered product if four or more product failures occur within twelve months.
- ☑ **Product replacement** if your covered product can't be fixed.
- ☑ **Annual Preventive Maintenance Check** at your request – no extra charge.
- ☑ **Fast help by phone** – we call it **Rapid Resolution** – phone support from a Sears representative on all products. Think of us as a "talking owner's manual".
- ☑ **Power surge protection** against electrical damage due to power fluctuations.
- ☑ **\$250 Food Loss Protection** annually for any food spoilage that is the result of mechanical failure of any covered refrigerator or freezer.
- ☑ **Rental reimbursement** if repair of your covered product takes longer than promised.
- ☑ **10% discount** off the regular price of any non-covered repair service and related installed parts.

Once you purchase the Agreement, a simple phone call is all that it takes for you to schedule service. You can call anytime day or night, or schedule a service appointment online.

The Master Protection Agreement is a risk free purchase. If you cancel for any reason during the product warranty period, we will provide a full refund. Or, a prorated refund anytime after the product warranty period expires. Purchase your Master Protection Agreement today!

Some limitations and exclusions apply. For prices and additional information in the U.S.A. call 1-800-827-6655.

*** Coverage in Canada varies on some items. For full details call Sears Canada at 1-800-361-6665.**

Sears Installation Service

*For Sears professional installation of home appliances, garage door openers, water heaters, and other major home items, in the U.S.A. or Canada call **1-800-4-MY-HOME®**.*

Acuerdos maestros de protección

Enhorabuena por haber hecho una compra inteligente. Su nuevo producto Kenmore® está diseñado y fabricado para brindarle años de funcionamiento fiable. Pero, como cualquier producto, puede necesitar mantenimiento preventivo o reparaciones periódicas. Es por eso que tener un Acuerdo maestro de protección podría ahorrarle dinero y molestias.

El Acuerdo maestro de protección también sirve para prolongar la durabilidad de su nuevo producto. El acuerdo* incluye lo siguiente:

- ☑ **Piezas y mano de obra** necesarias para contribuir a mantener el funcionamiento adecuado de los productos **utilizados en condiciones normales de uso**, no sólo en caso de defectos de los productos. Nuestra cobertura va **mucho más allá que la garantía del producto**. No se aplican deducibles ni exclusiones por fallas del funcionamiento: es decir, **verdadera protección**.
- ☑ **Servicio técnico por expertos** (más de **10000 técnicos autorizados de Sears**), lo cual significa que quien repare o realice el mantenimiento de su producto será un profesional de confianza.
- ☑ **Servicio técnico a escala nacional y número ilimitado de llamadas de solicitud de servicio técnico**: se puede poner en contacto con nosotros cuantas veces lo desee y cuando lo desee.
- ☑ **Garantía "sin sorpresas"**: se reemplaza el producto cubierto por el acuerdo si ocurren cuatro o más fallas del producto en un periodo de 12 meses.
- ☑ **Reemplazo del producto**: en caso de que no se pueda reparar el producto cubierto por el acuerdo.
- ☑ **Revisión anual preventiva de mantenimiento del producto**: puede solicitarla en cualquier momento, sin costo alguno.
- ☑ **Rápida asistencia telefónica**, la cual denominamos **Solución rápida**: es decir, asistencia telefónica a través de cualquiera de nuestros representantes de Sears, sobre cualquiera de nuestros productos. Piense en nosotros como en un "manual parlante del usuario".
- ☑ **Protección contra fallas eléctricas**, contra daños debidos a fluctuaciones de la corriente eléctrica.
- ☑ **\$250 al año para cubrir cualquier posible deterioro de alimentos** que haya tenido que desechar debido a una falla mecánica de cualquiera de nuestros refrigeradores o congeladores cubiertos por este acuerdo.
- ☑ **Devolución de gastos de alquiler de electrodomésticos** si la reparación de su producto asegurado toma más que el tiempo prometido.
- ☑ **10% de descuento** aplicable tanto a los costos del servicio de reparación, como de las piezas instaladas relacionadas que no hayan quedado cubiertos por este acuerdo.

Una vez que haya realizado el pago de este acuerdo, bastará una simple llamada telefónica para concertar una visita de servicio. Puede llamar a cualquier hora del día o de la noche, o bien concertar una visita de servicio por Internet.

La adquisición del Acuerdo maestro de protección es una inversión exenta de riesgos. Si por cualquier motivo decide cancelar dicho acuerdo durante el periodo de garantía del producto, le haremos un reintegro total del valor. O bien un importe proporcional si cancela el acuerdo en cualquier otro momento posterior al vencimiento del periodo de garantía del producto. ¡Adquiera hoy mismo su Acuerdo maestro de protección!

Algunas limitaciones y exclusiones podrían aplicarse. Para solicitar precios e información adicional, llame al 1-800-827-6655 (en los EE.UU.).

*** La cobertura en Canadá varía en el caso de algunos artículos. Para obtener detalles completos al respecto, llame al 1-800-361-6665 de Sears de Canadá.**

Servicio de instalación de Sears

*Para solicitar la instalación por profesionales de Sears de electrodomésticos, abridores de puertas de garaje, calentadores de agua y otros artículos de uso prioritario en el hogar, llame al **1-800-4-MY-HOME** en los EE.UU. o Canadá.*

Get it fixed, at your home or ours!

Your Home

For troubleshooting, product manuals and expert advice:



www.managemylife.com

For repair – **in your home** – of **all** major brand appliances, lawn and garden equipment, or heating and cooling systems, **no matter who made it, no matter who sold it!**

For the replacement parts, accessories and owner's manuals that you need to do-it-yourself.

For Sears professional installation of home appliances and items like garage door openers and water heaters.

1-800-4-MY-HOME[®] (1-800-469-4663)

Call anytime, day or night (U.S.A. and Canada)

www.sears.com www.sears.ca

Our Home

For repair of carry-in items like vacuums, lawn equipment, and electronics, call anytime for the location of your nearest

Sears Parts & Repair Service Center

1-800-488-1222 (U.S.A.) **1-800-469-4663** (Canada)

www.sears.com www.sears.ca

To purchase a protection agreement on a product serviced by Sears:

1-800-827-6655 (U.S.A.) **1-800-361-6665** (Canada)

Para pedir servicio de reparación a domicilio, y para ordenar piezas:

1-888-SU-HOGAR[®]

(1-888-784-6427)

www.sears.com

Au Canada pour service en français:

1-800-LE-FOYER^{MC}

(1-800-533-6937)

www.sears.ca

sears

® Registered Trademark / TM Trademark of KCD IP, LLC in the United States, or Sears Brands, LLC in other countries

® Marca Registrada / TM Marca de Fábrica de KCD IP, LLC en Estados Unidos, o Sears Brands, LLC in otros países

^{MC} Marque de commerce / ^{MD} Marque déposée de Sears Brands, LLC