

8000 & 8000 Q Series

Positive Displacement Blowers
& Vacuum Pumps



GD
GARDNER DENVER

Experience Proven Results

8000 & 8000 Q Series

Delivering More

- Throughout history, Gardner Denver has continually raised the standard of every product we've designed and manufactured
- The 8000/8000 Q Series positive displacement blowers are examples of this commitment
- Each Gardner Denver model is designed and built by highly skilled crafts persons to ISO 9001 certified quality standards utilizing the highest quality materials
- Exhaustive testing against strict standards insures top performance and reliability over the long haul
- Every blower is supported by a worldwide network of trained professionals and backed by a warranty:
 - 18 months from the date of shipment or
 - 12 months from the date of installation



8000 Series



8000 Q Series

Creativity, Engineering and Craftsmanship

- The heart of the 8000/8000 Q Series is an enhanced rotor profile
- Computer designed and precision machined at our state-of-the-art manufacturing facility
- Each rotor set produces less internal slip, reduces temperature rise and increases blower efficiency
- Rotor shaft diameter and bearing sizes have been increased to allow blower operation at higher pressures without sacrificing bearing life
- These advanced design features allow the 8000/8000 Q Series of blowers to deliver greater efficiency at higher pressure and vacuum levels than ever before

A Full Range of Sizes to Fit Your Application Needs

- Available 950 CFM–18,000 CFM, 1,600 m³h–30,500 m³h
- 8000/8000 Q Series blowers deliver up to 20 PSIG, 1.4 bar discharge pressure or 16" Hg, 470 mbar vacuum to match your application requirements
- Each blower model can be custom manufactured to meet your exact specifications
- Available options
 - water injection
 - mechanical seals
 - pressure lubrication systems
 - gear end shaft arrangements
 - closed end impellers
 - high temperature clearances

Industry	Application
Milling and Baking	Blending and Conveying
Resin and Plastic	Processing and Conveying
Power Generation	Fly Ash Conveying and Aeration
Chemical	Vacuum Processing and Conveying
Wastewater	Aeration and Backwashing
Pulp and Paper	Chip Conveying and Process Vacuum
Cement and Lime	Fluidization and Conveying
Soil Remediation	Vacuum Extraction and Sparging
Air Separation	Gas Collection and Transportation
Coalbed/Landfill	Methane Gas Recovery
Process Gass	Gass Boosting
Oil & Gas	Gas Collection & Sparging



Q = Quiet

The 8000 Q Series Greatly Reduces Pulsations for Significantly Reduced Noise

- The 8000 Q Series blower reduces pulsations created at the discharge port of a straight lobed blower, as depicted in the diagrams to the right
- Pulsations are reduced by bleeding some of the discharge air or gas back through a feedback plenum into the closed pocket
- Pressure within the blower gradually increases until it nearly equals the discharge line pressure
- When the rotor tip passes the long edge of the port, there is less disturbance which creates noise and unwanted pulsations
- The Q Series option is available for 10" through 16" gear size machines
- In most applications, the option can reduce the blower's noise level by approximately 5 dBA

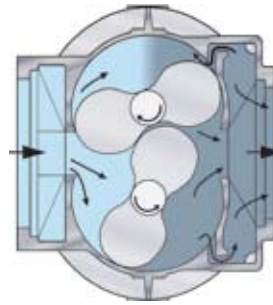

Pressure in upper pocket begins to be equalized through feedback port.

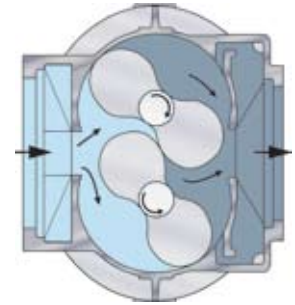

Lower air pocket about to be sealed off at inlet.

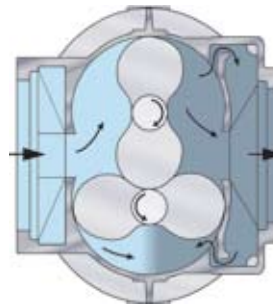

Pressure in pocket is equalized through feedback port.

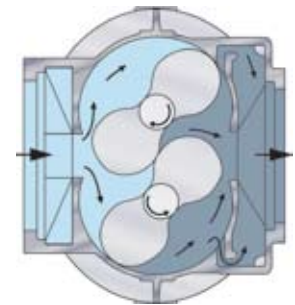

Discharged air pulsations and noise levels are greatly reduced.

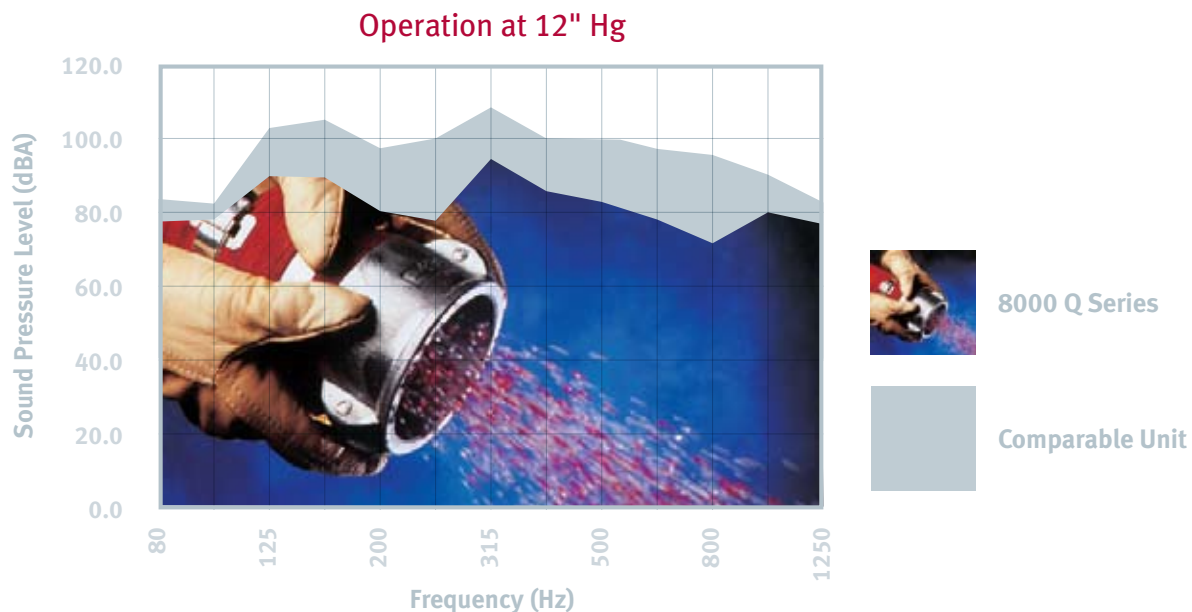

Options, Quality & Value

8000 & 8000 Q Series Map by Gear Diameter

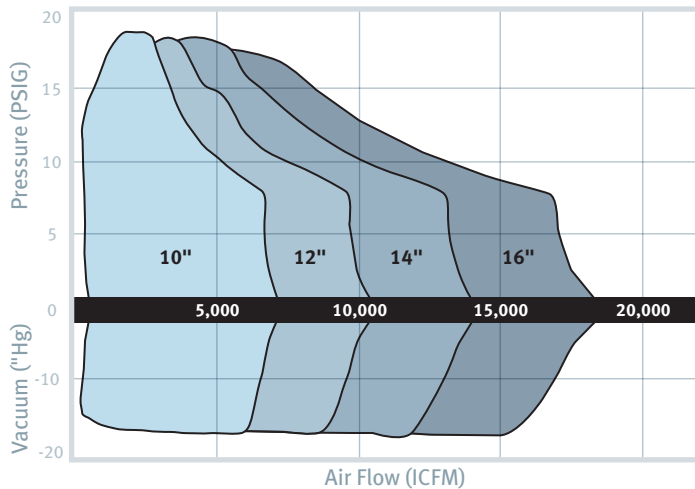

Specific Model Selection

- Over 100 individual 8000/8000 Q Series models to meet your application requirements
- For specific air demands, performance data is available through **QuickPik**, a web-based blower sizing and selection software. It can be accessed 24/7 on www.GDQuickPik.com or www.GardnerDenverProducts.com



The Gardner Denver Promise

SUPERIOR SERVICE

Customer service—including specification assistance, engineering support and blower sizing—is available from your local authorized distributor or directly from Gardner Denver

HIGHEST QUALITY AT LOWEST POSSIBLE COST

- Gardner Denver's 8000/8000 Q Series of blowers and vacuum pumps are engineered and manufactured under strict ISO 9001 quality standards
- Gardner Denver makes it a priority to invest in highly skilled people who take pride in producing quality products
- State-of-the-art CNC machining centers and labor savings material processing allow Gardner Denver to produce blowers quickly, efficiently and economically
- Attention to detail is found throughout the manufacturing process such as utilizing advanced coordinate measuring equipment (photo A)
- 8000/8000 Q Series blower components are subjected to quality inspections before assembly
- Prior to shipment, every blower is tested against rigid standards (photo B)



A — Coordinate measuring (Legend Series shown)

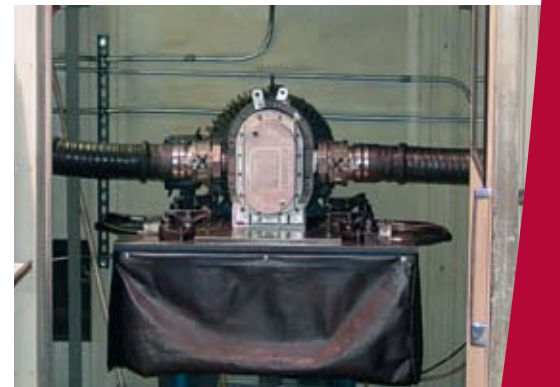

B — Testing station (Legend Series shown)

A Clear Look at Gardner Denver 8000/8000 Q's Superior Features

One-piece Steel Shafts

- Constructed of chrome alloy
- Interference-fit through the impeller and flanged to the gear end
- Larger shaft diameter to reduce torsional deflection
- Increased pressure ratings and efficiencies
- Allowing higher working loads for V-belt drives without additional bearings
- Competition utilizes bolt on shafts which transmit power through the cast rotor causing added stress loads

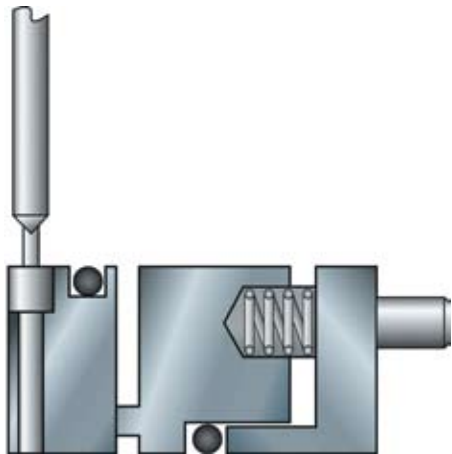

Optional Mechanical Seals

- Prevent gas leaks
- Recommended for all gas-handling applications in pressure or vacuum

Dynamically Balanced Impellers

- Constructed of high-density, ductile-iron
- Designed for smooth running and lower bearing loads

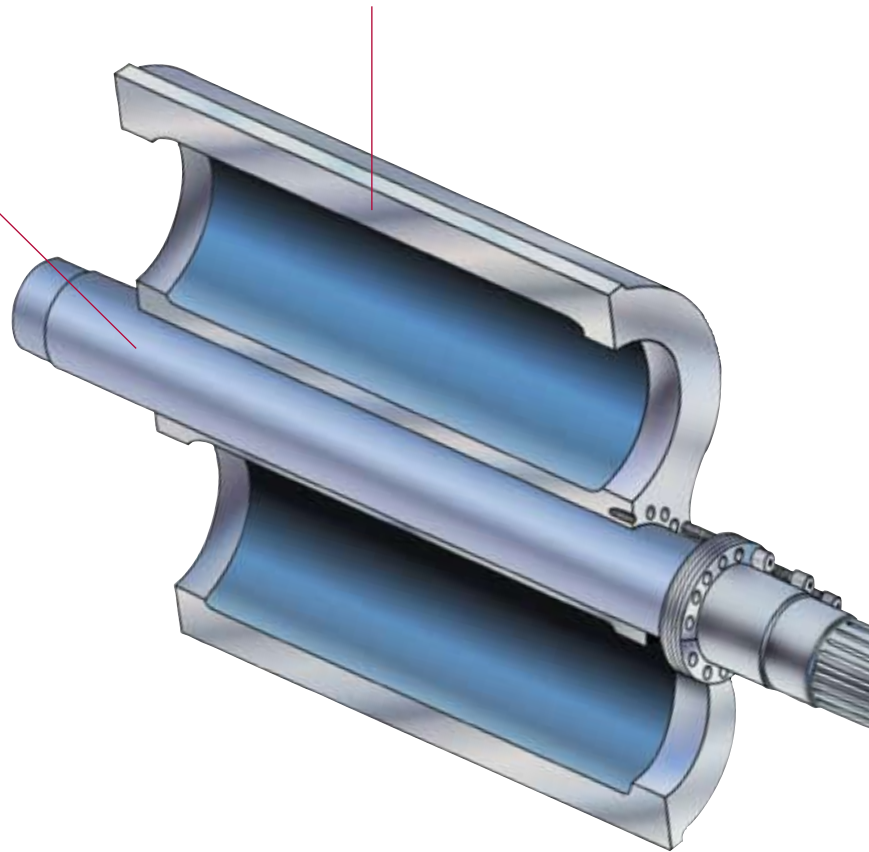

Splash Lubrication

- Effective & efficient splash lubrication of all bearing and timing gears
- Optional pressure lubrication system and oil cooler (with a unidirectional, shaft-mounted pump to deliver oil to bearings and gears from a single sump)

Heavy Duty Bearings

- Double-row, spherical roller bearings
- Held in machined bearing cartridges to allow for easy field maintenance
- Gear end bearings fixed axially against shaft shoulder
- Controls thrust loads and maintains end clearances

Viton Oil Seals and Labyrinth Air Seals

- Provide long life and reliable sealing at blower rated temperatures
- Optional mechanical seals

Heat-treated Timing Gears

- Constructed of alloy steel
- Attached to timing hubs by high tensile strength bolts
- Diameters in 10" through 14" are of helical design
- 16" are of straight spur design

Other 8000 Series Features

- High-tensile, cast-iron headplates keep all internals perfectly aligned
- Generous seal vent areas assure better sealing and longer life
- Large machined footpads offer excellent, permanent mounting surfaces
- Reinforced case design assures greater rigidity under pressure or vacuum
- Energy-saving ports with larger inlet and discharge ports allow for greater air flow and optimum air velocity

Timing Hubs

- Accurately positioned by splines on the drive shaft
- Simplifies timing and serviceability

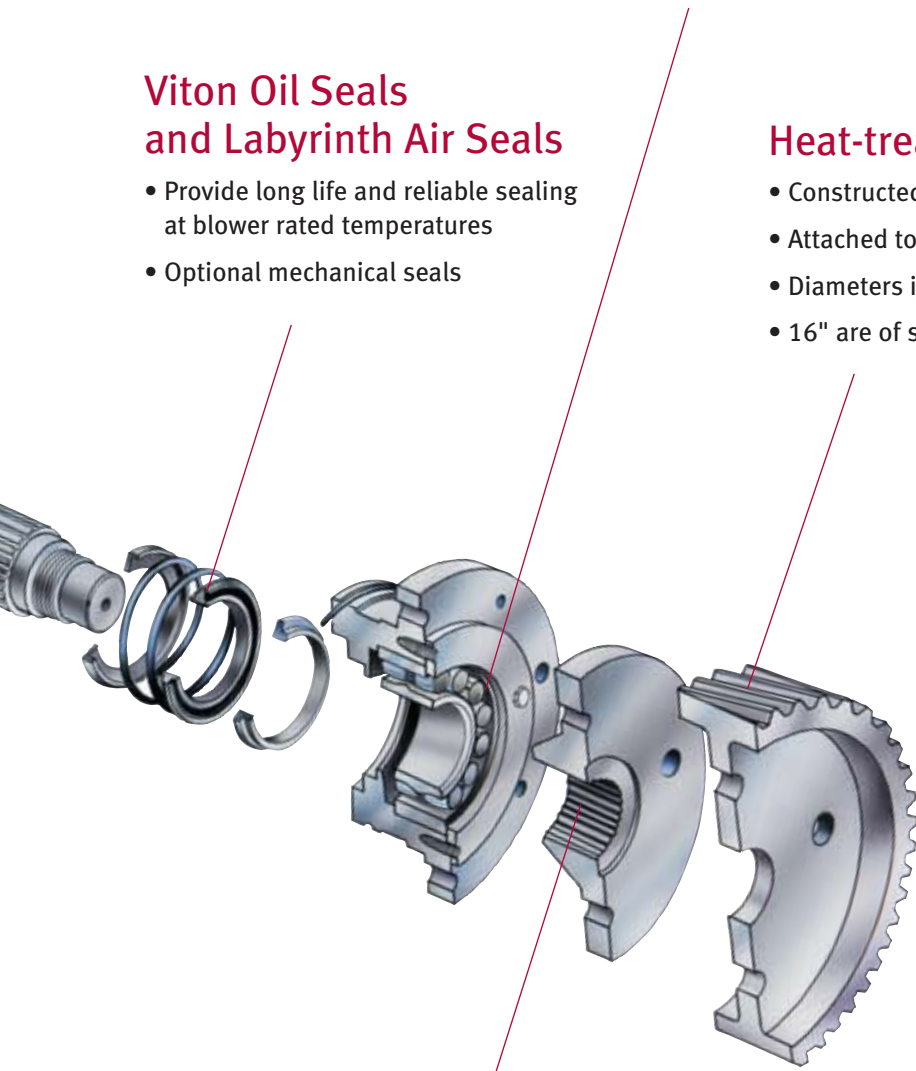

Dimensional Data – Vertical Configurations

SIZE	WT.	A	B	C	D	E	F	G	H	J _{In}	J _{Out}	K _{In}	K _{Out}	L	M	N	O	R	S	T	U	V
1008	1750	16.75	7.00	7.50	18	14.00	19.00	5	34.38	17.38	17.38	8	8	19.38	35.63	8.00	7.88	0.63	2.50	1.19	0.88	4.25
1011	1875	19.75	8.50	7.50	18	14.00	19.00	5	34.38	17.38	17.38	8	8	20.88	38.63	11.00	7.88	0.63	2.50	1.19	0.88	4.25
1013	2000	22.00	9.63	7.50	18	14.00	19.00	5	34.38	17.38	17.38	10	10	22.00	40.88	13.25	7.88	0.63	2.50	1.19	0.88	4.25
1013-Q	2092	22.00	9.63	7.50	18	14.00	19.00	5	34.38	14.25	14.25	12	10	22.00	40.88	13.25	7.88	0.63	2.50	1.19	0.88	4.25
1016	2050	24.75	11.00	7.50	18	14.00	19.00	5	34.38	12.00	12.00	10	10	23.38	43.63	16.00	7.88	0.63	2.50	1.19	0.88	4.25
1016-Q	2164	24.75	11.00	7.50	18	14.00	19.00	5	34.38	14.25	14.25	12	10	23.38	43.63	16.00	7.88	0.63	2.50	1.19	0.88	4.25
1018	2100	26.75	12.00	7.50	18	14.00	19.00	5	34.38	12.00	12.00	10	10	24.38	45.63	18.00	7.88	0.63	2.50	1.19	0.88	4.25
1018-Q	2217	26.75	12.00	7.50	18	14.00	19.00	5	34.38	14.25	14.25	12	10	24.38	45.63	18.00	7.88	0.63	2.50	1.19	0.88	4.25
1021	2165	29.75	13.50	7.50	18	14.00	19.00	5	34.38	12.00	12.00	12	12	25.88	48.63	21.00	7.88	0.63	2.50	1.19	0.88	4.25
1021-Q	2286	29.75	13.50	7.50	18	14.00	19.00	5	34.38	14.25	14.25	14	12	25.88	48.63	21.00	7.88	0.63	2.50	1.19	0.88	4.25
1024	2530	32.75	15.00	7.50	18	14.00	19.00	5	35.25	14.00	14.00	14	14	27.38	51.63	24.00	7.88	0.63	2.50	1.19	0.88	4.25
1024-Q	2697	32.75	15.00	7.50	18	14.00	19.00	5	35.25	14.25	14.25	14	12	27.38	51.63	24.00	7.88	0.63	2.50	1.19	0.88	4.25
1030	2770	38.75	18.00	7.50	18	14.00	19.00	5	35.25	14.00	14.00	14	14	30.38	57.63	30.00	7.88	0.63	2.50	1.19	0.88	4.25
1030-Q	3032	38.75	18.00	7.50	18	14.00	19.00	5	35.25	14.25	14.25	16	14	30.38	57.63	30.00	7.88	0.63	2.50	1.19	0.88	4.25
1213	2850	22.50	9.50	9.00	22	16.50	22.50	6	40.75	19.25	19.25	10	10	24.00	45.00	13.00	8.88	0.75	2.88	1.33	0.88	6.50
1216	2975	25.50	11.00	9.00	22	16.50	22.50	6	40.75	19.25	19.25	10	10	25.50	48.00	16.00	8.88	0.75	2.88	1.33	0.88	6.50
1218	3065	28.00	12.25	9.00	22	16.50	22.50	6	41.75	16.00	16.00	12	12	26.75	50.50	18.50	8.88	0.75	2.88	1.33	0.88	6.50
1218-Q	3211	28.00	12.25	9.00	22	16.50	22.50	6	41.75	16.50	16.50	16	14	26.75	50.50	18.50	8.88	0.75	2.88	1.33	0.88	6.50
1220	3340	29.50	13.00	9.00	22	16.50	22.50	6	41.75	16.00	16.00	12	12	27.50	52.00	20.00	8.88	0.75	2.88	1.33	0.88	6.50
1220-Q	3531	29.50	13.00	9.00	22	16.50	22.50	6	41.75	16.50	16.50	16	14	27.50	52.00	20.00	8.88	0.75	2.88	1.33	0.88	6.50
1223	3410	32.50	14.50	9.00	22	16.50	22.50	6	41.75	16.00	16.00	14	14	29.00	55.00	23.00	8.88	0.75	2.88	1.33	0.88	6.50
1223-Q	3606	32.50	14.50	9.00	22	16.50	22.50	6	41.75	16.50	16.50	16	14	29.00	55.00	23.00	8.88	0.75	2.88	1.33	0.88	6.50
1226	3625	35.50	16.00	9.00	22	16.50	22.50	6	41.75	16.00	16.00	14	14	30.50	58.00	26.00	8.88	0.75	2.88	1.33	0.88	6.50
1226-Q	3893	35.50	16.00	9.00	22	16.50	22.50	6	41.75	16.50	16.50	18	16	30.50	58.00	26.00	8.88	0.75	2.88	1.33	0.88	6.50
1230	3975	39.50	18.00	9.00	22	16.50	22.50	6	41.75	16.00	16.00	16	16	32.50	62.00	30.00	8.88	0.75	2.88	1.33	0.88	6.50
1230-Q	4346	39.50	18.00	9.00	22	16.50	22.50	6	41.75	16.50	16.50	18	16	32.50	62.00	30.00	8.88	0.75	2.88	1.33	0.88	6.50
1236	4170	45.50	21.00	9.00	22	16.50	22.50	6	41.75	16.00	16.00	16	16	35.50	68.00	36.00	8.88	0.75	2.88	1.33	0.88	6.50
1236-Q	4693	45.50	21.00	9.00	22	16.50	22.50	6	41.75	16.50	16.50	20	18	35.50	68.00	36.00	8.88	0.75	2.88	1.33	0.88	6.50
1415	3830	25.50	11.50	11.00	26	19.00	26.00	7	47.25	21.75	21.75	12	12	26.25	48.13	15.00	9.88	0.75	3.25	1.25	0.88	4.38
1419	3920	29.50	13.50	11.00	26	19.00	26.00	7	47.25	21.75	21.75	12	12	28.25	52.13	19.00	9.88	0.75	3.25	1.25	0.88	4.38
1421	3980	31.50	14.50	11.00	26	19.00	26.00	7	48.50	18.00	18.00	14	14	29.25	54.13	21.00	9.88	0.75	3.25	1.25	0.88	4.38
1421-Q	4172	31.50	14.50	11.00	26	19.00	26.00	7	48.50	19.25	19.25	16	14	29.25	54.13	21.00	9.88	0.75	3.25	1.25	0.88	4.38
1423	4075	33.50	15.50	11.00	26	19.00	26.00	7	48.50	18.00	18.00	14	14	30.25	56.13	23.00	9.88	0.75	3.25	1.25	0.88	4.38
1423-Q	4314	33.50	15.50	11.00	26	19.00	26.00	7	48.50	19.25	19.25	16	14	30.25	56.13	23.00	9.88	0.75	3.25	1.25	0.88	4.38
1426	4370	36.50	17.00	11.00	26	19.00	26.00	7	48.50	18.00	18.00	14	14	31.75	59.12	26.00	9.88	0.75	3.25	1.25	0.88	4.38
1426-Q	4695	36.50	17.00	11.00	26	19.00	26.00	7	48.50	19.25	19.25	18	16	31.75	59.12	26.00	9.88	0.75	3.25	1.25	0.88	4.38
1431	4575	41.50	19.50	11.00	26	19.00	26.00	7	48.50	18.00	18.00	18	18	34.25	64.12	31.00	9.88	0.75	3.25	1.25	0.88	4.38
1431-Q	5031	41.50	19.50	11.00	26	19.00	26.00	7	48.50	19.25	19.25	18	16	34.25	64.12	31.00	9.88	0.75	3.25	1.25	0.88	4.38
1437	5175	47.50	22.50	11.00	26	19.00	26.00	7	48.50	18.00	18.00	18	18	37.25	70.12	37.00	9.88	0.75	3.25	1.25	0.88	4.38
1437-Q	5868	47.50	22.50	11.00	26	19.00	26.00	7	48.50	19.25	19.25	24	20	37.25	70.12	37.00	9.88	0.75	3.25	1.25	0.88	4.38
1442	5625	52.50	25.00	11.00	26	19.00	26.00	7	48.50	18.00	18.00	18	18	39.75	75.12	42.00	9.88	0.75	3.25	1.25	0.88	4.38
1442-Q	6517	52.50	25.00	11.00	26	19.00	26.00	7	48.50	19.25	19.25	24	20	39.75	75.12	42.00	9.88	0.75	3.25	1.25	0.88	4.38
1617	5270	28.50	12.50	13.00	31	22.00	30.00	8	54.25	24.25	24.25	12	12	28.88	51.63	17.00	10.38	0.88	3.63	1.38	1.25	5.50
1623	5580	34.50	15.50	13.00	31	22.00	30.00	8	54.25	24.25	24.25	14	14	31.88	57.63	23.00	10.38	0.88	3.63	1.38	1.25	5.50
1626	5820	37.50	17.00	13.00	31	22.00	30.00	8	55.75	20.00	20.00	16	16	33.38	60.63	26.00	10.38	0.88	3.63	1.38	1.25	5.50
1626-Q	6255	37.50	17.00	13.00	31	22.00	30.00	8	55.75	22.25	22.25	20	18	33.38	60.63	26.00	10.38	0.88	3.63	1.38	1.25	5.50
1630	6070	41.50	19.00	13.00	31	22.00	30.00	8	55.75	20.00	20.00	16	16	35.38	64.63	30.00	10.38	0.88	3.63	1.38	1.25	5.50
1630-Q	6636	41.50	19.00	13.00	31	22.00	30.00	8	55.75	22.25	22.25	20	18	35.38	64.63	30.00	10.38	0.88	3.63	1.38	1.25	5.50
1636	6320	47.50	22.00	13.00	31	22.00	30.00	8	55.75	20.00	20.00	20	20	38.38	70.63	36.00	10.38	0.88	3.63	1.38	1.25	5.50
1636-Q	7132	47.50	22.00	13.00	31	22.00	30.00	8	55.75	22.25	22.25	24	20	38.38	70.63	36.00	10.38	0.88	3.63	1.38	1.25	5.50
1640	6970	51.50	24.00	13.00	31	22.00	30.00	8	55.75	20.00	20.00	20	20	40.38	74.63	40.00	10.38	0.88	3.63	1.38	1.25	5.50
1640-Q	8004	51.50	24.00	13.00	31	22.00	30.00	8	55.75	22.25	22.25	24	20	40.38	74.63	40.00	10.38	0.88	3.63	1.38	1.25	5.50
1643	7370	54.50	25.50	13.00	31	22.00	30.00	8	55.75	20.00	20.00	24	24	41.88	77.63	43.00	10.38	0.88	3.63	1.38	1.25	5.50
1643-Q	8587	54.50	25.50	13.00	31	22.00	30.00	8	55.75	22.25	22.25	30	24	41.88	77.63	43.00	10.38	0.88	3.63	1.38	1.25	5.50
1648	8070	59.50	28.00	13.00	31	22.00	30.00	8	55.75	20.00	20.00	24	24	44.38	82.63	48.00	10.38	0.88	3.63	1.38	1.25	5.50
1648-Q	9618	59.50	28.00	13.00	31	22.00	30.00	8	55.75	22.25	22.25	30	24	44.38	82.63	48.00	10.38	0.88	3.63	1.38	1.25	5.50

Dimensions are in inches. Weights are in pounds and approximate.

Dimensional Data – Horizontal Configurations

SIZE	WT.	A	B	C	D	E	G	H	J In	J Out	K In	K Out	L	M	N	O	R	S	T	U	V	X
1008	1750	16.75	7.00	7.50	20	14.00	5	31.38	17.38	17.38	8	8	19.38	36.38	8.00	7.88	0.63	2.50	1.13	0.88	7.00	30.75
1011	1875	19.75	8.50	7.50	20	14.00	5	31.38	17.38	17.38	8	8	20.88	39.38	11.00	7.88	0.63	2.50	1.13	0.88	7.00	30.75
1013	2000	22.00	9.63	7.50	20	14.00	5	31.38	17.38	17.38	10	10	22.00	41.63	13.25	7.88	0.63	2.50	1.13	0.88	7.00	33.00
1016	2050	24.75	11.00	7.50	20	14.00	5	26.00	12.00	12.00	10	10	23.38	44.38	16.00	7.88	0.63	2.50	1.13	0.88	7.00	33.00
1016-Q	2164	24.75	11.00	7.50	20	14.00	5	28.25	14.25	14.25	12	10	23.38	44.38	16.00	7.88	0.63	2.50	1.13	0.88	7.00	33.00
1018	2100	26.75	12.00	7.50	20	14.00	5	26.00	12.00	12.00	10	10	24.38	46.38	18.00	7.88	0.63	2.50	1.13	0.88	7.00	33.00
1021	2165	29.75	13.50	7.50	20	14.00	5	26.00	12.00	12.00	12	12	25.88	49.38	21.00	7.88	0.63	2.50	1.13	0.88	7.00	33.00
1021-Q	2286	29.75	13.50	7.50	20	14.00	5	28.25	14.25	14.25	14	12	25.88	49.38	21.00	7.88	0.63	2.50	1.13	0.88	7.00	33.00
1024	2530	32.75	15.00	7.50	20	14.00	5	28.00	14.00	14.00	14	14	27.38	52.38	24.00	7.88	0.63	2.50	1.13	0.88	7.00	33.00
1024-Q	2697	32.75	15.00	7.50	20	14.00	5	28.25	14.25	14.25	14	12	27.38	52.38	24.00	7.88	0.63	2.50	1.13	0.88	7.00	33.00
1030	2770	38.75	18.00	7.50	20	14.00	5	28.00	14.00	14.00	14	14	30.38	58.38	30.00	7.88	0.63	2.50	1.13	0.88	7.00	33.00
1030-Q	3032	38.75	18.00	7.50	20	14.00	5	28.25	14.25	14.25	16	14	30.38	58.38	30.00	7.88	0.63	2.50	1.13	0.88	7.00	33.00
1213	2850	22.50	9.50	9.00	24	16.50	6	35.75	19.25	19.25	10	10	24.00	45.12	13.00	8.88	0.75	2.88	1.33	0.88	7.00	36.50
1216	2975	25.50	11.00	9.00	24	16.50	6	35.75	19.25	19.25	10	10	25.50	48.12	16.00	8.88	0.75	2.88	1.33	0.88	7.00	36.50
1218	3065	28.00	12.25	9.00	24	16.50	6	32.50	16.00	16.00	12	12	26.75	50.62	18.50	8.88	0.75	2.88	1.33	0.88	7.00	39.00
1220	3340	29.50	13.00	9.00	24	16.50	6	32.50	16.00	16.00	12	12	27.50	52.12	20.00	8.88	0.75	2.88	1.33	0.88	7.00	39.00
1223	3410	32.50	14.50	9.00	24	16.50	6	32.50	16.00	16.00	14	14	29.00	55.12	23.00	8.88	0.75	2.88	1.33	0.88	7.00	39.00
1226	3625	35.50	16.00	9.00	24	16.50	6	32.50	16.00	16.00	14	14	30.50	58.12	26.00	8.88	0.75	2.88	1.33	0.88	7.00	39.00
1226-Q	3893	35.50	16.00	9.00	24	16.50	6	33.00	16.50	16.50	18	16	30.50	58.12	26.00	8.88	0.75	2.88	1.33	0.88	7.00	39.00
1230	3975	39.50	18.00	9.00	24	16.50	6	32.50	16.00	16.00	16	16	32.50	62.12	30.00	8.88	0.75	2.88	1.33	0.88	7.00	39.00
1230-Q	4346	39.50	18.00	9.00	24	16.50	6	33.00	16.50	16.50	18	16	32.50	62.12	30.00	8.88	0.75	2.88	1.33	0.88	7.00	39.00
1236	4170	45.50	21.00	9.00	24	16.50	6	32.50	16.00	16.00	16	16	35.50	68.12	36.00	8.88	0.75	2.88	1.33	0.88	7.00	39.00
1236-Q	4693	45.50	21.00	9.00	24	16.50	6	33.00	16.50	16.50	20	18	35.50	68.12	36.00	8.88	0.75	2.88	1.33	0.88	7.00	39.00
1415	3830	25.50	11.50	11.00	28	19.00	7	40.75	21.75	21.75	12	12	26.25	49.88	15.00	9.88	0.75	3.25	1.25	0.88	8.62	42.50
1419	3920	29.50	13.50	11.00	28	19.00	7	40.75	21.75	21.75	12	12	28.25	53.88	19.00	9.88	0.75	3.25	1.25	0.88	8.62	42.50
1421	3980	31.50	14.50	11.00	28	19.00	7	37.00	18.00	18.00	14	14	29.25	55.88	21.00	9.88	0.75	3.25	1.25	0.88	8.62	45.25
1423	4075	33.50	15.50	11.00	28	19.00	7	37.00	18.00	18.00	14	14	30.25	57.88	23.00	9.88	0.75	3.25	1.25	0.88	8.62	45.25
1426	4370	36.50	17.00	11.00	28	19.00	7	37.00	18.00	18.00	14	14	31.75	60.88	26.00	9.88	0.75	3.25	1.25	0.88	8.62	45.25
1426-Q	4695	36.50	17.00	11.00	28	19.00	7	38.25	19.25	19.25	18	16	31.75	60.88	26.00	9.88	0.75	3.25	1.25	0.88	8.62	45.25
1431	4575	41.50	19.50	11.00	28	19.00	7	37.00	18.00	18.00	18	18	34.25	65.88	31.00	9.88	0.75	3.25	1.25	0.88	8.62	45.25
1431-Q	5031	41.50	19.50	11.00	28	19.00	7	38.25	19.25	19.25	18	16	34.25	65.88	31.00	9.88	0.75	3.25	1.25	0.88	8.62	45.25
1437	5175	47.50	22.50	11.00	28	19.00	7	37.00	18.00	18.00	18	18	37.25	71.88	37.00	9.88	0.75	3.25	1.25	0.88	8.62	45.25
1437-Q	5868	47.50	22.50	11.00	28	19.00	7	38.25	19.25	19.25	24	20	37.25	71.88	37.00	9.88	0.75	3.25	1.25	0.88	8.62	45.25
1442	5625	52.50	25.00	11.00	28	19.00	7	37.00	18.00	18.00	18	18	39.75	76.88	42.00	9.88	0.75	3.25	1.25	0.88	8.62	45.25
1442-Q	6517	52.50	25.00	11.00	28	19.00	7	38.25	19.25	19.25	24	20	39.75	76.88	42.00	9.88	0.75	3.25	1.25	0.88	8.62	45.25
1617	5270	28.50	12.50	13.00	32	22.00	8	46.25	24.25	24.25	12	12	28.88	55.88	17.00	10.38	0.88	3.63	1.18	1.25	9.25	48.50
1623	5580	34.50	15.50	13.00	32	22.00	8	46.25	24.25	24.25	14	14	31.88	61.88	23.00	10.38	0.88	3.63	1.18	1.25	9.25	48.50
1626	5820	37.50	17.00	13.00	32	22.00	8	42.00	20.00	20.00	16	16	33.38	64.88	26.00	10.38	0.88	3.63	1.18	1.25	9.25	51.50
1630	6070	41.50	19.00	13.00	32	22.00	8	42.00	20.00	20.00	16	16	35.38	68.88	30.00	10.38	0.88	3.63	1.18	1.25	9.25	51.50
1630-Q	6636	41.50	19.00	13.00	32	22.00	8	44.25	22.25	22.25	20	18	35.38	68.88	30.00	10.38	0.88	3.63	1.18	1.25	9.25	51.50
1636	6320	47.50	22.00	13.00	32	22.00	8	42.00	20.00	20.00	20	20	38.38	70.62	36.00	10.38	0.88	3.63	1.18	1.25	9.25	51.50
1636-Q	7132	47.50	22.00	13.00	32	22.00	8	44.25	22.25	22.25	24	20	38.38	70.62	36.00	10.38	0.88	3.63	1.18	1.25	9.25	51.50
1640	6970	51.50	24.00	13.00	32	22.00	8	42.00	20.00	20.00	20	20	40.38	74.62	40.00	10.38	0.88	3.63	1.18	1.25	9.25	51.50
1640-Q	8004	51.50	24.00	13.00	32	22.00	8	44.25	22.25	22.25	24	20	40.38	74.62	40.00	10.38	0.88	3.63	1.18	1.25	9.25	51.50
1643	7370	54.50	25.50	13.00	32	22.00	8	42.00	20.00	20.00	24	24	41.88	77.62	43.00	10.38	0.88	3.63	1.18	1.25	9.25	51.50
1643-Q	8587	54.50	25.50	13.00	32	22.00	8	44.25	22.25	22.25	30	24	41.88	77.62	43.00	10.38	0.88	3.63	1.18	1.25	9.25	51.50
1648	8070	59.50	28.00	13.00	32	22.00	8	42.00	20.00	20.00	24	24	44.38	82.62	48.00	10.38	0.88	3.63	1.18	1.25	9.25	51.50
1648-Q	9618	59.50	28.00	13.00	32	22.00	8	44.25	22.25	22.25	30	24	44.38	82.62	48.00	10.38	0.88	3.63	1.18	1.25	9.25	51.50

Dimensions are in inches. Weights are in pounds and approximate.

8000 Bare Right-Hand Bottom Discharge

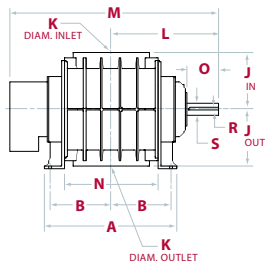

8000 Q Bare Right-Hand Bottom Discharge

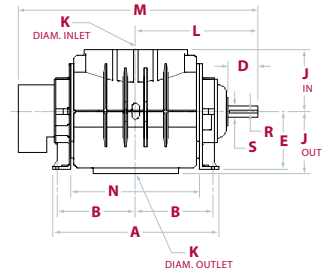
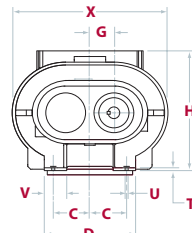
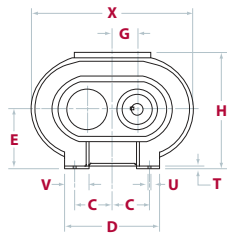

Sutorbilt® 8000 Series Vacuum Performance Data

SIZE	DIA. INLET & OUTLET	DISPL. CU. FT./REV.	FULL RATED VACUUM**	RPM	8" Hg		10" Hg		12" Hg		14" Hg		16" Hg	
					CFM	BHP	CFM	BHP	CFM	BHP	CFM	BHP	CFM	BHP
1008	8	1.1	16	1475	1424	31	1389	37	1353	44	1314	51	1215	57
				1770	1748	38	1714	46	1678	54	1638	62	1540	70
1011	8	1.5	16	1475	1955	42	1911	50	1864	61	1813	70	1700	79
				1770	2398	53	2353	64	2307	75	2256	85	2143	96
1013	10	1.8	16	1475	2355	50	2303	61	2248	72	2189	83	2055	94
				1770	2886	63	2834	75	2779	88	2720	101	2586	114
1016*	10	2.2	16	1475	2898	62	2839	75	2775	89	2707	102	2539	115
				1770	3547	78	3488	93	3424	109	3356	125	3188	140
1018*	10	2.4	16	1475	3173	68	3110	83	3043	97	2970	112	2789	126
				1770	3881	86	3818	103	3751	120	3678	137	3497	154
1021*	12	2.8	16	1475	3721	78	3651	95	3577	112	3495	129	3289	146
				1770	4547	98	4477	118	4402	138	4321	158	4115	178
1024*	14	3.3	16	1475	4386	91	4303	112	4215	132	4119	152	3876	172
				1770	5959	114	5276	138	5188	162	5093	185	4849	209
1030*	14	4.1	16	1475	5449	115	5346	140	5237	165				
				1770	6659	144	6555	173	6446	203				
1213	10	2.6	16	1160	2655	57	2592	69	2526	82	2455	94	2267	107
				1460	3435	75	3372	91	3306	106	3235	121	3047	137
1216	10	3.1	16	1160	3180	69	3107	83	3032	98	2949	113	2716	128
				1460	4110	92	4037	110	3962	128	3879	146	3646	164
1218*	12	3.6	16	1160	3709	79	3628	96	3543	113	3451	130	3183	148
				1460	4789	104	4708	125	4623	147	4531	168	4263	189
1220*	12	4.0	16	1160	4140	88	4053	107	3962	126	3863	145	3619	164
				1460	5340	117	5253	140	5162	164	5063	187	4819	211
1223*	14	4.5	16	1160	4678	98	4584	119	4485	141	4378	163	4109	184
				1460	6028	129	5934	156	5835	183	5728	209	5459	236
1226*	14	5.0	16	1160	5209	109	5107	133	5000	157	4882	181	4586	205
				1460	6709	145	6607	174	6500	204	6382	233	6086	263
1230*	16	6.0	16	1160	6251	131	6129	159	5999	188	5859	217		
				1460	8051	172	7929	208	7799	243	7659	279		
1236*	16	7.1	16	1160	7397	156	7252	190	7099	224				
				1460	9527	207	9382	249	9229	291				
1415	12	4.0	16	965	3397	72	3317	88	3232	104	3140	120	2922	136
				1250	4537	99	4457	119	4373	139	4280	159	4062	180
1419	12	5.1	16	965	4366	93	4270	114	4169	134	4059	154	3746	174
				1250	5820	129	5724	154	5623	180	5512	205	5199	231
1421*	14	5.6	16	965	4807	101	4704	123	4595	146	4477	168	4159	191
				1250	6403	138	6300	167	6192	195	6073	223	5755	252
1423*	14	6.1	16	965	5251	111	5141	135	5025	159	4899	184	4581	208
				1250	6989	152	6879	183	6764	213	6637	244	6319	275
1426*	14	6.9	16	965	5971	126	5852	154	5727	181	5591	208	5238	236
				1250	7938	174	7819	208	7694	243	7557	278	7205	312
1431*	18	8.2	16	965	7115	147	6977	180	6832	213	6674	246	6293	279
				1250	9452	201	9315	242	9170	284	9011	325	8630	367
1437*	18	9.9	16	965	8590	179	8424	219	8248	258	8057	298		
				1250	11412	246	11245	296	11071	346	10879	396		
1442*	18	11.2	16	965	9718	204	9530	249	9331	294				
				1250	12910	282	12722	338	12524	394				
1617	12	5.9	16	880	4838	100	4421	121	4299	143	4166	164	3845	185
				1100	5840	132	5724	158	5601	184	5468	210	5147	236
1623	14	8.0	16	880	6214	135	6069	164	5917	193	5752	122	5334	251
				1100	7976	179	7832	214	7680	249	7514	285	7097	320
1626*	16	9.1	16	880	7021	151	6857	184	6686	217	6498	250	6027	282
				1100	9012	199	8848	239	8677	280	8489	320	8018	360
1630*	16	10.4	16	880	8147	176	7967	214	7778	251	7572	289	7082	327
				1100	10444	233	10264	279	10075	325	9869	371	9378	417
1636*	20	12.5	16	880	9836	208	9631	253	9414	299	9178	344	8602	390
				1100	12593	273	12387	329	12170	384	11934	440	11359	496
1640*	20	13.9	16	880	10936	232	10707	283	10466	333	10203	384		
				1100	14000	306	13771	368	13530	430	13268	491		
1643*	24	15.0	16	880	11752	246	11506	300	11247	355	10965	410		
				1100	15045	321	14799	388	14540	455	14258	522		
1648*	24	16.7	16	880	13118	276	12843	337	12554	398				
				1100	16794	362	16519	436	16230	511				

Performance based on inlet air at standard temperature of 68° F, an ambient pressure of 14.7 psia and 36% relative humidity. For performance at non-standard conditions, contact your authorized Gardner Denver representative.

* Available with Quiet series option (Q Series). Q Series produces approximately 2% less flow and uses approximately 2% less hp than the standard models based on equivalent operating conditions.

** Wet vacuum performance is available to 24" Hg. Consult PD Blower Customer Service, Quincy, IL for assistance.

Sutorbilt® 8000 Series Pressure Performance Data

SIZE	DIA. INLET & OUTLET	DISPL. CU. FT./REV.	FULL RATED PRESSURE	RPM	6 PSIG		8 PSIG		10 PSIG		12 PSIG		15 PSIG		18 PSIG	
					CFM	BHP	CFM	BHP	CFM	BHP	CFM	BHP	CFM	BHP	CFM	BHP
1008	8	1.1	20.0	1475	1412	46	1380	60	1351	74	1325	1290	110	1203	131	
				1770	1737	57	1704	74	1676	91	1650	108	1615	134	1527	159
1011	8	1.5	20.0	1475	1942	64	1899	83	1862	103	1828	122	1783	151	1685	180
				1770	2383	80	2341	103	2304	126	2271	150	2225	184	2127	219
1013	10	1.8	18.9	1475	2338	76	2288	99	2245	122	2206	145	2153	180	2037	215
				1770	2869	94	2820	122	2776	150	2737	177	2684	219	2568	261
1016*	10	2.2	15.6	1475	2879	94	2822	122	2772	150	2727	178	2666	221		
				1770	3528	117	3471	151	3421	185	3376	219	3315	270		
1018*	10	2.4	13.9	1475	3152	103	3092	134	3039	164	2992	195				
				1770	3860	128	3800	166	3747	203	3700	240				
1021*	12	2.8	11.9	1475	3698	118	3631	154	3573	190						
				1770	4524	147	4457	191	4399	234						
1024*	14	3.3	10.4	1475	4359	138	4280	181	4210	223						
				1770	5332	172	5253	223	5184	274						
1030*	14	4.1	8.3	1475	5415	174	5317	227								
				1770	6625	217	6527	280								
1213	10	2.6	20.0	1160	2634	86	2575	112	2523	139	2476	165	2412	204	2244	244
				1460	3414	113	3355	147	3303	180	3256	213	3192	262	3024	312
1216	10	3.1	18.8	1160	3156	104	3088	135	3028	166	2974	198	2900	245	2689	292
				1460	4086	137	4018	177	3958	216	3904	256	3830	315	3619	374
1218*	12	3.6	16.2	1160	3682	119	3606	155	3539	192	3478	228	3396	283		
				1460	4762	157	4686	202	4619	248	4558	294	4476	363		
1220*	12	4.0	15.0	1160	4111	133	4029	173	3957	214	3892	254	3804	315		
				1460	5311	176	5229	226	5157	277	5092	328	5004	405		
1223*	14	4.5	13.0	1160	4647	148	4559	193	4480	239	4410	284				
				1460	5997	194	5909	252	5830	309	5760	366				
1226*	14	5.0	11.5	1160	5176	165	5079	216	4994	266						
				1460	6676	218	6579	282	6494	345						
1230*	16	6.0	10.0	1160	6211	197	6095	258	5993	319						
				1460	8011	260	7895	336	7793	412						
1236*	16	7.1	8.3	1160	7350	236	7212	308								
				1460	9480	312	9342	402								
1415	12	4.0	20.0	965	3370	109	3295	143	3228	176	3168	210	3086	261	2893	311
				1250	4510	148	4435	192	4368	236	4308	279	4226	345	4033	410
1419	12	5.1	18.4	965	4335	141	4244	184	4164	227	4092	270	3994	334	3711	398
				1250	5788	193	5697	249	5617	304	5545	360	5447	443	5164	527
1421*	14	5.6	16.7	965	4773	153	4676	200	4590	247	4512	294	4407	365		
				1250	6369	208	6272	269	6186	330	6108	391	6003	483		
1423*	14	6.1	15.2	965	5215	167	5111	219	5019	270	4936	321	4824	398		
				1250	6953	228	6849	295	6758	361	6675	428	6563	528		
1426*	14	6.9	13.5	965	5932	190	5820	249	5721	307	5631	365				
				1250	7899	261	7786	336	7687	412	7598	487				
1431*	18	8.2	11.3	965	7070	223	6940	292	6825	361						
				1250	9407	302	9277	391	9162	481						
1437*	18	9.9	9.5	965	8536	271	8378	355								
				1250	11357	370	11200	478								
1442*	18	11.2	8.3	965	9656	309	9478	403								
				1250	12848	423	12670	545								
1617	12	5.9	20.0	880	4499	151	4390	196	4293	242	4205	287	4087	355	3804	423
				1100	5802	199	5692	255	5595	312	5508	369	5389	454	5106	539
1623	14	8.0	17.4	880	6166	204	6030	265	5910	327	5801	388	5654	481		
				1100	7929	269	7792	346	7672	422	7563	499	7416	615		
1626*	16	9.1	15.4	880	6967	229	6013	298	6677	367	6554	437	6388	541		
				1100	8958	300	8804	387	8668	473	8545	560	8379	690		
1630*	16	10.4	13.3	880	8088	266	7918	346	7768	426	7633	506				
				1100	10385	350	10215	450	10065	550	9930	651				
1636*	20	12.5	11.1	880	9769	314	9574	410	9403	506						
				1100	12525	411	12331	531	12159	651						
1640*	20	13.9	10.0	880	10860	351	10644	458	10453	565						
				1100	13925	460	13709	594	13518	728						
1643*	24	15.0	9.3	880	11671	372	11439	487								
				1100	14965	484	14732	628								
1648*	24	16.7	8.3	880	13028	417	12768	545								
				1100	16704	544	16444	705								

Performance based on inlet air at standard temperature of 68° F, an ambient pressure of 14.7 psia and 36% relative humidity. For performance at non-standard conditions, contact your authorized Gardner Denver representative.

* Available with Quiet series option (Q Series). Q Series produces approximately 2% less flow and uses approximately 2% less hp than the standard models based on equivalent operating conditions.

Protect your Gardner Denver investment with AEON® PD, the only lubricant specially formulated for all blowers in any environment

- 100% synthetic for matchless service life
- Retains its superior lubricating properties a minimum of four times longer than a premium grade mineral oil at most operating conditions
- Eliminates seasonal oil viscosity grade changes
- Superior lubrication in severe, high temperature applications
- Available from your local authorized Gardner Denver distributor in convenient sizes to meet your needs
- Food grade lubricant available



Retain your 8000/8000 Q advantage with genuine Gardner Denver replacement parts

- Gardner Denver guarantees to supply the proper parts for your specific blower every time. Replacement parts incorporate the most recent design upgrades.
- All parts meet Gardner Denver original manufacturing specifications and tolerances for guaranteed fit and function.
- Pre-packaged overhaul kits with detailed service manuals are available from your local authorized Gardner Denver distributor.



**Gardner
Denver®**

www.GardnerDenverProducts.com pd.blowers@gardnerdenver.com

Gardner Denver, Inc. 1800 Gardner Expressway, Quincy, IL 62305
Telephone: (800) 682-9868 FAX: (217) 221-8780

©2009 Gardner Denver, Inc. Litho in U.S.A. PD-SB-8000 2nd Ed. 11/09

 Please recycle after use.

