



FACTORY DIRECT

FLAIL-MASTER®

Your **BEST** Choice for Quality Mower Parts

816 Esther Lane • Murfreesboro, TN 37129

MANUFACTURING FLAIL BLADES

Heavy-Duty Rotary Cutters



Flail Mower Parts



***CELEBRATING OVER
50 YEARS IN BUSINESS!***

(800) 251-4020 • (615) 848-1813 • www.flailmaster.com



Your **BEST** Choice for Quality Mower Parts

Dear Valued Customer,

Thank you for choosing **Flail-Master®** as your supplier for quality replacement parts. As you maintain your mowing equipment throughout the season, remember that for more than 50 years we have provided our customers with quality replacement parts at affordable prices and continue to provide unsurpassed customer service.

 **Flail-Master®** is a manufacturer and factory direct company meeting the needs of D.O.T.'s, municipalities, government agencies, universities, hospitals, lawn care professionals, maintenance organizations and individuals across the U.S. We are extremely proud that over **90%** of what we sell is **MADE IN THE USA**, with more than **80%** being produced in our facility **in Tennessee**.

In addition to providing replacement blades and parts, we also have a line of landscaper accessories to help you and your crew work more safely and more efficiently. These products include: arm/leg chapps, neck/ear sun protection, mesh debris bags, roadside safety equipment, Gator Magnum trimmer line, blade sharpeners (rotary blade grinders) and more.

If there is an item you cannot find please contact our Sales Staff at 1-800-251-4020. We have access to thousands of parts not listed in our catalog.

Please take a moment and look through our catalog, or visit our website at www.flailmaster.com and see why **Flail-Master®** is:

Your **BEST** Choice for Quality Mower Parts

Sincerely,
Flail-Master®

Flail Mower Replacement Parts • Heavy-Duty Rotary Cutter Parts
Riding & Walk Behind Mower Parts • Trimmer Parts
Blade Sharpening Equipment • Mowing Accessories

Our Mission:

To provide top quality replacement parts at competitive prices with unsurpassed customer service.

Our Hours Are:

Monday thru Friday
8:00 AM to 4:30 PM (CST)
Voicemail available after hours.

Contact Us At:

(800) 251-4020 Toll Free
(615) 896-5652 Fax
www.flailmaster.com.

Flail Mower Replacement Parts

Flail-Master® has manufactured top quality flail mower parts for more than 50 years. We take pride in making sure all of our parts meet or exceed original equipment manufacturers' (O.E.M.) specifications while offering them to you at a considerable savings. The blades we manufacture are made from high carbon spring steel. This allows them to be heat treated harder, to give longer wear. They are reversible for double life and may be resharpened again and again. All parts are unconditionally guaranteed against defects in material and workmanship. We stock a variety of parts for flail mowers, from blades and mounting hardware to high wear items such as belts, bearings, and pulleys.

Flail-Master® offers quality replacement parts to fit:

Alamo® • Bomford® • Bush Hog® • Dandl® • Edwards • Ford/New Holland • Loftness® • Mott® • Servis-Rhino®
Terrain King® • Tiger® • John Deere • Jacobsen® • Vrisimo® and other popular brands.

Table of Contents

Contents	Page
Alamo®/Mott®	1-18
Blades & Mounting Hardware.....	1-2
Cuttershafts & Components.....	3-4
Extension Shaft Assembly.....	4-5
Belt & Pulley System.....	5-6
Gearbox & Components.....	7-8
Front Pump & Tank Parts (New Style Interstater w/o Blower).....	8
Front Pump & Tank Parts (Old Style Interstater w/ Blower).....	9-10
Lift & Tilt Replacement Parts.....	11-12
PTO Assemblies & Components.....	13-14
Roller Assemblies & Components (Threaded Shaft).....	14
Roller Assemblies & Components (Hex Shaft).....	15
Roller Assemblies & Components (Round Shaft).....	16
Front Foot Guards.....	17
Trash Deflectors.....	17
Miscellaneous Replacement Parts.....	18
Alamo®/Terrain King®	18-20
Flail Axe Replacement Parts.....	18
Heavy-Duty Boom Mounted Replacement Parts.....	19
Versa Replacement Parts.....	19
Extension Arm Assembly.....	20
Miscellaneous Replacement Parts.....	20
Bomford®	20-21
Bush Hog®	22
Dandl®	22
Edwards	23
Ford	23-25
Blades & Mounting Hardware.....	23-24
Miscellaneous parts for Model #917.....	24
Miscellaneous parts for Model #918H	25
Jacobsen	25
John Deere	26
300 Series.....	26
Model 25A.....	26
Servis-Rhino® (see Alamo®/Mott®)	1-18
Tiger®	27-29
Blades & Mounting Hardware.....	27-28
Roller Replacement Parts.....	28
Miscellaneous Replacement Parts.....	29
Vrisimo®	29

Heavy-Duty Rotary Cutter Parts

Flail-Master® offers rotary cutter blades in two different styles, one being the original style blade, and the other a “banana” style blade. The visible difference is that the banana blade is curved to equal the natural wear pattern of the blade, giving it a longer life. Whichever you prefer, we have the right blade for your mower. We also offer blade bolts, nuts and washers for mounting blades.

Flail-Master® offers quality replacement parts to fit:
 Alamo® • Bush Hog® • Hardee • Land Pride • Schulte® • Servis-Rhino® • Side-winder
 Terrain King® • Tiger® • Woods and other popular brands.

Table of Contents

Contents	Page
O.E.M. Style Rotary Cutter Blades.....	30-45
Alamo®/Terrain King®	30-32
Bush Hog®	33-35
Hardee.....	36
Land Pride®	36-37
Schulte®	37-39
Servis-Rhino®.....	39-41
Tiger®	42-43
Woods.....	44-45
Mounting Hardware.....	46-48
Alamo®/Terrain King®	46
Bush Hog®.....	46
Hardee.....	47
Land Pride®	47
Schulte®	47
Servis-Rhino®.....	47
Side-winder.....	48
Tiger®	48
Woods.....	48

We also have tail wheels for
 Alamo®/Terrain King® Mowers
 as well as Triumph® sickle mower parts.
 Please call for details,
 1-800-251-4020.



Visit us on the web!
www.flailmaster.com

Riding & Walk Behind Mower Parts

Flail-Master® carries top quality replacement parts for Commercial Riding & Walk Behind Mowing Equipment. The blades we offer are made of harder, more resilient materials for a longer lasting cutting edge. These blades are precision balanced and heat treated for durability. The durability allows blades to give you a more precise cut. The precise cut keeps your grass from fraying or browning. We also offer filters and other miscellaneous replacement parts for many of the popular brand mowers.

Flail-Master® offers quality replacement parts to fit:

Ariens® • AYP • Bob-Cat/Ransomes • Bunton • Bush Hog® • Case • Country Clipper • Cub Cadet • Dixie Chopper
 Dixon® • Excel/Hustler • Exmark® • Ferris • Grasshopper® • Gravely® • Great Dane • Honda • Husqvarna • Ingersoll • Jacobsen
 John Deere • Kubota® • Land Pride® • Lawn-Boy®/Gilson • Massey Ferguson • MTD • Murray • Poulan Pro • Scag
 Scotts • Sears • Sensation • Simplicity • Snapper • Swisher • Toro® • Troy-Built • Walker • Woods® • Wright and Yazoo/Kees

Table of Contents

Contents	Page
Riding & Walk Behind Blades.....	49-54
Ariens®.....	49
Bob-Cat/Ransomes.....	49
Dixie Chopper.....	49
Excel/Hustler.....	49
Exmark®.....	50
Ferris.....	50
Grasshopper®.....	51
Gravely®.....	51
Great Dane.....	51
Jacobsen.....	51
John Deere.....	52
Kubota®.....	52
Scag.....	53
Toro®.....	53
Walker.....	54
Woods.....	54
Wright.....	54
Yazoo/Kees.....	54

**Mulching Blades available for many manufacturers/models.
 Call 1-800-251-4020 for prices and availability.**



Benefits:

- Pulls clippings down and discharges them from deck.
- Aids in re-cutting of clippings for quicker decomposing.
- Moves more air with less horsepower.
- Produces fine clippings. Promotes clipping flow to center of the deck.
- Longer wear. Holds cutting edge longer.
- Provides more efficient recutting of clippings.

FLAIL-MASTER® also has quality replacement blades for:
 AYP • Bush Hog® • Case • Country Clipper • Cub Cadet • Honda • Ingersoll
 Land Pride® • Lawn-Boy® • Massey Ferguson • MTD • Murray • Poulan Pro • Scotts
 Sears • Sensation • Simplicity • Snapper • Swisher and Troy-Built

Mowing Accessories

The key to good performance and long wear is to keep your blades in good working condition. **Flail-Master®** offers rotary blade grinders for commercial & heavy-duty rotary blades designed specifically for these type blades. Accessory parts are also available, such as grinder wheels, stands, grit collectors and mulching plates. We also stock trimmer line in round, hexagon or square shapes and in sizes ranging from .065 to .155. Whether you need 1 lb. or 5 lbs. of trimmer line, we have it. Our line comes in 1 lb. donuts and 3 lb. & 5 lb. spools. Need to keep your equipment free from the elements? We offer equipment covers for riding & walk behind mowers and hand-held equipment. **Flail-Master®** also offers products such as mesh debris bags, leg/arm chaps, neck/ear sun protection, chemical spraywear and roadside safety equipment to make sure you work safer and more efficiently.

Table of Contents

Contents	Page
Trimmer Line.....	55-56
Round.....	55
Square.....	55
Hex.....	55
Gator Magnum Specialty Line.....	56
Round.....	56
Square.....	56
SuperTwist.....	56
Trimmer Head/Edger Blades.....	57
Roadside Safety Equipment.....	58-60
ANSI/ISEA Safety Shirts.....	58
ANSI/ISEA Safety Vests.....	58-59
CLASS 3 Safety Wear & Accessories.....	60
Rain Suit & Safety Work Gloves.....	60

Blades & Mounting Hardware

Flail Mower Parts



Coarse-Cut

Blade Requirements		
Mower Model	# of Stations	Blades Required
62	36	72
74	36	72
88	44	88
96	48	96



M-100759

Standard-Duty Blade (02986332)

.106" Thick
1 3/4" Wide
3" Tall
1" x 1/2" Mtg. hole



FM-7

Heavy-Duty Blade

.130" Thick
1 3/4" Wide
3" Tall
1" x 1/2" Mtg. hole



M-105319M

Extreme-Service Blade (02986276)

.192" Thick
1 1/2" Wide
3" Tall
1" x 1/2" Mtg. hole



M-108381

Forged Heavy-Duty Blade

.196" Thick
1 3/4" Wide
3" Tall
1" x 1/2" Mtg. hole



M-100761

Clevis

7/16" Hole
1 7/8" Wide (outside)
1" Wide (inside ears)
2 1/2" Tall



M-102670

Clevis Pin

7/16" x 3"



MP-26

Cotter Pin

1/8" x 7/8"
200 per box



TM-203B

Bolt & Nut Set

7/16" x 3 1/4"
(each set contains 1 bolt & 1 nut)



WORK SAFER!

Roadside Safety Equipment, including HI-VIS vests, face shields & other safety products on pages 58-60.

Blades & Mounting Hardware

Fine-Cut



Blade Requirements		
Mower Model	# of Stations	Blades Required
48	60	120
60	76	152
72	92	184
74	92	184
88	108	216
96	118	236



MH-293

Fine-Cut Blade (101993/02986333)

Ring Mounted
.087" Thick
1 1/4" Wide
2 3/4" Tall
3/8" Mtg. hole



MH-386

Fine-Cut Blade (102086/02988196)

Pin Mounted
.087" Thick
1 1/4" Wide
4.7" Tall
3/8" Mtg. hole



MH-387

Renovating Knife

(Pin mounted)
OEM# 102087
Only 1 per station
.087" Thick
4.7" Tall, 1 1/4" Wide
3/8" Mtg. hole



MH-291

D-Ring

OEM# 101991



MP-26

Cotter Pin

1/8" x 7/8"
200 per box



Optional Ring Clips

M-102650

Ring Clip

(Flat Bottom)
1 3/4" Long



MH-292

Ring Clip

OEM# 101992
5/16" x 7/8"



MC-6

Clevis Pin

1 1/8" Long
OEM# 101034
for use with
MH-386 & MH-387 Blades



M-105746

Ring Clip

(Short bottom)
1 5/8" Long



P-32

Bolt

OEM# 000032
5/16" x 1 1/4"



P-210

Nut

OEM# 000210
for P-32 bolt



Cuttershafts & Components

Coarse-Cut



Part #	Model	Length
M-107123	Model #62 (also replaces M-105719)	66.03"
M-107124	Model #74 (also replaces M-105720)	80.12"
M-107125	Model #88 (also replaces M-105721)	93.25"



M-100719
Coarse-Cut Cuttershaft
Weld-On Lug

Fine-Cut



Part #	Model	Length
M-107127	Model #62 (also replaces M-105723)	66.12"
M-107128	Model #74 (also replaces M-105724)	80.12"
M-107129	Model #88 (also replaces M-105725)	93.25"



M-101029
Weld-On Lug for 60 & 72 (left)

M-100757
Weld-On Lug for 50,62,74 & 88

**Bearings & Housings (New Style Cuttershaft)
(Models #62,74,88,96)**



M-704305
Cuttershaft Bearing & Housing (Non-Pulley Side)
Setscrew towards the outside, visible from side of mower



M-002530
Cuttershaft Bearing only with Setscrew (1 15/16" ID, 3 1/2" OD) used only in M-704305



M-703695
Cuttershaft Bearing & Housing (Pulley Side)
Replaces M-702403



M-703271
Cuttershaft Bearing & Housing (Non-Pulley Side)
Replaces M-702402, Setscrew toward inside, not visible from side of mower



M-703694
Cuttershaft Bearing only with Setscrew (1 15/16" ID, 3 1/2" OD) used in M-703271 & M-703695
Replaces M-002315

Bearings & Housings (Old Style Cuttershaft)

Ref #	Part #	Description
1	M-102792	Bearing for Models #60, 72 (1 3/16" ID, Press Fit 2.44" OD)
2	M-702408	Bearing & Housing for Models #48, 60, 72 (Grease fitting on bottom, old # M-700736)
3	M-702409	Bearing & Housing for Models #60, 72 (Grease fitting on edge, old # M-700737)
4	M-702409B	Bearing for M-702408 & M-702409 (1 3/16" ID, Self-Aligning 2 7/16" OD)



Flail Mower Parts

Cuttershafts & Components (cont.)

Pulleys

Part #	Description
M-103065	Two-Groove Pulley, no brake, 1/4" Keyway
M-500031	Two-Groove Pulley, no brake, 3/8" Keyway
M-500059	Two-Groove Pulley w/brake, 3/8" Keyway
M-701672	Two-Groove Pulley w/brake, 1/4" Keyway
M-02959586	Two-Groove Pulley, no brake, 3/8" Keyway
M-02960512	Two-Groove Pulley, no brake, or setscrew 3/8" Keyway



Extension Shaft Assembly

Extension Shafts



Part #	Length
M-100159	39 11/16"
M-100286	15 11/16"
M-100287	27 11/16"
M-100288	21 11/16"
M-100724	36 3/16"
M-100778	29 7/16"
M-104685	22 7/16"

Extension Shaft Housings



Part #	Length
M-100721	36 1/8"
M-100776	29 9/16"
M-102637	15 5/8"
M-102804	27 5/8"
M-102874	21 5/8"

Bearing & Housing Assembly

Part #	Description
M-700491	Bearing & Housing Assembly (all parts below are included)
M-700739	Housing Only
M-000398	Bearing Only (1 1/8" ID, 2 7/16" OD)
M-000402	Snap Ring (2 used)



Extension Shaft Assembly (cont.)



Miscellaneous Drive Parts

Ref #	Part #	Description
1	M-000520	Lockwasher, 1/2"
2	M-000554	Bolt, 1/2" NF x 1 1/4"
3	M-100010	Bevel Washer
4	M-100057	Snap Ring
5	M-101780	Bearing Lock Washer
6	M-101782	Key
7	M-102651	Pulley Shim (use qty. as needed)
8	M-700171	Splined Coupling

Belt & Pulley System

Part #	Description
M-000701	Matched Belt Set for front pumps on Ford Tractors
M-000702	Matched Belt Set for Interstater Wing Mount & Versa Mowers
M-000907	Matched Belt Set for front pumps on Massey Ferguson Tractors
M-000954	Matched Belt Set
M-100706	Belt for Models #50,62,74,88 & 96 Rear Mount
M-102631	Belt for Models #60 & 72 Rear Mount



NOTE: Extend the life of your new belt by replacing the tension spring. (page 6)

M-700488

Belt Guard
with Hardware
(for Models
#50/#62/#74/#88 & #96)



M-701845

Belt Guard
with Hardware
(for Models
#50/#62/#74/#88 & #96
- Reverse Rotation)



Belt & Pulley System (cont.)

Flat Mower Parts

M-000539

Tension Spring



M-000547

Idler Pulley
for Rear Mowers,
5/8" ID, 6 1/4" OD



M-000672

Pulley Hub
for M-000673
Pulley



M-000673

**Two-Groove
Pulley for
Wing Mowers**



M-102501

**Extension Shaft
Pulley,**
for #50/62/74/88/96
8 1/2" OD, 1 1/8" ID



M-102565

**Extension Shaft
Pulley, 1 1/8" ID**
for Models #60, 72
8" OD, 1 1/8" ID



M-103105

Idler Pulley
for Wing Mowers
(2 required),
5" OD, 5/8" ID



M-100727

**Idler Arm for Rear
Mount Models**
#50/62/74/88/96



M-102652

**Cuttershaft
Pulley,**
for Models #62/74/8
8 3/4" OD, 1 15/16" ID



M-106528

LH Idler Arm
(forward rotation
Interstater left wing)



M-106529

RH Idler Arm
(forward rotation
Interstater right wing)



M-102810

Idler Arm
Models #60, 72



M-700949

LH Idler Arm
w/Grease Fitting
(forward rotation
#48 & 60)



M-700494

Idler Arm Assembly
for Rear Mount models
#50/62/74/88/96
(contains M-000547,
M-100727 & hardware)



M-700948

RH Idler Arm
w/Grease Fitting
(forward rotation
Versa #60 & 74)



M-103041

Idler Pivot Pin
Used w/ M-700948
& M-700949



M-702749

Idler Pivot Pin
w/Grease Fitting, used
w/ M-106528 & M-106529



Gearbox & Components

Gearboxes (Complete)

Part #	Description
M-700493	use M-702673 or M-702673A (Replacement parts still available)
M-702673	Comer Brand



Flail Mower Parts



M-700493 Repair Parts

Ref #	Part #	Description
1	M-000327	Bearing Cup (4 req.)
2	M-000328	Bearing Cone (3 req.)
3	M-000329	Bearing Cone (1 req.)
4	M-100054	Input Shaft Seal (1 req.)
5	M-100055	Output Shaft Seal (1 req.)



M-702673 & M-702673A Repair Parts

Ref #	Part #	Description
1	M-001716	Spacer
2	M-001717	Nut
3	M-001718	Pinion
4	M-001719	Seal
5	M-001720	Spring Washer
6	M-001722	Bearing, Roller
7	M-001724	Seal
8	M-001725	Shaft & Gear
9	M-00753222	Shim Kit (contains 4 shims)
10	M-00754459	Bearing, Ball
11	M-00754757	Bearing, Roller
-	M-00754761	Shim

Gearbox & Components (cont.)



M-103713
Gearbox Mounting Frame



M-103715
A-Frame Up-Right, LH or RH



M-102658
Overarm, LH or RH



Part #	Description
M-101779	Top Hitch Pin
M-102549	Quick Pin (for 101779)
M-103717	Bushing, Upper



Part #	Description
M-100743	Lower Hitch Pin
M-000333	Click Pin
M-103716	Bushing, Lower

Front Pump & Tank Parts

(New Style Interstater without Blower)



Ref #	Part #	Description
1	M-000810	Oil Temperature Gauge
2	M-000889	Hydraulic Pump used with M-106599 Pulley
3	M-001767	Drive Belt
4	M-106599	Drive Pulley, Upper for M-000889 Hyd. Pump
5	M-02961001	Hydraulic Filter
6	M-02961452	Top Cover O-Ring
7	M-03200350	Filler Cap (Oil Reservoir)

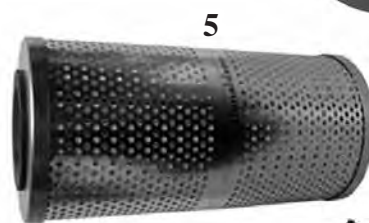

NOTE: Refer to owner's manual for correct drive shaft.

Front Pump & Tank Parts
(Old Style Interstater with Blower)

Flail Mower Parts



Pump Unit Replacement Parts

Ref #	Part #	Description
1	M-000671	2 Groove Pulley
2	M-000672	Pulley Hub
3	M-000788	Filter Element
4	M-001492	Reservoir Cover Seal
5	M-001494	Filter (Screw On)
6	M-103110	Blower Pilot Bushing
7	M-103111	Blower Spacer
8	M-103112	Oil Cooler
9	M-103136	Oil Cooler Blower
10	M-103173	Screen Retainer
11	M-103231	Reservoir Seal
12	M-103265	Blower Screen
13	M-103329	Dipstick
14	M-103389	Return Hose

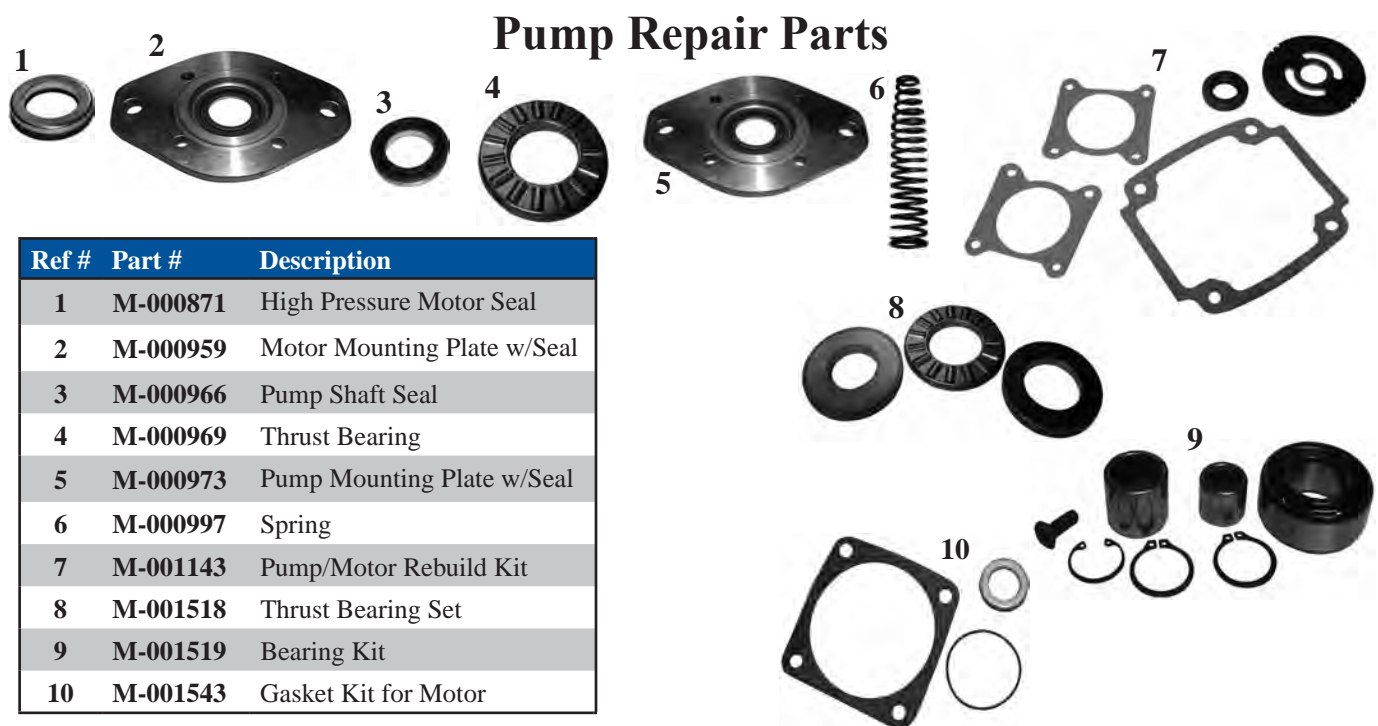

Pump Repair Parts

Ref #	Part #	Description
1	M-000871	High Pressure Motor Seal
2	M-000959	Motor Mounting Plate w/Seal
3	M-000966	Pump Shaft Seal
4	M-000969	Thrust Bearing
5	M-000973	Pump Mounting Plate w/Seal
6	M-000997	Spring
7	M-001143	Pump/Motor Rebuild Kit
8	M-001518	Thrust Bearing Set
9	M-001519	Bearing Kit
10	M-001543	Gasket Kit for Motor

Front Pump & Tank Parts
(Old Style Interstater w/Blower)

Flail Mower Parts

Drive Shafts

Part #	Length
M-104315	23 1/2"
M-104492	21 1/2"
M-104893	24 1/2"
M-105478	22 3/4"



Pulleys

Ref #	Part #	Description
1	M-000911	Pulley Hub (used w/4-Groove Pulley)
1	M-001010	Pulley Hub (used w/2-Groove Pulley)
2	M-000952	4-Groove Pulley
3	M-001235	Pulley Key (used w/M-104003)
4	M-104003	2-Groove Pulley

Miscellaneous Parts

Ref #	Part #	Description
1	M-000912	Bearing
2	M-000964	Rubber Bushing
-	M-001015	Pump Repair Kit
3	M-001496	Flange Bearing
4	M-101778	Spacer
-	M-104310	Coupling
5	M-104313	Coupling Bolt Sleeve



M-000889

Gear Pump
used w/M-104003 Pulley



M-701472

Front Coupling
(Complete)
Also for Ford Tractors

Lift & Tilt Replacement Parts



Ref #	Part #	Description
1	M-001007	Cylinder Pin w/Clip
2	M-103139	Lift Cylinder w/Pin & Clip
-	M-701104	Lift Cylinder (Complete) includes #'s: 2,3,4,5
2	M-103140	Tilt Cylinder w/Pin & Clip
-	M-701105	Tilt Cylinder (Complete) includes #'s: 2,3,4,5
3	M-700907	Rod End w/Grease Fitting
4	M-103266	Cylinder Pin
5	FTK-00755153	Cotter Pin
6	M-700992	Rod End Clamp w/Set Screw
7	M-000864	Set Screw
-	M-000872	Lift Cylinder Repair Kit
-	M-001074	Lift Cylinder Piston Rod
-	M-000873	Tilt Cylinder Repair Kit
-	M-001079	Tilt Cylinder Piston Rod



Ref #	Part #	Description
1	M-700972	Pivot Assembly w/Bushing (Old Style Interstater)
2	M-702706	Pivot Assembly w/Bushing (New Style Interstater)
3	M-103062	Pivot Pin
4	M-000760	Nut
5	M-103538	Bushing



Ref #	Part #	Description
6	M-700883	Inner Pivot w/Fitting
7	M-02035400	Bolt
8	M-03101646	Lockwasher
9	M-104039	Bushing

Lift & Tilt Replacement Parts (cont.)

Ref #	Part #	Description
1	M-701671	Brake Backing Assembly-RH
1	M-701676	Brake Backing Assembly-LH
2	M-104715	Backing Plate-RH
2	M-104720	Backing Plate-LH
3	M-104719	Brake Disc
4	M-001220	Socket Head Shoulder Screw
5	M-001221	Spring

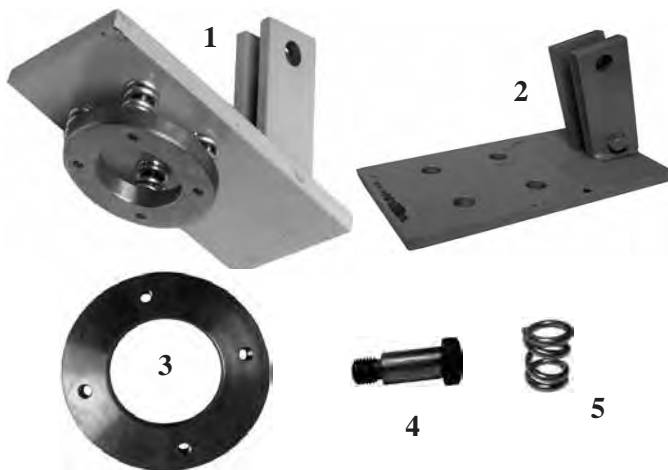

Ref #	Part #	Description
1	M-002019	Magnet Only
2	M-002020	Spacer Only
3	M-107222	Mounting, Switch
-	M-107224	Mounting, RH Wing
-	M-107225	Mounting, LH Wing
4	M-703520	Switch
5	M-703576	Switch Assembly, LH Wing
5	M-703578	Switch Assembly, RH Wing
-	M-703579	Magnet Assembly, RH Wing

Not Able to Find Your Part?
 Call 1-800-251-4020. We have access to thousands of parts not listed in our catalog.



Visit us on the web!
www.flailmaster.com

PTO Assemblies & Components

(Series 5)

M-702299 & M-702300

Part #	Description
M-702299	Complete Assembly (includes: M-701408 & M-701410)
M-702300	Complete Assembly w/slip clutch
M-702300SC	Shield Package for M-702300
M-001747W	Splined Clutch Hub (for M-702300)



Receiving (female) Half

Part #	Description
M-701408	Receiving Half w/plastic shield (accepts 1" square shaft)
M-701494	Shield Assembly for M-701408
M-701937	Receiving Half w/plastic shield (accepts 1 3/16" square shafts)

Shaft (male) Half

Part #	Description
M-701409	Shaft Half w/plastic shield (1" square shaft, approx. 25" long)
M-701410	Shaft Half w/plastic shield (1" square shaft, approx. 31" long)
M-701938	Shaft Half w/plastic shield 1 3/16" shaft, approx. 25" long)
M-701495	Shield Assembly for M-701409
M-701496	Shield Assembly for M-701410



M-14RCB

Cross & Bearing Kit (used in M-701408, 701409, 701410)



M-35RCB

Cross & Bearing Kit (used in M-701937, 701938)



PTO Assemblies & Components (cont.)

Fail Mower Parts



M-001863
Series 6 PTO Assembly w/Slip Clutch (Complete)

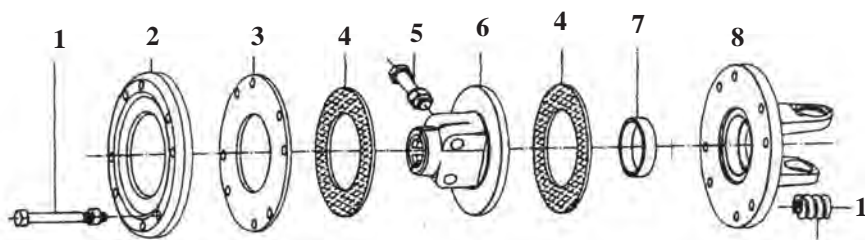

Replacement Parts for FTK-00769131

Ref #	Part #	Description
1	M-001499	Spring Kit (includes 8-Bolts; 8-Nuts; 8-Springs)
2	FTK-00769134	Outer Pressure Plate
3	FTK-00769133	Inner Pressure Plate
4	FTK-00769120	Friction Disc
5	FTK-02965273	Bolt
5	FTK-00762372	Nut
5	FTK-00762420	Lockwasher
6	FTK-00769135	Hub
7	FTK-00762528	Spacer (Bushing)
8	FTK-00769137	Flange w/Yoke



FTK-00769131
Slip Clutch Assembly for Series 6 PTO

Roller Assemblies & Components

Threaded Shaft Roller

NOTE: Threaded rollers are no longer available. Use the following chart to find correct conversion kit.



M-702485
Bearing & Housing
w/set screws & grease fitting



M-105697
Bracket Assembly

OEM Part #	Description	Use
105701	#62 Roller	M-703599H
701646	#62 Roller Assembly	
105702	#74 Roller	M-703600H
701401	#74 Roller Assembly	
105703	#88 Roller	M-703601H
701402	#88 Roller Assembly	

Part #	Description
M-000142	Capscrew
M-000170	Nut
M-000520	Lockwasher
M-001096	Roller Nut
M-106913	Spacer

Roller Assemblies & Components (cont.)**Hex Shaft Roller Assembly**

Ref #	Part #	Description
1	M-107784	Model #62 Roller (55" from end cap to end cap)
1	M-107785	Model #74 Roller (69 1/16" from end cap to end cap)
1	M-107786	Model #88 Roller (82 3/16" from end cap to end cap)
1	M-107787	Model #96 Roller (90 1/2" from end cap to end cap)
2	M-703976SS	Replacement End Cap, Hex Shaft (for all Hex models) (OEM #107783 w/ an additional 1" of material)
3	M-000516	Carriage Bolt
4	M-00001800	Nut
5	M-002037	Seal
6	M-703976	Bearing & Housing (includes hex bearing, housing & grease fitting)
7	M-002039	Grease Fitting
--	M-002486	Bearing only (hex bore)
8	M-107396	Bracket (Single Row of Mounting Holes)
9	M-02976761	Bracket, LH or RH (Two Rows of Mounting Holes)
--	M-107182	(Replaced by M-02976761)
--	M-107380	(Replaced by M-02976761)
3, 4, 5, 6, 8	M-704027	Bracket & Bearing Assembly (Single Row of Mounting Holes)
3, 4, 5, 6, 9	M-703977	LH Bracket & Bearing Assembly (Two Rows of Mounting Holes)
3, 4, 5, 6, 9	M-703978	RH Bracket & Bearing Assembly (Two Rows of Mounting Holes)
1, 3, 4, 5, 6, 8	M-703599H	Model #62 Roller Assembly (Single Row of Mounting holes on brackets)
1, 3, 4, 5, 6, 9	M-703262H	Model #62 Roller Assembly (Two Rows of Mounting Holes on brackets)
1, 3, 4, 5, 6, 8	M-703600H	Model #74 Roller Assembly (Single Row of Mounting holes on brackets)
1, 3, 4, 5, 6, 9	M-703261H	Model #74 Roller Assembly (Two Rows of Mounting Holes on brackets)
1, 3, 4, 5, 6, 8	M-703601H	Model #88 Roller Assembly (Single Row of Mounting holes on brackets)
1, 3, 4, 5, 6, 9	M-703260H	Model #88 Roller Assembly (Two Rows of Mounting Holes on brackets)

Roller Assemblies & Components

Round Shaft Roller Assembly

Flail Mower Parts



Ref #	Part #	Description
1	M-107176	Model #62 Roller , 55" (will soon be obsoleted)
1	M-107177	Model #74 Roller , 69 1/16" (will soon be obsoleted)
1	M-107178	Model #88 Roller , 82 3/16" (will soon be obsoleted)
2	M-703575SS	Replacement End Cap, Round Shaft w/ 1" of additional material (for all Round models)
3	M-703575	Bearing & Housing Assembly (includes round bore bearing, setscrew, grease fitting)
--	M-703574	Bearing (Round Bore), Setscrew & Grease Fitting
--	M-002038	Half Dog Setscrew
4	M-002039	Grease Fitting
5	M-000516	Carriage Bolt
6	M-00001800	Nut
7	M-002037	Seal
8	M-107396	Bracket (Single Row of Mounting Holes)
9	M-02976761	Bracket, LH or RH (Two Rows of Mounting Holes)
--	M-107182	LH Bracket (replaced by M-02976761)
--	M-107380	RH Bracket (replaced by M-02976761)
3, 5, 6, 7, 8	M-703598	Bracket & Bearing Assembly (Single Row of Mounting Holes)
3, 5, 6, 7, 9	M-703263	LH Bracket & Bearing Assembly (Two Rows of Mounting Holes)
3, 5, 6, 7, 9	M-703596	RH Bracket & Bearing Assembly (Two Rows of Mounting Holes)

Miscellaneous Roller Parts (Old Style Rollers)



M-102002
Roller Bearing (#701907)
 mounts inside roller shell
 on old style rollers w/tie rod
 for Models #60 & #72
 3/4" Inside Diameter



M-001092
Roller Bearing (#701906)
 mounts inside roller shell
 on old style rollers w/tie rod
 for Models #74 & #88
 1 3/8" Inside Diameter

Front Foot Guards



Part #	Model	Length
M-107254	#62 Rear Mount SHD/Interstater	62"
M-107256	#74 Rear Mount SHD/Interstater	76 5/8"
M-107257	#74 Wing Mount Interstater	76 3/4"
M-107258	#88 Rear Mount SHD/Interstater	89"
M-107259	#88 Wing Mount Interstater	89 3/4"
M-106330	#88 Rear Mount Interstater (Old Style)	89 3/4"

NOTE: Below are the different style ends for each foot guard. Please, pay careful attention to your style before ordering.



M-107254



M-107256



M-107257



M-107258



M-107259



M-106330

Trash Deflectors



Part #	Description	Length	Thickness	# of Bolt Holes
M-104682	Deflector only for Model #62	63 1/2"	3/16"	9
M-701650	Package for Model #62 (includes deflector & mounting hardware)	63 1/2"	3/16"	9
M-100783	Use M-700524 Kit	---	---	---
M-700524	Package for Model #74 *3/16" thick x 6" tall (includes deflector & mounting hardware)	76 3/4"	3/16"	11
M-100755	Use M-700498 Kit	---	---	---
M-700498	Package for Model #88 *3/16" thick x 6" tall (includes deflector & mounting hardware)	90"	3/16"	12

*New style 3/8" thick x 8" tall available at additional cost, please call for details.

Miscellaneous Replacement Parts

Flail Mower Parts



M-700886
Shoe Wear Plate
w/Bolts and Nuts



M-103051
Shoe Wear Plate (Only)
w/o Bolts and Nuts

Ref #	Part #	Description
-	M-000201	Seal
1	M-000225	Bearing Cone
2	M-000226	Bearing Cup
3	M-000759	Hydraulic Swivel Joint
-	M-000961	Counter Bore Screw
4	M-001083	Mercury Tilt Switch
5	M-001159	Solenoid Valve Assembly (for M-701500)
-	M-001160	Coil Only , 2-Prong (part of M-001159)
6	M-002502	Solenoid Valve Assembly (new Interstaters & SHD)
7	M-002503	Coil Only, 3-Prong (part of M-002502)
-	M-002504	Solenoid Coil Connector



Alamo® / Terrain King®

Flail Axe Replacement Parts

FTK-02956707

Flail Axe Blade



FTK-02958540

Balanced Set of 16
Blades



FTK-02956943

Bushing



FTK-02956948

Nut



FTK-02956949

Hanger Bolt



Miscellaneous Flail Axe Parts

Part #	Description
FTK-00001200	Nut
FTK-00001300	Lockwasher
FTK-02892000	Bolt
FTK-02956712	Trash Deflector
FTK-02956714	Clamp Bar
FTK-02957041	Roller Bearing & Flange
FTK-02958198	Key
FTK-02959835	Cuttershaft Pulley
FTK-02970539	V-Belt
M-000533	Belt



FTK-02958131
Cuttershaft Bearing
& Flange

FTK-02958176
Bearing Insert for
FTK-02958131

Heavy-Duty Boom Mounted & Versa

Blades & Mounting Hardware

Flail Mower Parts

M-100759

Standard-Duty Blade
 .106" Thick
 1 3/4" Wide
 3" Tall
 1" x 1/2" Mtg. hole



FM-7

Heavy-Duty Blade
 .130" Thick
 1 3/4" Wide
 3" Tall
 1" x 1/2" Mtg. hole



FTK-02958063

Extreme-Service Blade
 .192" Thick
 1 1/2" Wide
 3" Tall
 1" x 1/2" Mtg. hole



M-108381

Forged Heavy-Duty Blade
 .196" Thick
 1 3/4" Wide
 3" Tall
 1" x 1/2" Mtg. hole



M-100761

Clevis
 7/16" Hole
 1 7/8" Wide (outside)
 1" Wide (inside ears)
 2 1/2" Tall



M-102670

Clevis Pin
 7/16" x 3"



MP-26

Cotter Pin
 1/8" x 7/8"
 200 per box



Miscellaneous Replacement Parts



M-700886
Shoe Wear Plate w/Bolts and Nuts



M-103051
Shoe Wear Plate (Only) w/o Bolts and Nuts

M-500059

Cuttershaft Pulley
 2-Groove w/Brake
 3/8" Keyway



Part #	Description
FTK-02957167	Bearing
FTK-02957169	Seal
FTK-02957173	Seal, Cuttershaft
M-701650	Trash Deflector Package, Model #62

Extension Arm Assembly



FTK-02880100.....\$49.59 ea
Cable Assembly

Part #	Description
FTK-02959438	Pin, Attach (Versa Flail only)
FTK-02957536	Pin
FTK-02930200	Pin
FTK-10318000	Bolt
M-00001800	Nut, (1/2"-13 locknut)

Miscellaneous Replacement Parts



M-02961001
Hydraulic Filter
(Replaces M-02961002)



M-500031
Cuttershaft Pulley
No Brake
3/8" Keyway



M-702485
Roller Bearing
& Housing

Not Able to Find Your Part?
Call 1-800-251-4020. We have access to thousands of parts not listed in our catalog.

Bomford®

FMB-0281201

Blade
.192" Thick, 3" Tall
1 1/2" Wide
1.24" x .62" Mtg. hole
***Cannot be mixed with O.E.M. blades.**



FMB-0952801

Forged Blade
for Machete/Grass Head
.301" Thick, 4" Tall
1 1/2" Wide
1.4" x .58" Mtg. hole



FMB-0951701

Shackle
0.61" Hole
1.94" Wide (outside)
0.9" Wide (inside ears)
2.6" Tall



FMB-0589501

Shackle

0.61" Hole
1.8" Wide (outside)
1.1" Wide (inside ears)
2.35" Tall



FMB-0295901

Single Piece Blade

1 1/2" Wide



FMB-0990201

Single Piece Blade

2 1/4" Wide



FMB-0280101

Collar for 10mm

lugs, 1/8" lip,
10mm ID, used with
FMB-0589501 Shackle



FMB-0280103

Collar for 6mm

lugs, 1/4" lip,
10mm ID, used with
FMB-0589501 Shackle



FMB-0280701

Spacer

for 6mm &
10mm lugs,
1" OD, 1" long



FMB-0577502

Bolt

M10-1.25 x
85mm



FMB-0528202

Washer

for use with
FMB-0577502 Bolt



FMB-0596802

Self-Locking Nut

10mm, for use with
FMB-0577502 Bolt

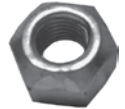

FMB-0367525

**Bolt, Nut &
Washer Pack**

10mm x 85mm
10 of each per pack,
0577502/0596802/0528202



FMB-4259403

Flail-Axe Blade

w/Mounting Ears,
(same as 4640201)
25mm mtg. hole

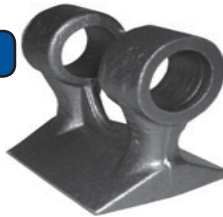

FMB-4259401

Flail-Axe Blade

w/Solid Mounting,
25mm mtg. hole



FMB-0367526

Bolt & Nut Pack

1/2" x 4 7/8", Grade 8
10 of each per pack,
0529504/0541101 for use
with FMB-4259802 collars



FMB-4259802

Collar

for 1/2" Bolt
(Bolt #0529504
or bolt pack #0367526)



FMB-0596806

Self-Locking Nut

14mm, for use with
FMB-0577513 Bolt



FMB-4116701

**Bolt, Nut & Washer
Pack, 14mm x 96mm**

10 of each per pack,
0577510/0596806/058208 for
use with FMB-4259801 collars



FMB-4259801

Collar

for 14mm Bolt
(Bolt #0577513)



FMB-0577513

Bolt, 14mm x 140mm,
used w/ 0596806 nut &
0596806 washer, and
4259801 collar



NOTE: Other Bomford parts available. Call 1-800-251-4020 for prices and availability.



1 1/2" Wide
4.6" Tall
.192" Thick
9/16" Hole

Models
FM36
FM48
FM60
FM72
FH48
FH60
FH72
FH90

FBH-68100 Standard Blade

FBH-68033 Nut

FBH-68035 Keep Plate

FBH-68036 Screw

FBH-68039 Spacer (2 required)

Models FH174 & FH188



1 3/4" Wide
3" Tall
.130" Thick
1" x 1/2" Mtg. hole

FM-7 Heavy-Duty Blade

FM-222207 Thatching Blade (Straight)

FM-222157 Link

FM-7502617 Hanger

750-CB Carriage Bolt

750-LN Lock Nut

Dandi®



1 3/4" Wide
3" Tall
.130" Thick
1" x 1/2" Mtg. hole

DFM-IA2016 Standard Blade



2.7" Tall
2.8 Cutting width
1/2" x 1" Mtg. hole

DFM-2042 Single-Piece Blade

DFM-I4132 Clevis

DFM-I4133 Cotter Pin (200/Box)

DFM-I4134 Clevis Pin



DFM-IA2095 Clevis Pin (1 1/2" Long)

DFM-IA2095EL Clevis Pin (1 3/4" Long)

DFM-IA2098 Clip Insert



TM-203B Bolt & Nut Set



EM-217-1 Heavy-Duty Blade (.25" Thick)
1.8" Wide, 3.6 Tall, .25" Thick,
1.2" x .58" Mtg. hole



EM-301 Standard Blade (.15" Thick)
1.75" Wide, 3.8 Tall, .15 Thick
1" x 1/2" Mtg. hole



EM-815 Ring

EM-9041 Pin



Ford

Blades & Mounting Hardware

Model #917 Fine-Cut

Blade Requirements

Mower Size	# of Stations	Blades Required
5 foot	81	162
6 foot	99	198
7 foot	117	234



1 1/4" Wide
3 1/2" Tall
.085 Thick
.34" x .68" Mtg. hole

FM-7501732 Fine-Cut Blade

FM-7501730 Link

FM-7502618 Hanger

750-CB Carriage Bolt

750-LN Lock Nut

Model #917 Coarse-Cut

Blade Requirements

Mower Size	# of Stations	Blades Required
5 foot	27	54
6 foot	33	66
7 foot	39	78



FM-220398

Single-Piece Blade
2.6" Cutting width,
3" Tall,
1" x 1/2" Mtg. hole



FM-222207

Thatching Blade
1 1/2" Wide, 3" Tall,
.192" Thick, 1" x 1/2" Mtg. hole

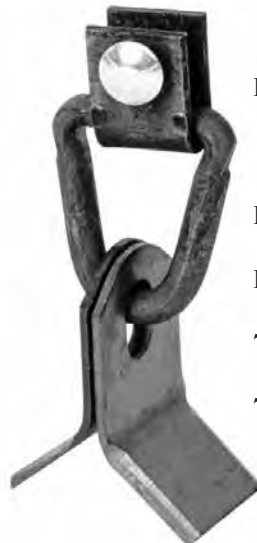

FM-7 Heavy-Duty Blade

1 3/4" Wide, 3" Tall,
.130" Thick, 1" x 1/2" Mtg. hole

FM-222157 Link (also used on Model 907)

FM-7502617 Hanger

750-CB Carriage Bolt

750-LN Lock Nut

Blades & Mounting Hardware (cont.)

Model #918H

Blade Requirements		
Mower Size	# of Stations	Blades Required
62"	40	80
74"	48	96
88"	64	128



1 1/2" Wide
4.6" Tall
.192" Thick
9/16" Hole

FM-6200080 Standard Blade

FM-0000149 Bolt

FM-0000219 Locknut

FM-6200071 Locking Plate

FM-6200072 Spacer (2* required for models 62" & 74")

Use two simple 1/8" thick washers for 88" units

Model #918L

Blade Requirements		
Mower Size	# of Stations	Blades Required
50"	40	80
60"	48	96



1 1/8" Wide
4.7" Tall
1/8" Thick
7/16" Hole



FM-6101080 Blade

FM-390039 Pin

Miscellaneous Parts for Model #917



Ref #	Part #	Description
1	FM-175082	Cross shaft bearing
2	FM-220345	Skid plate with nuts & bolts
3	FM-241565	Cuttershaft bearing (2 required)
4	FM-241565G	Cuttershaft bearing w/grease fitting
5	FM-7501256	Roller bearing housing, Left hand
6	FM-7501257	Roller bearing housing, Right hand
7	FM-7501260	Roller bearing (2 required)
-	FM-7501852	Belt
8	FM-7502212	Idler pulley
9	FM-7502606	Adjustment rod (#917H)
-	FM-7502364	Adjustment rod

Miscellaneous Parts for Model #918H



Ref #	Part #	Description
1	FM-0000411	Roller Bearing
2	FM-0000452	Cuttershaft bearing & housing
3	FM-6201101*	Roller bearing bracket, Right side
4	FM-6201102*	Roller bearing bracket, Left side



Order Today!

Toll Free: 1-800-251-4020

Fax: (615) 896-5652

For detailed product information with photos
visit our website at: www.flailmaster.com.

300 Series

Blade Requirements		
Model	# of Stations	Blades Required
360 Smooth-Cut	27	27
360 Heavy-Duty	27	54
370 Smooth-Cut	33	33
370 Heavy-Duty	33	66
390 Smooth-Cut	42	42
390 Heavy-Duty	42	84



1.9" Wide
3" Tall
.265" Thick
3/4" Hole

- JD-P57928 Heavy-Duty Knife
- JD-P57925 Ring
- JD-P57926 Clip
- JD-19H1777 Cap Screw
- JD-19H1777N Nut

JD-31900

Smooth-Cut Blade, 2.8" Tall
2.9" Cutting width
1/2" x 3/4" Mtg. hole



Miscellaneous Parts for 300 Series

Part #	Description
JD-E14377	Cuttershaft Bearing Housing (bearing not included)
JD-9275	Cuttershaft Bearing
JD-E51728	Belt

Model 25A

Blade Requirements		
Model	# of Stations	Blades Required
Smooth-Cut	36	36
Heavy-Duty	36	72



1 3/4" Wide
3" Tall
.130" Thick
1/2" x 1" Hole

- FM-7 Heavy-Duty Blade
- JD-31903 Link (Ring)
- JD-31905 Hanger
- JD-19H1801 Capscrew, 3/8"
- 750-LN Lock Nut

JD-31900

Smooth-Cut Blade, 2.8" Tall
2.9" Cutting width
1/2" x 3/4" Mtg. hole



Miscellaneous Parts for Model 25A

Part #	Description
JD-9275	Cuttershaft Bearing
MAE-20715	Cuttershaft Bearing & Housing
MAE-29309	Roller Bearing & Housing (Hex bore-replaces MAE-30587)
M-100706	Belt

Blades & Mounting Hardware

Flail Mower Parts

TM-201

Blade
 OEM #TF1019
 .145" Thick
 1 3/4" Wide
 4" Tall
 1/2" x 1" mtg. hole



TM-201F

Single-Piece Blade
 OEM #TF1019F
 2.78" Cutting width
 3" Tall
 1/2" x 1" mtg. hole



TM-201S

Super-Tuf Brand
 (sharpened full length of blade), .145" Thick
 1 3/4" Wide
 4" Tall
 1/2" x 1" mtg. hole

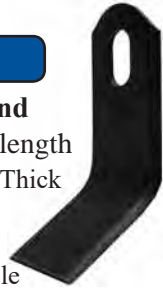

TM-201T

Thatching Blade
 OEM #TF1019T
 .145" Thick
 1 3/4" Wide
 4" Tall
 1/2" x 1" Mtg. hole



TM-28054

Standard-Duty Blade
 .106" Thick
 1 3/4" Wide
 3" Tall
 1/2" x 1" Mtg. hole



TM-33713

Forged Flail Blade
 replaces TM-28054
 .196" Thick
 1 3/4" Wide
 3" Tall
 1/2" x 1" Mtg. hole



TM-33714

Forged Flail Blade
 replaces OEM #TF1019
 3/16" Thick
 1 3/4" Wide
 4" Tall
 .57" x 1.3" Mtg. hole



TM-202

Clevis
 OEM #TF1020
 7/16" Hole
 1 7/8" Wide (outside)
 1" Wide (inside ears)
 2 1/2" Tall



TM-203

Clevis Pin
 OEM #TF1021
 7/16" Wide
 3" Long



MP-26

Cotter Pin
 1/8" x 7/8"
 200 per box



TM-203B

Bolt & Nut Set
 OEM #34011 & 21677

(set = 1 bolt & 1 nut)



WORK SAFER!

Safety vests, face shields & other safety products on pages 58-60.

Blades & Mounting Hardware (cont.)

Boom Mower

TM-3219

D-Ring
(for grass knife only)



TM-3220A

Cup Knife
3.6" Tall
2 1/2" Wide
1/4" Thick
9/16" Mtg. hole



TM-3221

Knife Attaching Ring, Split



TM-3221S

Knife Attaching Ring, Solid



TM-3222A

Knife Hanger



TM-3223A

Knife Bracket



Virtually all Tiger® replacement parts available, call for prices and availability.

Roller Replacement Parts



TM-1022S
Roller Shaft Bearing & Housing (Extra Heavy-Duty)



TM-1022
Roller Shaft Bearing & Housing



TM-1045
Stub Shaft for Ground Roller



TM-4333A
Ground Roller Adjustment Bracket



TM-1041
Dust Cap (Metal) for old style brg/hsg TM-1022

Miscellaneous Replacement Parts

Part #	Description
TM-0102	Sheave
TM-1018	Cuttershaft Bearing & Housing (2 3/16" bore)
TM-28683	Cuttershaft Bearing & Housing (1 15/16" bore)
TM-3020	Belt (for side mount hyd. driven)
TM-3021	Belt (for rear mount PTO driven, 40", 2 required)
TM-3023	Belt (for rear mount PTO driven, 63", 2 required)
TM-3040	Sheave
TM-3609	Bushing with Bearing
TM-6T0110	Cable 1/2" x 7' 3-3/4"
TM-6T0110E	Cable 1/2" x 7' 9-3/4"
TM-6T0104N	Sheave Pin Bushing (for TM-0102 Sheave)
TM-6T1029	Chain for Coupler
TM-6T1030	Sprocket (1 1/8" bore)
TM-6T1031	Sprocket (1 1/2" bore)
TM-6T1033	Coupling Cover Assembly
TM-6T3009	Lower Sheave Pin
TM-6T3010	Upper Sheave Pin
TM-6T3020	Sheave Pin Clip



TM-2752
Skid Shoe, Right Side



TM-27529
Skid Shoe, Left Side



TM-4365
Inner Shoe Wear Plate



TM-4371
Outer Shoe Wear Plate

Flail Mower Parts

Virtually all Tiger® replacement parts available, call for prices and availability.

Vrisimo®

Blades

V-CD2100

Industrial Knife

3.3" Tall
2" Wide
.174" Thick
1/2" x 1" Mtg. hole



V-CD2110

Scoop Knife

2.8" Tall
2.85" Cutting width
1/2" x 3/4" Mtg. hole



More Vrisimo® parts available. Call 1-800-251-4020 for details.

Mounting Hardware

V-CD2120

Hanger



V-CD2135

D-Ring



O.E.M. Style Blades

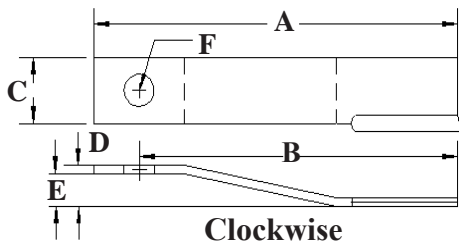

Overall Length: **A**
 Working Length: **B**
 Width: **C**
 Thickness: **D**
 Offset: **E**
 Hole Size: **F**

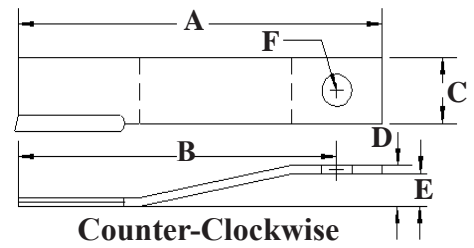

Part Number

FTK-00127028

Fits Models: SMC, Mowal, A-Boom 28°, Hydro 15, Versa Boom 28°, TK530 A-Boom

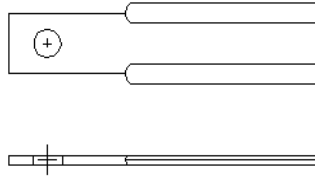

Non-Directional

Overall Length: **14"**
 Working Length: **11 1/2"**
 Width: **3"**
 Thickness: **1/2"**
 Offset: **none**
 Hole Size: **1 1/4"**
 Weight: **6 lbs.**

Part Number

FTK-00750787T

Fits Models: TK15, TK15HD, X5, AG15IV, DB60, Versa 72°, Hydro 15 (right wing)
(OEM sells as set of 2 #00752971)

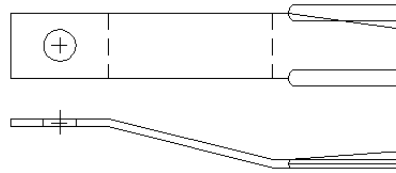

Clockwise

Overall Length: **24 3/4"**
 Working Length: **22 1/4"**
 Width: **3 1/2"**
 Thickness: **1/2"**
 Offset: **3"**
 Hole Size: **1 1/2"**
 Weight: **11.5 lbs.**

Part Number

FTK-00750788T

Fits Models: TK15, TK15HD, X5, AG15IV, AG60/72, MD60/72, Hydro 15 (left wing & center)
(OEM sells as set of 2 #00752972)

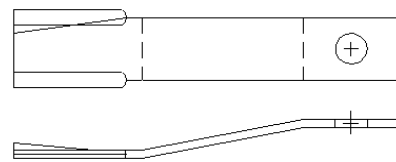

Counter-Clockwise

Overall Length: **24 3/4"**
 Working Length: **22 1/4"**
 Width: **3 1/2"**
 Thickness: **1/2"**
 Offset: **3"**
 Hole Size: **1 1/2"**
 Weight: **11.5 lbs.**

Part Number

FTK-00753841

Fits Models: Alamo 100 Semi-Mount, TK100, 101(HD), 120, AG96

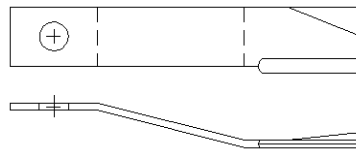

Clockwise

Overall Length: **20"**
 Working Length: **17 1/2"**
 Width: **3 1/2"**
 Thickness: **1/2"**
 Offset: **2"**
 Hole Size: **1 1/2"**
 Weight: **9.4 lbs.**

Part Number

FTK-00753842

Fits Models: Alamo 100 Semi-Mount, TK100, 101(HD), 120, AG96

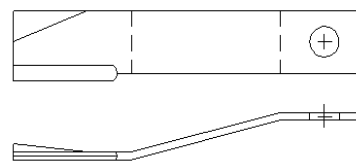

Counter-Clockwise

Overall Length: **20"**
 Working Length: **17 3/4"**
 Width: **3 1/2"**
 Thickness: **1/2"**
 Offset: **2"**
 Hole Size: **1 1/2"**
 Weight: **9.4 lbs.**

Blade bolts and related mounting hardware can be found on pages 46-48.

O.E.M. Style Blades

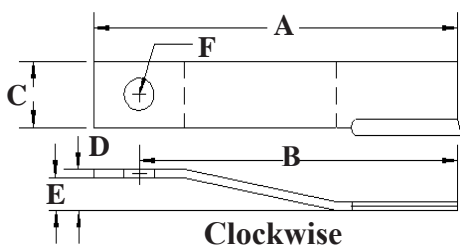

Clockwise

- Overall Length: **A**
- Working Length: **B**
- Width: **C**
- Thickness: **D**
- Offset: **E**
- Hole Size: **F**

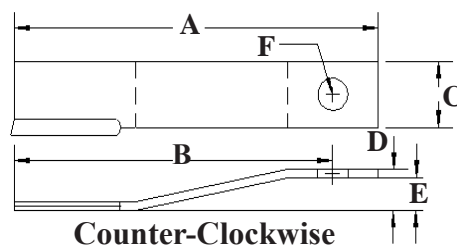

Counter-Clockwise

Part Number

FTK-02726900

Fits Models: Boom Axe models, Machete Boom, Slopemower, Versa Boom 60", A-Boom 60"
(OEM sells as set of 2 #02761500)

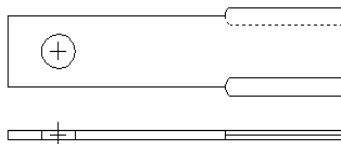

Non-Directional

- Overall Length: **14 1/2"**
- Working Length: **12"**
- Width: **5"**
- Thickness: **5/8"**
- Offset: **none**
- Hole Size: **1 1/2"**
- Weight: **12 lbs.**

Part Number

FTK-02761500

Fits Models: A-Boom, Boom-Axe, Double Swing, Machete, Minute Man, Rear Mount Boom, Slopemower, Versa
(Set of 2 Blades w/Roll Pins)

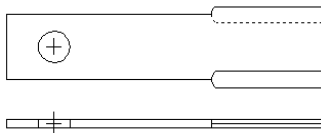

Non-Directional

- Overall Length: **14 1/2"**
- Working Length: **12"**
- Width: **5"**
- Thickness: **5/8"**
- Offset: **none**
- Hole Size: **1 1/2"**
- Weight: **12 lbs.**

Part Number

FTK-02886200

Fits Models: Grass King, Hydro, Versa 60" & 72"
(OEM sells as set of 2-#02977557)

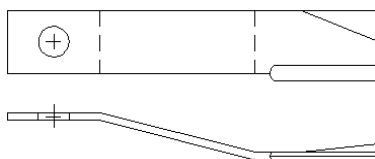

Clockwise

- Overall Length: **20 1/4"**
- Working Length: **17 5/8"**
- Width: **4"**
- Thickness: **1/2"**
- Offset: **2 1/4"**
- Hole Size: **1 1/2"**
- Weight: **11 lbs.**

Part Number

FTK-02962635

Fits Models: Boom Axe models A-Boom 50", Versa Boom 50"
(OEM set of 2 w/roll pins #02962634)
(OEM set of 3 w/roll pins #02962722)

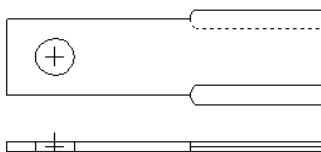

Non-Directional

- Overall Length: **13 5/8"**
- Working Length: **11"**
- Width: **5"**
- Thickness: **5/8"**
- Offset: **none**
- Hole Size: **1 1/2"**
- Weight: **11 lbs.**

Part Number

FTK-02964824

Fits Models: A-Boom, Brahma, Grass King, Versa 60"
(OEM sells as set of 3 #02964960)

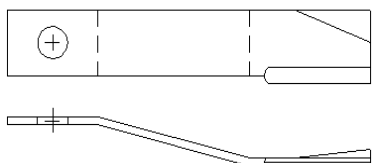

Clockwise

- Overall Length: **18 1/2"**
- Working Length: **16"**
- Width: **4"**
- Thickness: **1/2"**
- Offset: **2"**
- Hole Size: **1 1/2"**
- Weight: **10.8 lbs.**

Blade bolts and related mounting hardware can be found on pages 46-48.

O.E.M. Style Blades

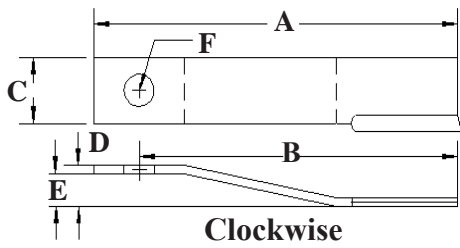

Overall Length: **A**
 Working Length: **B**
 Width: **C**
 Thickness: **D**
 Offset: **E**
 Hole Size: **F**

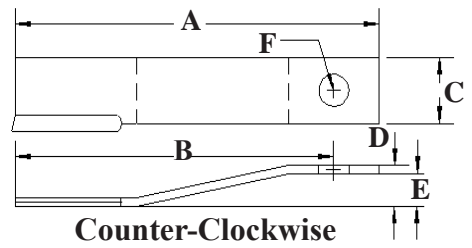

Counter-Clockwise

Part Number

FTK-8588

Fits Models: A315/A415 Flex Wing, AG72-B, A72, Superflex 15III/15HD/15
(Set of 2 Blades)

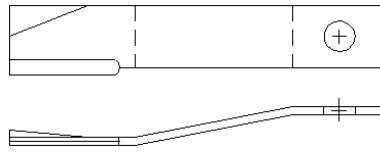

Counter-Clockwise

Overall Length: **26 3/8"**
 Working Length: **25"**
 Width: **4"**
 Thickness: **1/2"**
 Offset: **2"**
 Hole Size: **1 1/2"**
 Weight: **14.4 lbs.**

Part Number

FTK-8589

Fits Models: A315/A415 Flex Wing, AG60-B, AG-60, TW120, Superflex 15III/15HD/15
(Set of 2 Blades)

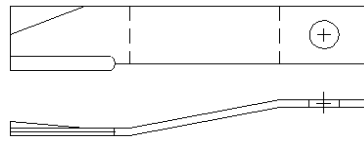

Counter-Clockwise

Overall Length: **20 1/8"**
 Working Length: **18"**
 Width: **4"**
 Thickness: **1/2"**
 Offset: **2"**
 Hole Size: **1 1/2"**
 Weight: **11 lbs.**

Part Number

FTK-8590

Fits Models: A315/A415 Flex Wing, Exten-A-Kut II, SE15, TW120, Superflex 15III/15HD/15
(Set of 2 Blades)

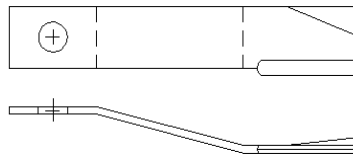

Clockwise

Overall Length: **20 1/8"**
 Working Length: **18"**
 Width: **4"**
 Thickness: **1/2"**
 Offset: **2 1/8"**
 Hole Size: **1 1/2"**
 Weight: **11 lbs.**

Hwy.-Duty Rotary Cutter Parts

WORK SAFER!
 Roadside Safety Equipment,
 including safety vests, shirts,
 chainsaw chaps & other
 products on pages 58-60.

Blade bolts and related mounting hardware can be found on pages 46-48.

O.E.M. Style Blades

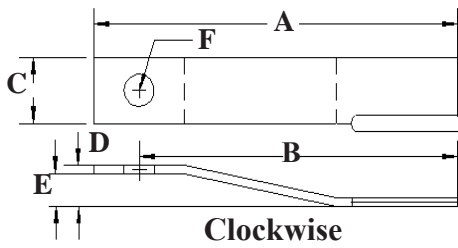

Overall Length: **A**
 Working Length: **B**
 Width: **C**
 Thickness: **D**
 Offset: **E**
 Hole Size: **F**

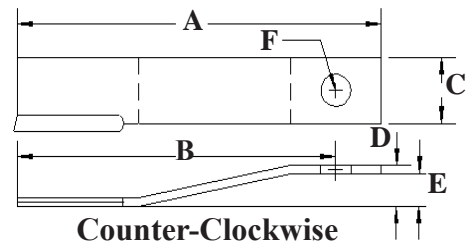

Part Number

BH-11150

Fits Models: 126 right side, 315 left side, 1126 right side, 1226 right side, 1315 left side, 2315 left side, 2615 left side, 2415 left side, 3715 left side

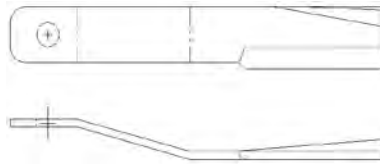

Clockwise

Overall Length: **24 3/4"**
 Working Length: **22 1/4"**
 Width: **4"**
 Thickness: **1/2"**
 Offset: **2"**
 Hole Size: **1 1/2"**
 Weight: **13.3 lbs.**

Part Number

BH-462

Fits Models: 6, 12, 105, 205, 266, 305, 504, 600, 5-FT, SQ60

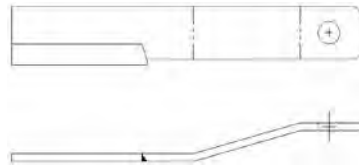

Counter-Clockwise

Overall Length: **24 1/2"**
 Working Length: **22"**
 Width: **3 1/2"**
 Thickness: **1/2"**
 Offset: **2"**
 Hole Size: **1 1/2"**
 Weight: **11.8 lbs.**

Part Number

BH-463

Fits Models: 206, 306, 307, 6-FT, SQ720
 (Can use BH-7556 for an up-lift alternative blade.)

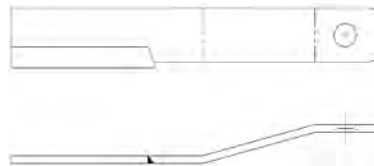

Counter-Clockwise

Overall Length: **27 1/2"**
 Working Length: **25"**
 Width: **3 1/2"**
 Thickness: **1/2"**
 Offset: **2"**
 Hole Size: **1 1/2"**
 Weight: **13 lbs.**

Part Number

BH-464

Fits Models: 207, 257, 307, 7-FT

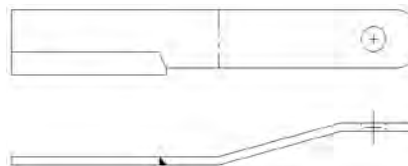

Counter-Clockwise

Overall Length: **30 3/4"**
 Working Length: **28 1/4"**
 Width: **3 1/2"**
 Thickness: **1/2"**
 Offset: **2"**
 Hole Size: **1 1/2"**
 Weight: **14 lbs.**

Part Number

BH-60528

Fits Models: 220 (20' cut)
 (2 per machine)

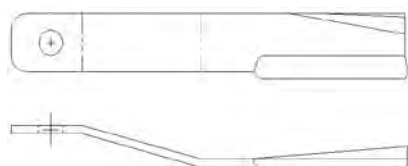

Clockwise

Overall Length: **30 1/4"**
 Working Length: **28 1/4"**
 Width: **4"**
 Thickness: **1/2"**
 Offset: **2"**
 Hole Size: **1 1/2"**
 Weight: **17 lbs.**

Hvy.-Duty Rotary Cutter Parts

O.E.M. Style Blades

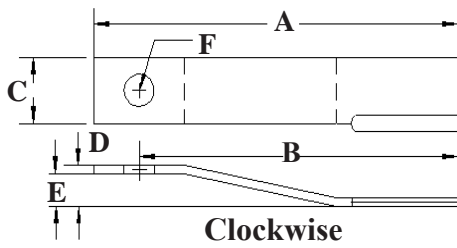

Clockwise

- Overall Length: **A**
- Working Length: **B**
- Width: **C**
- Thickness: **D**
- Offset: **E**
- Hole Size: **F**

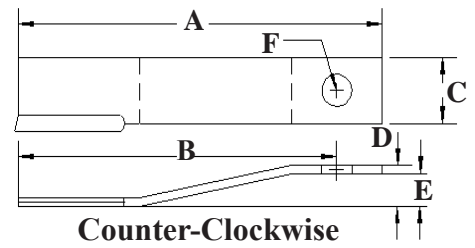

Counter-Clockwise

Part Number

BH-63968

Fits Models: SM60

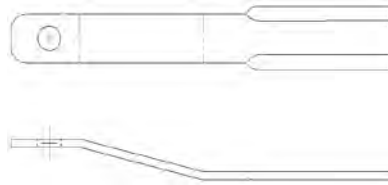

Non-Directional

- Overall Length: **24 1/2"**
- Working Length: **22"**
- Width: **3"**
- Thickness: **1/2"**
- Offset: **2"**
- Hole Size: **1 1/2"**
- Weight: **9.8 lbs.**

Part Number

BH-7278

Fits Models: 406

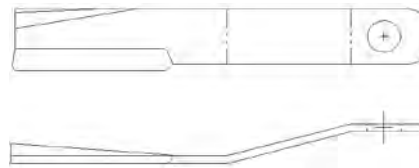

Counter-Clockwise

- Overall Length: **27 3/4"**
- Working Length: **25 1/4"**
- Width: **5"**
- Thickness: **5/8"**
- Offset: **2"**
- Hole Size: **2"**
- Weight: **22.6 lbs.**

Part Number

BH-7555

Fits Models: 126 left & offset, 310 right, 315 right, 1126 left & offset, 1226 left, 1310 right, 1315 right, 6 uplift, 12 uplift, 105 uplift, 205 uplift, 266 uplift, 305 uplift, 502 uplift, 600 uplift, 3715 right, 2315 right, 2615 right, 2415 right

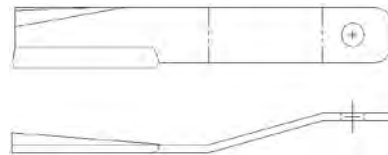

Counter-Clockwise

- Overall Length: **24 3/4"**
- Working Length: **22 1/4"**
- Width: **4"**
- Thickness: **1/2"**
- Offset: **2"**
- Hole Size: **1 1/2"**
- Weight: **13.9 lbs.**

Part Number

BH-7556

Fits Models: 310 center, 315 center, 1310 center, 1315 center, 206 uplift, 306 uplift, SQ720, 3715 center, 2315 center, 2615 center, 2415 center, 3615 center

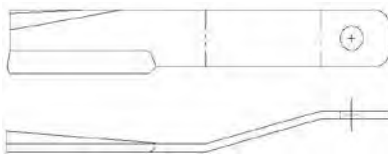

Counter-Clockwise

- Overall Length: **27 3/4"**
- Working Length: **25 1/4"**
- Width: **4"**
- Thickness: **1/2"**
- Offset: **2"**
- Hole Size: **1 1/2"**
- Weight: **15 lbs.**

Part Number

BH-7557

Fits Models: 220 (20' cut), 207, 257, 307

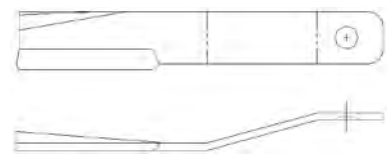

Counter-Clockwise

- Overall Length: **30 3/4"**
- Working Length: **28 1/4"**
- Width: **4"**
- Thickness: **1/2"**
- Offset: **2"**
- Hole Size: **1 1/2"**
- Weight: **17 lbs.**

HWY-Duty Rotary Cutter Parts

O.E.M. Style Blades

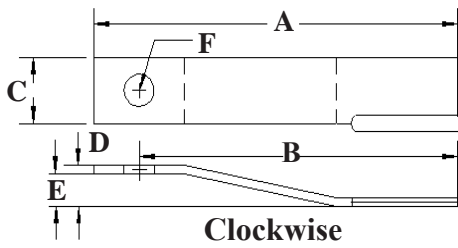

Overall Length: **A**
 Working Length: **B**
 Width: **C**
 Thickness: **D**
 Offset: **E**
 Hole Size: **F**

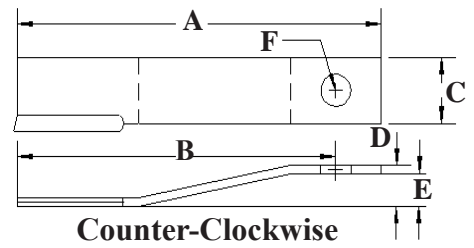

Part Number

BH-7828

Fits Models: 109 left side & offset, 160 right side & center, 166 right side & center, 1109 left side & offset, 1166 right side & center, 1209 left side, 1600 right side & center

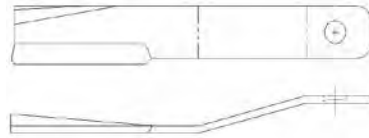

Counter-Clockwise

Overall Length: **19 1/4"**
 Working Length: **16 3/4"**
 Width: **4"**
 Thickness: **1/2"**
 Offset: **2"**
 Hole Size: **1 1/2"**
 Weight: **10.5lbs.**

Part Number

BH-7829

Fits Models: 109 right side, 160 left side, 166 left side, 1109 right side, 1166 left side, 1209 right side, 1600 left side

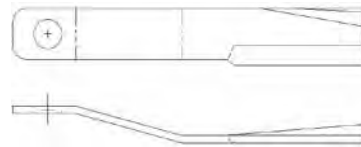

Clockwise

Overall Length: **19 1/4"**
 Working Length: **16 3/4"**
 Width: **4"**
 Thickness: **1/2"**
 Offset: **2"**
 Hole Size: **1 1/2"**
 Weight: **10.5 lbs.**

Part Number

BH-90014

Fits Models: 316S, 1312R, 3126 (2 used), 3126R, 3210, 13126S, updraft (Old #78494)

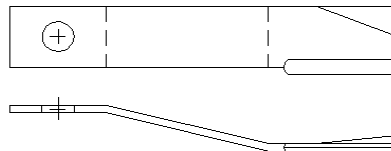

Clockwise

Overall Length: **24"**
 Working Length: **21 1/2"**
 Width: **4"**
 Thickness: **1/2"**
 Offset: **2"**
 Hole Size: **1 1/2"**
 Weight: **13.6 lbs.**

Part Number

BH-90015

Fits Models: 3126-0 (4 used), 3126 (2 used), 3126R & offset, 3126S & offset, 3210, 13126R, 13126S, updraft (Old #78495)

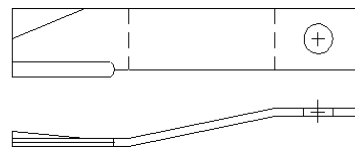

Counter-Clockwise

Overall Length: **24"**
 Working Length: **21 1/2"**
 Width: **4"**
 Thickness: **1/2"**
 Offset: **2"**
 Hole Size: **1 1/2"**
 Weight: **13.6 lbs.**

Hvy.-Duty Rotary Cutter Parts



Visit us on the web!
www.flailmaster.com

Blade bolts and related mounting hardware can be found on pages 46-48.

O.E.M. Style Blades

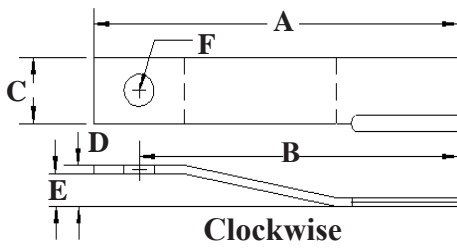

Overall Length: **A**
 Working Length: **B**
 Width: **C**
 Thickness: **D**
 Offset: **E**
 Hole Size: **F**

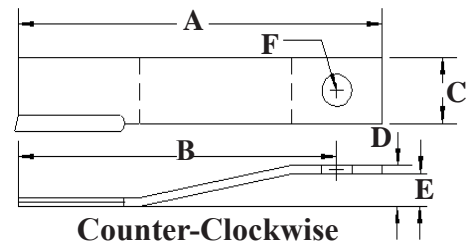

Counter-Clockwise

Part Number

H-C49

Fits Models: T160, T160LT, T160LTO, T166LT, T166LTO, T168, T172, T172LTO, H-CO except 66" & 72" w/Round Blade Holder

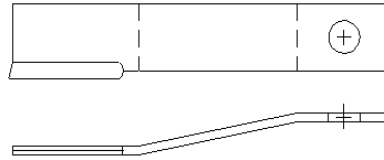

Counter-Clockwise

Overall Length: **23"**
 Working Length: **20 1/2"**
 Width: **3"**
 Thickness: **1/2"**
 Offset: **3"**
 Hole Size: **1 1/2"**
 Weight: **9.3 lbs.**

(Hardee H-C49HD & H-C49ND blades also available, please call for pricing.)

Land Pride®

Part Number

LP-820-112C

Fits Models: RCF(M)45180 (2 used on LH Deck), RCR3510, RCR(M)3515, Parallel Arm Cutter

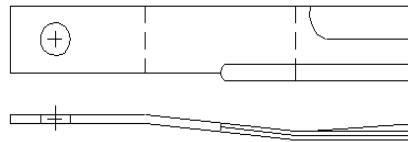

Clockwise

Overall Length: **25"**
 Working Length: **23 1/4"**
 Width: **4"**
 Thickness: **1/2"**
 Offset: **2 1/2"**
 Hole Size: **1 1/2"**
 Weight: **12.9 lbs.**

Part Number

LP-820-137C

Fits Models: RCF(M)45180 (2 for RH Deck), RCR2560, RCR2572, RCR(M)3515, RCR(M)3510, RCR(M)2515, RCR(M)3596

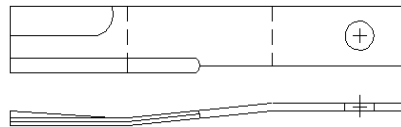

Counter-Clockwise

Overall Length: **25"**
 Working Length: **23 1/4"**
 Width: **4"**
 Thickness: **1/2"**
 Offset: **2 1/2"**
 Hole Size: **1 1/2"**
 Weight: **13.2 lbs.**

Part Number

LP-820-138C

Fits Models: RCR2584, RCR(M) 3515 Center

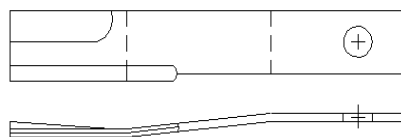

Counter-Clockwise

Overall Length: **31"**
 Working Length: **28 1/2"**
 Width: **4"**
 Thickness: **1/2"**
 Offset: **2 1/2"**
 Hole Size: **1 1/2"**
 Weight: **16.3 lbs.**

Blade bolts and related mounting hardware can be found on pages 46-48.

O.E.M. Style Blades

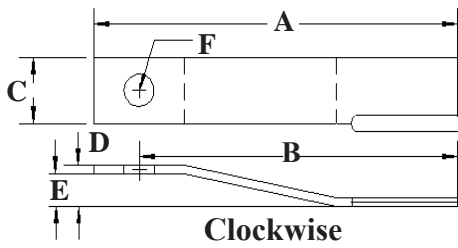

Overall Length: **A**
 Working Length: **B**
 Width: **C**
 Thickness: **D**
 Offset: **E**
 Hole Size: **F**

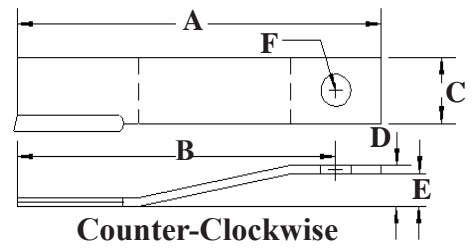

Counter-Clockwise

Part Number

LP-820-168C

Fits Models: RCB6015
 (2 for Center Section), RC(M)5010,
 RC(M)5015, RC(M)6010,
 RC(M)6015

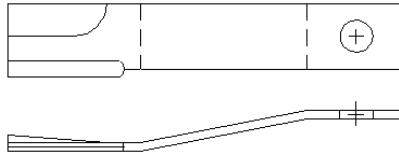

Counter-Clockwise

Overall Length: **29"**
 Working Length: **26 1/4"**
 Width: **4"**
 Thickness: **1/2"**
 Offset: **2 1/2"**
 Hole Size: **1 1/2"**
 Weight: **12 lbs.**

Part Number

LP-820-169C

Fits Models: RCB6015
 (2 for RH Section), RC(M)5010,
 5015, 6010, 6015

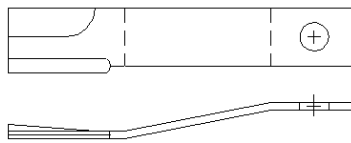

Counter-Clockwise

Overall Length: **23"**
 Working Length: **20 1/2"**
 Width: **4"**
 Thickness: **1/2"**
 Offset: **2 1/2"**
 Hole Size: **1 1/2"**
 Weight: **12.2 lbs.**

Part Number

LP-820-170C

Fits Models: RCB6015 (2 for LH
 Section), RC(M)5015, 6015 (2 for
 LH Wing)

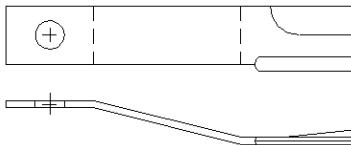

Clockwise

Overall Length: **23"**
 Working Length: **20 1/4"**
 Width: **4"**
 Thickness: **1/2"**
 Offset: **2 1/2"**
 Hole Size: **1 1/2"**
 Weight: **12.2 lbs.**

Schulte®

Part Number

SCH-401-026

Fits Models: XH1500 Wing

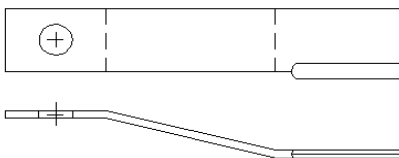

Clockwise

Overall Length: **24 3/4"**
 Working Length: **22 1/4"**
 Width: **4"**
 Thickness: **1/2"**
 Offset: **2 1/4"**
 Hole Size: **1 1/2"**
 Weight: **13.4 lbs.**

Hvy.-Duty Rotary Cutter Parts

Blade bolts and related mounting hardware can be found on pages 46-48.

O.E.M. Style Blades

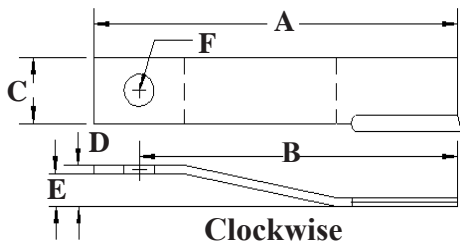

Clockwise

- Overall Length: **A**
- Working Length: **B**
- Width: **C**
- Thickness: **D**
- Offset: **E**
- Hole Size: **F**

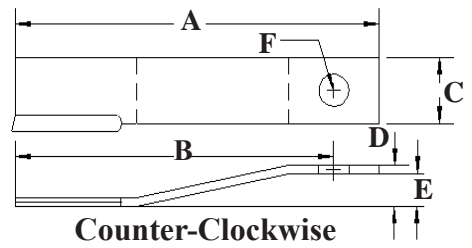

Counter-Clockwise

HWY.-Duty Rotary Cutter Parts

Part Number

SCH-401-027

Fits Models: XH1500 Wing, XH1000

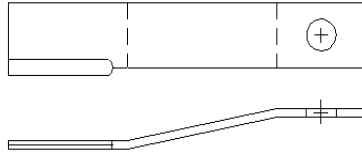

Counter-Clockwise

- Overall Length: **24 3/4"**
- Working Length: **22 1/4"**
- Width: **4"**
- Thickness: **1/2"**
- Offset: **2 1/4"**
- Hole Size: **1 1/2"**
- Weight: **13.4 lbs.**

Part Number

SCH-401-028

Fits Models: XH1500 Center

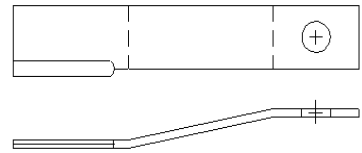

Counter-Clockwise

- Overall Length: **28"**
- Working Length: **25 1/2"**
- Width: **4"**
- Thickness: **1/2"**
- Offset: **1 3/4"**
- Hole Size: **1 1/2"**
- Weight: **15.3 lbs.**

Part Number

SCH-401-032

Fits Models: XH1000

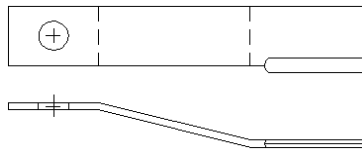

Clockwise

- Overall Length: **28"**
- Working Length: **25 1/2"**
- Width: **4"**
- Thickness: **1/2"**
- Offset: **1 3/4"**
- Hole Size: **1 1/2"**
- Weight: **15.3 lbs.**

Part Number

SCH-401-046

Fits Models: various highway mowers

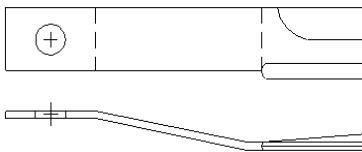

Clockwise

- Overall Length: **25"**
- Working Length: **22 1/4"**
- Width: **4"**
- Thickness: **1/2"**
- Offset: **2"**
- Hole Size: **1 1/2"**
- Weight: **11.6 lbs.**

Part Number

SCH-401-047

Fits Models: various highway mowers

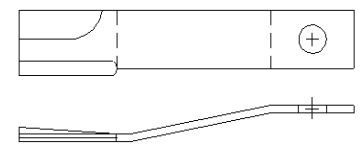

Counter-Clockwise

- Overall Length: **25"**
- Working Length: **22 3/4"**
- Width: **4"**
- Thickness: **1/2"**
- Offset: **2"**
- Hole Size: **1 1/2"**
- Weight: **13.5 lbs.**

Blade bolts and related mounting hardware can be found on pages 46-48.

O.E.M. Style Blades

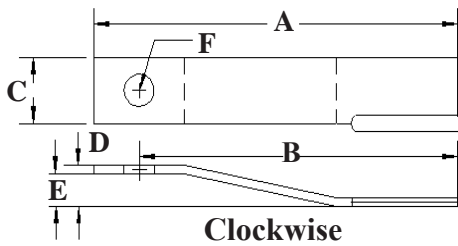

Overall Length: **A**
 Working Length: **B**
 Width: **C**
 Thickness: **D**
 Offset: **E**
 Hole Size: **F**

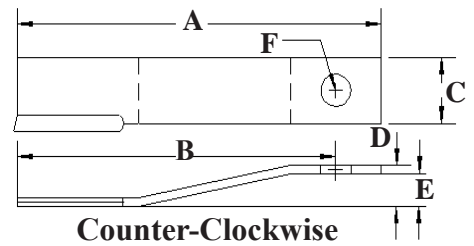

Counter-Clockwise

Part Number

SCH-401-048

Fits Models: various highway mowers

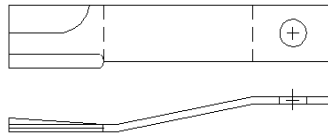

Counter-Clockwise

Overall Length: **29"**
 Working Length: **25 1/2"**
 Width: **4"**
 Thickness: **1/2"**
 Offset: **2"**
 Hole Size: **1 1/2"**
 Weight: **15.3 lbs.**

Part Number

SCH-401-052

Fits Models: various highway mowers

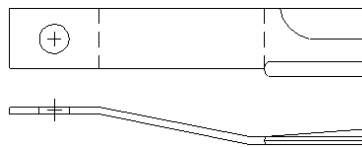

Clockwise

Overall Length: **28"**
 Working Length: **25 1/8"**
 Width: **4"**
 Thickness: **1/2"**
 Offset: **2 1/4"**
 Hole Size: **1 1/2"**
 Weight: **15.5 lbs.**



Visit us on the web!
www.flailmaster.com

Servis-Rhino®

Part Number

FTK-00753841

Fits Models: TW96 (2 used) updraft, SR120, SR 166, SAT8 (after S/N 10340)

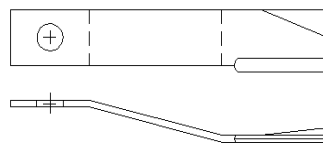

Clockwise

Overall Length: **20"**
 Working Length: **17 3/8"**
 Width: **3 1/2"**
 Thickness: **1/2"**
 Offset: **2"**
 Hole Size: **1 1/2"**
 Weight: **9.41 lbs.**

Part Number

FTK-00753842

Fits Models: TW96 (2 used) updraft, SR120, SR 166, SAT8 (after S/N 10340)

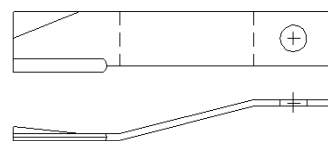

Counter-Clockwise

Overall Length: **20"**
 Working Length: **17 3/8"**
 Width: **3 1/2"**
 Thickness: **1/2"**
 Offset: **2"**
 Hole Size: **1 1/2"**
 Weight: **9.41 lbs.**

Blade bolts and related mounting hardware can be found on pages 46-48.

O.E.M. Style Blades

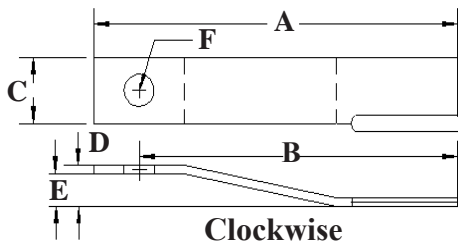

Overall Length: **A**
 Working Length: **B**
 Width: **C**
 Thickness: **D**
 Offset: **E**
 Hole Size: **F**

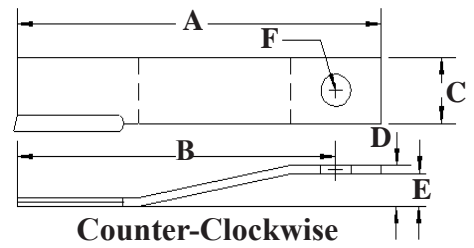

Part Number

FTK-8588

Fits Models: SE15, A72, AG72-B, A415, SR72 (Serial # 10205 & up), TW72, Superflex 15III/15HD/15
(Set of 2 Blades)

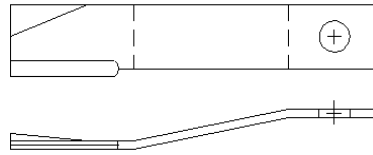

Counter-Clockwise

Overall Length: **26 1/4"**
 Working Length: **24 1/4"**
 Width: **4"**
 Thickness: **1/2"**
 Offset: **2 1/2"**
 Hole Size: **1 1/2"**
 Weight: **14.4 lbs.**

Part Number

FTK-8589

Fits Models: SE15, TW60, TW120, A60, A415, AG60-B, SR60 (S/N #10145 & up), Superflex 15III/15HD/15
(Set of 2 Blades)

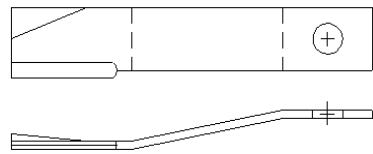

Counter-Clockwise

Overall Length: **20"**
 Working Length: **18"**
 Width: **4"**
 Thickness: **1/2"**
 Offset: **2"**
 Hole Size: **1 1/2"**
 Weight: **11 lbs.**

Part Number

FTK-8590

Fits Models: SE15, right-updraft, TW120, Superflex 15III/15HD/15
(Set of 2 Blades)

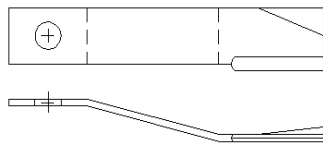

Clockwise

Overall Length: **20 1/4"**
 Working Length: **18 1/4"**
 Width: **4"**
 Thickness: **1/2"**
 Offset: **2"**
 Hole Size: **1 1/2"**
 Weight: **11 lbs.**

Part Number

S-0582010330

Fits Models: CY60, Flex 15, SR15 Center, Flex 20 w/o stump jumper

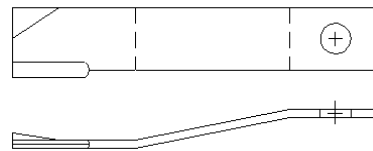

Counter-Clockwise

Overall Length: **27 3/4"**
 Working Length: **25 1/2"**
 Width: **4"**
 Thickness: **1/2"**
 Offset: **1 3/4"**
 Hole Size: **1 3/8"**
 Weight: **14.9 lbs.**

Part Number

S-0622010330

Fits Models: CY60, SR15 (left wing)

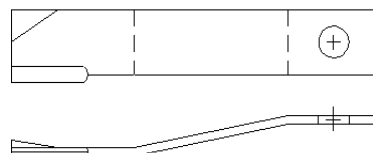

Counter-Clockwise

Overall Length: **24 3/4"**
 Working Length: **22 3/4"**
 Width: **4"**
 Thickness: **1/2"**
 Offset: **2 1/2"**
 Hole Size: **1 3/8"**
 Weight: **13.05 lbs.**

HWY-Duty Rotary Cutter Parts

O.E.M. Style Blades

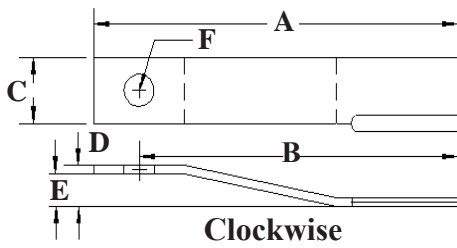

Overall Length: **A**
 Working Length: **B**
 Width: **C**
 Thickness: **D**
 Offset: **E**
 Hole Size: **F**

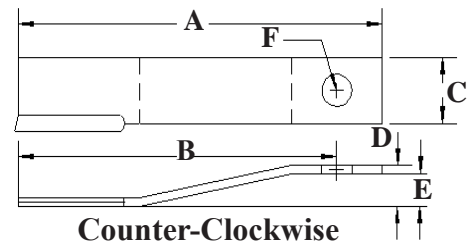

Counter-Clockwise

Part Number

S-58201-3F

Fits Models: Flex 15, SR15, SR15M center-updraft, CY72, FL20-BAR, SR18

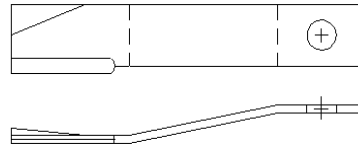

Counter-Clockwise

Overall Length: **27 1/2"**
 Working Length: **25 1/4"**
 Width: **4 1/2"**
 Thickness: **1/2"**
 Offset: **1 1/2"**
 Hole Size: **1 3/8"**
 Weight: **15 lbs.**

Part Number

S-622013F

Fits Models: Flex 15, left-updraft, CY128, CY60, FS15, S128, SM66, SR15

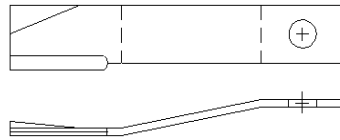

Counter-Clockwise

Overall Length: **24 3/4"**
 Working Length: **22 3/4"**
 Width: **4"**
 Thickness: **1/2"**
 Offset: **2"**
 Hole Size: **1 3/8"**
 Weight: **14 lbs.**

Part Number

S-652011RF

Fits Models: Flex 15, right-updraft, CY128, FS15, S128, SR15

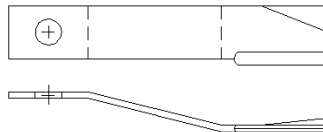

Clockwise

Overall Length: **24 3/4"**
 Working Length: **22 5/8"**
 Width: **4"**
 Thickness: **1/2"**
 Offset: **2"**
 Hole Size: **1 3/8"**
 Weight: **14 lbs.**

Part Number

S-00759338

Fits Models: SR15 Magnum (2 used), left side

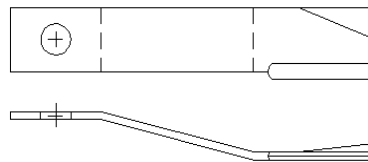

Clockwise

Overall Length: **22 3/16"**
 Working Length: **20"**
 Width: **4 1/2"**
 Thickness: **1/2"**
 Offset: **3"**
 Hole Size: **1 3/8"**
 Weight: **11.9 lbs.**

Part Number

S-00759339

Fits Models: SR15 Magnum (2 used), right side

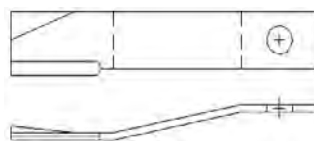

Counter-Clockwise

Overall Length: **22 3/16"**
 Working Length: **20"**
 Width: **4 1/2"**
 Thickness: **1/2"**
 Offset: **3"**
 Hole Size: **1 3/8"**
 Weight: **11.9 lbs.**

Blade bolts and related mounting hardware can be found on pages 46-48.

O.E.M. Style Blades

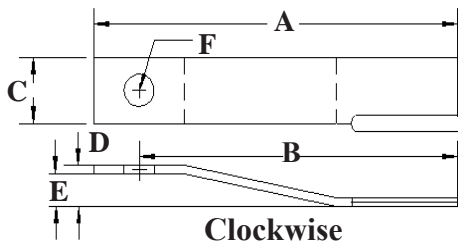

Overall Length: **A**
 Working Length: **B**
 Width: **C**
 Thickness: **D**
 Offset: **E**
 Hole Size: **F**

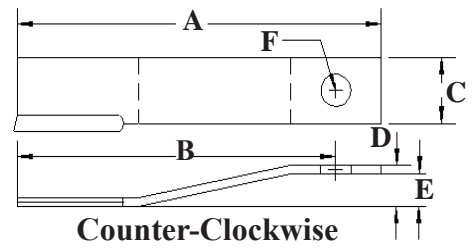

Part Number

TM-06521000

Fits Models:

50" rotary brush cutters
 (must use blade bolt TM-06538000)

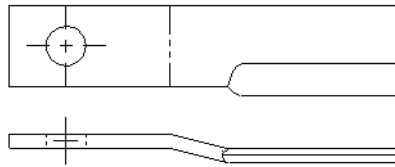

Clockwise

Overall Length: **17"**
 Working Length: **14 1/2"**
 Width: **5"**
 Thickness: **5/8"**
 Offset: **5/8"**
 Hole Size: **1 3/4"**
 Weight: **14.5 lbs.**

Part Number

TM-21251

Fits Models: 72" rotary brush cutters
 (has 1.5" mounting hole)

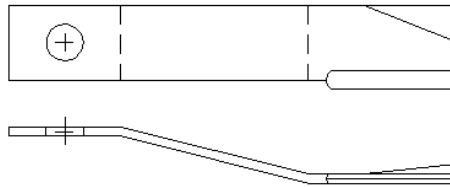

Clockwise

Overall Length: **26"**
 Working Length: **24 1/4"**
 Width: **4"**
 Thickness: **1/2"**
 Offset: **2"**
 Hole Size: **1 1/2"**
 Weight: **14.2 lbs.**

Part Number

TM-33203

Fits Models: Sabertooth®

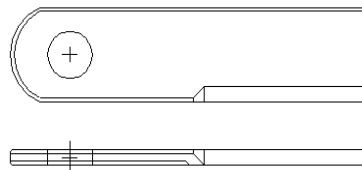

Clockwise

Overall Length: **18 1/4"**
 Working Length: **15 1/4"**
 Width: **6"**
 Thickness: **3/4"**
 Offset: **none**
 Hole Size: **2 3/8"**
 Weight: **20.5 lbs.**

Part Number

TM-34684

Fits Models: New style 60" Side
 combo rotary mower, standard lift
 (must use blade bolt TM-34497)

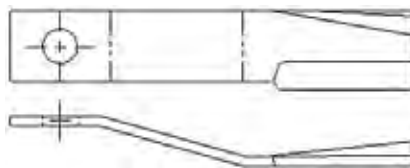

Clockwise

Overall Length: **20"**
 Working Length: **17 1/2"**
 Width: **4"**
 Thickness: **1/2"**
 Offset: **2"**
 Hole Size: **1 3/4"**
 Weight: **11 lbs.**

Part Number

TM-34685

Fits Models: New style 60" Side
 combo rotary mower, high-suction lift
 (must use blade bolt TM-34497)

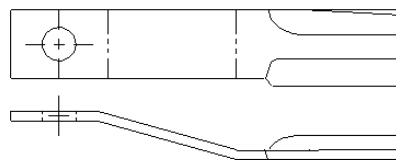

Clockwise

Overall Length: **20"**
 Working Length: **17 1/2"**
 Width: **4"**
 Thickness: **1/2"**
 Offset: **2"**
 Hole Size: **1 3/4"**
 Weight: **10.6 lbs.**

Hwy.-Duty Rotary Cutter Parts

O.E.M. Style Blades

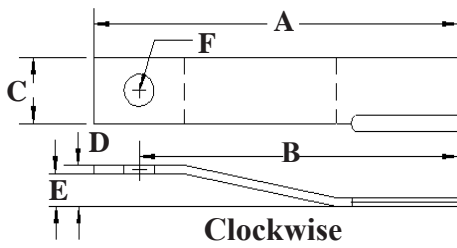

Overall Length: **A**
 Working Length: **B**
 Width: **C**
 Thickness: **D**
 Offset: **E**
 Hole Size: **F**

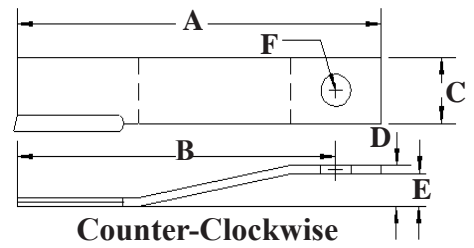

Counter-Clockwise

Part Number

TM-6T1021R

Fits Models:

60" Side, Boom, Twin Rotary,
 & Truckat Boom mowers

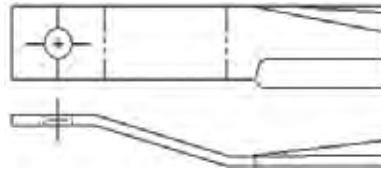

Clockwise

Overall Length: **20"**
 Working Length: **17 1/2"**
 Width: **4"**
 Thickness: **1/2"**
 Offset: **2"**
 Hole Size: **1 1/2"**
 Weight: **11 lbs.**

Part Number

TM-6T1021RS

Fits Models: Suction blade
 for 60" Side, Boom, Twin Rotary
 & Truckat Boom mowers

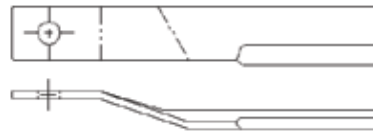

Clockwise

Overall Length: **20"**
 Working Length: **17 1/2"**
 Width: **4"**
 Thickness: **1/2"**
 Offset: **2"**
 Hole Size: **1 1/2"**
 Weight: **11 lbs.**

Part Number

TM-TB2031A

Fits Models: 50" (old style)
 Boom mower

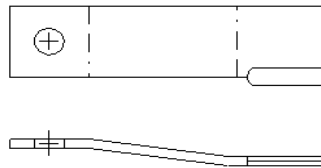

Clockwise

Overall Length: **17"**
 Working Length: **14 1/2"**
 Width: **5"**
 Thickness: **1/2"**
 Offset: **1"**
 Hole Size: **1 1/2"**
 Weight: **12 lbs.**

Part Number

TM-TB2031AHD

Fits Models: Heavy-Duty blade
 for 50" (old style) Boom mower

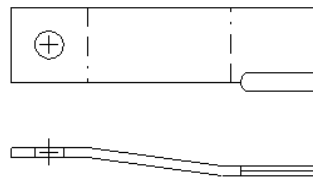

Clockwise

Overall Length: **17"**
 Working Length: **14 1/2"**
 Width: **5"**
 Thickness: **5/8"**
 Offset: **1"**
 Hole Size: **1 1/2"**
 Weight: **14.4 lbs.**

Part Number

TM-TB2031S

Fits Models: Suction blade for
 50" (old style) Boom mower

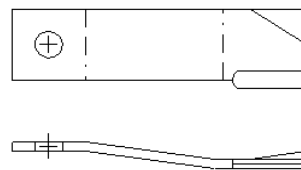

Clockwise

Overall Length: **17"**
 Working Length: **14 1/2"**
 Width: **5"**
 Thickness: **1/2"**
 Offset: **2"**
 Hole Size: **1 1/2"**
 Weight: **11.6 lbs.**

Hvy.-Duty Rotary Cutter Parts

O.E.M. Style Blades

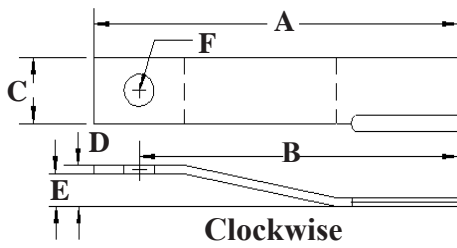

Overall Length: **A**
 Working Length: **B**
 Width: **C**
 Thickness: **D**
 Offset: **E**
 Hole Size: **F**

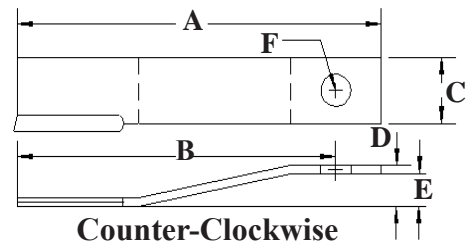

Hvy-Duty Rotary Cutter Parts

Part Number

W-12892

Fits Models: R105, MR105, S105-1, S105-2, P315-2, D315-3, HD315

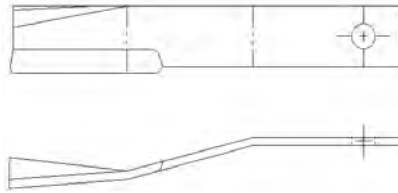

Counter-Clockwise

Overall Length: **24"**
 Working Length: **21 1/2"**
 Width: **4"**
 Thickness: **7/16"**
 Offset: **2 3/4"**
 Hole Size: **1 1/2"**
 Weight: **10.6 lbs.**

Part Number

W-19160

Fits Models: 4 used on 2120, 2162, 3180, 3240, 1260

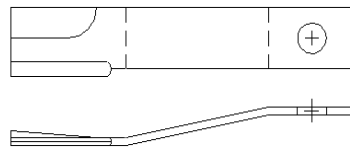

Counter-Clockwise

Overall Length: **25 3/8"**
 Working Length: **22 7/8"**
 Width: **4"**
 Thickness: **1/2"**
 Offset: **1 5/8"**
 Hole Size: **1 1/2"**
 Weight: **13.8 lbs.**

Part Number

W-19161

Fits Models: 2 used on 2120, 2162, 3180, 3240, 1260

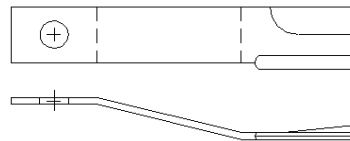

Clockwise

Overall Length: **25 3/8"**
 Working Length: **22 7/8"**
 Width: **4"**
 Thickness: **1/2"**
 Offset: **1 5/8"**
 Hole Size: **1 1/2"**
 Weight: **13.8 lbs.**

Part Number

W-24771

Fits Models: S105-3, P210R, D210R-3, P315-2, D315-3, HD315, 320

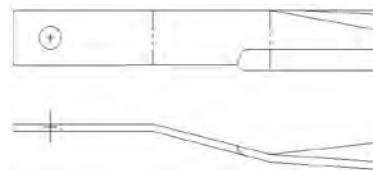

Clockwise

Overall Length: **24"**
 Working Length: **21 1/2"**
 Width: **4"**
 Thickness: **7/16"**
 Offset: **2 9/16"**
 Hole Size: **1 1/2"**
 Weight: **9.75 lbs.**

Part Number

W-3900

Fits Models: for 80 Series mowers

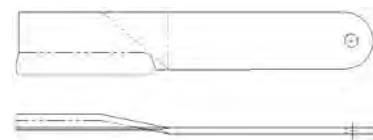

Counter-Clockwise

Overall Length: **18 5/8"**
 Working Length: **17 1/8"**
 Width: **3"**
 Thickness: **3/8"**
 Offset: **none**
 Hole Size: **7/8"**
 Weight: **5.4 lbs.**

Blade bolts and related mounting hardware can be found on pages 46-48.

O.E.M. Style Blades

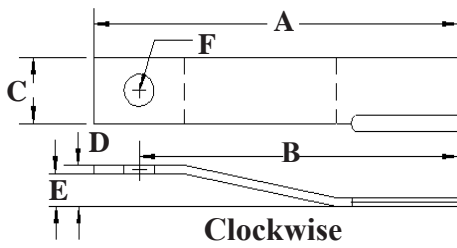

Overall Length: **A**
 Working Length: **B**
 Width: **C**
 Thickness: **D**
 Offset: **E**
 Hole Size: **F**

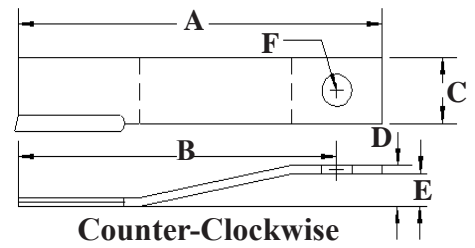

Part Number

W-6323

Fits Models: M84, S106, S106-1, S106-2, 6 and 7 foot, 213, 214, 72 Series mowers

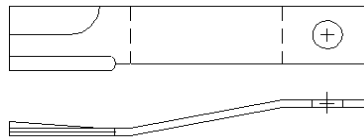

Counter-Clockwise

Overall Length: **30 1/4"**
 Working Length: **27 3/4"**
 Width: **4"**
 Thickness: **3/8"**
 Offset: **1 7/8"**
 Hole Size: **1 1/2"**
 Weight: **13.9 lbs.**

Part Number

W-6866

Fits Models: M5-3, M54, 60-2, 60-3, 60-4, E60

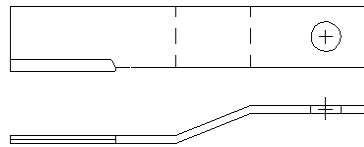

Counter-Clockwise

Overall Length: **22"**
 Working Length: **20 1/2"**
 Width: **3"**
 Thickness: **3/8"**
 Offset: **2"**
 Hole Size: **1 1/2"**
 Weight: **6.7 lbs.**

Part Number

W-8820

Fits Models: HS106-1, S106-3, 211, 213, 213Q, 214, 214Q, 214R, SM214, B214QR, 315, 320, B320Q

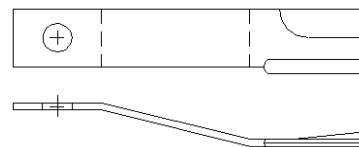

Clockwise

Overall Length: **30 1/4"**
 Working Length: **28"**
 Width: **4"**
 Thickness: **1/2"**
 Offset: **3"**
 Hole Size: **1 1/2"**
 Weight: **16 lbs.**

Part Number

W-8825

Fits Models: Cadet 72 & 84, 84-1, M84, S106-1, S106-2, MD172, 184, T184, 211, 213, 213Q, 214, 214R, 214Q, SM214, 215, 315, 320, B320Q, B214QR

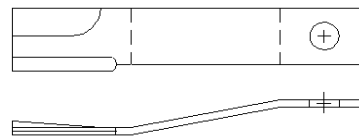

Counter-Clockwise

Overall Length: **30 1/4"**
 Working Length: **28"**
 Width: **4"**
 Thickness: **1/2"**
 Offset: **3"**
 Hole Size: **1 1/2"**
 Weight: **16 lbs.**

Your Part Not Listed?
 Call 1-800-251-4020. We have access to thousands of parts not listed in this catalog.

Mounting Hardware

Alamo® / Terrain King®



FTK-00020900
Slotted Nut



FTK-00735900
Blade Bolt
3 1/2" Long



FTK-00752827
Blade Bolt
3 5/8" Long



FTK-02782900
Blade Bolt
3 1/2" Long



FTK-02964330
Blade Bolt
3 3/4" Long



FTK-8227
Blade Bolt
4" Long



FTK-8251
Blade Bolt
3 5/8" Long



FTK-00747900
Nut



FTK-00748000
Lock Washer



FTK-02782800
Roll Pin



FTK-02964954
Key



FTK-02964161
Blade Bushing (No Step)



FTK-02964815
Blade Bushing (w/.125" Step)

Not Able to Find Your Part?
Call 1-800-251-4020. We have access to thousands of parts not listed in our catalog.

Bush Hog®

Part #	Description
BH-2500	Kit (includes bolt, nut & lock washer)
BH-252	Nut only
BH-253	Lock Washer only
BH-7919	Blade Bolt only



Hwy.-Duty Rotary Cutter Parts

Mounting Hardware

Hardee

Part #	Description
H-C48Kit	Bolt Kit (includes 1-Bolt, 1-Nut,1-Washer)
H-C48	Bolt only
H-C47	Lockwasher only
H-C46	Locknut only



Land Pride®



Part #	Description
LP-802-277CKit	Bolt Kit (includes 1 Bolt, 1 Nut, 1 Washer)
LP-802-277C	Bolt only
LP-803-170C	Nut only
LP-804-067C	Lockwasher only

Schulte®

Part #	Description
SCH-251-101	Bolt & Nut Kit
SCH-251-007	Bolt only
SCH-251-003	Nut only



Servis-Rhino®



Part #	Description
S-571044KIT	Bolt & Nut Kit (1-Bolt, 1-Washer, 1-Nut)
S-571044	Bolt only (1" LH Thread)
S-571045	Washer only
S-5GL16140	Nut only (1"-14 LH Thread)

Part #	Description
S-36-107A-2ALH	Bolt (3/4" LH Thread)
S-5GL12160	Nut (3/4"-16 LH Thread)

Mounting Hardware

Side-winder

Part #	Description
SW-27724	Bolt Kit (1-Bolt, 1-Nut)
SW-15060	Bolt only (w/Cutaway Shank)
SW-15061	Nut only



Tiger®

Part #	Description
TM-6T1022R	Std. Blade Bolt (shown)
TM-34497	Blade bolt for 1/2" thick blades w/ 1-3/4" mtg. hole
TM-06538000	Blade bolt for 5/8" thick blades w/ 1-3/4" mtg. hole
TM-6T1023R	Nylon Lock Nut (for use with all three)



Sabertooth®

Part #	Description
TM-33635	Blade Bolt only
TM-33635Key	Key only for Blade Bolt
TM-33859	Washer
TM-33860	Nut



Woods®



Part #	Description
W-32606	Blade Pin Kit (includes Pin & Clamp)
W-4622	Blade Pin only
W-7A6005	Clamp Kit only



Part #	Description
W-3908	Blade Pin

Hvy.-Duty Rotary Cutter Parts

Blades

Your BEST Choice for Quality Mower Parts

Ariens®

Part #	Replaces OEM #	Description/ Requirements	Length	Center Hole	Outside Holes	Width	Thick
AR-03123759	03123759 03123751	(3) for 48" cut #831031 GT deck	16 9/16"	3/4"	none	2 1/2"	.203"
AR-03535500	03535500 03535551 35975, 13350	(2) for 38" cut, 935000 YT Series	19 3/8"	3/4"	none	2 3/4"	.188"
AR-03624700	03624700 03624759 03624751	(2) for 40" cut	20 1/4"	3/4"	none	2 1/2"	.207"

Bob-Cat/Ransomes

Part #	Replaces OEM #	Description/ Requirements	Length	Center Hole	Outside Holes	Width	Thick
BC-112111-04	112111-04	(3) for 74" cut std. lift	24 15/16"	5/8"	none	2 1/2"	.250"
BC-112243-03	112243-03	(3) for 61" cut, XM Series std. lift	21"	5/8"	none	2 1/2"	.250"
BC-32022A	32022 112111-02	(2) for 36" cut std. blade (3) for 54" cut std. blade	18"	5/8"	1/4"	2 1/2"	.150"
BC-32061HD	32061A&HD 03239, 112111-01	(2) for 32" cut heavy-duty (3) for 48" cut heavy-duty	16 1/4"	5/8"	11/32"	2 1/2"	.240"

Dixie Chopper

Part #	Replaces OEM #	Description/ Requirements	Length	Center Hole	Outside Holes	Width	Thick
DC-30227-50H	30227-50H 30227-H	Hi-Lift (3) for 50" cut	17"	5/8"	none	2 1/2"	.250"
DC-30227-60	30227-60N	(3) for 60" cut	20 1/2"	5/8"	none	2 1/2"	.204"
DC-30227-60H	30227-60H	Hi-Lift (3) for 60" cut	20 1/2"	5/8"	none	2 1/2"	.250"
DC-30227-72H	30227-72H	for 72" cut, XXW2500 & 4000 Series	24"	5/8"	none	2 1/2"	.240"

Excel/Hustler

Part #	Replaces OEM #	Description/ Requirements	Length	Center Hole	Outside Holes	Width	Thick
EX-076752	076752	(3) for 60" cut model 2500 & outfront	20 15/16"	1/2"	none	2 3/4"	.187"
EX-782516	782516	(3) for 60" cut, Super Z	20 61/64"	5/8"	none	3"	.250"
EX-783753	783753	(3) for 52" cut, Fast Track & Mini Z	17 55/64"	5/8"	none	2 1/2"	.203"
EX-793794	793794	(3) for 60" cut	20.5"	5/8"	none	2 1/2"	.203"
EX-794685	794685	(3) for 60" cut, Z & Super Z XR7 & side discharge	20.5"	5/8"	none	2 1/2"	.203"
EX-797696	797696	(3) for 54" cut, XR7 Super Z & Z3	18 1/2"	5/8"	none	2 1/2"	.203"

Exmark®

Part #	Replaces OEM #	Description/ Requirements	Length	Center Hole	Outside Holes	Width	Thick
EXM-403026	323515,403026 103-2527 103-6583	(3) for 48" cut	16 1/4"	5/8"	none	2 1/2"	.150"
EXM-403086	403086,403148 103-6581 103-2517	Mulching Blade (3) for 48" cut	16 1/4"	5/8"	none	2 1/2"	.164"
EXM-613112	613112	Mulching Blade fits 60" Lazer Z	20 7/16"	5/8"	none	2 1/2"	.204"
EXM-613250MM	613250 633483 103-2530	Gator Mulcher Magnum (3) for 60" Lazer Z or Turf Ranger	20 1/2"	5/8"	none	2 1/2"	.250"
EXM-633482	633482 13-2528	(3) for 52" Turf Ranger Turf Tracer & Lazer Z	18"	5/8"	none	2 1/2"	.203"
EXM-633483	633483 103-2530	(3) for newer 60" Lazer Z or Turf Ranger	20 1/2"	5/8"	none	2 1/2"	.210"
EXM-633484	633484 103-2518 103-6582	Mulching Blade fits 52" Lazer Z	17 15/16"	5/8"	none	2 1/2"	.204"
EXM-643006	643006 103-2531	fits 72" Lazer Z	24 7/16"	5/8"	none	3"	.203"
EXM-653101	653101 103-2529	fits 44" Lazer Z	15 3/16"	5/8"	none	2 1/2"	.205"
EXM-653102	653102 103-2519	Std. Mulching Blade (3) for 44" Lazer Z	15 3/16"	5/8"	none	2 1/2"	.212"
EXM-653102M	653102 103-2519	Gator Mulching Blade (3) for 44" cut	15 1/4"	5/8"	none	2 1/2"	.203"

Ferris

Part #	Replaces OEM #	Description/ Requirements	Length	Center Hole	Outside Holes	Width	Thick
FE-1521227	1521227 1521227S	(2) for 36" cut (3) for 52" cut	18"	5/8"	none	2 1/2"	.250"
FE-1520842	1520842	(3) for 61" Comm. Pro Cut	21"	5/8"	none	2 1/2"	.250"
FE-1520843	1520843 1520843S	(3) for 48" cut	16 1/4"	5/8"	none	2 1/2"	.250"
FE-48113	48113 48112	(3) for 72" cut	24 1/2"	5/8"	none	2 1/2"	.203"

**Gator Mulcher™ Blades available for many manufacturers/models.
Call 1-800-251-4020 for prices and availability.**

**Benefits:**

- Pulls clippings down and discharges them from deck.
- Aids in re-cutting of clippings for quicker decomposing.
- Moves more air with less horsepower.
- Produces fine clippings. Promotes clipping flow to center of the deck.
- Longer wear. Holds cutting edge longer.
- Provides more efficient recutting of clippings.

Blades

Your BEST Choice for Quality Mower Parts

Grasshopper®

Part #	Replaces OEM #	Description/ Requirements	Length	Center Hole	Outside Holes	Width	Thick
GH-320231	320231	(3) for 44" cut	15"	1/2"	none	2"	.204"
GH-320236	320236	(3) for 52" cut, outer blade for 48" cut, Low-Lift	18"	1/2"	none	2"	.204"
GH-320237	320237 320239	(3) for 52" cut, Hi-Lift	18"	1/2"	none	2"	.204"
GH-320242	320242	Low Lift (3) for 61" cut	21"	1/2"	none	2 1/2"	.250"
GH-320243	320243A 320244	Heavy Duty, Hi-Lift (3) for 61" cut	21"	1/2"	none	2 1/2"	.250"
GH-320245	320243 320245	Heavy Duty, <u>Notched</u> Hi-Lift (3) for 61" cut	21"	1/2"	none	2 1/2"	.250"

Gravely®

Part #	Replaces OEM #	Description/ Requirements	Length	Center Hole	Outside Holes	Width	Thick
GR-025124	025124 08904651 08899000	(2) for 40" cut (3) for 60" cut	20 1/2"	5/8"	none	2"	.250"
GR-03498451	014668 03498451 08899800	(3) for 40" cut fits Pro100 Series	13 7/8"	5/8"	none	2"	.204"
GR-046998	046998 08779251 08899600	(3) for 50" cut, Hi-Lift fits Pro200 & 300 Series & 34Z	17"	5/8"	none	2 1/2"	.260"
GR-08861651	11234 08861651 08899300	(3) for 50" cut fits Pro150, 200 & 300 Series	17"	5/8"	none	2"	.204"

Great Dane

Part #	Replaces OEM #	Description/ Requirements	Length	Center Hole	Outside Holes	Width	Thick
GD-D18036	D18036	(3) for 61" cut	21"	5/8"	none	2 1/2"	.204"
GD-D18037	D18037	(2) for 36" cut (3) for 54" cut	18"	5/8"	none	2 1/2"	.204"
GD-D18086A	D18086A	(3) for 48" cut	16 1/2"	5/8"	none	2 1/2"	.203"
GD-D18406	D18406	(3) for 36" cut	12 21/32"	5/8"	none	2 1/2"	.203"

Jacobsen

Part #	Replaces OEM #	Description/ Requirements	Length	Center Hole	Outside Holes	Width	Thick
JA-390515	JT390515	(3) for 72" cut, fits Turfcut	24 15/16"	7/16"	13/32"	2 1/2"	.250"
JA-391039	JT391039	LH Cut (4) for HR511	23"	17/32"	2 7/8"	2 1/2"	.250"
JA-391040	JT391040	RH Cut (3) for HR511	23"	17/32"	13/32"	2 1/2"	.250"

John Deere

Part #	Replaces OEM #	Description/Requirements	Length	Center Hole	Outside Holes	Width	Thick
JD-AM100946	AM100946 M82408 M83459	(2) for 38" cut riding mowers	19 1/2"	11/16"	none	2 1/2"	.204"
JD-AM31100	AM31100 M41967	(3) for 46" cut, fits 46", 47" & 48" lawn tractors	16"	11/16"	none	2"	.188"
JD-AM102401	AM102401 M141786 M80783 M83363	(3) for 72" cut, fits 750-1070 Series	25"	29/32"	none	2 1/2"	.302"
JD-AM102402	AM102402 M83363	(3) for 72" cut, fits 272 rear mount, Heavy-duty	25"	29/32"	none	2 1/2"	.310"
JD-M115495	M115495	(3) for 48" cut (new style)	16 5/8"	51/64"	none	2 1/2"	.203"
JD-M115496	M115496 M113517	(3) for 54" cut, front mount & Z trak	18 5/8"	13/16"	none	2 1/2"	.204"
JD-M119975	M119975	(3) for 72" cut, fits F925, F935, F1145 front mount	25"	29/32"	none	2 1/2"	.302"
JD-M128485	M128485 M144196	for 60" Z-Trac, 7 Iron decks	21"	29/32"	none	2 1/2"	.312"
JD-M143520	M143520 M145516	(3) for 54" cut, convertible deck	18 29/32"	51/64"	none	2 1/2"	.203"
UJD-13	AM100538 M87622 M141785	(3) for 60" cut, fits models 425/445/455/400/420/430	20 1/2"	29/32"	none	2 1/2"	.302"

Kubota®

Part #	Replaces OEM #	Description/Requirements	Length	Center Hole	Outside Holes	Width	Thick
KU-5677-34340	5677-34340 76553-34330	(3) for 72" Pro Deck, Hi-lift	24 1/2"	1 1/8"	none	2 1/2"	.250"
KU-70090GM	30708, 70090 5676-97520	(3) for 72" cut, Gator Mulcher Magnum	24 5/8"	1 1/8"	none	2 1/2"	.250"
KU-76539-34330	76539-34330 7000-00602	(3) for 60" cut, front mount	20 9/16"	1 1/8"	none	2 1/2"	.250"
KU-76540-34330	76540-34330	(3) for 60" cut, fits RC60-20 & RC60-25	20 7/16"	29/32"	none	2 1/2"	.250"
KU-76550-34330	76550-34330	(3) for 72" cut, fits RC72, Model 2900L w/ RC7229 deck	24 1/2"	59/64"	none	2 1/2"	.312"
KU-76553-34330	76553-34330 70000-25002	(3) for 72" cut, std. lift	24 1/2"	1 1/8"	none	2 1/2"	.25"

**Gator Mulcher™ Blades available for many manufacturers/models.
Call 1-800-251-4020 for prices and availability.**

**Benefits:**

- Pulls clippings down and discharges them from deck. Aids in re-cutting of clippings for quicker decomposing.
- Moves more air with less horsepower.
- Produces fine clippings. Promotes clipping flow to center of the deck.
- Longer wear. Holds cutting edge longer.
- Provides more efficient recutting of clippings.

Scag

Part #	Replaces OEM #	Description/ Requirements	Length	Center Hole	Outside Holes	Width	Thick
SC-A48108	A48108 481707 482878	(2) for 36" cut, (3) for 52" cut, fits Tiger Cub, Wildcat, Turf Tiger	18"	5/8"	none	2 1/2"	.204"
SC-A48110	A48110 481706	(2) for 32" cut (3) for 48" cut	16 1/2"	5/8"	none	2 1/2"	.204"
SC-A48111	A48111 481708	(3) for 61" cut	21"	5/8"	none	2 1/2"	.204"
SC-A48112	A48112 48113 481709	(3) for 72" cut	24 1/2"	5/8"	none	2 1/2"	.204"
SC-A48184	A48184 481710	(2) for 32" cut, Hi-Lift (3) for 48" cut, Hi-Lift	16 1/2"	5/8"	none	3"	.204"
SC-A48185	A48185 481711	(2) for 36" cut, Hi-Lift (3) for 52" cut, Hi-Lift	18"	5/8"	none	3"	.204"
SC-A48304	A48304 481712	Super Hi-Lift (3) for 61" cut	21"	5/8"	none	3"	.203"

Toro®

Part #	Replaces OEM #	Description/ Requirements	Length	Center Hole	Outside Holes	Width	Thick
TO-23-2410	23-2410	Hi-Lift, LH Turn (3) for 72" cut Groundmaster	25"	3/4"	none	2 1/2"	.250"
TO-29-5530	29-5530	(3) for 72" cut, LH Turn	24 15/16"	3/4"	none	2 1/2"	.240"
TO-44-5480	44-5480 27-0990	(2) for 36" cut, Hi-Lift (3) for 52" cut, Hi-Lift Wide area walk behind	18"	1/2"	none	2 1/2"	.188"
TO-44-6250	44-6250 44-6250-03	(3) for 62" cut Groundsmaster	21 1/2"	1/2"	none	2 1/2"	.203"
TO-56-2390	56-2390	(2) for 36" cut, (3) for 52" cut, fits walk behind & Z Master	18"	1/2"	none	2 1/2"	.194"
TO-69-6920	69-6920	(11) for 16' cut Groundmaster 580D model	20"	5/8"	none	2 1/2"	.250"
TO-85-6040	85-6040	(3) for 72" cut, Recycler, Groundmaster	25 7/32"	1/2"	none	2 1/2"	.250"
TO-86-0010	86-0010	(7) for 455D model	19"	1/2"	none	2 1/2"	.250"
TO-92-5608	92-5608	(3) for 62" cut, Recycler	21 11/16"	1/2"	none	2 1/2"	.250"

Why should you be using our Oregon® blades?



- Our blades are made in the U.S.A.
- Our blades have superior life because they are 20% harder
- Our blades stay sharp longer because of their heat treat
- Our blades are precision straightened for less vibration

Walker

Part #	Replaces OEM #	Description/ Requirements	Length	Center Hole	Outside Holes	Width	Thick
WA-5705-3	5705-3	RH Cut (1) for 42" cut rear discharge (3) for 54" cut	22"	5/8"	3/16"	2 3/4"	.164"
WA-5705-4	5705-4	LH Cut (1) for 42" cut rear discharge (3) for 54" cut	22"	5/8"	3/16"	2 3/4"	.164"
WA-7705-1	7705-1	Hi-Lift, RH Cut (1) for 48" cut rear discharge	25"	5/8"	3/16"	2 3/4"	.164"
WA-7705-2	7705-2	Hi-Lift, LH Cut (1) for 48" cut rear discharge	25"	5/8"	3/16"	2 3/4"	.164"

Woods®

Part #	Replaces OEM #	Description/ Requirements	Length	Center Hole	Outside Holes	Width	Thick
WO-24590	24590	(6) for 44" cut	11 1/2"	7/8"	none	2"	.203"
WO-31306	13404 31306	LH Cut, (3) for 72" cut (L306, RM306, RM600)	24 7/16"	1"	none	2 1/2"	.203"
WO-31359	23825 31359	LH Cut, (3) for 60" cut (RM59)	20 3/16"	5/8"	none	2"	.204"
WO-6950	6950	Medium Lift, (3) for 60" cut	20 3/16"	5/8"	none	2"	.204"
WO-70134	70134	(3) for 61" cut	21"	1/2"	none	2 1/2"	.250"

Wright

Part #	Replaces OEM #	Description/ Requirements	Length	Center Hole	Outside Holes	Width	Thick
WR-71440001	71440001	(2) for 36" cut (3) for 52" cut	18"	5/8"	none	2 1/2"	.204"
WR-71440001M	71440001	(2) for 36" cut, (3) for 52" cut, Gator Mulcher Magnum	18"	5/8"	none	2 1/2"	.203"
WR-71440002	71440002	(2) for 32" cut (3) for 48" cut	16 1/2"	5/8"	none	2 1/2"	.204"
WR-71440003	71440003	(3) for 61" cut	21"	5/8"	none	2 1/2"	.204"



Yazoo/Kees

Part #	Replaces OEM #	Description/ Requirements	Length	Center Hole	Outside Holes	Width	Thick
YZ-206-660	206-660	(3) for 60" cut	20 3/4"	3/4" x 1 1/4"	none	2 1/4"	.250"
YZ-206-970	206-970	(3) for 61" cut	21 3/8"	5/8"	none	2 1/2"	.203"

Choose a Standard Line That's Right for You.

Size	Recommended Usage
.080"	Homeowner, 20 to 24.5cc, curved shaft models with manual and automatic feed heads.
.095"	Homeowner and commercial, 25 to 39.5cc, curved and straight shaft models with automatic and manual feed heads.
.105"	Commercial, 40cc and higher, straight shaft models with manual feed heads.
.130"	Commercial, 40cc and higher, straight shaft models with a fixed line head; also for use with high-wheel, walk behind trimmers.
.155"	Commercial, 40cc and higher, straight shaft models with a fixed line head; also for use with high-wheel, walk behind trimmers, 5 HP and larger.

Shape	Benefits	Recommended Application
Round	-High resistance to line welding. -Fray resistant. -More aerodynamic.	All types of trimmer heads.
Square	-More mass for longer wear. -4 edges cut cleaner and faster. -Fast and clean cutting to reduce browning of grass tips. -Fray resistant.	Manual and semi-automatic heads.
Hexagon	-25% more mass than round line. -No flat surfaces reduces line welding. -Fast and clean cutting to reduce browning of grass tips. -Fray resistant.	All types of trimmer heads.

Style	Size	1 lb. Donuts
		Part Number
 Round Line	.080"	TL-R080-1 (405')
	.095"	TL-R095-1 (285')
	.105"	TL-R105-1 (235')
	.130"	TL-R130-1 (155')
Style	Size	1 lb. Donuts
		Part Number
 Square Line	.080"	TL-S080-1 (327')
	.095"	TL-S095-1 (227')
	.105"	TL-S105-1 (179')
	.130"	TL-S130-1 (120')
Style	Size	1 lb. Donuts
		Part Number
 Hex Line	.080"	TL-H080-1 (385')
	.095"	TL-H095-1 (275')
	.105"	TL-H105-1 (225')
	.130"	TL-H130-1 (145')

3 lb. Spools
Part Number
TL-R080-3 (1,215')
TL-R095-3 (855')
TL-R105-3 (705')
TL-R130-3 (465')
3 lb. Spools
Part Number
TL-S080-3 (980')
TL-S095-3 (681')
TL-S105-3 (538')
TL-S130-3 (360')
3 lb. Spools
Part Number
TL-H080-3 (1,155')
TL-H095-3 (825')
TL-H105-3 (675')
TL-H130-3 (435')

5 lb. Spools
Part Number
TL-R080-5 (2,025')
TL-R095-5 (1,425')
TL-R105-5 (1,175')
TL-R130-5 (775')
5 lb. Spools
Part Number
TL-S080-5 (1,633')
TL-S095-5 (1,134')
TL-S105-5 (896')
TL-S130-5 (600')
5 lb. Spools
Part Number
TL-H080-5 (2,025')
TL-H095-5 (1,375')
TL-H105-5 (1,125')
TL-H130-5 (725')

Choose a Specialty Line That's Right for You.



MAGNUM GATORLINE™

- Dual polymer re-inforced with Aramid Fibers
- Outer layer prevents welding.
- High strength inner core resists breaking.
- Long life, excellent strength.

Style	Size	1 lb. Donuts
		Part Number
Round Magnum 	.095"	TL-RM095-1 (289')
	.105"	TL-RM105-1 (228')
	.130"	TL-RM130-1 (153')
	.155"	TL-RM155-1 (107')

Style	Size	1 lb. Donuts
		Part Number
Square Magnum 	.095"	TL-SM095-1 (227')
	.105"	TL-SM105-1 (179')
	.130"	TL-SM130-1 (120')
	.155"	TL-SM155-1 (84')

Style	Size	1 lb. Donuts
		Part Number
SuperTwist Magnum 	.095"	TL-TM095-1 (280')
	.118"	TL-TM118-1 (180')
	.130"	TL-TM130-1 (150')

3 lb. Spools
Part Number
TL-RM095-3 (867')
TL-RM105-3 (685')
TL-RM130-3 (459')
TL-RM155-3 (320')

3 lb. Spools
Part Number
TL-SM095-3 (681')
TL-SM105-3 (538')
TL-SM130-3 (360')
TL-SM155-3 (251')

3 lb. Spools
Part Number
TL-TM095-3 (867')
TL-TM118-3 (639')
TL-TM130-3 (459')

5 lb. Spools
Part Number
TL-RM095-5 (1,445')
TL-RM105-5 (1,142')
TL-RM130-5 (764')
TL-RM155-5 (533')

5 lb. Spools
Part Number
TL-SM095-5 (1,134')
TL-SM105-5 (896')
TL-SM130-5 (600')
TL-SM155-5 (419')

5 lb. Spools
Part Number
TL-TM095-5 (1,430')
TL-TM118-5 (915')
TL-TM130-5 (750')

Try the new SuperTwist™ Magnum for improved cutting with less noise.

Benefits of the SuperTwist™ Magnum Line

- Reduction in noise level of 15dB compared with traditional round nylon lines •
- Improved cutting efficiency •
- Reduced vibration •
- Less resistance, reducing engine drag •



SILVERBACK Dual-Line 4" Bump & Go Head

- * Fits 95% of all commercial straight-shaft trimmers
- * Extended Line Capacity (holds up to twice as much line as most other heads)
- * Trouble Free Design, simple and tough
- * Designed and Built for Commercial Use
- * Easy Line Reloading, in either direction
- * Comes with 4 adapters and application chart
- * Designed specifically for .080" and .095" line

TH-385-730



EDG-375030



EDG-375287



EDG-375352 (10")
EDG-375360 (9")



EDG-375364



EDG-375048



EDG-375311



Part #	Sharpened Edges	Length	Width	Center Hole	Thickness
EDG-375030	2	9"	2"	1/2"	.155"
EDG-375287	serrated	9"	2 1/2"	5/8"	.105"
EDG-375352	none	10"	2"	1/2"	.105"
EDG-375360	none	9"	2"	1/2"	.105"
EDG-375364	none	8"	2"	1"	.125"
EDG-375048	8	N/A	9"	1/2"	.095"
EDG-375311	none	N/A	9"	1/2"	.103"

HI-VIS SAFETY VESTS *

Available in
HI-VIS Orange
& HI-VIS Green



Mesh
Tear Away
Vest

Velcro
Shoulders
& Sides

RS-VEST3

Be safe, be seen with this 5-point tear away vest. Meets ANSI/ISEA 107-2004 Standards. Meets Class 2 Standards. Machine washable, 100% polyester. Velcro shoulders & sides, w/ inside pocket. Certified flame retardant. Most styles available M - 5XL.

* **RS-VEST3-(Color)-(Size)**

Mesh body, velcro front. Specify HI-VIS Orange or HI-VIS Green

* **RS-VEST2-(Size)**

Solid body w/ zippered front in Hi-Vis Green only

Mesh Non
Tear Away
Vest



RS-VEST12

Non tear away vest. Meets ANSI/ISEA 107-2004 Standards. Meets Class 2 Standards. Machine washable, 100% polyester. Velcro front, w/ inside pockets. Certified flame retardant. Most styles available M - 5XL.

* **RS-VEST12-(Size)**

Mesh body in HI-VIS Green only

HI-VIS SHIRTS *

Will Not Shrink

Wrinkle Free

Will Not Fade



Lightweight, breathable HI-VIS short sleeves shirts, with breast pocket. ANSI/ISEA rated to meet 107-2004. Made in accordance to CLASS 2 Standards. 2" wide reflective stripes. 100% polyester wicks away moisture quickly to bring warmth in the winter and cooling in the summer. Sizes M - 4XL.

Short sleeve w/ stripes * **RS-9051-(Size)**

Short sleeve(no stripes) * **RS-9057-(Size)**



HI-VIS SAFETY VESTS *



(Rear)

Adjustable Straps (Front)

Ultimate Class 2 Vest!



RS-VEST21

New Class 2 safety vest w/ adjustable velcro waist for a perfect fit. Mesh 5-point tear away w/ zippered front and numerous pockets. HI-VIS Green & Orange. Sizes M - 5XL.

* **RS-VEST21-(Size)**

HI-VIS INSULATED WEAR *

RS-INSUL



3M Scotchlite reflective winter safety jacket. Extra durable 300 denier cordura. Full zipper w/ storm flap. Jacket meets ANSI/ISEA 107-2004 Class 3 Standards. Insulated w/ zip off sleeves and polar fleece collar. HI-VIS Green. Sizes: M-4XL

* **RS-INSUL-(Size)**

RS-002053



Insulated, 100% water proof winter pants with extra high back, zip fly and zippered ankles for easy on/off. Quilted insulation w/ super tough 1000 denier nylon shell. HI-VIS Green. Sizes: S-XL

RS-002053-(Size)

RS-HIVISSUIT

Insulated, 100% water proof winter rain suit with zip off sleeves. Includes RS-INSUL and RS-009053.

* **RS-HIVISSUIT-(JCKT/PNTS)**



Custom Printing is available on all of our safety vests and shirts with your city, county or township name on the back. Please contact us for pricing and details @ 1-800-251-4020.

RS-VEST14



Class 3 Non Tear away safety vest. Meets ANSI/ISEA 107-2004 Standards and fire retardant Class 1 Standard. Velcro front, 2" stripes, 2 outside pockets and 1 inside pocket. Safety Green. Sizes M - 5XL.

* **RS-VEST14-(Size)**



CLASS 3 Safety Wear

This suit is the top of the line in reflective gear! 3M reflective stripes meet requirements for CLASS 3 at over 55 MPH. CLASS 1 flame retardant, w/ inside pocket. (Note: Vest is only CLASS 2 when purchased separately.)

A RS-HAT9-(Size)

Jungle hat, HI-VIS Green/Orange, Sizes: S/M or L/XL

* **B RS-VEST11-(Size)**

Mesh body in HI-VIS Green, Sizes: S-5XL

C RS-PANTS9-(Size)

Non-mesh body in HI-VIS Green, Sizes: S-5XL

D RS-7550

STOP/SLOW Road Sign. 18" paddle. Pole stands 79" high, perfect for road workers. Rugged design stands up to all weather conditions.



E RS-010034

FORESTER® Safety Reflective Cap in HI-VIS Green & Orange mix. 100% polyester (1 Size fits Most)



FORESTER

CLASS 3 Rain HI-VIS Suit

FORESTER® 2-Piece Rain HI-VIS Green safety suit. CLASS 3 safety, hooded with full zipper and storm flap. Zippered ankles for easy on/off. Numerous pockets. Sizes: M - 3XL.

F RS-7151G-(Size)

FORESTER® Insulated rubber palm work gloves. Non-slip rubber palm with soft, insulated interior.

G RS-685003-(Size)

Safety Orange, Sizes: M/L or XL

H RS-685001-(Size)

Safety Green, Sizes: M/L or XL

Non-Insulated, One size fits most

Orange: RS-20080-O

Green: RS-20080-G



Your **BEST** Choice for Quality Mower Parts

Dear Valued Customer,

Thank you for choosing **Flail-Master®** as your supplier for quality replacement parts. As you maintain your mowing equipment throughout the season, remember that for more than 50 years we have provided our customers with quality replacement parts at affordable prices and continue to provide unsurpassed customer service.

Flail-Master® is a manufacturer and factory direct company meeting the needs of D.O.T.'s, municipalities, government agencies, universities, hospitals, lawn care professionals, maintenance organizations and individuals across the U.S. We are extremely proud that over **90%** of what we sell is **MADE IN THE USA**, with more than **80%** being produced in our facility **in Tennessee**.

In addition to providing replacement blades and parts, we also have a line of landscaper accessories to help you and your crew work more safely and more efficiently. These products include: arm/leg chapps, neck/ear sun protection, mesh debris bags, roadside safety equipment, Gator Magnum trimmer line, blade sharpeners (rotary blade grinders) and more.

If there is an item you cannot find please contact our Sales Staff at 1-800-251-4020. We have access to thousands of parts not listed in our catalog.

Please take a moment and look through our catalog, or visit our website at www.flailmaster.com and see why **Flail-Master®** is:

Your **BEST** Choice for Quality Mower Parts

Sincerely,
Flail-Master®

Flail Mower Replacement Parts • Heavy-Duty Rotary Cutter Parts
Riding & Walk Behind Mower Parts • Trimmer Parts
Blade Sharpening Equipment • Mowing Accessories

Our Mission:

To provide top quality replacement parts at competitive prices with unsurpassed customer service.

Our Hours Are:

Monday thru Friday
8:00 AM to 4:30 PM (CST)
Voicemail available after hours.

Contact Us At:

(800) 251-4020 Toll Free
(615) 896-5652 Fax
www.flailmaster.com.

FLAIL-MASTER
P.O. Box 1558
Murfreesboro, TN 37133-1558

Return Service Requested

Order Factory Direct: 1-800-251-4020

Fax: (615) 896-5652

Visit Our Website! www.flailmaster.com



Flail Mower Replacement Parts
Heavy-Duty Rotary Cutter Parts
Riding & Walk Behind Mower Blades
Trimmer Line & Mowing Accessories
Blade Sharpening Equipment
Roadside Safety Equipment