

HY-ALERTA

HYDROGEN SPECIFIC LEAK DETECTION

HY-ALERTA™ 500 Handheld Hydrogen Leak Detector



OPERATING MANUAL



Hydrogen is the future, we can sense it!™

28486 Westinghouse Place, Suite 100
Valencia, California 91355, U.S.A.
Tel: (661) 775-9575, Fax: (661) 775-9515
E-mail: sales@h2scan.com
Website: <http://www.h2scan.com>



MISSION STATEMENT

To become the leading provider of hydrogen specific safety monitoring and in-line process measurement systems where hydrogen gas is produced, used, consumed, stored and transported.

We are committed to providing cost-effective solutions as new installations and replacements for existing hydrogen gas analyzers to OEM customers and through our global distribution network.

Our products will achieve worldwide recognition in industrial safety and process applications based on superior products, while maintaining excellent relationships with and ensuring unsurpassed value to our business partners around the globe.

CONTENTS

1. Description	5
2. Specifications	5
3. Operation	7
3.1 Startup	7
3.2 Shutdown	7
3.3 Battery Level	7
3.4 Normal Operation	7
3.5 Hydrogen-Free Areas	10
3.6 Reset Operation	10
3.7 Zero Operation	10
4. Keypad	11
4.1 Numerical Changes	11
4.2 Top Level Keypad Functions	11
4.3 General Keypad Functions (Also See Section 10)	11
4.4 Information Display	11
4.5 Firmware Rev:	11
4.6 Serial Number:	11
4.7 Calibration Date:	12
4.8 Reset Sensor	12
4.9 Zero Sensor	12
4.10 Verify	12
5. Hydrogen Sensing Considerations	13
6. Bump Test	14
7. Verification	14
7.1 Gases	14
7.2 Gas Connection	14
7.3 Verification Kits	14
8. Battery Charging	16
9. Cleaning	16
10. Troubleshooting	16
11. Menu Structure	17
12. Appendix	21
12.1 European Declaration of Conformity	21

IMPORTANT NOTICES



Read and understand this operating manual before installing or using the unit. Only use cables, battery pack, battery charger, and AC/DC power supply from H2scan with this unit.

If this equipment is used in a manner not specified by H2scan, the protection provided by this equipment may be impaired.



Hydrogen is flammable at 4% in air. Take indications seriously and be prepared to take action. In the event of detection of 4% or higher of a hydrogen gas concentration there is a high probability of a hazard to safety. Inform local emergency response personnel immediately.

LIMITATION OF LIABILITY

In the event of a defect in a product, h2scan shall not be responsible for any direct, indirect, incidental or consequential damages resulting therefrom, including, but not limited to, loss of revenue and/or profit.

LIMITED WARRANTY

H2scan Limited Warranty: Each hydrogen instrument ("Product") will conform, as to all substantial operational features, to the Product specifications set forth this Manual and will be free of defects which substantially affect such Product's performance for twelve (12) months from the ship date for such Product.

Must Provide Notice of Defect: If you believe a Product that you believe is defective, you must notify H2scan in writing, within ten (10) days of receipt of such Product, of your claim regarding any such defect.

Return Product to H2scan for Repair, Replacement or Credit. If the Product is found defective by H2scan, H2scan's sole obligation under this warranty is to either (i) repair the Product, (ii) replace the Product, or (iii) issue a credit for the purchase price for such Product, the particular remedy to be determined [by H2scan] on a case-by-case basis.

Voided Warranty. H2scan's 12 Month Limited Warranty is void for any of the following:

The unit is opened and the manufacturing seal is broken

Unauthorized repair work performed at the customer's location or carried out by anyone other than H2scan's factory trained technicians

Equipment or parts that have been tampered with, misused, neglected, mishandled, improperly adjusted, or modified in any way without the written consent of H2scan.

Equipment or parts that have been damaged due to shipping, misuse, accidents, mishandling, neglect, or problems with electrical power sources.

Repair work performed during the warranty period does not prolong the warranty period past the original period.

System operation in incorrect or inappropriate environments.



Usage that is not in accordance with system guidelines or an operator's failure to follow manual instructions.

Limitation of Warranty: THE ABOVE IS A LIMITED WARRANTY AS IT IS THE ONLY WARRANTY MADE BY H2SCAN. H2SCAN MAKES NO OTHER WARRANTY EXPRESS OR IMPLIED AND EXPRESSLY EXCLUDES ALL WARRANTIES OF MERCHANTABILITY AND FITNESS FOR A PARTICULAR PURPOSE. YOUR SOLE REMEDY HEREUNDER IS REPAIR OR REPLACEMENT OF THE PRODUCT OR A CREDIT FOR THE PURCHASE PRICE FOR SUCH PRODUCT, THE PARTICULAR REMEDY TO BE DETERMINED BY H2SCAN ON A CASE-BY-CASE BASIS. H2SCAN SHALL HAVE NO LIABILITY WITH RESPECT TO ITS OBLIGATIONS UNDER THIS AGREEMENT FOR CONSEQUENTIAL, EXEMPLARY, OR INCIDENTAL DAMAGES EVEN IF IT HAS BEEN ADVISED OF THE POSSIBILITY OF SUCH DAMAGES. THE STATED EXPRESS WARRANTY IS IN LIEU OF ALL LIABILITIES OR OBLIGATIONS OF H2SCAN FOR DAMAGES ARISING OUT OF OR IN CONNECTION WITH THE DELIVERY, USE OR PERFORMANCE OF THE PRODUCTS.

1. Description

H2scan believes that protecting lives means being able to locate and find hydrogen leak as quickly as possible. With two sensing elements on the same semiconductor die, the HY-ALERTA™ 500 can detect hydrogen leaks as low as 15 ppm and will not saturate or be destroyed when detecting concentrations of hydrogen up to 100%. The flexible cable allows the sensor probe access to virtually all potential leak sources.

2. Specifications

Sensitivity Range:	0.0015% (15 ppm) to 100% hydrogen by volume in air.
Response Time:	Indication of hydrogen within seconds. Stabilization to final value depends on concentration.
Ambient Temperatures:	Operating: 0°C to +40 °C Storage: -20°C to +45 °C
Relative Humidity:	0-95% non-condensing
Power:	Internal rechargeable Lithium Ion battery yields over 10 hours of operation and is recharged in 4 hours with included charger. Battery charger input: 100-240VAC, 50-60Hz, 0.6A.
Environmental:	Indoor/Outdoor Use Altitude up to 2000 meters Pollution degree 2 environment
Ingress Protection:	IP64 capable
Calibration Period:	Recommended user Verification/Calibration on a 12 month basis.
Weight:	975 g (2.15 lb.) unit and carrying pouch 2.2 kg (5 lb.) shipping weight (unit with accessories)
Product Life Expectancy:	10 years
Certifications:	  US LISTED



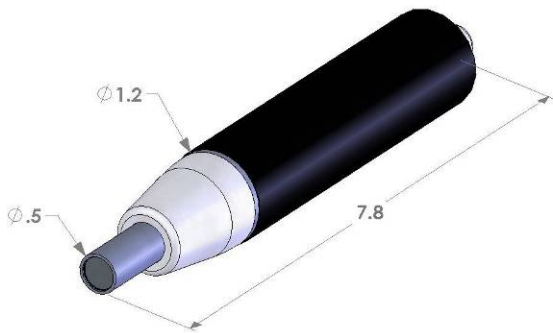

Probe



Controller

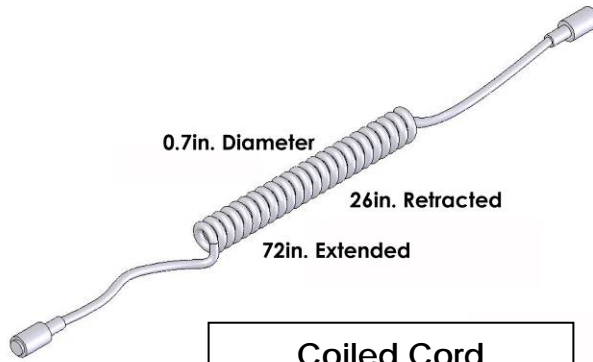

Coiled Cord



Controller Carry Pouch



Battery Charger with Regional Plugs

3. Operation

3.1 Startup

To power-up the HY-ALERTA™ 500, press and hold the **ON/OFF** button until the Controller LCD display indicates an operational message.

Warning: Only power-up the instrument in a hydrogen-free environment.

After power is on, the instrument takes about ten minutes to warm-up. During this time the LCD displays a countdown to completion and the Probe Tip LED is amber. The following operations occur:

The Wide Range Sensor® reaches operating temperature.

A system self-test is run.

Upon successful completion of the above tasks the instrument zeroes itself and automatically switches to normal operation. If an error is detected the instrument will display an error code (see *Section 10*).

3.2 Shutdown

To power-down the HY-ALERTA™ 500, press and hold the ON/OFF button for approximately two seconds until the Controller LCD display turns off.

3.3 Battery Level

After power-on the **BATTERY LED** indicates the current battery level (*times are approximate and may vary as the battery ages*):

Color	Meaning
Green	more than 60 minutes of operation remaining
Amber	approximately 15 to 60 minutes of operation remaining
Red	less than approximately 15 minutes of operation remaining

A fully charged battery should last 10 to 15 hours, depending on use.

There is a small load on the battery when the unit is powered off. This load will discharge the battery of the unit in its powered off state in about 6 months.

Customers that do not use the device frequently should charge the battery and perform a bump test with hydrogen gas every one to three months to keep the battery charged and ready for use.

3.4 Normal Operation

During normal operation the instrument is detecting and reporting the hydrogen concentration near the probe tip sensor. Hydrogen readings are displayed on the controller LCD and the probe tip LED bar graph array. Note that due to the extreme sensitivity of the sensor, it may take several minutes to return to a near zero (less than 0.001%) reading after exposure to hydrogen. If the instrument does not return to an indication of less than 0.001% after 5

minutes in a hydrogen-free environment, then invoke the Reset operation (See *Section 3.6*).

The upper line of the Controller LCD indicates a numerical value or range for the percent hydrogen concentration or peak hydrogen value. The lower line is used to display the hydrogen meter, a logarithmic bar graph ranging from 0.001% (10 ppm) to 100% hydrogen by volume. An open box on the bar indicates the last peak value obtained and filled boxes indicate the current value. The following figure describes how to interpret the hydrogen meter:

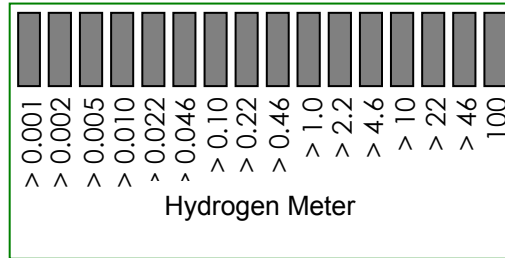

The Probe Tip LED Indicator shows an increase or decrease in hydrogen concentration. Leak detection is accomplished by watching the Probe Tip LED and the bar graph array and moving the sensor around a potential hydrogen leak.

Probe Tip Colors

	Solid Green	- Unit ready
	Pulsing Green	- < 15 ppm hydrogen - Decreasing H2 level
	Solid Amber	- System startup - Steady H2 level
	Pulsing Red	- Increasing H2 level
	Alternating Red, Green	- Fluctuating H2 level

The number of yellow LEDs lit in the Probe LED bar graph array indicates detected hydrogen concentrations in four ranges as noted below:

LED Bar Graph Array

	1 Yellow LED: > 0.01% hydrogen > 100 ppm		3 Yellow LEDs: > 1% hydrogen > 10,000 ppm
	2 Yellow LEDs: > 0.1% hydrogen > 1,000 ppm		4 Yellow LEDs: > 10% hydrogen > 100,000 ppm

3.5 Hydrogen-Free Areas

For the purposes of this document a hydrogen-free area is one with less than 5ppm of hydrogen in the air.

It may be difficult to find a hydrogen-free area in a facility where hydrogen is used. Nearby rooms, or even the entire building, may not be hydrogen free.

To check these areas reset or zero the sensor outside, away from any hydrogen tanks, pipes, or other potential sources. Walk through the facility, watching the sensor. It is surprising how far low levels of hydrogen can spread.

If the sensor is zeroed or reset in hydrogen, there will be a negative offset in the readings that could compromise the sensor's ability to find small leaks.

3.6 Reset Operation

The Reset Operation is used to speed recovery from hydrogen exposure.

It can be invoked from the keypad while in the top menu level (measuring hydrogen) by pressing and holding ◀▶ (left and right arrow buttons simultaneously) or from the Reset Menu (see *Section 4*). Once invoked the user is asked to confirm the operation by pressing the **ENTER** key. Pressing any other key will abort the operation. During Reset the LCD indicates a count down to completion and the Probe tip LED is yellow.

WARNING: The instrument must be in a hydrogen free environment with the LCD indicating less than 0.1% hydrogen before invoking the Reset operation.

3.7 Zero Operation

The Zero Operation is used to zero the hydrogen reading if the instrument is reporting low levels (0.001% to 0.01%) of hydrogen when no hydrogen is present. This operation can be invoked from the keypad while in the top menu level (measuring hydrogen) by pressing and holding ◀ (left arrow button) or from the Reset Menu (see *Section 4*). Once invoked the user is asked to confirm the operation by pressing the **ENTER** key, pressing any other key will abort the operation.

WARNING: The instrument must be in a hydrogen free environment with the LCD indicating less than 0.1% hydrogen before invoking the Zero operation.

4. Keypad

4.1 Numerical Changes

In the following sections when queried to change a numeric value the ▲ (up arrow) and ▼ (down arrow) keys are used to increment/decrement the value based on the selected digit. If the ones digit is selected the value will increment/decrement by one (9 increments to 10, 10 decrements to 9). The ◀ (left arrow) and ▶ (right arrow) keys are used to select another digit. To change a value of 0 to 100 first select the hundreds digit then press the ▲ up arrow. Pressing ◀▶ (the left and right arrows simultaneously) will clear any changes made and restore the previous value. Once the correct value is displayed press the **ENTER** key to save it.

4.2 Top Level Keypad Functions

While in the hydrogen measurement screen, the keypad has these functions:

Key	Function
ENTER	Go to the Information Display menu .
▲	Display the peak hydrogen reading.
▼	Display the current hydrogen concentration.
▶	Clear the peak hydrogen value.
◀	Zero the sensor (see Section 3.7).
◀▶	Reset the sensor (see Section 3.6).

4.3 General Keypad Functions (Also See Section 11)

Key	Navigation	Editing Values	Query Answer
ENTER	Enter submenu	Select Value	Yes
▲	Previous Menu	Increase Value	No
▼	Next Menu	Decrease Value	No
▶	Enter Submenu	Move Cursor Right	No
◀	Exit Submenu (Back)	Move Cursor Left	No
◀▶	Exit Configuration	Undo Changes	No

4.4 Information Display

The Information Display menu allows the user to view useful information about the instrument including firmware revisions, serial number, and calibration date. Enter it by can be entered by pressing and holding the **ENTER** button.

4.5 Firmware Rev:

This displays the sensor pod and controller firmware. The left most number preceded by an 'S' is the Probe firmware revision. The right most number preceded by a 'C' is the Controller firmware revision. For example: *S1.23 C2.34* for Probe firmware version 1.23 and Controller firmware version 2.34

4.6 Serial Number:

This displays the product serial number. For example: *50123*

4.7 Calibration Date:

This displays the date of last factory calibration, MM/DD/YY. For example:
5/8/06 for 8 May 2006.

4.8 Reset Sensor

The Reset Sensor menu is used to invoke the Reset Operation as described in *Section 3.6*.

4.9 Zero Sensor

The Zero Sensor menu is used to invoke the Zero Operation as described in *Section 3.7*.

4.10 Verify

The Verify menu shows the date of the last field verify and allows the user to invoke the Verify function in *Section 6*.

5. Hydrogen Sensing Considerations

From any given source, hydrogen gas disperses rapidly and generally upward due to its very low density compared to air. Understanding this behavior allows a more effective search for hydrogen leaks.

The hydrogen plume from a leak generally spreads in a roughly conical shape that is easily disturbed by environmental conditions. Certain conditions such as pressure, temperature, and leak size may act together to change the shape of the hydrogen plume from a cone to a laser-like beam. This makes finding a leak more difficult.

If the sensor element is near (and above) the leak, the concentration will likely be higher but the leak may be difficult to locate. As hydrogen dissipates the concentration decreases. Generally, greater distances will increase the chance of intercepting the leak stream, but if the sensor is too far away, the response may be too weak to detect.

When drafts or air currents are present, hydrogen will tend to be dispersed. Testing for hydrogen leaks downwind of the leak area may increase the chance of detecting the leak.

If hydrogen is rising in an enclosed building the hot air near the ceiling may slow the hydrogen's rise. Thus, sensing hydrogen near ceiling areas with high temperatures present may not be as effective as at a lower level.

Low temperatures can also affect the behavior of hydrogen. Hydrogen stored in a liquid state is at an extremely low temperature. The low temperature of any escaping hydrogen will be of a higher than normal density and may initially move downward. As the hydrogen warms, it will begin to rise upward. When checking for a leak in areas where liquid hydrogen is stored, check both above and below the area of concern.

6. Bump Test

A bump test is recommended every three months. The purpose of a bump test is to verify that the sensor is active, detecting hydrogen and verifying that the sensor is within the pre-set factory tolerance for accuracy. To perform a bump test perform the following:

In a non-hydrogen environment, power on the instrument. Once the instrument has gone through its standard 10 minute warm-up, use the calibration cup that accompanies the HY-ALERTA™ Model 500, and apply 2% hydrogen to the probe sensor. Let the 2% hydrogen flow for a minimum of 3-5 minutes. After 3-5 minutes the concentration value registered on the LCD display should read between 1.6% to 2.4%, which is within factory tolerance. If the 2% reading is below 1.6% or above 2.4% the instrument should go through a Verification test as outlined below.

7. Verification

Verification is performed in a non-hydrogen environment to confirm that the HY-ALERTA™ Model 500 is operating properly and within the pre-set factory tolerance for calibration. The recommended verification interval is every 12 months, or after a 2% bump test has been performed and the indicated values on the LCD display were outside the stated tolerance as outlined in Section 6. If the verification fails, then it should be repeated one more time.

The HY-ALERTA Model 500 requires calibration only if it fails the second verification. It cannot be field calibrated and must be returned to h2Scan for calibration service. An optional NIST traceable certificate is available upon request.

7.1 Gases

Verification requires the availability of the following certified gases:

2.00% hydrogen by volume in air (20,000 ppm)

0.10% hydrogen by volume in air (1000 ppm)

Zero grade, hydrogen-free air. Ambient air can be substituted if it is hydrogen-free.

7.2 Gas Connection

Gases are applied to the unit through the use of the Calibration Cup Assy. (P/N 50000009) available from H2Scan.

7.3 Verification Kits

Customer-specific Field Verification Kits for the HY-ALERTA™ 500 are available from H2scan.

The field verification function allows the user to check the instrument's calibration. Details on this function can be found in Table 1 on page 19.

If the unit passes verification, calibration is not required at this time.

If the unit fails verification, the unit should be returned to the factory for calibration.

8. Battery Charging

Ensure the unit is powered OFF.

Disconnect the coiled cord from the controller.

Connect the battery charger to the controller.

Using the appropriate A/C plug adapter for the region of use, plug the battery charger into the A/C supply.

The battery charger indicator light will illuminate according to charge status as follows:

Off	No Battery
Flashing Green	Fast charging
Steady Green	Fully charged
Steady Amber	Standby
Flashing Red	Error

NOTE: Complete charging may take up to 4 hours for a fully discharged battery.

9. Cleaning

If the unit becomes soiled, clean the unit with a lint-free cloth. Use special care when cleaning the handheld probe assembly. Small debris or other material may collect over the sensor tip. Clean the tip with a gentle wiping with a clean, damp, lint-free cloth or paper. Do not use chemicals or soap.

10. Troubleshooting

Symptom	Possible Cause	Action
Sensor Error	The probe is disconnected from the controller.	Turn off the instrument and verify that the probe is properly connected to the controller.
Error 88	Faulty capacitor	Turn off the instrument.
Error 40	The PCB temperature is too high.	Turn off the instrument. Let it cool.
Error 20	The sensor temperature is incorrect.	Turn off the instrument.
Battery LED is red	The battery is very low.	Charge the battery completely. See Section 8.
Unit won't turn on	The battery is dead.	Charge the battery completely. See Section 8.
If the recommended action does not solve the problem, the HY-ALERTA 500 should be returned to the factory for repair.		

11. Menu Structure

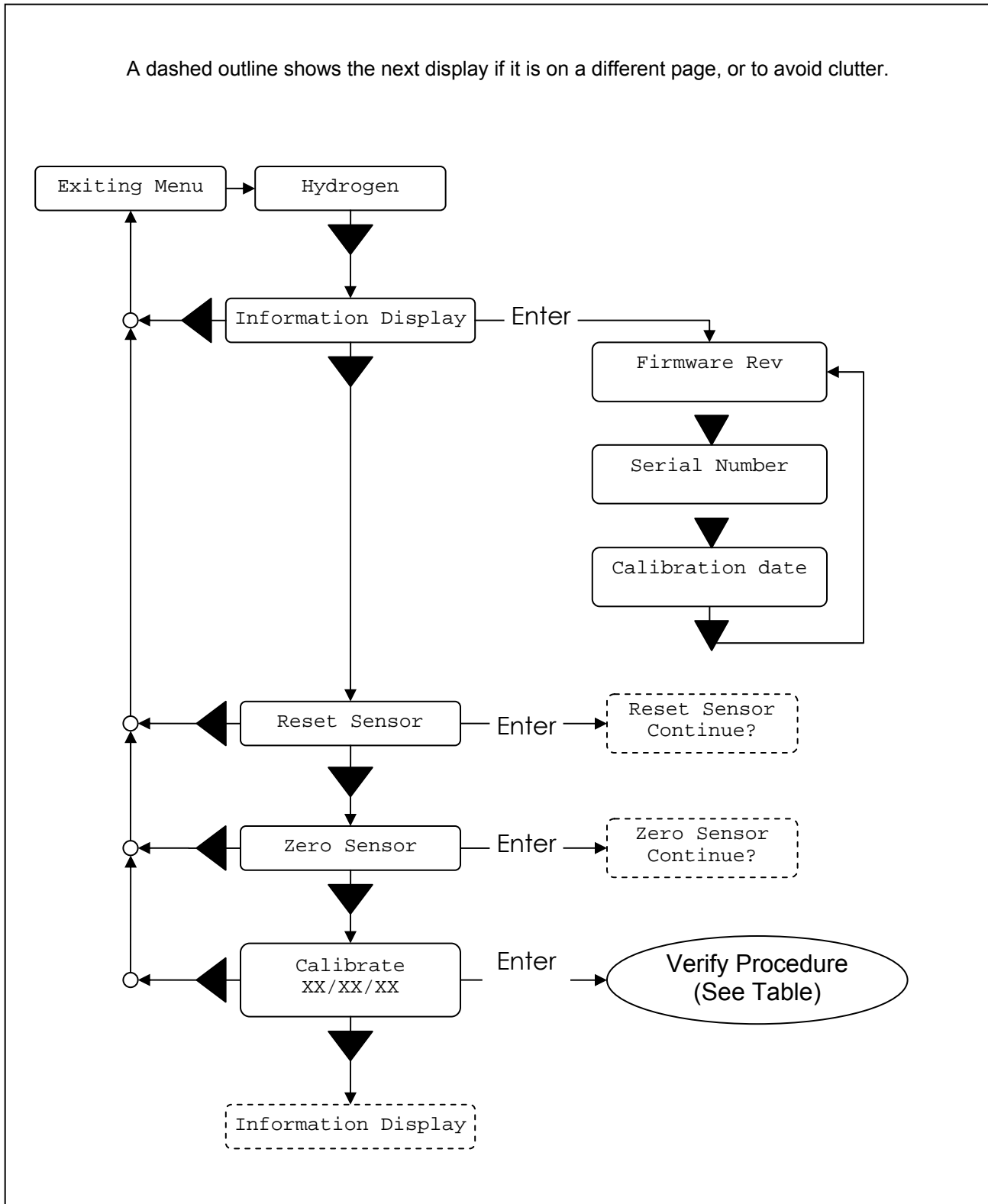

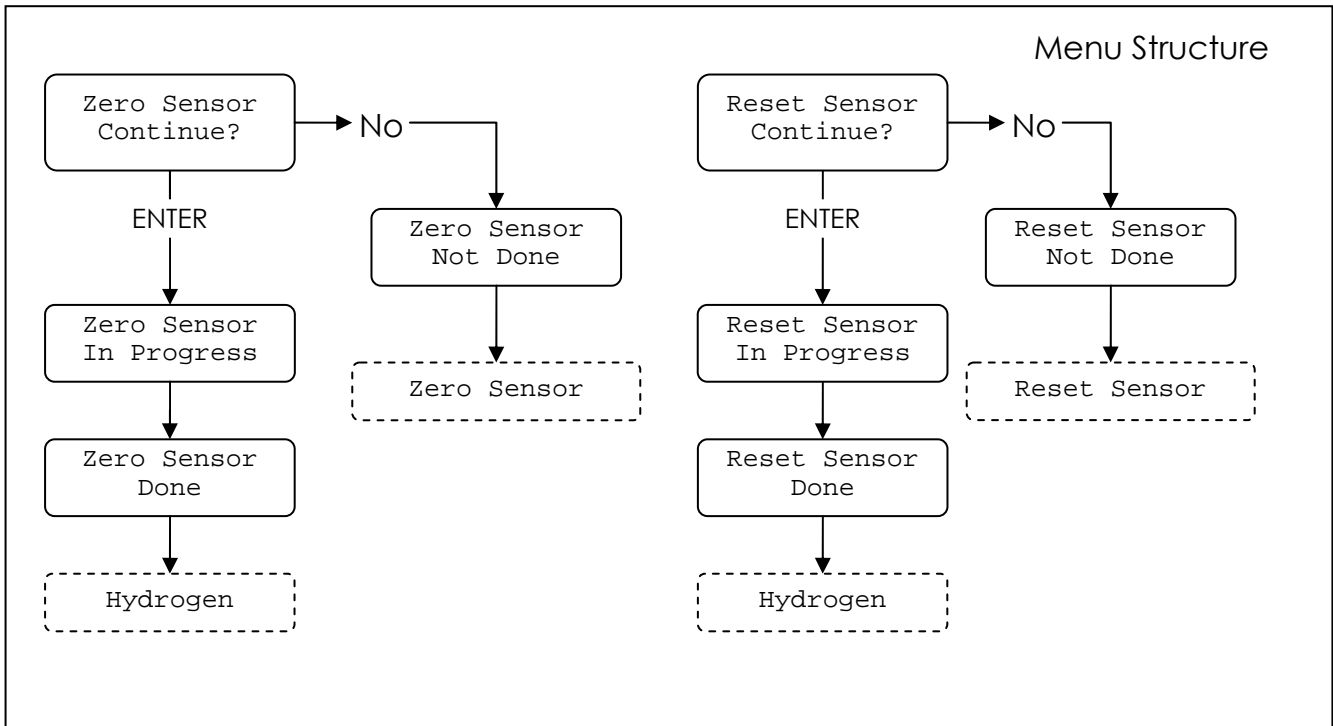

Table 1 - Verify Procedure

Step	Display	User response
1	Verify Sensor	Press ENTER
2	Verify Sensor Continue?	Press ENTER to Verify sensor, L to exit.
3	Verify Sensor In Progress	Verify Test begins.
4	Apply 0.000%H2 Continue?	With the Calibration Cup that accompanies the HY-ALERTA™ 500, apply hydrogen-free, zero air to the Probe sensor. The Probe Tip LED will remain Green. Press ENTER .
5	Apply 0.000%H2 In Progress	0% Verify Test starts.
6	Apply 0.000%H2 Settle	Checking sensor temperature.
7	Apply 0.000%H2 Wait xxxx	Wait for sensor reading to stabilize until xxxx = 0 .
8	Apply 0.000%H2 Finding Average	Measuring sensor response to test gas.
9	Apply 0.100%H2 Continue?	With the Calibration Cup, apply 0.1% hydrogen to the Probe sensor. The Probe Tip LED will change from Green to Red. One (or two) yellow LEDs in the LED Bar Graph Array will turn on. Press ENTER .
10	Apply 0.100%H2 In Progress	0.1% Verify Test starts.
11	Apply 0.100%H2 Settle	Checking sensor temperature.
12	Apply 0.100%H2 Wait xxxx	Wait for sensor reading to stabilize until xxxx = 0 .
13	Apply 0.100%H2 Finding Average	Measuring sensor response to test gas. Visually verify that 1-2 yellow LED's are lit up in the probe tip. If not the unit needs factory calibration
14	Apply 2.000%H2 Continue?	With the Calibration Cup, apply 2.0% hydrogen to the Probe sensor. The Probe Tip LED will remain Red. Three yellow LEDs in the LED Bar Graph Array will turn on. Press ENTER .
15	Apply 2.000%H2 In Progress	2.0% Verify Test starts.

16	Apply 2.000%H2 Settle	Checking sensor temperature.
17	Apply 2.000%H2 Wait xxxx	Wait for sensor reading to stabilize until xxxx = 0.
18	Apply 2.000%H2 Finding Average	Measuring sensor response to test gas.
19	Enter Date: 1.0000 M	Enter the current month (1-12) using the ▲ (up arrow) and ▼ (down arrow) keys.
20	Enter Date: 1.0000 D	Enter the current day (1-31) using the ▲ (up arrow) and ▼ (down arrow) keys.
21	Enter Date: 6.0000 Y	Enter the current year (7=2007, 12=2012, etc.) using the ▲ (up arrow) and ▼ (down arrow) keys.
22	Verify Sensor Passed	Verify is complete, press any key.

12. Appendix

12.1 European Declaration of Conformity

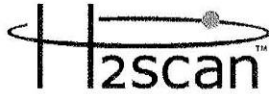
***European Declaration of Conformity*****Application of Council Directive: 2004/108/EC**

**Standards to Which
Conformity is Declared:** EN61326:1998
EN55011 Class B Group I
EN61000-4-2
EN61000-4-3

Standards comply with
requirements of the
European Directives.

Manufacturer's Name: H2scan Corporation

Manufacturer's Address: 28486 Westinghouse Place, Suite 100
Valencia, CA 91355
(661) 775 - 9575

Equipment Description: Handheld Hydrogen Leak Detector

Equipment Class: Laboratory, Measurement, and Process
Control Equipment: Portable Environment

Model Number: 500

The tests were carried out by the test laboratories of DNB Engineering and/or in accredited testing laboratories. Test reports may be inspected on demand.

We, the undersigned, hereby declare that the equipment specified above conforms to the above Directive(s) and Standard(s).

Date of Issue: 31 May, 2007
Place of Issue: Valencia, CA

Signature: 
Full Name: Dennis Wayne Reid
Position: Chief Executive Officer

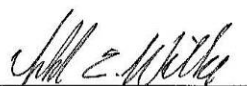
Signature: 
Full Name: Todd E. Wilke
Position: Chief Technical Officer

Annexes are part of this declaration. This declaration certifies conformance with the above mentioned Directives.
Affirmation of attributes in a legal sense is not included. Security declarations given in the product documentation have to be considered.

28486 Westinghouse Place, Ste. 100, Valencia, CA 91355
Tel: 1-661-775-9575, Fax: 1-661-775-9515