INSTRUCTION MANUAL

EPOCH 4

Part No. 910-220D

2/22/04

 **PANAMETRICS-NDT™**

A Business of R/D Tech Instruments Inc.

Copyright © 2000 - 2004 by R/D Tech, Inc.
All rights reserved.

No part of this manual may be reproduced or transmitted in any form or by any means, electronic or mechanical, including photocopying, recording, or by any information storage and retrieval system, without the written permission of Panametrics-NDT™, except where permitted by law. For information, contact: info@panametrics-NDT.com.

Other product names mentioned in this document may be trademarks of their respective companies, and are mentioned for identification purposes only.

Printed in the United States of America

Warranty

The EPOCH 4 Digital Ultrasonic Flaw Detector has been designed and manufactured as a high quality instrument.

Damage in transit - Inspect the unit thoroughly upon receipt for evidence of external or internal damage that may have occurred during shipment. Notify the carrier making the delivery immediately of any damage, since the carrier is normally liable for damage in shipment. Preserve packing materials, waybills, and other shipping documentation in order to establish damage claims. After notifying the carrier, contact Panametrics-NDT so that we may assist in the damage claims, and provide replacement equipment, if necessary. Your shipping container is re-usable and may be used in the future when returning the unit for recalibration or repair.

Panametrics-NDT guarantees the EPOCH 4 to be free from defects in materials and workmanship for a period of one year (twelve months) from date of shipment. This warranty only covers equipment that has been used in a proper manner as described in this instruction manual and has not been subjected to excessive abuse, attempted unauthorized repair, or modification. DURING THIS WARRANTY PERIOD, PANAMETRICS-NDT LIABILITY IS STRICTLY LIMITED TO REPAIR OR REPLACEMENT OF A DEFECTIVE UNIT AT ITS OPTION. Panametrics-NDT does not warrant the EPOCH 4 to be suitable of intended use, or fitness for any particular application or purpose. Panametrics-NDT accepts no liability for consequential or incidental damages including damage to property and/or personal injury. In addition to our standard one year warranty, Panametrics-NDT also offers an optional two year warranty (call for further details).

This warranty does **not** include transducers, transducer cables, or battery. The customer will pay shipping expense to the Panametrics-NDT plant for warranty repair; Panametrics-NDT will pay for the return of the repaired equipment. (For instruments not under warranty, the customer will pay shipping expenses both ways.)

In this manual, we have attempted to teach the proper operation of the EPOCH 4 consistent with accepted flaw detection techniques. We believe the procedures and examples given are accurate. However, the information contained herein is intended solely as a teaching aid and should not be used in any particular application without independent testing and/or verification by the operator or the supervisor. Such independent verification of procedures become more important as the criticality of the application increases.

For these reasons, we make no warranty, expressed or implied, that the techniques, examples, or procedures described herein are consistent with industry standards nor that they will meet the requirements of any particular application. Panametrics-NDT expressly disclaims all implied warranties of merchantability and of fitness for any particular application.

Panametrics-NDT reserves the right to modify all products without incurring the responsibility for modifying previously manufactured products. Panametrics-NDT does not assume any liability for the results of particular installations, as these circumstances are not within our control.

THE WARRANTIES SET FORTH HEREIN ARE EXCLUSIVE AND ARE IN LIEU OF ALL OTHER WARRANTIES WHETHER STATUTORY, EXPRESS OR IMPLIED (INCLUDING WARRANTIES OF MERCHANTABILITY AND FITNESS

FOR A PARTICULAR PURPOSE, AND WARRANTIES ARISING FROM COURSE
OF DEALING OR USAGE OR TRADE.)

Table of Contents

Warranty	3
Table of Contents	5
List of Tables	11
List of Figures	13
1 Preface	15
1.1 Product Description	15
1.2 About this Document	16
1.3 Audience	16
1.4 Typographic Conventions	17
1.5 Related Documentation	18
1.6 If You have Documentation Comments	18
1.7 Revision History	18
1.8 Technical Help	18
2 Operating the Power Supply	19
2.1 Using AC Line Power	19
2.2 Using Battery Power	19
2.3 Operating Time for the Battery	20
2.4 Replacing the Battery	20
2.5 Charging the Battery	20
2.5.1 Using a Proper Cycling Charge	21
2.6 Using a “AA” Alkaline Battery	21
3 Managing Basic Operations	23
3.1 Powering-up	23
3.1.1 ELD and LCD Screen Adjustment	23
3.2 Using the Keypad	24
3.2.1 Enter Key	24
3.2.2 Direct Access Operation	24
3.3 Summarizing Keypad Functions	25
3.3.1 Main Keypad Functions	26
3.3.2 Datalogger Keypad Functions	29
3.4 Editable Parameters Software	31
3.4.1 Activating Editable Parameters	32
3.5 Managing the Display	34
3.5.1 Full Screen A-Scan Display	34
3.5.2 Split Screen Display	35

3.5.3	Display Flags and Markers.	36
3.6	Setting-up Parameters.	37
3.6.1	Language Selection.	37
3.6.2	Units of Measurement	38
3.6.3	Analog Out.	38
3.6.4	Clock	38
3.6.5	Advanced User.	39
3.6.6	RS232 Setup.	41
3.6.7	VGA Output On/Off	42
3.6.8	Beep On	42
3.6.9	Grid On/Off	42
3.6.10	Keypad Lock Functions	43
3.6.11	Filled Live	43
3.6.12	Filled Peak	43
3.6.13	“AA” Alkaline Battery Selection.	43
4	Adjusting the Pulser Receiver	45
4.1	Adjusting System Sensitivity	45
4.2	Using AUTO-80%.	45
4.3	Setting a Gain Reference Level and Adding Scanning Gain	47
4.4	Using the Pulser Key	48
4.4.1	Waveform Rectification.	48
4.4.2	Pulser Energy	49
4.4.3	Damping.	49
4.4.4	Test Mode.	50
4.4.5	Narrowband Filters.	50
4.4.6	Pulser Type Selection.	52
4.4.7	Pulser Frequency Selection	52
5	Managing Special Waveform Functions	55
5.1	Reject	55
5.2	Peak Memory	55
5.3	Peak Hold.	56
5.4	Screen Freeze	56
6	Using the Gates	59
6.1	Positioning Gate 1	59
6.2	Positioning Gate 2	59
6.3	Taking Thickness Readings	60
6.4	Taking Echo-to-Echo Thickness Readings	61
6.5	Locating Flaws with an Angle Beam Transducer	62
6.6	Measuring Signal Amplitude	63
6.7	Operating Time-of-Flight (TOF) Mode	64

6.8	Using the Zoom Feature	65
6.9	Activating Gate Alarms	66
6.9.1	Threshold Alarms	66
6.9.2	Minimum Depth Alarm	67
6.9.3	Minimum Depth Alarm with a Single Gate	67
6.9.4	Minimum Depth Alarm in the Echo-to-Echo Measurement Mode	68
6.9.5	Alarm Condition Storage	68
7	Calibrating the EPOCH 4	69
7.1	Getting Started	69
7.2	Calibrating with a Straight Beam Transducer	70
7.3	Calibrating with a Delay Line Transducer	73
7.4	Calibrating with a Dual Element Transducer	75
7.5	Calibrating with an Angle Beam Transducer	78
7.5.1	Locating the Beam Index Point (B.I.P.)	79
7.5.2	Verifying the Refracted Angle (Beta)	80
7.5.3	Calibrating for Distance	81
7.5.4	Calibrating for Sensitivity	83
8	Managing the Datalogger and Data Communication Features	85
8.1	Defining the Datalogger Storage Capacity	85
8.2	Using the Memory Screen	86
8.3	Using the Alphanumeric Keypad	87
8.4	Creating Files and Identifier (ID) Codes	88
8.5	Saving Waveforms and Thickness Readings	89
8.6	Incrementing ID Codes	90
8.7	Recalling Transducer Calibrations and Waveforms	90
8.8	Saving and Recalling Quick Recall Calibrations	92
8.9	Creating Memos	92
8.10	Editing a File	93
8.11	Printing	95
9	Using Software Options	97
9.1	Defining Active/Inactive Options	97
9.2	Distance Amplitude Correction (DAC)	98
9.2.1	Drawing DAC Curves	98
9.2.2	Special Considerations for JIS Z3060 DAC Curves	100
9.2.3	Saving and Recalling DAC Curves	101
9.2.4	Setting Alarms in DAC Mode	101
9.2.5	Exiting DAC Mode	101
9.3	Time Varied Gain (TVG)	101
9.3.1	Activating and Calibrating TVG	102
9.3.2	Saving and Recalling TVG Setups	103
9.3.3	Exiting TVG Mode	103

9.4	Pulse Repetition Frequency (PRF)	104
9.4.1	Activating Low PRF or High PRF Mode.	104
9.4.2	Exiting Low PRF or High PRF Mode	104
9.5	B-Scan	105
9.5.1	Choosing an Encoder and Accessories	105
9.5.2	Getting Started	106
9.5.3	Performing A-Scan Calibration and Setup.	106
9.5.4	Selecting a B-Scan Mode.	106
	9.5.4.1Setting Up the Bi-Directional Mode	107
	9.5.4.2Setting Up the Uni-Directional Mode	108
	9.5.4.3Setting Up the Manual Mode	109
9.5.5	Using the Scan Setup Menu	110
	9.5.5.1Entering the Start Coordinate	111
	9.5.5.2Operating the Save A-Scan Function	111
9.5.6	Operating the B-Scan Software	112
9.5.7	Reviewing Depth and Distance Traveled Information.	114
9.5.8	Operating Minimum Depth Alarm.	114
9.5.9	Operating Scan Speed Alarm.	115
9.5.10	Operating Floating Gate and B-Scan	115
9.5.11	Operating Echo-to-Echo Detection	116
9.5.12	Saving B-Scan Data	117
9.5.13	Viewing and Recalling Stored B-Scans	117
9.6	Spotweld.	117
9.6.1	Activating Spotweld Mode	118
9.6.2	Defining Switchable Overlays	118
9.6.3	Accessing Datalogger Storage	119
9.7	Interface Gate	120
9.7.1	Activating the Interface Gate	120
9.7.2	Operating in Standard Mode	121
9.7.3	Operating in Echo-to-Echo Mode	121
9.7.4	Managing Gate Positioning and Alarms	121
9.7.5	Defining Gate Commands	122
9.8	Floating Gate	124
9.8.1	Activating Floating Gate	124
9.8.2	Operating in -6dB Mode	125
9.8.3	Operating in -12db Mode.	125
9.8.4	Using Gate Alarms.	126
9.9	Expanded Memory	126
9.10	Curved Surface Correction.	127
9.11	Wave Analysis	127
	9.11.1 Activating the Wave Analysis Software:	128
	9.11.2 Moving the Cursors	129
9.12	DGS	130
9.13	AWS.	130

9.13.1	AWS D1.1 and the EPOCH 4	130
9.13.2	Operating the AWS D1.1 Software	131
9.13.3	Adding Scanning Gain	132
9.13.4	Calculating A and C Values	132
9.14	Auto-Freeze	133
Appendix A – Specifications		137
Appendix B – Sound Velocities		141
Appendix C – Glossary		143
Appendix D – Cable Diagrams		151
Appendix E – Parts List		155
Index		159
Documentation Comments		163

List of Tables

Table 1	Typographic Conventions	17
Table 2	Revision History	18
Table 3	Main Keypad Functions	26
Table 4	Datalogger Keypad Functions	29
Table 5	Datalogger Alphanumeric Keypad Functions	31
Table 6	Menu Symbol Descriptions	37
Table 7	Active/Inactive Software Options	98
Table 8	Spotweld Overlays	118
Table 9	Sound Velocities of Various Materials (Longitudinal Wave Velocity).	141
Table 10	EPOCH 4 Ultrasonic Flaw Detector	155
Table 11	Items Included with the EPOCH 4 (Spares can be purchased)	155
Table 12	Instrument Software Options	155
Table 13	PC Interface Program and Accessories	156
Table 14	Optional Hardware Accessories	156

List of Figures

Figure 1	English Keypad	25
Figure 2	International Keypad	26
Figure 3	Selecting the Editable Parameters Option	32
Figure 4	Viewing the Editable Parameters Screen	32
Figure 5	Editing the Gain Parameter	33
Figure 6	Viewing New Preset Values.	33
Figure 7	Full Screen Display	34
Figure 8	Split Screen Display	35
Figure 9	Menu Options	37
Figure 10	Discovering a Flaw during an Angle Beam Inspection	40
Figure 11	Displaying the Flaw Location	40
Figure 12	Before Activating AUTO-80%	46
Figure 13	After Activating AUTO-80%	46
Figure 14	Set-up for Peak-to-Peak Measurement.	62
Figure 15	Angle Beam Inspection	62
Figure 16	Amplitude Mode Displaying Current Amp and Amp Max	64
Figure 17	Time-of-Flight Mode Displaying μ s Values	65
Figure 18	Negative Logic Alarm	66
Figure 19	Positive Logic Alarm	67
Figure 20	Calibrating for a Thin Block Using a Straight Beam Transducer	71
Figure 21	Entering a Thin Standard Value	71
Figure 22	Calibrating for a Thick Block Using a Straight Beam Transducer	72
Figure 23	Entering a Thick Standard Value	72
Figure 24	Calibrating for a Thin Block Using a Delay Line Transducer	74
Figure 25	Entering a Thin Standard Value	74
Figure 26	Calibrating for a Thick Block Using a Delay Line Transducer	75
Figure 27	Entering a Thick Standard Value	75
Figure 28	Calibrating for a Thin Block Using a Dual Element Transducer	77
Figure 29	Entering a Thin Standard Value	77
Figure 30	Calibrating for a Thick Block Using a Dual Element Transducer	78
Figure 31	Entering a Thick Standard Value	78
Figure 32	Reference Block Displaying the “0” Mark.	79
Figure 33	Locating the Beam Index Point	80
Figure 34	Verifying the Refracted Angle	81
Figure 35	Calibrating for Distance	82
Figure 36	Entering a Thin Standard Value	82
Figure 37	Adjusting the Gain	83
Figure 38	Entering a Thick Standard Value	83
Figure 39	IIW Calibration Block with 0.060" Diameter Drilled Hole	84
Figure 40	Locking the Reference Gain to Add/Subtract Scanning Gain	84
Figure 41	Memory Screen (no stored files)	87
Figure 42	Entering File Information.	88

Figure 43	Recalling a Selection	91
Figure 44	Editing the File Directory	93
Figure 45	Editing the File Contents	95
Figure 46	Creating a DAC Curve	99
Figure 47	TVG Example	103
Figure 48	Selecting B-Scan from the Options Menu	107
Figure 49	Selecting the Bi-Directional Encoder Pulses Option	107
Figure 50	Selecting the Uni-Directional Encoder Pulses Option	109
Figure 51	Selecting the Manual Update Rate Option	110
Figure 52	Setting Up Scan Parameters	111
Figure 53	Setting Number of A-Scans to Save	112
Figure 54	Viewing the Selected Mode	113
Figure 55	Viewing a Manual B-Scan	114
Figure 56	Viewing a Split A-Scan / B-Scan	115
Figure 57	Activating/Deactivating the Floating Gate	116
Figure 58	Active Floating Gate with Two Gates	116
Figure 59	Selecting Parameters from the Interface Gate Menu	121
Figure 60	Gate Appearances	122
Figure 61	Setup Mode	123
Figure 62	Run Mode	123
Figure 63	Selecting -6dB from the Floating Gate Menu	124
Figure 64	Gate 1 Floating at -6dB/Gate 2 Floating at -12dB	125
Figure 65	Example of -6dB Mode	125
Figure 66	Example of -12dB Mode	126
Figure 67	Selecting Wave Analysis from the Options Menu	128
Figure 68	Viewing Changes on Display when Wave Analysis is Active	129
Figure 69	AWS D1.1 Software Option Activated in the Options Menu	131
Figure 70	Pressing [F1] to Store the REF B Value	132
Figure 71	Displaying the D Value	133
Figure 72	Selecting Auto-Freeze from the Options Menu	134
Figure 73	Selecting either Hold Mode or Time Mode	135
Figure 74	Snowflake Icon Identifies Auto-Freeze is Active	135
Figure 75	RS232 Serial Cable / Panametrics-NDT Part# EP4/C-9FAT-6	151
Figure 76	RS232 Serial Cable Wire Run List	151
Figure 77	Parallel Port Cable / Panametrics-NDT Part# EP4/C-25PRL-6	152
Figure 78	Parallel Port Cable Wire Run List	152
Figure 79	VGA Adapter Cable / Panametrics-NDT Part# EP4/C-15VGA-6	153
Figure 80	VGA Adapter Cable Wire Run List	153
Figure 81	Printer Cable (for DPU-414 Portable Serial Printer) / Panametrics-NDT Part# EP4/PR-Cable	154
Figure 82	Printer Cable (for DPU-414 Portable Serial Printer) Wire Run List	154

1 Preface

The preface provides the following introductory topics:

- Product Description
- About this Document
- Audience
- Typographic Conventions
- Related Documentation
- If You have Documentation Comments
- Revision History
- Technical Help

1.1 Product Description

Utilizing the latest advances in technology, Panametrics-NDT has developed what can be considered an ideal Ultrasonic Flaw Detector, the fourth generation, EPOCH 4.

Improvements in microprocessors, displays, batteries, and components have enabled Panametrics-NDT to develop a lightweight, fast, powerful instrument with ultrasonic performance, resolution, and documentation capabilities.

Two types of displays are available on the EPOCH 4. The Electroluminescent Display (ELD) is a high resolution, ultra bright, fast display with adjustable brightness settings. The Liquid Crystal Display (LCD) is extremely crisp, offering superior outdoor visibility with extended battery operating time. The new electronics drive the displays at rates faster than the human eye can perceive and bright enough to view under the worst lighting conditions and most extreme environments.

Improvements over previous models include:

- A higher bandwidth, combined with the addition of narrowband filters, increased PRF rates up to 1kHz and the option to select a tunable square wave pulser or spike pulser. The EPOCH 4 also has an automatic transducer calibration function to determine material velocity and zero offset and expanded datalogging with editing capabilities. The EPOCH 4 includes a VGA output for large screen viewing, comfortable ergonomic design, and an improved and more intuitive user interface.
- The light weight of the EPOCH 4 (5.7 lbs./2.6 Kg.) makes it an ideal choice for field inspectors with demanding applications. The compact Nickel Metal Hydride battery pack provides 7 hours of continuous use with the ELD and up to 10 hours with the LCD under any normal testing modes and requires recharge times of less than 3 hours.
- The ELD and LCD screens provide the inspector with all necessary test data in a clear, logically organized format. The instrument's gain and range settings and current measurement mode are constantly displayed at the top of the screen. A large numeric display provides an instantaneous readout of material thickness, soundpath, amplitude, or time of flight. When using an angle beam transducer, the EPOCH 4 will

provide the soundpath, surface distance, and depth to a flaw, plus display which leg of the soundpath the reflector is in with a leg indicator.

- The documentation capability of the EPOCH 4 has been greatly improved. Capable of storing as many as 500 waveforms (expandable up to 2,000) or 10,000 thickness readings (expandable up to 40,000), the alphanumeric datalogger allows the most extensive data collection capabilities available on the market today. Calibration and test data can be labelled with an eight character file name, three digit extension, and 16 character ID for each individual piece of data. In addition, a unique editing feature allows IDs to be deleted or cleared for future use. A handy memo feature allows unlimited comment and data description entries. A memory display screen makes it possible to review the contents of any file by scrolling through the actual data prior to deleting or recalling the information. Finally, any stored data can be sent directly from the EPOCH 4 to a printer to create an on-site, mini-report or uploaded to the optional PC Interface Program. The Interface Program runs in a standard Internet browser and makes it easy to save, view, send, or move data from application to application. The browser format makes it easier than ever to utilize the power of the Internet to share data and send reports.

These are a few of the EPOCH 4's many features. This manual is written in a functional format. The information contained within can read in modular format to answer questions about how to perform specific functions. We suggest reading through the information completely at least once with your EPOCH 4 in hand so that you can combine reading the descriptions and examples with actual use of the instrument.

1.2 About this Document

This document is the *Instruction Manual* for the EPOCH 4. The *Instruction Manual* describes routine tasks for operating the EPOCH 4. These tasks include operating the power supply, managing basic operations, adjusting the pulser receiver, managing special waveform functions, using the gates, calibrating the EPOCH 4, managing the datalogger and data communication features, and using software options.

1.3 Audience

This document is intended for any operator using the EPOCH 4. Panametrics-NDT recommends that all operators have a thorough understanding of the principles and limitations of ultrasonic testing. We assume no responsibility for incorrect operational procedure or interpretation of test results. We recommend that any operator seek adequate training prior to using this equipment. Panametrics-NDT offers a full range of training courses including Level I and Level II Ultrasonic Testing, Advanced Detection and Sizing, and Ultrasonic Thickness Gaging. For further information regarding training courses, contact Panametrics-NDT.

While the EPOCH 4 is a continuously self-calibrating instrument, it is up to the customer to determine regulatory requirements. Panametrics-NDT offers calibration and documentation services. Contact Panametrics-NDT or your local representative with any special requests.

1.4 Typographic Conventions

The following notes and table provide a list of the typographic conventions that appear in this document.



Warning: This information indicates danger and the possibility of personal injury.



Caution: This information indicates that equipment damage can occur.

Note: This information provides explanatory information.

Tip: This information provides helpful guidelines for easy operation.

Convention	Description
Courier Font	Used for file names, lines of code, names of processes, and commands.
Heavy courier	Used for command line user input.
Bold	Used for textual parts of graphical user interface, including menu items, buttons, toolbar names, modes, options, and tabs.
<i>Italics</i>	Used for screen/window names, dialog boxes and document titles.
<i>Bold Italics</i>	Used for emphasis.
[Bold] (Square Brackets with Bold)	Used for instrument keys on the keypad.
< <i>Italics</i> > (Angle Brackets)	With italics text, used for variable data.
→	Used for showing the next sequential step.

Table 1 Typographic Conventions

1.5 Related Documentation

The EPOCH 4 works with the optional EPOCH 4 Interface Program. For more information about this software program, refer to the following instruction manuals:

- EPOCH 4 Interface Program, Part Number 910-224

1.6 If You have Documentation Comments

Panametrics-NDT is always interested in improving its documentation. We value your comments about this manual and other Panametrics-NDT documentation.

Simply fill out the survey at the back of this manual and send your documentation comments to Panametrics-NDT by using one of the following methods:

- Send comments to Panametrics-NDT, Attention: Technical Publications
- Contact us at info@panametrics-NDT.com.

In all your correspondence, please include the title of the document, its part number, release date, and the specific section upon which you are commenting.

1.7 Revision History

This document may require updating because of corrections or changes to the product. Publication dates, printed on the front cover, are updated when a change is made to this document. In addition, the document number is also changed to reflect the revision.

The table below shows a list of all revisions for this document.

Date	Issue	Release version
May 2001	910-220A	First release.
September 2001	910-220B	Second release.
August 2002	910-220C	Third release.
April 2003	910-220D	Fourth release.
February 2004	910-220D	Update.

Table 2 Revision History

1.8 Technical Help

Call Panametrics-NDT and ask for a sales engineer to assist you.

2 Operating the Power Supply

This chapter describes how to operate the EPOCH 4 using different power supply options.

Topics are as follows:

- Using AC Line Power
- Using Battery Power
- Operating Time for the Battery
- Replacing the Battery
- Charging the Battery
- Using a “AA” Alkaline Battery

2.1 Using AC Line Power

AC line power is supplied via the Charger/Adapter (part number EP4-MCA). The EP4-MCA has a universal AC POWER input, so it operates with any line voltage from 100-120 or 200-240 Volts AC, and with 50 to 60Hz line frequency.

To use AC line power, follow these steps:

1. Connect the power cord to the Charger/Adapter unit and to an appropriate line power source.
2. Connect the DC Output power cable from the Charger/Adapter unit to the Charger/AC Adapter input jack on the right side of the EPOCH 4.
3. Turn the EPOCH 4 on via the front keypad.
4. Proceed with normal operation.

2.2 Using Battery Power

The EPOCH 4 uses Nickel Metal Hydride (NiMH) batteries. An optional “AA” Alkaline battery pack is available (See Using a “AA” Alkaline Battery on page 21).

Press **[ON/OFF]** to power up the unit after the initial status screen, the EPOCH 4 proceeds to the split screen display.

A battery symbol is always present at the bottom right corner of the display and indicates the remaining battery charge. A completely filled battery symbol relates directly to the charge remaining on the battery. A symbol that is half filled means that the battery is 50% charged. All batteries show some rebound effects so the initial reading appears higher than the actual amount. This is temporary; a stable battery reading can be obtained after 1-2 minutes of operation.

2.3 Operating Time for the Battery

The EPOCH 4 operating time on battery power varies depending on the display type and use conditions. The Liquid Crystal Display (LCD) has a nominal operating time of 10 hours on a full charge. The Electroluminescent Display (ELD) has a nominal operating time of 7 hours. Instrument settings can also affect battery life.

Note: It may initially take several cycles of complete charging and discharging of the battery to bring the battery to full capacity. This conditioning process is normal for (NiMH) batteries.

2.4 Replacing the Battery



Warning: The EPOCH 4 Charger/Adapter is designed to charge EPOCH 4 batteries only. DO NOT ATTEMPT TO CHARGE ANY OTHER BATTERIES. Doing so may cause an explosion and injury! Do not attempt to charge other electronic equipment. This will cause permanent damage.

To replace the battery, follow these steps:

1. Turn the unit over so the display is face down.
2. Loosen the two screws on the back of the unit at the bottom that secure the battery door cover.
3. Remove the battery door cover exposing the battery.
4. Slide out the battery from the bottom of the unit.
5. Install the replacement battery by reversing these steps.

Tip: The battery has a notch on one end and only fits into the unit one way.

2.5 Charging the Battery

Note: Charge EPOCH 4 batteries with the EP4-MCA Charger/Adapter only.

There is no on/off or line voltage selector switch. The Charger/Adapter automatically turns on when AC power is applied. You can charge the EPOCH 4 battery either internally in the unit or externally using a stand-alone charging base.

To charge the battery internally, follow these steps:

1. Plug the EP4-MCA Charger/Adapter into an AC Main line.
-

2. Plug the output cable directly into the receptacle on the right side of the EPOCH 4.

To ensure complete charging, charge batteries with the EPOCH 4 turned off. If the Epoch 4 is turned on while connected to an AC line, the battery charges at a slower rate.

When the unit is powered on and connected to the charger, the battery symbol on the display will continuously cycle from empty to full to indicate the battery is charging. Once the battery reaches approximately 85% capacity, the symbol will stop cycling and remain full. Charge the unit for another hour in order to achieve full capacity.

You can also charge the EPOCH 4 battery outside the instrument using an external stand-alone charger. This accessory is available through Panametrics-NDT (part number EP4-EC) or found locally in electronic and retail stores. Contact Panametrics-NDT for more information.

2.5.1 Using a Proper Cycling Charge

If the battery is used daily (or frequently), connect it to the Charger/Adapter when not in use. Whenever possible, the battery should remain connected to the EP4-MCA Charger/Adapter (overnight or over a weekend), so that it achieves 100% of full charge. The battery must reach full charge on a regular basis for the proper capacity and cycle life maintenance.

Recharge discharged batteries as soon as possible after use. Give a full recharge, as described above.

Note: Never place discharged batteries in storage without receiving a full recharge.

Store batteries in a cool, dry environment. Avoid long-term storage under sunlight or in other excessively hot places such as an automobile trunk. While in storage, fully recharge batteries at least once every 2 months.

2.6 Using a “AA” Alkaline Battery

An optional battery configuration for the EPOCH 4 is the “AA” Alkaline pack (Panametrics-NDT part number: EP4/BAT-AA.) This battery style uses readily available “AA” alkaline cells (10 cells total.) The battery pack provides a maximum EPOCH 4 operating time of 2.5 hours with the ELD screen and 4 hours with the LCD screen.

Note: The “AA” Alkaline battery pack cannot be recharged with the EPOCH 4 charger/adapter.

The **Alkaline Battery** mode is located in the **Options** menu. This mode allows the EPOCH 4 to fully discharge the AA battery. EPOCH 4 always defaults to the **AA Battery Off** mode.

3 Managing Basic Operations

This chapter describes how to get started with basic EPOCH 4 operations.

Topics are as follows:

- Powering-up
- Using the Keypad
- Summarizing Keypad Functions
- Managing the Display
- Editable Parameters Software
- Setting-up Parameters

3.1 Powering-up

Pressing [ON/OFF] causes an initial beep from the unit and then a series of relay clicks. The display lights up and the unit goes through a self-test for 5 seconds.

Note: You can do a Master Reset on the EPOCH 4 during power-up. Press and hold [EDIT] and then turn the unit on. Do not release [EDIT] until the screen lights up with a **Powerup Reset** prompt box. Press [OPTION] to cancel master reset and the unit will proceed to the live screen. Otherwise, press [ENTER] to continue. Use the slewing keys to move the highlight bar over the desired selection:

Parameters - Resets the unit's parameters back to the factor settings

Database - Erases the EPOCH 4's memory (saved calibrations, etc.)

Parameters + Database - Completes both operations listed above.

Use the slewing keys to highlight your selection and press [ENTER]. A ☒ appears. Press [OPTION] to complete the MASTER RESET and proceed to the live screen.

3.1.1 ELD and LCD Screen Adjustment

You can adjust the EPOCH 4's screen for maximum viewing under the harshest and most extreme lighting conditions. The adjustment vary depending on whether the unit is outfitted with an Electroluminescent Display (ELD) or Liquid Crystal Display (LCD).

To adjust the screen, follow these steps:

1. Press [2nd F], [CALIBRATION] (CONTRAST).
2. Use the slewing keys to position the highlight bar over the appropriate selection.
3. Use the slewing keys to adjust the setting.

ELD Brightness: This setting is valid for units with ELD screens only. You can select from brightness (intensity of screen) settings of LOW, MED, HIGH and MAX. The MAX selection is the brightest setting. Note that higher brightness settings result in lower total battery operating time. The unit will always default to the LOW setting upon power-up.

LCD Backlight: This setting is valid for units with LCD screens only. You can select to either have LCD backlight display light to set on or off. The default setting for the backlight is ON.

LCD Contrast: This setting is valid for units with LCD screen only. Depending on sunlight conditions and temperature, you may need to adjust the contrast of the LCD to maximize the screen visibility. You can slew through a wide range of the adjustment to optimize the display.

3.2 Using the Keypad

The most commonly used keys on the keypad (Gain, Freeze, Save, Enter, and Slewing Keys) are close to your left thumb. All instrument settings can be changed while keeping the left hand in a natural position.

The keypad is grouped and color coded according to function. The outlined section of yellow keys on the left side of the keypad is used primarily for calibrating. The separate group of grey keys on top are the function keys, designed to provide easy access to preset parameter values. The EPOCH 4 also has extensive data storage features controlled by the datalogger keys at the right side of the keypad.

3.2.1 Enter Key

While you can access most functions directly via the instrument keypad, you can change all essential ultrasonic controls by using of the [ENTER] key and one of the four green slewing keys [↑], [↓], [←], and [→]. This method provides control of virtually all instrument settings with the thumb of the left hand. Multiple presses of [ENTER] will toggle through each of the instrument parameters. The parameter highlights when activated. Use the [↑], [↓], [←], or [→] key to change a activated parameter value.

Press the [ENTER] key multiple times to toggle through the instrument settings. To move quickly through the sequence, press [ENTER] multiple times in succession or simply hold down the key to reach the desired function.

3.2.2 Direct Access Operation

Most commonly used parameters also have their own individual keys to provide direct access to the parameter setting. To use the EPOCH 4 in this manner, press the appropriate key to change the parameter and then either press one of the function keys (F1-F5) to select preset values, or adjust the value using the [↑], [↓], [←], and [→] slewing keys. For example to change the gain, press [GAIN]. Press [F1], [F2], [F3], [F4], or [F5] to select one of the preset dB steps or use the slewing keys for fine adjustments.

In some cases the parameter appears as a second function above another key. To change these parameters, press [2nd F] and then the appropriate key to access that parameter.

Whenever a function is opened in the full screen display, the EPOCH 4 provides prompts in the *Abbreviated Status* window directly above the A-Scan display on the left side.

3.3 Summarizing Keypad Functions

The EPOCH 4 has two keypads. The top keypad, located directly underneath the display, is made up of five function keys: [F1], [F2], [F3], [F4], and [F5].

When an operator accesses a parameter from the main keypad, preset value choices are displayed at the bottom of the screen. Each preset value has a corresponding function key. For example, press [RANGE] to view various preset range values at the bottom of the display. Press any one of the function keys to set the EPOCH 4's range to that displayed value.

The main keypad is laid out with functional grouping of keys for easy identification. The main keypad is basically split into two sections. The right side of the keypad, which resembles a telephone keypad, is used exclusively for datalogging purposes. The left side of the keypad contains the primary operating keys of the EPOCH 4. Most parameters on the EPOCH 4 can be directly accessed by pressing the appropriately labelled key. Some parameters are second functions. These can be accessed by first pressing [2nd F] and then the desired function. The second function is written directly above the key. For example, to access ZOOM, press [2nd F] and then [RANGE].

Once you access a parameter, change it through one of two methods. Use the function keys to directly access preset values. Alternately, use the green slewing keys ([↑], [↓], [←], and [→]) to change the parameter in smaller increments.

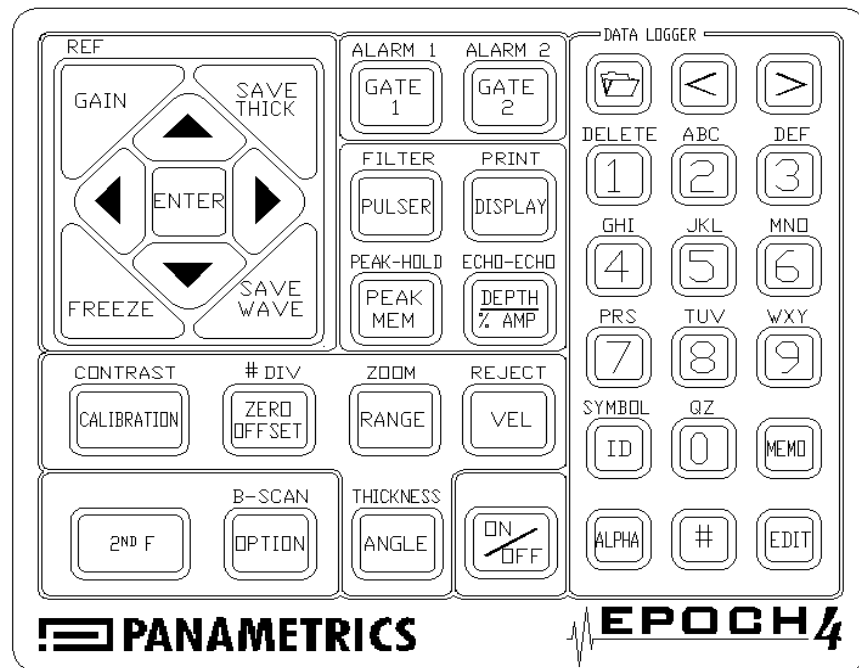

Figure 1 English Keypad

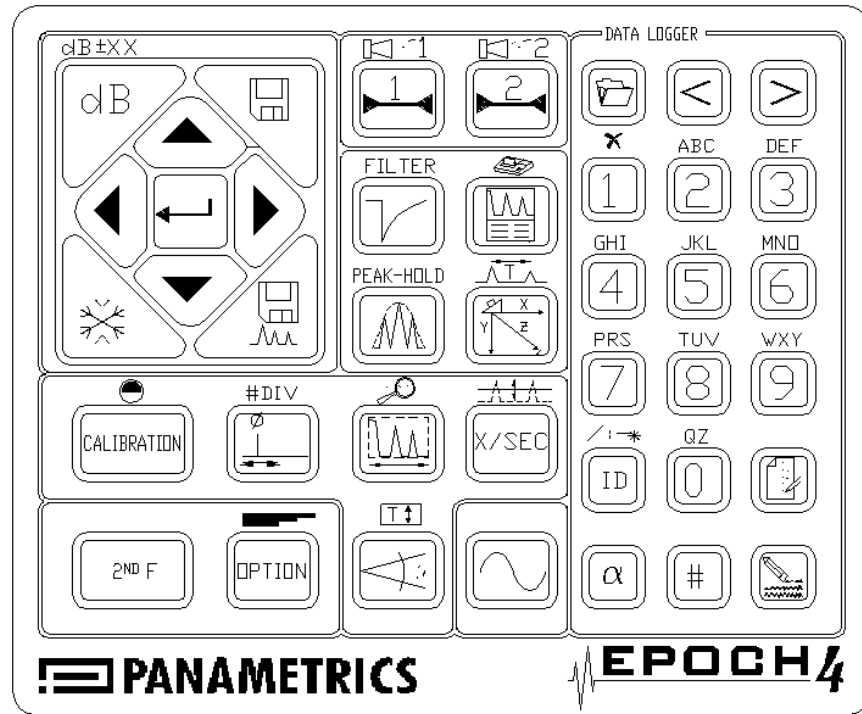

Figure 2 International Keypad

3.3.1 Main Keypad Functions





English	Int'l	Color	Function
		Blue	Sensitivity: Adjusts system sensitivity.
		Gray	Option: Accesses the instrument's setup menu and software options.
		Gray	2nd Function: Press the [2nd F] key with a key that has dual functions (the main function written on the key; the secondary function written above the key), and the secondary function becomes active.

Table 3 Main Keypad Functions



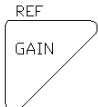
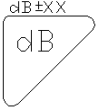







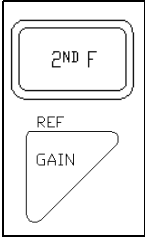
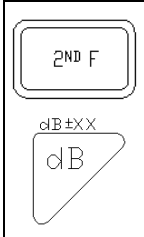

English	Int'l	Color	Function
		<p>Beige</p> <p>Blue</p>	<p>Reference Level: Sets a gain reference level and allows addition of scanning gain in 6dB or 0.1dB increments.</p>
		Blue	<p>Screen Freeze: Holds displayed waveform until [FREEZE] is pressed a second time.</p>
		Purple	<p>Save Thickness Reading: Saves displayed thickness reading in current file. If the EPOCH 4 is in Time-of-Flight mode, the value will be in microseconds.</p>
		Purple	<p>Save Waveform: Saves the current waveform and instrument setup parameters in current file.</p>
		Purple	<p>Enter: Press this key multiple times to toggle through the setup parameters.</p>
		Red	<p>Gate 1: Controls the positioning of Gate 1 on the display. Press this key multiple times, or use the function keys, to access Gate 1 Start, Gate 1 Width, and Gate 1 Level.</p>
		<p>Beige</p> <p>Red</p>	<p>Gate 1 Alarm: Activates the alarm mode for Gate 1. Use the function keys to access the Threshold or Minimum Depth Alarm.</p>
		Red	<p>Gate 2: Controls the positioning of Gate 2 on the display. Press this key multiple times, or use the function keys, to access Gate 2 Start, Gate 2 Width, and Gate 2 Level.</p>

Table 3 Main Keypad Functions (Continued)





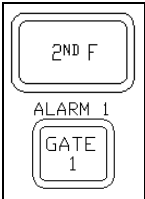
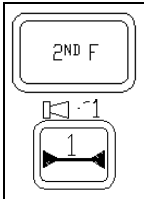

English	Int'l	Color	Function
		Beige Red	Gate 2 Alarm: Activates the alarm mode for Gate 2. Use the function Keys to select the Threshold or Minimum Depth Alarm .
		Orange	Pulser: Press this key multiple times to toggle through the pulser parameters. Use the function keys to select preset values for each pulser parameter.
		Beige Orange	Filter: Brings you directly to the filter parameters.
		Orange	Display View: Press this key multiple times to toggle between Full Screen View (full A-Scan display) and Split Screen View (half sized A-Scan with setup parameters).
		Beige Orange	Print Data: Accesses the printing menu for sending information to a serial port printer.
		Orange	Peak Memory Function: Activates the Peak Memory function allowing continuous accumulation of peak envelope data with the live waveform. Press this key again to deactivate the function.
		Beige Orange	Peak Hold Function: Activates the Peak Hold function, which allows you to capture a screen shot and hold it on the screen while allowing the view of the live waveform. Press this key sequence a second time to deactivate the function.

Table 3 Main Keypad Functions (Continued)

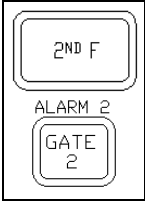
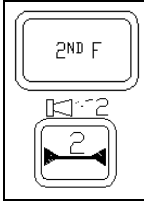
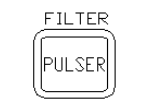

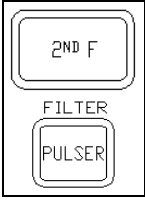
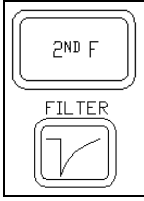
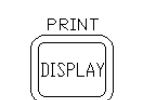
English	Int'l	Color	Function
		Orange	Depth/% Amplitude: Allows selection and display of peak depth, edge depth, signal amplitude, or time of flight data.
		Beige Orange	Echo-to-Echo Measurement: Activates the Echo-to-Echo Measurement mode. This automatically opens Gate 2 (if it is not already active) and allows you to select edge to edge or peak to peak measurement using the function keys.
		Yellow	Auto Calibration: Initiates the EPOCH 4 Auto Calibration feature in conjunction with the [ZERO OFFSET] and [VELOCITY] keys.
		Beige Yellow	Contrast Adjustment: Adjusts the contrast and backlight for units with a Liquid Crystal Display (LCD) and to adjust the brightness setting for units with an Electroluminescent Display (ELD).

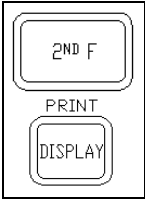
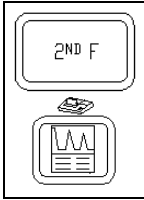
Table 3 Main Keypad Functions (Continued)

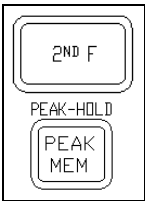
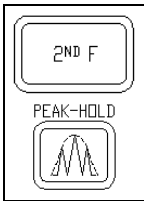
3.3.2 Datalogger Keypad Functions



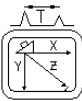
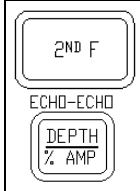
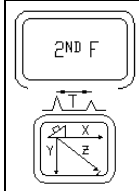

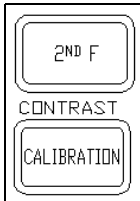
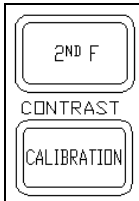
English	Int'l	Color	Function
		Blue	Open Datalogger: Opens the EPOCH 4 datalogger/memory screen.
		Blue	Move Cursor Left: Moves the cursor to the left one space each time this key is pressed when the datalogger is opened, and you are entering/editing a directory name, filename, etc.

Table 4 Datalogger Keypad Functions













English	Int'l	Color	Function
		Blue	Move Cursor Right: Moves the cursor to the right one space each time this key is pressed when the datalogger is opened, and you are entering/editing a directory name, filename, etc.
		Beige	Alpha Entry: Allows entry of the characters that are in beige-colored text above the numbers keys. This includes entry of the letters “A” through “Z”, the entry of symbols (above the ID key, and the Delete function above the [1] key).
		Yellow	Number Entry: Allows entry of the number keys [0] through [9] .
SYMBOL 		Blue	ID Entry: Allows entry of an ID (Identifier) location code. This ID could be a new location code or editing or a current one.
		Blue	Memo Entry: Allows entry of notes/ comments regarding the inspection data.
		Blue	Database Edit: Allows you to edit an existing directory or file name when in the datalogger/memory screen.

Table 4 Datalogger Keypad Functions (Continued)

KEYS	COLOR	FUNCTION
	Yellow	<p>Alphanumeric Entry: Entry of alphanumeric characters. The numeric characters are entered after pressing the [#] key. The alpha characters are entered after pressing the [ALPHA] key.</p> <p>The Delete function is used to erase a number or character.</p> <p>Note: The international keypad uses an X symbol instead of the Delete label over the [1] key.</p>

Table 5 Datalogger Alphanumeric Keypad Functions

3.4 Editable Parameters Software

Editable Parameters is a new software feature released with EPOCH 4 operating software version 1.07. This feature is included with all new EPOCH 4 Flaw Detectors and is free to all existing EPOCH 4 owners. When the EPOCH 4 is upgraded to operating software version 1.07, the **Editable Parameters** option will appear in the **Options** menu automatically.

Using the **Editable Parameters** option, you can customize some of the values that appear above the [F1] to [F5] keys. These are the values that the EPOCH 4 recalls automatically when the corresponding [F] key is pressed. You can edit the following parameters:

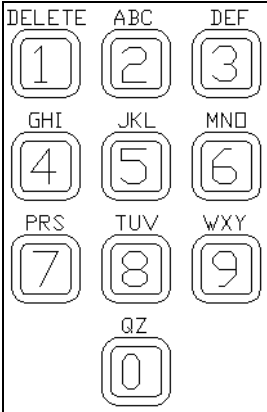
- Gain
- Reject
- Zero Offset
- Angle
- Frequency
- Range
- Thickness
- Velocity

Note: Parameters that contain text, such as Rectification, cannot be adjusted. Also, parameters that are limited by hardware and/or software constraints such as Damping cannot be adjusted.

3.4.1 Activating Editable Parameters

To activate the **Editable Parameters** menu, follow these steps:

1. Press the [OPTION] key.
2. Use the slewing keys to select the **Editable Parameters** option.

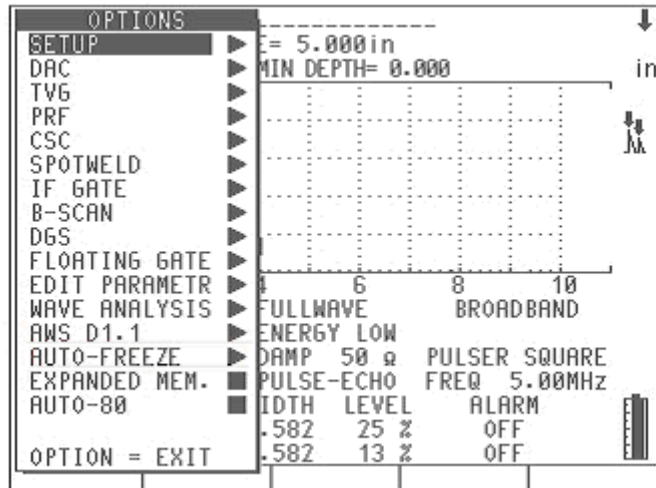

Figure 3 Selecting the Editable Parameters Option

3. Press [ENTER]. The *Editable Parameters* screen opens:

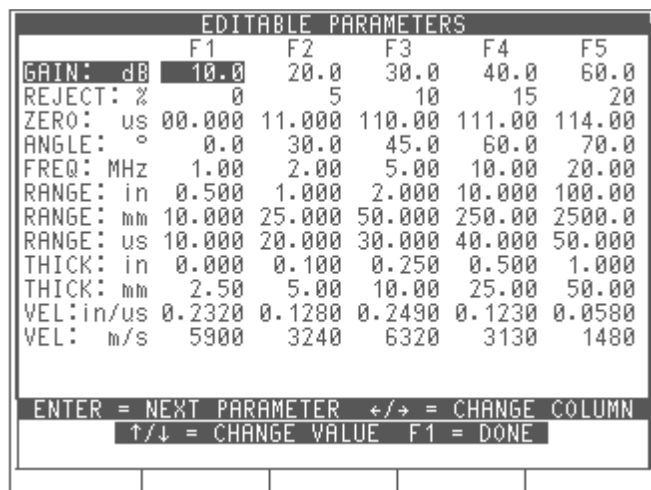

Figure 4 Viewing the Editable Parameters Screen

4. Press the [ENTER] key to move downward to different Parameters.

- Use the left and right slewing keys to select which [F1] - [F5] parameter to edit.
 Edit each parameter using the up and down slewing keys.

EDITABLE PARAMETERS					
	F1	F2	F3	F4	F5
GAIN: dB	15.0	25.0	35.0	45.0	65.0
REJECT: %	0	5	10	15	20
ZERO: us	00.000	11.000	110.00	111.00	114.00
ANGLE: °	0.0	30.0	45.0	60.0	70.0
FREQ: MHz	1.00	2.00	5.00	10.00	20.00
RANGE: in	0.500	1.000	2.000	10.000	100.00
RANGE: mm	10.000	25.000	50.000	250.00	2500.0
RANGE: us	10.000	20.000	30.000	40.000	50.000
THICK: in	0.000	0.100	0.250	0.500	1.000
THICK: mm	2.50	5.00	10.00	25.00	50.00
VEL: in/us	0.2320	0.1280	0.2490	0.1230	0.0580
VEL: m/s	5900	3240	6320	3130	1480

ENTER = NEXT PARAMETER +/- = CHANGE COLUMN
 ↑/↓ = CHANGE VALUE F1 = DONE

Figure 5 Editing the Gain Parameter

- Press the [F1] key, when you have finished editing the parameters, to save the settings and return to the **Options** menu.
 When you select one of the parameters that you edited, the new preset values appear above the [F] keys.

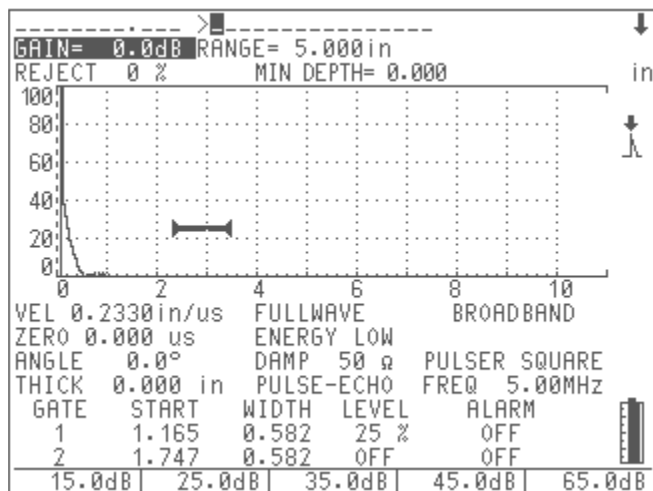

Figure 6 Viewing New Preset Values

3.5 Managing the Display

The EPOCH 4 can present the A-Scan in two different display formats – split screen and full screen. A split screen presents simultaneous viewing of the waveform and all instrument set-up data. The full screen presents a large, high resolution waveform and important basic information.

Note: After the EPOCH 4 is powered up and completes the self test routine, the split screen opens.

To set the display parameter, simply press **[DISPLAY]** to switch to full screen or press **[DISPLAY]** again to switch back to the split screen.

3.5.1 Full Screen A-Scan Display

The full screen A-Scan presents a large, high resolution waveform and some basic data to aid with interpretation of the display.

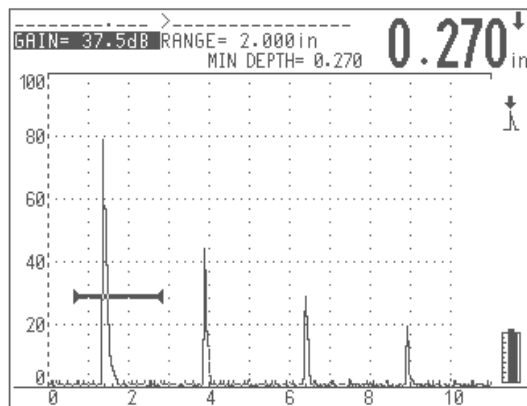

Figure 7 Full Screen Display

Top of the screen

- The Filename, Gain level, ID Code, Range setting, and currently selected parameter are constantly displayed.
- A numeric display shows thickness, soundpath, amplitude, or Time-of-Flight data pertaining to a gated signal. Use **[DEPTH /%AMPL]** to select which information to show.

Middle of the screen

- Displays the waveform.
- In the background, a numbered graticule shows signal amplitude on the vertical axis and screen division number or the function presets on the horizontal axis. To view the screen divisions instead of the function presets, press [2nd F] then [ZERO OFFSET] (#DIV).
- On the right side of the waveform display, a set of display flags and markers appear when certain functions are active (See Display Flags and Markers on page 36).

Bottom of the screen

- Displays the preset values for many of the parameters. These are accessed via the function keys.
- The battery level icon is constantly displayed in the bottom right corner.

3.5.2 Split Screen Display

The split screen display presents a condensed waveform and a status display that shows all instrument set-up data. This screen is useful when establishing the initial instrument settings as it enables you to quickly check all set-up information and make adjustments while viewing the waveform display. Even in the split screen mode, the A-scan still has enough resolution to produce accurate waveforms.

To display a split screen, follow these steps:

1. Press [DISPLAY] to toggle the display to the split screen.

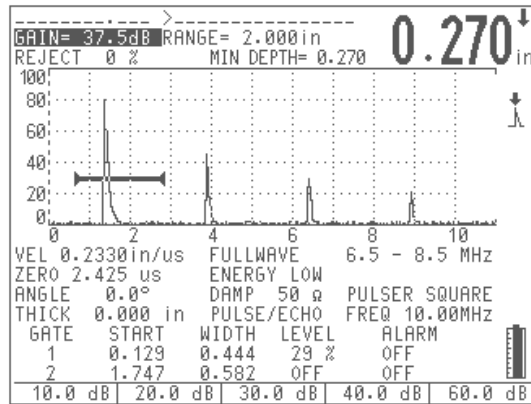
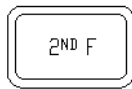

Figure 8 Split Screen Display

2. Press [ENTER] several times to toggle through the instrument parameters.
3. Use the [↑], [↓], [←], and [→] keys to change the setting from the current highlighted function.

3.5.3 Display Flags and Markers

To indicate when particular display functions are active, a set of flags and markers appear on the right side of the waveform display.



Indicates the **[2nd F]** key has been pressed. The unit is waiting for you to press one of the second function keys. Press **[2nd F]** again to cancel.

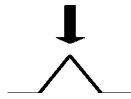

Indicates the EPOCH 4 is in the **Peak Depth** mode; thickness and soundpath measurements are made to the peak of the highest amplitude signal within the flaw gate. This symbol also appears when the amplitude display is active as all amplitude measurements are made to the peak of the signal.

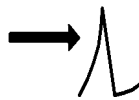

Indicates the EPOCH 4 is in the **Edge Depth** mode and all thickness and soundpath measurements are to the leading edge of the first signal within the flaw gate.

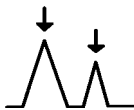

Indicates the EPOCH 4 is in the **Echo-to-Echo measurement** mode and the measurement is being made between the peaks of the two selected signals.



Indicates the EPOCH 4 is in the **Echo-to-Echo measurement** mode and the measurement is being made between the leading edges of the two selected signals.

P

Indicates the **Peak Memory** function is active.

PH

Indicates the **Peak Hold** function is active.

F

Indicates the display is frozen because the **Freeze** function is activate.

Z

Indicates the **Zoom** function is activate to expand the region within the flaw gate to full screen width.

A

Indicates the gate alarm is tripped.

TVG

Indicates Time Varied Gain is active.

DAC

Indicates Distance Amplitude Correction is active.

CSC

Indicates Curved Surface Correction is active.

B

Indicates B-Scan is active.

PRF

Indicates either **Low PRF** or **High PRF** Option is active.

DGS

Indicates DGS (Distance Gain Sizing) is active.



Indicates the remaining battery life in the unit. The battery level is constantly displayed in the lower right corner of the display.

3.6 Setting-up Parameters

The EPOCH 4 **Setup** screen allows you to select basic system parameters. To access the **Setup** screen, press [OPTION]. Move the highlight bar over **Setup** and press [ENTER]. The following screen appears:

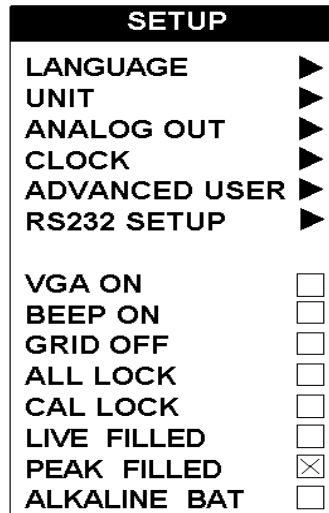

Figure 9 Menu Options

The selections in the **Setup** menu are grouped according to function. Use the green slewing keys to move around this menu. Press [ENTER] to select/deselect an item. Press [OPTION] to return to the live screen after making choices.

Symbol	Description
▶	When this symbol appears after a menu item, it means that another menu is available. Simply highlight the item using the slewing keys and press [ENTER] to view the next menu.
<input type="checkbox"/>	When this symbol appears after a menu item, it means that multiple items within the group can be selected.
<input checked="" type="checkbox"/>	When this symbol appears after a menu item, it means that the item is selected.

Table 6 Menu Symbol Descriptions

3.6.1 Language Selection

To select or change a language to use on the EPOCH 4, follow these steps.

1. Move the highlight bar over the **Language** option and press [ENTER].

2. Move the highlighted bar over the desired choice and press **[ENTER]**.
3. Press **[OPTION]** to exit.

3.6.2 Units of Measurement

The EPOCH 4 is capable of displaying and calculating distance parameters and soundpath data in terms of “distance” (inches or millimeters) or time (microseconds). When displaying in terms of distance, the screen can be set to be viewed either in units per division (for example 1.000in/div or 25.00mm/div) or units full scale (for example 10.00in full scale or 250mm full scale). Units full scale describes the distance over the entire screen range.

When displaying in terms of time, all distance parameters (range, zero offset, gate position, material thickness, minimum depth, and all soundpath data) are displayed using microseconds (μ s) instead of inches or millimeters.

To change the units of measure, follow these steps:

1. Move the highlight bar over **Unit** and press **[ENTER]**.
2. Use the slewing keys to select the desired unit setting and press **[ENTER]**.
3. Press **[OPTION]** to exit.

3.6.3 Analog Out

The EPOCH 4 is capable of continuously outputting the depth or amplitude information to an external device, such as a strip-chart recorder or a PC outfitted with an Analog/Digital converter card. The information is outputted as a voltage, either on a 0-1 volt or 0-10 volt scale.

Select the output scale and then connect the EPOCH 4 to the external device via the analog output LEMO connector on the top of the instrument.

To change the voltage output scale, follow these steps:

1. Move the highlight bar over **Analog Out** and press **[ENTER]**.
2. Use the slewing keys to select the desired voltage scale setting and press **[ENTER]**.
3. Press **[OPTION]** to exit.

3.6.4 Clock

The EPOCH 4 has a real time internal clock. The clock can be set once, and the instrument then stamps individual files in the datalogger with the correct time/date whenever information is saved to that file. The time/date is also updated whenever additional information is saved to the file. The clock is reset during an instrument Master Reset and when it initially ships from the factory.

To set the clock, follow these steps:

1. Move the highlight bar over **Clock** and press **[ENTER]**.

2. Use the slewing keys and the datalogging keys to enter the correct date mode, date and time.
3. Press **[F1]** to set or **[F2]** to cancel the updated settings.

3.6.5 Advanced User

Several EPOCH 4 functions can be customized with either a standard setting or an advanced setting for users needing additional flexibility and control. All functions are reset to the standard setting with an instrument Master Reset or when it initially ships from the factory.

To change to the advanced user settings, follow these steps:

1. Move the highlight bar over **Advanced User** and press **[ENTER]**.
2. Use the slewing keys and **[ENTER]** to select or deselect the individual setting.
 signifies the advanced user setting is in place for that feature.
3. Press **[OPTION]** to exit.

Filter (See **Pulsar Frequency Selection** on page 52)

The EPOCH 4 is equipped with narrowband filters that are designed to provide a better signal-to-noise ratio for many applications by filtering out undesired frequencies.

When set to **Standard**, you can select factory preset bandpass filters. When set to **Advanced**, you can customize the filtering by selecting both high and low pass filters individually.

Zero Offset

The zero offset parameter compensates for the time offset between electric and acoustic zero points. This offset is attributed to cable and transducer properties, sound delays from angle beam wedges and delay line tips, etc.

It is extremely important that you do **not** offset the screen so much that incorrect multiple backwall echoes are used during the calibration procedure. For this reason, some users may want to limit the number of preset function key values for the zero offset parameters.

The Standard setting only allows you to press **[F1]** to directly set the zero offset value to 0.000us.

The Advanced setting allows you to access the **[F2]** through **[F5]** keys for additional zero offset presets. These are designed to closely match calibrated zero offset values for common straight beam, delay line, and angle beam transducers.

X-Value

The X-Value Correction feature is used during angle beam inspections to account for the distance between the front of the wedge and the Beam Index Point (B.I.P.), which is where the focused sound energy leaves the wedge and enters the material.

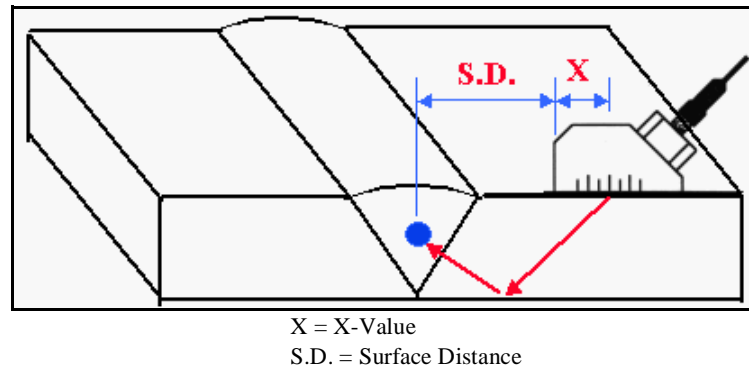

Figure 10 Discovering a Flaw during an Angle Beam Inspection

This is useful as it adjusts the surface distance value of the “Soundpath Calculator”, so that the adjusted value corresponds to the distance from the front of the wedge to the location of where the flaw is being detected. This allows you to butt the end of a ruler up against the front of the wedge to find the surface distance to the detected flaw.

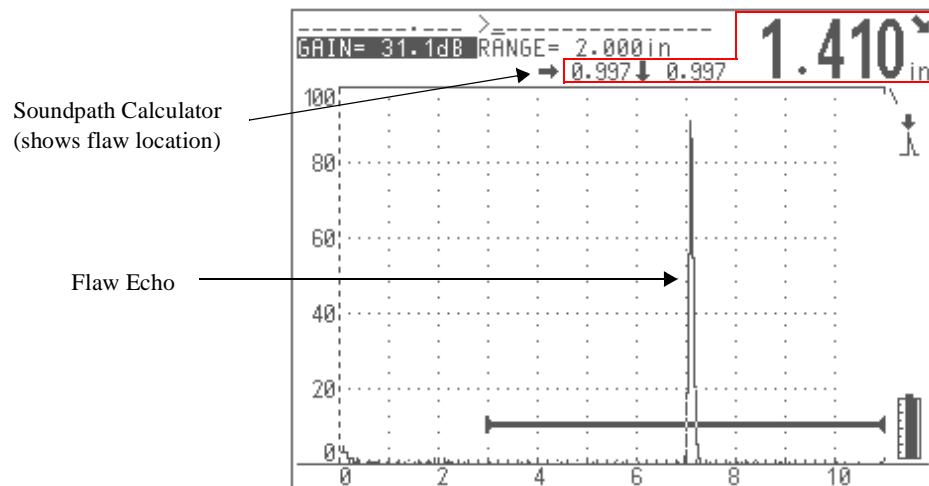



Figure 11 Displaying the Flaw Location

To activate the X-Value feature, follow these steps:

1. Press [**OPTION**].
2. Use the slewing keys to move the highlight bar over **Setup** and press [**ENTER**].
3. Use the slewing keys to move the highlight bar over **Advanced User** and press [**ENTER**].
4. Use the slewing keys to move the highlight bar over **X-VALUE** and press [**ENTER**].
5. Press [**ENTER**] to toggle the X-Value Correction On/Off.

When turned on, use the slewing keys to enter the actual X-Value. This is the distance between the front of the wedge and the Beam Index Point (B.I.P.).

6. Press [**OPTION**] to return to the live screen.

When the X-Value Correction is activated, the surface distance symbol for the soundpath calculator appears as a hollow arrow .

Save ID

You can choose to save either the **Minimum Depth** or the **Current Depth** in the datalogger when you press the [**SAVE THICK**] key. The default selection is to save the **Current Depth**. If the **Minimum Depth** is saved, the value in the datalogger will be tagged with a "M" symbol to signify **Minimum Depth**.

To select the value to be saved, follow these steps:

1. Press [**OPTION**].
2. Use the slewing keys to move the highlight bar over **Setup** and press [**ENTER**].
3. Use the slewing keys to move the highlight bar over **Advanced User** and press [**ENTER**].
4. Use the slewing keys to move the highlight bar over **Save ID** and press [**ENTER**].
5. Use the slewing keys to select the desired choice, and press [**ENTER**] to make the selection.
6. Press [**OPTION**] to return to the live screen.

3.6.6 RS232 Setup

The EPOCH 4 is equipped with an RS232 port located on the top of the instrument. You can use a cable to connect the EPOCH 4 to a PC, printer, or other hardware device. The most common usage for this port is communication with a PC via the EPOCH 4 Interface Program (contact Panametrics-NDT or your local representative for further details).

Users must also select the appropriate flow control (hand shaking) protocol. The choice is either **software** (X on/X off) or **hardware**. The most common choice is **software** as this selection is used when communicating with the EPOCH 4 Interface Program.

When communicating with these types of devices, you must select the correct baud rate on the EPOCH 4 to match the hardware device on the other end of the connection. The EPOCH 4 serial port has the ability to send/receive data at 38400, 19200, 9600, or 2400 baud.

To select the baud rate and flow control on the EPOCH 4, follow these steps:

1. Press [**OPTION**].
2. Position the highlight bar over **Setup** and press [**ENTER**].
3. Position the highlight bar over **RS232 Setup** and press [**ENTER**]. The current selections are denoted by a "●".

4. To change the baud rate and flow control, position the highlight bar over the desired selection and press **[ENTER]**. This selection are denoted by a “1”.
5. Press **[OPTION]** to return to the live screen.

3.6.7 **VGA Output On/Off**

The VGA output on the EPOCH 4 lets you view the screen display on a PC monitor, projector, or a heads-up display. Connect the EPOCH 4 to the external device with a cable attached to the VGA port on the top of the unit.

The default setting for the VGA Output is OFF. The EPOCH 4 consumes a slightly greater amount of power when the VGA circuitry is turned on, which reduces battery operating time.

To turn on the VGA output, follow these steps:

1. Move the highlight bar over **VGA On** and press **[ENTER]**.
 in the corresponding box signifies the VGA output is on.
2. Press **[ENTER]** again to turn it off.
3. Press **[OPTION]** again to the return to the live screen.

3.6.8 **Beep On**

Note: When **Beep On** is selected, pressing the keypad results in audible beeps.

3.6.9 **Grid On/Off**

When you select **Grid Off**, only the borders of the graticule shows behind the waveform display. This is a real-time condition only and is not stored.

3.6.10 Keypad Lock Functions

All Lock: When you select **All Lock**, all keys except [**DISPLAY**], [**OPTION**], [**ENTER**], [**↑**], [**↓**], [**←**], [**→**], and [**ON/OFF**] are inactive.

A full padlock appears above the battery symbol indicator to show that **All Lock** is selected.

Cal Lock: When you select **Cal Lock**, a half padlock appears above the battery indicator and the following keys are inactive:

[GAIN]	[VEL/REJECT]
[CALIBRATION]	[ANGLE/THICKNESS]
[ZERO OFFSET]	[PULSER/FILTER]
[RANGE]	

To unlock either the **All Lock** or **Cal Lock**, return to the **Setup** screen and deselect the item.

3.6.11 Filled Live

When you select **Filled Live**, the live waveform appears filled-in, rather than as an outline trace. This is used to make the waveform more visible when viewing in bright sunlight.

3.6.12 Filled Peak

When you select **Filled Peak**, a waveform or echo envelope that is frozen on the screen when using either the **Peak Memory** or **Peak Hold** feature appears filled-in, rather than as an outline trace.

3.6.13 “AA” Alkaline Battery Selection

When using the Alkaline battery pack offered by Panametrics-NDT, the **Alkaline Bat.** selection in the **System Setup** menu should be highlighted. This allows for maximum battery operating time.

Note: This selection defaults to **Off** (NiMH battery) when the unit is powered off and back on again.

4 Adjusting the Pulsar Receiver

This chapter describes how to adjust the pulser receiver.

Topics are as follows:

- Adjusting System Sensitivity
- Using AUTO-80%
- Setting Gain Reference Level and Adding Scanning Gain
- Using the Pulsar Key

4.1 Adjusting System Sensitivity

To adjust the instrument sensitivity, follow these steps:

1. Press **[GAIN]**.
2. Use the function keys to select preset values for course adjustment.
3. Move the gain upward or downward with the **[↑]** and **[↓]** keys for fine adjustments.
The current system sensitivity is displayed and highlighted in the upper left corner.
4. Adjust gain in 0.1dB increments by pressing the **[↑]** or **[↓]** key once.
5. Hold the **[↑]** or **[↓]** key to gradually increasing slewing rate.
Total system sensitivity is 110.0dB.

4.2 Using AUTO-80%

AUTO-80% is an excellent tool to quickly adjust the gain (dB) setting, bringing the peak of a reference echo to 80% full screen height. AUTO-80% is especially useful with general welding applications and codes that require quick gain adjustments to bring an echo to 80% screen height.

You can use AUTO-80% to bring an echo to 80% full screen height in either Gate 1 or Gate 2.

To use Auto-80% with Gate 1, follow these steps:

1. Press **[GATE 1]**.
2. Use the green slewing keys to position the gate over the desired echo. Be sure the echo breaks the gate threshold.
3. Press **[F5]**. The peak of the highest amplitude echo breaking the Gate 1 threshold is brought to 80% screen height.

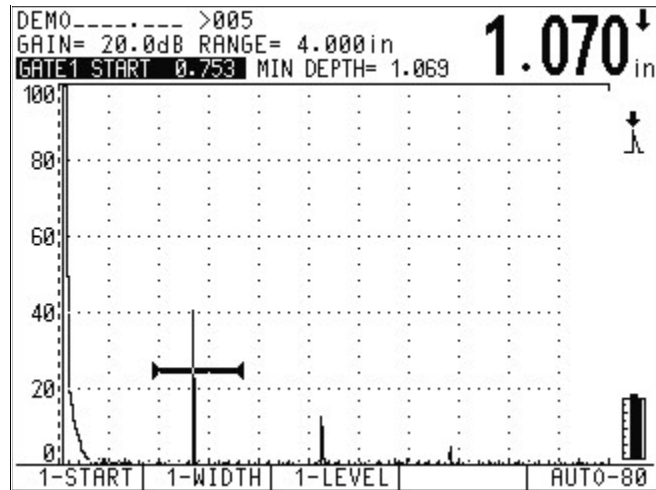

Figure 12 Before Activating AUTO-80%

To use Auto-80% with Gate 2, follow these steps:

1. Press [**GATE 2**].
2. Press [**F4**] to turn on the gate if necessary.
3. Use the green slewing keys to position the gate over the desired echo. Be sure the echo breaks the gate threshold.
4. Press [**F5**]. The peak of the highest amplitude echo breaking the Gate 1 threshold is brought to 80% screen height.

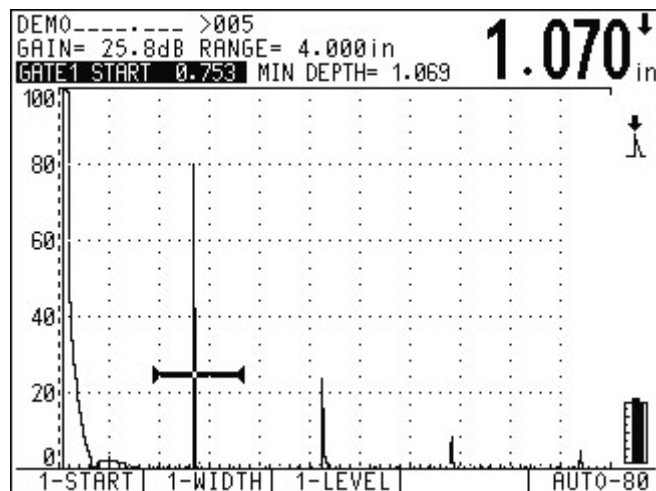

Figure 13 After Activating AUTO-80%

Note: You can use AUTO-80% when an echo exceeds the desired amplitude. The echo can be either above or below 80% full screen height. If a signal is above 80% screen height, the EPOCH 4 reduces gain in a series of repetitions until the signal peaks at 80%. Occasionally, for very high amplitudes (above 500% full screen height), you may need to press the [F5] key a second time.

4.3 Setting a Gain Reference Level and Adding Scanning Gain

To establish the current system gain as the reference (base) level, press [2nd F], [GAIN] (REF). This is useful for inspections that require you to establish a reference gain level, then add or subtract additional scanning gain.

After accessing the reference function, the gain display will read: REF XX.XdB + 0.0. You can now add scanning gain independent of the reference gain level.

To add scanning gain, follow these steps:

1. Press [F2] to add or subtract scanning gain in 6dB increments. The cursor position is to the left of the decimal point.
2. Use the [↑] and [↓] keys to increment or decrement.
3. Press [F1] to make adjustments in 0.1dB increments. The cursor position is to the right of the decimal point.
4. Use the [↑] and [↓] keys to increment or decrement.
5. Use the [↑] and [↓] keys to increment and decrement the scanning gain.

Tip: Press [GAIN] multiple time as another method to toggle back and forth between the 6dB and 0.1dB increments.

You can add the scanning gain to the reference level, toggle between the active scanning gain and 0dB (this is the scan dB feature), or turn it off by pressing the following keys:

[F3]: Adds the reference gain and scanning gain together, and exits the Reference Level function.

[F4]: Scan dB-Toggles the scanning gain back and forth from the active scanning gain and 0dB.

[F5]: Exits the Reference Level function without adding the entered scanning gain.

Prompts are displayed in the function boxes at the bottom of the screen. If another parameter is accessed, these choices may change, but can be brought up again by pressing [2nd F], [GAIN] (REF).

4.4 Using the Pulser Key

The following pulser receiver and filter parameters can be adjusted on the EPOCH 4 keypad:

- Waveform Rectification
- Pulser Energy
- Pulser Damping
- Pulser Test Mode
- Filter Selection
- Pulser Type (square wave or spike excitation)
- Pulser Frequency (tuned for square wave pulser only)

To access the available parameters, follow these steps:

1. Press [**PULSER**] multiple times to toggle through the several features.
2. Press [**2nd F**], [**PULSER**] (**FILTER**) to go directly to the filter parameter.

Each pulser-receiver and filter characteristic adjustments can be done in either Full A-Scan or Split Screen.

- In the full A-scan, the current parameter being adjusted appears at the top left of the screen, directly above the waveform.
- In the **Split Screen** mode, the parameter is highlighted on the lower half of the EPOCH 4 screen.

Note: For reviewing the adjustments in this manual, we use the **Split Screen** mode.

To view how the selections of the pulser receiver affect a waveform, couple a transducer to a sample or test block, which produces an echo on the top half of the screen.

4.4.1 Waveform Rectification

The EPOCH 4 can operate in one of four different rectification modes:

- Full Wave
- Half Wave Positive
- Half Wave Negative
- RF (unrectified)

The RF mode is not active while operating in DAC or TVG mode, Peak Memory, or Echo-to-Echo mode.

To select a waveform rectification mode, follow these steps:

1. Press [**PULSER**] once to display the current screen rectification. This is highlighted and displayed at the bottom of the screen.

2. Use the function keys for direct access or the [↑] and [↓] keys to toggle through the different waveform rectification modes.

4.4.2 Pulsar Energy

The EPOCH 4 has four pulser energy settings depending upon test conditions:

- Low (100V)
- Medium (200V)
- High (300V)
- Max (400V)

Tip: Generally, the lower pulser energy settings is used for thin materials, while the higher settings are used for thicker materials and/or highly attenuating materials.

To select a pulser setting, follow these steps:

1. Press [**PULSER**] to access the energy level settings.
In the split screen mode, the pulser energy level is highlighted on the lower half of the screen.
2. Use the function keys for direct access or the [↑] and [↓] keys to toggle between the four selections.

4.4.3 Damping

The damping control lets you optimize the waveform shape for high resolution measurements via an internal resistive circuit. There are four damping settings:

- 50 ohms
- 63 ohms
- 150 ohms
- 400 ohms

Tip: Generally, the lowest ohm setting increases the system damping and improves near surface resolution, while the highest ohm setting decreases system damping and improves the instrument penetration power.

Selecting the correct damping setting fine tunes the EPOCH 4 to operate with a particular transducer selection. Depending upon the transducer being used, the various damping settings either improve near surface resolution or improve the instrument's penetration power.

To select a damping option, follow these steps:

1. Press [**PULSER**] to access the Damping parameter.

2. Use the function keys for direct access or the [↑] and [↓] keys to toggle through the four available damping selections.

4.4.4 Test Mode

The EPOCH 4 can operate in three different Test modes:

- Pulse-Echo Mode:** Single element transducers. Use either transducer connector.
- Through Mode:** Two separate transducers, typically on opposite sides of the test specimen. Use the red transducer connector as the transmitter.
- Dual Mode (Pitch and Catch):** One connector acts as a transmitter, the other acts as a receiver. The red transducer connector is designated as the transmitter.

To select a **Test** mode, follow these steps:

1. Press [PULSER] to access the test mode parameter.
2. Use the function keys for direct access or the [↑] and [↓] keys to toggle through the three selections.

Note: To compensate for the one-way soundpath in **Through** mode, the EPOCH 4 does not divide transit time by two when calculating thickness measurements.

4.4.5 Narrowband Filters

The EPOCH 4 has a 25MHz bandwidth at -3dB (broadband frequency spectrum). The instrument can operate in either broadband mode, or can use one of many narrowband filters. Filters improve signal-to-noise ratio by filtering out unwanted low or high frequency noise outside the test frequency spectrum.

The EPOCH 4 user interface for the filter selection varies depending on whether you are in **Standard User** or **Advanced User** mode (See Advanced User on page 39.)

Standard User Mode

In the **Standard User** mode, you can choose one of nine preset selections. Generally, the best results are found by filtering out frequencies below and above the selected transducer frequency. The filter selection is saved in the instrument's datalogger when the entire waveform/calibration is saved. The appropriate filter selection is recalled when the waveform/calibration is recalled to the live screen.

The Broadband selection means that the entire frequency spectrum is analyzed. This setting is appropriate when you do not want to adjust the filters when either changing transducers or changing to a different application. However, the signal to noise ratio may not be as great as if a narrowband filter is selected.

For example, if you are using a 10 MHz transducer, select the 8.0–12.0 MHz filter for the best results. Sometimes, the transducer frequency falls between several preset selections. We recommend that you couple the transducer to a known standard and then adjust the filter selection until the best signal-to-noise ratio for the desired echo is achieved.

The following preset filter selections are available in **Standard User** mode:

- Broadband (0.3 MHz - Bypass)
- 0.3 - 0.8 MHz
- 0.8 - 1.2 MHz
- 0.8 - 3.0 MHz
- 1.7 - 8.5 MHz
- 3.0 - 6.0 MHz
- 6.5 - 8.5 MHz
- 8.0 - 12.0 MHz
- > 8.0 MHz (8.0 MHz - Bypass)

To select the Filter setting, follow these steps:

1. Press [**PULSER**] multiple times until the filter selection is highlighted, or press [**2ND F**], [**PULSER**] (**FILTER**) to go directly to the filter selection.
2. Use the function keys for direct access to the preset choices, or use [**↑**] and [**↓**] keys to change the selection.

Advanced User Mode

In the **Advanced User** mode, the filters on the EPOCH 4 are **NOT** fixed to a limited number of presets. The EPOCH 4 lets you select both low and high filter frequencies individually. You can mix and match eight selections on both low and high frequencies to maximize ultrasonic performance.

High Pass Filter Setting (HP >) – allows signals ABOVE the selection to pass through

- By Pass (Broadband)
- 300 KHz
- 800 KHz
- 1.7 MHz
- 3.0 MHz
- 6.5 MHz
- 8.0 MHz
- Custom (Future Development)

Low Pass Filter Setting (LP <) – allows signals BELOW the selection to pass through

- ByPass (Broadband)
- 800 KHz
- 1.2 MHz
- 1.7 MHz
- 6.0 MHz
- 8.5 MHz
- 12.0 MHz
- Custom (Future Development)

Your selections for low and high filter frequencies are generally a function of the transducer frequency. We recommend that you select a High Pass Filter setting below the transducer frequency being used and select a Low Pass Filter setting above the transducer frequency being used. For example, if a 10MHz transducer is being used, a High Pass Filter Setting of 8.0MHz and a Low Pass Filter Setting of 12.0MHz may provide the best signal to noise ratio. Due to down shifting of frequency and other material variations, adjust the filter selection when actually testing a material to maximize ultrasonic performance.

Note: To select a single filter setting suitable for a wide range of transducer frequencies, select the ByPass setting for both Low and High Pass Filter settings. This results in the EPOCH 4 operating in a broadband mode with a bandwidth of 25MHz at -3dB. In this mode, the filter selections do not have to be adjusted when a different transducer is used. However, the signal-to-noise performance of the instrument is better if filters are used to help eliminate noise from outside the test frequency spectrum.

To select the Low and High Pass Filter settings, follow these steps:

1. Press [**PULSER**] multiple times until the desired filter selection is highlighted, or press [**2ND F**], [**PULSER**] (**FILTER**) to go directly to the filter selections.
2. Use the function keys for direct access to the preset choices, or use [**↑**] and [**↓**] keys to change the selection.

4.4.6 **Pulser Type Selection**

The EPOCH 4 is equipped with both a negative spike excitation pulser and a tunable square wave pulser.

To choose the pulser type, follow these steps:

1. Press [**PULSER**] multiple times until the highlight bar is over the pulser selection.
2. Use the function keys or use the [**↑**],[**↓**],[**←**] and [**→**] keys to change the selection to either **Spike** or **Square**.
3. Use the square wave pulser to provide the best ultrasonic performance for a wide range of applications, because the pulser can be tuned (See Pulser Frequency Selection on page 52) to best match the transducer being used. The square wave pulser generally performs best when using low frequency transducers (10MHz and below.)
4. Use the spike pulser to simplify the operation of the EPOCH 4 so that the pulser frequency does not have to be adjusted (See Pulser Frequency Selection on page 52.) Generally, the spike pulser yields better results when using high frequency transducers (above 10MHz.) In practice, try both pulser settings and adjust other parameters during calibration to determine the best settings for the application.

4.4.7 **Pulser Frequency Selection**

Pulser Frequency Selection is only applicable when the square wave pulser is selected. The frequency selection is designed to tune the square wave pulser to obtain the best performance for the transducer being used.

The Pulser Frequency Selection is only viewable on the display when the EPOCH 4 is in the **Square Wave Pulser** mode. In the **Spike** mode, the selection is disabled.

To select Pulser Frequency Selection, follow these steps:

1. Press [**PULSER**] multiple times until the **FREQ** selection is highlighted.
2. Use the Function keys for direct access or the [**↑**],[**↓**],[**←**] and [**→**] keys to select the desired frequency.
3. Choose a frequency that is closest to the frequency of the transducer being used.

Note: Actual results may vary and we recommend trying various settings when evaluating a test sample in order to maximize ultrasonic performance.

5 Managing Special Waveform Functions

This chapter describes how to manage special waveform functions.

Topics are as follows:

- Reject
- Peak Memory
- Peak Hold
- Screen Freeze

5.1 Reject

The **Reject** function eliminates unwanted, low-level signals from the EPOCH 4's display. Because the EPOCH 4 features a digital waveform display, the reject function is linear. **Increasing the reject level does not affect the amplitude of the signals above the reject level.** The reject level is continuously adjustable from 0 to 80% of full scale with 1% resolution and is displayed in the upper left hand corner of the screen in the split screen view.

Note: It is not possible to add reject while in the unrectified, RF display.

To access the reject function, follow these steps:

1. Press [2ndF], [VEL] (REJECT).
2. Use the function keys to select preset values or use the [↑], [↓], [←], and [→] keys to adjust the reject level upward or downward.

Any signal whose amplitude is less than or equal to the specified reject level is eliminated from the display.

5.2 Peak Memory

The **Peak Memory** function enables the display to capture and store on the screen the amplitude of each display point. The display updates each pixel if a signal of greater amplitude is acquired. When a transducer is scanned over a reflector, the signal envelope or echo dynamic as a function of transducer position, is held on the screen. In addition, the current, live waveform is displayed at the appropriate place within the echo envelope.

This function is useful when it is necessary to peak up an indication during an angle beam calibration.

Note: The **Peak Memory** function cannot be activated in the unrectified, RF display mode.

To activate **Peak Memory**, follow these steps:

1. Press **[PEAK MEM]**.
A “**P**” appears at the right side of the display to indicate the function is active.
2. Scan over the reflector to acquire the echo envelope. Continue to scan slowly until the live waveform peak matches the peak amplitude of the echo envelope. When these two points match, the signal will be peaked up.
3. Press **[PEAK MEM]** again to shut off **Peak Memory**.

Note: The EPOCH 4 software allows you to select whether to view the live waveform and/or the **Peak Memory** echo envelop as an outline or a filled-in trace. Refer to Section 3.5.11 for more information on this feature.

5.3 Peak Hold

The **Peak Hold** function is similar to **Peak Memory** as it captures the current screen that is displayed on the EPOCH 4 when the function is accessed. The difference is that with **Peak Hold**, the captured waveform is frozen on the screen, and will **not** update even if the live waveform exceeds the frozen waveform’s amplitude.

Peak Hold is useful when an operator wants to obtain a waveform from a known sample, and compare it to a waveform from an unknown test piece. Similarities and/or differences in the waveforms can be noted to help determine the unknown material’s acceptability status.

Note: The **Peak Hold** function cannot be activated in the unrectified, RF display.

To activate **Peak Hold**, follow these steps:

1. Obtain an echo on the EPOCH 4 screen that you want to capture.
2. Press **[2nd F]**, **[PEAK MEM]** (**PEAK HOLD**). This captures the screen and still allows viewing of the live waveform.
A “**PH**” appears on the right side of the A-Scan display indicating the function is active.
3. Select the captured waveform to view as a single trace by pressing **[F1]**, or as a filled-in trace by pressing **[F2]**.
4. Press **[2nd F]**, **[PEAK MEM]** (**PEAK HOLD**) again to shut off **Peak Hold**.

5.4 Screen Freeze

The **Screen Freeze** function holds or freezes the information on the screen at the moment **[FREEZE]** is pressed. Once the **Freeze** function is activated, the pulser/receiver of the

EPOCH 4 becomes inactive and does not acquire any further data. An “**F**” appears to the right of the A-Scan display indicating the function is active.

The **Freeze** function is useful when storing waveforms as it holds the current A-Scan allowing the transducer to be uncoupled from the test material. Once the display is frozen, you can do a variety of functions such as storage of the Waveform or thickness data and entry of an alphanumeric location code or memo to describe the data. It is possible to manipulate the gates to obtain thickness or soundpath data.

The **Freeze** function differs from **Peak Memory** in that no new data is acquired and added to the instrument display. The [**FREEZE**] key is ideal for high temperature measurements.

When **Freeze** is active, the following parameters cannot be changed/accessed:

- Zero Offset
- Range
- Zoom
- Reject
- Gain
- Reference Gain
- Peak Memory
- Peak Hold
- Pulser Receiver and Filter Settings

To disable the **Freeze** function and return to normal operation, press [**FREEZE**] again.

6 Using the Gates

This chapter describes how to use the gates in the EPOCH 4.

Topics are as follows:

- Positioning Gate 1
- Positioning Gate 2
- Taking Thickness Readings
- Taking Echo-to-Echo Thickness Readings
- Locating Flaws with an Angle Beam Transducer
- Measuring Signal Amplitude
- Operating Time-of-Flight Mode
- Using the Zoom Feature
- Activating Gate Alarms

6.1 Positioning Gate 1

Gate 1 is the primary flaw gate. It provides thickness readings in both the A-Scan and unrectified RF displays, soundpath data when using an angle beam transducer, signal amplitude, time of flight data, or to trigger minimum depth or threshold alarms.

Movement of Gate 1 is controlled via the red **[GATE 1]** key.

To access the starting position, width, or level of Gate 1, follow these steps:

1. Press **[GATE 1]**.
2. Press the appropriate function key.

Tip: You can also access the start, width, and level by pressing **[GATE 1]** multiple times. Use the **[↑]**, **[↓]**, **[←]**, and **[→]** keys to position the gate.

6.2 Positioning Gate 2

Gate 2 is a secondary gate and is used when making Echo-to-Echo thickness readings or when multiple alarm gates are required.

To access Gate 2, follow these steps:

1. Press **[GATE 2]** to view Gate 2 controls.
2. Press **[F4]** for ON. The movement of Gate 2 is done in the same manner as Gate 1.
3. Press **[GATE 1]** to switch back to control Gate 1.

-
- To turn Gate 2 off, press [**GATE 2**] followed by [**F4**].

6.3 Taking Thickness Readings

The EPOCH 4 is equipped with a high resolution distance calculator that provides a direct readout of thickness, soundpath, or Time-of-Flight data across the top of the A-Scan. Depth measurements can be made in two different ways. Some applications may require measuring to the leading edge of the signal, while others may require measuring to the peak of the signal.

To take a thickness reading, assuming that the EPOCH 4 is properly calibrated (See Calibrating the EPOCH 4 on page 69), follow these steps:

- Position Gate 1. Since Gate 1 is used to obtain single echo thickness readings, it must be positioned correctly. To obtain a thickness reading, the appropriate echo on the display must exceed the gate threshold. Make sure the Gate 1 start is less than the minimum expected thickness value and that the Gate 1 width exceeds the maximum expected value.

Note: When used for thickness gaging, set Gate 1 level just high enough to avoid false readings. When used for flaw detection, set Gate 1 according to the appropriate acceptance and rejection criteria.

- Select the **Measurement** mode. The EPOCH 4 can measure to either the leading edge or the peak of a signal.
- Press [**DEPTH/%AMPL**] to select the appropriate mode. The following selections will appear in the function boxes below the A-Scan display:

F1 = EDGE F2 = PEAK F3 = %AMP F4 = TOGGLE

The F4 = TOGGLE selection only appears when the unit has a refracted angle entered and when either the peak or edge mode is selected.

- Press [**F4**] multiple times to allow you to select which of the soundpath readings (depth, surface distance, or total soundpath) is displayed in large bold text.
- Select [**F1**] or [**F2**] to put the EPOCH 4 in the corresponding **Depth Measurement** mode.
- Select [**F3**] to put the EPOCH 4 into the **Amplitude Measurement** mode.

One of the following icons appears next to the upper right corner of the A-Scan.

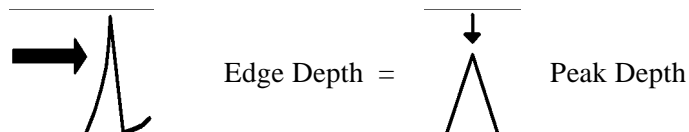

While in **Edge Depth** mode, thickness readings are made to the leading edge of the first signal to exceed the flaw gate level. In **Peak Depth** mode, thickness readings are made to the peak of the highest amplitude signal that falls within the gate.

If no refracted angle is entered, a Minimum Depth value appears above the display. This value refers to the minimum detected thickness value and is only updated if a lower value is measured. To reset the minimum depth value, press either [**GATE 1**] or [**GATE 2**].

Note: To obtain the most accurate and consistent thickness or soundpath readings, select the **Peak Depth** mode. The apparent arrival time of the leading edge of a signal varies with the signal's amplitude. As a result, the instrument gain setting, coupling conditions, and any other factor affecting signal amplitude, has an impact on the accuracy of a reading made in the edge depth mode. The effects of these factors are not completely eliminated in the peak depth mode, but they are greatly reduced. If **Peak Depth** is selected, perform calibrations using the peak of the signal. However, when using a dual transducer, due to the jagged peaks, we recommend you use **Edge Depth**.

6.4 Taking Echo-to-Echo Thickness Readings



The EPOCH 4 is also equipped to make measurements between successive echoes. Measurements can be made between two consecutive backwall echoes or between an interface echo and any other selected signal. This provides the capability to measure thickness through coatings or to do low speed immersion testing. A second gate (Gate 2) is used to capture data from the second back wall echo. Echo-to-Echo readings are made by calculating the separation between the detected echoes in Gate 1 and Gate 2.

Echo-to-Echo thickness readings cannot be made in the unrectified RF display mode

Calibrate the EPOCH 4 (see Section 7–Calibration) and follow these steps to make Echo-to-Echo thickness readings.

1. Position Gate 1 over the region where the first back echo is expected to appear.
2. Press [**2nd F**], [**DEPTH/%AMP**] (**ECHO-ECHO**) to activate the Echo-to-Echo measurement mode. The following will appear in the function boxes at the bottom of the display.

F1 = EDGE, F2 = PEAK

3. Select either edge-to-edge or peak-to-peak. The icon  appears for peak-to-peak or  appears for edge-to-edge to the right of the display to indicate Echo-to-Echo measurements are being used.

If Gate 2 is off and the **Echo-to-Echo** mode is turned on, then Gate 2 is automatically turned on.

4. Define the Blanking Period to avoid possible false readings that could occur due to transducer ringing or material noise. A dead zone or blanking period is necessary after the detection of the first echo. This period is defined during set-up as the separation between the start of Gate 1 and the start of Gate 2. When an echo is detected in Gate 1, Gate 2 start automatically adjusts to trail the detected echo by the blank period.

For example, if Gate 1 Start is set to 0.25" (6.35mm) and Gate 2 Start is set to 0.40" (10mm), then the blank period is 0.15" (3.8mm) of metal path. If the first detected

echo breaks Gate 1 at 0.35" (8.9mm), then Gate 2 Start automatically adjusts by the value of the blanking period to 0.50" (0.35" + 0.15") or 12.7mm (8.9mm + 3.8mm).

There is a trade-off in defining the blanking period. While a relatively long period may prevent false readings, the minimum measurable thickness is limited to a value slightly greater than the blanking period.

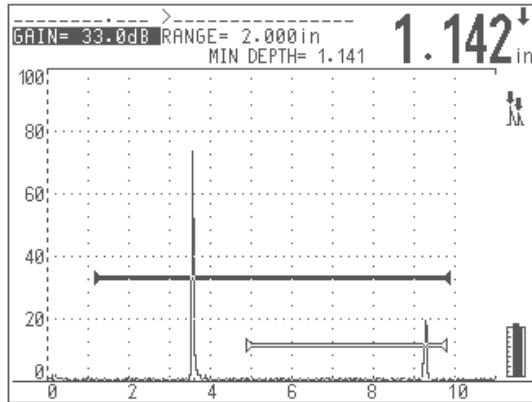

Figure 14 Set-up for Peak-to-Peak Measurement

6.5 Locating Flaws with an Angle Beam Transducer

During an angle beam inspection, you can obtain accurate and reliable soundpath information using the EPOCH 4's high resolution distance calculator.

If a refracted angle is entered into the EPOCH 4, and an echo is exceeding the gate threshold, all angular soundpath components are displayed at the top of the A-Scan display.

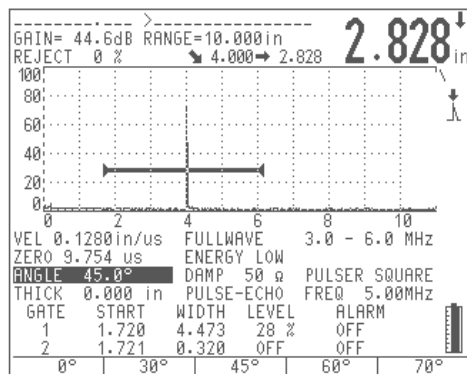





Figure 15 Angle Beam Inspection

These symbols represent the following distances:

-  = angular (soundpath) distance to the reflector
-  = surface distance (projection) to the reflector
-  = depth to the reflector
-  = soundpath leg that the particular reflector is located in – 1st, 2nd, 3rd, 4th, beyond 4th

The selection of the **Measurement** modes (**Peak Depth** or **Edge Depth**), and the ability to toggle the soundpath reading displayed in large text. (See Taking Thickness Readings on page 60.)

Any signal breaking the gate threshold generates the display of soundpath data.

To setup information in the first leg of the soundpath, follow these steps:

1. Enter a value of 0 for material thickness into the EPOCH 4 when calibrating.
2. Press [2nd F], [ANGLE] (THICKNESS).
3. Press [F1] or use [↓] until the thickness value reads 0.00. With this set-up, all soundpath data is treated as if the information is in the first leg.

When working beyond the first leg, it is imperative that you enter an exact thickness of the material into the EPOCH 4. Press [2nd F], [ANGLE] (THICKNESS) and use [↑], [↓], [←], and [→] to enter the proper thickness. You can also use the function keys to quickly select preset values. This value is then used to calculate the depth to a reflector that lies beyond the first leg.

6.6 Measuring Signal Amplitude

When estimating discontinuity size, the instrument is adjusted so that a particular gain setting and screen height represent the echo amplitude produced by a known size reflector in a reference standard. In general, a signal with smaller amplitude may indicate a smaller reflector and a signal with higher amplitude may indicate a larger reflector than the reference standard.

Press [DEPTH/%AMPL] and then [F3] to display a direct on-screen readout of amplitude information.

If an echo exceeds the gate threshold and the EPOCH 4 is in the **Amplitude** mode, the amplitude information for that echo is displayed as a percentage of Full Screen Height as both **Current Amp** and **Amp Max**.

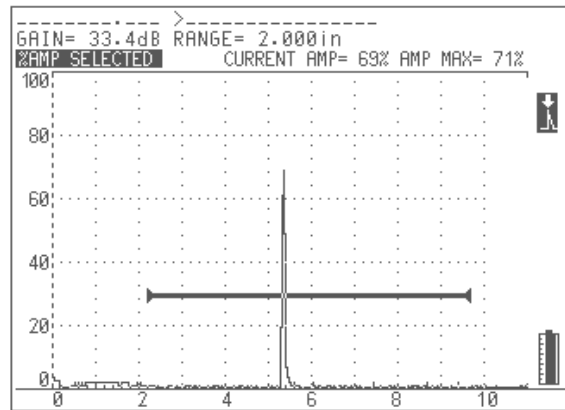

Figure 16 Amplitude Mode Displaying **Current Amp** and **Amp Max**

Current refers to the real time percentage of screen height of the highest amplitude signal within the gate.

The **Amplitude Max** display retains the highest amplitude of a signal that has broken the gate threshold. If a higher amplitude signal is read, the **Amplitude Max** value is updated. Reset the maximum amplitude value by pressing any one of the red gate keys.

If there is no echo within the gate, **Current** will read “ ____% ” indicating no reading was taken.

6.7 Operating Time-of-Flight (TOF) Mode

The EPOCH 4 is capable of displaying Time-of-Flight (TOF) soundpath data for an echo that breaks the gate. Time-of-Flight is the location of the reflector in terms of microseconds (μs).

When the **Time-of-Flight** mode is turned on, all EPOCH 4 distance parameters are displayed using μs values instead of inches or millimeter values.

Note: Unlike all other measurement modes, **Time-of-Flight** mode does NOT divide the reading by two. The entire Time-of-Flight through the test piece in both directions is displayed.

As a reminder, when taking thickness measurements, the EPOCH 4 must divide the product of material velocity and Time-of-Flight by two in order to calculate the thickness of a part. If this is not done, then the unit would display twice the actual thickness because the sound energy passes through the part twice.

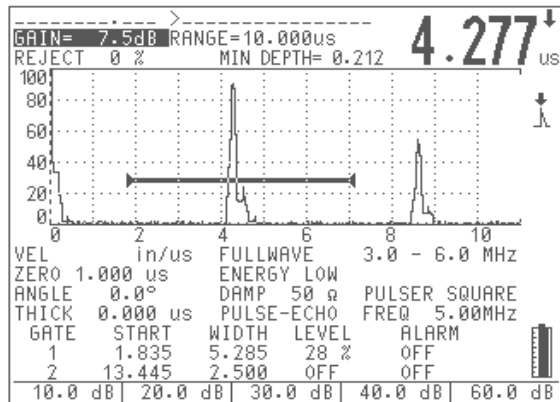

Figure 17 Time-of-Flight Mode Displaying μ s Values

To setup the **Time-of-Flight** mode, follow these steps:

1. Use the **Setup** menu to turn on **Time-of-Flight** mode.
2. Press [**OPTION**].
3. Move the highlight bar over **Setup** and press [**ENTER**].
4. Move the highlight bar over **Unit** and press [**ENTER**].
5. Move the highlight bar over μ s **Full Scale** to view in units full scale, or μ s/**DIVISION** to view in units per division and press [**ENTER**].
6. Press [**OPTION**] to return to the live screen.

6.8 Using the Zoom Feature

To zoom in on an indication, position Gate 1 over the area of interest and press [**2nd F**], [**RANGE**] (**ZOOM**). The instrument automatically uses screen delay to bring the point that corresponds to the gate start to the screen's left side and also adjusts the displayed range to match the gate width. The new range equals the unzipped gate width. The lowest achievable value of the expanded range is equivalent to the minimum range of the instrument at the current material velocity setting.

Flaw Detection

Zoom is useful in certain flaw detection applications. For example, when detecting branches of cracking such as inter-granular stress corrosion cracking (IGSCC); the inspector's job can be complicated by the geometry of the test specimen and also by the specific characteristics of the defect itself. In instances where the pipe counterbore is close to the weld root, it is possible to have three signals that all appear quite close to each other; from the weld root, the counterbore, and the crack itself. Use the **Zoom** function to improve the visual resolution of the EPOCH 4's display so that each individual signal can be more easily identified.

When evaluating a crack signal, the inspector's attention is usually focused on the leading edge of an indication. By observing the number and location of small peaks along the leading edge of the signal, it is possible to make some assumptions regarding the presence and location of different branches of cracking. Use the **Zoom** function to get a much more detailed view of an indication and thus make better judgements regarding flaw location and depth.

Zoom is useful when inspecting particularly large or thick components when detail is lost due to using long screen ranges. Use the **Zoom** function to look at small sections of the test piece without disturbing the instrument's original calibration.

6.9 Activating Gate Alarms

The EPOCH 4 features a variety of alarm configurations that can be used in either the **Single** or **Dual Gate** modes. An alarm on Gate 2 can only be set if Gate 2 is turned on by pressing [GATE 2] and then pressing [F4] for ON.

6.9.1 Threshold Alarms

Threshold alarms can be set on Gate 1 and/or Gate 2.

To set a threshold alarm on Gate 1, follow these steps:

1. Press [GATE 1] and use the start, width, and level parameters to position the gate over the desired area.
2. Press [2nd F], [GATE 1] (ALARM 1). The alarm choices are displayed in the function boxes at the bottom of the screen.
3. Press [F1] for positive logic or [F2] for negative logic. A negative logic alarm indicates a signal is absent from the gate. A positive logic alarm indicates a signal is present within the gate. Either Gate 1 or Gate 2 can be set positive or negative.

Once a threshold alarm is activated, markers at the starting and ending points of the gate will point upwards or downwards to indicate which type of alarm has been set.

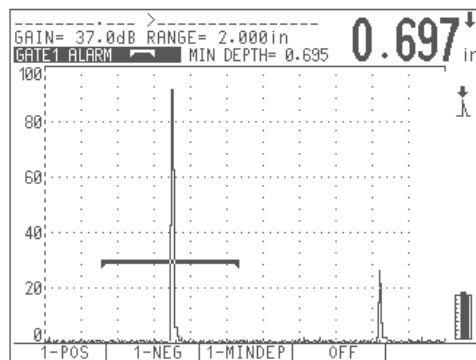

Figure 18 Negative Logic Alarm

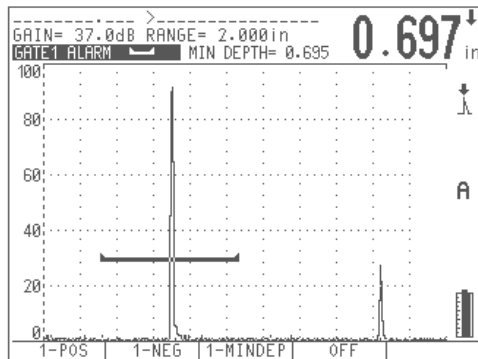

Figure 19 Positive Logic Alarm

4. Press [2nd F], [GATE 1] (ALARM 1) and then press [F4] for OFF to shut off Gate 1 alarm.
5. Press [2nd F], [GATE 2] (ALARM 2) and then press [F4] for OFF to shut off Gate 2 alarm.

6.9.2 Minimum Depth Alarm

The EPOCH 4 is equipped with a minimum depth alarm, which is triggered whenever the current thickness reading falls below an operator defined level. Use the minimum depth alarm with a single gate or in the **Echo-to-Echo Measurement** mode. In Echo-to-Echo, the cursor appears on the second gate. A cursor appears at the bottom of Gate 2 to indicate this level.

6.9.3 Minimum Depth Alarm with a Single Gate

Minimum depth alarms can be set on Gate 1 and/or Gate 2.

To set a minimum depth alarm on Gate 1, follow these steps:

1. Press [GATE 1] and use the start, width, and level parameters to position the gate over the desired area. Be sure the gate start position is set to cover a range below the minimum depth alarm value.
2. Press [2nd F], [GATE 1] (ALARM 1) to display the alarm choices in the function boxes at the bottom of the screen. Press [F3] to activate the minimum depth alarm.
3. Use the [↑], [↓], [←], and [→] keys to set the desired minimum value. The range of minimum depth values is limited by the gate start and width settings. The minimum depth alarm value must be greater than the gate start value and less than the gate width value. Once activated, a marker appears on the gate to indicate the current setting. Any indication that exceeds the gate threshold to the left of the marker will activate the alarm.
4. Press [2nd F], [GATE 1] (ALARM 1) and then press [F4] to shut off the alarm.

6.9.4 Minimum Depth Alarm in the Echo-to-Echo Measurement Mode

Use the minimum depth alarm when making Echo-to-Echo thickness readings. In the **Echo-to-Echo** mode the minimum depth marker appears on Gate 2.

To set the minimum depth alarm when in the **Echo-to-Echo** mode, follow these steps:

1. Position Gate 1 and Gate 2 over the desired areas (See Taking Echo-to-Echo Thickness Readings on page 61.) Be sure the start position of Gate 2 is set to cover a range below the minimum depth value that will be used for the alarm.
2. Press [2nd F], [DEPTH/%AMP] (**ECHO-ECHO**) to activate the **Echo-to-Echo Measurement** mode.
3. Press [2nd F], [GATE 2] (**ALARM 2**) to activate the alarm.
4. Press [F3] to select the minimum depth alarm.
5. Use the [↑], [↓], [←], and [→] keys to set the desired minimum value. The range of minimum depth values is limited by the start and width settings of both gates. Gate 1 must be positioned to detect the first back echo. Also, the minimum depth alarm value must be greater than the blank period between Gate 1 and Gate 2 and less than the Gate 2 width value.

6.9.5 Alarm Condition Storage

When an alarm is active, a capital letter A flashes to the right of the A-Scan. Alarm conditions can be saved in the EPOCH 4's datalogger. All data with an alarm is flagged in the memory by the character "@" prior to the ID.

7 Calibrating the EPOCH 4

This chapter describes how to calibrate the EPOCH 4. Calibration is the process of adjusting the unit so that it measures accurately on a particular material, using a particular transducer at a particular temperature. You must adjust the **Zero Offset** and **Velocity** parameters of the EPOCH 4 during calibration. **Zero Offset** (sometimes referred to as probe delay) compensates for the dead time between the firing of the Main Bang and the entry of the sound into the test piece. The unit must be programmed with the correct **Velocity** setting so that it matches the material velocity of the test piece.

The EPOCH 4 has an advanced Auto-Calibration feature, which provides for a fast and easy calibration process. The following sections detail the procedure to calibrate the EPOCH 4 when using the four basic transducers configurations: straight beam, delay line, dual element, and angle beam.

Note: Do **NOT** use the Auto-Calibration feature when the EPOCH 4 is in the following modes:

- Microsecond Time-Of-Flight Mode
- DAC
- TVG
- BSCAN

Topics are as follows:

- Getting Started
- Calibrating with a Straight Beam Transducer
- Calibrating with a Delay Line Transducer
- Calibrating with a Dual Element Transducer
- Calibrating with an Angle Beam Transducer

7.1 Getting Started

Until you are completely comfortable operating the EPOCH 4, we recommend that a basic review and set-up procedure be used prior to starting the actual calibration. The split-screen feature of the EPOCH 4 is useful for this as it lets you simultaneously view the waveform display and all instrument calibration data.

To setup the EPOCH 4 before calibrating, follow these steps:

1. Press **[DISPLAY]** to select the split screen display.
2. Press **[2nd F]**, **[VEL] (REJECT)** to set the reject level to 0%. Press **[F1]** or use the **[↓]** slewing key to adjust the value to zero.
3. Press **[GAIN]** to select an initial gain value that is appropriate for the calibration and adjust the value by using the direct access function keys or the **[↑]** and **[↓]** keys. If the appropriate gain level is unknown, set the initial gain at 30dB and adjust it as necessary during calibration.

4. Press **[VEL]** to enter an approximate velocity for the test material and adjust the value with the function keys or the **[↑]** and **[↓]** keys. If the velocity value is unknown, find a starting value in the velocity in Appendix IV of this manual.
5. Press **[RANGE]** to set the range and then adjust the value using the function keys or the **[↑]**, **[↓]**, **[←]**, or **[→]** keys.
6. Press **[2nd F]**, **[ANGLE] (THICKNESS)** to set the material thickness to 0.00" or 0.00mm. Press **[F1]** or use the **[↓]** key to adjust the value to zero.
7. Press **[ZERO OFFSET]** to set the zero offset value to 0.00μSec. Press **[F1]** or use the **[↓]** or **[→]** keys to bring the initial pulse to the left hand side of the instrument screen.
8. Press **[ANGLE]** to enter the correct refracted angle for the probe (0 for a straight beam or 90° probe, 45 for a 45°, etc.) Use the function keys to access preset values or adjust in 0.1 degree adjustments using the **[↑]** and **[↓]** keys.
9. Once the transducer is coupled to the block, adjust the pulser and filter settings to create a clean A-Scan. Press **[PULSER]** multiple times to allow access to the various pulser and filter functions. Alternately, press **[2nd]**, **[PULSER] (FILTER)** to go directly to the filter settings. Adjust each function with the function keys or the **[↑]**, **[↓]**, **[←]**, and **[→]** keys.

Note: Refer to Chapter 4 for information on how to set the pulser and filter parameters.

7.2 Calibrating with a Straight Beam Transducer

Use Panametrics-NDT transducer part number A109S-RM, with a frequency of 5.0MHz and an element diameter of 0.50" (13mm) to perform the sample Straight Beam calibration. The calibration requires the a test block with two known thicknesses, made from the material to be measured. Ideally the two thicknesses should represent thicknesses that are both below and above the expected thickness of the material being inspected.

For this example, we are using Panametrics-NDT standard 5-step steel test block part number 2214E. The steps measure 0.100", 0.200", 0.300", 0.400", and 0.500".

Note: If the EPOCH 4 is set to metric units, the calibration process is exactly the same, except that the entries below will be in millimeters, rather than inches.

To calibrate using a Straight Beam transducer, follow these steps:

1. Follow the initial set-up procedure outlined above. Connect the transducer to an appropriate cable and then connect the cable to either of the transducer posts on the EPOCH 4.
2. Press **[CALIBRATION]**. A Cal symbol appears to the right of the A-Scan, signifying the EPOCH 4 is in the **Auto-Calibration** mode. (To exit the **Auto-Calibration** mode at any point, press **[ENTER]**.)
3. Couple the transducer to the THIN calibration block step. For this example, the transducer is coupled to the 0.200" step (depending on the frequency of the contact

transducer being used, it may be impossible to obtain a proper reading on a very thin material).

4. Position Gate 1 so that the first backwall echo from the known thickness step is exceeding the gate threshold. Adjust the gain setting so that the echo amplitude is approximately 80%.

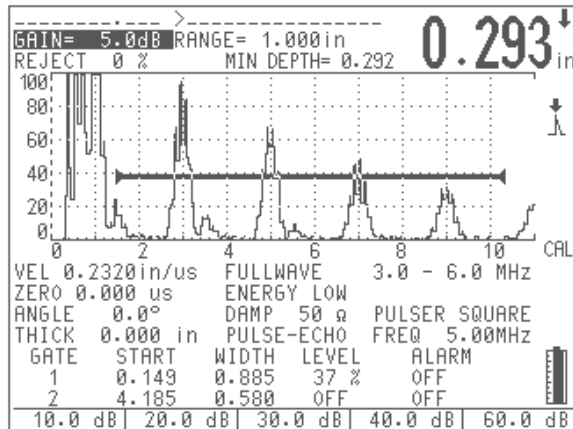

Figure 20 Calibrating for a Thin Block Using a Straight Beam Transducer

5. A thickness reading appears in large text above the A-Scan. Once a steady reading is achieved, press **[ZERO OFFSET]**. The screen freezes and a pop-up box appears on the screen.

Use the alphanumeric keypad to enter the exact known thickness of the test sample. For this example, press **[2]**, **[0]**, **[0]**. The entry appears in the pop-up box.

If you enter an incorrect number, press **[0]** multiple times to clear the entry and then type in the correct thickness.



Figure 21 Entering a Thin Standard Value

6. Press **[CALIBRATION]**. The display returns to the live A-Scan. Couple the transducer to the THICK calibration block step. For this example, the transducer is coupled to the 0.500" step.
7. Position Gate 1 so that the first backwall echo from the known thickness step is exceeding the gate threshold. Adjust the gain setting so that the echo amplitude is approximately 80%.

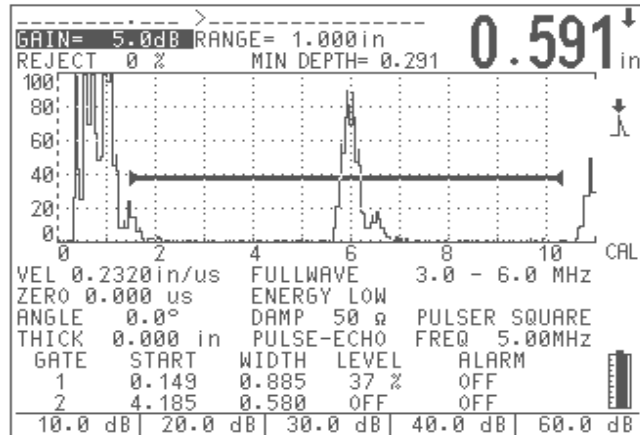

Figure 22 Calibrating for a Thick Block Using a Straight Beam Transducer

- A thickness reading appears in large text above the A-Scan. Once a steady reading is achieved, press [VEL]. The screen freezes and a pop-up box appears again on the screen.

Use the alphanumeric keypad to enter the exact known thickness of the test sample. For this example, press [5], [0], [0]. The entry appears in the pop-up box.

If you enter an incorrect number, press [0] multiple times to clear the entry and then type in the correct thickness.



Figure 23 Entering a Thick Standard Value

- Press [ENTER] to complete the Auto-Calibration. The **Zero Offset** and **Velocity** parameters adjust automatically and the correct thickness reading of any gated echo displays on the screen.

Note: It is possible to use the Auto-Calibration feature on a single test block of known thickness. You can use multiple backwall echoes instead of coupling on both a thin step and a thick step. You can leave the transducer coupled on the thin step, move the gate over to one of the multiple backwall echoes and enter the correct soundpath thickness (2, 3, 4, etc. multiple of the first backwall echo) during the velocity portion of the calibration.

7.3 Calibrating with a Delay Line Transducer

The sample delay line calibration described below is performed using Panametrics-NDT transducer part number V202-RM, with a frequency of 10.0MHz and an element diameter of 0.25" (6mm). The calibration requires a test block with two known thicknesses, made from the material to be measured. Ideally, the two thicknesses measurements are both below and above the expected thickness of the material to be inspected.

For this example, we are using Panametrics-NDT standard 5-step steel test block part number 2214E. The steps measure 0.100", 0.200", 0.300", 0.400", and 0.500".

Note: If the EPOCH 4 is set to work in metric units, the calibration process is exactly the same, except that the entries below will be in millimeters, rather than inches.

To calibrate using a Delay Line transducer, follow these steps:

1. Follow the initial set-up procedure outlined in Section 7.2.

Connect the transducer to an appropriate cable and then connect the cable to either of the transducer posts on the EPOCH 4. With a Zero Offset of 0.000 μ s, the Main Bang (or excitation pulse) should appear on the left side of the screen.

Increase the Zero Offset until the Main Bang moves off the left side of the screen and the interface echo from the end of the delay line tip appears on the screen.

Verify that the echo represents the end of the delay by tapping your finger on the end of the couplant-coated delay line. This dampens the signal and the echo should jump up and down on the screen. Use the Zero Offset to move this echo to the left side of the screen so that it is barely visible.

2. Press [**CALIBRATION**]. A **Cal** symbol will appear to the right of the A-Scan, signifying the EPOCH 4 is in the **Auto-Calibration** mode. (To exit the **Auto-Calibration** mode at any point, press [**ENTER**].)
3. Couple the transducer to the THIN calibration block step. For this example, the transducer will be coupled to the 0.100" step.
4. Position Gate 1 so that the first backwall echo from the known thickness step is exceeding the gate threshold. Adjust the gain setting so that the echo amplitude is approximately 80%. A thickness reading appears in large text above the A-Scan.

Note: Make sure it is the first backwall echo being gated, not a multiple echo from the end of the delay line tip.

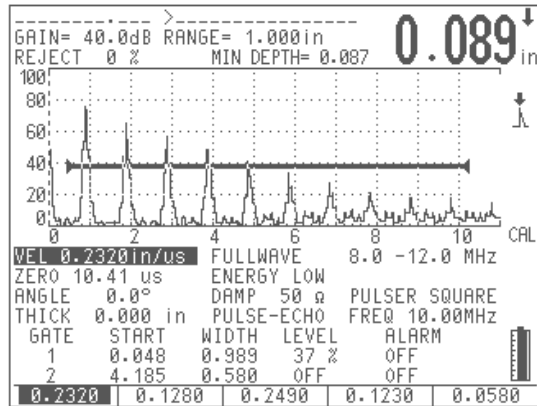

Figure 24 Calibrating for a Thin Block Using a Delay Line Transducer

5. Press [**ZERO OFFSET**] once the reading is steady. The screen freezes and a pop-up box appears on the screen.

Use the alphanumeric keypad to enter the exact known thickness of the test sample. For this example, press [**1**], [**0**], [**0**]. The entry appears in the pop-up box.

If you enter an incorrect number, press [**0**] multiple times to clear the entry and then type in the correct thickness.



Figure 25 Entering a Thin Standard Value

6. Press [**CALIBRATION**]. The display returns to the live A-Scan. Couple the transducer to the THICK calibration block step. For this example, the transducer is coupled to the 0.500" step.
7. Position Gate 1 so that the first backwall echo from the known thickness step is exceeding the gate threshold. Adjust the gain setting so that the echo amplitude is approximately 80%. A thickness reading appears in large text above the A-Scan.

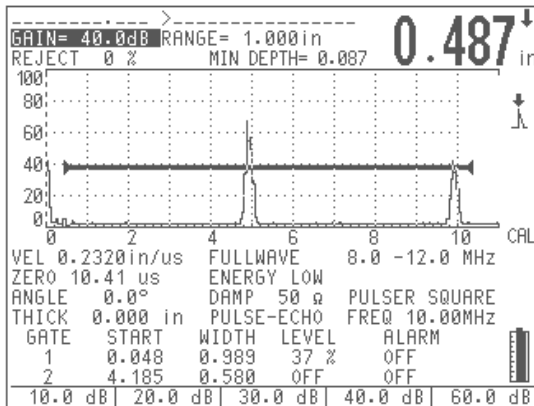

Figure 26 Calibrating for a Thick Block Using a Delay Line Transducer

8. Press [VEL] once the reading is steady. The screen freezes and a pop-up box appears again on the screen.

Use the alphanumeric keypad to enter the exact known thickness of the test sample. For this example, press [5], [0], [0]. The entry appears in the pop-up box.

If you enter an incorrect number, press [0] multiple times to clear the entry and then type in the correct thickness.



Figure 27 Entering a Thick Standard Value

9. Press [ENTER] to complete the Auto-Calibration. The **Zero Offset** and **Velocity** parameters adjust automatically, and the correct thickness reading of any gated echo is displayed on the screen.

Note: It is possible to use **Auto-Calibration** on a single test block of known thickness. You can use “multiple backwall echoes” instead of coupling on both a thin step and a thick step. You can leave the transducer coupled on the thin step, and instead move the gate over to one of the multiple backwall echoes and enter the correct soundpath thickness (2, 3, 4, etc. multiple of the first backwall echo) during the velocity portion of the calibration.

7.4 Calibrating with a Dual Element Transducer

The sample delay line calibration described below is performed using Panametrics-NDT transducer part number DHC711-RM, with a frequency of 5.0MHz and an element

diameter of 0.25" (6mm). The calibration requires a test block with two known thicknesses, made from the material to be measured. Ideally, the two thicknesses should represent thicknesses that are both below and above the expected thickness of the material to be inspected.

For this example, we are using Panametrics-NDT standard 5-step steel test block part number 2214E. It has steps measuring 0.100", 0.200", 0.300", 0.400", and 0.500".

Note: If the EPOCH 4 is set to work in metric units, the calibration process is exactly the same, except that the entries below will be in millimeters, rather than inches.

Note: Due to acoustic characteristics of dual transducers, a non-linearity in the distance calibration occurs as the thickness of the material decreases. The point of maximum sensitivity is determined by the "roof angle" of the particular dual transducer. We recommend that the distance calibration is carried out using a step block that covers the range of interest. Be careful interpreting thickness readings made outside the calibrated range. The EPOCH 4 does not have V-Path Correction, therefore, there may be some non linearity within the calibrated range depending on the minimum thickness used in the calibration process.

The zero offset value of dual element transducers can vary significantly at extreme temperatures. If the temperature changes more than a few degrees from the temperature at which the zero offset value was established, re-check its value. If thickness measurements are to be made over a wide temperature range, we strongly recommend the use of Panametrics-NDT dual transducers that are designed for high temperature applications. These have built in delay lines with a stable sound velocity that does not change significantly with temperature. Specific recommendations are Panametrics-NDT D790-SM and D791 dual element transducers.

To calibrate using a Dual Element transducer, follow these steps:

1. Follow the initial set-up procedure outlined in Section 7.2.

Connect the transducer to an appropriate cable and then connect the cable to the transducer posts on the EPOCH 4. Change the **Test** mode to **Dual**. Also when using a dual element transducer, the Gain setting is generally set very high so that the leading edge of the backwall echoes appear as near vertical lines on the screen. The leading edge is then used when making thickness measurements. For this reason, the EPOCH 4 should be set to **EDGE Detection** mode.

2. Press [**CALIBRATION**]. A Cal symbol appears to the right of the A-Scan, signifying the EPOCH 4 is in the **Auto-Calibration** mode. (To exit the **Auto-Calibration** mode at any point, press [**ENTER**].)
 3. Couple the transducer to the THIN calibration block step. For this example, the transducer will be coupled to the 0.100" step. As noted above, a higher Gain setting is required to produce a clean leading edge of the signal. Do not be concerned with the jagged peaks of the echo. Concentrate on the leading edge only.
-

- Position Gate 1 so that the leading edge of the backwall echo from the known thickness step is exceeding the gate threshold. A thickness reading appears in large text above the A-Scan.

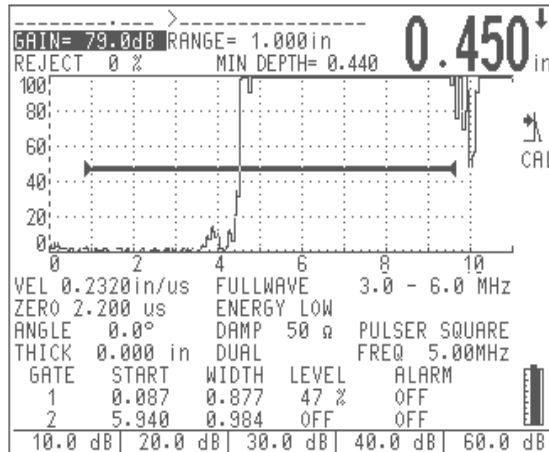

Figure 28 Calibrating for a Thin Block Using a Dual Element Transducer

- Press [**ZERO OFFSET**] once the reading is steady. The screen freezes and a pop-up box appears on the screen.

Use the alphanumeric keypad to enter the exact known thickness of the test sample. For this example, press [**1**], [**0**], [**0**]. The entry appears in the pop-up box.

If you enter an incorrect number, press [**0**] multiple times to clear the entry and then type in the correct thickness.



Figure 29 Entering a Thin Standard Value

- Press [**CALIBRATION**]. The display returns to the live A-Scan. Couple the transducer to the THICK calibration block step. For this example, the transducer is coupled to the 0.500" step.
- Position Gate 1 so that the leading edge of the backwall echo from the known thickness step is exceeding the gate threshold. A thickness reading appears in large text above the A-Scan.

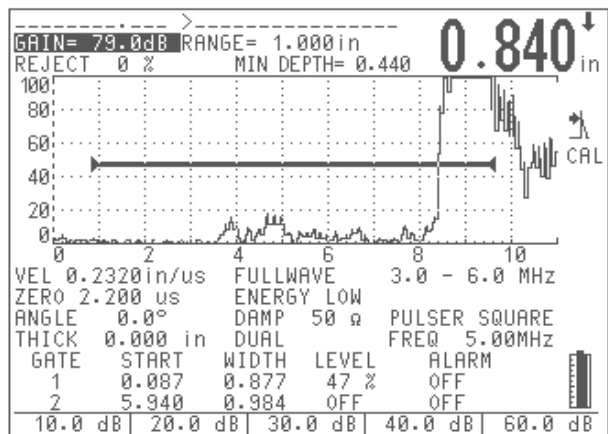

Figure 30 Calibrating for a Thick Block Using a Dual Element Transducer

8. Press [VEL] once the reading is steady. The screen freezes and a pop-up box appears again on the screen.

Use the alphanumeric keypad to enter the exact known thickness of the test sample. For this example, press [5], [0], [0]. The entry appears in the pop-up box.

If you enter an incorrect number, press [0] key multiple times to clear the entry and then type in the correct thickness.



Figure 31 Entering a Thick Standard Value

9. Press [ENTER] to complete the **Auto-Calibration**. The **Zero Offset** and **Velocity** parameters adjust automatically, and the correct thickness reading of any gated echo is displayed on the screen.

7.5 Calibrating with an Angle Beam Transducer

The sample angle beam calibration described below is performed using Panametrics-NDT transducer part number A1420S-SB, with a frequency of 2.25MHz and an element diameter of 0.625" x 0.625". The transducer is mounted on a 45° wedge, part number ABWS-6-45. We recommend using either an ASTM E-164 IIW Type I or a U.S. Air Force IIW Type II Calibration Block for this calibration procedure. The steps below use Panametrics-NDT IIW Type I carbon steel calibration block, part number TB7541-1.

To calibrate using an Angle Beam transducer, follow these steps:

1. Follow the initial set-up procedure outlined in Section 7.2.

Connect the transducer to an appropriate cable and then connect the cable to either of the transducer posts on the EPOCH 4.

2. Enter the correct refracted angle for the transducer/wedge combination. For this example, enter 45° .
3. Enter the approximate shear wave velocity of the material being inspected. For this example using carbon steel, enter a velocity of $0.1280\text{in}/\mu\text{s}$ ($3251\text{mm}/\mu\text{s}$ if working in metric units).
4. Enter an appropriate range for the test block being used. For this example, enter a range of 10.000in (250.00mm if working in metric units).

Review sections 7.5.1 - 7.5.4 for the following procedures:

- Locating the Beam Index Point (B.I.P.) of the probe
- Verifying the Refracted Angle (Beta)
- Calibrating for Distance
- Calibrating for Sensitivity

Note: If the EPOCH 4 is set to work in metric units in each procedure listed above, the calibration process is exactly the same, except that the entries below will be in millimeters, rather than inches.

7.5.1 Locating the Beam Index Point (B.I.P.)

To locate the BIP, follow these steps:

1. Couple the probe to the test block at the “0” mark.

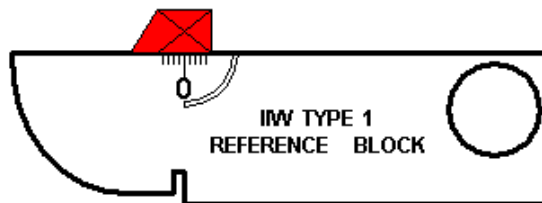

Figure 32 Reference Block Displaying the “0” Mark

2. Manipulate the probe until a high amplitude signal appears on the screen after the Main Bang. This is the reflection from the large arc of the block that is located on the Type I block at 4" (100mm).
3. Move the probe forward and backward to bring the echo to its maximum amplitude (peak it up). Make sure the echoes do not exceed 100%. Reduce the Gain setting if necessary.

Note: The **Peak Memory** feature on the EPOCH 4 is an excellent tool to aid in finding the BIP. Press **[PEAK MEM]** to turn on the feature. This feature

draws and collects the echo envelope of the signal while also drawing the live waveform. Match the live waveform with the maximum point corresponding to the previously accumulated echo dynamic curve. Refer to the figure above for a detailed schematic of using the **Peak Memory** feature to find the BIP. Press **[PEAK MEM]** again to turn off the feature.

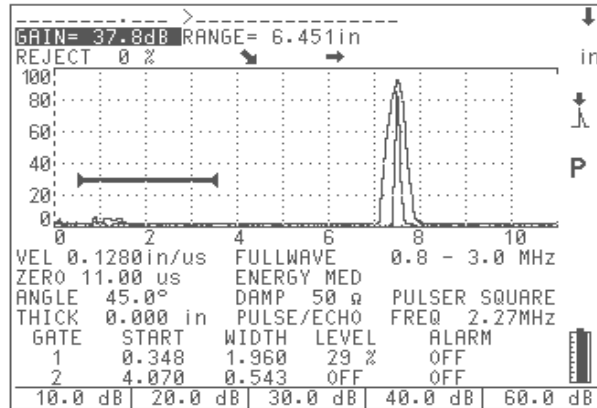

Figure 33 Locating the Beam Index Point

4. Hold the probe stationary once you have peaked up the signal, and mark the side of the transducer's wedge directly over the "0" mark on the block. This is the BIP – the point at which the sound leaves the wedge and enters the material with maximum energy.

7.5.2 Verifying the Refracted Angle (Beta)

The refracted angle of the probe should already have been previously entered into the EPOCH 4 in the initial steps of the calibration procedure. Although the wedge may be marked 45° , for example, the actual refracted angle may be slightly different due to the properties of the test material or the amount of wear on the wedge. It is necessary to verify the actual angle. This ensures the EPOCH 4's soundpath calculations are accurate.

To verify the refracted angle, follow these steps:

1. Position the probe over the appropriate angle mark on the block, which is 45° for this example.

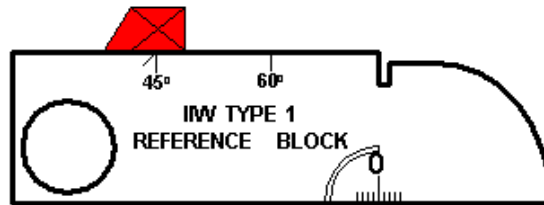

Figure 34 Verifying the Refracted Angle

2. Move the probe backward and forward to “peak up” the echo coming from the large circular hold in the side of the block. The circular hole may be filled with Plexiglas, but the procedure is the same.

Tip: The **Peak Memory** feature on the EPOCH 4 is an excellent tool to aid in finding the peak of the signal.

3. Hold the probe stationary once you have peaked up the signal. Note the degree mark on the block that lines up with the BIP, which you marked on the side of the wedge in the previous step. This is the actual refracted angle (Beta) for this particular transducer and wedge in steel.

If this value for Beta differs from the value entered previously, enter the corrected angle now via the [ANGLE] key and the [↑], [↓], [←], and [→] keys.

7.5.3 Calibrating for Distance

Note: This step differs depending on which type of IIW calibration block is used. The ASTM E-164 IIW Type I Block, which has a crescent cut in the side, produces echoes at 4" (100mm) and 9" (225mm) on the screen. The U.S. Air Force IIW Type II Block, which has a large cutout in the side, produces echoes at 2" and 4" on the screen. The procedure below uses Panametrics-NDT IIW Type I carbon steel calibration block, part number TB7541-1.

We recommend that the EPOCH 4's Range parameter be set to 10" (250mm) for this step. Regardless of whether a Type I or Type II Calibration block is used, this should ensure that the echoes from the block are visible on screen.

To calibrate for distance, follow these steps:

1. Couple the probe to the block so that the BIP is directly over the “0” mark on the ASTM test block (or the Air Force block.) **Do not move the transducer from this point during this step.**
2. Press [CALIBRATION]. A Cal symbol appears to the right of the A-Scan, signifying the EPOCH 4 is in the **Auto-Calibration** mode. (To exit the **Auto-Calibration** mode at any point, press [ENTER].)

3. Position Gate 1 so that the echo reflection from the 4" arc (this should be the first large echo after the Main Bang) is exceeding the gate threshold.
4. Adjust the gain setting so that the echo amplitude is approximately 80%. A thickness reading appears in large text above the A-Scan.

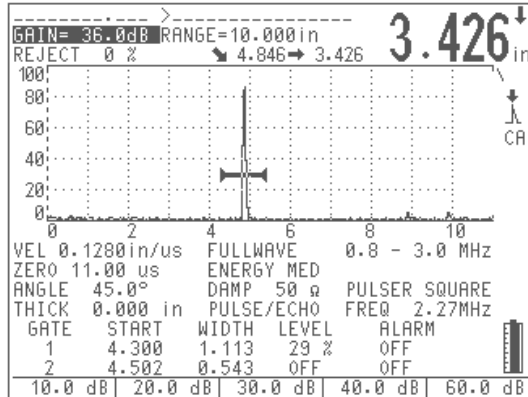

Figure 35 Calibrating for Distance

5. Press [**ZERO OFFSET**] once the reading is steady. The screen freezes and a pop-up box appears on the screen.

Use the alphanumeric keypad to enter the exact known soundpath distance for this arc. For this example, press [4], [0], [0], [0]. The entry appears in the pop-up box.

If you enter an incorrect number, press [0] multiple times to clear the entry and then type in the correct thickness.



Figure 36 Entering a Thin Standard Value

6. Press [**CALIBRATION**]. The display returns to the live A-Scan. Position Gate 1 so that the echo from the 1" crescent is exceeding the gate threshold. This echo is generally located at approximately the ninth or tenth screen division, and usually the 3rd echo after the Main Bang.
7. Adjust the Gain setting so that this echo amplitude is approximately 40%. A thickness reading appears in large text above the A-Scan.

Note: Another echo may be present on the screen at approximately the eighth or ninth screen division. Disregard this echo as it is usually the result of beam spreading and sound bouncing off the side of the block. Make sure Gate 1 is not over this echo.

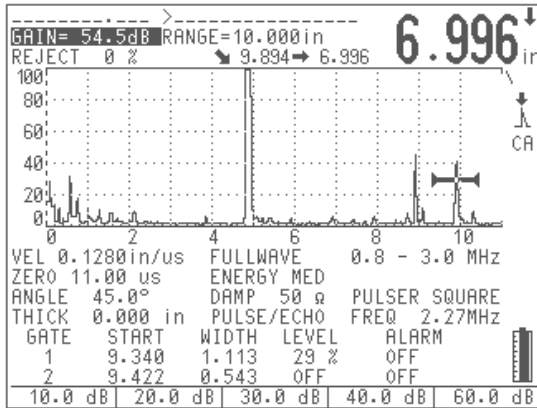

Figure 37 Adjusting the Gain

- Press [VEL] once the reading is steady. The screen freezes and a pop-up box appears again on the screen.

Use the alphanumeric keypad to enter the exact known soundpath distance for this crescent. For this example, press [9], [0], [0], [0].

The entry appears in the pop-up box. If you enter an incorrect number, press [0] multiple times to clear the entry and then type in the correct thickness.



Figure 38 Entering a Thick Standard Value

- Press [ENTER] to complete the **Auto-Calibration**. The **Zero Offset** and **Velocity** parameters adjust automatically, and the correct soundpath readings of any gated echoes are displayed on the screen.

7.5.4 Calibrating for Sensitivity

The final step in the angle beam calibration is to calibrate for sensitivity. This lets you set up a reference gain level.

- Couple the probe to the IIW calibration block so that the transducer is aimed at the 0.060" diameter side drilled hole, which is used as a reference reflector.

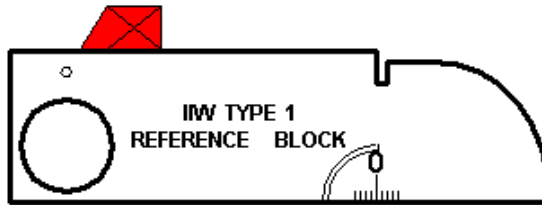

Figure 39 IIV Calibration Block with 0.060" Diameter Drilled Hole

2. Move the probe forward and backward until you have “peaked up” the return signal from the hole (i.e. found the maximum amplitude.) Do not confuse the reference reflector echo from the side of the block.

Tip: The **Peak Memory** feature on the EPOCH 4 is an excellent tool to aid in finding the peak of the signal.

3. Adjust the system sensitivity (Gain) up or down once the echo is peaked up to bring the reference reflector signal to a predetermined reference line on the screen. In this example, the echo is brought to 80% of full screen height.
4. Press [**2nd F**], [**GAIN**] (**REF**) to lock in the reference gain level and add/subtract scanning gain separately.
5. Press the function keys once the reference gain functions are activated to select between adding or subtracting in 0.1dB or 6.0dB increments.

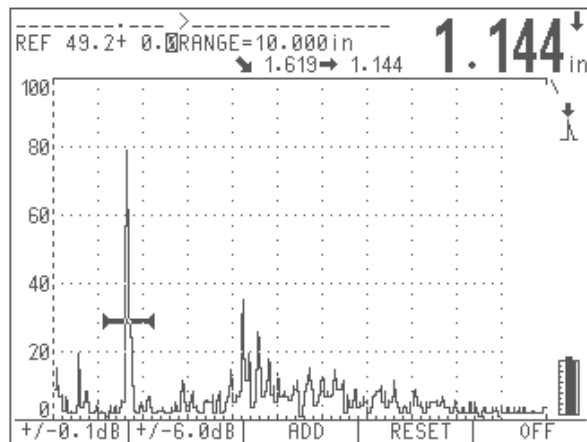

Figure 40 Locking the Reference Gain to Add/Subtract Scanning Gain

8 Managing the Datalogger and Data Communication Features

This chapter describes how to manage the EPOCH 4's sophisticated datalogger. Panametrics-NDT has designed the datalogger for ease of use while providing a wide range of features for virtually all flaw detection and thickness gaging requirements. It includes the following capabilities:

- Data organized by file and identifier (ID) code
- Alphanumeric file names and identifier codes
- Memo mode to allow entry of detailed comments
- Edit feature for adding, deleting, and clearing of individual file names and IDs
- On-screen scroll/review of all file contents
- Quick recall of stored setups
- Ability to transfer data between the unit and a PC or printer

Topics are as follows:

- Defining the Datalogger Storage Capacity
- Using the Memory Screen
- Using the Alphanumeric Keypad
- Creating New Files and Identifier (ID) Codes
- Saving Waveforms and Thickness Readings
- Incrementing ID Codes
- Recalling Transducer Calibrations and Waveforms
- Saving and Recalling Quick Recall Calibrations
- Creating Memos
- Editing a File
- Printing

8.1 Defining the Datalogger Storage Capacity

The EPOCH 4's datalogger is designed to store the following data:

- **Thickness Reading**
 - Identifier (ID) code
 - Alarm conditions
 - Peak/Edge Depth Mode Indicator

-
- Soundpath leg of measurement
 - Thickness/Soundpath values (**Edge** or **Peak Depth** mode), Current and Maximum Amplitude data (**Amplitude** mode), or Time-of-Flight data (**Microsecond** mode).
 - **Complete Waveform/Parameter Setup**
 - All data listed in the **Thickness Reading** section
 - Waveform screen
 - Peak Memory echo envelope or Peak Hold frozen waveform (if selected)
 - Complete setup parameters
 - Flag status (Freeze, Zoom, Peak Memory, etc.)
 - **Memo**
 - User defined Memo typed in via alphanumeric keypad

The EPOCH 4's datalogger can store a maximum combination of 10,000 thickness readings or 500 waveforms.

Note: A software option is available to increase the storage capacity to 40,000 thickness readings or 2,000 waveforms. (See Expanded Memory on page 126.)

The EPOCH 4 can save information in 500 separate files. The first nine files are fixed files meaning that each file can only store one complete waveform/parameter setup with an associated identifier (ID) code. This structure allows a quick recall for up to nine calibration setups (See Saving and Recalling Quick Recall Calibrations on page 92.) This is useful when an operator changes transducers during an inspection and needs to recall the associated stored calibration.

Files 10-500 are flexible files, which can store numerous thickness readings, waveforms, and memos. Thickness, waveform data, and memos can all coexist in the same file. Calibration waveform/parameter setups can also be stored in these files and recalled to the live screen, although it requires an extra key press to do this (See Saving Waveforms and Thickness Readings on page 89.)

All the keys on the EPOCH 4's alphanumeric keypad are in a common section on the right side of the main keypad. Press [#] to allow access to the first function key presses (0, 1, 2, 3, 4, 5, 6, 7, 8, 9, ID.) Press [ALPHA] to allow access to the second function key presses (Delete, the 26 letters of the Roman alphabet, and a variety of mathematical Symbols.)

8.2 Using the Memory Screen

To enter the *Memory* screen, press . The *Memory* screen is split into two windows.

- **Lower window:** displays a directory of files
- **Upper window:** displays the file contents

To toggle between the two windows, press [F1]. Other function key prompts appear when applicable.

The remaining number of thickness or waveform availability are displayed between the **File Content** and **File Directory** windows. Press [F5] to exit and return to the live screen.

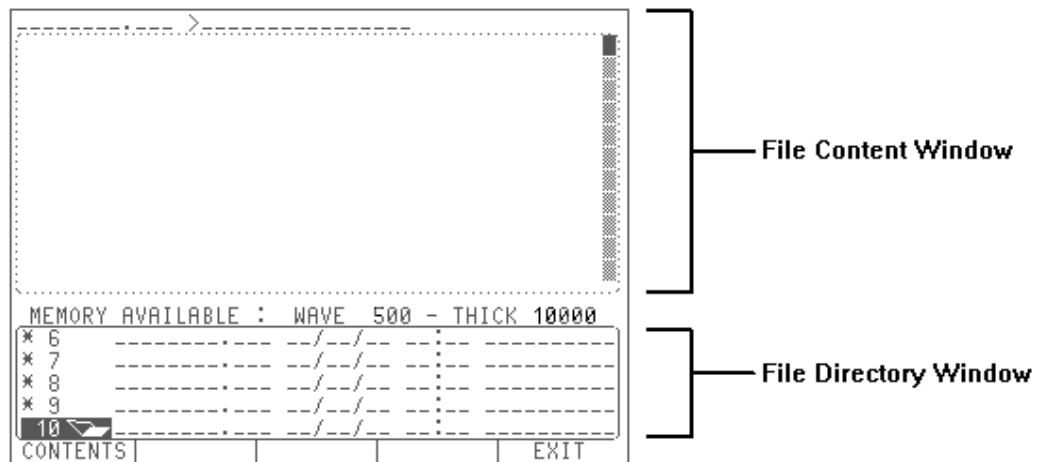

Figure 41 Memory Screen (no stored files)

8.3 Using the Alphanumeric Keypad

The EPOCH 4's datalogger can be used for thorough documentation of inspection data by entering alphanumeric strings in the following ways:

- To enter file names, extensions, dates, times, and notes
- To enter identifier (ID) location codes for thickness or A-Scan data
- To enter memos

To enter numbers, follow these steps:

1. Press [#] to put the EPOCH 4 in **Numeric Entry** mode. A flashing "■" appears.
2. Press any numeric key to enter the selected digit. The cursor automatically advances one position to the right.
3. Use the [<] or [>] keys to skip spaces or move the cursor back to re-enter over an existing character.

To enter letters, follow these steps:

1. Press [ALPHA] to begin entry of alpha characters. A flashing "___" appears.
2. Press the corresponding number where the letter exists. There are two or three letter choices per key. Choose the correct letter by pressing the key multiple times. For example, to enter the letter A, press the [2] key once. To enter the letter C, press the [2] key three times.

3. Use the [<] or [>] keys to skip spaces or move the cursor back to re-enter over an existing character.
 - a. To avoid having to continuously use the [>] key when entering letters, an automatic advance is built into the **Alpha** mode. (This sequence does not apply when editing data.) Any letters that are not over the same key can be entered directly and the cursor will automatically advance.
 - b. If two letters are over the same key, use the [>] key to advance the cursor. To enter the word WELD, use the following sequence:

W	E	L	D
[Alpha] [9]	[3] [3]	[5] [5] [5]	[3]

To enter delimiters (symbols), follow these steps:

Note: Delimiters or Symbols are treated as letters and are accessed in the **Alpha** mode. Symbols are only valid when entering ID codes from the live screen.

1. Press [ALPHA] to enter symbols. The entry cursor flashes “_”.
2. Press [ID] (SYMBOL) multiple times to move through the following list:
[SPACE] [.] [/] [-] [*] [:] [#]

8.4 Creating Files and Identifier (ID) Codes

Thickness readings and waveforms are stored in the EPOCH 4 datalogger in a file with an associated ID. You can either manually enter file names and IDs using the EPOCH 4’s keypad, or can create them in the Epoch 4 Interface Program and download to the instrument. (Contact Panametrics-NDT or your local representative for more information on the EPOCH 4 Interface Program.)

You can create file names in the EPOCH 4’s *Memory* screen in preparation for saving thickness readings and waveforms. Upon entering the memory screen, a cursor appears at the first available empty file location. If the cursor is flashing over an existing file, use the down arrow key to move to the next available empty file location. Enter the file name with extension, date, time, and a short descriptive note using the alphanumeric keypad.

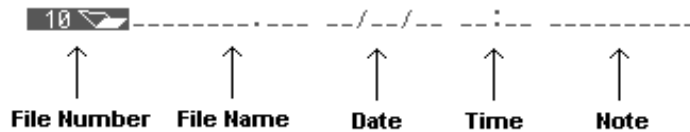

Figure 42 Entering File Information

The following rules and conditions apply:

- The file name is limited to eight alphanumeric characters with an extension of three characters. If no file name is assigned, the instrument automatically assigns a generic name UNTITLED.001, UNTITLED.002, and so forth.
- The note is limited to 10 alphanumeric characters.
- You can manually enter the date and time. Alternately, the EPOCH 4 does have an on-board real time clock that automatically stamps the file with the current date and time when saving data to that file. If subsequent information is saved to that file, the EPOCH 4 automatically updates the stamp with the current date and time.

Once the file name is created, press [F5] to return to the live screen. Whatever file is open (designated by the flashing cursor) is the file that begins to have data saved to it when returning to the live A-Scan. The file name displays continually at the top left side of the screen.

Before any data is stored in the file, press [ID] to enter the first Identification (ID) code. A cursor appears at the ID entry line at the top right side of the screen. Use the alphanumeric keypad to type in the ID. To redo an entry, use the blue arrow keys to backspace or press [ID] a second time and a blank line will appear. To toggle back to the original ID, press [ID] again.

8.5 Saving Waveforms and Thickness Readings

Follow the steps outlined in Section 8.4 to setup a file name in the *Memory* screen and an Identifier (ID) file in the live screen.

The EPOCH 4 can save two types of data:

- **Thickness Readings:** Press [SAVE THICK] to save the ID code along with the displayed depth, amplitude, or TOF value. The waveform and the setup parameters will **NOT** be saved during this process and these IDs can **NOT** be recalled to the live screen. Saving this limited data allows the EPOCH 4 to store a larger amount of individual IDs and corresponding measurement values (10,000 readings or 40,000 readings with the Expanded Memory option.)
- **Waveforms:** Press [SAVE WAVE] to save all waveform data and setup parameters in the datalogger. These IDs can be recalled to the live screen to restore the instrument's settings to what they were when the calibration/waveform was initially saved. The EPOCH 4 can save a total of 500 (2000 with the Expanded Memory option) complete waveform/parameters setups.

Data is saved in the EPOCH 4 datalogger in the currently displayed file and tagged with the ID code displayed on the screen. The ID code automatically increments to the next ID in preparation for saving additional data. (See Incrementing ID Codes on page 90.)

To save thickness readings and waveforms to a different file already created in the EPOCH 4 or a completely new file, return to the *Memory* screen and position the highlight bar over the desired filename (or on a newly created filename.) When you return to the live screen, the EPOCH 4 saves data at whichever file was highlighted when the *Memory* screen was exited. The file name is also displayed on the top left portion of the live screen.

Note: Every time the EPOCH 4 is initially turned on, the next available blank file is displayed. The top left portion of the screen displays a blank line indicating

that no file has been selected. If you enter an ID and then attempts to start saving data, the EPOCH 4 automatically creates a new file name where the data is stored. The file is named UNTITLED.XXX, where the extension incrementally increases depending on the number of untitled files created.

8.6 Incrementing ID Codes

This feature automatically increments the EPOCH 4's ID code every time you press the [SAVE THICK] or [SAVE WAVE] key. You do not have to enter a new ID every time a reading is saved. For example, a user wants to save several readings when inspecting an aircraft wing. Begin by entering an initial ID of "Wing-01." Press [SAVE THICK] or [SAVE WAVE] to save desired thickness readings and waveforms. Every time you press one of these keys, the ID code listed at the top of the screen increments by one character value. In this example, the first thickness reading/waveform is saved with an ID code of "Wing-01," the second one with an ID code of "Wing-02," etc.

Some guidelines for the auto-ID incrementing features are:

- Only the portion of the ID consisting of digits and letters (no punctuation marks) beginning with the rightmost letter and extending leftward to the first punctuation mark or leftmost character (whichever comes first) is incremented.
- To have the EPOCH 4 properly increment, first create and hold using zeros the maximum number of needed digit positions. To save 999 readings, enter "001" as the first ID code. If an initial ID code of "1" is entered, the EPOCH 4 only increments up to "9" and beeps. The message error – "Id Cannot Increment" appears. Press [F1] to exit and enter a new ID code to continue saving readings.
- After saving several readings to a file, you may want to save data to a different file. If you return to a file where data has already been saved, the ID code displays the next available ID (incremented after the last save.)
- To interrupt the auto-ID sequencing, press the [ID] key and enter a new ID code. The new ID code then increments in the same fashion.

Note: It is possible to create a list of ID's in the EPOCH 4 Interface Program and then transmit this list to the instrument. When you select this file to save information, the unit automatically begins to incrementally fill the ID database created in the PC. (Contact Panametrics-NDT or your local representative for details regarding ordering the EPOCH 4 Interface Program.)

8.7 Recalling Transducer Calibrations and Waveforms

The EPOCH 4's datalogger is designed to let you to quickly review the contents of saved files, and then recall saved transducer calibrations to the live screen.

Note: The EPOCH 4 has a total of nine dedicated transducer calibration slots. These are located in files 1-9 of the datalogger, and are indicated by an "*" "

next to the file number. These can only store one calibration (with complete setup parameters and waveform) in each file. They are designed to store the most frequent calibration setups that you used and can be recalled using only two key presses. (See Saving and Recalling Quick Recall Calibrations on page 92.)

To recall a saved calibration (in Files 10 and greater), follow these steps:

1. Press  to enter the *Memory* screen.
2. Use the slewing keys to select the file where the desired calibration is located.
3. When the file is highlighted, press [F1] to enter the *Contents* screen.
4. Use the slewing keys to scroll through the selected file. Only IDs with saved waveform/parameter setups can be recalled to the live screen. The ID name being viewed displays at the top of the screen. As you scroll through the file, this ID will continually change.
 - a. When an ID is listed that has a corresponding waveform and setup parameters saved with it, a **Recall** selection is available by pressing [F2].
 - b. The **Recall** selection disappears when an ID is listed that contains a measurement value only (depth, amplitude, or TOF.)

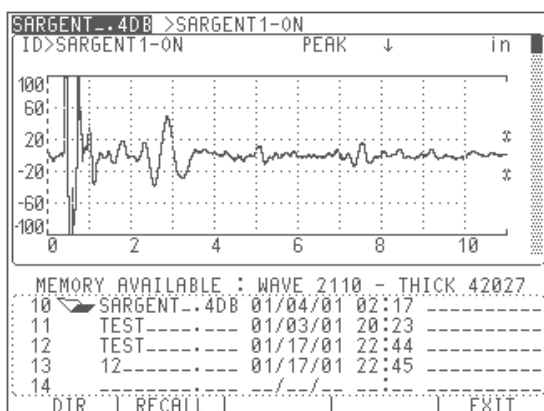

Figure 43 Recalling a Selection

5. Press [F2] for **Recall** when the appropriate ID is listed at the top of the screen (see step 4 above for details.) The calibration is recalled and the EPOCH 4 is in the **Freeze** mode. You cannot change any parameters while in this **Freeze** mode.
6. Press [FREEZE] to go to the live screen. The EPOCH 4 is ready for use with the same parameter settings used when this calibration was initially saved.

8.8 Saving and Recalling Quick Recall Calibrations

The EPOCH 4 has a total of nine dedicated “quick recall” transducer calibration slots. These are located in files 1-9 of the datalogger, and are denoted by an “*” next to the file number. These files can only store one calibration (with complete setup parameters and waveform) in each file. They are designed to store the most frequent calibration setups that you used and can be recalled using two key presses.

To save Quick Recall Calibrations, follow these steps:

1. Enter the *Memory* screen and create a file name for the desired quick recall file (file locations 1-9.) (See Creating Files and Identifier (ID) Codes on page 88.) After entry of file name, exit the *Memory* screen with the cursor over the desired file.
2. Enter an ID code. (See Creating Files and Identifier (ID) Codes on page 88.)
3. Press [**SAVE WAVE**].

Note: A memo can be entered before or after the calibration is actually saved in order to provide more detail about the type of calibration.

Thickness readings can not be saved in Calibration Files 1-9. “ERROR” will appear if [**SAVE THICK**] is pressed when saving to a file 1-9.

Only one waveform/calibration setup can be saved in Calibration Files 1-9. “ERROR” appears if [**SAVE WAVE**] is pressed a second time when saving to a file 1-9.

To perform a Quick Recall Calibration, follow these steps:

1. Press [**CALIBRATION**] from the live screen. The **Cal** symbol appears on the screen.
2. Press the desired key [1], [2], ...[9] associated with the desired calibration to recall. A pop-up box appears on the screen to confirm.
3. Press [**F1**] to recall the calibration or [**F2**] to abort.

8.9 Creating Memos

Use the MEMO feature to enter descriptive comments to include with stored data. This is used to supplement the single note (10 character maximum) that can be added to each file. Memos are usually used to provide further details about a measurement condition or calibration. Memos can only be entered from the live screen.

To place a memo in the database prior to a particular thickness reading, enter it prior to saving the reading. To place a memo in the database after saving a thickness reading and/or waveform, enter it afterwards.

To enter a memo, follow these steps:

1. Press [**MEMO**]. A pop-up box appears with three lines of available entry space.
 2. Use the alphanumeric keypad to enter a memo.
-

3. Press **[F1]** to save the memo in the datalogger or **[F2]** to abort.

8.10 Editing a File

Editing the File Directory Portion of the Memory Screen:

You can create multiple files in the EPOCH 4 and then store a variety of data in the files. These files are displayed in the File Directory, which is located in the lower portion of the *Memory* screen. To edit one of these files, move the highlight bar over the desired file by using the up and down arrow keys. Once the file is highlighted, press **[EDIT]**.

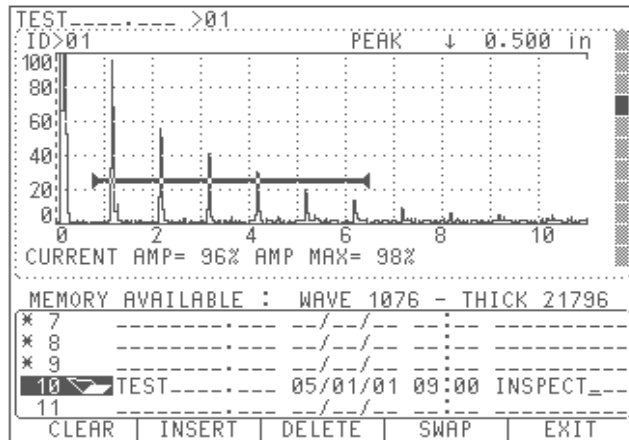

Figure 44 Editing the File Directory

To clear the file's contents, follow these steps:

1. Pressing **[F1]** prompts you to enter one of the following:
 - a. Press **[F1]** to clear the data (thickness readings, waveforms, memos, etc.) from the file. This action leaves the ID codes of the data in place. You can then opt to begin saving new data to these same ID codes.
 - b. Press **[F2]** to clear the data plus the ID codes. This leaves the file completely blank, but leaves the file name and location in place. You can then opt to save new data to this file after entering a new initial ID code.
2. Press **[F3]** to abort.

To insert a new file, follow these steps:

1. Pressing **[F2]** prompts you to enter one of the following:
 - a. Press **[F1]** to insert a new file. A blank file is then be inserted before the highlighted selected file.
 - b. Press **[F2]** to abort.

To delete the file, follow these steps:

1. Pressing **[F3]** prompts you to enter one of the following:
 - a. Press **[F1]** to delete the file. The file is deleted and the remaining files move up one location.
 - b. Press **[F2]** to abort.

To swap the file location, follow these steps:

1. Press **[F4]** and use the up and down arrow keys to select the new location for the file.
2. Press **[F1]** to swap desired files. The two files selected exchange places in the file directory.
3. Press **[F2]** to abort.

To exit the edit function, follow these steps:

1. Press **[F5]** to exit the edit function. You will still be in the *Memory* screen.
2. Press **[F5]** again to return to the live screen.

Editing the File Contents Portion of the Memory Screen

When thickness readings and waveforms are saved in the datalogger, they are saved to an individual file. The contents of these files are displayed in the File Contents portion of the Memory Screen.

To edit individual ID codes in these files, follow these steps:

1. Use the slewing keys to move the highlight bar over the desired file in the File Directory (lower portion of the *Memory* screen.)
2. Press **[F1]** to enter the **File Contents** screen (upper portion of the *Memory* screen.)
3. Use the slewing keys to review the file contents. The current ID code (either a waveform or a thickness reading) is continuously displayed and updated at the top of the screen as you scroll through the file.
4. Press **[EDIT]** when the desired ID code is displayed.

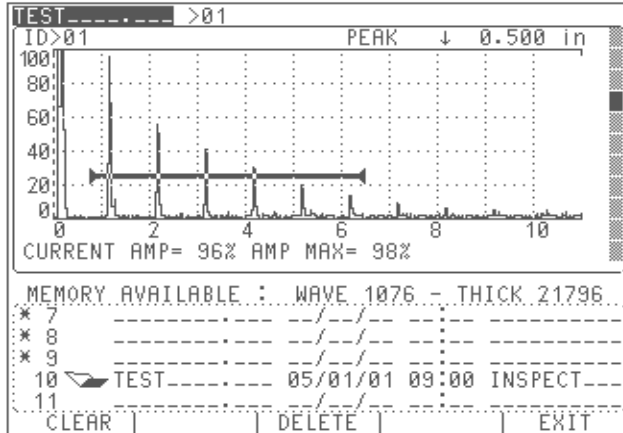

Figure 45 Editing the File Contents

To clear the ID, follow these steps:

1. Pressing [F1] prompts you to enter one of the following:
 - a. Press [F1] to clear the data from the ID code (thickness readings or waveforms.) This action leaves the ID name in place and lets you to save other data to the same ID. You can then opt to begin saving new data to these same ID codes.
 - b. Press [F2] to abort.

To delete the ID, follow these steps:

1. Pressing [F2] prompts you to enter one of the following:
 - a. Press [F1] to delete the ID name and data saved in that ID location. The file will be deleted and the remaining files will move up one location.
 - b. Press [F2] to abort.

8.11 Printing

Live waveforms and stored data files can be printed directly from the EPOCH 4 to a serial printer. Printing a live waveform prints exactly what you see on the EPOCH 4 display. Printing a file prints the entire contents that a user has saved in the file.

Note: Panametrics-NDT offers portable, battery powered printers to facilitate printing while in the field or office. The part numbers are EP4-PR (110V) and EP4-PRE (220V). (Contact Panametrics-NDT or your local representative for more information.)

Before printing, set the EPOCH 4's communication parameters to match the configuration of the printer device. (See RS232 Setup on page 41 to select the proper parameters.)

To print from the live screen, follow these steps:

1. Press [**2ND** **F**] [**DISPLAY**] (**PRINT**). A pop-up box appears on the screen.
2. Press [**F1**] to print the live screen or [**F2**] to abort.

To print from the memory screen, follow these steps:

1. Press  to enter the Datalogger/Memory screen.
2. Use the slewing keys to move the highlight bar over the desired file to print. A pop-up box appears on the screen.
3. Press [**F1**] to print the entire contents of the file or [**F2**] to abort.

Printing an entire file also prints the XML tags associated with the EPOCH 4 software code.

9 Using Software Options

This chapter describes the different software options that are available for the EPOCH 4. The EPOCH 4 is intended to be a highly versatile instrument. It is capable of being configured to perform specialized functions related to certain applications or code requirements. Since some inspectors may not make use of these functions, they have been offered as software options. Contact Panametrics-NDT or your local representative for information on ordering these options.

Topics are as follows:

- Defining Active/Inactive Options
- Distance Amplitude Correction (DAC)
- Time Varied Gain (TVG)
- Pulse Repetition Frequency (PRF)
- B-Scan
- Spotweld
- Interface Gate
- Floating Gate
- Expanded Memory
- Curved Surface Correction
- Wave Analysis
- DGS
- AWS
- Auto-Freeze

9.1 Defining Active/Inactive Options

Access software options using the [OPTION] key. The menu displays a list of available options, each with a triangle or box preceding it. The following table describes each symbol:

Symbol	Description
Unfilled triangle or box	The option is not activated.
Filled triangle	The option is active. To activate an option, move the highlight bar over a desired selection using the slewing keys and press [ENTER].
Filled box	The option is active, are no further adjustment is necessary.

Table 7 Active/Inactive Software Options

9.2 Distance Amplitude Correction (DAC)

A Distance Amplitude Correction (DAC) curve is used to plot amplitude variations of signals from reflectors of the same size, but at different distances from the transducer. Normally, these reflectors produce echoes of varying amplitude due to material attenuation and spreading of the sound beam. The purpose of a DAC curve is to graphically compensate for material attenuation, nearfield effects, beam spread, and surface roughness.

After plotting a DAC curve, reflectors that are the same size as those used for creation of the curve produce echoes that peak along the curve despite different locations in the test piece. Similarly, reflectors that are smaller than those used to create the curve fall below the level, while larger reflectors exceed the curve level.

With the use of the DAC curve option, the EPOCH 4 is capable of drawing user-defined DAC curves. It is possible to select formats that are consistent with either American Society of Mechanical Engineers (ASME), ASME-3, or Japanese Industrial Standard (JIS) Z3060 code requirements.

When the ASME format is selected, a single curve is drawn. The ASME-3 format lets you draw three curves simultaneously at 0dB, -6dB, and -14dB. When the JIS format is selected, up to eight segmented curves are drawn.

In all formats, the signal amplitude as a percentage of the primary curve level is displayed on the screen. Users can select to view this value in terms of a “%” or “dB.” In addition, DAC alarms can be set to activate whenever an echo exceeds the primary curve level. DAC curves can be saved in the EPOCH 4’s datalogger and recalled when needed.

9.2.1 Drawing DAC Curves

To draw a DAC curve, follow these steps:

1. Calibrate the EPOCH 4 for the appropriate transducer. Adjust the Gain so the peak of the highest amplitude echo that is to be used in the DAC curve is visible on the screen.

An echo can not be used in the curve if its amplitude is greater than 100% screen height.

2. Press **[OPTION]**.
3. Use the slewing keys to position the highlight bar over the DAC selection and press **[ENTER]** to display the DAC setup choices.
4. Use the slewing and **[ENTER]** key to select the DAC standard (ASME, ASME-3, or JIS) and also the signal amplitude units (% DAC or dB DAC).
5. Press **[OPTION]** to return to the A-SCAN display.
6. Position Gate 1 over the desired echo to begin drawing the DAC curve. Adjust the gate level if necessary to make sure the echo breaks the gate. Press **[F1]**.
7. Move Gate 1 to the appropriate position to capture the next point for the curve.
8. Press **[F1]**. Repeat this step until all points for the curve are captured.
9. Press **[F2]** to complete the curve once the last point are captured.

Tip: To correct a mistake made while drawing the curve, press **[F3]** to clear the curve and start again.

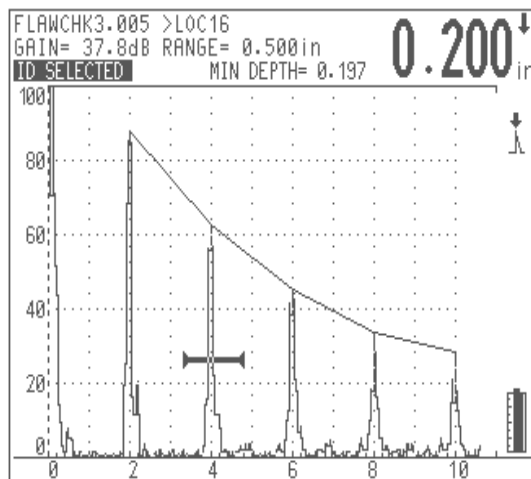

Figure 46 Creating a DAC Curve

When the **DAC** mode is active, any parameter that would affect instrument calibration is automatically locked. This includes: **[GAIN]**, **[RANGE]**, **[ZERO OFFSET]**, **[VELOCITY]**, **[ANGLE]**, **[REJECT]**, and all pulser and filter parameters.

To obtain amplitude information in the **DAC** mode, press **[DEPTH /%AMP]**, and **[F3]**. If you highlight the **% DAC** selection in the DAC setup screen, the EPOCH 4 displays the current echo height percentage (in terms of full screen height) and the percentage of the echo related to the primary DAC curve level. If **DB DAC** is selected, the current echo height percentage (in terms of full screen height) and the dB value of the echo related to the primary DAC curve level is displayed.

Once the curve is complete, the Reference Gain function can be activated by pressing [2nd F], [GAIN] (REF DB). This key sequence locks in a reference gain level and allows scanning gain to be added or subtracted to accommodate specific applications. For example, if it is required to evaluate any reflector that exceeds 50% of the DAC level, 6dB of scanning gain can be added. In this manner, the DAC curve when used in conjunction with the Amplitude DAC display and DAC alarm becomes an easy reference to determine if an indications exceeds the evaluation level. Note that the additional scanning gain can not be added to the original reference gain level as this would change the calibration and invalidate the DAC curve.

Note: In version 1.04 and higher of the EPOCH 4 operating software, the [ZOOM] key is active after setting up a DAC curve. When zooming in on a particular echo, the DAC curve will temporarily disappear. The curve will reappear when zooming back out. The ASCAN waveform can also be saved when in the zoomed mode, however the DAC curve will not be saved with the waveform.

9.2.2 Special Considerations for JIS Z3060 DAC Curves

In general, the instructions in Section 9.2.1 apply to the construction of all DAC curves. However, there are some special provisions that have been made to address the requirements of JIS Z3060. These considerations are listed below.

- Because of the large number of curves drawn for the **JIS DAC** mode, it is possible to temporarily add in 6, 12, 18, or 24dB of additional gain while constructing the DAC curve set. The purpose of this feature is to facilitate construction of additional curves when testing at longer ranges. Once construction of the curve set has begun, add up to 24dB of additional gain through repeated presses of the [GAIN] key. In order to make clear that gain has been added while constructing the curve, the gain appears as follows: “GAIN 46.2DB + 6,” “GAIN 46.2DB + 12,” etc. Once the curve set is completed, the gain is reset to its original level (46.2dB in this example.)
- It is also possible to change Angle, Material Thickness, Zero Offset, and Gain in the normal manner when in the **JIS DAC** mode. Be careful when adjusting these parameters to ensure the relationship of DAC curves to material thickness or distance is not unintentionally altered.
- Any of the six curves can be used to trip the alarm when in the **JIS DAC** mode. Additionally, you can set the alarm to positive or negative. To select which curve will be used as the alarm reference level, first activate JIS DAC and then use the [F4] and [F5] function keys to select which curve to use for the alarm threshold. The selected curve appears as a double thickness line. Once a curve has been selected, an alarm can be activated and set to be either positive or negative threshold detection by pressing [2nd F], [GATE 1] (ALARM 1) and following the prompts.
- When the **JIS DAC** mode is active, the amplitude (level) of a gated signal is always displayed as a percentage (% DAC or dB DAC) with respect to the selected curve. If a different curve is selected, the displayed amplitude changes accordingly.

9.2.3 Saving and Recalling DAC Curves

DAC curves are saved and recalled in the same manner as any general waveform/calibration. With **DAC** mode active, use the [**SAVE WAVE**] key to save the entire setup in the datalogger. When a setup that was stored with a DAC curve is recalled, the instrument automatically comes up in the **DAC** mode.

9.2.4 Setting Alarms in DAC Mode

You can use the gates to set alarms while DAC is active. When using the ASME or ASME-3 **DAC** modes, all alarms are referenced to the primary curve. When using the **JIS DAC** mode, alarms are referenced to the highlighted alarm curve. For example, any DAC alarm can be set by using the positive threshold alarm on either Gate 1 or Gate 2. Any echo that falls within the gate and exceeds the DAC level triggers the alarm. The alarm is triggered only if an echo exceeds the portion of the DAC curve immediately above the gate. This same rule applies to the use of the minimum depth and negative threshold alarms while in DAC.

Note: Alarms do not function in the area outside of the DAC curve.

9.2.5 Exiting DAC Mode

To clear the DAC curve and return to the normal operation, follow these steps:

1. Press [**OPTION**].
2. Use the slewing keys to highlight the **DAC** selection and press [**ENTER**] to go into the DAC setup.
3. Use the slewing keys to highlight **Off** and press [**ENTER**].
4. Press [**OPTION**] to return to the A-SCAN display.

9.3 Time Varied Gain (TVG)

The Time Varied Gain (TVG) option compensates or corrects for the changes in echo amplitude from equal sized reflectors at different distances due to material attenuation and beam spreading. When TVG is properly set up, equal sized reflectors produce indications of equal screen height regardless of their distance. TVG has a dynamic range of 40dB with a minimum echo height of approximately 5%.

Note the following items when using the TVG option:

- In version 1.04 and higher of the operating software, TVG is active in all display modes (RF, Full Wave, Half Wave +, and Half Wave -)
- In version 1.04 and higher, the zoom function is active with TVG
- TVG and DAC may not be activated simultaneously

- Up to 20 TVG calibration points may be programmed, separated by a minimum of 0.52 microseconds (approximately 0.06" or 1.5mm at longitudinal velocity in steel)
- The minimum full screen range must be set greater than approximately 1" (25mm) at longitudinal velocity of steel to activate TVG. After a TVG curve is set up, it is possible to zoom in to smaller range ranges than 1.000 inches.
- The maximum full screen range must be set less than approximately 120" (3050mm) at longitudinal velocity of steel to activate TVG. Please note that some instruments are hardware limited to a maximum of 30" (762mm) full screen range. Contact Panametrics-NDT or your local representative if you require the TVG upgrade to 120" (3050mm).
- TVG must be set up with the aid of reference standards that generates representative echoes at the points of interest

9.3.1 Activating and Calibrating TVG

To activate and calibrate TVG, follow these steps:

1. Calibrate the EPOCH 4 for the appropriate transducer.
2. Adjust the Gain so the peak of the highest amplitude echo to be used in the TVG setup is visible on the screen. An echo can not be used at a TVG point if its amplitude is greater than 100% screen height.
3. Press [**OPTION**] to display the **Options** menu.
4. Use the slewing keys to position the highlight bar over the TVG selection and press [**ENTER**] to display the TVG setup choices.
5. Use the slewing and [**ENTER**] key to select **On**.
6. Press [**OPTION**] to return to the A-SCAN display.
7. To set a TVG point, position Gate 1 over the desired echo. Adjust the gate level if necessary to make sure the echo breaks the gate. Press [**F1**]. Generally, you should start with the highest amplitude calibration echo and work down to the smallest one.

You can go back to fine-tune the gain level at any selected point by repositioning the gate on the appropriate echo and pressing [**F1**] again. If a point outside the allowable time limits, the unit beeps to indicate an error.

8. Move Gate 1 to the appropriate position to capture the next point for the curve and press [**F1**] again. Repeat this step until all points for the curve are captured.
9. Press [**F2**] when all echoes have been set to lock the TVG setup. The letters "TVG" will appear to the right of the screen to indicate that TVG is active. A double thickness line appears at the top of the display to mark the area over which TVG has been programmed.

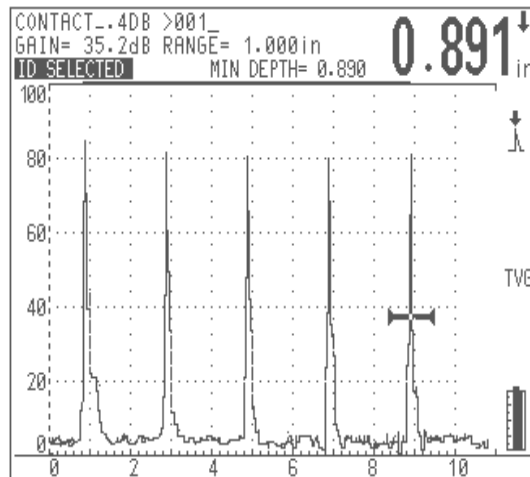

Figure 47 TVG Example

When **TVG** mode is active, any parameter that would affect instrument calibration is automatically locked. This includes: **[GAIN]**, **[ZERO OFFSET]**, **[VELOCITY]**, **[ANGLE]**, **[REJECT]**, and all pulser and filter parameters.

Once the TVG setup is complete, you can activate the Reference Gain function by pressing **[2ndF]**, **[GAIN]** (**REF DB**). This locks in a reference gain level and allows scanning gain to be added or subtracted to accommodate specific applications. Note that the additional scanning gain can not be added to the original reference gain level as this would change the calibration and invalidate the TVG setup.

9.3.2 Saving and Recalling TVG Setups

TVG setups are saved and recalled in the same manner as any general waveform/calibration. With **TVG** mode active, the **[SAVE WAVE]** key is used to save the entire setup in the datalogger. When a setup that was stored with a TVG setup is recalled, the instrument automatically comes up in **TVG** mode.

9.3.3 Exiting TVG Mode

To clear the TVG setup and return to the normal operation, follow these steps:

1. Press **[OPTION]**.
2. Use the slewing keys to highlight the **TVG** selection and press **[ENTER]** to go into the TVG setup.
3. Use the slewing keys to highlight **Off** and press **[ENTER]**.
4. Press **[OPTION]** to return to the A-SCAN display.

9.4 Pulse Repetition Frequency (PRF)

Pulse Repetition Frequency (PRF) is a measure of how often the transducer is being pulsed by the electronic circuitry in the EPOCH 4. The standard PRF setting of the EPOCH 4 is “Auto,” where the PRF changes automatically from 60Hz to 360Hz depending on the range setting. In order to work with challenging applications more effectively, the EPOCH 4 has software options to increase or decrease this PRF setting to make it a fixed rate.

The Low PRF setting decreases the PRF to a fixed rate of 30Hz. This may be necessary for applications involving long sound paths or very attenuating materials. By lowering the PRF, it helps avoid a phenomena called “wrap-around noise”, which results in random noise and echoes on the A-Scan display.

The High PRF setting increases the PRF to a fixed rate of 1,000Hz (or 1KHz). This can be extremely useful for higher scanning speed applications, due to the actual measurement rate of the EPOCH 4 being 1KHz. The EPOCH 4 analog output rate is the same as the measurement rate. This means when High PRF software is activated, the analog output will be at a rate of 1KHz. The maximum full screen range is 10 inches (254mm) at the longitudinal velocity of steel when High PRF is active. The High PRF software can be used with FG, CSC, and Wave Analysis software, but CANNOT be used at the same time as all other software options such as Interface Gate, BSCAN, etc. The battery operating time is reduced when HPRF is active. The approximate operating time is 6.5 hours for units with LCD screens and 4.5 hours with ELD screens (continuous measurement in the gate).

9.4.1 Activating Low PRF or High PRF Mode

To activate the **Low PRF** or **High PRF** mode, follow these steps:

1. Press [**OPTION**].
2. Use the slewing keys to highlight the **PRF** selection and press [**ENTER**].
3. Use the slewing keys to highlight either the **Low** or **High** selection and press [**ENTER**].
4. Press [**OPTION**] to return to the A-SCAN display. A “PRF” symbol displays on the right side of the screen to signify that either the **Low PRF** or **High PRF** mode is active.

9.4.2 Exiting Low PRF or High PRF Mode

To exit the Low PRF mode, follow these steps:

1. Press [**OPTION**].
2. Use the slewing keys to highlight the **PRF** selection and press [**ENTER**].
3. Use the slewing keys to highlight **Auto** and press [**ENTER**].
4. Press [**OPTION**] to return to the A-SCAN display.

9.5 B-Scan

The B-Scan software option allows you to generate an easy to understand cross sectional profile of test material. This view is used to verify acquired thickness measurements, and also to provide a visual reference showing areas on the part with critical thickness values.

A scanner equipped with an internal encoder mechanism maps the thinning areas by providing transducer location information (Distance Traveled) along with the thickness reading. This feature increases the functional value of the B-Scan as relative location in the material is directly correlated with the depth at that location.

The B-Scan has three separate operating modes:

- ***Bi-Directional Encoded Mode:*** This mode requires the use of a bi-directional encoder that keeps track of location information as data is collected in both forward and backward directions.
- ***Uni-Directional Encoded Mode:*** This mode requires the use of a bi-directional or uni-directional encoder that keeps track of location information as data is collected in the forward direction only.
- ***Manual Mode:*** This mode does not keep track of location information and does not require the use of an encoder. This mode provides a continuous scan of thickness data with no correlation to its location along the scan. Readings are timed from 1 to 60 readings per second and are not related to transducer movement.

9.5.1 Choosing an Encoder and Accessories

Panametrics-NDT offers a handheld portable scanner with internal encoder (EP4/ENC) for use with the B-Scan option, which is well suited for a variety of applications. The scanner and general B-Scan package (EP4/BSCAN-KIT-XX) are available with the following optional accessories:

- Magnetic Wheels (EP4/MW)
- Extension Pole Bracket (EP4/EPB)
- Extended Probe Holder Wear Cap (EP4/EWC)
- Transducer and Encoder Cables of various lengths (X^\dagger CMD-316- Y^\ddagger B, EP4/ENC/CBL- Z^*)

Note: $^\dagger X$ = Connector type indicating BNC or Large LEMO. Replace X in the part number with B to indicate a BNC connector, or LI to indicate a Large LEMO connector.

$^\ddagger Y$ = Transducer cable length indicating 5", 10", 25", 50", or 100". Replace Y in the part number with the desired cable length.

$^* Z$ = Encoder cable length indicating 10", 25", 50", or 100". Replace Z in the part number with the desired cable length.

- PC Interface Program (Contact Panametrics-NDT)

You can use other encoders that have a standard TTL quadrature position encoder and a four conductor connection with a single +5V power supply. You can also use a remote control scanner to provide a more automated inspection.

9.5.2 Getting Started

To configure the EPOCH 4 and scanner, follow these steps:

1. Secure the selected transducer, with attached cable, in the scanner's probe holder using the two tightening screws.
2. Connect the transducer cable into the BNC or LEMO connector on the EPOCH 4. This provides the ultrasonic information from the transducer to the EPOCH 4.
3. Attach the LEMO connector of the encoder cable into the scanner. The 15 pin connector plugs into the 15 pin parallel port of the EPOCH 4.

You can also connect a couplant feed to the couplant feed port on the scanner, which allows for continuous transducer coupling when used with a water pump or pressurized couplant dispenser.

9.5.3 Performing A-Scan Calibration and Setup

Before entering the **B-Scan** mode, it is extremely important that the EPOCH 4 is calibrated and set up properly in the A-Scan screen.

To perform an A-Scan calibration and setup, follow these steps:

1. Calibrate the EPOCH 4 for the appropriate transducer and material. (See Adjusting the Pulser Receiver on page 45 for proper calibration procedures.)
2. Position Gate 1 so that the start of the gate is positioned prior to the minimum expected thickness or at zero. Likewise, position the end of the gate after the maximum expected reading. An echo must break the gate for the EPOCH 4 to detect it and display a B-Scan data point.

Upon entering the **B-Scan** mode, the Gate Start and Gate End positions determine the vertical scale of the B-Scan. For best resolution, position the gate as accurately as possible near the minimum and maximum values expected. Use a slight buffer to include potential unexpected values. When entering the **B-Scan** mode, the EPOCH 4 automatically zooms the gate and expands the range until the gate represents a full screen.

9.5.4 Selecting a B-Scan Mode

To select a **B-Scan** mode, follow these steps:

1. Press [OPTION] to activate the **Options** menu.
2. Press [↑] and [↓] to highlight the **B-SCAN** option. Press [ENTER].

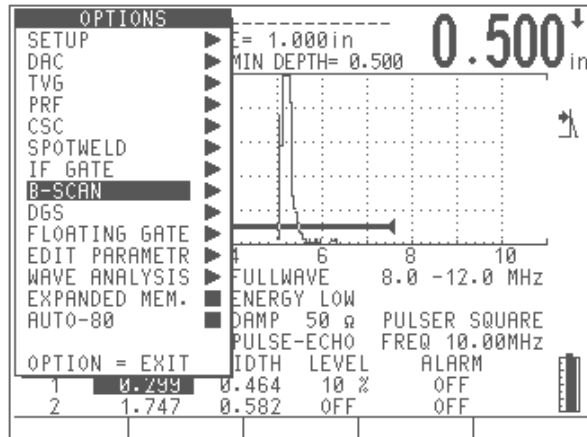

Figure 48 Selecting B-Scan from the Options Menu

- Press [F2] to select one of the following modes from the **Setup** menu: **Bi-Directional**, **Uni-Directional**, or **Manual**.

9.5.4.1 Setting Up the Bi-Directional Mode

To set up the **Bi-Directional** mode, follow these steps:

- Select the **Bi-Directional** B-Scan option. (See Selecting a B-Scan Mode on page 106.)

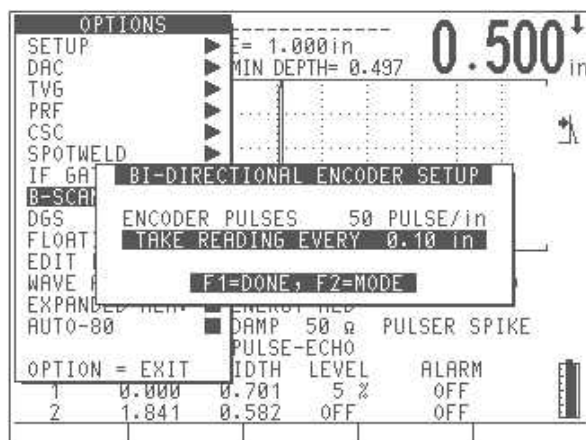

Figure 49 Select-Directional Encoder Pulses Option

The default parameter for the **ENCODER PULSES** setting is 50 Pulse/inch (2 Pulse/mm). The value for this setting represents the specification of the encoder offered by Panametrics-NDT with the B-Scan kit. If you are using the Panametrics-NDT EP4/ENC encoder car, do NOT change this value.

Note: If you are using a different scanner with a different optical encoder specification, you should adjust the Encoder Pulses value. Press [ENTER] to select **ENCODER PULSES**. Adjust the pulses/inch value by pressing [↑] and [↓] to select the correct number of encoder pulses per inch (mm) specific to the encoder that you are using. Consult the encoder specification to determine the appropriate encoder pulses value for your encoder.

2. The **TAKE READING EVERY __. __ in (mm)** setting should be highlighted upon initially entering this menu. Press [↑] and [↓] to enter the desired resolution based on the encoder resolution in pulses per inch/mm. Therefore, desired resolution is limited to increments of the encoder resolution that you are using.

For example, if the encoder resolution is 50 pulses/inch (2 pulses/mm), then the best resolution possible is 0.020 inch (0.5mm).

Each pulse from the encoder is capable of taking readings in increments of 0.020 in (0.5mm). It is possible to take a reading every other pulse, every third pulse, every fourth pulse, etc. Therefore, the resolution can be changed in increments as follows:

- 0.020 inch (0.5 mm) - Take reading every 1 pulse
- 0.040 inch (1.0 mm) - Take reading every 2 pulses
- 0.060 inch (1.5 mm) - Take reading every 3 pulses
- 0.080 inch (2.0 mm) - Take reading every 4 pulses
- 0.100 inch (2.5 mm) - Take reading every 5 pulses, etc....

3. Press [F1] to exit the **Bi-Directional Encoder Setup** menu after selecting the appropriate settings for encoder pulses and resolution.

9.5.4.2 Setting Up the Uni-Directional Mode

To setup the **Uni-Directional** mode, follow these steps:

1. Select the **Uni-Directional** B-Scan option. (See Selecting a B-Scan Mode on page 106.)

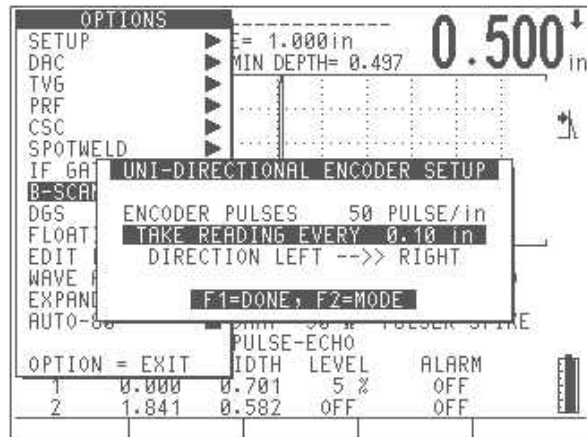

Figure 50 Selecting the Uni-Directional Encoder Pulses Option

The **ENCODER PULSES** setting defaults to the factory setting of 50 Pulse/inch (2 Pulse/mm), which matches the specification of the scanner included with the Panametrics-NDT B-Scan kit. (See note in the Bi-Directional set up screen if it is necessary to change this selection.)

2. Modify the parameter for the **TAKE READING EVERY** __. __ in (mm) setting by pressing [\uparrow] and [\downarrow] to enter the desired resolution. (See note in the *Bi-Directional Setup* screen for entering the proper resolution.)
3. Press [**ENTER**] to select the **DIRECTION LEFT** \rightarrow **RIGHT** option. Pressing [\uparrow] and [\downarrow] changes the direction of the arrows as follows:

LEFT \rightarrow RIGHT

LEFT \leftarrow RIGHT

This determines the direction that the data is updated on the EPOCH 4 screen. For example, choosing LEFT \rightarrow RIGHT causes the data to start at the left side of the screen and scroll to the right.

4. Press [**F1**] to exit the **Uni-Directional Setup** menu.

9.5.4.3 Setting Up the Manual Mode

To setup the **Manual** mode, follow these steps:

1. Select the **Manual** B-Scan option. (See Selecting a B-Scan Mode on page 106.)

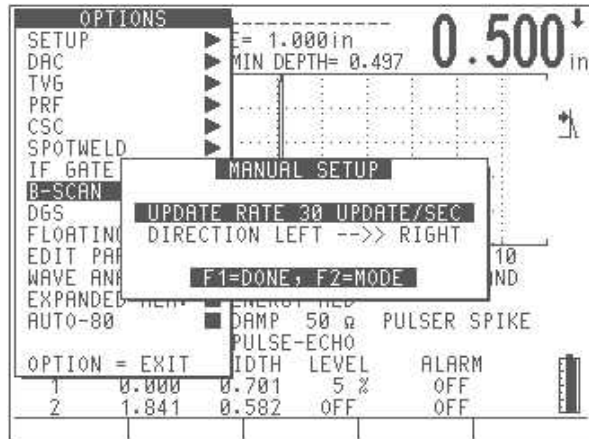

Figure 51 Selecting the Manual Update Rate Option

- The **UPDATE RATE** __ **UPDATE/SEC** setting is adjustable from a value of 1 to 60. This value controls the rate at which the EPOCH 4 takes readings and controls the rate of the scan.

Entering a value of 60 Updates/Sec allows the B-Scan to capture 60 readings every second. This also determines the minimum scan speed for the desired resolution. For example, to achieve a scan speed of 6 inches per second with a desired resolution (field of scan) of 0.100 inch, the value needs to be set at 60 Updates/Sec.

60 Updates/Sec X 0.100 inch = Max scan speed of 6 inches/second

30 Updates/Sec X 0.100 inch = Max scan speed of 3 inches/second

- Press **[ENTER]** to select the **DIRECTION LEFT** —> **RIGHT** option. Pressing **[↑]** and **[↓]** changes the direction of the arrows as follows:

LEFT —> RIGHT

LEFT <— RIGHT

This determines the direction that the data is updated on the EPOCH 4 screen. Choosing LEFT —> RIGHT causes the data to start at the left of the screen and scroll to the right.

- Press **[F1]** to exit the **Manual Mode Setup** menu.

9.5.5 Using the Scan Setup Menu

After completing the Bi-Directional, Uni-Directional, and Manual setup, press **[F1]** to proceed to the **Scan Setup** menu.

Tip: You can also access this menu from the live A-Scan screen by pressing **[2nd]**, **[OPTION]** (B-Scan).

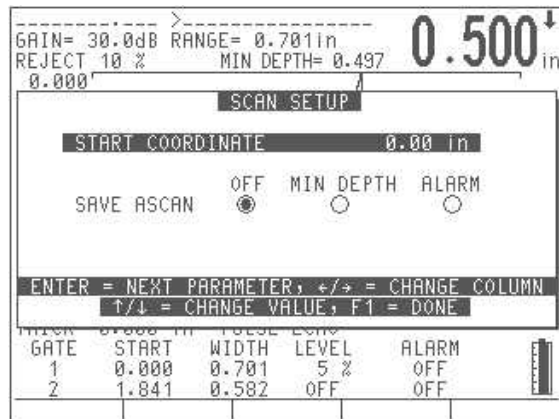

Figure 52 Setting Up Scan Parameters

If the **Bi-Directional** mode or **Uni-Directional** mode was previously selected, you will be prompted to enter a Start Coordinate. In **Manual** mode, the Start Coordinate portion of the **Scan Setup** menu does not appear because DT is not encoded in **Manual** mode.

9.5.5.1 Entering the Start Coordinate

To enter the start coordinate, follow this step:

Press [**↑**] and [**↓**] to enter the appropriate value for the starting point of your inspection. This value represents the first Distance Traveled (DT) value of the B-Scan. For example, if you are beginning the scan at the end of a pipe or plate, you may want to enter a value of zero. If you are beginning a scan that is a certain distance from the end of the test piece, enter an appropriate value for that position.

You may want to mark the location on your material to indicate where you have started the inspection for later reference.

9.5.5.2 Operating the Save A-Scan Function

The B-Scan software can automatically save A-Scans that may be of interest to you while performing a B-Scan. The EPOCH 4 can be set up to save A-Scans corresponding to the minimum depth (thickness reading) in a B-Scan, or to save A-Scans when a user defined alarm is triggered during a scan.

If you select to save the A-Scan at the minimum depth in a B-Scan, the EPOCH 4 can save up to 50 A-Scan waveforms within the B-Scan file where the minimum thickness measurement occurs. If you want to save waveforms corresponding to alarm conditions, the EPOCH 4 can automatically save up to 50 A-Scans within the B-Scan where a Gate Alarm is triggered.

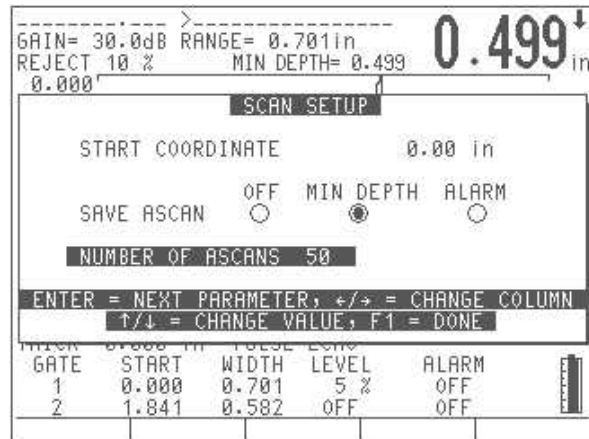

Figure 53 Setting Number of A-Scans to Save

When B-Scan collection is stopped, you can move a cursor back and forth along every data point on the B-Scan. This allows you to review the thickness measurement at every point. If an A-Scan was automatically saved at a data point due to a Minimum Depth or an Alarm Condition, it can be reviewed in the A-Scan view or the split A-Scan / B-Scan view. More detail about this feature is provided in the operational and datalogging sections.

To begin using the B-Scan feature from the **Setup** menu, press **[F1]**.

9.5.6 Operating the B-Scan Software

To use the B-Scan mode, you must first complete the following:

- Enter an appropriate Start Coordinate (in encoded modes)
- Choose if you would like the EPOCH 4 to automatically save A-Scan data while the B-Scan is conducted, and how many A-Scans to be saved
- Press **[F1]** in the **Scan Setup** menu

The selected mode is indicated along the left edge of the B-Scan. If this is not the proper mode, exit the B-Scan by pressing **[F5]**. (See Selecting a B-Scan Mode on page 106.)

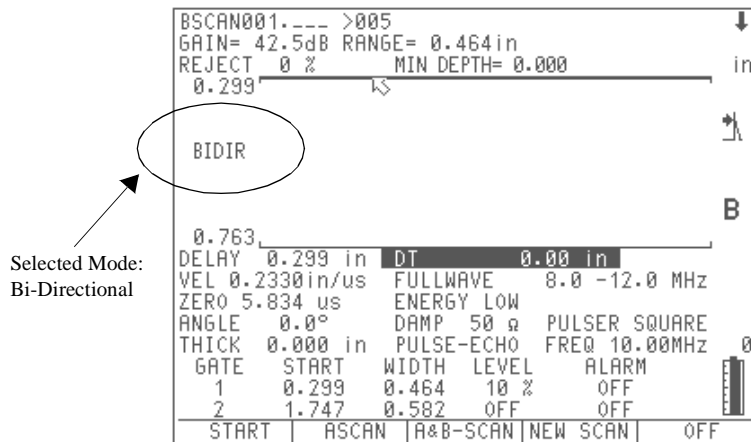

Figure 54 Viewing the Selected Mode

You are now ready to begin collecting data. While in the collect mode, the EPOCH 4 function keys **[F1]** – **[F5]** are setup to perform the following actions:

- **[F1]:** Start the collection of B-Scan data. While the B-Scan data is being collected, the function over the **[F1]** key changes to **Stop**. This allows the user to stop the collection of data during or at the completion of a B-Scan.
- **[F2]:** View the current live A-Scan waveform. This can be done while the B-Scan is running or while the B-Scan is stopped. While the A-Scan is being viewed, the function over the **[F2]** key changes to **B-Scan**, letting you toggle back to the B-Scan screen.
- **[F3]:** View both the B-Scan and the A-Scan screens simultaneously in a split screen manner. The A-Scan appears on the top half of the screen, and the B-Scan replaces the instrument setup parameters on the bottom half of the screen.
- **[F4]:** Initiate a new scan. A new scan clears any information in the memory buffer. Be sure to save the B-Scan before starting a new scan to avoid data loss (See Accessing Datalogger Storage on page 119.) After pressing **[F4]**, you will be prompted to verify that this is the desired course of action.
- **[F5]:** Turn off the **B-Scan** mode. You will be prompted to make sure that the desired action is to exit B-Scan.

To begin collecting data, press **[F1]**. As the scanner is moved, data is collected and displayed as a cross sectional image of the test material. The number of data points is based on the movement of the encoder wheel in increments of the resolution entered in the setup screen. The **Bi-Directional** mode allows the scanner to move backwards. B-Scan data points are updated. This is especially useful when verifying thin material areas where an alarm condition exists.

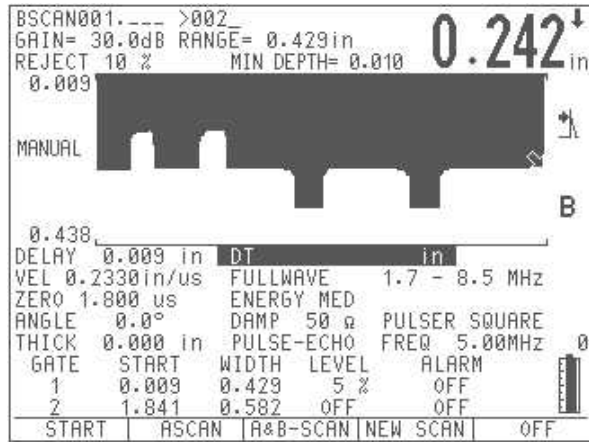

Figure 55 Viewing a Manual B-Scan

While collecting data, the information is temporarily stored in a memory buffer. The EPOCH 4 is capable of storing a maximum of 100,000 B-Scan data points (thickness readings) before the buffer is full. In the **Bi-Directional** mode, the buffer can store a maximum of 90,000 readings in the forward direction and a maximum of 10,000 readings in the backwards direction. When the buffer becomes full, the scan stops. You will be prompted to save the scan or start a new one. To prevent the loss of encoded data, the DT reading flashes as a warning when the buffer is within 500 readings of being full.

9.5.7 Reviewing Depth and Distance Traveled Information

It is possible to stop the B-Scan and review depth information and correlating distance traveled values. At any time during the encoded B-Scan, press [F1] to stop data collection. A marker arrow appears in the place of the cursor on the display. Press [←] and [→] to move this marker along the scan. In **Manual** mode, the depth recorded at each data point is displayed. In one of the encoded modes, the thickness reading along with the DT value at that point is shown.

Press [F1] again to restart the scan. The scan resumes at the cursor's last position.

9.5.8 Operating Minimum Depth Alarm

The EPOCH 4 is equipped with a minimum depth alarm, which is triggered whenever the current thickness reading falls below an operator defined level. The minimum depth alarm appears as a cursor on Gate 1 in single gate mode or on Gate 2 in **Echo-to-Echo** mode. The alarm level is displayed as a horizontal line across the B-Scan. The alarm is noted by a flashing **A** on the display and a continuous audible tone. (See Minimum Depth Alarm on page 67 for further information.)

Note: You can only activate or modify the minimum depth alarm in the **A-Scan** mode; you cannot change it while in **B-Scan** mode.

The figure below shows a split A-Scan / B-Scan if you were to view the Depth and Distance Traveled information in a B-Scan. Notice that an automatically saved A-Scan appears in the upper half of the screen because the Minimum Depth Alarm on Gate 1 was triggered.

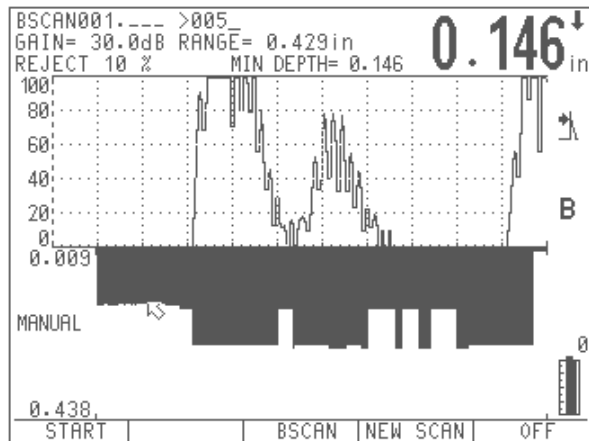

Figure 56 Viewing a Split A-Scan / B-Scan

9.5.9 Operating Scan Speed Alarm

When acquiring B-Scan data in one of the encoded modes, an alarm is triggered if the scanner is moved too fast for the EPOCH 4 to acquire and display data. The encoder's update rate is displayed on the right side of the screen above the battery level indicator when operating in the **B-Scan** mode. With an instrument range setting of 10 inches or less at steel velocity, the maximum encoder update rate is 180 updates per second. At range settings greater than 10 inches, the maximum encoder update rate is 60 updates per second. If the encoder is moved fast enough to exceed these values, a scan speed alarm condition is noted by an audible beep along with the flashing of the update rate. Encoded Distance Traveled (DT) data is kept in sync with the scanner, but no thickness data is drawn on the screen. The **Bi-Directional** mode allows the scanner to move in the opposite direction at a slower speed to redraw these thickness values.

Note: The greater the resolution desired, the slower the scanner can move to avoid missing data points. You can adjust the resolution in the **B-Scan** mode selection screens.

9.5.10 Operating Floating Gate and B-Scan

The Floating Gate software option is included with the purchase of the B-Scan software option in the EPOCH 4. Floating Gate is used to track the peak echo amplitude at either the -6dB or -12dB point of an echo. By using the floating gate, the EPOCH 4 provides a more consistent and accurate thickness reading particularly when using the **Edge Depth** mode.

Use this feature in either **Peak Depth** or **Edge Depth** modes. In **Edge Depth** mode, the floating gate tracks the highest amplitude echo breaking the gate (100% screen height or less), but takes the measurement from the left most echo breaking the gate.

In the **Options** menu, the Floating Gate is activated as shown below:

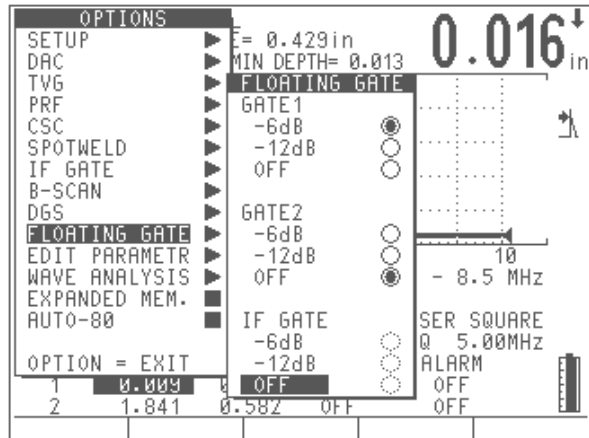

Figure 57 Activating/Deactivating the Floating Gate

When Floating Gate is active for Gate 1 or Gate 2, the EPOCH 4 displays either -6dB or -12dB under the Gate Level Indicator (depending on the chosen settings). See the example screenshot below showing the Floating Gate active with Gates 1 and 2 set at -6dB.

GATE	START	WIDTH	LEVEL	ALARM
1	0.037	0.362	-6dB	OFF
2	0.361	0.534	-6dB	OFF

Figure 58 Active Floating Gate with Two Gates

In order to use the Floating Gate option with B-Scan, the Floating Gate must be setup and active before B-Scan is activated. (See Floating Gate on page 124.)

Note: The gates do not appear on the instrument display while Floating Gate is active in **B-Scan** mode when the B-Scan is stopped in order to review the Depth / Distance Traveled information.

9.5.11 Operating Echo-to-Echo Detection

The EPOCH 4 is capable of conducting a B-Scan inspection while in **Echo-to-Echo** detection mode as well as the standard Mode 1 measurement. This functionality allows an inspector to create cross-sectional images of a single layer within a part while ignoring another layer such as a paint coating.

To setup the EPOCH 4 to generate a B-Scan in **Echo-to-Echo** mode, follow the instructions on page 61. Then, simply follow the steps detailed earlier in this section and be sure to position both gates in order to capture anticipated waveforms.

9.5.12 Saving B-Scan Data

The EPOCH 4 internal datalogger has the memory capacity to store up to 250,000 B-Scan data points. The only restriction is the maximum size of the active memory buffer. Therefore, not all 250,000 readings can be collected at one time. Instead, individual files of up to 100,000 readings can be created.

Storing the B-Scan data is similar to creating standard files in the EPOCH 4 database. (See Managing the Datalogger and Data Communication Features on page 85 for specific information.)

To store a file, you must first select or create the file where you want to store the data.

Press  to enter the *Memory* screen. Press [↑] and [↓] to select an existing or new file. If you are selecting a new file, use the alphanumeric keypad to enter a filename and press [F5] or [DISPLAY] to return to the live screen. Return to the B-Scan display by pressing [F5] or [DISPLAY]. Press the [ID] key, enter an appropriate identifier, and press [ENTER].

You can save B-Scans in either the **Start** or **Stop** mode. To save the entire collected B-Scan currently occupying the memory buffer, press [SAVE WAVE]. This action also stores any A-Scans that are associated with the B-Scan due an to Alarm Condition or a Minimum Depth. Pressing [SAVE THICK], saves a screenshot of the B-Scan currently on the EPOCH 4 display along with the associated thickness values for all data points on the display. Data that is not currently on the screen is NOT saved, and NO A-Scans associated with the scan are saved regardless of their position on or off the current displayed B-Scan area.

9.5.13 Viewing and Recalling Stored B-Scans

View stored B-Scans, along with corresponding setup parameters, in the *Memory* screen. If more than 250 readings are collected and saved, the EPOCH 4 displays a compressed image of the entire scan in the *Memory* screen. This data is automatically uncompressed when the data is recalled to the live screen.

When the B-Scan file is recalled to the live screen, press [←] and [→] to move the marker along the scan and review thickness values. If the scan was done in an encoded mode, relative Distance Traveled (DT) values correlate to the thickness measurements. Press [F1] to re-start the scan at the cursor's last position when the scan was saved.

9.6 Spotweld

The inspection of spotwelds using ultrasonic equipment has become increasingly popular due to the cost effectiveness, safety, and reliability of the technique. The EPOCH 4 Spotweld software option makes this application even easier and quicker for the operator.

When the Spotweld option is activated, you can save A-Scan waveform template “overlays” in the instrument's memory. An overlay can represent a waveform from a

certain type of spotweld (Good, Undersized, Stick, etc.) You can customize and save up to five distinct overlays for each particular setup. A setup may consist of a particular transducer and material combination.

During the actual inspection of the spotweld, the operator has the ability to quickly recall these frozen overlays to the live screen. The live waveform is still displayed which allows an easy comparison between the unknown sample and the overlay from the known standard. By matching the live waveform to a particular overlay, the operator can evaluate the acceptability of a certain spotweld.

It is important to note that the Spotweld option goes well beyond the spotweld application alone. Almost all flaw detection applications involve some sort of visual comparison between a known standard and an unknown test sample. With the Spotweld option you can save waveform patterns from known samples and then use them for comparison during the actual inspection. This makes the feature extremely useful for all types of “waveform comparison” flaw detection applications.

9.6.1 Activating Spotweld Mode

To activate **Spotweld** mode, follow these steps:

1. Press [OPTION].
2. Use the slewing keys to select the **Spotweld** sub-menu and press [ENTER].
3. Select **On** and press [OPTION] to exit the menu and return to the live screen.

9.6.2 Defining Switchable Overlays

The Spotweld overlays are stored under keys [F1] – [F5] as follows:

Function Key	Description
[F1]: Good Weld	The reference echo from a good weld.
[F2]: U/S (Undersized) Weld	The reference echo from an undersized weld.
[F3]: Stick Weld	A stick weld condition.
[F4]: Weld A	A storage location for other user-defined welds that may need to be used for testing.
[F5]: Weld B	A storage location for other user-defined welds that may need to be used for testing.

Table 8 Spotweld Overlays

When the overlay prompt appears below the display, pressing the [F1] key displays the frozen waveform overlay of a good weld shown. The overlay waveform is “filled-in”, similar to the Peak Hold function. Pressing [F1] a second time toggles the overlay off.

Pressing [F2], [F3], [F4], or [F5] results in a similar operation with their respective reference waveform overlays.

To store a reference waveform overlay, first obtain the desired waveform on the EPOCH 4 screen by coupling the transducer to the known standard. Use the [FREEZE] key to hold the waveform on the screen. If the waveform represents a “good” weld, press [2ndF] then [F1] to store the waveform in the **Good** location. Likewise, [2ndF], [F2] can be used to store a reference waveform for an Undersized Weld and [2ndF], [F3] can be used to store a reference waveform for a Stick Weld, etc. A reference waveform can be updated by simply by saving over the current saved reference waveform by pressing [2nd F], [F1] again, for example.

The reference waveforms are stored in the battery-backed memory of the EPOCH 4. This means they are saved even when the unit is powered off. These reference waveforms are kept in the battery-backed memory locations until new waveforms are saved in the [F1] – [F5] keys or if you recall a file with a different set of saved overlays.

9.6.3 Accessing Datalogger Storage

Datalogger File Locations 1-9 (Storage of Waveform Overlays)

Datalogger file locations 1-9 are also known as “Quick Recall Calibration Files”. You can save ALL data associated with a Spotweld Inspection Setup in these files. Pressing the [SAVE WAVE] key when the **Spotweld** option is activate, stores the following items in file locations 1-9:

- Live waveform (or frozen waveform if the [FREEZE] key is used)
- Setup parameters
- All reference waveform overlays assigned to the [F1] – [F5] keys

Note that the overlays stored with the setup are NOT visible in the datalogger screen or from the Interface Program. However, the overlays are stored with the setup and will be recalled to their respective [F1] – [F5] key locations when it is recalled to the live screen. Press the [CALIBRATION] key followed by the number of the desired file in the datalogger [1] – [9] to complete this recall procedure.

Datalogger File Locations 10 and higher (Storage of Weld Rating Stamping)

Datalogger file locations 10 and higher are generally used to save data acquired during the actual inspection of spotweld parts. When saving data to files 10+, you can “stamp” the individual Identifier (ID) with a two letter code representing the quality of the weld by pressing the [SAVE THICK] or [SAVE WAVE] key.

- [SAVE THICK] saves the ID with only the thickness reading
- [SAVE WAVE] saves the ID with the thickness reading, waveform, and setup parameters

After one of these keys is pressed, the following prompt appear:

SELECT STAMP TYPE TO SAVE

F1 = GOOD

F2 = UNDERSIZED

F3 = STICK

F4 = WELD A

F5 = WELD B

ENTER = SAVE WITHOUT SPOTWELD STAMP

The information is only saved once you choose the stamp. Each ID that you save has a two letter code attached corresponding to the desired stamp. Examples of thickness readings saved with the various stamps are shown below:

ID>0123456789012345 GD	1.00 in	(STICK)
ID>0123456789012345 US	1.00 in	(UNDERSIZED)
ID>0123456789012345 ST	1.00 in	(STICK)
ID>0123456789012345 WA	1.00 in	(WELD A)
ID>0123456789012345 WB	1.00 in	(WELD B)

9.7 Interface Gate

The Interface Gate is mainly used in immersion applications where the water path distance between the front surface of the test material and transducer face is continuously changing. The application may involve an “on-line” type approach with the test material moving steadily past a stationary transducer (or vice versa.) If the front surface of the test material is not uniform, it results in a slight difference in the water path distance.

The Interface Gate option is designed to graphically compensate for the change in water path distance between the test material and transducer. When the option is activate, a 3rd Gate (Interface Gate) is visible on the EPOCH 4’s display. You can position this Interface Gate in the area where you expect to detect the interface echo. The interface echo is a result of the sound energy reflection at the interface between the water path and the front surface of the test material.

The advantage of using the Interface Gate is that it maintains the interface echo on the left hand side of the EPOCH 4 screen, regardless of the water path distance. The instrument’s flaw gates (Gate 1 and 2) automatically track the location of the Interface Gate.

9.7.1 Activating the Interface Gate

To activate the Interface Gate, follow these steps:

1. Press [**OPTION**].
2. Use the slewing keys to select the **If Gate** sub-menu and press [**ENTER**].
3. Select **On**.
4. Select either **Standard** or **Echo-Echo** mode.

5. Press [OPTION] to exit the menu and return to the live screen.



Figure 59 Selecting Parameters from the Interface Gate Menu

9.7.2 Operating in Standard Mode

This mode is used when flaw detection is the main purpose of the application. The EPOCH 4 provides a digital thickness readout corresponding to the distance between the echo detected in the Interface Gate and the echo detected in Gate 1.

Gate 1 and Gate 2 automatically track the Interface Gate based upon the location of the echo in the Interface Gate. The tracking distance is a result of the “Interface Gate blanking period” which is the distance between the Interface Gate start position and Gate 1 start position. Set this blanking period to optimize the inspection by ensuring the proper echoes are captured in the gates.

9.7.3 Operating in Echo-to-Echo Mode

Use the **Echo-Echo** mode when thickness gaging is the main purpose of the application. The EPOCH 4 provides a thickness readout corresponding to the distance between the echo detected in Gate 1 and the echo detected in Gate 2. The Echo-Echo is also capable of ignoring the thickness associated with a painted or coated surface on the material.

Gate 1 automatically tracks the Interface Gate based upon the location of the echo in the Interface Gate. The tracking distance is a result of the “Interface Gate blanking period” that is the distance between the Interface Gate start position and Gate 1 start position.

Gate 2 automatically tracks Gate 1 based upon the location of the echo in Gate 1. The tracking distance is a result of the “Gate 1 blanking period” which is the distance between the Gate 1 start position and Gate 2 start position.

Note: The Interface Gate option is not valid in **RF** mode or if the EPOCH 4’s standard **Echo-Echo** mode is activated. Also, Interface Gate cannot be turned on or off while the screen is frozen.

9.7.4 Managing Gate Positioning and Alarms

When the Interface Gate option is activated, the Interface Gate is visible on the screen. This gate is in addition to Gate 1 (always displayed) and Gate 2 (can be turned on or off.) The three gates differ in appearance as illustrated below:

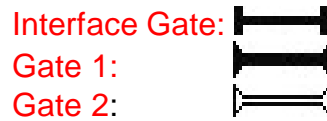

Figure 60 Gate Appearances

The Interface Gate should be positioned in the region where you expect to detect the interface echo (generated from the reflection at the boundary of the water path and the front surface of the test material.) Set a proper gate width and level to ensure this echo continues to break the gate threshold. It is common to set a negative logic threshold alarm on the Interface Gate. This position results in an alarm being triggered if the interface echo falls out of the Interface Gate.

Gate 1 is generally used as an internal flaw gate. Gate 1 is commonly positioned to cover the area where you expect to detect echoes from internal flaws in the test material. Pay attention to the start, width, and level of the gate as the echo height and location corresponds to flaw size. You can choose to set a positive logic threshold alarm on Gate 1. This results in an alarm being triggered if an echo breaks the Gate 1 threshold, indicating a possible critical flaw.

Gate 2 is generally used to monitor the backwall echo of the test material. Gate 2 is commonly positioned to cover the area where you expect to detect the echo from the material backwall. Pay attention to the start, width, and level of the gate to ensure the backwall echo is captured. You can set a negative logic threshold alarm on Gate 2. This position results in an alarm being triggered if the backwall echo falls out of the gate. This could indicate an obstruction (flaw) in the sound wave propagation, thus preventing a backwall echo from being received by the instrument.

9.7.5 Defining Gate Commands

When the Interface Gate is activate, press **[GATE 1]** to view the Interface Gate controls on the function bar menu of the EPOCH 4.

Note: You can press **[GATE 1]** at any time to bring these controls back to the function bar.

1-START	1-WIDTH	1-LEVEL	GATE1/IF	SETUP/IF
---------	---------	---------	----------	----------

[F1] Selects Gate 1 or Interface Gate Start (use slewing keys to adjust position)

[F2] Selects Gate 1 or Interface Gate Width (use slewing keys to adjust position)

[F3] Selects Gate 1 or Interface Gate Level (use slewing keys to adjust position)

[F4] Toggles between controlling the Interface Gate or Gate 1

[F5] Toggles between **Setup** mode and **Run** mode

The **Setup** mode sets up the instrument's parameters and gate positions. The Interface echo is NOT automatically moved to the left side of the screen in this mode.

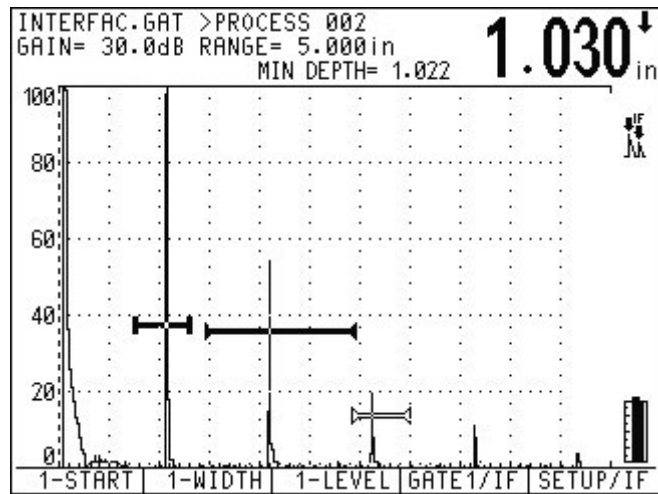

Figure 61 Setup Mode

Select the **Run** mode after you set the gate positions. The Interface echo (the echo breaking the Interface Gate) remains on the left side of the screen (at the zero point) at all times. This results in the Zero Offset (or delay) of the instrument changing dynamically. If **Peak** detection mode is active, the peak of the signal is at the “0” point. If **Edge** is active, the edge of the signal (where it breaks the gate) is at the “0” point.

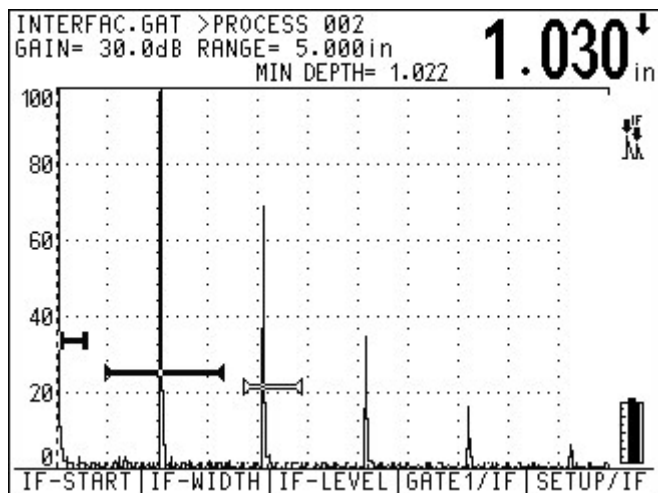

Figure 62 Run Mode

9.8 Floating Gate

The Floating Gate software option is used to track the peak echo amplitude at either the -6dB or -12dB point of the echo. Using the Floating Gate provides a more consistent and accurate thickness reading particularly when using the **Edge Depth** mode.

Using the Floating Gate in either peak depth or **Edge Depth** modes. In **Edge Depth** mode, the Floating Gate tracks the highest amplitude echo breaking the gate, but takes the measurement from the left most echoes breaking the gate.

Note: Floating Gate is included free of charge when you purchase the B-Scan software option.

9.8.1 Activating Floating Gate

To activate the Floating Gate, follow these steps:

1. Press [**OPTION**].
2. Use the slewing keys to select the **Floating Gate** sub-menu and press [**ENTER**].
3. Select the desired gate(s) and choose the -6dB or -12dB position. The default setting is **Off**, which means the particular gate will not float, and instead can be adjusted at the live screen through the gate level parameter.

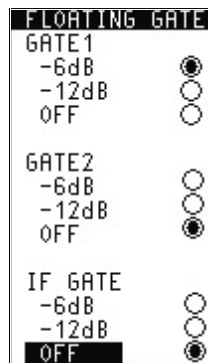

Figure 63 Selecting -6dB from the Floating Gate Menu

4. Press [**OPTION**] to exit the menu and return to the live screen after the selections are made.

Note: The **If Gate** selection in the Floating Gate menu can only be adjusted if the Interface Gate option is enabled and previously turned on in the **Option** menu.

When Floating Gate is active the gate level display in the parameter section of the EPOCH 4 screen shows the setting for that particular gate. The figure below details an example where Gate 1 is floating at the -6dB point, and Gate 2 at the -12dB point.

GATE	START	WIDTH	LEVEL	ALARM
1	0.960	0.612	-6dB	OFF
2	2.935	0.580	-12dB	OFF

Figure 64 Gate 1 Floating at -6dB /Gate 2 Floating at -12dB

9.8.2 Operating in -6dB Mode

In -6dB mode the desired gate floats at 6dB below the peak echo amplitude in the gate. This corresponds to 50% of the echo's maximum height. The screen below depicts Gate 1 with Floating Gate active in the -6dB mode. Note that the gate is exactly at 50% of the echo's peak amplitude.

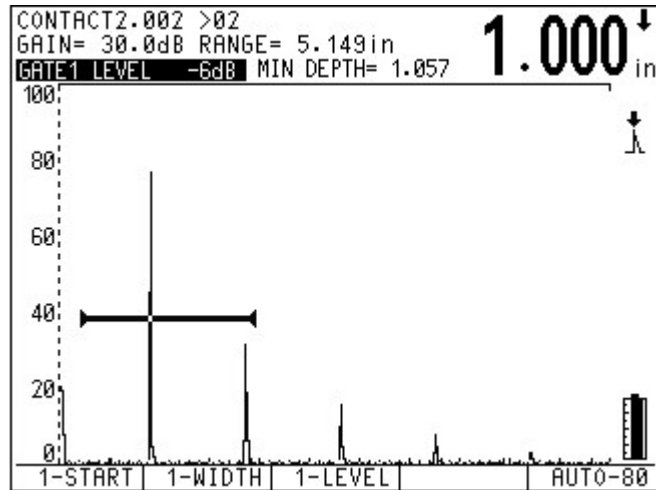

Figure 65 Example of -6dB Mode

9.8.3 Operating in -12dB Mode

In -12dB mode the desired gate floats at 12dB below the peak echo amplitude in the gate. This corresponds to 25% of the echo's maximum height. The screen below depicts Gate 1 with Floating Gate active in the -12dB mode. Note that the gate is exactly at 25% of the echo's peak amplitude.

Note: The Floating Gate option is not valid in **RF** mode. Also, Floating Gate cannot be turned on or off while the screen is frozen.

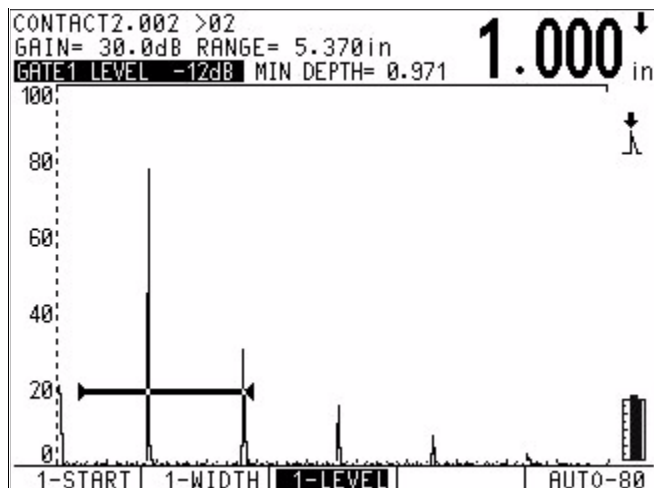

Figure 66 Example of -12dB Mode

9.8.4 Using Gate Alarms

Individual gate alarms can be set while Floating Gate is active. In general practice, select the minimum depth alarms to monitor for thinning areas in the material.

9.9 Expanded Memory

The standard datalogger capacity in the EPOCH 4 allows for a combination of 500 waveforms/calibrations or 10,000 thickness readings. The Expanded Memory option provides the EPOCH 4 with a total capacity of 2,000 waveforms/calibrations or 40,000 thickness readings.

If an EPOCH 4 is purchased with the Expanded Memory option, there is no further setup that is required by you. The instrument's datalogger is simply able to store more information before reaching its capacity.

To confirm that the Expanded Memory option is active in a particular EPOCH 4, press the [OPTION] key. If the **Expanded Mem** selection has a filled in box next to it, the option is active.

Note: To determine the remaining capacity in the EPOCH 4 datalogger, press



to enter the datalogger screen. The remaining number of waveforms or thickness readings that still can be saved is displayed in the center of the screen.

9.10 Curved Surface Correction

The Curved Surface Correction (CSC) option for the EPOCH 4 is used to provide accurate sound path values when inspecting curved surfaces such as pipes. When you enter the pipe diameter and thickness, soundpath information is adjusted accordingly when using an angle beam probe to inspect the circumference of the curved surface.

1. Press [**OPTION**].
2. Use the slewing keys to highlight CSC from the menu and press [**ENTER**].
A appears, indicating CSC option is active. A cursor will appear over the outer diameter value.
3. Use the slewing keys to enter the desired diameter.
4. Press [**F1**] and then [**OPTION**] to return to the live screen. A CSC prompt is displayed to the right of the A-Scan whenever the EPOCH 4 is in CSC mode.
5. Calibrate the EPOCH 4 and be sure to enter the appropriate shear wave angle. Correct soundpath information is displayed when an echo breaks a gate.

Note: The CSC option is linked to the EPOCH 4 memory. If a calibration or waveform is saved in CSC mode the instrument will be in CSC mode when that data set is recalled. A “c” is displayed in the *Memory* screen after the ID to signify the calibration or waveform was saved in CSC mode.

6. Press [**OPTION**] and highlight CSC to exit the CSC mode.
7. Press [**ENTER**] to bring up the CSC setup menu.
8. Press [**ENTER**] to disable the option and deselect the check box.
9. Press [**F1**] to return to the **Option** menu.

9.11 Wave Analysis

The Wave Analysis software option is useful in many specialized applications where operators need to select particular points along an A-Scan waveform and then obtain a timing (thickness) measurement between these two points. In addition, the software displays the dB difference between the two points. An example of where this software is extremely useful is for measuring the scale/oxide layer buildup on the inner diameter of metal pipes. For this application, it is generally recommended to use Panametrics-NDT M116 or V116 transducers.

Note: Surface preparation is almost always required for proper coupling.

The measurement is accomplished when you move two cursors individually along the waveform. The software then calculates the time (distance/thickness) between these two measurement points, along with the dB difference between them. The waveform can either be frozen or live during the measurement. In addition, the software is valid in RF mode and any of the rectified modes.

9.11.1 Activating the Wave Analysis Software:

The Wave Analysis software is enabled in the EPOCH 4 through the Option Security key, similar to the other software options.

To activate the Wave Analysis software, follow these steps:

1. Press [OPTION].
2. Press [↑] or [↓], and [ENTER] to select the **Wave Analysis** option.

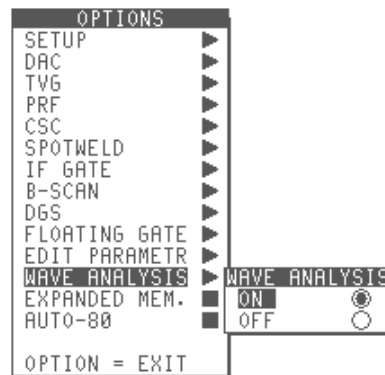

Figure 67 Selecting Wave Analysis from the Options Menu

3. Select **On**.
4. Press [OPTION] to exit the menu and return to the live screen.

Note: Wave Analysis is not valid with other software options in the EPOCH 4 such as DAC, TVG, Interface Gate, etc.

When Wave Analysis is active, the gates on the display disappear and are replaced with *Cursor A* and *Cursor B* as shown in the figure below.

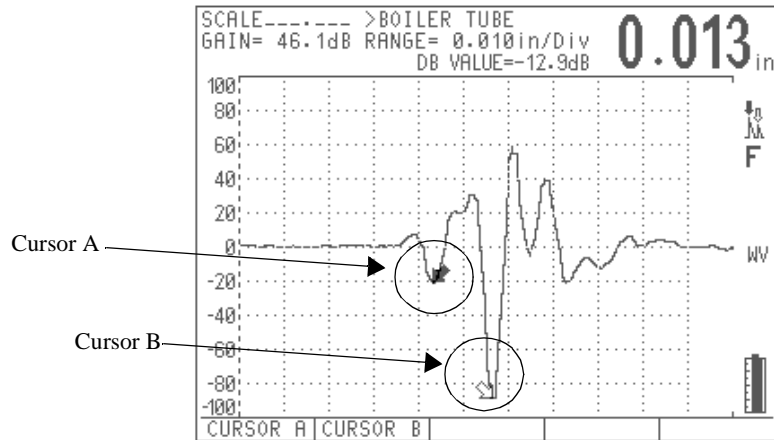

Figure 68 Viewing Changes on Display when Wave Analysis is Active

When Wave Analysis is active, notice **DB VALUE** replaces **MIN DEPTH** at the top of your screen. **DB VALUE** shows you the difference in dB between the two cursors. While the thickness value in the Top Right hand corner shows you the difference in thickness between the 2 cursors.

9.11.2 Moving the Cursors

To move **Cursor A** and **Cursor B**, follow these steps:

1. Select [F1] to access **Cursor A**.
2. Select [F2] to access **Cursor B**.
3. Press [↑], [↓], [←] and [→] to move the cursors along the waveform. The distance and dB difference between the two cursors is continually displayed at the top of the screen.

Note: **Cursor A** always resides in front of **Cursor B**.

Measurements and Cursor Position in RF mode:

- If **Cursor A** and **Cursor B** are both in the positive lobe of the RF waveform, the dB difference and Thickness values will be displayed.
- If **Cursor A** and **Cursor B** are both in the negative lobe of the RF waveform, the dB difference and Thickness values will be displayed.
- If **Cursor A** and **Cursor B** are in opposite lobes of the RF waveform, the dB difference value will be blank.

9.12 DGS

Distance Gain Sizing (DGS), also referred to as AVG in Europe, uses calculated DGS curves to determine whether or not test material passes or fails a particular requirement by displaying the percentage Over Shoot (OS). A DGS curve is actually a series of curves created not only for each of the type of probes or transducers that are used, but also for the range or depth of material that is being tested.

The DGS curves are created for all different probe angles, probe frequencies and test ranges using the DGS Calibration Interface Program. This program allows you to create specific DGS scale electronically for various types of probes and directly download the curves to the EPOCH 4 flaw detector.

Please refer to the DGS operating manual that is included on a CD-ROM with the DGS software option for more information.

9.13 AWS

The AWS D1.1 software option for the EPOCH 4 is intended to assist with performing inspections covered under the American Welding Society D1.1 Structural Welding Code for steel. This code provides inspectors with a method to classify discontinuities found in welds using ultrasonic inspection. This code uses the following formula to develop an indication rating for a reflector found during an inspection:

$$A - B - C = D$$

A = Discontinuity Indication Level (dB)

B = Reference Indication Level (dB)

C = Attenuation Factor: $2 * (\text{soundpath in inches} - 1 \text{ inch})$ (dB)

D = Indication Rating (dB)

As an AWS D1.1 inspector, you must take the Indication Rating (D) that is calculated based on A, B, and C to an *Ultrasonic Acceptance – Rejection Criteria* table produced by the AWS in order to classify the severity of the discontinuity that has been located. When performing an inspection, you are required to develop an AWS report that lists the values for all variables listed above as well as transducer information, discontinuity length and location, and your overall evaluation of the discontinuity.

For further details regarding the test equipment, methods, interpretation, and classification requirements for these inspections, please refer to the AWS D1.1 Code Book.

9.13.1 AWS D1.1 and the EPOCH 4

Panametrics-NDT developed the AWS D1.1 software option for the EPOCH 4 to simplify your tasks and lower the overall inspection time. This is accomplished by having the EPOCH 4 perform some required calculations automatically and also by allowing you to document discontinuities in the EPOCH 4's datalogger for reporting purposes.

The EPOCH 4 can also transfer inspection data to the EPOCH 4 Interface Program to aid in report generation. This program allows you to view the instrument setup parameters, the waveform generated by a discontinuity, the discontinuity's soundpath and location information, and all values for the AWS D1.1 formula variables.

9.13.2 Operating the AWS D1.1 Software

The first step in operating the EPOCH 4 for AWS D1.1 inspections is to calibrate the instrument for the transducer and test conditions. See *Calibrating the EPOCH 4* on page 69 or the appropriate guidelines from the American Welding Society for information on Angle Beam Calibration for the EPOCH 4.

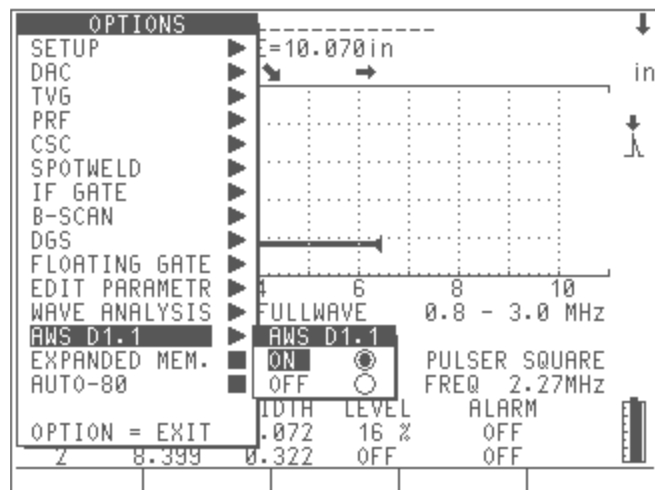

Figure 69 AWS D1.1 Software Option Activated in the Options Menu

When AWS D1.1 is activated, the Function Keys on the EPOCH 4 provide the following options:

- [F1]:** REF B – store the dB value from a reference reflector
- [F2]:** No Function
- [F3]:** No Function
- [F4]:** SCAN DB – toggle the scanning gain between a selected value and zero dB
- [F5]:** AUTO-80 – adjust a gated signal to 80% FSH

After the AWS option is activated from the **Options** menu, you must set a REF B value in order to begin an inspection. This number represents the gain level necessary to bring the echo from a reference reflector to 80% Full Screen Height (FSH). The reference reflector is often a Side Drilled Hole in the calibration block used for the angle beam calibration. Other reference reflectors may be used provided that they meet AWS requirements for these inspections.

In order to store a REF B value, you must gate the echo from the reference reflector and bring the echo to 80% FSH. You can achieve this by pressing the **[GAIN]** key and adjusting the gain with the Up and Down Arrow keys, or by pressing **[F5]** to automatically

adjust the gain to bring the echo to 80% FSH. Once the echo has the appropriate amplitude, press **[F1]** and the following screen will appear:

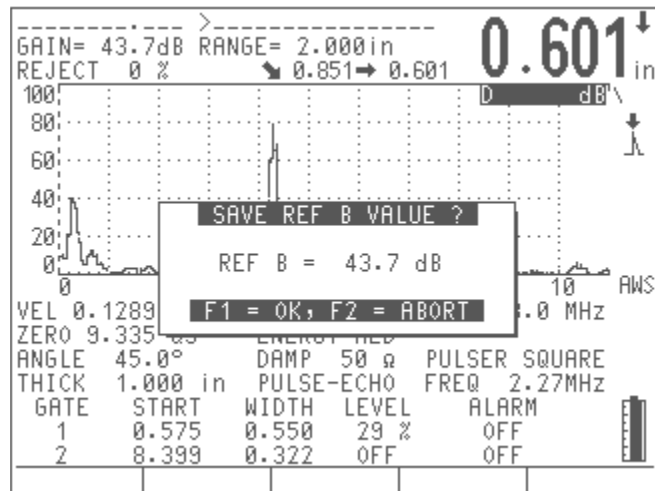

Figure 70 Pressing **[F1]** to Store the REF B Value

9.13.3 Adding Scanning Gain

AWS codes require that an operator enter a certain amount of scanning gain to the REF B dB value allowing the operator to locate flaws that may be smaller or deeper into the test piece than the reference flaw. By pressing **[F4]**, you can enter the amount of scanning gain necessary to perform the inspection as outlined by AWS Code.

The EPOCH 4 allows scanning gain to be entered in increments of 0.1 dB and 6.0 dB by default. However, you can customize these settings by using the Editable Parameters feature that is included with all EPOCH 4 instruments. (See Editable Parameters Software on page 31.) This feature is located in the **Options** menu and there are on-screen prompts explaining how to adjust the F-Key presets values. Once the scanning gain is setup, press **[F4]** to toggle the scanning gain on and off as necessary.

When a discontinuity is located within the test piece, the EPOCH 4 provides a D value corresponding to the discontinuity. However, in order to display a D value, the gated echo must peak at an amplitude less than 100% FSH. Often, you will have to press **[F4]** to turn off scanning gain and bring the echo peak onto the screen. In some cases, further gain adjustments are necessary.

9.13.4 Calculating A and C Values

When a gated echo has a peak below 100% FSH, the EPOCH 4 automatically calculates the A and C values necessary to provide a D value. In order to calculate the A value, the EPOCH 4 automatically calculates the required dB value to bring the gated echo to 80% FSH. In order to calculate the C value, the EPOCH 4 uses the data in the soundpath calculator to generate an attenuation factor.

Note: In order for this calculation to be accurate, you must enter the correct thickness for the test piece. The EPOCH 4 displays the value for D in the upper right hand portion of the A-Scan waveform display.

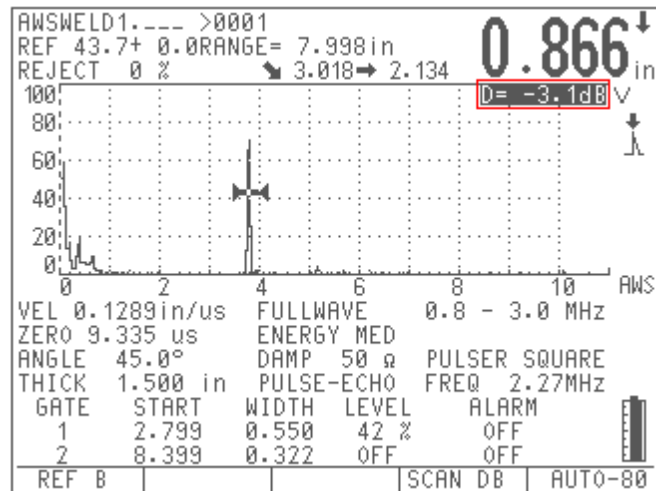

Figure 71 Displaying the D Value

Pressing the [SAVE WAVE] key saves the data for this discontinuity in the EPOCH 4 datalogger. In instruments with operating software version 1.09 and higher, this information is available for review in the instrument datalogger. For instruments with operating software version 1.08, the AWS data must be reviewed in the EPOCH 4 Interface Program version 3.0 or higher.

Note: While using the EPOCH 4 and the AWS D1.1 software option, you must be aware of any inspection conditions that may cause variation in the displayed Indication Rating (D value). You must also be able to interpret the meaning of echo indications and reported D values corresponding to these indications properly.

9.14 Auto-Freeze

The Auto-Freeze software option allows the EPOCH 4 to freeze for a specific period of time when a signal breaks a gate on the display. This is achieved using the Gate Alarms that are already programmed in the instrument. This option is listed in the **Options** menu.

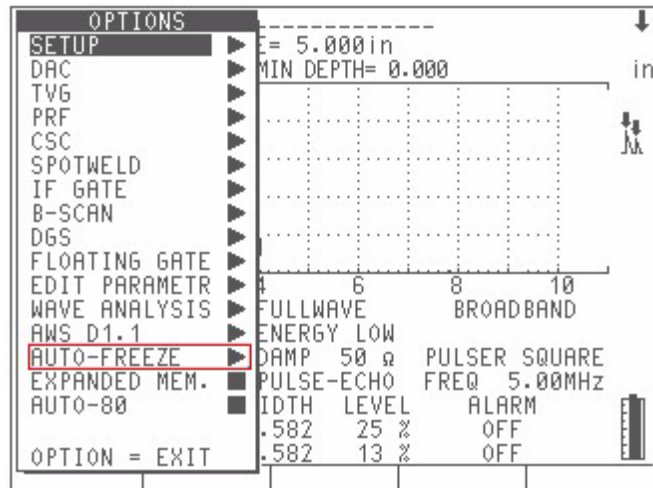

Figure 72 Selecting Auto-Freeze from the Options Menu

The Auto-Freeze option functions with the following options:

- DAC
- TVG
- PRF
- CSC
- SPOTWELD
- INTERFACE GATE

Note: Other EPOCH 4 options are not functional when Auto-Freeze is activated. Auto-Freeze must be deactivated in order to use any other options not listed above.

To setup the Auto-Freeze option, follow these steps:

1. Press [OPTION].
2. Move the highlight bar over the **Auto-Freeze** option and press [ENTER].
3. Select either **Hold** mode or **Time** mode.

Hold Mode: The Auto-Freeze function stays frozen until you press the [FREEZE] key.

Time Mode: The Auto-Freeze function stays frozen for a specific user-defined period of time. When **Time** mode is activated, you must set the amount of time for the EPOCH 4 to freeze using the up and down arrow keys. You can set the EPOCH 4 to freeze for any duration between 1 and 30 seconds.

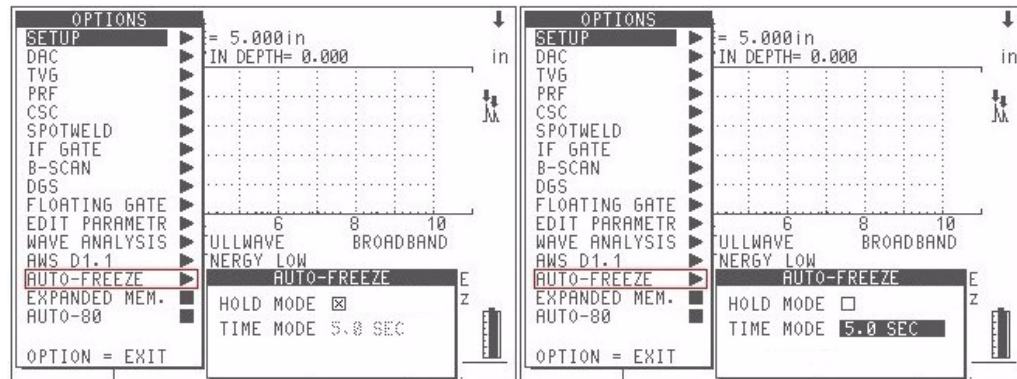

Figure 73 Selecting either Hold Mode or Time Mode

- The Auto-Freeze option is now set, however, before the option becomes active, you need to press [**2nd F**], [**FREEZE**].

Tip: Panametrics-NDT recommends that you adjust the instrument parameters, such as Gain and Pulser Settings, before activating Auto-Freeze.

- Deactivate Auto Freeze at any time by pressing [**2nd F**], [**FREEZE**] again.

In order for the EPOCH 4 to freeze automatically, you need to setup the proper gate alarm(s) so the Auto-Freeze occurs when a gate alarm is triggered. For example, if you position Gate 1 above the first echo location for a spotweld inspection and place a positive logic alarm on gate one, when the echo breaks Gate 1 the EPOCH 4 performs an Auto-Freeze. This function works for all alarms types on both Gate 1 and Gate 2, however it does NOT work for ANY for Interface Gate alarms.

When the Auto-Freeze option is setup and activate, a snowflake icon appears on the right side of the display where the standard FREEZE “F” icon would appear.

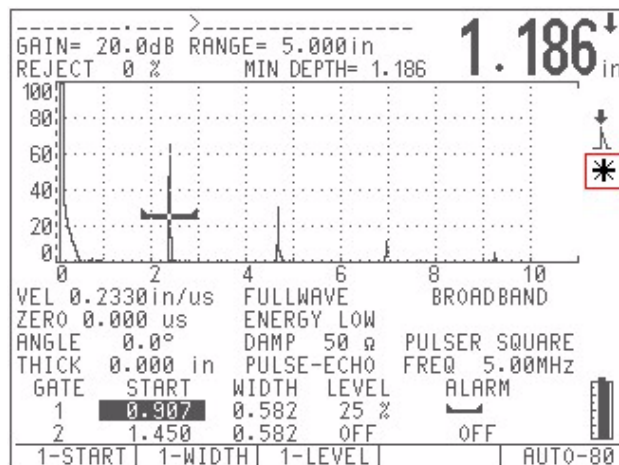

Figure 74 Snowflake Icon Identifies Auto-Freeze is Active

When the EPOCH 4 is frozen in **Hold** mode, the standard FREEZE “F” icon appears. If the EPOCH 4 is frozen in **Time** mode, the “F” icon flashes for the duration of the freeze.

Note: This option does not have any effect on the EPOCH 4’s datalogger or the EPOCH 4 Interface Program. The Auto-Freeze option is not saved with an instrument calibration file. When a calibration is recalled, the Auto-Freeze option must be activated separately.

When a gate alarm is triggered in **Auto-Freeze** mode, the EPOCH 4 should only beep for one-second. The instrument should not have the continuous beep that it normally has in other modes.

The [**FREEZE**] key is active in Auto-Freeze **Time** mode. If you press the [**FREEZE**] key during a timed freeze, the EPOCH 4 immediately becomes unfrozen.

Appendix A – Specifications

DISPLAY	320 pixels (W) x 240 pixels (H) electroluminescent display (ELD) or Liquid Crystal Display (LCD). “Split-screen” allows simultaneous viewing of waveform and setup data. Selectable “filled” or outline waveform trace.
GRATICULE	Electronically generated 2.625" x 2.375" (67 x 60mm). No parallax error. No changes in brightness due to repetition rate changes.
DISPLAY UPDATE RATE	Minimum 60Hz under all test conditions.
SENSITIVITY	110.0dB max. and reference level sensitivity feature with 6dB or 0.1dB selectable resolution.
SELF CALIBRATION	Continuous, automatic self-calibration compensates pulse amplitude and receiver sensitivity for temperature and aging effects.
AUTO CALIBRATION	Automatic calibration of Zero Offset and/or Velocity.
REJECT	Absolutely linear from 0% to 80% full scale in 1% increments.
UNITS	English, Metric, or microseconds.
MATERIAL VELOCITY	0.025 to 0.6000 in/ μ Sec (635 to 15240 m/S). Switchable between two stored velocity settings.
ZERO OFFSET	0 to 350 μ Sec.
RANGE	0.038"– 400" (1– 10,000mm) standard range at the velocity of longitudinal waves in steel.
DISTANCE READOUT	Provides single echo or Echo-to-Echo thickness readings (in large numerals) or soundpath, surface and depth display for angle beam testing. Measures to either peak or leading edge of gated signal. In addition, selectable microsecond readout for time of flight measurements.
REFRACTED ANGLE	Fixed settings of 0 $^{\circ}$, 30 $^{\circ}$, 45 $^{\circ}$, 60 $^{\circ}$, 70 $^{\circ}$, or variable from 10 $^{\circ}$ to 85 $^{\circ}$ in. 0.1 $^{\circ}$ resolution.
GATE START	Variable over entire displayed range.
GATE WIDTH	Variable from Gate Start position to the maximum displayed range.
GATE LEVEL	Off or On with level adjustable from 2% to 95% of full screen in both rectified and RF display modes.
ZOOM	Expands gated portion of display to full graticule width.

PEAK MEMORY	Simultaneous display of live A-Scan at 60Hz update rate and peak envelope of A-Scan.
PEAK HOLD	Freezed Peak Memory echo envelope for waveform comparison with live A-Scan.
SCREEN FREEZE	Freezes and holds waveform and soundpath display. Gates and thickness can be adjusted after the display is frozen.
PULSER TYPE	Negative spike excitation on a tunable square wave.
PULSE ENERGY	Selectable: Low, Medium, High, or Max.
DAMPING	Selectable settings of 50, 63, 150, or 400 ohms.
RECTIFICATION	Full wave, half wave positive or negative, and unrectified RF settings.
ANALOG BANDWIDTH	Broadband, 25MHz at -3dB.
FILTER	Broadband, Narrowband or Custom Selectable Low and High Pass filters.
TEST MODES	Pulse Echo, Dual, or Through-Transmission.
ALARMS	Selectable threshold positive/negative or Minimum Depth modes.
MEMORY	Storage of up to 500 waveforms or 10,000 thickness readings or 400,000 B-Scan readings. Expanded memory to 2000 waveforms, 40,000 thickness readings, or 400,000 B-Scan readings.
IDENTIFIERS	8 character alphanumeric file names with 3 digit file extension and 16 character alphanumeric location codes. Memo mode allows entry of comments. Edit feature allows delete, insert, and clear capabilities.
OPERATING TEMPERATURE	ELD/ -20°C to 50°C (-4°F to 122°F). LCD/ 0°C to 50°C (32°F to 122°F).
STORAGE TEMPERATURE	ELD/ -20°C to 50°C (-4°F to 122°F) with battery. LCD/ -20°C to 50°C (-4°F to 122°F) with battery. ELD/ -40°C to 70°C (-40°F to 158°F) without battery. LCD/ -15°C to 60°C (5°F to 140°F) without battery.
POWER REQUIREMENTS	AC Mains; 100-120VAC, 200-240 VAC, 50-60Hz.
BATTERY	Internal Rechargeable NiMH battery pack rated at 12V at 4000mAH or optional disposable Alkaline "AA" (10) cells.
BATTERY OPERATING TIME	7 hours nominal for ELD display. 10 hours nominal for LCD display

BATTERY RECHARGE TIME	2 hours typical.
BATTERY STATUS	Continuously displayed, low battery warning display when battery life falls below a half hour.
TRANSDUCER CABLE CONNECTORS	BNC or Number 1 Lemo.
KEYPAD	English or International Symbols.
LANGUAGES	Keypad selectable English, French, German, Spanish, Italian, Russian, and user customizable languages available.
RS-232C COMMUNICATIONS PORT	Serial communications port allows interfacing with IBM compatible computers and Epson FX 80 compatible printers. Max baud rate 19.2K.
HIGH SPEED DATA PORT	Allows rapid communication for Raw Data and B-Scan encoder communication.
VGA OUTPUT PORT	Video output port to connect to standard VGA monitor.
DIMENSIONS	(ELD) 11.15" H x 6.55" W x 2.6" T (LCD) 11.15" H x 6.55" W x 2.4" T
WEIGHT	5.7 lbs (2.6 Kg)
WARRANTY	One year warranty, battery not included. Optional second year warranty available.

Appendix B – Sound Velocities

The following table lists the ultrasonic velocity in a variety of common materials. This is only a guide. The actual velocity in these materials may vary significantly due to a variety of causes, such as, composition, preferred crystallographic orientation, porosity, and temperature. For maximum accuracy, establish the sound velocity in a given material by first testing a sample of the material.

MATERIAL	V (in./usec)	V(M/S)	REF
Alumina, Al ₂ O ₃ 99.5%	0.4013	10190	2
Aluminum, rolled	0.253	6420	1
Aluminum, 6061T6	0.251	6383	2
Beryllium	0.5073	12890	1
Brass, yellow 70 Cu, 30 Zn	0.1850	4700	1
Brass, yellow 70 Cu, 30 Zn	0.1726	4385	2
Copper, rolled	0.1972	5010	1
Duraluminum, 17S	0.2487	6320	1
Fused Silica	0.2349	5968	1
Fused Silica	0.2335	5932	2
Glass, crown	0.2008	5100	5
Glass, flint	0.1567	3980	5
Glass, pyrex	0.2220	5640	1
Iron, Armco	0.2345	5960	1
Lead, rolled	0.0771	1960	1
Lucite	0.1055	2680	1
Magnesium, drawn annealed	0.2270	5770	1
Molybdenum	0.247	6250	3
Monel	0.2105	5350	1
Nickel	0.2377	6040	1
Nylon	0.1031	2735	2
Polyethylene	0.0705	1950	1
Polystyrene	0.0925	2350	1
Silicone Rubber RTV	0.0373	0948	4

Table 9 Sound Velocities of Various Materials (Longitudinal Wave Velocity)

Steel, low alloy	0.2259	5734	2
Stainless Steel #347	0.2278	5790	1
Titanium	0.237	5990	3
Tungsten, drawn	0.2129	5410	1
Uranium	0.133	3370	3
Water	0.0590	1498	5
Zinc, rolled	0.1657	4210	1
Zinc, extruded	0.1756	4460	2

Table 9 Sound Velocities of Various Materials (Longitudinal Wave Velocity)

References

1. Folds, D. L. "Experimental Determination of Ultrasonic Wave Velocities in Plastics, Elastomers, and Syntactic Foam as a Function of Temperature." *Naval Research and Development Laboratory*. Panama City, Florida, 1971.
2. Fredericks, J. R. *Ultrasonic Engineering*. New York: John Wiley & Sons, Inc., 1965.
3. *Handbook of Chemistry and Physics*. Cleveland, Ohio: Chemical Rubber Co., 1963.
4. Mason, W. P. *Physical Acoustics and the Properties of Solids*. New York: D. Van Nostrand Co., 1958.
5. Papadakis, E. P. Panametrics - unpublished notes, 1972.

Appendix C – Glossary

Term	Definition
Acoustic Impedance	A material property defined as the product of sound velocity (C) and the material's density (d).
Acoustic Interface	The boundary between two media of different acoustic impedance.
Acoustic Zero	The point on the CRT display which represents the entry surface of the specimen.
Amplifier	An electronic device which increases the strength of a signal fed into it, by obtaining power from a source other than the input signal.
Amplitude	Referring to an indication on the CRT screen, the vertical height of an indication measured from the lowest to the highest point on the indication. In wave motion, the maximum displacement of the particles of the material.
Angle Beam Transducer	A transducer that transmits or receives the acoustic energy at an angle to the surface to set up shear waves or surface waves in the part being inspected.
A-Scan	Pulse-echo format wherein the CRT display shows the pulse travel time in the horizontal direction (left to right) representing the corresponding sound paths. The vertical direction (bottom to top) displays the maximum value of the acoustic pressure echo amplitude received by the probe.
Attenuation	The loss in acoustic energy which occurs between any two points of travel. This loss may be due to absorption, reflection, etc.
Attenuation (M.L.A.)	The loss of sound pressure in a travelling wavefront caused by the scattering of some of the wave's sound pressure by the grain structure and/or porosity of the medium, and by absorption, a conversion of sound energy into heat.
Back or Backwall Echo	The echo received from the side of the specimen opposite the side to which the transducer is coupled. This echo represents the thickness of the specimen at that point.
Background Noise	Extraneous signals caused by sources within the ultrasonic testing system and the material being tested.

Term	Definition
Beam Index Point	The point on the base of an angle beam probe's wedge from which the sound leaves the wedge and enters the specimen.
B-Scan	A sectional representation (side view) of a test specimen, often performed in an immersion system. This can be in the form of a photograph or recorder display.
Cal Block Velocity	Material sound velocity for the calibration block.
Couplant	A material (usually a liquid or gel) used between the transducer and the test specimen to eliminate air from this space and thus facilitate the passage of sound waves into and out of the specimen.
Critical Defect	Either the largest tolerable defect or the smallest intolerable defect. The critical defect size is usually given by a specification or code.
Cross Talk	An unwanted condition affecting dual element transducers in which acoustic energy travels from the transmitting crystal to the receiving crystal by routes other than the intended path through the material.
Damping (Control)	<p>A variable resistance across the pulser circuit output which shapes the excitation pulse. Typically it is used to change pulse characteristics to optimize either penetration (low damping) or near surface resolution (high damping).</p> <p>Note: High damping = Low damping ohms (50Ω) Low damping = High damping ohms (400Ω)</p>
Damping Material	Any gel, rubber-like substance, or other material which, when used in the transducer, results in a shorter ringing time of the piezoelectric crystal.
Decibel (dB)	<p>A unit which compares levels of power. Two power levels P1 and P2, are said to differ by n decibels when:</p> $n = 10 \log_{10} \left(\frac{P_2}{P_1} \right)$ <p>This unit is often used to express sound intensities. In this case, P2 is the intensity of the sound under consideration and P1 is the intensity of some reference level.</p> <p>In the case of the displayed voltages on a cathode ray tube screen, the relationship becomes:</p> $n = 20 \log_{10} \left(\frac{V_2}{V_1} \right)$

Term	Definition
Delay Control	Subcircuit of the sweep generator that allows a variably adjustable time period from the sending of the trigger pulse to the start of the sweep across the CRT.
Detectability	The ability of a test system (instrument and transducer) to detect or “see” a given size reflector. This is also known as “sensitivity.”
Distance Amplitude Correction (DAC)	A method of flaw evaluation that uses a test block with a known size reflector at varying known distances from the transducer. This allows you to plot a curve on the CRT screen that represents the amplitude of that size reflector throughout a given distance range. This curve compensates for the loss of energy due to beam spreading and attenuation.
Dual-Element Probe	A probe containing two piezoelectric elements; one which transmits and one which receives.
Dynamic Range	The ratio of maximum to minimum reflective areas that can be distinguished on the cathode ray tube (usually based on decibel ratios.)
Electronic Zero	The point in time when the pulser fires the initial pulse to the transducer and the point on the cathode ray tube screen where the electron beam leaves the baseline due to the initial pulse signal coming from the transmitter.
First Critical Angle	The minimum incident angle in the first medium at which the refracted longitudinal wave is eliminated from the test specimen.
Flaw	A discontinuity which may be undesirable but does not necessarily call for rejection.
Frequency	The number of complete cycles undergone or produced by an oscillating body in one second.
Gain	Used in electronics with reference to an increase in signal power; usually expressed as the ratio of the output power (for example, of an amplifier) to the input power in decibels.
Gain (Control)	Selects the amount of calibrated gain (dB’s) available within the instrument. Usually consists of a coarse gain control (additions at 20dB increments), and a fine gain (additions at 1 or 2dB increments).
Gate	An electronic baseline display used to electronically monitor portions of the displayed range with reference to distance or amplitude.

Term	Definition
Hertz (Hz)	The derived unit of frequency defined as the frequency of a periodic phenomenon of which the period is one second; equal to one cycle per second. Symbol Hz. 1 Kilohertz (KHz) = 10^3 cycles per second 1 Megahertz (Mhz) = 10^6 cycles per second. Named after Heinrick Hertz (1857-94).
Horizontal A	The smaller length (if rectangular) of the actual crystal. The software will compute the “affective length” automatically.
Immersion Testing	A test method, useful for testing irregularly shaped parts, in which the part to be tested is immersed in water (or other liquid) so that the liquid acts as a couplant. The search unit is also immersed in the liquid, but not in contact with the part being tested.
Incidence, Angle of	The angle between a sound beam striking an acoustic interface and the normal (i.e., perpendicular) to the surface at that point. Usually designated by the Greek symbol α (alpha).
Indication	The signal displayed on the screen signifying the presence of a sound wave reflector in the part being tested.
Indication (Defect) Level	The number of decibels of calibrated gain which must be set on the instrument to bring the indication (defect) echo signal to peak at the reference line on the screen.
Initial Pulse (IP)	The pulse of electrical energy sent by the pulser to the transducer.
Leg	In angle beam testing, the path the shear wave travels in a straight line before being reflected by the opposite surface of the material being tested.
Linearity, Vertical or Amplitude	The characteristics of an ultrasonic test system indicating its ability to respond in a proportional manner to a range of echo amplitudes produced by specified reflectors.
Linearity, Horizontal or Distance	The characteristics of an ultrasonic test system indicating its ability to respond in a proportional manner to a range of echo signals, produced by specified reflectors, variable in time, usually a series of multiple back reflections.
Longitudinal Wave	Mode of wave propagation characterized by particle movement parallel to the direction of wave travel.

Term	Definition
Main Bang	Slang term used to describe the Initial Pulse Voltage.
Mode Conversion	Changing a portion of a sound beam's energy into a wave of a different mode due to refraction at incident angles other than zero degrees. In NDT this usually involves conversion of longitudinal waves into shear waves or surface waves.
Peaking Up	Maximizing the height of any indication displayed on the CRT screen by positioning the main axis of the sound beam directly over the reflector.
Penetration	The ability of the test system to overcome material loss attenuation; i.e., the ability of the sound beam to by-pass small reflectors such as grain boundaries and porosity in the specimen.
Piezoelectric Elements	A family of elements (such as lead metaniobate, quartz, lithium sulfate) that possess the characteristic ability to produce a) A voltage differential across their faces when deformed by an externally applied mechanical force and b) A change in their own physical configuration (dimensions) when an external voltage is applied to them.
Probe	Another name for transducer or search unit
Pulse Repetition Rate or Pulse Repetition Frequency	The frequency with which the clock circuit sends its trigger pulses to the sweep generator and the transmitter, usually quoted in terms of pulses per second (pps).
Range	The distance represented by the entire horizontal CRT screen display.
Receiver	That circuit of a flaw detector that receives both the initial pulse voltage from the transmitter and the returning echoes (as voltages) from the transducer. By passing these incoming signals through certain subcircuits, the signals are rectified, filtered and amplified with the results send to the screen for display.
Reference Echo	The echo from a reference reflector.
Reference Level	The number of decibels of calibrated gain which must be set on the instrument to bring the reference reflector signal to peak at the reference line on the screen.

Term	Definition
Reference Line	A predetermined horizontal line (usually dictated by specifications) on the screen representing some percentage of total screen height (e.g., 40%), at which reference echoes and indication echoes are compared.
Reference Reflector	A reflector of known size (geometry) at a known distance, such as a flat-bottom hole.
Refraction, Angle of	The angle of sound reflection in the wedge which is equal to the angle of incidence (also in the wedge.) The angle of reflectance is measured from the normal to the reflected sound beam.
Registration	The minimum detectable flaw size.
Reject (Control)	Also known as suppression, it limits the input sensitivity of the amplifier in the receiver. "Grass" or scattering noise can be reduced or eliminated from the screen by its use. On most analog instruments it also destroys the vertical linearity relationship between echo heights.
Resolution	The ability of the test system (instrument and transducer) to distinguish reflectors at slightly different depths.
Scanning Level	The number of dB's of calibrated gain above the reference level added to insure seeing potentially significant reflectors at the end of the V-path in a weld inspection.
Second Critical Angle	The minimum incident angle in the first medium at which the refracted shear wave leaves the body of the test specimen.
Sensitivity	The ability of the test system (instrument and transducer) to detect a given size reflector at a given distance.
Signal-to-Noise Ratio	The ratio of amplitudes and indications from the smallest defect considered significant and those caused by random factors, such as grain scattering or instrument noise.
Single Element Probe	A probe containing only one piezoelectric element, which is used to both transmit and receive sound.
Skip-Distance	In angle beam testing, the surface distance which represents one V-path of sound in the material.

Term	Definition
Sound Beam	The characteristic shape of the ultrasonic wave sent into the material.
Sound Path Distance	The distance from the transducer beam index point to the reflector located in the specimen, measured along the actual path that the sound travels. Sometimes referred to as angular distance in angle beam testing.
Straight Beam Probe (Normal Beam Probe)	A probe which transmits the sound into the material perpendicular to the entry surface.
Surface Wave	Mode of wave propagation characterized by an elliptical movement of the particles (molecules) on the surface of the specimen as the wavefront moves forward, this movement penetrating the specimen to a depth of one wavelength.
Through Transmission	A test method in which the vibrations emitted by one search unit are directed toward, and received by, another search unit. The ratio between quantity of vibration sent and received is a measure of the integrity, or quality of the material being tested.
Time Varied Gain (TVG)	Circuit that automatically adjusts gain so that the echo amplitude of a given size reflector is displayed at a constant screen height regardless of the distance to that given size reflector.
Transducer	A device that transforms one form of energy into another.
Transmitter	Circuit of the flaw detector that sends the initial pulse voltage to both the transducer and receiver.
Ultrasonic	Of or relating to frequencies above the human audible range; e.g., above 20,000 cycles/sec. (Hertz).
Ultrasonics	Study of pressure waves which are of the same nature as sound waves, but which have frequencies above the human audible limit, i.e., above 20,000 cycles/sec. (Hertz).

Term	Definition
V-Path	The angular distance sound travels, measured from the top surface of the material to the bottom, and reflecting back up to the top surface.
Vertical B	The larger length (if rectangular) of the actual crystal. The software will compute the “effective length” automatically.
Wavelength	The distance between like points on successive wavefronts; i.e., the distance between any two successive particles of the oscillating medium that are in the same phase. It is denoted by the Greek letter λ (lambda).

Appendix D – Cable Diagrams

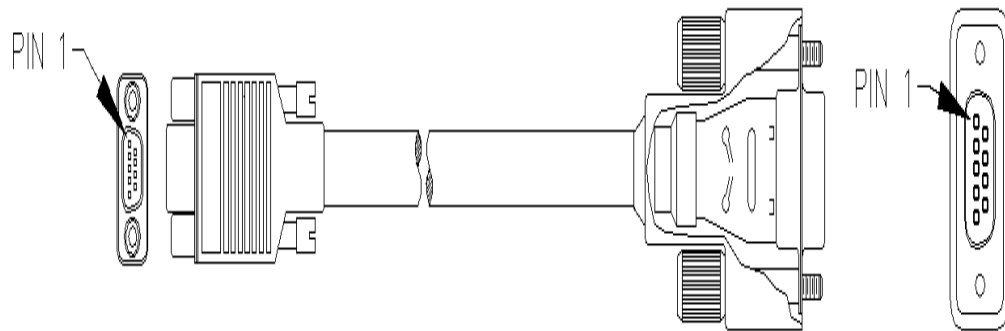

Figure 75 RS232 Serial Cable / Panametrics-NDT Part# EP4/C-9FAT-6

WIRE RUN LIST				
214-767-09 ITT CANNON # MDSM-9SC-Z11-VS-1		236-045 HELIX #E026C0055113	214-693 AMP #747951-1	
SIGNAL	PIN #	WIRE COLOR	PIN #	SIGNAL
RX	2	RED	3	TX
TX	3	ORANGE	2	RX
DTR	4	YELLOW	6	DSR
RTN	5	FOIL/TINNED WIRE/SHELL	5	RTN
DSR	6	BLUE	4	DTR

Figure 76 RS232 Serial Cable Wire Run List

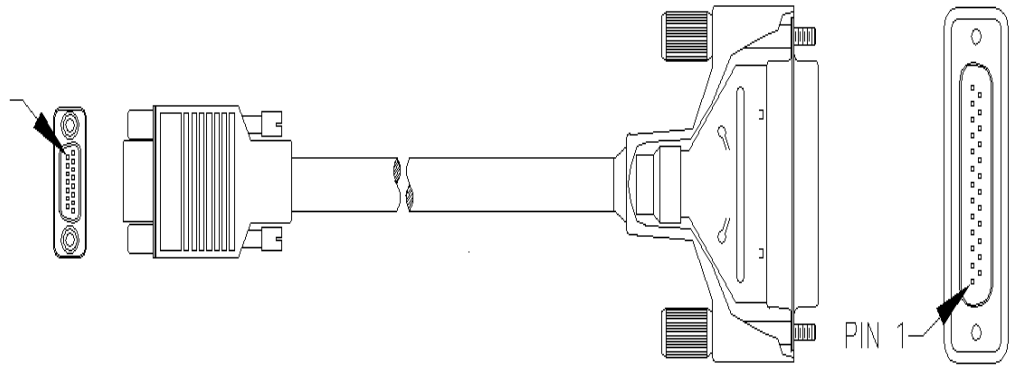

Figure 77 Parallel Port Cable / Panametrics-NDT Part# EP4/C-25PRL-6

WIRE RUN LIST					
214-767-15 ITT CANNON # MDSM-15SC-Z11-VS-1		236-054 ALPHA WIRE #3470/15C		214-773 AMP #747956-1	
SIGNAL	PIN #	WIRE COLOR	PIN #	SIGNAL	
STB-OUT	1	BLACK	10	nACK	
D0	2	RED	2	D0	
D1	3	WHITE	3	D1	
D2	4	GREEN	4	D2	
D3	5	ORANGE	5	D3	
D4	6	BLUE	6	D4	
D5	7	BROWN	7	D5	
D6	8	YELLOW	8	D6	
D7	9	VIOLET	9	D7	
STB-IN	10	GRAY	1	nSTRB	
PORT IN/OUT	13	PINK	14	HOST BUSY	
GND	14	DRAIN/SHELL	11	BUSY	
			12	PAPER END	
			18	GND	
			19	GND	
			20	GND	
			21	GND	
			22	GND	
			23	GND	
			24	GND	
			25	GND	
+5V	15	RED/BLACK	15	nERROR	
			13	SELECT	

Figure 78 Parallel Port Cable Wire Run List

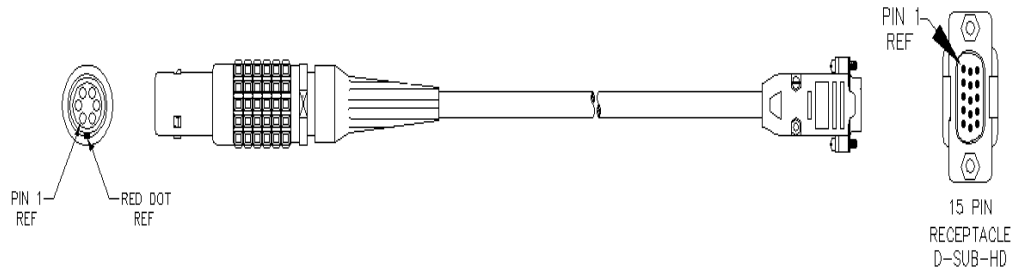

Figure 79 VGA Adapter Cable / Panametrics-NDT Part# EP4/C-15VGA-6

WIRE RUN LIST		
214-697 6 PIN LEMO PIN #	236-045 SHIELDED CABLE HELIX WIRE COLOR	214-771 15 SOCKET HD CONNECTOR PIN #
1	RED	1
2	ORANGE	2
3	YELLOW	3
4	GREEN	13
5	BLUE	14
6	FOILED/TINNED COPPER/SHELL	10,5,6,7,8

Figure 80 VGA Adapter Cable Wire Run List

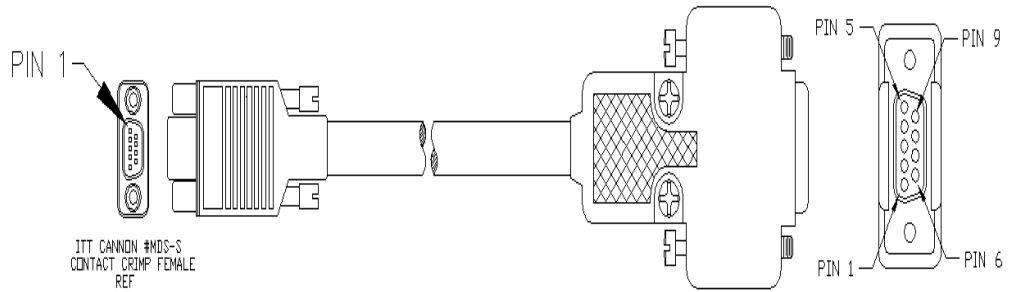

Figure 81 Printer Cable (for DPU-414 Portable Serial Printer) / Panametrics-NDT Part# EP4/PR-Cable

WIRE RUN LIST				
ITT CANNON # MDSM-9SC-Z11-VS-1		HELIX #E026C0055113	AMP # 205204-4	
SIGNAL	PIN #	WIRE COLOR	PIN #	SIGNAL
RX	2	RED	NC	
TX	3	ORANGE	3	RX
DTR	4	YELLOW	NC	
RTN	5	FOIL/TINNED WIRE	5	RTN
DSR	6	BLUE	8	PRNT READY

Figure 82 Printer Cable (for DPU-414 Portable Serial Printer) Wire Run List

Appendix E – Parts List

Part	Description
EP4-BUE-E	Epoch 4 Flaw Detector with ELD Screen
EP4-BUE-L	Epoch 4 Flaw Detector with LCD Screen

Table 10 EPOCH 4 Ultrasonic Flaw Detector

Part	Description
EP4/BAT	NiMH Battery
EP4/MCA-X	Mini Charger Adapter (“X”= Power Cord Configuration)
EP4/CAL-NIST	NIST Calibration Certificate
EP4/MAN	Instruction Manual
EP4/TC	Plastic Transport Case
EP4/PS	Stainless Steel Pipe Stand
EP4/HS	Hand Strap

Table 11 Items Included with the EPOCH 4 (Spares can be purchased)

Part	Description
EP4/DAC	DAC (Distance Amplitude Correction)
EP4/TVG	TVG (Time Varied Gain)
EP4/DAC/TVG	DAC and TVG Combination
EP4/MEM	Expanded Memory
EP4/LPRF	Low PRF (30Hz)
EP4/CSC	CSC (Curved Surface Correction)
EP4/IG	Interface Gate
EP4/SPOTWELD	Spotweld
EP4/FG	Floating Gate
EP4/BSCAN	BSCAN

Table 12 Instrument Software Options

Part	Description
EP4/DGS/AVG	DGS/AVG

Table 12 Instrument Software Options (Continued)

Part	Description
EP4/IP-KIT	EPOCH 4 Interface Program (includes EP4/IP, EP4-IP/MAN and EP4/C-9FAT-6)
EP4/IP	EPOCH 4 Interface Program (software only)
EP4/IP-MAN	EPOCH 4 Interface Program Manual
EP4/C-9FAT-6	EPOCH 4 RS232 Serial Cable

Table 13 PC Interface Program and Accessories

Part	Description
EP4/SC	Shipping Case
EP4/BAT-AA	Alkaline Battery Pack (includes 10 AA cells)
EP4/EC	External Stand-Alone Charger (base only-requires EPOCH 4 charger)
EP4/RPC	Rubber Protective Carrying Case (includes EP4/SS and EP4/CH)
EP4/SS	Sunshade for Rubber Protective Case
EP4/CH	Chest Harness for Rubber Protective Case
EP4/PR	Printer: 110-120V, Seiko DPU-414 (Includes EP4/PR-CABLE)
EP4/PRE	Printer: 230-240V, Seiko DPU-414 (includes EP4/PR-CABLE)
EP4/PR-CABLE	Printer Cable for EP4/PR and EP4/PRE
EP4/PP	Printer Paper (5 Rolls)
EP4/DP-E	ELD Screen Protective Cover (Qty. 10)
EP4/DP-L	LCD Screen Protective Cover (Qty. 10)
EP4/C-15VGA-6	VGA Cable (6.0 ft.)

Table 14 Optional Hardware Accessories

Part	Description
EP4/C-25PRL-6	Parallel Port Cable (25 pin to 25 pin)

Table 14 Optional Hardware Accessories (Continued)

Index

A

- AA alkaline battery 21, 43
- AC line power 19
- Active/inactive software options 97
- Adjusting
 - Pulser Receiver 45
 - system sensitivity 45
- Advanced user 39
 - filter 39
 - save ID 41
 - X-value 39
 - zero offset 39
- Alarm condition storage 68
- Alphanumeric keypad 87–88
- Analog out 38
- Angle beam transducer
 - locating flaws 62–63
- AUTO-80% feature 45–47
- Auto-Freeze 133–136
- AWS 130–133
 - calculating A and C values 132–133
 - operating 131–132
 - overview 130–131
 - scanning gain 132

B

- Basic operations 23
- Batteries
 - AA alkaline 21
 - charging 20–21
 - cycling charge 21
 - Nickel Metal Hydride 19
 - operating time 20
 - replacing 20
- Battery power 19
- Beam Index Point
 - locating 79–80
- Beep 42
- BIP
 - locating 79–80

B-Scan 105–117

- Bi-Directional mode 107–108
- B-Scan mode 106–107
- depth and distance traveled 114
- Echo-to-Echo detection 116–117
- Floating Gate 115–116
- Manual mode 109–110
- minimum depth alarm 114–115
- operating 112–114
- Save A-Scan function 111–112
- saving 117
- Scan Setup menu 110–111
- scan speed alarm 115
- start coordinate 111
- Uni-Directional mode 108–109
- viewing and recalling stored B-Scans 117

C

- Cable diagrams 151
- Calibrating 69–70
 - angle beam transducer 78–79
 - delay line transducer 73–75
 - distance 81–83
 - dual element transducer 75–78
 - sensitivity 83–84
 - straight beam transducer 70–72
- Calibrations, quick recall
 - recalling 92
 - saving 92
- Calibrations, transducer
 - recalling 90–91
- Clock 38
- Curved surface correction 127

D

- DAC 98
 - drawing curves 98–100
 - exiting 101
 - JIS Z3060 curves 100
 - recalling 101

- saving 101
- setting alarms 101
- Damping 49
- Datalogger storage capacity 85–86
- DGS 130
- Display 34
 - flags and markers 36
 - full screen A-scan 34–35
 - split screen 35
- Distance Amplitude Correction 98
 - drawing curves 98–100
 - exiting 101
 - JIS Z3060 curves 100
 - recalling 101
 - saving 101
 - setting alarms 101
- Documentation
 - related documentation 18
 - revision history 18
 - sending comments 18
 - typographic conventions 17

E

- Echo-to-Echo thickness readings 61–62
- Editable parameters 31–33
- ELD screen adjustment 23–24
- EPOCH 4
 - audience 16
 - product description 15
- Expanded memory 126

F

- File
 - clearing 93
 - creating 88–89
 - deleteing 94
 - editing 93
 - exiting edit function 94
 - inserting 93
 - swaping locations 94
- Filled live 43
- Filled peak 43

- Filter 39
- Flags 36
- Floating gate 124
 - 12db mode 125
 - 6dB mode 125
 - activating 124–125
 - alarms 126

G

- Gain reference level 47
- Gate alarms
 - alarm condition storage 68
 - minimum depth alarm 67
 - minimum depth alarm in the Echo-to-Echo measurement mode 68
 - minimum depth alarm with a single gate 67
 - negative logic alarm 66
 - positive logic alarm 67
 - threshold alarms 66–67

Gates

- positioning gate 1 59
- positioning gate 2 59

- Glossary 143

- Grid 42

I

- ID codes
 - clearing 95
 - creating 88–89
 - deleting 95
 - editing 94
 - incrementing 90
- Interface gate 120
 - activating 120
 - alarms 121
 - commands 122–123
 - Echo-to-Echo mode 121
 - positioning 121
 - standard mode 121

J

JIS Z3060 DAC Curves 100

K

Key, datalogger
 alpha entry 30
 alphanumeric entry 31
 database edit 30
 ID entry 30
 memo entry 30
 move cursor left 29
 move cursor right 30
 number entry 30
 open datalogger 29

Key, main

 calibration 29
 contrast 29
 depth/% amp 29
 display 28
 Echo-to-Echo 29
 enter 24, 27
 filter 28
 freeze 27
 gate 1 27
 gate 1 alarm 27
 gate 2 27
 gate 2 alarm 28
 peak hold 28
 peak mem 28
 print data 28
 pulser 28
 reference level 27
 save thick 27
 save wave 27
 sensitivity 26

Keypad 24

 English 25
 functions 25
 international 26
 lock 43

L

Language 37

LCD screen adjustment 23–24

M

Markers 36

Measuring signal amplitude 63–64

Memory

 expanded 126
 screen 86–87

Memos

 creating 92–93

Minimum depth alarm 67

 Echo-to-Echo measurement
 mode 68
 single gate 67

N

Narrowband filters

 advanced user mode 51–52
 standard user mode 50–51

Nickel Metal Hydride 19

P

Parameters 37

Parts list 155

Peak hold 56

Peak memory 55–56

Power supply

 AC line power 19
 battery power 19
 operating 19
 operating time 20

Powering-up 23

Preface 15

PRF 104

 activating 104
 exiting 104

Printing 95–96

Pulse Repetition Frequency 104

 activating 104
 exiting 104

Pulser energy 49

Pulser frequency selection 52–53

Pulser key 48

Pulser type selection 52

Q

Quick recall calibrations
 recalling 92
 saving 92

R

Refracted angle (beta)
 verifying 80–81
Reject 55
RS232 setup 41–42

S

Save ID 41
Scanning gain 47
Screen freeze 56–57
Signal amplitude
 measuring 63–64
Sound velocities 141
Special waveform functions 55
Specifications 137
Spotweld 117
 activating 118
 datalogger storage 119–120
 switchable overlays 118–119
Switchable overlays 118–119

T

Test mode 50
Thickness readings 60–61
 saving 89–90
Threshold alarms 66–67
Time Varied Gain 101
 activating 102–103
 calibrating 102–103
 exiting 103
 recalling 103
 saving 103
Time-of-Flight (TOF) mode 64–65

TOF mode 64–65
Transducer calibrations
 recalling 90–91
TVG 101
 activating 102–103
 calibrating 102–103
 exiting 103
 recalling 103
 saving 103
Typographic conventions 17

U

Units of measurement 38

V

VGA output 42

W

Warranty 3
Wave Analysis 127–129
 activating 128–129
 moving cursors 129
Waveform functions
 peak hold 56
 peak memory 55–56
 reject 55
 screen freeze 56–57
Waveform rectification 48
Waveforms
 recalling 90–91
 saving 89–90

X

X-Value 39

Z

Zero offset 39
Zoom 65–66

Documentation Comments

Panametrics-NDT is always interested in improving its documentation. Please complete this questionnaire and return your responses to:

Panametrics-NDT
info@panametrics-NDT.com

Thank you for helping us improve our documentation!

Note: The following questionnaire is adapted from the “Judging Form” from the Boston Chapter, Society for Technical Communication, Technical Publications Competition, and “Revision Checklist” from John Lannon’s *Technical Writing*, Seventh Edition (Addison Wesley Longman, 1997).

Document title : _____

Document number: _____

Documentation Usability Ratings

In the sections that follow, please rate the usability of the document according to the following rating system:

1 - Poor 2 - Below Average 3 - Average 4 - Above Average 5 - Excellent

Audience and purpose

Is the purpose of this manual clearly stated?	1	2	3	4	5
Does the document fulfill the purpose?	1	2	3	4	5
Is the audience clearly defined?	1	2	3	4	5
Does the document meet the audience’s needs?	1	2	3	4	5

Organization

Do the instructions follow the exact sequence of steps?	1	2	3	4	5
Is the organization appropriate and logical at all levels?	1	2	3	4	5
Are the headings specific and helpful?	1	2	3	4	5
Is the Table of Contents complete and useful?	1	2	3	4	5
Is the index comprehensive, easy to use, and cross-referenced?	1	2	3	4	5

Content

Do explanations enable readers to understand what to do?	1	2	3	4	5
Do notes, cautions, or warnings appear whenever needed, in the appropriate place?	1	2	3	4	5
Is everything accurate?	1	2	3	4	5
Are the main points properly stressed?	1	2	3	4	5

Are there sufficient helpful examples? 1 2 3 4 5

Writing and Editing

Is the reading level appropriate to the audience? 1 2 3 4 5

Are the tone and style appropriate for the purpose and audience? 1 2 3 4 5

Is terminology consistent? 1 2 3 4 5

Are grammar, syntax, spelling, and punctuation correct? 1 2 3 4 5

Illustrations

Do the illustrations contribute to the usefulness of the document? 1 2 3 4 5

Are the illustrations effectively integrated into the text? 1 2 3 4 5

Are the illustrations clearly labelled? 1 2 3 4 5

Layout and Design

Is the layout effective for the audience and purpose? 1 2 3 4 5

Is the overall design consistent and coherent? 1 2 3 4 5

Overall Document 1 2 3 4 5

Additional Comments

Which topics are not covered that you would like to see covered in the next revision?

Errors found in this manual:

Page Description of Error

Name _____ Company _____

Mailing Address _____

Phone _____ E-Mail Address _____

Fax No. _____