

A 1 KW Thermoelectric Generator for Low-temperature Geothermal Resources

Changwei Liu, Pingyun Chen, Kewen Li*

China University of Geosciences, Beijing

29 Xueyuan Road, Beijing 100083, China

*Corresponding author e-mail: likewen@cugb.edu.cn

Keywords: One KW TEG system; direct power generation; thermoelectric effect; TEG; low temperature

ABSTRACT

Most of the current thermal power-generation technologies must first convert thermal energy to mechanical work before producing electricity. Thermoelectric generation technology, as one entirely solid-state energy conversion method, can directly transform thermal energy into electricity by using thermoelectric transformation materials. A thermoelectric power converter has no moving parts, and is compact, quiet, highly reliable and environmentally friendly. Therefore, the whole system can be simplified and operated over an extended period of time with minimal maintenance. In addition, it has a wider choice of thermal sources. It can utilize both the high- and low-quality heat to generate electricity. The low-quality heat may not be utilized effectively by conventional methods such as ORC technology.

In this study, a direct heat to electricity (DHE) technology using the thermoelectric effect, without the need to change through mechanical energy, was applied to harvest low-enthalpy thermal work. Such a power generation system has been designed and built using thermoelectric generator (TEG) modules manufactured using a new technique. The targets of this technique were low cost and high thermal to electricity efficiency. Experiments have been conducted to measure the output power at different conditions: different inlet temperature and temperature differences between hot and cold sides. TEG modules manufactured with different materials have also been tested. The power generator assembled with TEG modules had an installed power of 1 KW at a temperature difference of around 120 °C. The power generated by the thermoelectric system is almost directly proportional to the temperature difference between the hot and the cold sides. The cost of the DHE power generator is much lower than that of photovoltaics (PV) in terms of equivalent energy generated. The TEG systems are ready to be applied practically in many geothermal sites with low temperature resources, including oil fields where fossil and geothermal energies are co-produced.

1. INTRODUCTION

Geothermal energy is one of the largest sources of renewable energy according to the World Energy Assessment (WEA, 2000). Among the vast number of geothermal resources, a great proportion are low temperature (<150°C). Most of the potential co-produced geothermal energy associated with oil and gas fields is in the range of low temperature (Erdlac, et al, 2007, Li, et al., 2007, Xin, et al., 2012, Bennett, et al., 2011). The frequently-used technology to generate electricity by using this type of low enthalpy geothermal or other thermal energy is Organic Rankine Cycle (ORC) binary power generator. A noteworthy example is the 250 kW ORC plant in Chena Hot Springs, Alaska, which produces electricity from a very low temperature (74°C) geothermal resource (Erkan, et al., 2007).

Compared with solar and wind systems, geothermal energy has many advantages, including being impervious to weather changes, having a stable base load, and high thermal efficiency (for high temperature geothermal resource). However, the total capacity of installed geothermal power lags behind solar and wind. In 2011, the installed power of PV and wind were 70 and 240 GW, respectively. According to Geothermal Energy Association (GEA), the total geothermal power installed in the world was about 11.2 GW as of May 2012. The average annual growth rate of geothermal power is about 2%, while that of PV is about 58% during the same period of 2006-2011 and up to 74% in 2011 (REN 21, 2012).

Li (2013) discussed likely factors leading to the low growth rate of geothermal energy. The main factors include high initial investment, high exploration risk, long payback and construction time, difficulty to assess resource, and difficulty to modularize. Li (2013) also pointed out possible directions to accelerate the growth of geothermal power. One of the solutions may be the large-scale utilization of TEG technology.

Since 1821, many researches have investigated the application of thermoelectric materials. Thacher (2007) developed a thermoelectric power generator using car exhaust heat. The maximum power output reached 255 W. Kajikawa and Onishi (2007) developed an advanced thermoelectric conversion exhaust system in a light truck. Maneewan and Chindarksa (2009) investigated the characteristic and performance of TEG modules for power generation at low temperatures. The unit achieved a power output of 2.4 W with a temperature gradient of approximately 150°C. The conversion efficiency was about 3.2%. Niu et al. (2009) constructed an experimental thermoelectric generator unit; a comparison of the experimental results with those from the previously published numerical model was analyzed. Hsu (2011) developed a low-temperature waste heat system to utilize the car exhaust heat as well. When the engine rate boosted to 3500 RPM, 12.4 W of maximum power output was obtained at an average temperature difference of about 30°C.

Numerical modeling of TEG systems has also been investigated. Esarte et al. (2001) analyzed the influence of fluid flow rate, heat exchanger geometry, fluid properties and inlet temperatures on the power supplied. Chen et al (2005) assumed that heat-transfer obeys the linear phenomenological heat-transfer law and studied the performance of multi-element thermoelectric-generators. Yamashita (2008) developed new thermal rate equations by taking the temperature dependences of the electrical resistivity and thermal conductivity of the thermoelectric (TE) materials into the thermal rate equations on the assumption that they vary linearly with temperature. Freunek et al. (2009) described an analytical model for thermoelectric generators and found that the influence of

the Peltier heat on the output power was about 40%. Eisenhut and Bitschi (2006) derived an analytic model based on convective heat sources. Liu (2012) presented the designs of electricity generators based on thermoelectric effects using heat resources of small temperature differences. Karabetoglu et al. (2012) reported the approach to characterizing a thermoelectric generator at low temperatures. Xiao et al. (2012) designed a solar thermoelectric generator using multi-stage thermoelectric module; the total conversion efficiency was 10.52%. Suter et al. (2012) established a numerical model for a 1kWe thermoelectric stack for power generation, which may help define the configuration and operating parameter range that are optimal from a commercial standpoint. Wang et al. (2013) presented a mathematical model of TEG and preliminary analysis of factors. Kim (2012) derived a model describing the interior temperature difference as a function of the load current of a thermoelectric generator (TEG) and the results showed approximately 25% of the maximum output power is lost because of the parasitic thermal resistance of the TE module used in the experiment.

Thermoelectric generation technology (2006), as one entirely solid-state energy conversion method, can directly transform thermal energy into electricity by using thermoelectric transformation materials. A thermoelectric power converter has no moving parts, and is compact, quiet, highly reliable and environmentally friendly. Therefore, the whole system can be simplified and operated over an extended period of time with minimal maintenance. In addition, it has a wider choice of thermal sources. It can utilize both the high- and low-quality heat to generate electricity. The low-quality heat may not be utilized effectively by conventional methods such as ORC technology.

In this study, we built a power generation system using TEG modules and conducted experiments to measure the output power at different temperature gradients and other conditions. We also tested the efficiency of TEG modules manufactured with different materials. The cost of the power generator using TEG technology was estimated and the results showed that TEG technology was competitive to PV technology. This report is modified from the previous version (Li, et al., 2013).

2. POWER TESTING OF DIFFERENT TEG MODULES

We tested five different modules with different semi-conduct materials in order to find the TEG with the maximum output at a specific temperature difference. Fig. 1 shows the schematic of the module tests. The TEG module was clamped tightly in between two containers, one was the hot side with a high temperature and another was the cold side with a low temperature.

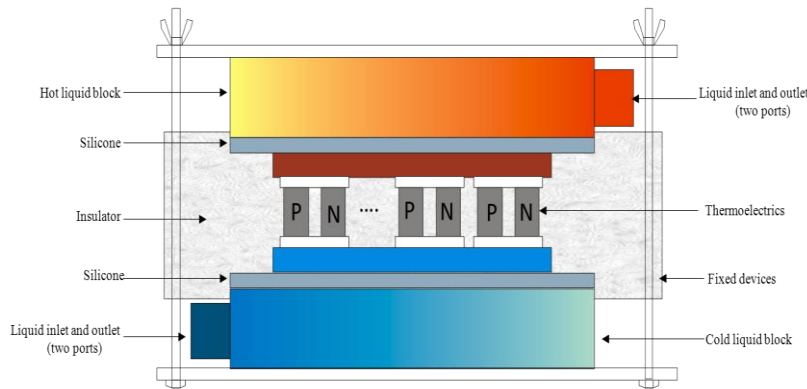

Figure 1: Schematic of the module test.

Table 1 lists the size and the approximate cost of each module. Module 5 was the most expensive TEG and Module 4 was the cheapest one.

Table 1: Property of different TEGs.

Type	Size(cm ²)	Cost(US\$)
Module 1	16	10.5
Module 2	16	4.5
Module 3	16	7.7
Module 4	16	3.4
Module 5	9	30.8

We kept the temperature on the hot side at about 200°C by using a digital thermostat oil bath and used the tap water as the cooling liquid on the cold side with a temperature of about 20°C. The temperatures of both hot and cold sides were measured and the results are shown in Fig. 2. The temperature was measured using two micro-thermocouples with very thin tips. The temperature on the hot side of the modules was stabilized at about 180°C and that on the cold side at about 40°C. The increase in the temperature on the cold side from 20 to 40°C was because of the heat conduction from the hot side through the TEG modules. The temperature difference was stabilized at around 140°C. The results illustrate that the test system for thermoelectric power generation was stable.

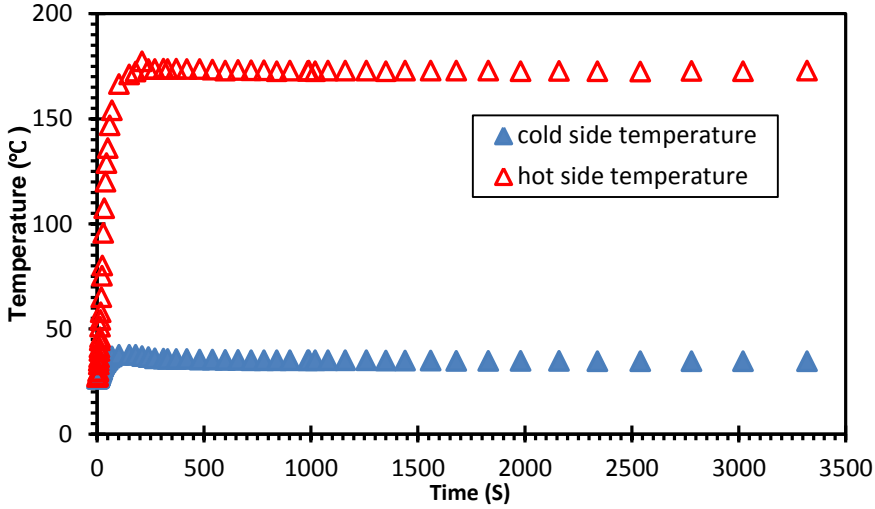

Figure 2: Temperatures on the hot and cold sides of the module

With the stable temperature difference of 140°C, we measured the output power of the five different TEG modules. The results are shown in Fig. 3. Three out of the five thermoelectric modules, Modules 2, 3, and 4, generated power more than 4.5 W.

The power ratio (power generated by each TEG module divided by the cost) was calculated and the results are shown in Fig. 4. Obviously, Module 4, with the cost of 3.4 dollar each, has the highest power-cost ratio.

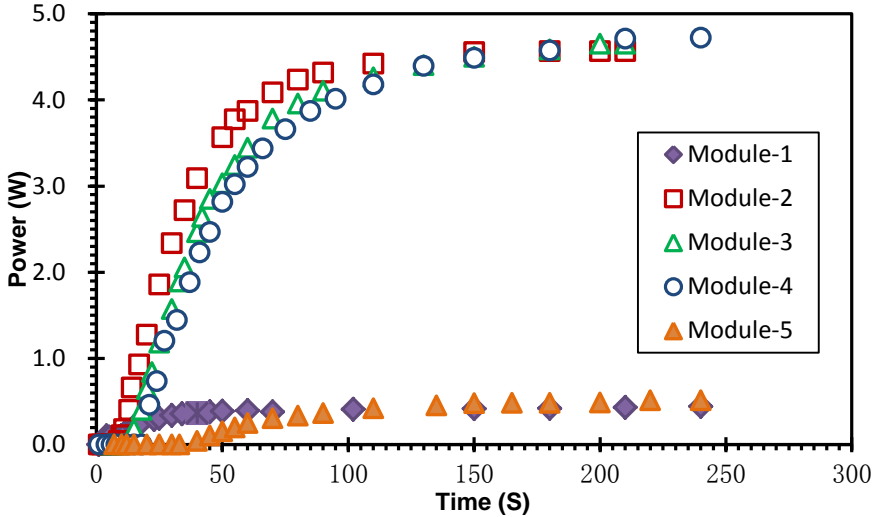

Figure 3: The power generated from different modules

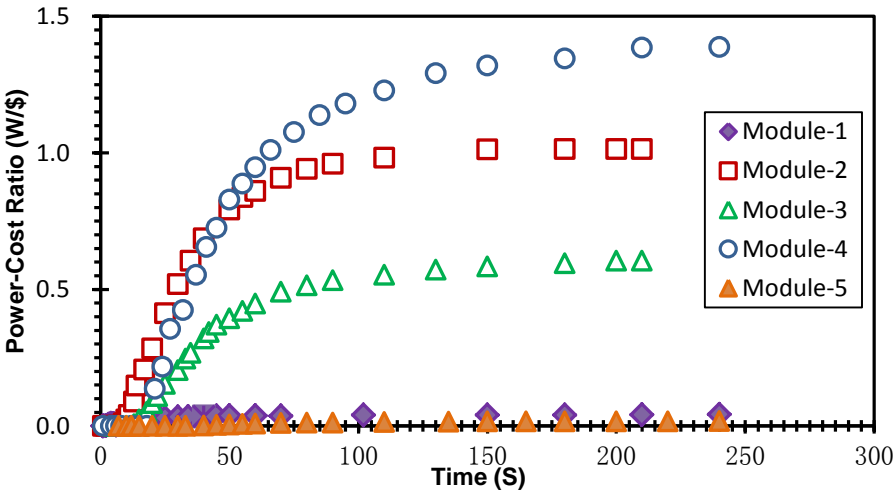

Figure 4: The power-cost ratio of different TEG modules

Note that Module 5 with the highest cost generated less power and yielded the lowest power-cost ratio at a temperature difference of about 140°C. The above test results do not imply that Module 5 is valueless because Module 5 was originally manufactured for operating temperatures as high as 300°C. Thus, Module 5 may work better at high temperatures than other modules.

Efficiency is the key parameter for power generation. A theoretical model is frequently used to calculate the efficiency of TEG. For a single thermoelectric module:

$$\eta_i = P/Q \quad (1)$$

$$P = I^2 R_L \quad (2)$$

$$Q = \alpha T_H I + K(T_H - T_C) - 1/2 I^2 R_L \quad (3)$$

Where η_i is the efficiency of the thermoelectric module, P is the output power and Q is the total quantity of heat, α is the seebeck coefficient. K is the heat transfer coefficient, R_L is the load resistance, T_H and T_C is the temperature of the hot and cold side respectively.

$$\eta_{imax} = \frac{T_H - T_C}{T_H} \cdot \frac{(1 + Z\bar{T})^{1/2} - 1}{(1 + Z\bar{T})^{1/2} + T_C/T_H} \quad (4)$$

here $\bar{T} = (T_H + T_C)/2$. ZT is the dimensionless figure of merit and its value, ranging from 0.2 to 2, varies with temperature. The efficiency calculated according to the theoretical model (Eq. 4) is shown in Fig.5. The temperature of cold side was stabilized initially at about 30°C, and then changed to 40°C, 50°C, 55°C, 60°C, 65°C, 70°C, 75°C, 80°C, 85°C, and 90°C respectively. Based on the current thermoelectric technology, the value of ZT reaches about 1.0 and the efficiency can hardly reach 4% when the hot side temperature was around 100°C (see Fig. 5).

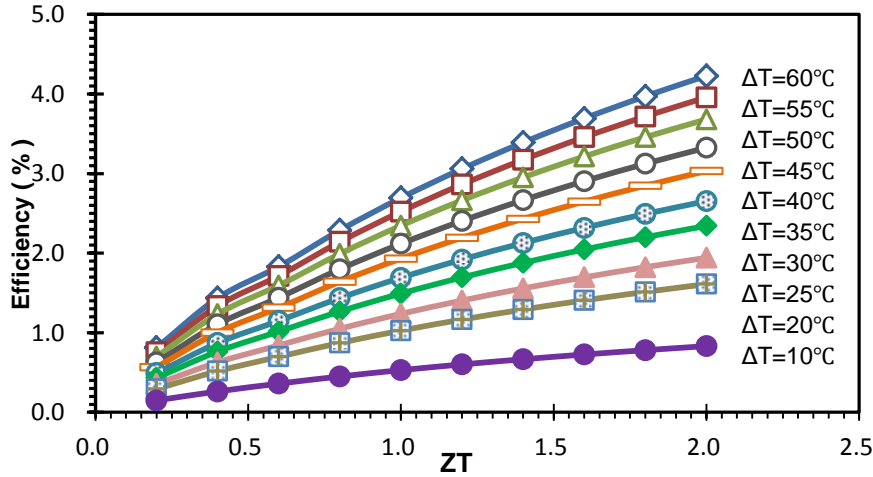

Figure 5: The efficiency of thermoelectric module at different ZT and temperature difference

However, the theoretical model (Eq. 4) for calculating the efficiency of thermal power generation using TEG may not be very accurate because the seebeck coefficient varies with the temperature or other parameters. Nonetheless we propose a different approach to estimating energy conversion efficiency from thermal to electricity. We define this efficiency as the ratio of the maximum electricity generated from thermal energy to the total thermal energy per unit volume of hot water. This efficiency is defined as “global efficiency”. Using such a concept, it is easier to estimate how many KW of electricity could be generated using per unit volume (for example, one ton) of hot water with a specific temperature difference, which is a common engineering question of interest. The mathematical models for determining the global efficiency are presented as follows.

The total heat energy of the hot liquid can be calculated by the following equation:

$$E_t = C \cdot m \cdot \Delta T \quad (5)$$

Where E_t is the total thermal energy of the hot side liquid, C is the specific heat capacity, m is the mass of the hot side liquid, ΔT is the temperature difference between the cold and hot sides.

The maximum electricity generated by TEGs can be calculated:

$$W_i = P_i \cdot t \quad (6)$$

here W_i is the electric energy generated by TEGs, P_i is the instantaneous power, t is the time interval at i^{th} step. The global efficiency of a TEG system can then be computed:

$$\eta_g = \sum_{i=1}^n W_i / E_t \quad (7)$$

Where η_g is the global efficiency of a TEG system.

The experimental procedures for measuring global efficiency from thermal to electricity are described briefly as follow:

- (1) Fill the hot side container using water with a temperature of T_H and a mass of m , keep the temperature of cold side liquid at T_C . The total heat energy of the hot liquid can be calculated using Eq. 5.
- (2) Collect the data of the electricity generated by a TEG system every second until it decreases to zero. The total electricity generated from the hot liquid can be calculated using Eq. 6.
- (3) The global efficiency of a TEG system can be calculated using Eq. 7 with the above experimental data.

The efficiency and cumulative electricity output data of module 4 were measured using the above experimental procedures by decreasing the hot side temperature from 95°C to 30°C and keeping the cold side temperature at 30°C. The experimental results are shown in Fig.10. It is clear that the growth rate of electricity output slows down when the temperature of the hot water on the hot side decrease to 80°C. The global efficiency was about 10%, which is greater than η_i . This is because η_i is the instantaneous energy conservation efficiency.

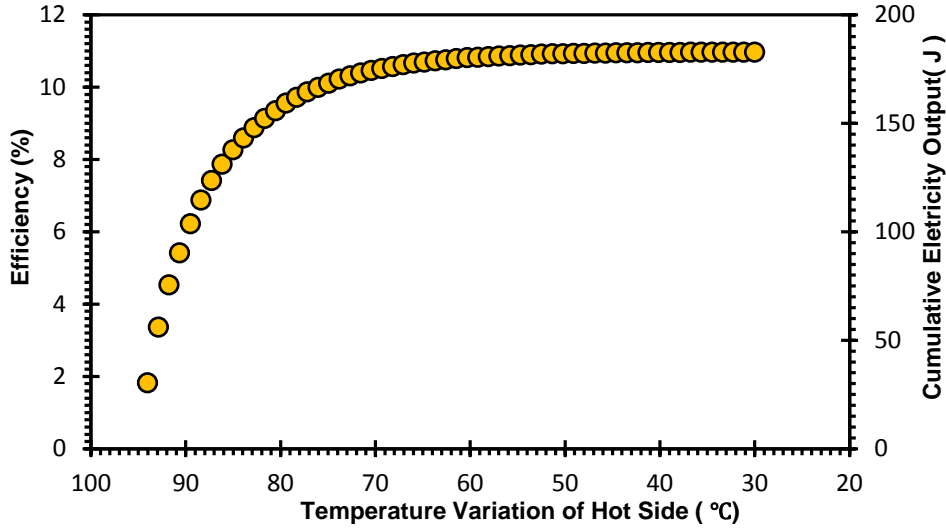

Fig.6. Efficiency and cumulative electricity of thermoelectric module (#4) with the hot side temperature difference

3. POWER TESTING WITH DIFFERENT HEAT-CONDUCTING MEDIA

The heat-conducting medium between the ceramic plate and liquid block plays a very important role for the TEG systems. Both thermal conductivity and cost should be taken into account. In this study, some commercially available heat-conducting media were used for the comparison tests. The property data of the heat-conducting media are shown in Table 2.

Table 2: Properties of heat-conducting media

Medium Name	Thermal conductivity (W/m-K)	Cost(US\$)
Silicone Film	6.0	17.7
Graphite Sheets	15.0	2.5
Silicone Grease	3.0	24.1

The measurements of output power for Module 4 were conducted when different heat-conducting media were used. The high temperature on the hot side was provided by a thermostatic heating station and the hot side temperature was kept at about 80°C. Tap water with a temperature of 20°C still served as the cold side. At the same time, we chose two different size modules for the test: 40mm × 40mm and 50mm × 50mm.

The power test results are shown in Fig. 7. The power generated is proportional to the module's area. In this study, the 40mm × 40mm size modules were used for the experiments in next section.

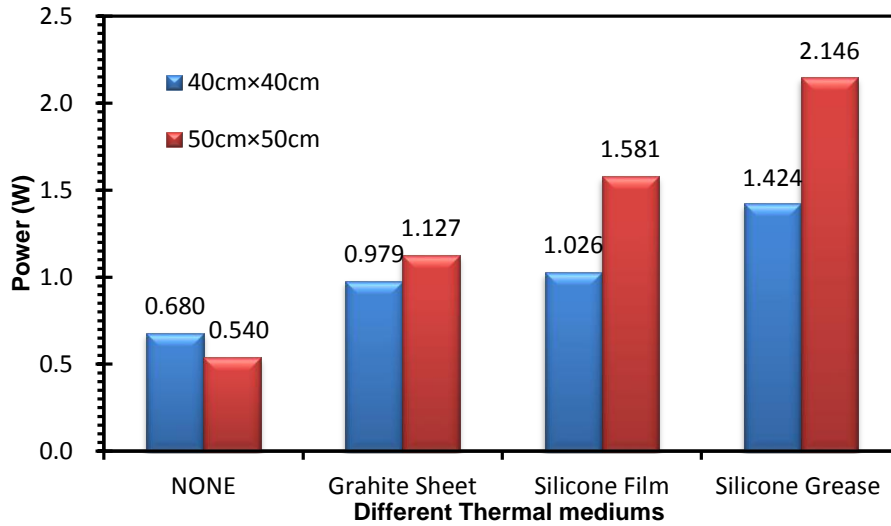

Figure 7: The effect of area and heat-conducting medium type on output power

According to the results shown in Fig. 7, the modules with silicon grease generated 1.424 W and 2.146 W for the heat-conducting media with different size, respectively. The silicon grease with a lower thermal conductivity performs better than other media with a higher thermal conductivity. The reason might be due to air trapped between the two plates and heat-conducting media. Note that the thermal conductivity of air is 0.023 W/m·K. On the other hand, silicone grease can adhere at the interface tightly, so it may help the thermoelectric modules dissipate heat and generate more power. However, the silicone grease has an obvious disadvantage: it's volatile and easy to dry, leading to performance reduction.

Silicone film is not recommended because of its high cost. The graphite sheet may be the most suitable medium due to its high thermal conductivity and low cost, but the air gap weakens the heat-conducting performance.

Based on the above experimental results, our approach to assembling the TEG modules in this study was to adhere the graphite sheet at the module's surface using a trace amount of silica gel which can tolerate 200°C. This method not only takes advantages of the graphite merit, but also avoids the air gap's negative effect.

4. EXPERIMENTAL SET-UP OF THE POWER GENERATING SYSTEM

A 500W TEG power generator was designed after above experimental studies. Its schematic is shown in Fig. 8. The hot water, which was supplied by the thermostatic water bath circulator, simulated the geothermal or hot water and provided heat for the generators. Cooling cycle was composed of a water pump and water container. Thermal couples for temperature measurements and displays were installed at the inlet and outlet pipes. The values of voltage, current and power can be collected by the electrical multimeter.

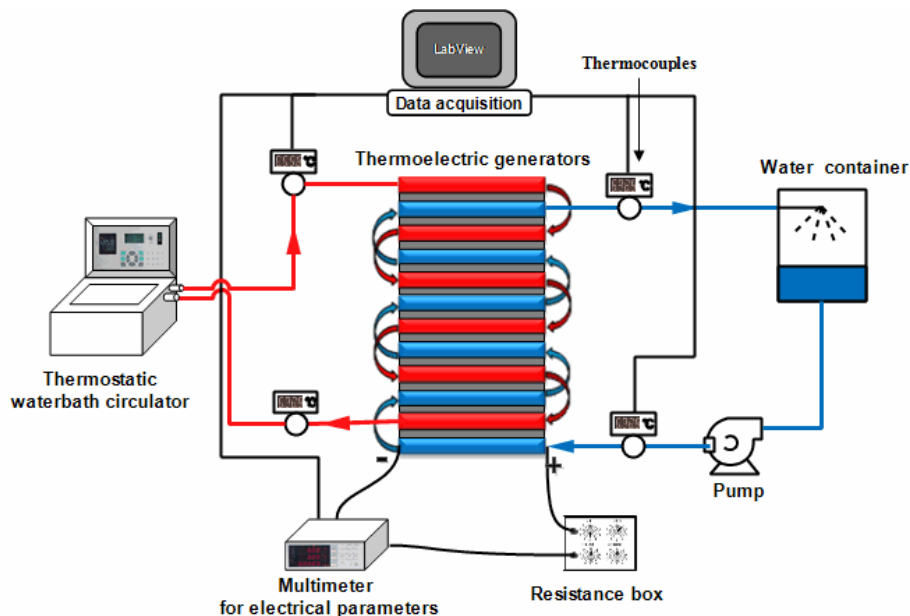

Figure 8: The Schematic of the thermoelectric power generation system

The 500 W TEG power generator was composed of 100 thermoelectric modules (Module 4). 13 liquid blocks (containers) and some connection boxes were also used in this system. Fig. 9 shows the picture of the TEG power generator before it was wrapped using insulation material.

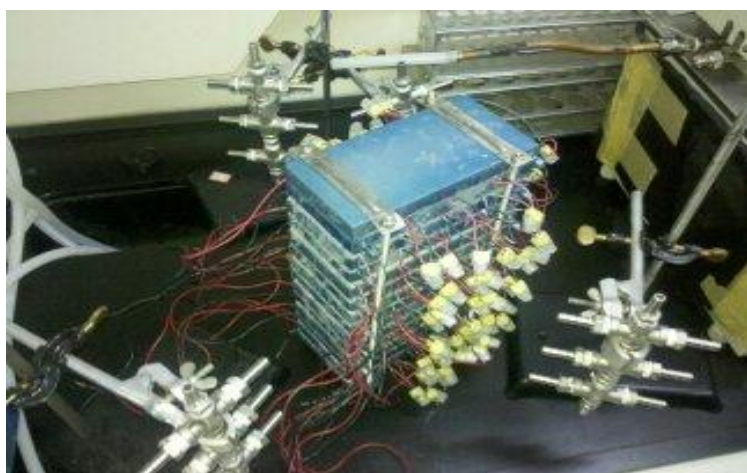

Figure 9: The thermoelectric power generation system before operating

In order to visually display the experimental results, ten direct-current bulbs were used to utilize the output energy. As shown in Fig. 10, ten 15W bulbs (direct current) were lit up with 100°C water on the hot side and 20°C tap water on the cold side of the system. The 500 W thermoelectric power generation systems after assembled with the case are shown in the Fig. 11.

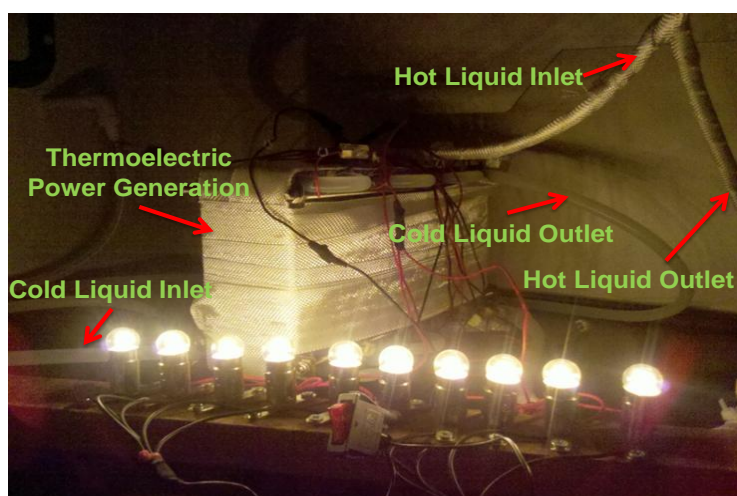

Figure 10: The thermoelectric power generation system lighting up ten 15W bulbs

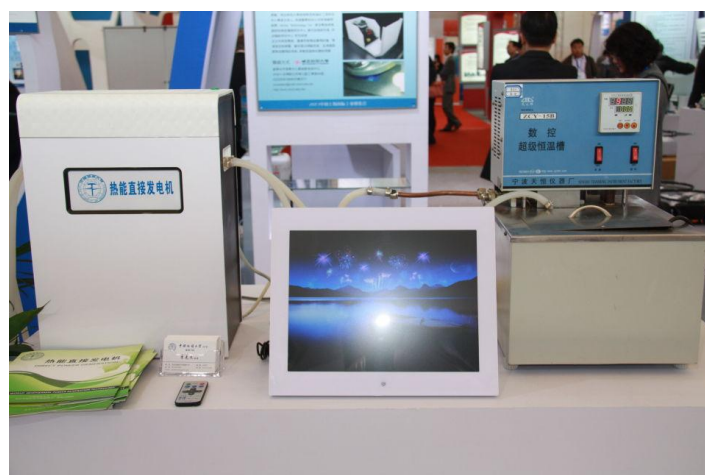

Figure 11: The 500 W thermoelectric power generation system assembled with the case operated to start the LED display during the 2013 exhibition at Shanghai International Expo Center

We built another TEG apparatus with a power of about 1 KW at a temperature difference of around 120 °C after successfully developed the previous one shown in Fig. 11. The new system was shown in the Fig. 12. Altogether 600 modules were used for this 1 KW power system, and its volume was only about 0.01 m³. The power of this apparatus (see Fig. 12) could be as high as 2 KW if temperature difference between the cold and hot sides is greater enough. The maximum temperature on the hot side can be 200 °C. Detailed research and field tests on this generator will be conducted in the near future.



Figure 12: The 1 KW thermoelectric generator for low-temperature geothermal resources

Note that the experimental data in the following sections are based on the TEG system shown in Fig. 11, which has a small power output than the apparatus shown in Fig. 12.

5. POWER TESTING OF THE 500 W POWER GENERATING SYSTEM

The thermoelectric power generation system as shown in Fig. 11 was operated using 100°C hot water and 20°C tap water. The 100°C hot water was supplied by a thermostatic water bath. The power generated by the system at a temperature difference of about 80°C is shown in Fig. 13. The power was stabilized at around 160W.

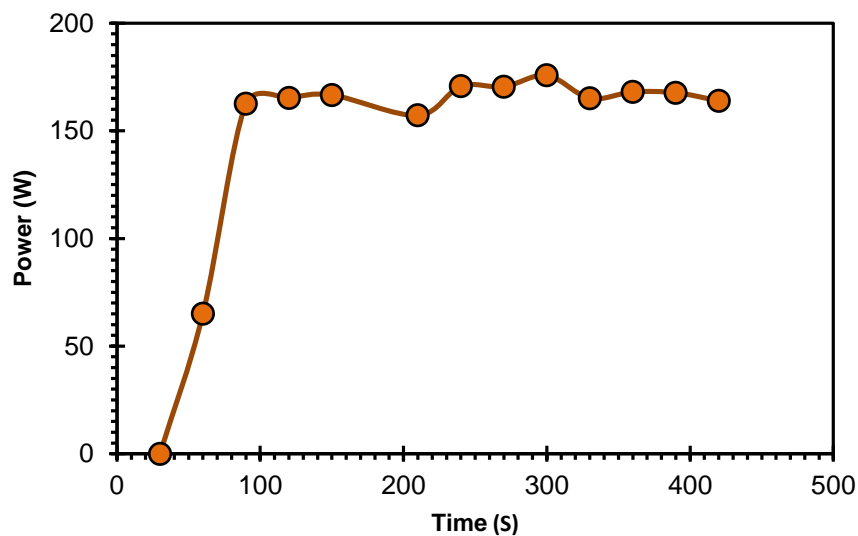

Figure 13: Power generated from the TEG power system vs. time

The power output was measured at different temperature differences using the TEG power generator. The purpose was to establish the relationship between power output and temperature difference. The experimental results are shown in Fig. 14.

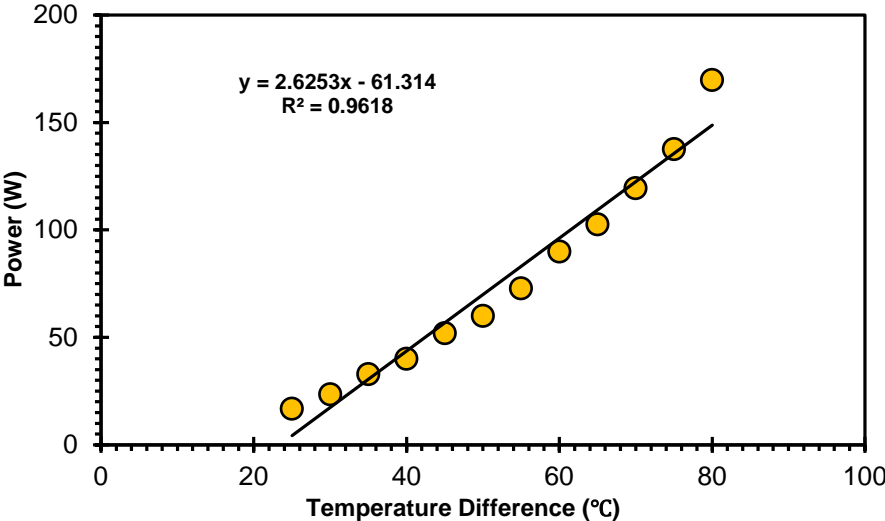

Figure 14: Relationship between power and temperature difference.

One can see that the power output increases with the increase in temperature differences almost linearly. We can estimate the power output approximately at a specific temperature difference. For example, a power output of 500 W will be reached at a temperature difference of about 200°C. Note that the slope of the power curve shown in Fig. 14 increases with the increase in temperature difference. The relationship between power output and temperature difference looks like exponential, which is of great significance.

The same experimental method as that applied for single modules was used for the efficiency determination of the 500 W power generation system. As shown in Fig.15, the global efficiency was about 9% with the temperature variation from 100°C to 30°C of the hot side. The slope gradually decreases to zero, and the temperature of hot side from 100°C to 80°C was recommended for power generation based on the results in Fig. 15.

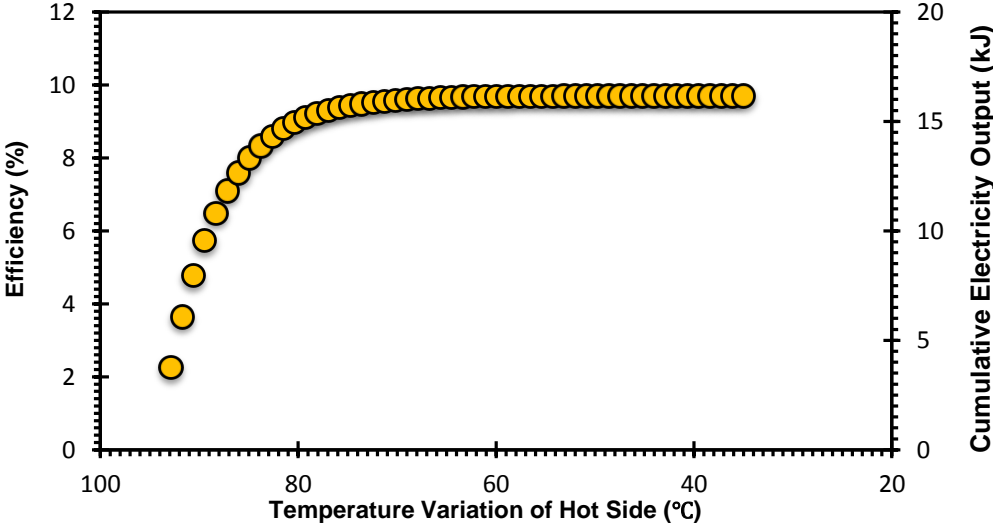

Figure 15: Global efficiency and cumulative electricity of geothermal power generation with the hot side temperature variation

On the other hand, temperature differences of inlet and outlet of hot side also plays very important role on the efficiency. Both inlet and outlet temperature variation of hot side was collected, inlet temperature was changed from 45°C to 85°C and the outlet was from 35°C to 75°C. The temperature on the cold side was kept at 35°C.

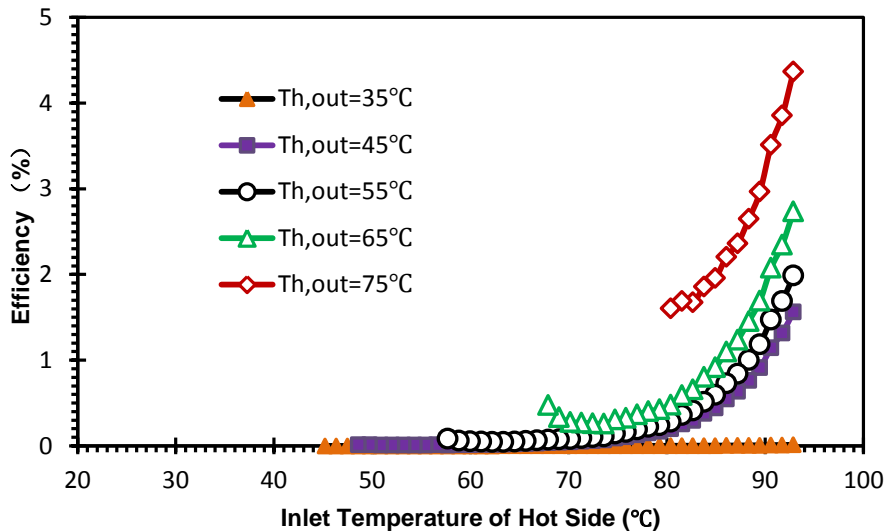

Figure 16: Efficiency of power generation at different inlet and outlet temperatures of hot side

The data shown in Fig. 16 are instantaneous efficiency which increases with the increase in temperature at the inlet and the decrease in temperature at the outlet on the hot side. The instantaneous efficiency of the TEG system could reach about 4.5% at the inlet temperature of about 95 °C and the outlet temperature of 75°C. Importantly the instantaneous efficiency increases with the inlet temperature exponentially, and has a stronger dependency on the outlet temperature. Note that the results shown in Fig. 16 are similar to the results reported by Sulter et al. (2012).

6. COMPARISON OF COST WITH PV AND WIND SYSTEMS

Cost is a great challenge for almost all of the renewable energy technologies. Based on the experimental results and the data about PV and wind system from publications (CWEA,2012,Qian.,2012), we estimated the total cost of the DHE power generator and found that the cost is close to the PV’s cost in terms of unit installed power. The cost data for solar PV and wind energy are shown in Fig. 17. Also shown in Fig. 17 are the cost data estimated by considering the capacity factor for PV and DHE. A capacity factor of 14% for PV and 90% of DHE (or TEG technology for thermal energy) were chosen. The cost of the TEG system developed in this study was much lower than those of PV and wind power systems in terms of equivalent energy generated after considering the capacity factor.

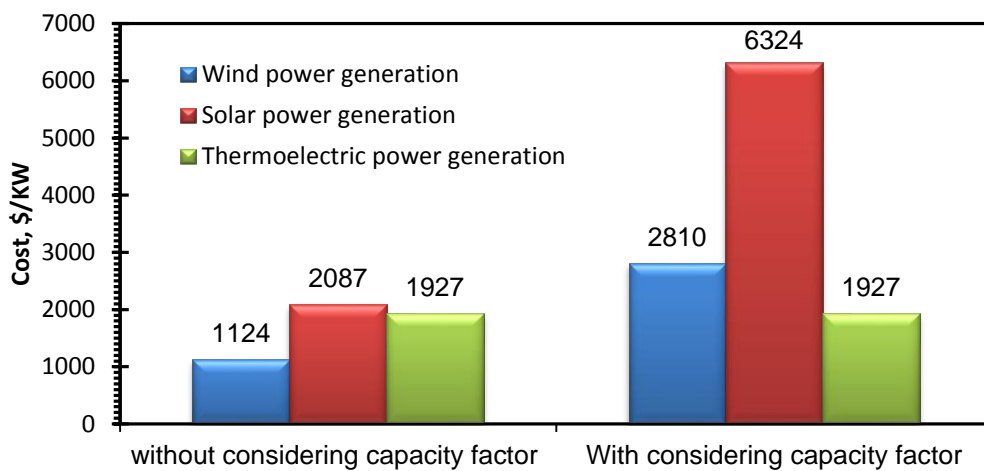

Figure 17: The cost comparison of wind, solar, thermoelectric power generation

7. CONCLUSIONS

According to the current study, the following preliminary conclusions may be drawn:

- (1) Two power generators have been built using TEG modules and tested. The power of the first one could reach about 500 W (predicted using experimental data) with a temperature difference of about 200°C between hot and cold sides. An output power of over 160 W has been generated under a temperature difference of 80°C (hot side temperature was about 100°C and the cold side was 20°C). The second TEG system could generate over 1 KW at a temperature difference of around 120 °C.
- (2) The instantaneous efficiency of the TEG system reached 4.5% at an inlet temperature of about 95°C on the hot side and a temperature of 30°C on the cold side. This efficiency increases exponentially with the inlet temperature.

- (3) The cost of the TEG system developed in this study was much lower than those of PV and wind power systems in terms of equivalent energy generated (considering the capacity factor).

REFERENCES

- Bennett, K., Horne, R. and Li, K.: "Power Generation Potential from Coproduced Fluids in the Los Angeles Basin," In: GRC Trans; (2011).
- Chen, L., Sun, F. and Wu, C.: "Thermoelectric-generator with linear phenomenological heat-transfer law". Applied Energy (2005); 81, 358–64.
- Eisenhut, C. and Bitschi, A.: "Thermoelectric conversion system based on geothermal and solar heat," 25th International Conference on thermoelectrics, (2006), p.510-515.
- Erdlac, Jr., Armour, L., Lee, R. and Snyder, S.: "Sorensen M, Matteucci M, Horton J. Ongoing Resource Assessment of Geothermal Energy from Sedimentary Basins in Texas," Proceedings of 32nd Workshop on Geothermal Reservoir Engineering, Stanford University, Stanford, California, (2007), January 22-24.
- Erkan, K., Holdman, G., Blackwell, D. and Benoit W.: "Thermal Characteristics of the Chena Hot Springs Alaska Geothermal System," PROCEEDINGS, Thirty-Second Workshop on Geothermal Reservoir Engineering Stanford University, Stanford, California, (2007), January 22-24.
- Esarteia, J., Minb, G. and Roweb, D.: "Modeling heat exchangers for thermoelectric generators," J Power Sources 2001; 93:72–6.
- Freunek, M., Mueller, M. and Ungan, T. Walker, W., Reindl, L.: "New Physical Model for Thermoelectric Generators," Journal of electronic materials (2009), 38, 1214-1220.
- Hsu, C., Huang, G., Chu, H., Yu, B. and Yao, D.: "Experiments and simulations on low-temperature waste heat harvesting system by thermoelectric power generators," Applied Energy (2011), 88(4), 1291-1297.
- Kim, S.: "Analysis and modeling of effective temperature differences and electrical parameters of thermoelectric generators," Applied Energy (2012), 102, 1458-63.
- Kajikawa, T. and Onishi, T.: "Development for advanced thermoelectric conversion exhaust thermoelectric generator in a light truck," Proc Inst Mech Eng Part D J Automob Eng (2007), 221, 95–107.
- Karabetoglu, S., Sisman, A., Fatih Ozturk, Z. and Sahin T.: "Characterization of a thermoelectric generator at low temperatures," Energy Conversion and Management (2012), 62, 47-50.
- Li, K., Liu, C., and Chen, P.: "Direct power generation from heat without mechanical work. Proceedings, 38th Workshop on Geothermal Reservoir Engineering Stanford University," Stanford, California; (2013), February 11-13.
- Li, K., Zhang, L., Ma, Q., Liu, M., Ma, J. and Dong, F.: "Low Temperature Geothermal Resources at Huabei Oilfield, China". In: GRC Trans, (2007), p. 31.
- Li, K.: "Comparison of Geothermal with Solar and Wind Power Generation Systems," Proceedings, 38th Workshop on Geothermal Reservoir Engineering Stanford University, Stanford, California; (2013), February 11-13.
- Liu, L.: Large-scale Ocean-based or Geothermal Power Plants by Thermoelectric Effects. www.arXiv.org ; (2012).
- Maneewan, S. and Chindaruksa, S.: "Thermoelectric power generation system using waste heat from biomass drying," Journal of electronic materials 38(7), 974-980.
- Niu, X., Yu, J. and Wang, S.: "Experimental study on low-temperature waste heat thermoelectric generator". Journal of Power Sources (2009), 188, 621–6.
- Renewables: Global Status Report, REN21 (Renewable Energy Policy Network for the 21st Century). Available at: www.ren21.net , (2012).
- Rowe, D.: "Review: thermoelectric waste heat recovery as a renewable energy source," International Journal of Innovation Energy System Power (2006), 1:13–23.
- Suter, C., Jovanovic, Z. and Steinfeld, A.: "A 1kW thermoelectric stack for geothermal power generation—Modeling and geometrical optimization," Applied Energy (2012), 99, 379-85.
- Thacher, E., Helenbrook, B., Karri, M. and Richter, C.: "Testing of an automobile exhaust thermoelectric generator in a light truck," Proceedings of the Institution of Mechanical Engineers, Part D: Journal of Automobile Engineering (2007), p. 95-107.
- Wang, Y., Dai, C. and Wang, S.: "Theoretical analysis of a thermoelectric generator using exhaust gas of vehicles as heat source," Applied Energy (2013).
- WEA.: World Energy Assessment Report. "Energy and the Challenge of Sustainability," (2000), p. 500.
- Xiao, J., Yang T.: "Thermal design and management for performance optimization of solar thermoelectric generator," Applied Energy (2012), 93, 33–8.
- Xin, S., Liang, H., Hu, B. and Li, K.: "Electric power generation from low temperature co-produced geothermal resources at HuaBei Oilfield," Thirty-Seventh Workshop on Geothermal Reservoir Engineering Stanford University; (2012), January 30 – February 1.

Liu et al.

Yamashita, O.: "Effect of linear temperature dependence of thermoelectric properties on energy conversion efficiency," *Energy Convers Manage* (2008), 49, 3136–69.