

INSTALLATION & OPERATING MANUAL  
**Qi Variable Speed Pump**

# A COMPLETE GUIDE TO YOUR SWIMMING POOL PUMP

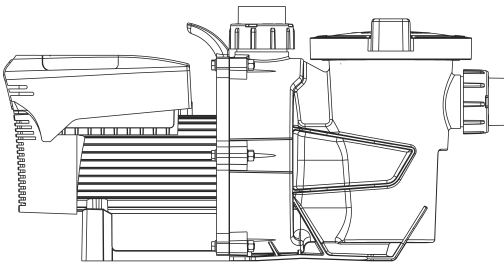

**i**nsnrg

# CONGRATULATIONS ON PURCHASE YOUR INSNRG SWIMMING POOL PUMP.

**THIS MANUAL HAS BEEN CAREFULLY DEVELOPED TO GIVE YOU ALL THE INFORMATION YOU NEED TO GET THE BEST VALUE FROM YOUR PURCHASE.**

It is important that you read through the manual to identify the key areas you need to understand, particularly the following:

- Health and Safety Concerns
- Installation requirements
- How to operate the major features of the unit
- The importance of maintenance
- If you have a problem, what to trouble shoot before you contact your professional
- Finally, your entitlements under your product warranty.

Insnrg have developed their product to provide you with the ultimate experience and are sure you will be delighted with your purchase.

**Please note:** This manual has been designed to cater for installation rules and codes in the USA, Canada and Australia. Specific rules and regulations for each country has been highlighted by the National flag of each country. Please ensure you follow the installation rules specific to your country.

# THE IMPORTANT BITS

**03 SECTION 1:**  
We care about your safety

**10 SECTION 2:**  
We want you to be delighted

Dimensions & Performance Charts  
Pump Location & Clearances  
Starting / Priming the Pump

**16 SECTION 3:**  
Now to Have some Fun

Pump Speed Control & Monitoring  
Bluetooth Control

**31 SECTION 4:**  
Oops, something not right?

Maintenance  
Pump Details  
Winterisation  
Troubleshooting  
Replacement Parts  
Warranty

## SECTION 1

# WE CARE ABOUT YOUR SAFETY

## **IMPORTANT WARNINGS**

**Warning – Please read and follow all instructions in this owner’s manual and on the equipment. Failure to follow instructions can cause severe injury and/or death.**

**INSTALLERS:** Insnrg highly recommend the installation of all their equipment by a suitably qualified pool professional who will ensure your high performance Insnrg products are installed to your local standards and codes to ensure optimum safety and performance.

### **WARNING**

This appliance is not intended for use by persons (including children) with reduced physical, sensory or mental capabilities, or lack of experience and knowledge, unless have been given supervision or instruction concerning use of the appliance by a person responsible for their safety.

### **WARNING**

If the supply cord is damaged, it must be replaced by the manufacturer, its service agent or similarly qualified persons in order to avoid a hazard.

### **WARNING**

Failure to remove pressure test plugs and/or plugs used in winterization of the pool/spa from the suction outlets can result in an increase potential for suction entrapment as described above.

### **WARNING**

Failure to keep suction outlet components clear of debris, such as leaves, dirt, hair, paper and other material can result in an increase potential for suction entrapment as described above.

### **WARNING**

Suction outlet components have a finite life, the cover/grate should be inspected frequently and replaced at least every ten years or if found to be damaged, broken, cracked, missing, or not securely attached.

### **WARNING**

Never operate or test the circulation system at more than 50 PSI.

### **WARNING**

Never change the filter control valve position while the pump is running.

## CAUTION

All components of the filtration system including Pumps, Filters, Heaters must be positioned so to prevent being used as means of access to the pool by young children. To reduce risk of injury, do not permit children to use or climb on this product. Closely supervise children at all times.

## WARNING - HAZARDOUS PRESSURE

Pool and Spa water circulation systems operate under hazardous pressure during start up, normal operation, and after pump shut off. Stand clear of circulation system equipment during pump start-up. Failure to follow safety and operation instructions could result in violent separation of the pump housing and cover, and/or filter housing and clamp due to pressure in the system, which could cause property damage, severe personal injury, or death. Before servicing pool and spa water circulation systems, all system and pump controls must be in the off position and filter manual relief valve must be in open position. Before starting system pump, all system valves must be set in a position that allows system water to return back to the pool. Do not change filter control valve position whilst system pump is operating. Before starting system pump, fully open filter manual air relief valve. Do not close filter manual air relief valve until a steady stream of water (not air) is discharged.

## WARNING

This pump is to be supplied by an isolating transformer or supplied through a residual current device (RCD) having a rated residual operating current not exceeding 30 mA.

## WARNING - RISK OF ELECTRIC SHOCK

All electrical wiring MUST be in conformance with applicable local codes, regulations, and the National Electric Code (NEC). Hazardous voltage can shock, burn, and cause death or serious property damage. To reduce the risk of electric shock, do NOT use an extension cord to connect unit to electric supply. Provide a properly located electrical receptacle. Before working on any electrical equipment, turn off power supply to the equipment.

## WARNING

To reduce the risk of electric shock replace damaged wiring immediately. Locate conduit to prevent abuse from lawn mowers, hedge trimmers and other equipment.

## WARNING

Electrical ground all electrical equipment before connecting to electrical power supply. Failure to ground all electrical equipment can cause serious or fatal electrical shock hazard.

## WARNING

Do NOT ground to a gas supply line.

## WARNING

To avoid dangerous or fatal electrical shock, turn OFF power to all electrical equipment before working on electrical connections

## WARNING

Failure to bond all electrical equipment to pool structure will increase risk for electrocution and could result in injury or death. To reduce the risk of electric shock, see installation instructions and consult a professional electrician on how to bond all electrical equipment. Also, contact a licensed electrician for information on local electrical codes for bonding requirements.

**Notes to electrician:** Use a solid copper conductor, size 8 or larger. Run a continuous wire from external bonding lug to reinforcing rod or mesh. Connect a No. 8 AWG (8.4 mm<sup>2</sup>) [No. 6 AWG (13.3 mm<sup>2</sup>) for Canada] solid copper bonding wire to the pressure wire connector provided on the electrical equipment and to all metal parts of swimming pool, spa, or hot tub, and metal piping (except gas piping), and conduit within 5 ft. (1.5 m) of inside walls of swimming pool, spa, or hot tub.

**IMPORTANT** - Reference NEC codes for all wiring standards including, but not limited to, grounding, bonding and other general wiring procedures.

## WARNING

Risk of Electric Shock. Connect only to a branch circuit protected by a ground-fault circuit-interrupter (GFCI). Contact a qualified electrician if you cannot verify that the circuit is protected by a GFCI.

## WARNING

Risk of Electric Shock . The electrical equipment must be connected only to a supply circuit that is protected by a ground-fault circuit-interrupter (GFCI). Such a GFCI should be provided by the installer and should be tested on a routine basis. To test the GFCI, push the test button. The GFCI should interrupt power. Push reset button. Power should be restored. If the GFCI fails to operate in this manner, the GFCI is defective. If the GFCI interrupts power to the electrical equipment without the test button being pushed, a ground current is flowing, indicating the possibility of an electrical shock. Do not use this electrical equipment. Disconnect the electrical equipment and have the problem corrected by a qualified service representative before using.

## CAUTION

This pump is intended for use with permanently-installed pools and may be used with hot tubs and spas if so marked. Do not use with storable pools. A permanently-installed pool is constructed in or on the ground or in a building such that it cannot be readily disassembled for storage. A storable pool is constructed so that it is capable of being readily disassembled for storage and reassembled to its original integrity.

# TO REDUCE THE RISK OF ENTRAPMENT HAZARDS:

- When outlets are small enough to be blocked by a person, a minimum of two functioning suction outlets per pump must be installed. Suction outlets in the same plane (i.e. floor or wall), must be installed a minimum of 1 metre (3 Feet) apart, as measured from near point to near point.
- Dual suction fittings shall be placed in such locations and distances to avoid “dual blockage” by a user.
- Dual suction fittings shall not be located on seating areas or on the backrest for such seating areas.
- The maximum water velocity through the suction outlet assembly and its cover for any suction outlet must not exceed the suction fitting assembly and it’s cover’s maximum design flow rate. The suction outlet (drain) assembly and its cover must comply with the latest version of ANSI/ASME A112.19.8, the standard for Suction Fittings For Use in Swimming Pools, Wading Pools, Spas, and Hot Tubs, or its successor standard, ANSI/APSP-16.
- Never use Pool or Spa if any suction outlet component is damaged, broken, cracked, missing, or not securely attached.
- Replace damaged, broken, cracked, missing, or not securely attached suction outlet components immediately.
- In addition to the above instructions for two or more suction outlets per pump, they must be installed in accordance with latest ASME, APSP Standards and CPSC guidelines, and follow all National, State, and Local codes applicable.
- Installation of a vacuum release or vent system, which relieves

# TYPES OF ENTRAPMENT HAZARDS:

## **SUCTION ENTRAPMENT HAZARD**

Suction outlets and/or suction outlet covers which are, damaged, broken, cracked, missing, or unsecured can cause severe injury and/or death due to the following entrapment hazards:

### ***Hair Entrapment***

Hair can become entangled in suction outlet cover.

### ***Limb Entrapment***

A limb inserted into an opening of a suction outlet or suction outlet cover that is damaged, broken, cracked, missing, or not securely attached can result in a mechanical bind or swelling of the limb.

### ***Body Suction Entrapment***

A negative pressure applied to a large portion of the body or limbs can result in an entrapment.

### ***Evisceration/ Disembowelment***

A negative pressure applied directly to the intestines through an unprotected suction outlet or suction outlet cover which is, damaged, broken, cracked, missing, or unsecured can result in evisceration/ disembowelment.

### ***Mechanical Entrapment***

There is potential for jewellery, swimsuit, hair decorations, finger, toe or knuckle to be caught in an opening of a suction outlet cover resulting in mechanical entrapment.

## **SECTION 2**

WE WANT YOU TO BE DELIGHTED WITH YOUR PURCHASE, CORRECT INSTALLATION WILL PROLONG LIFE AND MAXIMISE THE PERFORMANCE OF THIS UNIT.

**Congratulations on your purchase of the Insnrg Variable Speed Pump. This Pump represents a combination of the latest technology and expertise from the Insnrg Research and Development department to create one of the most innovative Swimming Pool Pumps in the marketplace. Your pool professional will ensure your Insnrg Variable Speed Pool Pump is installed to give you the optimum water flow for all your pool needs as well as reducing your energy consumption, reducing your electricity bills.**

**Insnrg highly recommend the use of qualified service technicians to ensure the best performance as well as the health and safety of your family.**

# DIMENSIONS & PERFORMANCE CHARTS

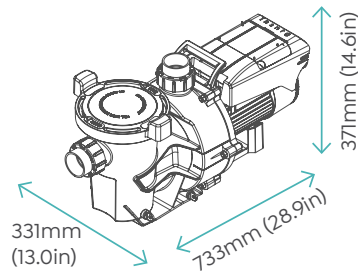

MODEL	Qi 1100				Qi 1800			
SPEED	i	ii	iii	iv	i	ii	iii	iv
VOLTS	230	230	230	230	230	230	230	230
RPM	2850	2300	1700	1150	2850	1700	1125	900
INPUT WATTS (W)	1050	538	227	140	1870	800	350	137
FLOW RATE (lpm)	300	240	180	120	602	360	240	120
FLOW RATE (gpm)	80	64	48	32	160	96	64	32
Head (m)	8.0	5.1	2.9	1.3	8.0	5.0	2.7	1.2
Current (Amps)	7.5	3.8	1.6	1.0	8.5	4.0	2.0	0.9

**Qi 1100 PUMP - FLOW CHART**

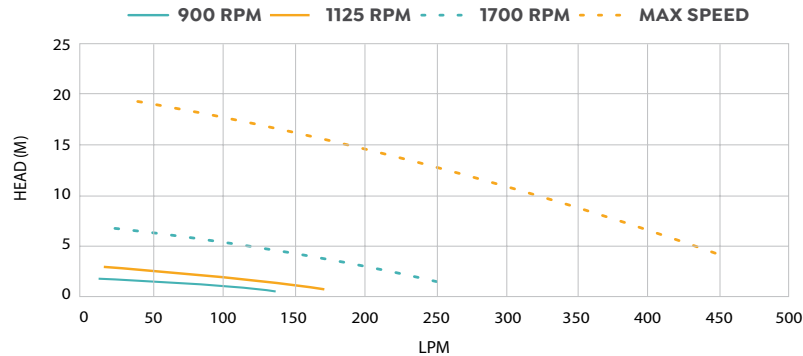

**Qi 1800 PUMP - FLOW CHART**

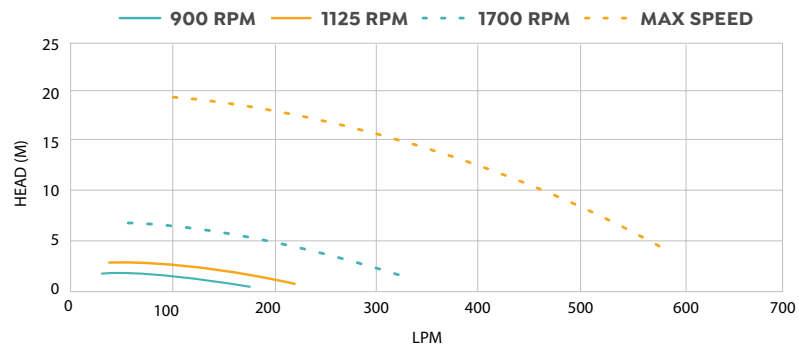

**Pump maximum total head is 21 metres**

# PUMP LOCATION AND CLEARANCES

For optimal performance of your new Insnrg Pump we recommend installing the pump within 30 cm (1 ft) above water level. If the pool pump needs to be elevated more than 1 m (3 ft) above the water level of the pool, then a check valve is recommended on the suction line to the pump.

If the pump is located below water level, isolation valves must be installed on both the suction and return lines to prevent the back flow of pool water during any routine or required servicing.

For electrical connection, install the pump such that any disconnecting means and/or junction boxes are within sight of the pump and at least 1.5 m (5 ft) horizontally from the edge of the pool and/or spa. Choose a location that will minimize the amount of elbows required in the PVC piping.

**NOTE:** In Canada, the minimum distance maintained from the edge of the pool and/or spa as noted above must be 3 m (10 ft), as required by the Canadian Electrical Code (CEC, CSA C22.1).

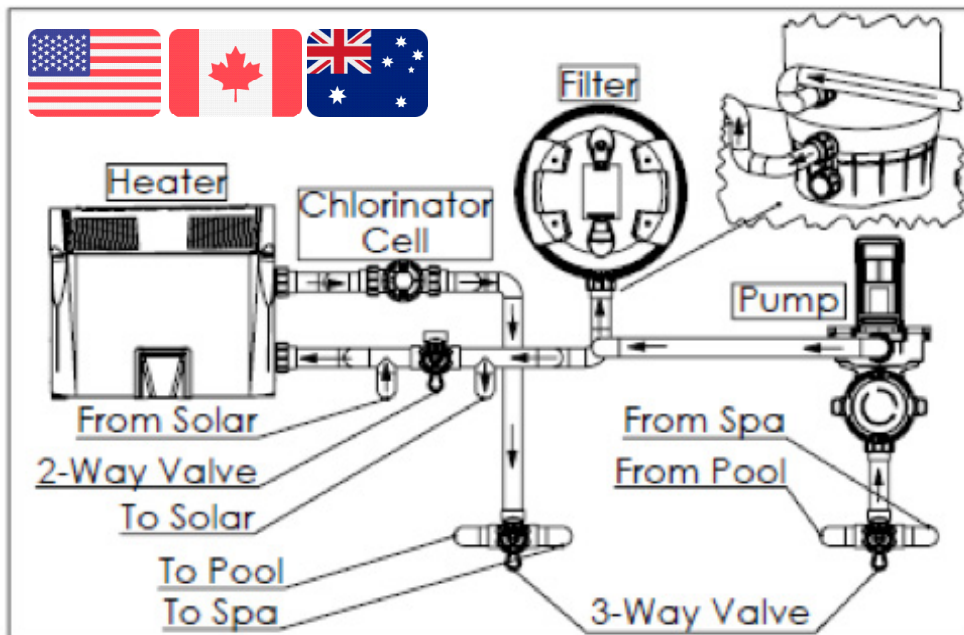

The pump must be placed on a solid foundation that will not vibrate. To further reduce the possibility of vibration noise, bolt the pump to the foundation, or place it on a rubber mat.

The pump foundation must have adequate drainage to prevent the motor from getting wet. The pump has been designed for use outdoors, however, to prolong the life of the pump any protection from the rain and sun will ensure a great result.

All motors generate heat when in operation, therefore, please ensure that the motor is installed with adequate ventilation around the motor. Do not install the motor directly onto a wall or fence, the Fan at the back requires at least 2" (50mm) of space to generate enough air-flow.

Provide access for future service by leaving a clear area around the pump. Allow plenty of space above the pump to remove the lid and basket for cleaning.

## TIPS ON INSTALLATION FOR BEST RESULTS

1. Minimise the amount of PVC Pipe and Fittings through your filtration system. The longer the pipe and the greater the amount of fittings the more pressure is built into the system and the harder the Pump has to operate. This will eventually reduce the lifespan of the Pump as well as costing you more energy to operate.
2. Always use minimum of 50mm (2") PVC Pipe on the Inlet of the Pump.
3. Where possible use minimum of 50mm (2") PVC Pipe on the Outlet of the Pump.
4. Keep Pump clear of any debris, rubbish, other equipment, chemicals, walls etc. It is important that the circulation of air around the motor is clear to help reduce the running temperature and extend the lifespan of the pump.
5. Ensure that if any other equipment exists in your filtration system (ie Filter, Heater, Sanitiser etc) that you have thoroughly checked that the Pump Flow rate does not exceed the maximum flow rates for the other equipment. If it is not suitable, this will affect the performance of the Pump and the other equipment and most likely void any warranty claims on all items.



# STARTING / PRIMING THE PUMP

Once your Insnrg High Performance Pump has been installed, it is now time to turn on and fill with water, a process known as 'priming' the Pump. If the Pump is not primed correctly it could cause the Pump to 'run dry'.

**Note:** Running the pump dry could cause a loss of pressure, resulting in damage to the pump case, impeller and seal.

Firstly, check where your Pump is installed in relation to the pool water level. If below the water level of the pool you need to check that the isolation valves on both the suction and return lines are returned to the 'OPEN' position. They must be OPEN before you start operating the Pump.

The pump strainer pot must be filled with water before the pump is initially started. Your Insnrg Pump has a unique feature that enables the Pump to be filled to a higher level, making the priming process quicker and easier. Follow the steps below to prime the pump:

- 1.** Remove the pump lid and locking ring.
- 2.** Fill the pump strainer pot with water, generally use a Bucket and/or Garden Hose.
- 3.** Reassemble the pump lid and locking ring onto the strainer pot. The pump is now ready to prime.
- 4.** Open the air relief valve on the filter, and stand clear of the filter.
- 5.** Turn on the pump.
- 6.** When water comes out of the filter air relief valve, close the valve. The system should now be free of air and recirculating water to and from the pool.

Congratulations your pump is now primed and ready for operation.

## SECTION 3

# HAVE FUN AND GET THE MOST OUT OF YOUR PURCHASE

Your Insnrg Variable Speed Pump has many features that will benefit you in relation to superior water flow, minimise energy costs, reduced noise and easy operation via the use of Automation or Bluetooth control. The following section will outline the features you need to consider to ensure your pump operates at it's highest capabilities.

# PUMP SPEED CONTROL AND MONITORING

## PUMP CONTROL BOX

The brains of your Insnrg Variable Speed Pump is situated in the Pump Control Box on the top of the Motor. This Box controls the numerous Features and Benefits that allow you to operate the majority of your pool equipment, all with the touch of a button. The following section will outline what functions are available and how to access and operate.

## DISPLAY SCREEN

During normal Pump operation, your Pump Control Screen will look like below.

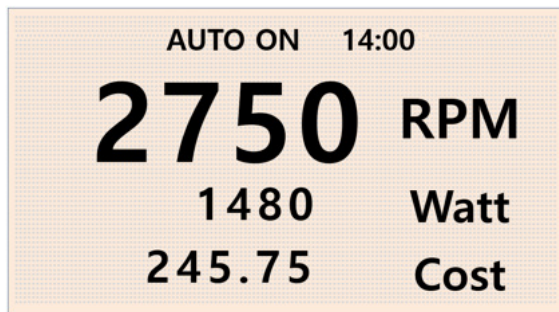

This display shows Four (4) major areas of Information:

- Operation Mode: Manual Off, Manual On, Auto Mode
- Speed of Pump is RPM
- Energy Use in Watts per Hour
- Energy Cost in Dollars per Year, based on Energy Cost entered in the Menu

This information is central to the operation of your Insnrg Variable Speed Pool Pump and more details are explained further in this Manual.

## CHANGING SPEEDS

Your Insnrg Variable Speed Pool Pump has 4 programmed speeds that can be individually adjusted to exactly what your pool requires. These speeds can be allocated to different timer periods to allow the greatest flexibility. Changing speeds is simple, however, it is important that you set to the correct flow rates and Insnrg highly recommend the use of qualified pool professionals to ensure you are getting the best benefit

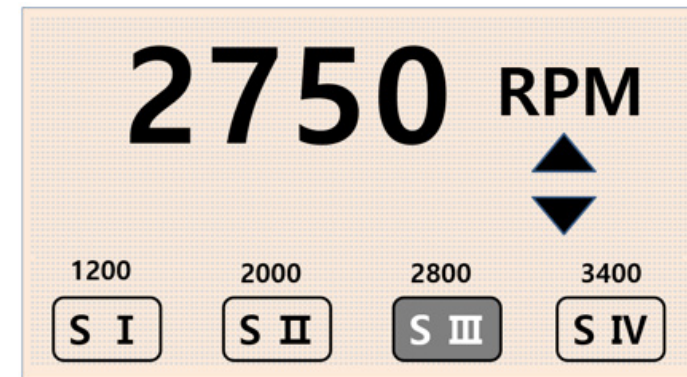

Select the Button that represents the Speed you wish to adjust. Once selected the speed will appear at the top of the screen, then press the “up” or “down” buttons to select the speed you want, changes are in 25 rpm increments. Once speed is selected this will be automatically saved. Continue this process to change the speeds are you require.

## TOUCHSCREEN OPERATION

During normal Pump operation, your Pump Control Screen will look like below.

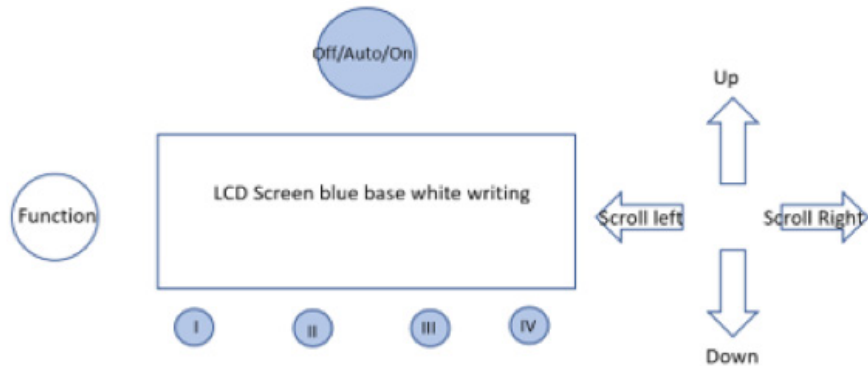

## OFF/AUTO/ON

Depressing this Button will switch between the three main pump operation – Pump Power Off, Pump Timer Mode Active and Pump Continuously On.

On start-up your display should show Pump “off”, one press will put into Pump Timer Mode. The Screen will display “Auto on” for 10 seconds and then flash “Next timer period “xx:xx” for 2 seconds. When in timer period, screen displays “Auto On, running til xx:xx” (next off time).

AUTO ON		
	PRESENT	NEXT
START	11:30	15:00
STOP	14:00	17:30

Pressing the Button again, will activate the Pump and continuously operate until manually stopped. The Screen will flash for 2 seconds displaying “Manual On” and then show (RPM/watts/running cost) for 10 seconds.

MANUAL ON	14:00
<b>2750</b>	<b>RPM</b>
<b>1480</b>	<b>Watt</b>
<b>245.75</b>	<b>Cost</b>

When pressed again, pump is turned continuously off. Screen displays “Pump Off”.

## FUNCTION

The Function Button is used to move between different menus in the Pump Operation. In order, they are as follows:

**Function 1** – Clock Setting

**Function 2** – Timer Setting

**Function 3** – Priming Setting

**Function 4** – External Temperature Setting (Freeze Protection)

**Function 5** – Anti Freeze Setting

**Function 6** – Power Cost Setting

**Function 7** – Pump ID Setting

Press the Function Button to move your way down the list of Numbers on the Left Hand Side until you reach the Setting area you require.

### Function 1 - Clock Setting

Press function button until F1 is selected to display Timeclock: Scroll left or right to select hour/minute, press up or down to change hour or minute. Clock setting is 24 hour format (ie 08:00 for 8am and 20:00 for 8pm). Once happy with time setting either scroll left or right off the hour or minute, or press the function button and the new hour or minute setting will be stored.

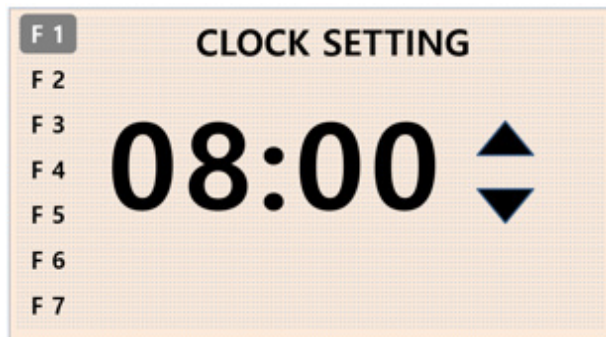

## FUNCTION 2 – TIMER SETTING

Press function button until F2 is selected to move to Timer Menu. Screen will allow you to select Active or Inactive by pressing the Left or Right button. If “Timers Inactive” selected, display “Timers Inactive”.

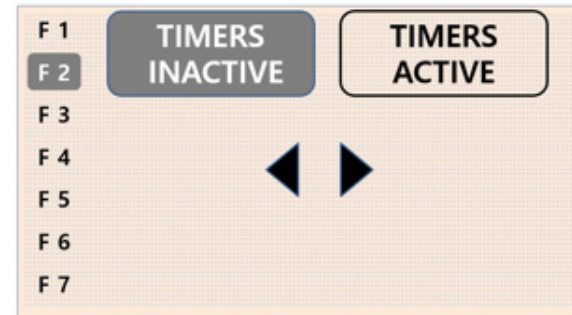

If “Timers Active” selected, screen will then displays timer 1 (T1) to Timer 4 (T4) above 4 horizontal buttons beneath LCD screen and a summary of timer periods as below.

F 1	TIMER				
F 2		T1	T2	T3	T4
F 3	START	08:30	11:30	15:00	08:00
F 4	STOP	10:30	14:00	17:30	
F 5	SPEED	IV	II	III	
F 6	PUMP	ON	ON	ON	
F 7					

Insrg will send the Variable Speed Pump factory programmed with start time of 08:00 and stop 12:00 for Timer 1, then 18:00 start and 20:00 stop for Timer 2. If you are happy with this, you can leave as factory settings. To change the timer settings, select the Timer Period you wish to adjust by pressing the corresponding button below the screen. Similar to the Clock

Setting, move around the time period by Scroll Left and Right, then adjust with Up and Down. Continue to scroll right to select speed of pump for that time period. Press up or down to select speed 2, 3, or 4.

Press buttons underneath T1, T2, T3, T4 to select timer period. Continue to repeat timer programming by selecting each period as you desire.

Should you wish to turn off a Timer period, you can scroll to right and select “Pump Off”. This could be a useful feature for Summer and Winter periods where you want to operate the pump less in Winter.

**Please note:** Timer periods can't overlap. If next timer is due to start before previous timer period finishes, then message on screen will state that “Timers cannot overlap”.

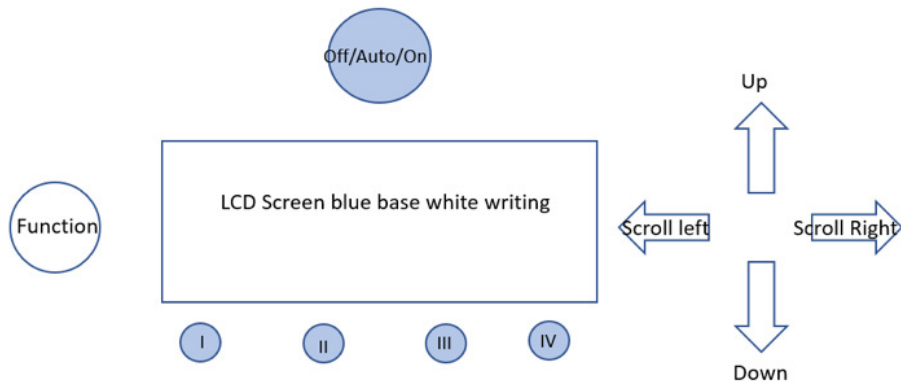

Once your happy with your Timer settings either Press the Function button to adjust another menu, or press the On/Off/ Auto button to save settings and operate your pump.

### **FUNCTION 3 – PRIME SETTING**

Press Function Button until F3 is selected to move to Prime Menu.



There are two choices using the Left or Right buttons. Selecting Prime Time or Auto Prime. Prime Time allows you to set the preferred starting speed for your pump and how long you wish this to run. The Speed and Time will be dependant on how your pool has been set-up by your pool professional. In most instances, the priming speed will operate near high speed for a period of 5 minutes to ensure the pump is primed and the water is circulating after being turned off for a period of time. However, you can also use the Prime Time to operate Suction Cleaners, Heaters or other equipment that may require extra flow for a designated period of time.

If you select “Prime-Time” the below screen will display and prompt you to adjust the Period Time and RPM Speed using the scroll left or right buttons, then up and down buttons similar to other operations.



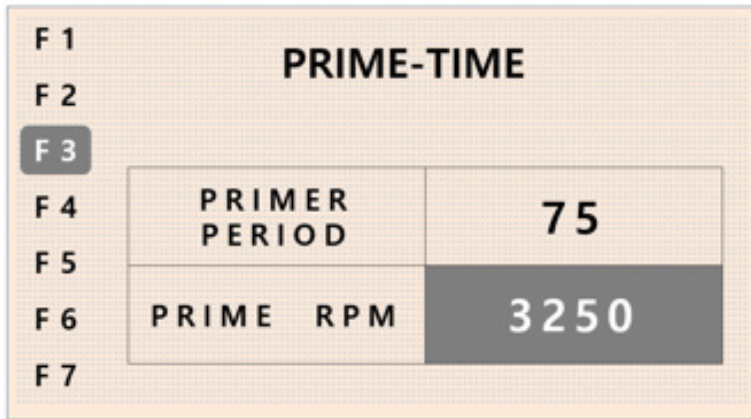

When “on” is selected “primer period = mmm: XXX”. Press up or down to select from “0” to “120” minutes. Scroll right or left to select Prime RPM, press up or down to select 1200 to 3300 in 25 RPM increments.

Please note: If RPM in prime RPM exceeds maximum current, then pump is limited to speed at which maximum current is drawn.

If “Auto Prime” is selected, the pump will run at maximum speed until maximum current is reached for 5 seconds, then revert to (a) timer speed or (b) previous selected speed (1) (2) (3) or (4) in the case where the pump is turned on manually. If motor/controller has not achieved maximum current for 5 seconds within 5 minutes, the controller shuts the pump down. Please note: Auto Prime is the factory default setting.

#### **FUNCTION 4 – EXTERNAL TEMPERATURE SETTING (FREEZE PROTECTION)**

Press Function Button until F3 is selected to move to Prime Menu.

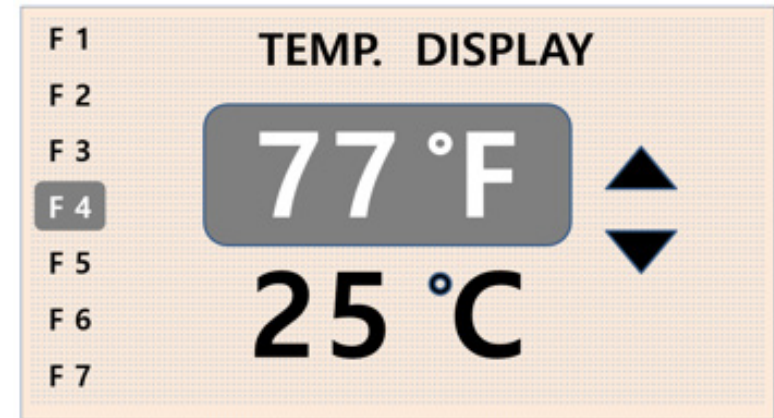

Press up or down to select your preferred display in either “C” (Celcius) or “F” (Fahrenheit). If no external temperature sensor is fitted to your Pump the display will show “0” values, contact your pool professional to confirm if this is correct.

## **FUNCTION 5 – ANTI-FREEZE SETTING**

Press Function Button until F5 is selected to enter the Anti-Freeze menu. The Anti-Freeze function is an important feature for those climates where the pool can freeze during winter. Frozen water expands and can cause significant damage to your equipment. The Anti-Freeze function will monitor the outside temperature and will turn the Pump on to a selected speed should the temperature fall below the set point. This will maintain circulation and stop your water from freezing.

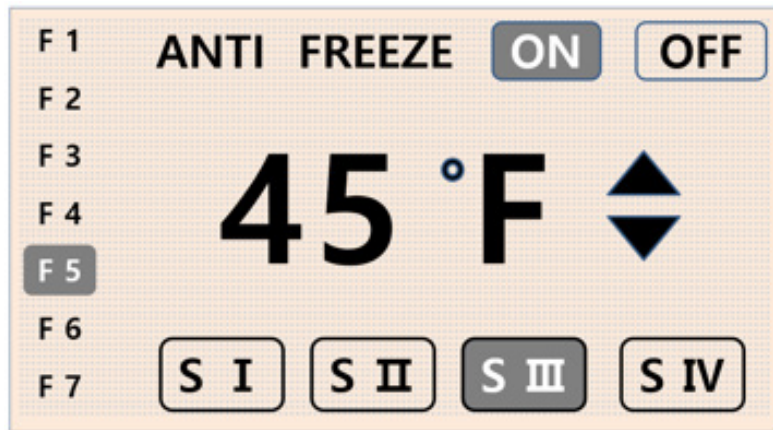

Firstly, press up or down to select “On or Off”.

If “on” selected, temperature will then be displayed, then press up or down to change temperature from 40 F to 48 F or 4.4 C to 9.0 C depending on the setting chosen in Function 4. You must also select the Speed you wish the Pump to operate by scrolling left or right to select speed, then press up or down to select speed your chosen speed.

When selected and the on board thermistor drops to Anti Freeze set point, pump starts on speed selected and operates until temperature of water increases by 2 F or 1 C.

## **FUNCTION 6 – POWER COST SETTING**

Press Function Button until F6 is selected to enter “Power Cost” menu.

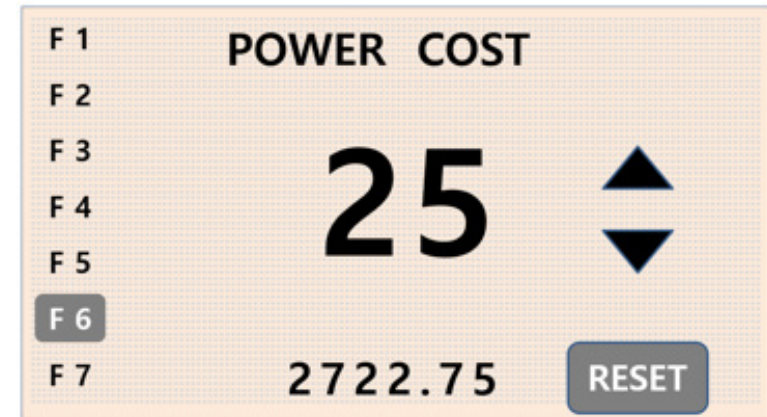

Press up or down to change from 5 to 40 in 1 cent increments. This value represents cents per kW hour and can be located on your latest electricity bill to get the most accurate results.

## **FUNCTION 7 – PUMP ID SETTING**

Press Function Button until F7 is selected to enter Pump ID Menu.

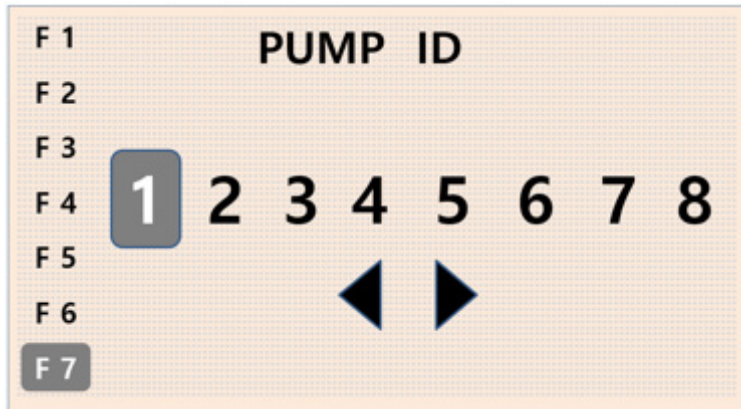

A Pump ID may be required when using an Automated system that requires a Pump to have an ID to ensure it operates in the correct time and speed. Your pump will default to Pump ID 1, should you need to adjust, scroll left or right to appropriate number, then press up or down to select. Choices are 1, 2, 3, 4, 5, 6, 7, 8.

Please note: when in any Function mode, if no button is pressed for more than 30 seconds, pump reverts to last saved setting (manually on, off or auto).

## BLUETOOTH CONTROL

One of the most unique features of your Insnrg Variable Speed Pump is the ability to monitor and control the functions via Bluetooth on any SMART device.

### **TO SET-UP THIS FEATURE YOU WILL NEED TO COMPLETE THE FOLLOWING STEPS:**

1. Download the free **INTOUCH** App from your devices store (ie Google Play, App Store etc)



2. Follow the instructions on the App to set-up an account and locate your Insnrg Device. Please note, if you have more than one Insnrg electrical device they can all be set-up on the one account and all operate from this App.

You will now be able to operate your Insnrg Variable Speed Pump from your SMART device or by physically changing at the Pump, the choice is yours.

If you want to monitor and operate through your SMART device anywhere in the world, you need to purchase the Insnrg Intouch Gateway which will connect to your Wireless Router in the House. This will give you the ability to monitor and change anywhere you have access to Data.



## SECTION 4

# OOPS, SOMETHING'S NOT RIGHT?

Maintenance, Trouble Shooting,  
Replacement Parts, Warranty &  
Contact Section

## MAINTENANCE

Your new Insnrg Variable Speed Pump is one of the hardest working items in your household. It is designed to withstand harsh outdoor conditions and withstand high velocity water with chemicals. Some of these parts will wear in the normal course of use and require regular checks and maintenance. A well thought out pro-active maintenance schedule will identify faults early and extend the lifespan of your pump.

To protect against extremes of temperature, your unit is vented to allow expensive electronics to cool. Ants and some insects are often attracted to the warmer, dry environment inside the enclosure.

We recommend that, with power turned off, you spray a surface insecticide on the surfaces surrounding the control to prevent ant and insect ingress. Repeat every three months or as necessary.

# WARNINGS

The Pump Control Box has in built warning systems to advise of any issues that can be addressed to get the best performance from your Pump. They include the following:

## 1. CURRENT TOO HIGH



Your Pump requires the correct connection to a mains power supply. This can vary according to your local power supply and the amount of electrical items installed on the line. If the Current is too High, your screen will show the display below:.

This should only happen when the motor or impellor is seized, usually caused by debris blocking movement inside the Pump Volute. Empty Baskets, and if necessary dismantle Pump to remove debris. If warning still shows on screen, contact your local pool professional for assistance.

## 2. OVER TEMPERATURE



Your Insnrg Variable Speed Pump has capability of measuring the Temperature of the Motor and outside conditions. Should temperature reach above standard operating levels, the pump will stop until temperature drops and the below will display on the screen.

It is important that the Pump Motor has sufficient ventilation to allow the motor to cool by passing air across during normal operation. Check the area around the motor and remove any unnecessary items (ie pool toys, chemicals, leaves, builders rubble etc) that could cause blockage to air flow. If still shows on display, contact your local pool professional for assistance.

## 3. ANTI FREEZE

The Anti Freeze feature of your Insnrg Variable Speed Pump prevents the swimming pool water from freezing and causing damage to your pool equipment. Read the Anti Freeze section in this manual for further details. Should the Anti Freeze function become active, the display will show below.



The Anti Freeze function will continue to operate until the temperature increases above the set level. Insnrg highly recommends that you allow the Anti Freeze to operate to avoid expensive damage if water should freeze within your equipment. There is no further action required.

## 4. PRIME FAIL

The Prime Fail display below will only show when the Pump is set-up in Auto Prime mode (refer section in manual for further details).



Pump Motors require additional current at start-up to get running. Should the above display, the Pump has not been able to get enough current to operate on start-up. This could be due to too many electrical items on the one connection draining current from the Pump, or due to change in your local supply. Suggest removing any unnecessary items and restart. If still shows display warning, contact your local pool professional for assistance.

# PUMP DETAILS

At some stage you may be asked by your Pool Professional or Insnrng Service Department for the manufacturing details of your Pump. These appear on the Data Label adhered to the Volute, however, should this has been damaged or removed you control box has these details stored in it's program.

To access, hold the "Function" button and "I" button together and hold for Five (5) seconds. The display should change and show similar to below. Take note of the details and record for future reference.

**1. Manuf. Date : W35.2018**

**2. Serial No : K100-0365**

1. 현장에서 변경하면 안되는 경우  
Setting 기능을 사용하면 안됨

2. 이런 경우 표시 디폴트 값만 표시

# MAINTENANCE PROGRAM

WHEN?	WHAT ARE YOU LOOKING FOR?	HOW CAN YOU FIX?
<b>Weekly</b>	Check and Empty Basket	Empty Leaves and other debris
<b>Quarterly</b>	Check all Gaskets	Isolate and turn off the Pump. Remove all Gaskets and turn over. You can also apply a silicon based grease to extend the life. If dry, then contact your local pool professional to replace.
	Check around the unit for leaves/ debris or signs of flooding.	Replace any debris that is restricting air circulation around the Pump. If in a flood prone location, rectify.
	Check for any Insects/Ants etc	It is a good practice to use a good quality surface spray around your equipment. Make sure all units are turned off and then spray around all units to eliminate any insect/ ants etc
	Check for any leaks	If you notice any water leaking from the pump. Check gaskets first and reseal. If continues, contact your local pool professional to assess and rectify.

# WINTERISATION

Is it important to protect your High Performance Insnrng Pump from freezing water conditions. As water freezes it expands and that can cause the internals of the Pump to break under the intense pressure of expanding water. It is our to you to monitor temperatures and take the following actions:

1. In mild climate areas, when temporary freezing conditions may occur, run your pump and filtering equipment all night to maintain water circulation and prevent freezing.
2. If freezing conditions are expected, take the following steps to reduce the risk of freeze damage. Freeze damage is not covered under warranty.

**To prevent freeze damage follow the procedures listed below:**

1. Shut off electrical power for the pump at the house circuit breaker.]
2. Drain the water out of the pump housing by removing the two thumb-twist drain plugs from the housing. Store the plugs in the pump basket.
3. Cover the motor to protect it from severe rain, snow and ice. Once the freezing conditions are finished, it is important to reverse the above procedure and prime the pump for operation.

# TROUBLESHOOTING

The chart below identifies some of the main issues you may encountered with your pump. This should assist with the majority of problems. Insnrng highly recommends regular checks and maintenance of your swimming pool equipment by a qualified pool professional. This will extend the life of your equipment and give you the best performance.

WHAT IS THE PROBLEM?	WHAT YOU CAN DO ABOUT IT?
<b>Pump will not Prime</b>	<ul style="list-style-type: none"> <li>• Check that any Valves on the Suction and Return lines are open</li> <li>• Check that Lid and Gasket is correctly seated and sealed</li> <li>• Check Unions and Gaskets on Suction and Return side of the Pump are correctly seated and sealed</li> <li>• Fill Wet End of Pump with water as high as possible</li> <li>• Check that water level in the Pool is high enough that water is drawing into the Skimmer</li> <li>• Remove any suction cleaners from the Skimmer Box</li> </ul>
<b>Pump Gasket is damaged</b>	<ul style="list-style-type: none"> <li>• Important that the Gasket can fully seal and eliminate any air coming into the Pump. Replace if damaged.</li> </ul>
<b>Too much Air in the Pump Basket</b>	<ul style="list-style-type: none"> <li>• Check that any Valves on the Suction and Return lines are fully open</li> <li>• Check that Lid and Gasket is correctly seated and sealed</li> <li>• Check Unions and Gaskets on Suction and Return side of the Pump are correctly seated and sealed</li> <li>• Fill Wet End of Pump with water as high as possible</li> <li>• Check that water level in the Pool is high enough that water is drawing into the Skimmer</li> <li>• Remove any suction cleaners from the Skimmer Box</li> <li>• Check for any debris in Diffuser or Impellor</li> <li>• For a Variable Speed Pump, check that Pump Speed is at the correct level that your pool professional installed at</li> </ul>
<b>Debris in Diffuser or Impellor</b>	<ul style="list-style-type: none"> <li>• Switch off power to Pump</li> <li>• Remove the Wet End from the Seal Plate</li> <li>• Remove the Diffuser</li> <li>• Clean out debris from Impellor</li> <li>• Once clean, reassemble and prime pump</li> <li>• If problem still occurs, contact your local pool professional.</li> </ul>

# REPLACEMENT PARTS OF PUMP

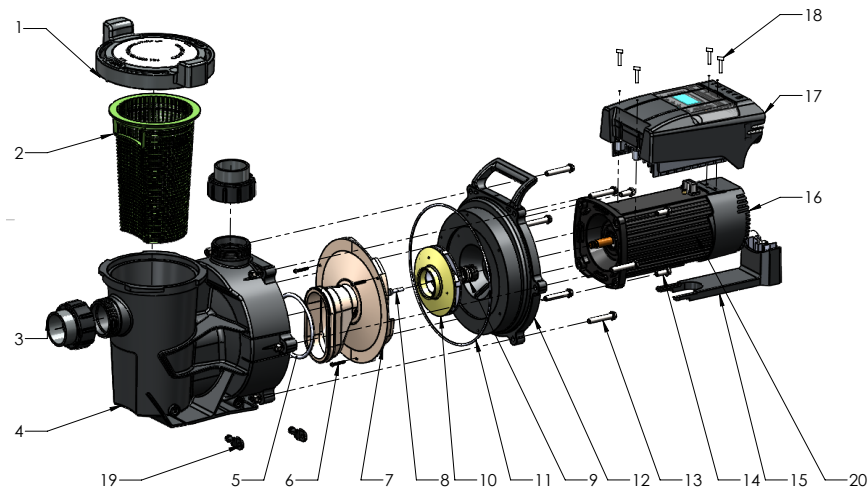

ITEM	CODE	DESCRIPTION	QTY
1	24201009	LID, O RING, LOCK RING ASSEMBLY	1
2	24101403001	PUMP, BASKET	1
3	15201001	UNION ASSEMBLY INCLUDING LOCK AND ORING	2
4	24101401001	PUMP VOLUTE	1
5	24C021602003	O RING DIFFUSER	1
6	10101014	6-20 X 1" PAN PHIL S/S316	3
7	24191491993	DIFFUSER	1
8	24101405006	1/4 NYLON 1h IMPELLER SCREW	1
9	24101512	MECHANICAL SEAL 5/8"	1
10	24201004	IMPELLER Qi 1100	1
10	24201005	IMPELLER Qi 1800	1
11	24C01602001	O RING SEAL PLATE	1
12	24201006	SEAL PLATE	1
13	10101010	3/8-16 unc X 2.3" S/S BOLT CAPTIVE WASHER	6
14	10101013	3/8-24UNF x 1" HEX S/S BOLT CAPTIVE WASHER	4
15	24101401004	MOTOR FOOT	1
16	24101405001	FAN COWL	1
17	24102509150	Controller Assembly VS Pump 1.5 HP	1
17	24102514200	Controller Assembly VS Pump 2.5 hp	1
18	24C01602003	COMMON - DIFFUSER ORING	1
19	152003	AIR BLEED VALVE ASSEMBLY PUMP	2
20	24102514100	VARIABLE SPEED MOTOR 1.5HP	1
20	24102514200	VARIABLE SPEED MOTOR 2.5HP	1

# WARRANTY

Insrg products are designed and manufactured to the highest possible standards of performance.

## Australian Consumer Law

Our goods come with guarantees that cannot be excluded under the Australian Consumer Law. You are entitled to a replacement or refund for a major failure and for compensation for any other reasonably foreseeable loss or damage. You are also entitled to have the goods repaired or replaced if the goods fail to be of acceptable quality and the failure does not amount to a major failure.

## Warranty Period and Conditions

Insrg Techne Pty. Ltd. (hereinafter "the Company") is pleased to warrant to the original retail purchaser that this product shall be free of manufacturing and material defects for a period of three (3) years from the original invoice date subject to the following conditions:

1. The product is purchased new from an authorised Insrg dealership in Australia, New Zealand or North America.
2. This warranty is not assignable and applies to the original retail purchaser only and the original receipt, invoice or any other proof of purchase must be retained and produced if requested by the Company.
3. Nothing in this warranty shall apply to any defects caused by misuse or abuse, neglect, accident, extremes of climate, dampness, humidity, reasonable fair wear and tear and/or any causes other than defects in manufacturing and materials. Proper care and maintenance information is detailed in the Owner's Manual for this product which you must follow.
4. Where a defect is physically visible or otherwise affects the exterior surfaces of the product, you must notify the Company of such defect within fourteen (14) days from the date of your purchase.
5. If the product is bought as a demonstration, refurbished, ex-rental, discontinued or otherwise previously unboxed unit, the warranty applicable shall be limited to twelve (12) months only.

## Warranty Claim Procedure

To exercise your rights under this warranty, you must:

Within fourteen (14) days of you becoming aware of any defect, report the following details to the dealership from which the product was purchased:

- Your name, address and contact information;
- Model, and serial number of the product; and
- A detailed description of the defect.

On receipt of the above information, the Company will allocate to your dealership an Insnrg Authorisation Number (IAN).

Depending on the model type, how it is installed, and the defect reported, your nominated dealership will advise on how the warranty service will be performed. This could include, but not limited to, return of product to the dealership, return of product to the company, or a visit by qualified service technician to your poolside.

If advised to return the product, place the defective product in secure packaging, clearly label it with the IAN number allocated and send it to the address of the authorised service agent which will be advised by your dealership.

The Company will not be liable for any transportation costs, or in the event that a poolside call is arranged with an authorised service technician, costs of technician's travel time if the defect is found not to be covered by the consumer guarantees.

In the case of returned product, the authorised service technician or dealership will contact the purchaser when the product has been repaired and is ready for collection.

The Company will repair or replace at its absolute discretion your product at no cost for parts or labour in accordance with the terms stated in this warranty provided that the reported defect is able to be located by the technical staff assigned to the product. If the technical staff is unable to locate the defect, you may be liable to pay for the cost of the technician's travel time and labour.

The logo for Insnrg, featuring the letters 'i', 'n', 's', 'n', 'r', 'g' in a lowercase, rounded font. The 'i' is teal, 'n' is orange, and the remaining letters are teal. To the right of the text is a large, stylized teal letter 'I'.

We know that you will get many years of enjoyment from this product.

Insnrg has been founded by persons with over 120 years experience in the Pool and Spa industry.

We pride ourselves on developing products that are specifically created for your backyard lifestyle. We are continuously developing new products and ideas to make pool ownership easier and fun.

Should you wish to keep updated with our progress and hear first hand our new products and developments, please feel free to stay in touch by using any or all of the below methods:

### SNAIL MAIL

64 Duerdin Street,  
Clayton, VIC, 3168

### LANDLINE

1800 INSNRG (1800 467674)

### WEBSITE

[www.insnrg.com](http://www.insnrg.com)



insnrg

PRODUCTS IN PERFECT SYNERGY