

LARSA4D

Reference Manual



LARSA 4D Reference Manual

A manual for

LARSA 4D
Finite Element Analysis and Design Software

Last Revised February 17, 2022

Copyright (C) 2001-2021 LARSA, Inc. All rights reserved. Information in this document is subject to change without notice and does not represent a commitment on the part of LARSA, Inc. The software described in this document is furnished under a license or nondisclosure agreement. No part of the documentation may be reproduced or transmitted in any form or by any means, electronic or mechanical including photocopying, recording, or information storage or retrieval systems, for any purpose without the express written permission of LARSA, Inc.

Table of Contents

Introduction	11
Model Data Reference	13
Properties	17
Materials	19
Material Name	19
Basic Isotropic Material Properties	19
Other Common Basic Properties	19
Other Material Properties for Time Dependent and Inelastic Analyses	20
Orthotropic Material Properties	20
Sections	23
General Section Properties	23
Properties for Time-Dependent Analysis	23
Properties for Inelastic Analysis	24
Stress Recovery Points	24
Section Dimensions	24
Centroid Offset	25
Spring Property Definitions	29
Nonlinear Elastic Spring Properties	29
Hysteretic (Nonlinear Inelastic) Spring Properties	30
6x6 Stiffness Matrix Properties	34
Isolator Property Definitions	37
User Coordinate Systems	39
The Global Coordinate System	39
Defining Coordinate Systems	39
Cylindrical Coordinate Systems	41
Spherical Coordinate Systems	42
Bridge Paths	43
Bridge Paths	47
Bridge Axes	48
Horizontal Geometry	48
Vertical Geometry	50
Superstructure Rotation	51
Time-Dependent Material Property Definitions	53
Creep and Shrinkage Properties for CEBFIP-78	53
Creep and Shrinkage Properties for CEBFIP-90	54
Other Properties	54
Material Curves	55
Relaxation Coefficients	55
Geometry	57
Joints	59
General Properties	59

Translational and Rotational Restraints	59
Displacement User Coordinate System	60
Members	61
Member Properties	61
Connection Beam Properties	65
Properties for Time-Dependent Material Effects	65
Member Coordinate Systems (Local Axes)	66
Self-Weight Computation	71
Spans	73
Plates	75
Usage Notes	75
Element Formulation	75
Attributes of Plates	78
Element Coordinate Systems	79
Self-Weight Computation	81
Springs	83
Usage Notes	83
Grounded Spring Element	83
Two-Node Spring Element	83
Hysteretic (Nonlinear Inelastic) Spring Element	84
General Attributes	85
Stiffness Attributes	86
Isolators	89
Mass Elements	91
DOF Constraints	93
Tendons	95
About the Tendon	95
Friction Losses	95
Anchorage Slip Losses	96
Elastic Shortening of Concrete Losses	96
Other Losses	97
Attributes	97
Path Geometry	98
Example Path	102
Lanes	105
Basic Properties	105
Path Geometry	106
Lane Path Example	108
Loads	111
Static Load Cases	113
Static Load Types	113
Load Case Options	113
Additional Dynamic Mass	113
Load Combinations	115

Including Response Spectra Cases	115
Including Moving Load Cases	115
Use in Nonlinear Analysis	115
Self Weight	117
Weight Factor and Gravity Load Directions	117
Self Weight Computation	117
In Staged Construction Analysis	117
Joint Loads	119
Support Displacements	121
Member Loads	123
Member Thermal Loads	127
Load Input	127
Nonlinear Thermal Gradient Curves	128
Plate Loads	129
Plate Load Fields	129
Point Load Coordinates	130
Moving Loads	133
Influence Loads	135
Time History Loads	137
Excitation Functions	137
Initial Conditions	138
Construction Activities	139
Construct and Deconstruct Activities	141
Deconstruction	141
Self Weight	141
Segmental Construction Methods	141
Load Activities	145
Creating Load Activities	145
Using Load Activities	145
Self-Weight Load Cases	145
Support and Hoist Activities	147
Support Activities	147
Hoist Activities	147
Activity Fields	147
DOF Constraint Change Activities	149
Activity Fields	149
Tendon Stressing and Slackening Activities	151
Activity Fields	151
Displacement Initializations	153
What It Does	154
Activity Fields	154
Cast Concrete Activities	155

Composite Section Construction Activities	157
Analysis Scenarios	161
Analysis Reference	163
Linear and Nonlinear Static Analysis	167
Linear Static Analysis	169
Structure Model for Linear Static Analysis	169
Analysis Results	169
Assumptions in a Linear Static Analysis	170
P-Delta Analysis	171
Using Load Combinations for the P-Delta	171
Caveats	171
Method	171
Convergence Criteria	171
Nonlinear Static Analysis	173
Why a Nonlinear Analysis	173
Applications of the Nonlinear Analysis	174
Equations of Equilibrium and Solution	174
Caveats	174
Incremental Loading	175
Convergence Criteria	175
Displacement Convergence and Unbalanced Forces	175
Load Case Data for Nonlinear Static Analysis	176
Nonlinear Static Analysis Options	177
Eigenvalue and Response Spectra Analysis	179
Eigenvalue and Stressed Eigenvalue Analysis	181
Unstressed (Standard) Eigenvalue Analysis	181
Stressed Eigenvalue Analysis	181
Eigenvalue Analysis within Staged Construction Analysis	181
Eigenvalue Analysis Options	183
Stressed Eigenvalue Analysis Options	185
Response Spectra Analysis	187
Response Spectrum Curves	187
Preparing the Eigenvalue Analysis	189
Using the Response Spectra Case Tool	189
Tool Options	191
Accessing RSA Results	193
Nonlinear Buckling and Pushover Analysis	195
Nonlinear Buckling Analysis	197
Advantages of a Nonlinear Analysis	197
Using the Nonlinear Buckling Analysis	197
Nonlinear Pushover Analysis	199
Incremental Nonlinear and Nonlinear Buckling Analysis Options	201

Nonlinear Pushover Analysis Options	203
Linear and Nonlinear Time History Analysis	205
Linear Time History Analysis	207
Linear Time History Analysis within Staged Construction Analysis	207
Linear Time History Analysis Options	209
Nonlinear Time History Analysis	211
Overview	211
Newmark-Beta with Newton-Raphson	211
Sparse Solver Technology	211
Nonlinear Time History Data	211
Nonlinear Time History Analysis within Staged Construction Analysis	211
Nonlinear Time-History Analysis Options	213
Geometric Nonlinearity	213
Static Moving Load Analysis, Dynamic Rolling Stock Analysis, Influence-based Live Load Analysis, and Vehicle-Track-Structure Interaction Analysis	215
Linear Static Moving Load Analysis and Dynamic Rolling Stock Analysis	217
Preparing a Moving Load Analysis	217
Linear Static Moving Load Analysis	217
Linear Dynamic Rolling Stock Analysis	218
Standard Vehicles	219
AASHTO and CALTRANS Vehicles	219
AASHTO Load Patterns for Influence Analysis	219
IRC Load Patterns for Influence Analysis	220
Influence Line & Surface Analysis	223
Influence Analysis Overview and Options	225
The Assumption of Linearity	225
The Vehicle Loading Algorithm	225
Performing an Influence Analysis	226
General Loading Parameters	227
Vehicular Loading Options	230
Uniform/Patch Loading Options	234
Procedure: Getting Results	234
Suggestions for Influence Analysis	237
Suggestions for Speed	237
Vehicle-Track-Structure Interaction Analysis	239
Methodology and Rationale	239
Model Setup Procedure	240
Accessing Dynamic Results	244
Staged Construction Analysis	247
Overview of Staged Construction Analysis	249
Staged Construction Activities	251

Setting Up the Model	253
Preparation	253
Creating Activities in the Explorer	254
Creating Activities in the Stage Editor	256
Time Effects on Materials	261
Material Time Effects	261
Design Codes	263
Load Class Tracking	265
Setting up the model	265
The Load Classes of Result Cases	265
Accessing Class-Based Results	266
Staged Construction Analysis Options	267
Options for Analysis Scenarios	268
Solver Options	271
Analysis Results Reference	273
Joint Results	275
Joint Displacements	277
Definitions	277
Joint Reactions	279
Definitions	279
Joint Velocities & Accelerations	281
Definitions	281
Member Results	283
Member End Forces	285
Definitions - General	285
Definitions - When Reported in Local Directions	285
Definitions - When Reported in Global Directions	286
Member Sectional Forces	287
Definitions	287
Member Stresses	289
Computation of Normal Stress	289
Definitions	289
Member Displacements	291
Definitions	291
Member Plastic Deformation	293
Definitions	293
Member Yield and Strains	295
Definitions	295
Span Displacements and Span Sectional Forces	297
Analyzed Member Loads	299
Definitions	299

Plate Results	301
Plate Forces on Center	303
Definitions	303
Plate Forces at Joints - External	307
Definitions	307
Plate Forces at Joints - Internal	309
Definitions	309
Plate Stresses on Center and at Joints	313
Definitions	314
Spring Results	317
Spring Forces	319
Local Axial/Local Torsional Springs	319
Translation/Rotation X/Y/Z Directions	319
Spring Deformations	321
Local Axial/Local Torsional Springs	321
Translation/Rotation X/Y/Z Directions	321
Compound Element Forces	323
Procedure	323
Sample Problem	323
Definitions	326
Tendon Results	329
Eigenvalue Results	331
Modal Frequencies	333
Definitions	333
Mode Shapes	335
Definitions	335
Modal Reactions and Modal Member/Plate Forces	337

Introduction

LARSA 4D is the premier general purpose structural analysis and design software. In use throughout the world, LARSA 4D boasts advanced analytical features, from influence surface based analysis to nonlinear time history analysis, and an all-new user interface. LARSA 4D: 4th Dimension, the most advanced program in the LARSA 4D series, features staged construction analysis and time-dependent material properties.

Clients have turned to LARSA for over 25 years for their structural analysis needs. The LARSA structural analysis engine was originally developed to perform nonlinear static analysis of structures with large displacements, such as suspension and cable-stayed bridges. But, LARSA has come a long way since it was first available on the VAX super-mini computers decades ago. Today, LARSA 4D has the only truly 3D analysis engine providing all of the tools segmental bridge and large-scale structures engineers can no longer live without.

This is the LARSA 4D Reference Manual, a part of the series of manuals for LARSA 4D. This manual is split into three sections. In the first, *Model Data*, LARSA's element library and model definitions are explained. The second section, *Analysis Reference*, describes how the various types of analysis are performed by the LARSA analysis engine and explains analysis parameters. The last section, *Analysis Results*, explains how to interpret the results of an analysis.

Separate manuals are available that delve deeper into specific uses of LARSA 4D: staged construction analysis, bridge analysis, and pushover analysis. In addition, the User's Guide explains how to use LARSA 4D's user interface, and the Samples and Tutorials manual provides a hands-on method for learning about the program.

Part I

Model Data Reference

The Model Data Reference details the input data describing the structural geometry, element behavior properties, and loading of the structure.

Properties	17
Materials	19
Material Name	19
Basic Isotropic Material Properties	19
Other Common Basic Properties	19
Other Material Properties for Time Dependent and Inelastic Analyses	20
Orthotropic Material Properties	20
Sections	23
General Section Properties	23
Properties for Time-Dependent Analysis	23
Properties for Inelastic Analysis	24
Stress Recovery Points	24
Section Dimensions	24
Centroid Offset	25
Spring Property Definitions	29
Nonlinear Elastic Spring Properties	29
Hysteretic (Nonlinear Inelastic) Spring Properties	30
6x6 Stiffness Matrix Properties	34
Isolator Property Definitions	37
User Coordinate Systems	39
The Global Coordinate System	39
Defining Coordinate Systems	39
Cylindrical Coordinate Systems	41
Spherical Coordinate Systems	42
Bridge Paths	43
Bridge Paths	47
Bridge Axes	48
Horizontal Geometry	48
Vertical Geometry	50
Superstructure Rotation	51
Time-Dependent Material Property Definitions	53
Creep and Shrinkage Properties for CEBFIP-78	53
Creep and Shrinkage Properties for CEBFIP-90	54

Other Properties	54
Material Curves	55
Relaxation Coefficients	55
Geometry	57
Joints	59
General Properties	59
Translational and Rotational Restraints	59
Displacement User Coordinate System	60
Members	61
Member Properties	61
Connection Beam Properties	65
Properties for Time-Dependent Material Effects	65
Member Coordinate Systems (Local Axes)	66
Self-Weight Computation	71
Spans	73
Plates	75
Usage Notes	75
Element Formulation	75
Attributes of Plates	78
Element Coordinate Systems	79
Self-Weight Computation	81
Springs	83
Usage Notes	83
Grounded Spring Element	83
Two-Node Spring Element	83
Hysteretic (Nonlinear Inelastic) Spring Element	84
General Attributes	85
Stiffness Attributes	86
Isolators	89
Mass Elements	91
DOF Constraints	93
Tendons	95
About the Tendon	95
Friction Losses	95
Anchorage Slip Losses	96
Elastic Shortening of Concrete Losses	96
Other Losses	97
Attributes	97
Path Geometry	98
Example Path	102
Lanes	105
Basic Properties	105
Path Geometry	106

Lane Path Example	108
Loads	111
Static Load Cases	113
Static Load Types	113
Load Case Options	113
Additional Dynamic Mass	113
Load Combinations	115
Including Response Spectra Cases	115
Including Moving Load Cases	115
Use in Nonlinear Analysis	115
Self Weight	117
Weight Factor and Gravity Load Directions	117
Self Weight Computation	117
In Staged Construction Analysis	117
Joint Loads	119
Support Displacements	121
Member Loads	123
Member Thermal Loads	127
Load Input	127
Nonlinear Thermal Gradient Curves	128
Plate Loads	129
Plate Load Fields	129
Point Load Coordinates	130
Moving Loads	133
Influence Loads	135
Time History Loads	137
Excitation Functions	137
Initial Conditions	138
Construction Activities	139
Construct and Deconstruct Activities	141
Deconstruction	141
Self Weight	141
Segmental Construction Methods	141
Load Activities	145
Creating Load Activities	145
Using Load Activities	145
Self-Weight Load Cases	145
Support and Hoist Activities	147
Support Activities	147
Hoist Activities	147
Activity Fields	147

DOF Constraint Change Activities	149
Activity Fields	149
Tendon Stressing and Slackening Activities	151
Activity Fields	151
Displacement Initializations	153
What It Does	154
Activity Fields	154
Cast Concrete Activities	155
Composite Section Construction Activities	157
Analysis Scenarios	161

Properties

Property data are specifications of element behavioral properties that are used for one or more elements in the structure. These include materials, sections, nonlinear spring behavior definitions, isolator and bearing property definitions, and time-dependent material property definitions. User coordinate systems are also defined in this section.

Materials	19
Material Name	19
Basic Isotropic Material Properties	19
Other Common Basic Properties	19
Other Material Properties for Time Dependent and Inelastic Analyses	20
Orthotropic Material Properties	20
Sections	23
General Section Properties	23
Properties for Time-Dependent Analysis	23
Properties for Inelastic Analysis	24
Stress Recovery Points	24
Section Dimensions	24
Centroid Offset	25
Spring Property Definitions	29
Nonlinear Elastic Spring Properties	29
Hysteretic (Nonlinear Inelastic) Spring Properties	30
6x6 Stiffness Matrix Properties	34
Isolator Property Definitions	37
User Coordinate Systems	39
The Global Coordinate System	39
Defining Coordinate Systems	39
Cylindrical Coordinate Systems	41
Spherical Coordinate Systems	42
Bridge Paths	43
Bridge Paths	47
Bridge Axes	48
Horizontal Geometry	48
Vertical Geometry	50
Superstructure Rotation	51
Time-Dependent Material Property Definitions	53
Creep and Shrinkage Properties for CEBFIP-78	53
Creep and Shrinkage Properties for CEBFIP-90	54

Other Properties	54
Material Curves	55
Relaxation Coefficients	55

Materials

Material properties set the elastic modulus, unit weight, and other isotropic, orthotropic, hysteretic, and time-dependent material properties for members, plates, and tendons.

Material properties most often define isotropic linear elastic behavior using elastic modulus, shear modulus, and unit weight. Materials can also hold orthotropic material properties when assigned to plate elements starting in version 8.01. Time-dependent material properties (page 261) can also be set when used with member and plate elements in a Time-Dependent Staged Construction Analysis. And when assigned to hysteretic beam elements (page 61), additional properties can be used to define inelastic behavior.

The following material properties can be set:

Material Name

Name

A material's name is used to refer to the material throughout the project.

Basic Isotropic Material Properties

The behavior of an isotropic material does not depend on the direction of loading or the orientation of the material. Shearing behavior is uncoupled from extensional behavior.

Modulus of Elasticity

Young's Modulus (Elastic Modulus) of the material.

Poisson Ratio

Poisson ratio of the material. The range from 0.0 to 0.5 is common, but the ratio must be less than 0.50.

Shear Modulus

Shear Modulus of the material. The Poisson ratio can be calculated using the Young's modulus and shear modulus. When any two of the Young's Modulus, Poisson ratio, and shear modulus are specified, the third is automatically calculated.

Other Common Basic Properties

Unit Weight

Weight density (weight per unit volume) of the material. The self-weight of elements in a static analysis and the mass due to self-weight in a dynamic analysis are computed using this entry. If the unit weight is not entered (zero), the element is assumed weightless.

Coefficient of Thermal Expansion

The coefficient of thermal expansion is used when thermal loadings are specified for the structure. If there are no thermal loads, this field is optional. The unit of this field is $\times 10^{-6}$, meaning a value of 6.5×10^{-6} should be entered as simply 6.5.

Other Material Properties for Time Dependent and Inelastic Analyses

These fields are used for steel design, time dependent analyses and inelastic elements in nonlinear analyses.

Yield Stress

The yield stress is used to compute the plastic moment capacity for beams. The plastic moment capacity is computed as the plastic section modulus times the material yield stress. In pushover analysis, element stiffness is reduced by the Post-Yield to Initial Slope Ratio after this point is reached.

Post-Yield to Initial Slope Ratio

This entry defines the slope of the stress-strain curve after the material yields. The field is the ratio of the post-yield stress-strain slope to the pre-yield stress-strain slope.

Concrete Strength Specimen

The specimen type used to get the 28 day strength of the material. It can be either cylinder or cube.

Concrete Fck or Steel Fu

The meaning of this column depends on whether the material is concrete or steel.

When the material is concrete, this entry holds the characteristic (also known as specified) strength of concrete (Fck) and is used in Time-Dependent Staged Construction Analysis creep and shrinkage and in the Ultimate Strength tool.

When the material is steel, this entry holds Fu, which is used in steel design.

Concrete Cement Hardening Type

Cement hardening type to be used in a time-dependent analysis. If the material is not subject to creep and shrinkage, select Not Concrete.

Tendon GUTS (Guaranteed Ultimate Tensile Stress)

Required data for tendons. This is the guaranteed ultimate yield stress.

Material Time-Effect

This entry determines long-term material time effects, such as relaxation in tendons, creep and shrinkage in a concrete members and also the elastic modulus variation of the all elements as a function of age, that members or tendons assigned this material are subject to during the Staged Construction Analysis (page 247) (see Time Effects on Materials (page 261)). Choices are drawn from time-dependent material property definitions (page 53). A time-dependent material property definition can also be assigned to a member via its section (page 23). It is invalid to have a member for which both its material and its section have been assigned a time-dependent material property definition.

Orthotropic Material Properties

Although the plate element typically uses an isotropic material, it can also be assigned an orthotropic material with properties that vary in the element's two transverse dimensions starting in version 8.01.

Sheet metal formed by squeezing thick sections of metal between heavy rollers is an example of an orthotropic material. The squeezing flattens and stretches the grain structure of the metal, as a result making it anisotropic. Its properties differ between the direction it was compressed in and each of the two transverse directions. Some other orthotropic materials are wood, laminated plastics, and reinforced concrete. Orthotropic steel bridge deck plates can be modeled using orthotropic materials with plate elements.

For more information about how orthotropic materials apply to plate elements, see Plates (page 75). To create an orthotropic material, the following properties are used:

Material UCS

A user coordinate system that determines the material axes of the plates to which the material is assigned. If not set, the Global Coordinate System is used. See see Plates (page 75) for more information about material axes.

E11

Modulus of Elasticity in the direction of the Material 1 axis.

E22

Modulus of Elasticity in the direction of the Material 2 axis

m12

Poisson ratio that describes the amount of deformation in the Material 2 direction when a unit deformation occurs in the Material 1 direction. The poisson ratio in the orthogonal direction, i.e. m21, is automatically calculated from E11, E22, and m12.

G12

In-plane shear modulus.

G13

Out-of-plane shear modulus of the element's face whose outward unit normal is parallel to Material 1 axis. Applies to the thick plate element only.

G23

Out-of-plane shear modulus of the element's face whose outward unit normal is parallel to Material 2 axis. Applies to the thick plate element only.

For More Information, please refer to the following documentation.

- Members on page 61.
- Time Effects on Materials on page 261.
- For help on using spreadsheets, see Using the Model Spreadsheets in *LARSA 4D User's Manual*.

Sections

Section data is for describing the geometric and analytic cross-sectional properties of members. Section properties are assigned to members.

The section property data is arranged in three groups:

General Properties

The first group is for the most often used property data in the analysis such as area and inertias.

Stress Recovery Points

The second group is for stress recovery points, which are the coordinates of the extreme points or edge points on the section. These points are also used for defining tendon and lane paths.

Section Dimensions

The last group is for physical section dimensions, which is used for graphical rendering and computation of section properties.

All section properties are entered with respect to the reference coordinate system of the member (see Members (page 61)).

General Section Properties

Name

A section's name is used to identify the section throughout the project.

Section Area

The gross cross-sectional area of the section for axial stiffness. Since truss and cable elements have only axial stiffness, the cross-sectional area is the only property needed for truss and cable elements.

Shear Areas

The shear areas A_y and A_z are for transverse shear in the xy- and xz-planes of with corresponding transverse shear stiffness as $A_y * G$ and $A_z * G$.

Torsional Constant

Torsional constant is the area moment about the member x-axis for torsional stiffness.

Moment of Inertias I_{yy} and I_{zz}

These are the area moments of inertia I_{yy} and I_{zz} about the member local y- and z-axes, respectively. These values are used for the bending stiffness of beam elements.

Properties for Time-Dependent Analysis

Perimeter

The perimeter of the section. This is used to determine the notional thickness of the section.

Material Time-Effect

This entry determines long-term material time effects, such as creep and shrinkage in a concrete members and the elastic modulus variation of the all elements as a function of age, that members assigned this section are subject to during the Staged Construction Analysis (page 247) (see Time Effects on Materials (page 261)). Choices are drawn from time-dependent material property definitions (page 53). A time-dependent material property definition can also be assigned to a member via its material (page 19). It is invalid to have a member for which both its material and its section have been assigned a time-dependent material property definition.

Properties for Inelastic Analysis

Plastic Section Modulus Z_{yy} and Z_{zz}

Plastic section moduli are used for calculating the plastic moment capacity of beam elements in nonlinear inelastic analysis. Plastic section modulus Z_{yy} is for yield moment M_y where $M_y(\text{yield}) = Z_{yy} * F_y$ (bending about y) and plastic section modulus Z_{zz} is for yield moment M_z where $M_z(\text{yield}) = Z_{zz} * F_y$ (bending about z).

Ductility

The ductility factor. This is used in an inelastic nonlinear analysis to determine hysteretic beam behavior.

Residual Strength (%)

The residual strength used in nonlinear analysis for the property of hysteretic beams.

Additionally, a yield surface can be set for the second. See below for setting the yield surface.

Stress Recovery Points

The stress recovery points are y and z coordinates in the member reference coordinate system (page 61) for points on the outer edges of the section where the user desires stresses (page 289) to be reported at. Six stress recovery points can be entered directly on sections spreadsheet. More stress recovery points can be specified using the special commands (see below).

The coordinates of these points are specified in the member reference coordinate system using the proper sign convention with respect to the member's axes. See Members (page 61). When the section has a centroid offset (see below), stress recovery points are relative to the reference axis, not the centroid.

If the coordinates for the stress recovery points are not specified, only the stresses at the centroid of the section ($y=0$ and $z=0$) are reported.

These points are also used in linear thermal gradient loads (page 127), locating tendons (page 95) in beams when tendon locations are specified with reference to the top/bottom or left/right edges of the section, and in lane (page 105) definitions with y/z offsets. The first stress point is assumed to be at the top right corner of the section, in the positive- y /positive- z quadrant, and the third stress points at bottom left, in the negative- y /negative- z quadrant.

The location of the stress recovery points are computed automatically when the Custom Section utility is used or when sections are imported from a database. When sections are imported from the Section Composer [see "LARSA Section Composer" in *LARSA Section Composer Manual*], stress recovery points are set in the Section Composer, not in LARSA 4D.

Section Dimensions

These are the dimensions used in the Custom Sections tool when computing properties from dimensions or when sections are imported from a database. These dimensions are used for graphically rendering the actual shape.

The types of dimension measurements for a section vary according to the shape.

Centroid Offset

Sections defined in the Section Composer [see “LARSA Section Composer” in *LARSA Section Composer Manual*] may not have their COG lined up with the member reference x-axis, which is the joint-to-joint line for the member (plus member end offsets). When this is the case, the section is said to have a centroid offset. In these cases, the member local axes, which are at the COG, do not match the member reference axes. The local axes are used in the placement of member loads (page 123) and in the reporting of member end forces (page 285), sectional forces (page 287), and stresses (page 289). The reference axes, however, are used in the definitions of tendons (page 95) and lanes (page 105).

Additional Commands

Some additional related commands are available. These commands are used to modify input data or to access additional attributes of the data referenced above. The commands can generally be accessed in one of several ways.

In the Sections spreadsheet, the commands are available in the Sections menu, or by right-clicking the spreadsheet. Some commands can be applied to more than one row in the spreadsheet at once by selecting multiple rows before activating the command.

The additional commands are as follows:

Calculate Properties

When the section shape and dimensions are given in the Section Dimensions spreadsheet, this command computes the analytic properties of the cross-section based on the shape and dimensions provided. The properties computed are: area, I_{yy} , I_{zz} , J , shear areas, perimeter, and plastic section moduli. This command must be activated whenever the shape or dimensions are changed to update the analytic properties.

Edit Parameters

When a section has been imported from the Section Composer, this command brings up a window where the geometric parameters used to define the section can be viewed and edited. Nonprismatic variation and the analytic properties at points along the span can also be inspected.

Edit Yield Surface

Opens a spreadsheet to edit the yield surface of the section, which is used to determine the behavior of inelastic hysteretic members (page 61). The yield surface is defined by planar surfaces given by the user. The resulting yield surface is the surface of the volume enclosed by the planes. Each plane is given as 1) a vector $\langle a, b, c \rangle$ normal to the plane and 2) an offset distance d from the origin to the plane, in the direction of the normal vector. This defines the plane $ax + by + cz + d = 0$. The component a corresponds to the bending moment about the local z axis of the member. The component b corresponds to the bending moment about the local y axis of the member. And the component c corresponds to the axial force in the member.

As a simplified example, a cube is made of six planar surfaces with the vectors and offsets shown in the image below.

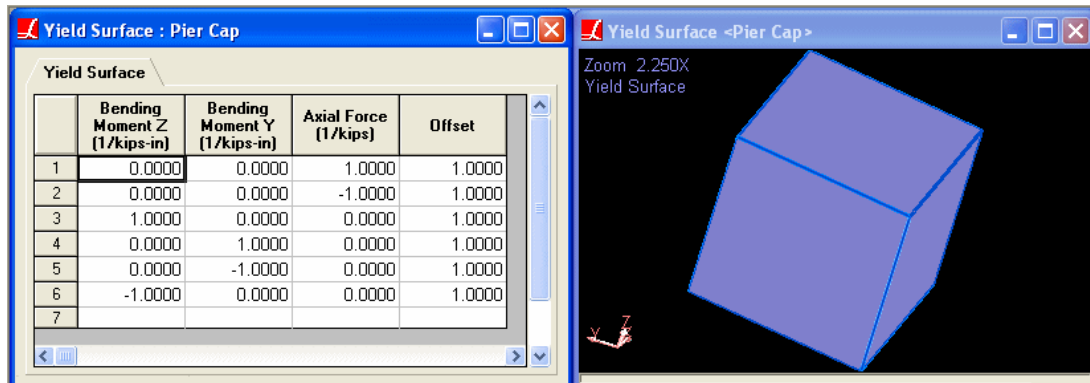

Cube-Shaped Yield Surface Definition

More Stress Points

This command is available in the Section Stress Recovery Points spreadsheet and allows the user to enter more than six stress recovery points.

Section Fiber Width vs Depth

This will be used for nonlinear temperature gradients.

Section Fiber Depth vs Width

This will be used for nonlinear temperature gradients.

Rebars

This command opens a spreadsheet to define the rebars present in the section. Rebar information will be used for concrete design.

Moment (y) Curvature

For hysteretic connection beam members (see the member element (page 61)), a family of moment-curvature spring curves can be entered to specify the inelastic behavior of the beam. With this method, the user is responsible for determining the moment-curvature relation data for the member at different axial loads. Moment curvature relations are entered as spring curve definitions (page 29) with the type field set to *Moment curvature*. Additionally, the Axial Force field of the spring curve is set to the axial force at which the curve is applicable. The *Moment (y) Curvature* tool opens a spreadsheet where the family of moment curvature curves for y-moment can be chosen.

Moment (z) Curvature

See the description of the *Moment (y) Curvature* tool. This tool opens a spreadsheet where the family of moment curvature curves for z-moment can be chosen.

For More Information, please refer to the following documentation.

- For help on using spreadsheets, see Using the Model Spreadsheets in *LARSA 4D User's Manual*.
- Members on page 61.
- Tendons on page 95.

- LARSA Section Composer in *LARSA Section Composer Manual*.

Spring Property Definitions

Spring property definitions set the behavior of one or more spring elements used in the model. Spring property definitions are applied to spring elements (page 83) to give the elements their nonlinear elastic, hysteretic (nonlinear inelastic), or stiffness matrix-based material properties. Linear springs do not need to be assigned spring property definitions. Spring property definitions are also used for moment-curvature beam properties.

The three main types of spring property definitions are described below:

- Nonlinear Elastic
- Hysteretic (Nonlinear Inelastic)
- 6x6 Stiffness Matrix

The use of spring property definitions for moment-curvature beam properties is described in Sections (page 23).

Nonlinear Elastic Spring Properties

Nonlinear elastic spring property definitions are applicable for nonlinear grounded (one-node) springs and nonlinear two-node springs. Choose either **Curve: Translational** or **Curve: Rotational** as the spring property type. Then use the **Edit Curve** command to enter a nonlinear spring curve.

Nonlinear spring curve

A tabular function describes the force-deformation curve of nonlinear elastic springs (as well as hysteretic springs as described in the next section). These curves can be for both translational and rotational springs. The horizontal axis of the curve is the deformation, either in linear or angular dimensions, and the vertical axis is the force or moment.

For nonlinear elastic springs, the curve data can be of any shape and with any number of data points, but the curve data points must be entered in ascending order by displacement and must include the point (0, 0). Generally, springs have positive stiffness, which appears as an upward-sloping function. (Hysteretic spring curves must omit the (0,0) point and have other restrictions on their shape and number of points. See below.)

The sign convention is as follows:

When assigned to grounded (i.e. one-node) springs

Positive displacements will produce positive forces and negative reactions. That is, if the joint connected to a grounded spring displaces in the positive direction (of the spring's Direction attribute), then the force in the spring will be determined from the positive side of the spring curve.

When assigned to two-node springs acting in the Local Axial direction

Extensions and tensile forces have positive signs; Shortening and compressive forces have negative signs.

When assigned to two-node springs acting in the Local Torsional direction

Positive displacement corresponds to positive rotation of the end joint relative to the start joint, following the right-hand rule, about the joint-to-joint line.

When assigned to two-node springs acting in the translational or rotational x, y, or z directions

Positive displacement corresponds to positive displacement or rotation of the end joint relative to the start joint in that direction. That is, positive displacement does not necessarily correspond with tension or extension. Rather, it follows the relative displacement of the end joint compared to the start joint.

The stiffness \mathbf{k} of a spring in the tangent stiffness matrix is the slope of the curve and varies as a function of the deformations in the spring. The value is computed in the following manner:

- Assume an iteration in nonlinear analysis is performed and joint displacements are known for this iteration.
- Deformation (elongation or rotational deformation) of the element is computed using the nodal displacements of the element.
- With deformation known, the spring force is determined from the tabular deformation-force curve assigned as the material property. For the nonlinear spring, the table look-up is performed using linear interpolation within the table and linear extrapolation outside the table using the last two end points at the appropriate table end. For the inelastic spring, the spring force is precomputed for deformations within the table and is assumed to be zero outside the table (beyond the end points of the curve).
- Note that the familiar rule of linear elastic spring $f=ku$ does not apply to nonlinear springs.
- The stiffness is computed as the slope of the curve corresponding to the computed deformation where x-axis is the deformation.
- The spring force and the new stiffness is used in the next iteration of the nonlinear analysis to establish the unbalanced load vector and tangent stiffness matrix of the structure.

Hysteretic (Nonlinear Inelastic) Spring Properties

Hysteretic (nonlinear inelastic) spring properties can be entered by choosing **Hysteretic: Translational** or **Hysteretic: Rotational** as the spring property type.

The “backbone” curve of the hysteretic model is entered as a nonlinear spring curve, similar to how the force-deformation curve is entered for nonlinear elastic springs. This curve is restricted to have the same compressive and tensile stiffnesses in the pre-yield range. Therefore, point (0,0) should not be entered. The curve has other constraints depending on the backbone type, described below.

The following parameters specify the stiffness of the spring after yielding, during unloading, and in any following loading-unloading cycles.

Backbone

The force-deformation relationship can be either **Bilinear** or **Trilinear**.

Bilinear backbones are defined using 4 points, where the second and third points correspond to negative and positive yield forces F_y .

Trilinear backbones are defined using 6 points, where the second and fifth points correspond to negative and positive yield forces F_y . Trilinear curves can accommodate cracking in addition to yielding. The third and fourth points then correspond to negative and positive cracking force F_{cr} . Trilinear backbone curves can be used to define plastic-multilinear behavior (with the mentioned constraint that the compressive and tensile stiffnesses are equal in the pre-yield range).

Beyond the ultimate points (u_u, F_u) , the force is assumed to be zero for both backbone curves.

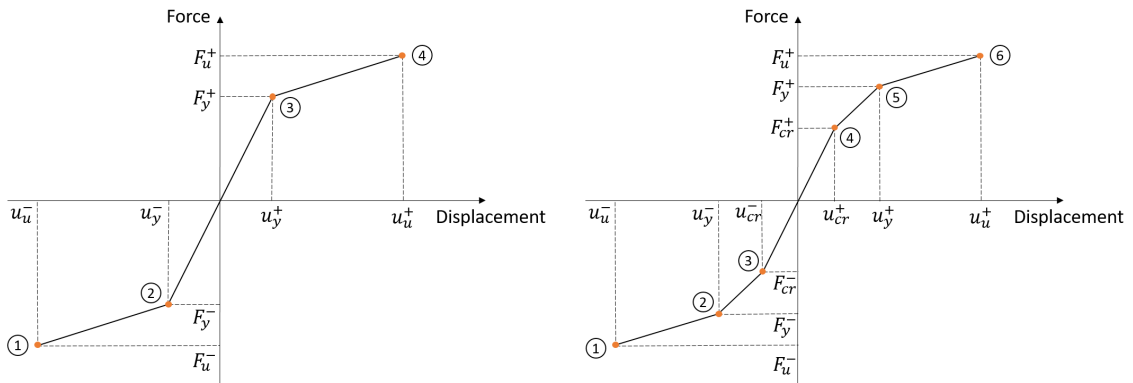

Bilinear or trilinear backbone curves

Depending on the shape of the backbone curve, an elastic-perfectly plastic behavior or elastic-plastic behavior with postyielding hardening can be modeled.

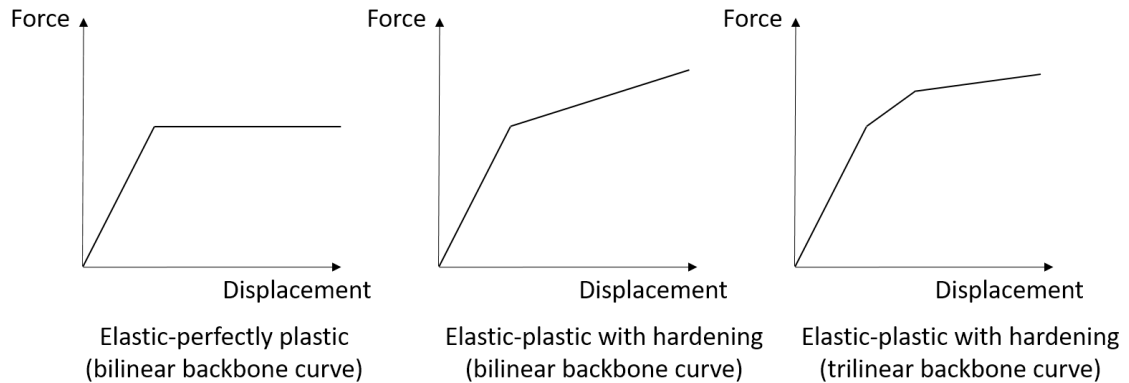

Modeling elastic-perfectly plastic and elastic-plastic behavior with hardening

Polygonal Hysteretic Model (PHM)

A hysteretic model with piecewise linear (multi-linear) behavior.

Bilinear cyclic behavior is available with a bilinear backbone curve.

With a trilinear backbone curve, **Vertex-oriented** or **Yield-oriented** behavior can be modeled. In the model with vertex oriented PHM, the response curve “shoots” for the backbone vertexes. Yield-oriented PHM corresponds to response curve “shooting” for the backbone curve's yield points. The yield-oriented model includes slip (see Gamma parameter below). Internally, a set of hysteresis loop control points are created based on backbone curve parameters. These points are connected by *branches* that correspond to various response stages (for example, elastic behavior, cracking, yielding, unloading). The cyclic behavior then determines transitions between branches.

Alpha

Stiffness degradation parameter. The stiffness degrades due to nonlinear geometric effects. In this model, the stiffness degradation is modeled using the pivot rule. This rule can be described as follows. A pivot point is chosen on the elastic branch of the hysteresis loop. The location of the point is governed by alpha. The load-reversal branch then targets the pivot point. In the example below, the unloading branch corresponds to the load

reversal direction. This branch targets a pivot point on the left (negative) side of the elastic branch. Similarly, if subsequent loading follows the unloading, the loading branch will target a pivot point on the right (positive) side of the elastic branch. Values of alpha equal to 200 or greater cause negligible stiffness degradation, as in a simple bilinear model. Smaller values (typically less than 10) imply higher stiffness degradation, i.e. a smaller slope in the force-deformation curve.

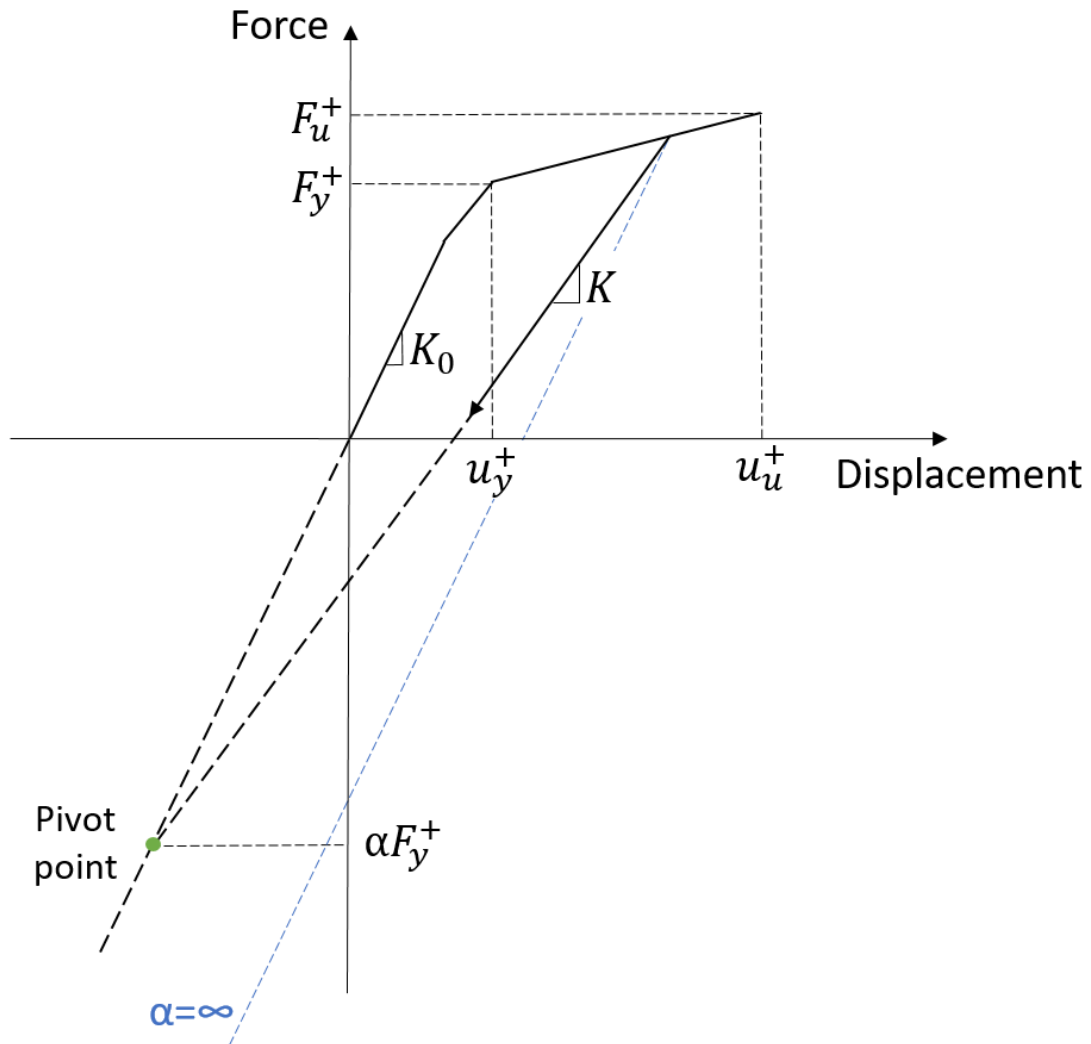

Modeling of stiffness degradation using the pivot rule

Beta 1

Ductility-based strength degradation parameter. This describes the reduction in strength ("yield capacity," the force at which yielding begins) as a function of the degree of (plastic) deformation. A value of zero causes no stiffness degradation due to plastic deformation, as in a simple bilinear model. Values greater than zero cause stiffness degradation, and the value 1.0 causes rapid degradation.

Beta 2

Energy-based strength degradation parameter. This describes the reduction in strength as a function of energy dissipated throughout the cycles of loading and unloading. Roughly, then, this is the degradation as a function

of the number of loading and unloading cycles. A value of zero causes no stiffness degradation due to energy dissipation, as in a simple bilinear model. Values greater than zero cause stiffness degradation, and the value 1.0 causes rapid degradation.

Gamma

Slip parameter. This parameter controls the amount of pinching of hysteresis loops. Pinching of hysteresis loops is the reduction of their area (and the amount of dissipated energy) due to the opening and closing of cracks in concrete and masonry structures and due to repeated buckling in steel frames. First, if cracks occur, crack opening causes stiffness reduction. If the loading direction is then reversed, the crack may eventually close and some of the lost stiffness may be recovered. In this model, slip is included by redefining a target point for the loading branch. The new target point is lowered to the force level equal to a fraction of the yield force. The corresponding deformation level is a weighted average of the yield and maximum deformation. This new target point is the crack closing point.

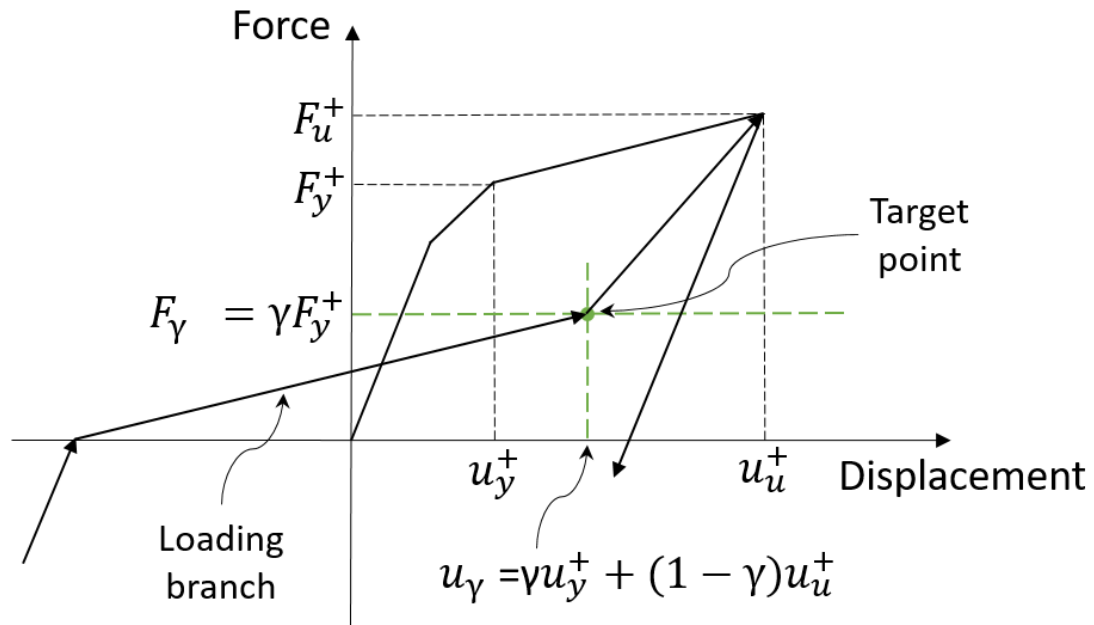

Modeling of hysteresis loop pinching

When the slip parameter is close to zero, the stiffness is nearly zero. Consequently, the area of the hysteretic loop and the amount of dissipated energy are significantly reduced. When the slip parameter is equal to 1, no pinching is observed.

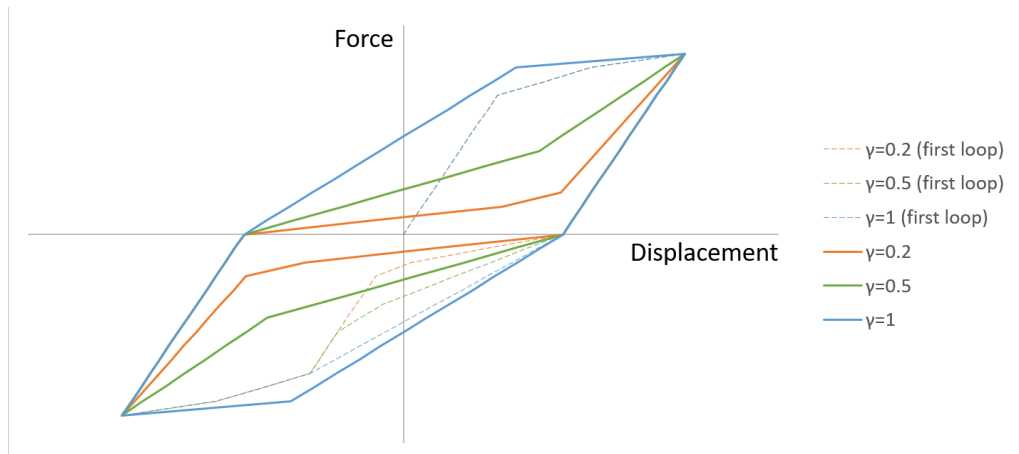

The influence of the slip parameter on the pinching of hysteresis loops

Generally, an inelastic spring with a bilinear backbone curve and without degradation is the most commonly used inelastic spring type. To create more complicated models with trilinear backbones and/or degradation, it is beneficial to create a simple one-spring model, apply a dynamic cyclic load, and graph the spring's force-displacement relationship to determine the effects of the parameters. A sample problem [see “TH18: Hysteretic Spring Time History Analysis” in *LARSA 4D Sample and Verification Problems*] demonstrates an example of such a model.

For more information, refer to: M.V. Sivaselvan and A.M. Reinhorn. (1999). "Hysteretic Models for Cyclic Behavior of Deteriorating Inelastic Structures." Technical Report MCEER-99-0018, University at Buffalo, State University of New York.

6x6 Stiffness Matrix Properties

6x6 stiffness matrix spring property definitions are applicable for linear grounded (one-node) springs only.

A stiffness matrix must be entered for 6x6 Stiffness Matrix spring property definitions using the **Edit Stiffness Matrix** command. Unlike the other spring property types, a curve is not entered.

Additional Commands

Some additional related commands are available. These commands are used to modify input data or to access additional attributes of the data referenced above. The commands can generally be accessed in one of several ways.

In the Springs spreadsheet, the commands are available in the Springs menu, or by right-clicking the spreadsheet. Some commands can be applied to more than one row in the spreadsheet at once by selecting multiple rows before activating the command.

The additional commands are as follows:

Edit Curve

This command opens a new spreadsheet window where the spring curve can be modified and view as a graph. The curve is entered as a list of points on the curve. The analysis engine will linearly interpolate the curve to find intermediate values. Special restrictions on the number and positions of the points may apply depending on the curve type (see above).

Edit Stiffness Matrix

When the spring property type is 6x6 Stiffness Matrix, this command opens a new spreadsheet window where the 6x6 stiffness matrix can be entered. The matrix must be symmetric, so only the upper half of the matrix is editable.

Edit Damping Matrix

When the spring property type is 6x6 Damping Matrix, this command opens a new spreadsheet window where the 6x6 damping matrix can be entered. The matrix must be symmetric, so only the upper half of the matrix is editable.

For More Information, please refer to the following documentation.

- Springs on page 83.
- For help on using spreadsheets, see Using the Model Spreadsheets in *LARSA 4D User's Manual*.

Isolator Property Definitions

Isolator property definitions set the behavior for one or more isolator elements used in the model. These property definitions are assigned to isolator elements (page 89) to give the elements their behavioral properties.

An isolator element has the behavior of a dashpot, such as a viscous damping device. These devices are widely used as structural protective systems for extreme loading (wind and earthquake) cases. Due to their combined benefits in terms of overall displacement reduction and energy dissipation, dampers are considered to be one of the most effective structural protective systems.

The dashpot element in LARSA is suitable for modeling the behavior of fluid viscous dampers or other devices displaying viscous behavior. This element can only be used in the time history analysis (and only in the nonlinear time history analysis before LARSA 4D version 8.0) because the response of the element is velocity-dependent.

The dashpot is controlled by a damping coefficient C and a velocity power n . The force in the dashpot, F , is a function of the velocity across the element (v , the difference in velocity at the end joints), where $F = Cv^n$.

Fluid dampers which operate on the principle of fluid orificing, produce an output force which is proportional to the power of the velocity. That power n can take values in the range of 0.5 to 2.0. This element has linear behavior when $n=1$ (but note that the element cannot be used in a linear time history analysis before LARSA 4D version 8.0).

It should be noted that when the velocity exponent n is not 1.0, then the damping coefficient and velocity power must be chosen with respect to a particular choice of units. Care should be taken for units of C and v when using nonlinear damping properties.

The following fields are required for dashpot elements:

Name

The name is used to refer to the property definition throughout the project.

Class

Currently only Dashpot is supported.

Damping Coefficient

The damping coefficient, C , used in time history analysis. The coefficient is in units of force-per-velocity. If the isolator property definition is used on an isolator element whose direction is rotational, the unit is given in units of moment per units of velocity.

Velocity Power

The power that the velocity is raised to, typically in the range of 0.5 to 1.2. If the value is 1.0, then the element has linear behavior (see above).

For More Information, please refer to the following documentation.

- Isolators on page 89.
- For help on using spreadsheets, see Using the Model Spreadsheets in *LARSA 4D User's Manual*.

User Coordinate Systems

User coordinate systems (UCSs) are used to describe the geometry of the structure in alternative coordinate systems and also to specify the directions of joint degrees of freedom, loads and displacements applied at joints, and the orientation of springs and isolators. There are four types of UCSs: rectangular, cylindrical, spherical, and bridge path.

In most structures, the coordinates of the joints are specified in the Global Coordinate System and joint degrees of freedom, loads and displacements applied at joints, and the orientation of springs and isolators follow the global axes. However, when a user coordinate system is assigned to the Displacement Coordinate System property of a joint (see Joints (page 59)), then the directions of the joint's degrees of freedom, and loads and displacements applied at that joint, are with respect to the user coordinate system. In addition, the orientation of springs (page 83) and isolators (page 89) connected to that joint may be affected.

The use of the additional user coordinate systems is merely a user convenience. The structures with curve beams, tunnels, domes, or structures with inclined supports can be modeled much easier using multiple displacement coordinate systems. For example, it is more convenient to specify radial and tangential loads or supports on curved structures by using a cylindrical rather than rectangular coordinate system.

Coordinate systems can be edited using the Properties spreadsheets or with the Model Data Explorer [see “User Coordinate Systems” in *LARSA 4D User's Manual*].

The Global Coordinate System

The structure model has always one Global Coordinate System. The Global Coordinate system is a rectangular coordinate system with the axes X, Y and Z. The axes are perpendicular and right-handed. The origin and directions are chosen arbitrarily by the user, however the direction of the Z-axis is used in interpreting the orientation angle of members.

Defining Coordinate Systems

A user coordinate system definition consists of the following:

Type

The coordinate system type can be rectangular, cylindrical, spherical, or bridge path. The type of a user coordinate system affects how coordinates are entered and displayed, but not the location or orientation of the user coordinate system.

Origin (X/Y/Z)

This is the origin of the user coordinate system, in global coordinates.

For rectangular UCSs, the origin is the (0, 0, 0) point in local coordinates; for cylindrical UCSs, this is the center of the cylinder at $z = 0$; for spherical UCS, this is the center of the sphere; and for bridge paths, this is the location of the first point on the path.

In the spreadsheets, the following two fields are used to define UCSs:

Axis Point (X/Y/Z)

The vector from the origin to this point defines the positive x-axis of the user coordinate system. The axis point is specified in global coordinates.

Point on XY Plane (X/Y/Z)

This is a point on the positive-y side of the x-y plane of the user coordinate system, given in global coordinates. It may, of course, be a point on the UCS's +y-axis itself, but it need not be because the y-axis can be determined with any point on the +y side of the x-y plane.

The x-axis of the UCS is the vector from the Origin to the Axis Point.

The z-axis of the UCS is determined by taking the normal to the plane defined by the Origin, Axis Point, and Point on XY Plane.

The y-axis of the UCS is determined by taking the cross product of the z-axis and the x-axis.

The right-hand-rule applies.

Cylindrical Coordinate Systems

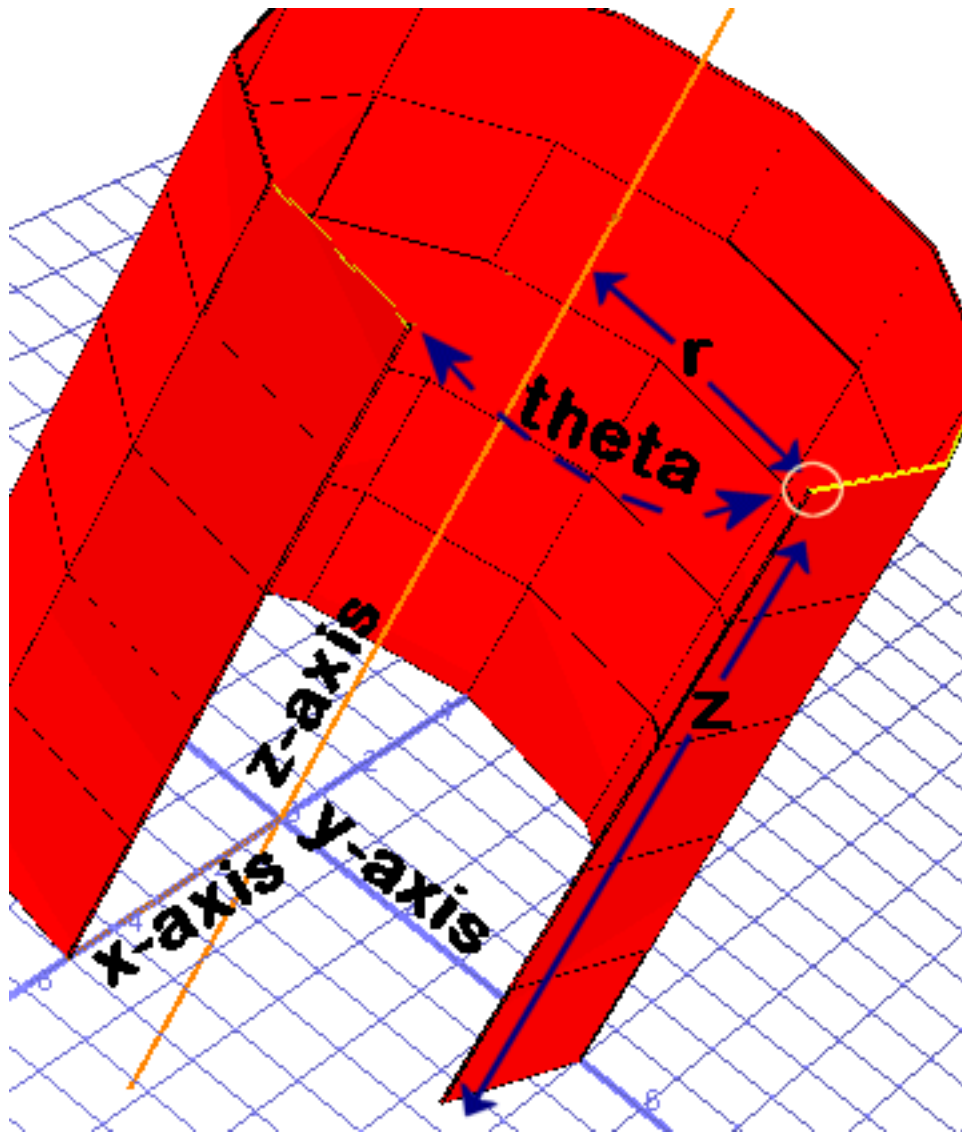

Cylindrical Coordinate System

Cylindrical coordinate systems are three-dimensional extensions to polar coordinates. The concentric circles of polar coordinates are on the x-y plane of the UCS and are extruded through the UCS's z-axis. A cylindrical coordinate has the components r , θ , and z . The z -coordinate is the same as when the coordinate is expressed in rectangular form. R and θ are computed as in polar coordinates as if all points are on the x-y plane.

R is the perpendicular distance from a point to the z-axis of the user coordinate system.

θ is the projected angle from the x-axis to a point, generally expressed in degrees.

Z is the perpendicular distance from a point to the x-y plane.

Cylindrical coordinate systems are often used to restrain joints in radial or tangential directions, or to apply joint loads in those directions. To apply radial loads, for instance, create a cylindrical UCS and set its origin to the center of

the circle about which the loads radiate. For each joint on which a radial load will be applied, set its displacement coordinate system to the cylindrical UCS. Loads applied to these joints will act in the local directions of the UCS, which means the loads x, y, and z components correspond to r, theta, and z. Applying loads with x-components set to 5 will result in loads of magnitude 5 directed radially away from the origin of the UCS. Using the y-component instead would produce tangential loads.

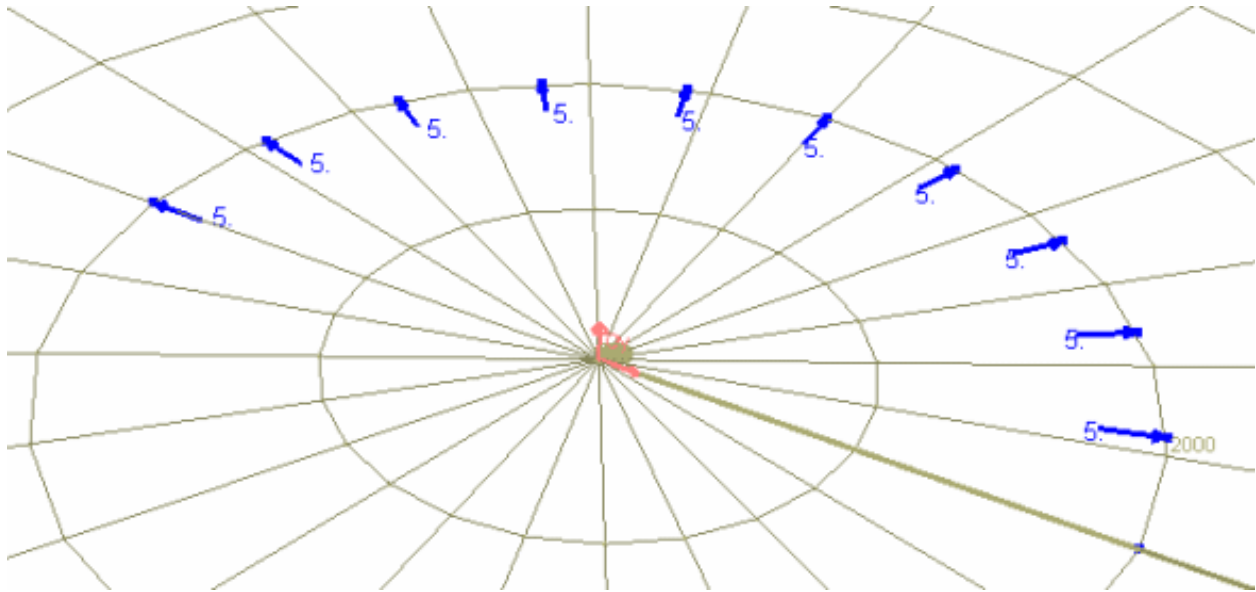

Using a Cylindrical Coordinate System to Apply Radial Loads

Spherical Coordinate Systems

Spherical coordinate systems have coordinates in r, phi, theta form. R and theta are the same as in cylindrical coordinate systems, the perpendicular distance to the z-axis and angle from the x-axis, respectively.

Phi is the angle between the z-axis vector and the vector from the origin to a point. It is usually expressed in degrees.

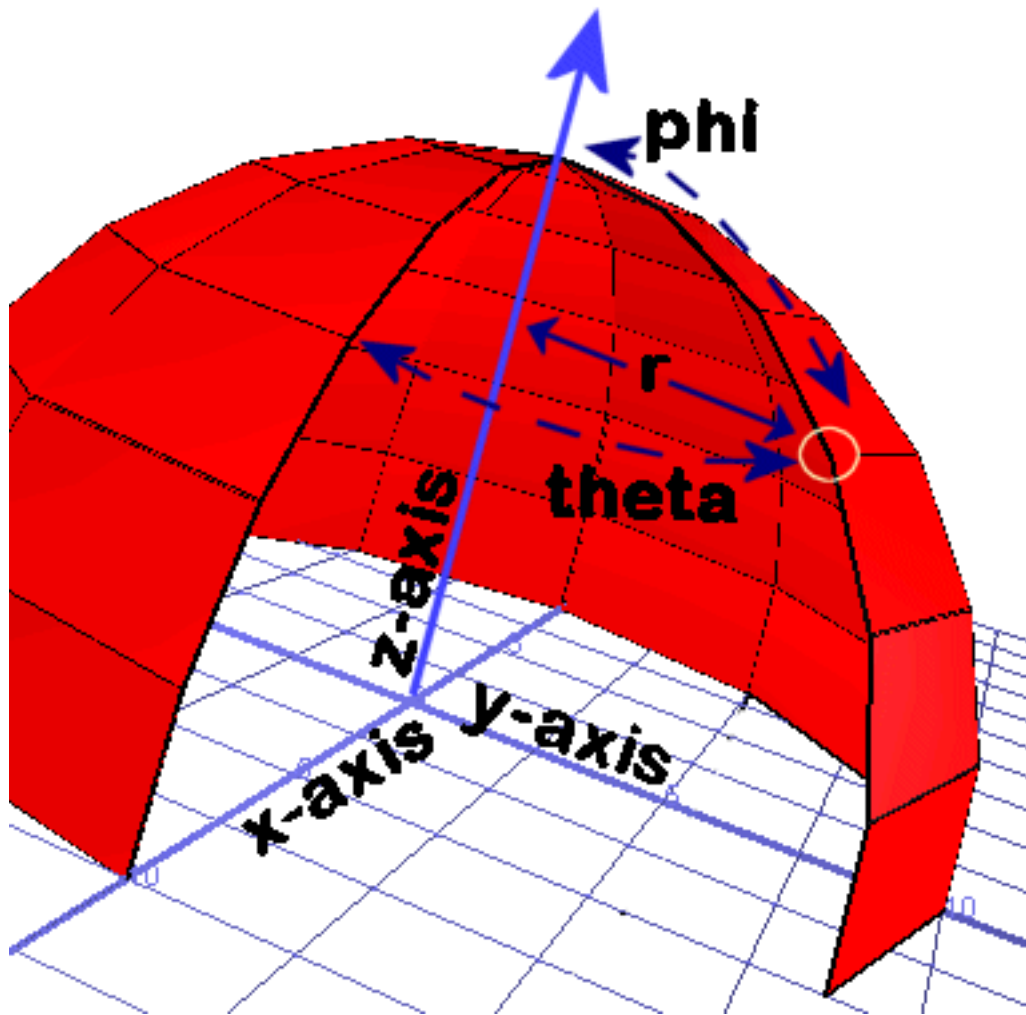

Spherical Coordinate System

Bridge Paths

Bridge path coordinate systems are special "traveling" coordinate systems whose axes are station, transverse offset, and elevation. The station axis follows the curved path of the bridge. It is the arc-distance along the center of the path, like the distance traveled by a car going down the center of a bridge. The station axis is shown as a thick line in the image below.

The transverse offset axis is perpendicular to the heading of the bridge at any station. That is, it is always the perpendicular distance from a point to the center line of the bridge, in the plane of the bridge. The transverse lines in the image are lines of the transverse offset axis.

The elevation axis is perpendicular to the station and offset axes, according to the right-hand rule. This axis is shown as the single arrow going up.

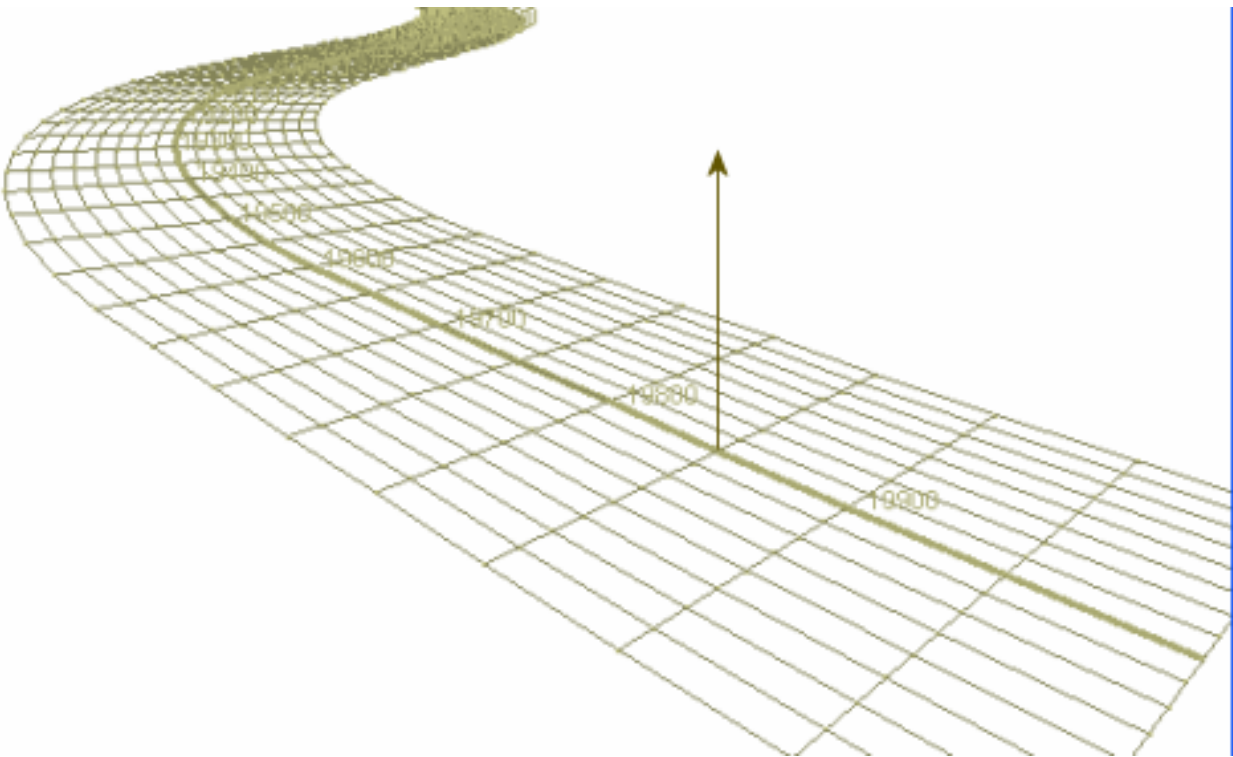

Bridge Path Coordinate Systems

Bridge paths are defined in two planes. Geometry control points at stations along the bridge with their directional headings and curve fitting options define the path in the plan or horizontal view. The elevation or vertical path is defined by a series of elevation control points at stations along the path, with the elevation and grade at each point. The vertical path is parabolically curve-fit.

For more information, see [Bridge Paths](#) (page 47).

Additional Commands

Some additional related commands are available. These commands are used to modify input data or to access additional attributes of the data referenced above. The commands can generally be accessed in one of several ways.

In the UCSs spreadsheet, the commands are available in the UCSs menu, or by right-clicking the spreadsheet. Some commands can be applied to more than one row in the spreadsheet at once by selecting multiple rows before activating the command.

In the Model Data Explorer, change to the display for UCSs. Then right-click an object to get this list of commands. You can also apply the command to multiple at once by clicking on the first object, then holding the SHIFT key and clicking on the last object, and last right-clicking any of the to get the list of commands.

In the graphics window, activate the Pointer mouse tool from the toolbar, and then right-click an object in the graphical display to get the list of commands to apply to that object.

The additional commands are as follows:

Edit UCS...

This command opens the UCS editing window. See User Coordinate Systems [in *LARSA 4D User's Manual*].

Make This the Current UCS

This command sets the UCS to be the active coordinate system. See User Coordinate Systems [in *LARSA 4D User's Manual*].

Make Global System the Current UCS

This command sets the global coordinate system to be the active coordinate system. See User Coordinate Systems [in *LARSA 4D User's Manual*].

Move UCS To Joint

This command lets the user change the origin of a UCS by clicking on a joint in the graphics window. A window titled *Move UCS to Joint* appears. Click a joint to choose a new origin. Otherwise, click *Done* to cancel choosing a new origin.

Translate UCS in X/Y/Z

After activating this command, the user is prompted for the distance to move the UCS in either the x, y, or z directions in global coordinates.

Rotate UCS in X/Y/Z

After activating this command, the user is prompted for an angle in degrees to rotate the UCS axes about either the x, y, or z global axes.

For More Information, please refer to the following documentation.

- For help on using spreadsheets, see Using the Model Spreadsheets in *LARSA 4D User's Manual*.

Bridge Paths

Bridge path coordinate systems are special coordinate systems whose axes are station, transverse offset, and elevation.

Like the cylindrical user coordinate system (page 39), the bridge path user coordinate system is a tool of convenience for modeling. Bridge paths are particularly useful in the setup of model geometry because they allow the user to work in very simple coordinates despite any curvature of the structure. This is accomplished by warping the usual x-axis into a curve that follows the curvature of the bridge. In bridge path UCSs, this is called the station axis, and it is the thick line down the center of the bridge in the image below.

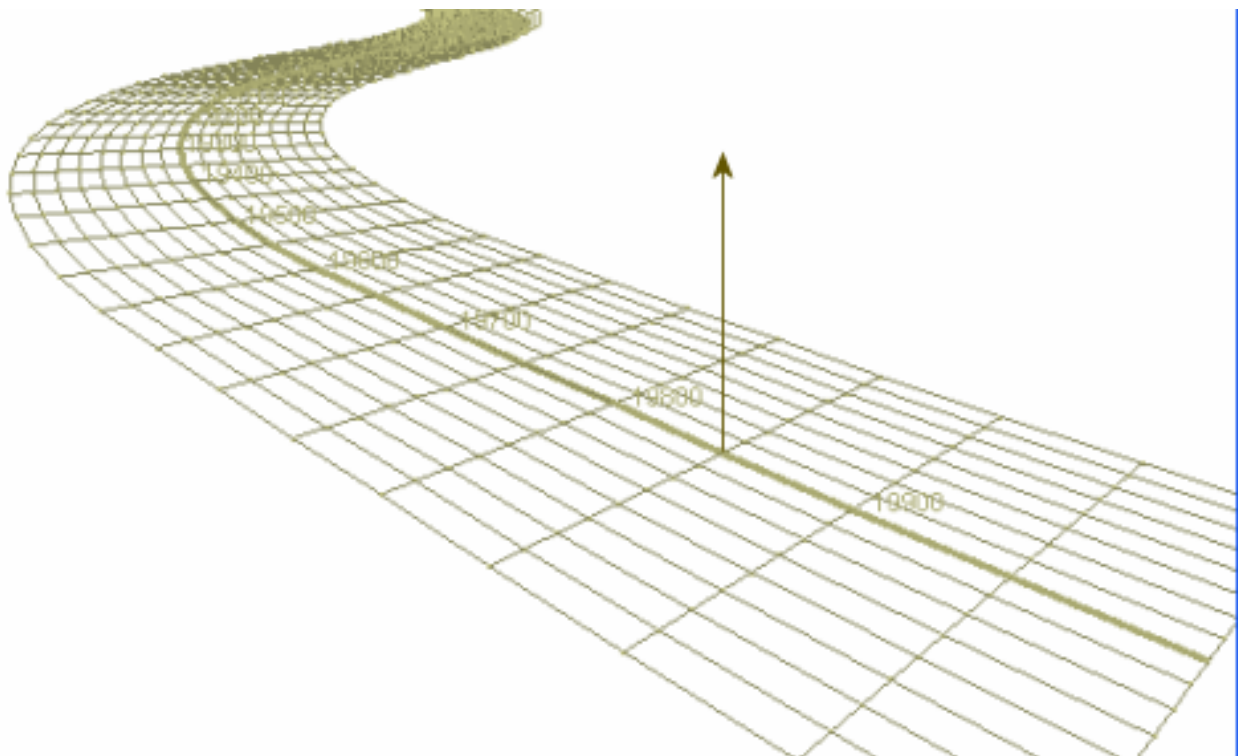

Bridge Path Coordinate Systems

The curvature of the station axis is given by defining the path in two planes. Geometry control points at stations along the bridge with their directional headings and curve fitting options define the path in the plan or horizontal view. The elevation or vertical path is defined by a series of elevation control points at stations along the path, with the elevation and grade at each point.

Bridge path coordinate systems can also be set as the displacement coordinate system of joints in order to change the direction of supports, springs, and loads to be parallel or perpendicular to the heading of the bridge at the location of the joint. This saves the effort of creating a separate rectangular user coordinate system at each pier, for instance, to set the directions of the supports at the piers.

Coordinate systems can be edited using the User Coordinate Systems (page 39) Properties spreadsheets or with the Model Data Explorer [see “User Coordinate Systems” in *LARSA 4D User’s Manual*].

Bridge Axes

Like the usual x-axis, the station axis is measured in length units. But the station axis is according to arc length. That is, station axis coordinates are distances that a vehicle would travel as it follows the centerline of the bridge. The benefit of this system is that any coordinate $(x, 0, 0)$ is on the centerline of the bridge. Without a bridge path, trigonometric functions would be needed to locate points on the centerline.

The second axis of bridge paths is the transverse offset axis, which is perpendicular to the station axis at any station, in the horizontal plane. For example, at station 1000 on the curved bridge, two parallel girders 10 units apart are passing through. The bridge path coordinates of the girders at this station are $(1000, -5, 0)$ and $(1000, 5, 0)$, regardless of the curvature at this point.

The elevation axis is always straight up, with the station axis at zero elevation. This is useful for setting coordinates relative to a bridge deck. Sometimes it is also useful to set coordinates relative to a ground line, especially when the bridge deck's elevation is not constant. In that case it may be helpful to create two bridge path user coordinate systems, both with the same horizontal geometry, but one with elevations set to the elevation of the deck, and the other with elevations set flat to the ground line.

Horizontal Geometry

Station and Heading

Horizontal geometry is set through geometry control points and curve fitting options. Geometry control points set the directional heading at stations along the bridge, usually before and after curved segments. For instance, if a bridge goes through an arc from station 2500, where the bridge is headed toward the east, to station 3000, where the bridge is headed at N 30° E, two geometry control points are set:

Station	Heading
2500	0
3000	N 30 E

Headings can be entered as counter-clockwise degree measures from east, in either decimal format or DMS format. For DMS format, you may omit the symbols, e.g. enter "30 15 5" for 30° 15' 5". You may also enter surveyor notation, such as N 30 15 5 E, for 30.251 degrees from north going toward east.

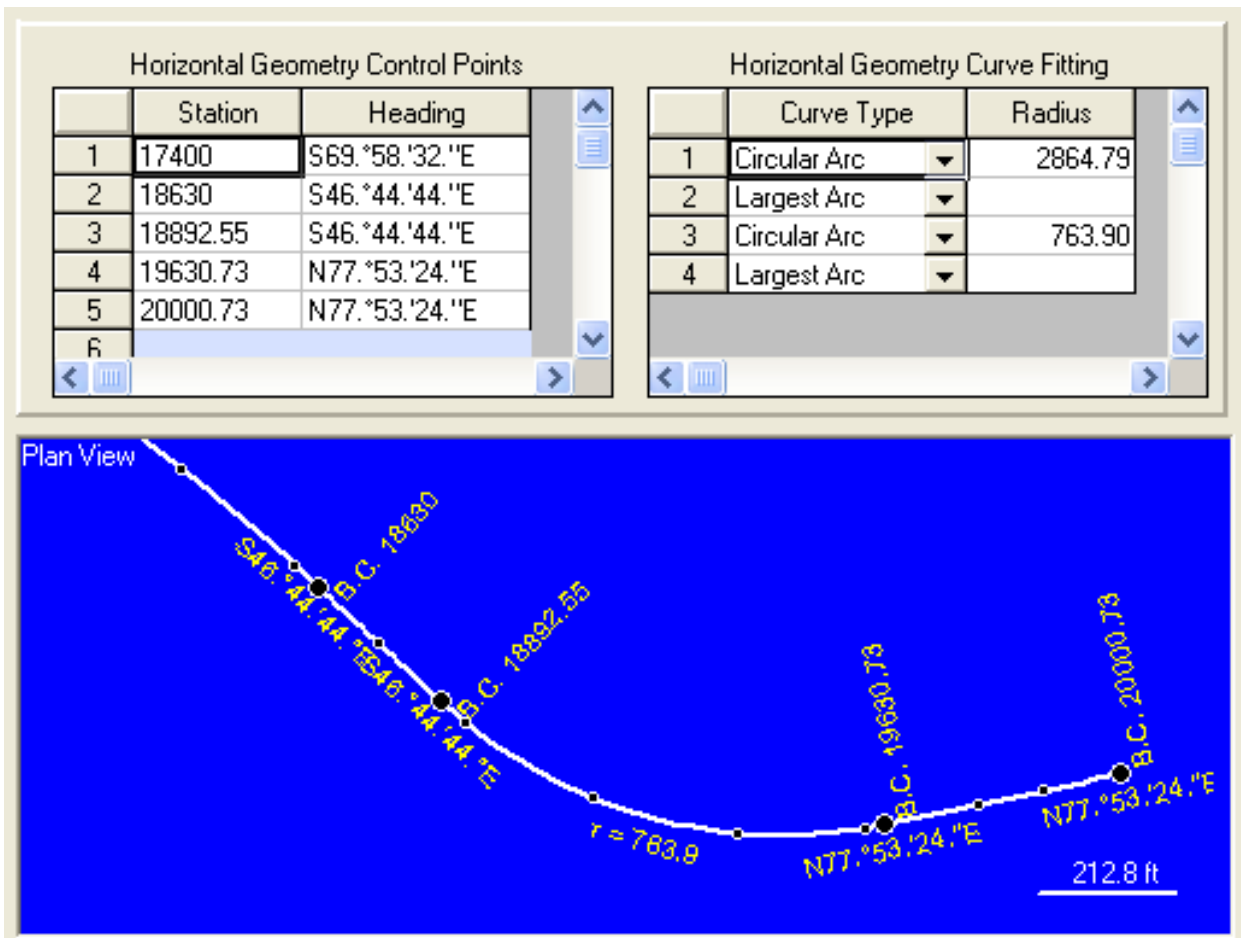

Horizontal Curve Definition

Curve Types

The segments between each geometry control point are connected by a curve. The options for curve fitting are entered into the spreadsheet on the righthand side of the Horizontal Curve tab. The curve specified in row 1 of that spreadsheet corresponds to the segment between the points in rows 1 and 2 in the lefthand spreadsheet, and so on.

Three types of curve fitting are available: straight line, circle, and spiral.

Straight lines are automatically fit between two points that have the same heading.

For circular curve fitting, choose the Largest Arc option. This will choose the radius of curvature automatically based on the formula $R=S/T$, where S is the arc-length of the segment and T is the change in heading from the start point to the end point in radians.

Choose Circular Arc to specify a particular radius. If the radius is smaller than the largest radius that can fit between the points, the circular segment will be placed symmetrically between two straight line segments on either end of the segment.

Spirals

Euler spirals (also known as clothoids or Talbot transition spirals) can also be fit between control points. The spiral is a smooth transition between a circular curve and a straight line. Four spiral options are available. “Spiral Off” is used for spirals from straight lines to circular segments. “Spiral On” is used for spirals from circular segments to straight lines. The mnemonic is getting “on” the highway (i.e. from circular on-ramp to straight highway) or getting “off” the highway (from straight highway to circular off-ramp). “Right” spirals go clockwise, while “left” spirals go counter-clockwise.

For example, the Spiral Off Right option creates a clockwise spiral between a straight line and a circle.

The radius of curvature at the circular end is computed automatically from the formula $R=S/2T$, where S is the arc-length of the spiral and T is the change in heading from the start point to the end point in radians.

Vertical Geometry

The vertical geometry of the station axis is determined by a series of elevation control points. Each point specifies a station, the elevation at that station, and the grade of the deck at that station. The elevation is relative to coordinate set as the origin of the user coordinate system (page 39), in the direction of the z-axis of the UCS. If the UCS origin and directions are left as the default, elevations are measured from the global xy-plane.

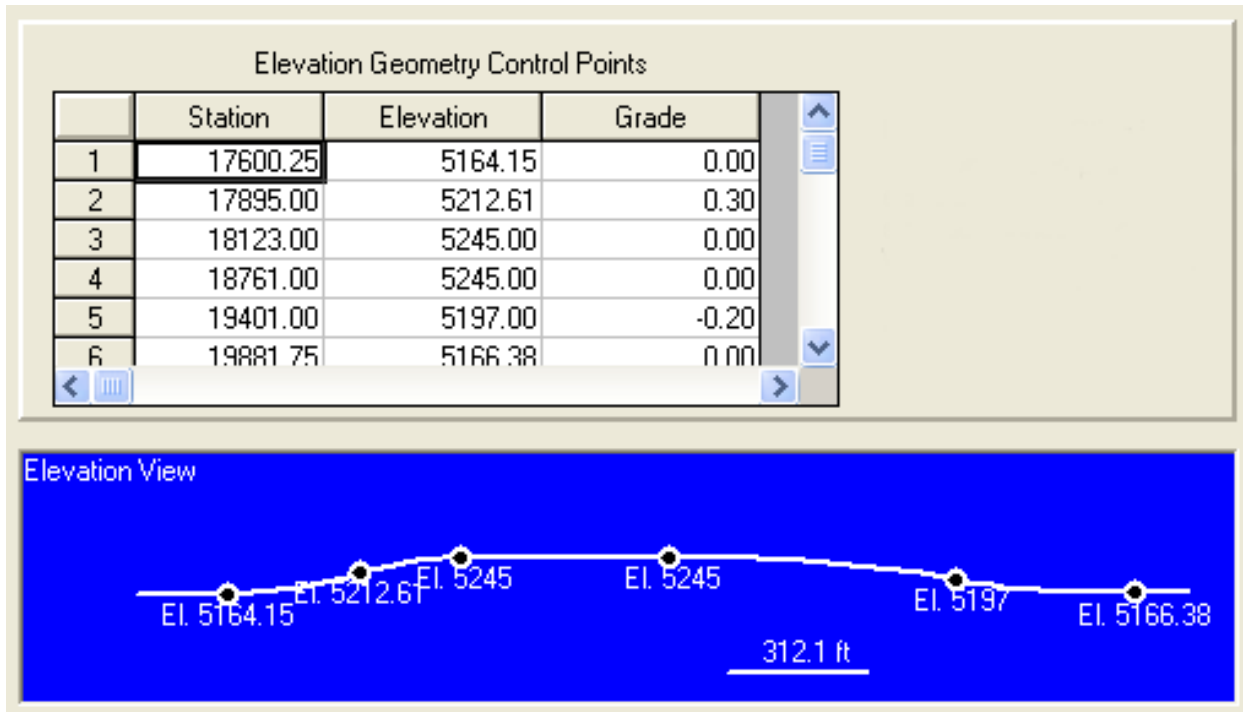

Vertical Curve Definition

The grade and elevation are used to fit curves between the elevation control points. Where possible, parabolic curve fitting is used. Parabolic curve fitting is only applicable when a point of intersection exists for adjacent elevation control points. PI points won't exist between elevation control points with the same grade but different elevations, for instance. In these cases, cubic curve fitting is applied.

Elevation - Parabolic Curve Fitting

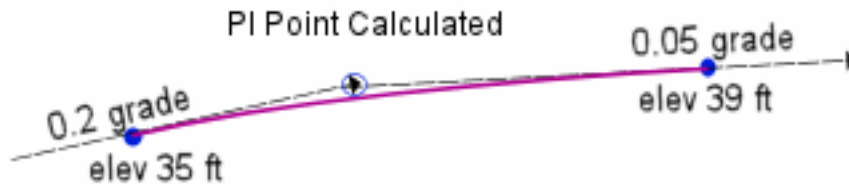

Elevation - Cubic Curve Fitting

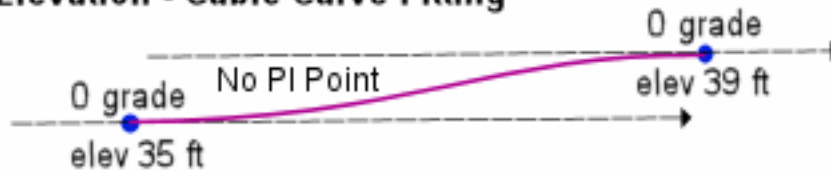

Elevation Curve Fitting

Superstructure Rotation

Rotation of the superstructure can be set using the "Bank Rotation" spreadsheet. Rotations are specified at control points (stations) along the bridge path, and are given in degrees. The degree angle specifies a rotation about the bridge's station axis using the right-hand-rule (clockwise rotation).

Rotation values are linearly interpolated between the control points.

The effect of a rotation is to skew the local cross-sectional coordinate system at that point on the bridge path. The transverse offset axis is rotated according to the bank rotation angle, but the elevation axis remains vertical. This is shown in the image below, which displays the transverse offset and elevation axes at a particular cross-section on a bridge path.

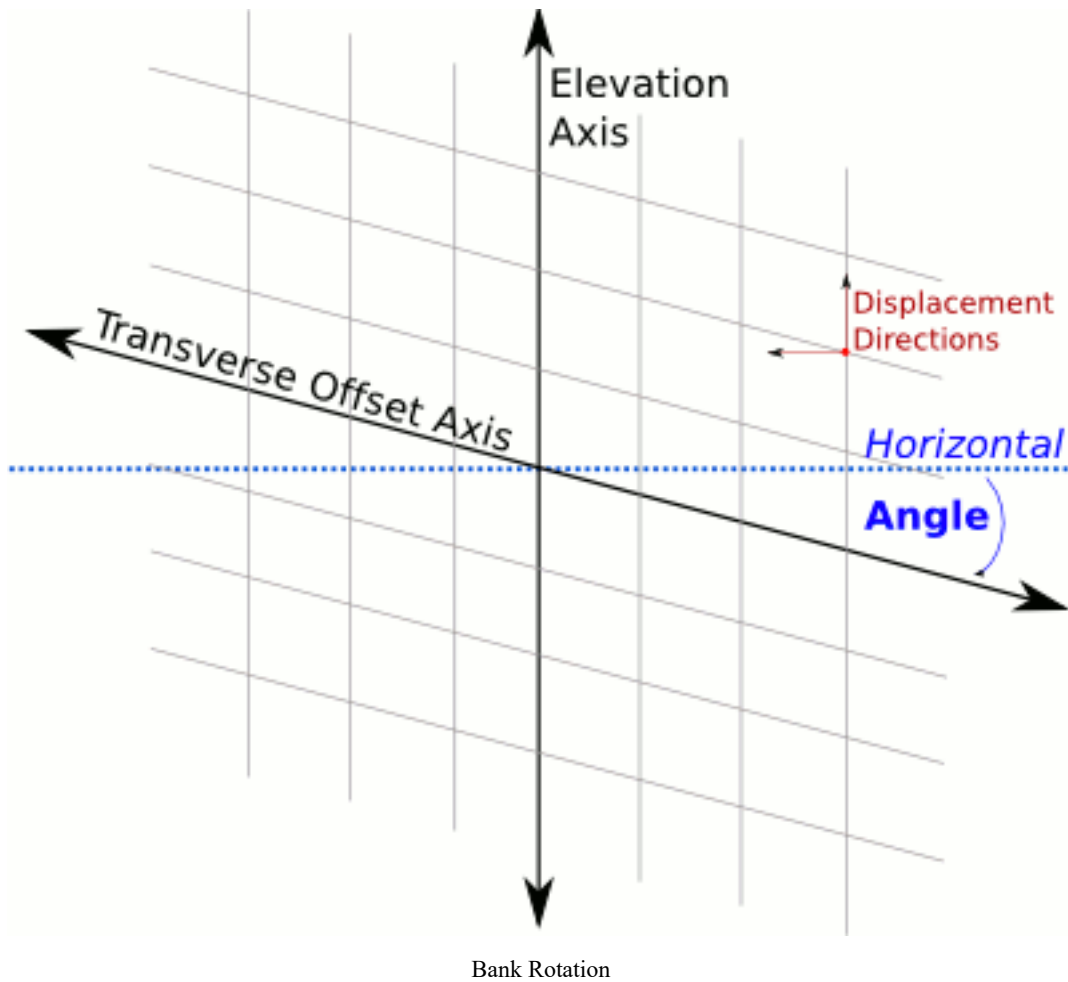

Although the coordinate system is skewed for the purposes of model geometry, a non-skewed (orthogonal) coordinate system must be used when a bridge path is used as a joint displacement coordinate system or as the reference system for compound element forces results. In these cases, the local directions ignore any bank rotation. This is shown as the "displacement directions" axes in the image.

Time-Dependent Material Property Definitions

Time-dependent material property definitions are used only in the time-dependent staged construction analysis. These definitions define both concrete creep and shrinkage as well as steel relaxation behavior.

The use of time-dependent material property definitions depends on what type of material properties they represent.

For Concrete Creep and Shrinkage

Time-dependent material property definitions are assigned to materials (page 19) or to sections (page 23) when they are used to calculate creep and shrinkage for members (page 61).

For Steel Relaxation

Time-dependent material property definitions are assigned to materials (page 19) when they are used to calculate relaxation for tendons (page 95).

Creep and Shrinkage Properties for CEBFIP-78

When the CEBFIP-78 code is chosen for a time-dependent staged construction analysis, the following coefficients must be specified to determine creep and shrinkage behavior. The CEBFIP-78 code is used when the user wants to define custom creep and shrinkage models for each section instead of the built-in material models used with CEBFIP-90. When the CEBFIP-90 code is selected, these coefficients are not necessary, but the CEBFIP-90 models may not be applicable in extreme environmental conditions.

Creep and shrinkage are affected by time-dependent factors, such as stress, relative humidity, and ambient temperature, thus a knowledge of environmental history is required for accurate predictions of deformation. The creep coefficient also depends on:

- Dimensions of Element
- Composition of the Concrete
- Rate of Hardening of Concrete

The creep coefficient for CEBFIP-78 is defined as:

$$j(t, t_0) = b_a(t_0) + j_d b_d(t-t_0) + (j_{f1} j_{f2}) [b_f(t) - b_f(t_0)]$$

$$b_a(t_0) = 0.8(1 - f_c(t_0)/f_{c\%})$$

For more on CEBFIP-90, please refer to CEB-FIP Model Code 90 Section 2.1.6.

See Time Effects on Materials (page 261) for more information on choosing the material model for an analysis and other time-dependent material options.

Notional Thickness Coefficient

This field is not used.

Flow Coefficients

Flow Coefficient 1

j_{f1} . This coefficient is 0.80 for water, 1.00 for very damp atmosphere, 2.00 for outside in general, and 3.00 for a very dry environment

Flow Coefficient 2

j_{f2} . Depends on the notional thickness.

The flow coefficients are used in computing the irreversible delayed deformation (flow) which is very much affected by the age at which loading commences. Their definitions are in accordance with CEBFIP-78.

LARSA uses the product of these coefficients, j_{f1} and j_{f2} .

Note: $j_{f1} = 2$ and $j_{f2} = 1.4$ will represent an average concrete setting and aging in average conditions with a notional thickness of 0.40m.

Delayed Modulus of Elasticity

j_d . Used in computing the recoverable part of the delayed deformation (delayed elasticity). It is assumed to be independent of aging in its development and it is defined by a constant value.

Shrinkage Coefficients

Shrinkage Coefficient 1

e_{s1} . Depends on the environment. This coefficient is +0.00010 for water, -0.00013 for very damp atmosphere, -0.00032 for outside in general, -0.00052 for very dry atmosphere.

Shrinkage Coefficient 2

e_{s2} . Depends on the notional thickness. This coefficient is usually available in the form of a curve with horizontal axis as the notional thickness (mm) and vertical axis as the value of for the shrinkage coefficient 2.

The shrinkage coefficient definitions are in accordance with CEBFIP-78.

The strain due to shrinkage which develops in an interval of time (t-t0) is given by

$$e_0 = e_{s1} \cdot e_{s2} \text{ (This is the basic shrinkage coefficient.)}$$

$$e_s(t, t_0) = e_0[b_s(t) - b_s(t_0)]$$

The basic shrinkage coefficient corresponds to *EPS* in the BC software program.

b_s is a user-supplied function corresponding to the change of shrinkage with time depending on the notional thickness of the section.

The recoverable creep function b_d , flow function b_f and shrinkage function b_s are entered as functions of time (days). The value is computed from the given curve by interpolation. These functions are used in accordance with CEBFIP-78.

Creep and Shrinkage Properties for CEBFIP-90

No values need to be entered when using CEBFIP-90 for creep and shrinkage.

Other Properties

The following other properties can be specified:

Creep Factor

A factor to apply to the effect of creep for elements to which this time-dependent material property definition is relevant.

Shrinkage Factor

A factor to apply to the effect of shrinkages for elements to which this time-dependent material property definition is relevant.

Relaxation Factor

A factor to apply to the effect of relaxation for tendons to which this time-dependent material property definition is relevant.

Material Curves

See Time Effects on Materials (page 261) for more information on which of these curves are needed under different conditions, choosing the material model for an analysis, and other time-dependent material options.

Concrete Shrinkage Curve (S)

Time (in days) versus Strain, the change in shrinkage at this time. A function corresponding to the change of shrinkage with time, depending on the notional thickness (h_0). This curve is only used with CEBFIP-78. This corresponds to the b_S function.

Concrete Delayed Plastic Strain Curve (F)

Time (in days) versus Plastic Strain. A function corresponding to the development of delayed plastic strain over time, depending on the notional thickness (h_0). This curve is only used with CEBFIP-78. This corresponds to the b_F function.

Concrete Delayed Elastic Strain Curve (D)

Time (in days) versus Elastic Strain. A function corresponding to the development of delayed elastic strain over time, depending on the notional thickness (h_0). This curve is only used with CEBFIP-78. This corresponds to the b_D function.

Time versus Elastic Modulus Curve

This curve is not currently used by LARSA. Instead, a built-in function is applied when called for by chosen code.

Stress/GUTS vs. Relaxation Curve (for Tendons)

Relaxation losses for different stress levels in the tendon. This curve is used for all creep and shrinkage codes. Stress/GUTS is the stress in the tendon divided by the guaranteed ultimate tensile strength. This value is usually less than 1.0. Higher stress values in the tendon cause higher relaxation losses. Relaxation is the total relaxation. For 6 percent relaxation, specify 0.06.

Time vs. Relaxation Curve (for Tendons)

Time (in hours) versus Relaxation (a proportion). A function corresponding to how relaxation varies over time. This curve is used for all creep and shrinkage codes. If a tendon experiences 100 percent loss of relaxation in 1,000 hours, then the value for $Time = 1,000$ should be 1.0.

Relaxation Coefficients

Relaxation is derived from the product of the coefficients from the *Stress/GUTS vs. Relaxation* and *Time vs. Relaxation* curves. The coefficients are the values of the curves with *time* being the number of days since the tendon was stressed.

Additional Commands

Some additional related commands are available. These commands are used to modify input data or to access additional attributes of the data referenced above. The commands can generally be accessed in one of several ways.

In the Time Material spreadsheet, the commands are available in the Time Material menu, or by right-clicking the spreadsheet. Some commands can be applied to more than one row in the spreadsheet at once by selecting multiple rows before activating the command.

The additional commands are as follows:

Edit Shrinkage Curve S

This command opens a new spreadsheet window where the S curve can be edited. The use of this curve depends on the code being used.

Edit Delayed Plastic Strain Curve F

This command opens a new spreadsheet window where the F curve can be edited. The use of this curve depends on the code being used.

Edit Delayed Elastic Strain Curve D

This command opens a new spreadsheet window where the D curve can be edited. The use of this curve depends on the code being used.

Edit Curve: Time VS Modulus of Elasticity

This command opens a new spreadsheet window where the time versus modulus of elasticity curve can be edited. The use of this curve depends on the code being used.

Edit Curve: Stress/GUTS VS Relaxation

This command opens a new spreadsheet window where the stress/GUTS versus relaxation curve can be edited. The use of this curve depends on the code being used.

Edit Curve: Time VS Relaxation

This command opens a new spreadsheet window where the time versus relaxation curve can be edited. The use of this curve depends on the code being used.

For More Information, please refer to the following documentation.

- For help on using spreadsheets, see Using the Model Spreadsheets in *LARSA 4D User's Manual*.

Geometry

In a finite element analysis, model geometry is defined by the locations of joints, support conditions at joints, constraints between joint degrees of freedom, and a set of elements interconnected at those joints. In addition to general FEM geometry elements, model geometry includes lanes, tendons, and other miscellaneous objects.

Joints	59
General Properties	59
Translational and Rotational Restraints	59
Displacement User Coordinate System	60
Members	61
Member Properties	61
Connection Beam Properties	65
Properties for Time-Dependent Material Effects	65
Member Coordinate Systems (Local Axes)	66
Self-Weight Computation	71
Spans	73
Plates	75
Usage Notes	75
Element Formulation	75
Attributes of Plates	78
Element Coordinate Systems	79
Self-Weight Computation	81
Springs	83
Usage Notes	83
Grounded Spring Element	83
Two-Node Spring Element	83
Hysteretic (Nonlinear Inelastic) Spring Element	84
General Attributes	85
Stiffness Attributes	86
Isolators	89
Mass Elements	91
DOF Constraints	93
Tendons	95
About the Tendon	95
Friction Losses	95

Anchorage Slip Losses	96
Elastic Shortening of Concrete Losses	96
Other Losses	97
Attributes	97
Path Geometry	98
Example Path	102
Lanes	105
Basic Properties	105
Path Geometry	106
Lane Path Example	108

Joints

Joints, also known as nodes, are the connection points for stiffness-carrying elements. They are the primary locations where displacements are computed. Joints define the physical geometry of the structure and are the sites of support conditions.

Degrees of freedom are the components of displacement at a joint. Joints can have up to six degrees of freedom, corresponding to translation along the three axes and rotation about the three axes. The number of unrestrained joint degrees of freedom in a model determines the number of equations to be solved in an analysis.

General Properties

ID

Numbers are assigned to joints for identification purposes. They can be any integer, and they must be uniquely assigned among all joints in a project, but they need not be assigned consecutively.

Coordinates

Joint locations are generally specified using x-, y-, and z-coordinates in the global coordinate system. When a user coordinate system (page 39) is the active coordinate system, then the coordinates are specified with respect to that coordinate system. (See User Coordinate Systems [in *LARSA 4D User's Manual*].)

Translational and Rotational Restraints

Each degree of freedom at the joint can be either free or fixed. A free degree of freedom indicates the joint is free to move, while a fixed degree of freedom indicates that the joint is not free to move because of the presence of a support.

Without any restraint, the structure will float in space. A free floating structure will have six rigid body degrees of freedom. The structure must be restrained against its rigid body motions. In general, the rule is that degrees of freedom without stiffness need to be restrained to prevent rigid body motions as well as ill-conditioning of the system stiffness matrix.

For example, 2D structures such as a 2D frame in the xz-plane must have y-translation and x- and z-rotations restrained for all joints. To eliminate the rigid body motion at least three additional degrees of freedom must be restrained in the xz-plane.

The restraint directions are always in the displacement coordinate system of the joint (see below). If the joint is assigned a cylindrical coordinate system as the displacement coordinate system, then X translation represents the radial and Y translation represents the tangential motion at the joint.

Universal Restraints [in *LARSA 4D User's Manual*] is used to fix a set of degrees of freedom for all joints. Any degrees of freedom restrained universally will apply to all joints, regardless of the DOF selected for a joint.

If the displacement of a joint along any one of its degrees of freedom is known ahead of time, then the degree of freedom is restrained. It should be set to fixed, and a joint displacement load (page 121) should be applied.

Joints can be constrained using DOF Constraints (page 93). Constrained degrees of freedom on dependent joints are removed from the system of equations to be solved.

To model other support conditions, such as soil-structure interaction, see Springs (page 83).

Displacement User Coordinate System

The directions of motion (displacements) of a joint are specified and computed in a coordinate system identified as the joint displacement coordinate system. The default system is the Global Coordinate System. Any user coordinate system (page 39) (including a Bridge Path Coordinate System) can be assigned to a joint as the displacement coordinate system.

Supports, spring elements, DOF constraints, joint loads, and support displacements all act in the directions specified by the joint displacement coordinate system.

Additional Commands

Some additional related commands are available. These commands are used to modify input data or to access additional attributes of the data referenced above. The commands can generally be accessed in one of several ways.

In the Joints spreadsheet, the commands are available in the Joints menu, or by right-clicking the spreadsheet. Some commands can be applied to more than one row in the spreadsheet at once by selecting multiple rows before activating the command.

In the graphics window, activate the Pointer mouse tool from the toolbar, and then right-click an object in the graphical display to get the list of commands to apply to that object only.

To apply the command to multiple joints at once, first select those joints and unselect everything else, then go to the Modify menu, find the Joints menu, and choose a command from within that menu. Activating these commands from the Modify menu will apply the action to all selected joints.

The additional commands are as follows:

Renumbering Setup

This command sets up renumbering options for joints. The user can choose the starting ID and the step.

Renumber

Renumbers the selected joints according to the renumbering setup options, which must be set first.

For More Information, please refer to the following documentation.

- For help on using spreadsheets, see *Using the Model Spreadsheets in LARSA 4D User's Manual*.
- User Coordinate Systems on page 39.

Members

Members are structural elements connecting two joints and are used to model beams, columns, cables, and trusses. The members can also be used to model yielding connections and plastic hinging within the element.

Member Properties

ID

Member numbers are assigned to beams for identification purposes. They can be any integer, and they must be uniquely assigned among all members in a project, but they need not be assigned consecutively.

Start (I) and End (J) Joints

A member's connectivity is described using two non-coincident joints. Members may not have zero length. The joints' IDs are used here.

Member Type

The member types that can be selected are Beam, Truss, Cable, Compression-Only Truss, Tension-Only Truss, and Hysteretic Beam. The types Inactive and Construction Line are available to have the analysis engine ignore the stiffness of the member in the analysis. There is no difference between Inactive and Construction Line, but the user may decide to make use of the distinction.

Cable, Compression-Only Truss, Tension-Only Truss, and Hysteretic Beam elements and a beam with member-end nonlinear springs are nonlinear elements when used in a nonlinear analysis. If cable or truss elements are used in a linear analysis, they are treated as simple truss elements. The hysteretic beam elements fall back to the standard beam element in a linear analysis.

Beam Element

The beam element has six degrees of freedom at each end joint: translational displacements in X, Y and Z directions and rotational displacements about X, Y and Z directions. This element includes axial and shear deformations, twisting about its x-axis, bending in two perpendicular planes, and associated shears. The beam element is capable of exactly representing constant axial deformation along the beam with constant torsional shear deformation and linear bending deformations within the element. This is sufficient for analyzing structures with loads applied at joint points. However, modeling these deformations requires a higher order representation due to axial loads, torsional loads, lateral loads, and moments along the elements. Use of the fixed end forces allows these higher-order deformations without the need of additional degrees of freedom for the beam elements.

This element has geometric nonlinearity and stress-stiffening or softening in all nonlinear analysis types. It also includes beam-column properties.

When member-end nonlinear springs are assigned, the beam becomes the Connection Beam Element (see below).

Truss Element

The truss element has only translational displacements in X, Y and Z directions at each end and it has no rotational stiffness. These elements can carry axial force only. The cross-sectional area determines the axial stiffness of the element, and it is the only stiffness required to be entered for sections assigned to truss element members. The values for I_x , I_y , I_z and shear areas are ignored for truss and cable elements.

This element has geometric nonlinearity and stress-stiffening or softening in all nonlinear analysis types.

Cable Element

The cable element is identical to the truss element except a cable element cannot resist compressive force. The cable element can only be used in a nonlinear analysis. If during the analysis, the axial force in a cable element becomes compressive, then the cable element is assumed to have no axial stiffness and cannot carry any load. It is kept in the model as an inactive element with no contributing stiffness. During the loading process of a nonlinear analysis, if the element can become tensile again, it is included in the model with contributing stiffness to the system.

This element has geometric nonlinearity and stress-stiffening in all nonlinear analysis types.

Compression- and Tension-Only Truss Elements

These elements are identical to the truss element except the compression-only element cannot resist tension forces and the tension-only element cannot resist compressive forces.

This element has geometric nonlinearity and stress-stiffening or softening in all nonlinear analysis types. This element cannot be used in any linear analysis.

Inelastic Hysteretic Beam Element

This advanced element is used in nonlinear analyses for plastic pushover and progressive collapse. The formulation of the element is based on spread plasticity to capture the variation of section flexibility and combine them to determine the element stiffness matrix. It has nonlinear material properties including hysteretic behavior and geometric nonlinearity for tension stiffening.

Instead of using the material stress-strain relations directly, the hysteretic beam element uses the section axial force-centroidal strain and moment-curvature relationships to reduce computation. Hence the term strain in the context of the hysteretic beam element refers to the vector consisting of centroidal axial strain, curvature about the element y-axis, and the curvature about the element z-axis.

The interaction between the axial force and the two bending moments at the sections located at the element Gauss points is taken into account using a yield surface and the rules of plasticity: (i) Normal Flow rule and (ii) Kinematic Hardening rule. Normal flow rule states that plastic strain increments are orthogonal to the yield surface. Shear deformations and material nonlinearity in torsion are ignored.

Conventional finite elements use the stiffness formulation where the nodal displacements are interpolated within the element using displacement interpolation functions. In contrast, the hysteretic beam element uses force interpolation functions, i.e., the element end forces are interpolated within the element. This is because, for beam-elements, while displacement interpolation functions are accurate only for prismatic members with linear material behavior, the force interpolation functions are always accurate.

This necessitates an element level state determination procedure to determine the element end forces and strains at the Gauss Points. The Newton-Raphson method is used within the element for this purpose. The number of equations for each hysteretic beam element depends on the number of Gauss points. This number is set to 10 and cannot be modified by the user.

For the consideration of geometric nonlinearity, the element deformation is split into two parts: (i) the rigid body rotation of the element coordinate system and (ii) the deformation of the element within this coordinate system. Only the former is included in geometric nonlinearity.

The ignoring of the deformations within the element coordinate system may lead to greater inaccuracies when the element is in single curvature and when there is significant deformation before yielding in double curvature. In such cases, to increase accuracy the element should be subdivided.

Member loads applied to hysteretic beam elements are non-consistent. These loads are transferred immediately to the I- and J-joints at the ends of the member. Mid-span point loads, for instance, will be treated instead as split between the end joints.

Connection Beam Element

The connection beam element consists of an elastic beam with built-in yielding springs at the ends. There can be up to four such end-springs, two springs at each end, one for each direction of bending. The properties of these springs can be assigned so as to model the elastic-plastic behavior of the beam itself and/or to model the flexibility and inelastic behavior of the end connections.

The spring properties are assigned using spring curves (page 29) representing the moment-rotation behavior and by selecting the appropriate parameters that determine hysteretic behavior.

This element is used by specifying member end nonlinear springs for members whose type is *beam*.

Super Cable Element

The Super Cable Element has multiple internal Gaussian points that simplifies cable modeling. Self-weight and other types of distributed and concentrated loads imposed within the element are analyzed as equivalent concentrated loads at internal Gaussian points. While simplifying the modeling of cables, the element provides a realistic and reliable solution considering geometric nonlinearity due to the sagging effect under arbitrary loading.

Section: At Start, End

The sectional properties of members are established by assigning a section type (page 23) from the list of sections defined in the project. The section's name is used here.

A member is assigned one or two sections (page 23), which give the cross-sectional properties of the member. If one section is assigned, the section applies throughout the member. If two sections are assigned, the sectional properties of the member vary linearly, with the start of the member taking sectional properties from the first assigned section, and the end of the member taking sectional properties from the end of the section.

Sections may have nonprismatic properties, in which the dimensions of the section change over the length of the member, either through assigning two section properties as above, or using a nonprismatic section defined in the Section Composer. When a Section Composer nonprismatic section is assigned to a member, a second section cannot also be assigned. When a nonprismatic section from the Section Composer is assigned, use Spans (page 73) to extend the nonprismatic variation over multiple connected members.

The beam element can carry axial forces, shear forces, bending moments and torsion. The data for cross-sectional area gives axial stiffness in the x-direction; the torsional moment of inertia gives stiffness for rotation about the element x-axis; the moment of inertia about the y-axis gives stiffness for translation in the z-direction and for rotation about the y-axis. The moment of inertia about the z-axis gives stiffness for translation in the y-direction and for rotation about the z-axis. The shear areas are for shear deformations. If you set any of the cross-sectional variables are set to zero on the section property data, the corresponding stiffness is zero and the corresponding force at both ends is released.

The orientation of the principal axis of a member is defined with an *orientation angle* (see below), which sets the relative orientation of the member's local axes. The relation of the principal axis to the local axes of a member is dependent on the definition of the member's sectional properties.

Material

The material properties of members are established by assigning a material type (page 19). The material's name is used here. Material properties are constant throughout the member, except when a composite section defined in the Section Composer has been assigned as the section of the member.

Prestress Force

The initial prestressing force can be set for beam, cable, and truss elements. This type of prestressing can only be used in a nonlinear analysis. For prestressing with tendons, see Tendons (page 95). Member loads (page 123) can also be used.

Rigid Zones

The structural model is normally idealized representing the center line of the beams, columns, and braces. This technique of center-line modeling ignores the thickness of elements and results in greater lengths than is actually the case because a portion of element thickness is included in the idealized length of other elements. For instance, the thickness of a column is not accounted for in the lengths of beams attached to the column.

When the joint thickness is small compared to the actual member length, errors due to ignoring the thickness are insignificant. If the joint thickness is large compared to the actual member length, the error may be significant.

Rigid end zones can be specified to include the actual characteristics of the element end condition. A rigid end is specified as the length along the member from the start or end joint, or both, which is to be considered infinitely stiff, specified normally as a relative length from zero (i.e. no rigid end) to 0.5 (i.e. half the length of the member is rigid). It is also possible to specify rigid zones in absolute length units. See the Additional Commands section below.

Use of rigid end zones produces more realistic displacements and element forces. The element loads are considered to be acting only on the elastic length of the beam. The moment and shear force distribution along the member is computed accordingly. Loads placed in rigid zones are ignored.

While the total member length for the purposes of self-weight computation is from joint to joint, the member length used in stiffness computation is the length of the elastic portion of the member (i.e. excluding the rigid zones). To shorten the length of the member for the purposes of automatic self-weight computation, use End Offsets.

Orientation Angle

Members can be situated in any angle about their centroidal axis, such as placing flanges horizontal or vertical. The orientation angle of a member determines this angle. ***It is crucially important to define the member orientation properly*** so that the strong axis of the member is in the right direction.

The orientation angle is used to determine the orientation of the local coordinate system of the member, which is explained below. Roughly speaking, the orientation angle sets the angle between the global Z-axis and the member's local z-axis. Member sectional properties are given in member local directions. A member whose section's I_{zz} is greater than its I_{yy} , which is the case for standard I-shape sections, has its strong axis in its *local* z-axis direction. If the global Z-axis is "up" and the member is a horizontal beam, the the strong axis needs to be made horizontal by specifying an orientation angle of 90 degrees. For vertical members, the orientation angle specifies the angle between the global X-axis and the local z-axis.

See the section on member coordinate systems below for a detailed explanation of member local axes and the orientation angle.

End Offsets

The centerline of a member is normally the straight line between the member's two joints. End offsets can be applied to move the end-points of the member, relative to the locations of the joints. Offsets can be applied at the start and end of a member and are given in global coordinate system directions.

The actual length of the member is computed after the end offsets are applied. This length is used for stiffness computation and load application (including self-weight).

An end offset is equivalent to a rigid link between the offsetted end of the member and the joint it is connected to at that end.

See the section on member coordinate systems below.

In dynamic analysis, element mass is computed as a lumped mass matrix. When the element has an end offset, this matrix becomes non-diagonal when transformed to the element's joints.

End Releases

The end connections of beam elements are by default perfectly rigid. Beam-joint connections can be also specified as pinned or semi-rigid. If a member end release is specified, then the corresponding force is set to zero. The effect of the hinge is to free the force at the end of the beam, not at the joint.

The release components are in the member local coordinate system. All directions except F_y and F_z may be released. Semi-rigid releases can be applied only for M_y and M_z . The semi-rigid end connections are specified as a percent of fixity. A value of 0 represents a perfect hinge (free) and 100 represents full fixity. Semi-rigid connections are ignored when applied to hysteretic and connection beams. F_y and F_z can be effectively released by making use of DOF constraints (page 93).

Note that a rigid/fixed member-joint end connection does not prevent the joint itself from translating or rotating, subject to its own degrees of freedom restraint conditions. Instead, a fixed member-joint connection ensures that all other member rigidly connected to the same joint undergo the same displacement at the joint.

Structure/Construction Group

Structure groups can be assigned directly to members. It is possible to select an existing structure group here or specify a new one. Structure groups are used to modularize the geometry of the model and plays a key role in staged construction analysis. For more information see Structure Groups Explorer [see "Structure Groups Explorer" in *LARSA 4D User's Manual*].

Connection Beam Properties

Member End Nonlinear Springs

Application of these springs makes the member a connection beam element. The connection beam element consists of an elastic beam with built-in yielding springs at the ends. There can be up to two springs at each end, one for each direction of bending. The properties of these springs can be assigned so as to model the elastic/plastic behavior of the beam itself and/or to model the inelastic behavior of the end connections. The type of connection beam members must be *beam*.

Properties for Time-Dependent Material Effects

In the Time-Dependent Staged Construction Analysis (page 247), members can be subject to time-dependent material effects including creep, shrinkage, and the time-effect on elastic modulus. The following fields are relevant to this analysis:

Casting Day

The day the member is cast, for use in the Time-Dependent Staged Construction Analysis (page 247). The age of the member when constructed is determined by subtracting the casting day from the day of construction set for the construction stage being analyzed. The casting day of a member must be less than the day of construction when the member is assembled.

Starting in LARSA 4D version 7.2, there is also a cast concrete activity (page 155) in Staged Construction Analysis which can be used to set the casting day of the member. It is also possible to cast individual shapes within a built-up section created in the Section Composer. In this case, the cast concrete staged construction activity must be used rather than the Casting Day attribute of the member element as a whole.

Additionally, a time-dependent material property definition (page 53) must be assigned to either the material or the section that is assigned to the member, but not both. The time-dependent properties are thus indirectly associated with the member element.

Member Coordinate Systems (Local Axes)

Members have two "local" coordinate systems for the purposes of the alignment of cross-section geometry and properties, loading, the alignment of tendons and lanes, and reporting forces, stresses, and other results. The local coordinate systems of members determine both the location of the member centroid and the orientation of a member about its centroid: which way the wedges and flanges are pointing, for instance. Because these coordinate systems define the position of the centroid and the orientation of the member's strong axis, it is crucially important to understand and set up these systems properly.

The two systems are the **reference coordinate system** and the **local coordinate system**. In most cases, the two systems are the same. They differ only when a member has been assigned a section from the Section Composer [see "LARSA Section Composer" in *LARSA Section Composer Manual*] with a centroid offset from the reference coordinate system.

The **reference coordinate system** is used to determine the placement of the member's cross-sectional geometry and tendons (page 95). Its origin is located at the I-Joint of the member, plus any end offset specified at the I-Joint. The x-axis of the reference coordinate system is directed toward the J-Joint of the member, plus any end offset specified at the J-Joint.

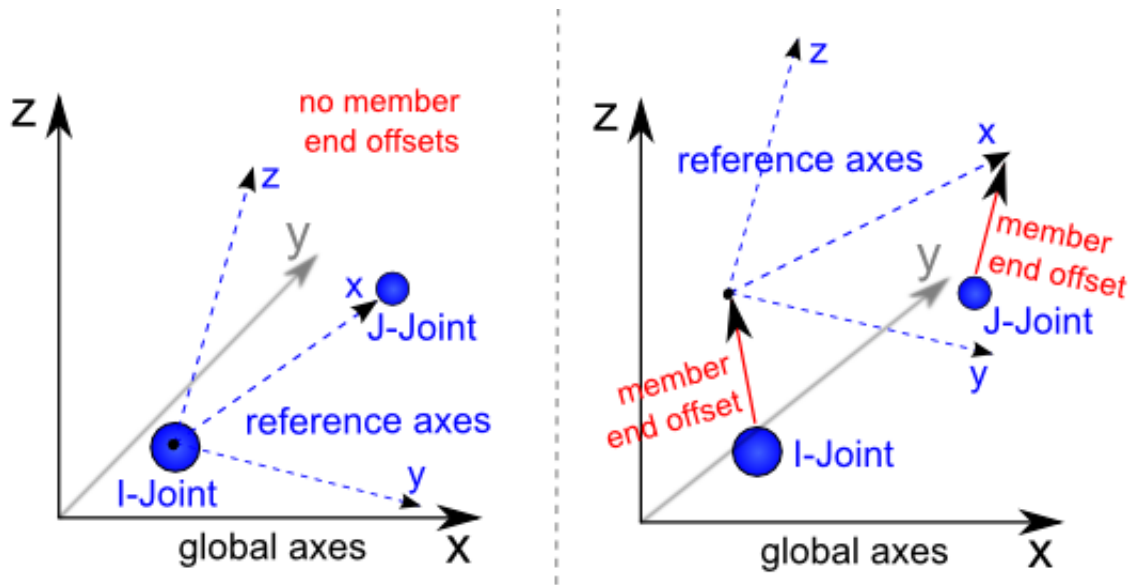

Member Reference Axes - Alignment With Joints

The y- and z-axes of the reference coordinate system are oriented according to the orientation angle of the member, as follows:

The direction of the reference coordinate system z-axis is determined as follows:

Call the global coordinate axes X , Y , Z and the reference member axes x , y , z . The orientation angle is defined as follows:

- Let A be a plane containing the reference x -axis and a line parallel to the global Z -axis. Plane A will therefore be perpendicular to the XY plane.
- Let z' be a point on a line connected to the origin of the reference coordinate system in the plane A and perpendicular to the reference x -axis. The location of z' must be taken so that the projection of the line from reference origin to z' is in the positive Z direction.
- Then, the orientation angle is defined as the angle from z' to z , positive by the right-hand rule about the member local x -axis.

In other words, the orientation angle is the angle between the global Z -axis and the reference z -axis

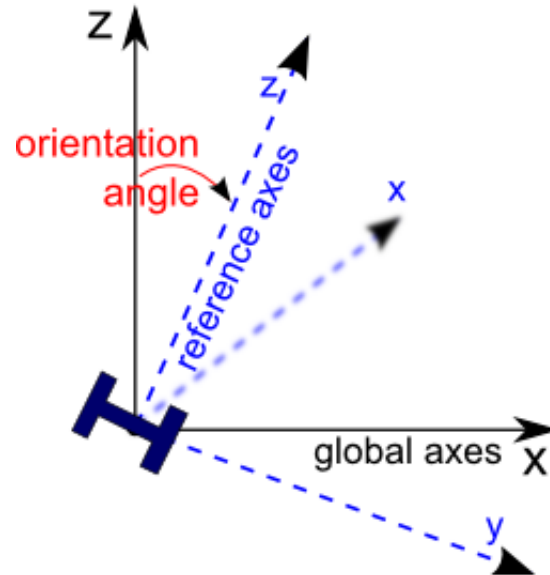

Member Reference Axes - Horizontal Members

This definition is valid for all members except when the reference x -axis is parallel to the global Z -axis. In such a case, the plane A cannot be defined as described above. If the reference x -axis is parallel to the global Z -axis, the following rules are used:

- When the reference x -axis is in the same direction as the global Z -axis, the orientation angle is defined as the angle from the minus X -axis to the z -axis.
- When the reference x -axis is in the direction opposite to the global Z -axis, the orientation angle is defined as the angle from positive X -axis to the z -axis.

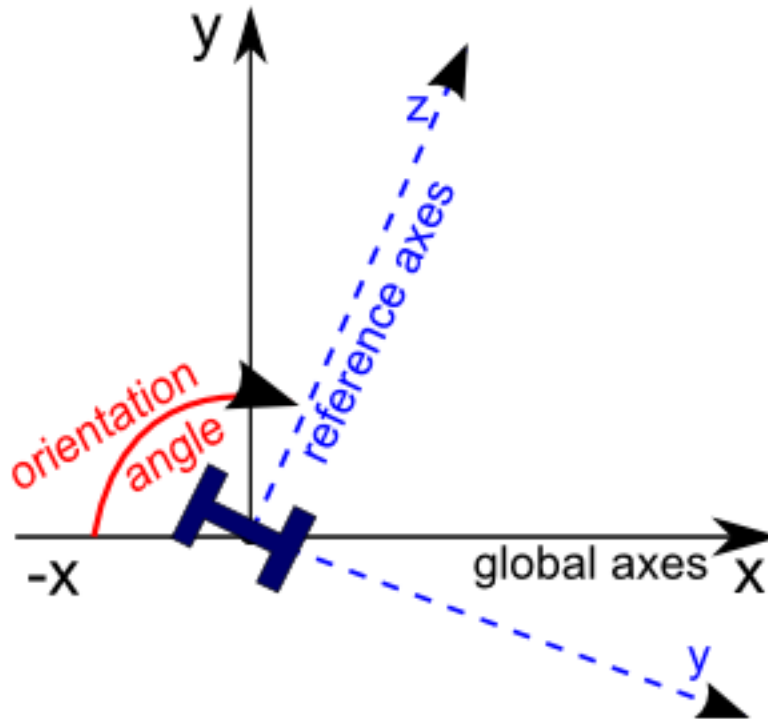

Member Reference Axes - Vertical Members

The member **local coordinate system** x-axis corresponds to the member centroid, with the y- and z-axes the axes about which the sectional properties (page 23) I_{yy} and I_{zz} are given and the directions in which member loads (page 123) and results such as Member End Forces (page 285) are entered and reported in. For standard sections (i.e. those not created in the Section Composer), the local x-axis (i.e. the centroid of the member) is placed along the x-axis of the reference coordinate system, and the member local coordinate system coincides with the reference coordinate system.

Note that the local member axes are not necessarily principal axes. If the product of inertia I_{yz} is zero for the member, the local axes coincide with the principal axes of the member.

For sections created in the Section Composer [see “LARSA Section Composer” in *LARSA Section Composer Manual*] when the centroid of the section is not placed at the member reference coordinate system origin, the centroid is offset from the reference axis according to the section definition. For sections without nonprismatic variation, this merely offsets the member local coordinate system from the reference axes. The local coordinate system y- and z-axes are directed the same way as (are parallel to) the reference axes.

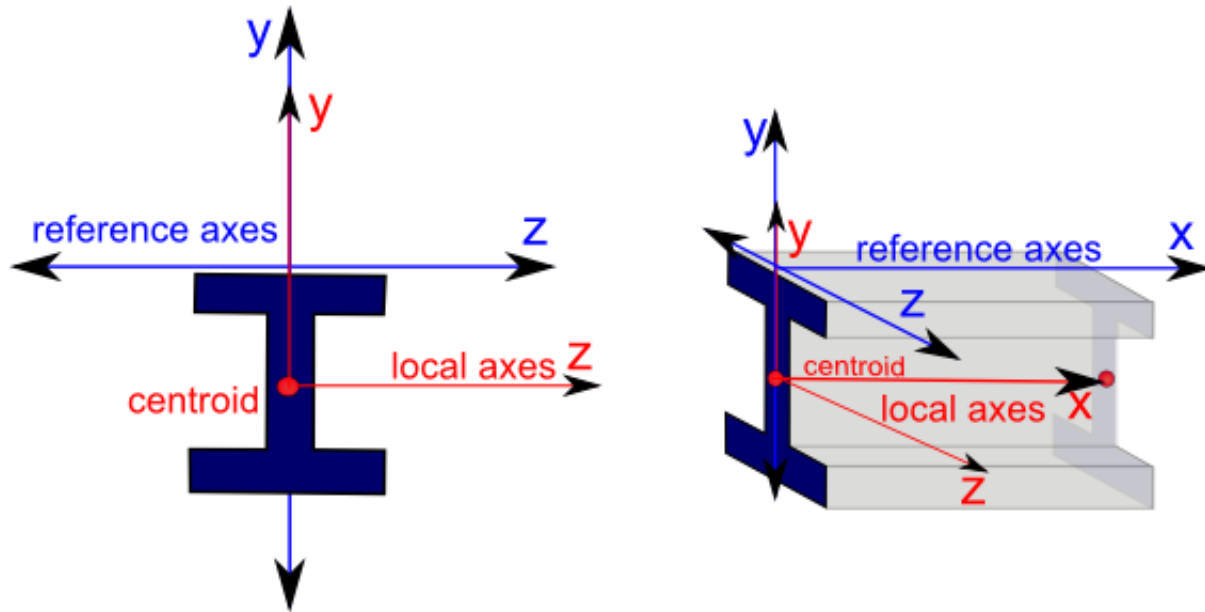

Member Local Axes - A Centroid Offset

If the section has nonprismatic variation, the end points of the centroidal local x-axis are positioned in the reference coordinate system according to the section definition. The local coordinate system y- and z-axes are oriented so that the local z-axis is parallel to the reference z-axis. In this case, the local y-axis will not be parallel with the reference y-axis.

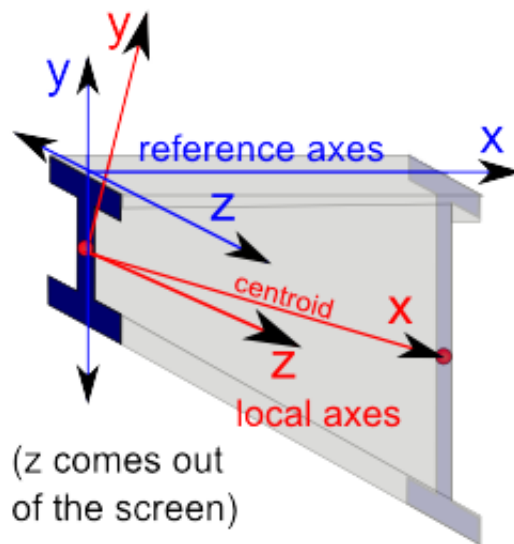

Member Local Axes - Nonprismatic Variation

When a user coordinate system is active, the orientation angle is displayed relative to the active local coordinate system's axes rather than the global axes. For members parallel to the user coordinate system's z-axis, the orientation angle is the angle from the coordinate system's positive x-axis. This differs from the convention described above which uses the negative global x-axis.

Self-Weight Computation

The self-weight of members used in static load cases with self-weight (page 117) activated, is applied as a uniform load with magnitude equal to the member's material unit weight multiplied by the member's cross-sectional area. It is applied in the direction specified in the load case.

Additional Commands

Some additional related commands are available. These commands are used to modify input data or to access additional attributes of the data referenced above. The commands can generally be accessed in one of several ways.

In the Members spreadsheet, the commands are available in the Members menu, or by right-clicking the spreadsheet. Some commands can be applied to more than one row in the spreadsheet at once by selecting multiple rows before activating the command.

In the graphics window, activate the Pointer mouse tool from the toolbar, and then right-click an object in the graphical display to get the list of commands to apply to that object only.

To apply the command to multiple members at once, first select those members and unselect everything else, then go to the Modify menu, find the Members menu, and choose a command from within that menu. Activating these commands from the Modify menu will apply the action to all selected members.

The additional commands are as follows:

Edit Section

When the member is assigned to a standard section, this command opens the sections spreadsheet to the member's section. When the member is assigned a nonprismatic section, this command opens a new window to edit the parameters of the section and to view its nonprismatic variation.

See Section Stresses

When analysis results are available and there is an active result case, this command opens a new window showing the stresses throughout the member's cross-section, at any point along the length of the member.

Member Section Stresses

Rotate Principal Axis

The member's orientation angle is increased by 90 degrees.

Enter Relative Positions

Choosing this option sets the rigid zone fields to be entered in relative dimensions, where 0 is no rigid zone and 1 is the entire length of the member.

Enter Absolute Positions

Choosing this option sets the rigid zone fields to be entered in true length dimensions.

Break Member to Existing Joints

If the member passes through joints but is not connected to the joints, the member is broken into pieces so that it connects to each joint it passes through.

Reverse Direction

The member's start (I) and end (J) joints are reversed, which reverses the direction of the local x-axis of the member.

Select Chain

This command starts with the chosen member, or the selected members, and selects all members on the same chain. A chain is a series of members connected by joints all going in the same direction, like a physical member or girder modeled as many members.

Orient Principal Axis to Joint...

This command prompts the user to choose a joint, and then orients the member's local z-axis so that it points toward the chosen joint.

Renumbering Setup

This command sets up renumbering options for members. The user can choose the starting ID and the step.

Renumber

Renumbers the selected members according to the renumbering setup options, which must be set first.

Renumber Chain

This command renumbers the members in the chosen member's chain according to the renumbering options. If the member is selected, only selected members on the chain will be renumbered. Otherwise, all members on the chain will be renumbered.

Span Properties

If the member is part of a span (page 73), the span's properties are shown.

For More Information, please refer to the following documentation.

- Spans on page 73.
- For help on using spreadsheets, see *Using the Model Spreadsheets in LARSA 4D User's Manual*.
- Joints on page 59.
- Materials on page 19.
- Sections on page 23.
- Member Reference Line and Local Coordinate System in *LARSA Section Composer Manual*.

Spans

Spans are special entities that represent physical members in the real world. Spans are collections of one or more members that usually form a straight line. They must be used in certain cases of sections with nonprismatic variation.

A beam in the real world must often be modeled as multiple members in LARSA so that connections along the member can be made. Such members are called analytical members, as opposed to physical members, because they only exist for the sake of the analysis.

It is sometimes necessary to treat groups of members that represent one physical member in a special way, such as for code checks and design [see “Steel Design” in *LARSA 4D User’s Manual*], for obtaining analysis results (page 297), or when the physical member’s cross-section has nonprismatic variation [see “Nonprismatic Variation” in *LARSA Section Composer Manual*].

All members in a span must have the same section and material properties and must be of the same type. For more information on span properties, see member properties (page 61).

Additional Commands

Some additional related commands are available. These commands are used to modify input data or to access additional attributes of the data referenced above. The commands can generally be accessed in one of several ways.

In the Spans spreadsheet, the commands are available in the Spans menu, or by right-clicking the spreadsheet. Some commands can be applied to more than one row in the spreadsheet at once by selecting multiple rows before activating the command.

The additional commands are as follows:

Properties

This command opens a window which allows the user to add and remove members from the span, and to change the span’s material and section properties.

For More Information, please refer to the following documentation.

- For help on using spreadsheets, see Using the Model Spreadsheets in *LARSA 4D User’s Manual*.
- Members on page 61.
- Steel Design in *LARSA 4D User’s Manual*.
- Nonprismatic Variation in *LARSA Section Composer Manual*.

Plates

The plate is a planar element with constant thickness, either triangular or quadrilateral in shape, with isotropic or orthotropic material properties. It has both plate bending (out-of-plane action) and plane stress (membrane actions, in-plane action) stiffness.

Usage Notes

The plate element is a linear element with linear material properties (page 19).

The use of the triangular element should be limited to transition zones where quadrilateral elements cannot be easily used. Triangular elements with interior angles close to 60 degrees each are ideal, and interior angles in excess of 120 degrees will distort results around the element.

The aspect ratio for quadrilateral plates, defined as width-to-length, should not be so large as to skew the element. The interior angles for quadrilateral elements should not be much greater than 90 degrees.

Plates must have non-zero area and thickness. When the thickness is large in comparison to the width of the plate, a thick-plate element behavior must be chosen.

Geometric nonlinearity is only available for element formulation options as indicated below. See below.

Element Formulation

Several bending (out-of-plane, also called plate) and membrane (in-plane) behaviors are available for the plate element. The correct choice of bending and membrane behavior will depend on the model according to factors explained below.

Bending (Out-of-Plane) Behaviors

Inactive

The element has no plate stiffness.

Thin Plate

The thin plate (DKQ-DKT) bending behavior has two rotational (θ_x and θ_y) and one translational (w) degrees of freedom at each node. Shear deformations within the thickness of the element are assumed to be equal to zero. Factors to consider:

- Can be used to model any type of plates where shear deformations are not important such as slabs, decks, retaining walls, abutments, etc.
- Shear forces are only computed at the center of the element using the first derivatives of the internal element moments.
- Gives more accurate internal moments when compared with thick plate elements.

Thick Plate

The thick plate bending behavior has two rotational (θ_x and θ_y) and one translational (w) degrees of freedom at each node. Shear deformations within the thickness of the element are assumed to have a linear variation.

The element has quadratic displacement field definition for bending and shear deformations. Factors to consider:

- Can be used to model plates where shear deformations are important such as pile caps and mat foundations.
- Does not give correct internal moment results just under point loads. Internal moments elsewhere and external moments are accurate.
- Shear forces are only computed at the center of the element using the shear strains.

In order to determine whether shear deformations are important or not, the parasitic shear parameter can be computed with the following equation for the direction in interest: $\Phi = 12EI/(A_sGL^2)$, where E and G are the elastic and shear modulus, respectively, I is the moment of inertia, A_s is the equivalent shear area, and L is the clear span length. Having a value equal to 0.05 means that shear deformations makes the plate approximately 5% flexible. Thus, based on the value of parasitic shear parameter, one can decide whether to consider shear deformations or not.

MITC4

See below.

Membrane (In-Plane) Behaviors

The following in-plane membrane behaviors are available:

Inactive

The element has no membrane stiffness.

Bilinear (Quadrilateral Plates Only)

The bilinear membrane behavior for quadrilateral elements has two translational (ux, uy) and one rotational (θ_z) degrees of freedom at each node. The rotational degree of freedom has a fictitious stiffness to provide stability in shell structures. The element has a bilinear displacement field definition. Factors to consider:

- The element has a linear displacement field and so suffers from membrane locking (very stiff behavior) in bending problems.
- Can be used for cases where axial deformations are more important and bending deformations are negligible.
- Element stresses are less sensitive to mesh distortions when compared with higher order elements.
- The effect of rotation at the nodes (θ_z) cannot be computed accurately, and this may be important when the nodes connect to other elements such as beams with significant end rotations.

When the Bilinear / CST option is chosen for triangular elements, the Constant Strain Triangle (CST) behavior is used instead.

Incompatible (Quadrilateral Plates Only)

The membrane with incompatible modes behavior has two translational (ux, uy) and one rotational (θ_z) degrees of freedom at each node. The rotational degree of freedom has a fictitious stiffness to provide stability in shell structures. The element has additional internal general displacement parameters named as incompatible modes. With these additional parameters, the element has a higher order displacement definition which avoids membrane locking (i.e. better bending behavior when compared with bilinear elements). Factors to consider:

- Can be used for modeling flat members.

- Due to the definition of general displacement terms within the elements, the displacement at the element edges are not continuous (compatible) between elements.
- Element stresses are more sensitive to mesh distortions when compared with bilinear membrane element.
- The effect of rotation at the nodes (θ_z) cannot be computed accurately, and this may be important when the nodes connect to other elements such as beams with significant end rotations.

When the Incompatible / CST option is chosen for triangular elements, the Constant Strain Triangle (CST) behavior is used instead.

Drilling (Quadrilateral Plates Only)

The membrane with a drilling degree of freedom behavior has two translational (u_x, u_y) and one rotational (θ_z) degrees of freedom at each node. The rotational degree of freedom is defined from the displacement of the mid-points of the edges, thus they have actual stiffness values for drilling degrees of freedom. The element has a quadratic displacement field definition. Factors to consider:

- Can be used for modeling shell structures such as folded plates, curved roofs, etc.
- When connected to beam elements at a node, the effect of rotation (θ_z) is better represented.
- Defining a restraint for the drilling degree of freedom means that the mid displacements of the neighbor edges in the outward normal direction is also restrained.

When the Drilling / CST option is chosen for triangular elements, the Constant Strain Triangle (CST) behavior is used instead.

Constant Strain Triangle (CST)

The CST membrane behavior is used for triangular plate elements when Bilinear, Incompatible, or Drilling are selected. This behavior has two translational (u_x, u_y) and one rotational (θ_z) degrees of freedom at each node. The rotational degree of freedom has a fictitious stiffness to provide stability in shell structures. The element assumes constant axial strain between the nodes. Factors to consider:

- Not a good element for bending.
- Should be used with a fine mesh size for acceptable results.
- The effect of rotation at the nodes (θ_z) cannot be computed accurately, and this may be important when the nodes connect to other elements such as beams with significant end rotations.

MITC4

See below.

MITC4

MITC4 (Mixed Interpolation Tensorial Components) is a curved quadrilateral shell element formulated for geometric nonlinearity. The element can undergo large deformations and large rotations in nonlinear static, buckling, and pushover analysis, nonlinear time history analysis, and Staged Construction Analysis when Include Geometric Nonlinearity is turned on. It can be used in combination with the cable element and other nonlinear elements. Because it is a curved element, it performs well when used with curved geometry.

The formulation is based on the original element with five degrees of freedom at each node. Small fictitious stiffness is added to the drilling degrees of freedom to provide stability. The membrane behavior is described with a bilinear displacement field. The formulation uses an assumed transverse shear strain field, thus the element does not suffer from shear locking.

Other considerations:

- The effect of rotation at the nodes (θ_z) cannot be computed accurately because the original element formulation lacked drilling stiffness, and this may be important when the nodes connect to other elements such as beams with significant end rotations.
- Element loading specified in local directions is calculated using the undeformed geometry always.
- Although the original element formulation requires the definition of outward unit normals at each node, LARSA 4D computes the unit normals at each node from the cross-product of the adjacent edges.
- In linear analysis, the element has a linear displacement field and so suffers from membrane locking (very stiff behavior) in bending problems similarly to the bilinear membrane behavior. Consequently, although the MITC4 formulation can be used in linear analysis, it is recommended to use one of the linear element behaviors described above in linear analysis.
- Orthotropic material properties are not supported for this behavior.

The MITC4 behavior is only available for quadrilateral elements. It is an error to choose MITC4 for triangular elements.

The element is based on the formulation in *Dvorkin EN, Bathe KJ. A continuum mechanics based four-node shell element for general nonlinear analysis. Eng Comput 1984;1(1):77-88.*

Classic Behavior

In addition, there is a bending and membrane behavior called Classic which was the plate element formulation available in LARSA 4D through version 7.1.12. It is no longer recommended to use these behaviors because time-dependent material effects such as creep and shrinkage and orthotropic material properties are not supported for plates with these behaviors. They can only be used when both the bending and membrane behaviors are set to Classic. These behaviors were recommended for thin plates when shear deformations are negligible. For the bending behavior, a cubic polynomial is used to describe the displacement of the mid-plane. The membrane behavior is similar to the Incompatible membrane behavior described above: It has no stiffness for rotation about the axis perpendicular to the element surface, and it is an incompatible element (bilinear shape functions with incompatible modes). For triangular elements, a constant strain formulation is used. Geometric nonlinearity is introduced through the updating of the deformed shape that occurs in the nonlinear static analysis (but not in Staged Construction Analysis).

Attributes of Plates

ID

Plate numbers are assigned for identification purposes. They can be any integer, and they must be uniquely assigned among all plates in a project, but they need not be assigned consecutively.

Bending Type

The out-of-plane plate behavior, as described above.

Membrane Type

The in-plane membrane behavior, as described above.

Joints (I, J, K & L)

The element connectivity of the plate elements is described using 3 joints for triangular elements and 4 joints for quadrilateral elements. These joints must not be coincident or collinear and must be specified in clockwise or counter-clockwise order. The order will determine the element's local coordinate system. For triangular plates, Joint L should be set to *none*.

Material

The material properties of the element are established by assigning the material type to the element. Both isotropic and orthotropic materials (starting in version 8.01) can be used (see Materials (page 19)).

Thickness

The thickness of the element. The value entered must be in the units specified for section properties. The thickness is constant throughout the plate.

Structure/Construction Group

Structure groups can be assigned directly to plates. User have option to select an existing structure group or specify a new one. Structure groups are used to modularize the geometry of the model and plays a key role in staged construction analysis. For more information see Structure Groups Explorer [see “Structure Groups Explorer” in *LARSA 4D User's Manual*].

Material Angle

For plates with orthotropic material properties, this field reports the angle between the local x-axis of the plate and its Material 1 axis. It cannot be set by the user. Instead, set the Material UCS property (page 19) of the material.

End Offsets

End offsets can be applied to move the corners of the plate, relative to the locations of the joints it is connected to. Offsets can be applied at each corner of the plate and are given in global coordinate system directions.

The geometry of the plate is computed after the end offsets are applied. The area of the plate for stiffness computation and load application (including self-weight) is determined by the coordinates of the corners of the plate after the end offsets are applied.

An end offset is equivalent to a rigid link between the offsetted corner of the plate and the joint it is connected to at that corner.

See the section on plate coordinate systems below.

In dynamic analysis, element mass is computed as a lumped mass matrix. When the element has an end offset, this matrix becomes non-diagonal when transformed to the element's joints.

Element Coordinate Systems

Plate loads, plate results, and plate material properties are defined with respect to up to two different element-specific coordinate systems.

Local Axes

The first is called the plate local axes. Plate local axes define the directions of plate loads and the directions that internal plate forces and stresses are reported in.

The local x-axis and local y-axis are on the surface of the plate. The plane defined by the local x- and y-axes represent the in-plane directions. The local-z direction is the out-of-plane direction of the element and is perpendicular to the surface of the plate. The diagram below shows the definition of the plate local coordinate system:

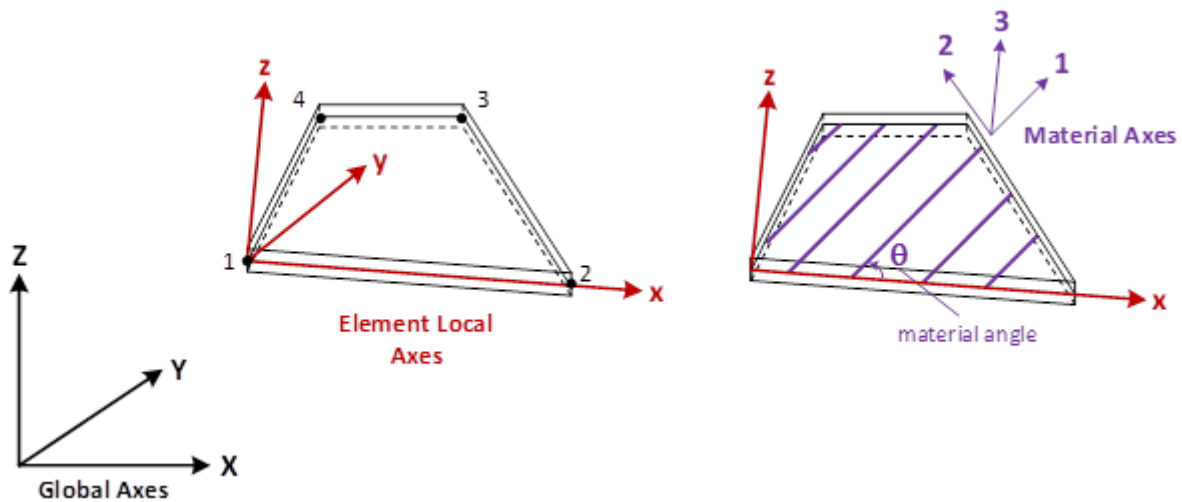

Plate Local Axes (left) and Material Axes (right)

The local x-axis is defined as the vector from the location of the plate element's first joint (plus any plate end offsets at that joint) to the location of the plate element's second joint (plus any plate end offsets at that joint). The positive local-z axis points to the side of the plane from which the joints appear in counter-clockwise order. The direction of the local y-axis is determined from right hand rule using the local x- and z-axes.

It is important to note that the element's local axis directions depend on the way the element connectivity is defined. The local axis is always determined by using the global coordinates of the first three nodes, in order, and the plate element's corresponding end offsets, if any. Thus, depending on the element geometry and element connectivity definition, the local axes of these elements in a mesh may be different.

Formally, the local axes of plates are determined using the sequence of the joints entered (I, J, K, and, for quadrilateral plates, L, defined in counter-clockwise order):

- The origin of the plate's coordinate system is at the I joint.
- The x-axis is along the line from the I joint to the J joint.
- The z-axis is perpendicular to the plane of the plate, in the direction of the right-hand rule.
- The y-axis is normal to x- and z-axes.
- The thickness of the plate extends $thickness/2$ into the positive-z direction and $thickness/2$ into the negative-z direction.

See Plate Forces on Center (page 303), Plate Forces at Joints - Internal (page 309), and Plate Stresses on Center and at Joints (page 313) for more information about the axes used in the reporting of results.

Material Axes

Material axes are used when an orthotropic material is applied to the plate element. (See Materials (page 19). Available starting in version 8.01.) Orthotropic material properties are applied to the plate element according to its material axis directions, not the element's local axis directions.

The material axes are named 1, 2 and 3, so as not to be confused with the local axes x, y, and z. While Material 3 axis is always identical to the out-of-plane local z-axis, the Material 1 and 2 axes may not be identical to the local y- and z-axes. These material axes are determined according to the material's Material UCS, which is either either the Global Coordinate System or a user coordinate system. The Material 1 axis is the projection of the Material UCS's x-axis

onto the surface of the plate element, and the Material 2 axis is the projection of the Material UCS's y-axis onto the surface of the plate. The Material UCS determines the material axes for all plate elements that the material is applied to. Therefore, to set a plate element's material axes, set the Material UCS on the plate's material to a User Coordinate System whose x-axis is in the direction of the desired Material 1 axis.

The "material angle" is the angle between the element local x-axis and the Material 1 axis measured in the counterclockwise direction. The material angle is not entered by the user. It is computed automatically and reported in the Plates spreadsheet.

See the plate axes figure above.

Self-Weight Computation

Automatic self-weight computation (page 117) uses the plate's material unit weight (page 19) and the plate's thickness to determine the magnitude of the uniform distributed load placed in the given direction of self-weight.

Additional Commands

Some additional related commands are available. These commands are used to modify input data or to access additional attributes of the data referenced above. The commands can generally be accessed in one of several ways.

In the Plates spreadsheet, the commands are available in the Plates menu, or by right-clicking the spreadsheet. Some commands can be applied to more than one row in the spreadsheet at once by selecting multiple rows before activating the command.

In the graphics window, activate the Pointer mouse tool from the toolbar, and then right-click an object in the graphical display to get the list of commands to apply to that object only.

To apply the command to multiple plates at once, first select those plates and unselect everything else, then go to the Modify menu, find the Plates menu, and choose a command from within that menu. Activating these commands from the Modify menu will apply the action to all selected plates.

The additional commands are as follows:

Renumbering Setup

This command sets up renumbering options for plates. The user can choose the starting ID and the step.

Renumber

Renumbers the selected plates according to the renumbering setup options, which must be set first.

Reverse Joint Order

The order of the I, J, K, and L joints are reversed. The effect is to keep the origin of the plate's local axes at the I joint, but to direct the local x-axis not toward the second joint but instead toward the last joint, and to reverse the direction of the local z-axis.

Shift Joint Order

The order of the I, J, K, and L joints are shifted so that the origin of the plate's local axes moves to the J-joint.

Put Local Axes in Same Direction

When many plates are selected, this command ensures that all of the plates' local z-axes are directed in the same direction, i.e. all up or all down.

Break Plates to Existing Joints

The plate is meshed so that any joints within the plate are connected to the meshed surface.

For More Information, please refer to the following documentation.

- For help on using spreadsheets, see Using the Model Spreadsheets in *LARSA 4D User's Manual*.
- Materials on page 19.
- Joints on page 59.

Springs

The spring is a very general element that can be used to model foundations, soil-structure interaction, gaps, bearings, and isolators, and it can be used as a general stiffness element. The spring element can be grounded (one-node) or two-node and can have linear, nonlinear elastic, and hysteretic (nonlinear inelastic) material properties. All springs have one degree of freedom at the joints they are connected to, except when a 6x6 matrix is assigned to the spring.

Usage Notes

For coupled springs, see Isolators (page 89).

The spring element is weightless. Joint loads (page 119) for static analysis or mass elements (page 91) for dynamic analysis can be used to model the weight or mass of springs, if necessary.

Grounded Spring Element

The grounded spring element (i.e. the one-node spring) is defined using a single joint and there is no length associated with the element. The element represents a spring connecting a joint in the structure to the ground at its undeformed location.

The linear grounded spring element has the same stiffness in both tension and compression. Either a single spring constant is specified, or a 6x6 stiffness matrix (page 29) is applied to the spring. If a spring constant is given, the element can act in one direction only: either translation along or rotation about an axis of the global coordinate system, or the joint displacement directions (page 59) assigned to the joint the spring is connected to if a joint displacement system has been assigned to the joint.

The nonlinear elastic grounded spring element is a general foundation element. This element is a versatile element for use in mat foundations, beams on elastic foundations and in structures supported by contact only. It is used to model foundations where soil has stiffness in compression and no resistance in tension or to model piles with varying resistance in tension versus compression. For nonlinear elastic grounded springs, k-tension, k-compression, maximum tension, maximum compression, hook, and gap values can be specified. Alternatively, a spring curve (page 29) can be assigned describing the force-deformation curve of the element. The spring acts in a single direction only.

In Staged Construction Analysis, when a grounded spring is attached to a joint that is simultaneously restrained in the same direction as the spring, the spring is considered released from the structure and will report zero force in that direction, until the joint restraint is removed.

Two-Node Spring Element

This element is defined using two joints. The element represents a spring connecting the joints, or represents arbitrary stiffness between the two joints in the direction specified. The length of the element may be zero, depending on the spring's direction property.

This element can act in one of several directions:

1) It can act in either the axial or torsional direction along or about the straight line connecting the spring's ends, provided the length of the element is non-zero. An axial spring acts according to the lengthening or shortening of

the straight-line distance between the joints. For torsional springs, "tension" is rotation about the joint-to-joint line following the right-hand rule by the end joint, relative to the start joint.

2) It can also act in a direction given by either the global coordinate system or a user coordinate system. In these cases, the length of the element may be zero. The directions are along or about the start-joint's displacement coordinate system (The end-joint's displacement coordinate system is ignored for determining the direction of the spring). The start joint's displacement coordinate system can be a user coordinate system (page 39) or the global coordinate system if it has not been assigned a joint displacement coordinate system (page 59). The spring deformations (page 321) are reported as the displacement of end joint relative to the start joint and the spring forces (page 319) are reported as the forces at the start of the spring element, in the direction chosen. In other words, the positive displacement or force does not necessarily correspond to extension or tension.

The linear two-node spring element has the same stiffness in both tension and compression and acts in a single direction only. Only one spring constant can be specified (see Springs (page 83)). The 6x6 stiffness matrix option for grounded springs is not available for two-node springs.

The nonlinear two-node spring is defined using a spring curve (page 29) describing the force-deformation curve of the spring. The nonlinear elastic spring element loads and unloads along the same path. Its stiffness can only be specified in this manner.

Gap and hook distances, yield force, and different behavior for compression and tension can be included in the spring material curve with the proper definition of the tabular function representing the behavior.

The two-node spring is an uncoupled element, meaning the behavior of the spring in one direction does not affect other directions. Isolators and bearings are coupled elements. (page 89)

The nonlinear two-node spring element can be elastic or hysteretic (inelastic). The hysteretic spring element is described below.

Hysteretic (Nonlinear Inelastic) Spring Element

The hysteretic spring is a two-node element that represents an inelastic, nonlinear connection between the joints. The length of the element may be zero, depending on the spring's direction property. The directions in which the spring can act are the same as for other two-node springs described above.

As opposed to the nonlinear elastic spring, the inelastic spring element exhibits plastic behavior. The unloading path differs from the loading path and depends on the history of loading.

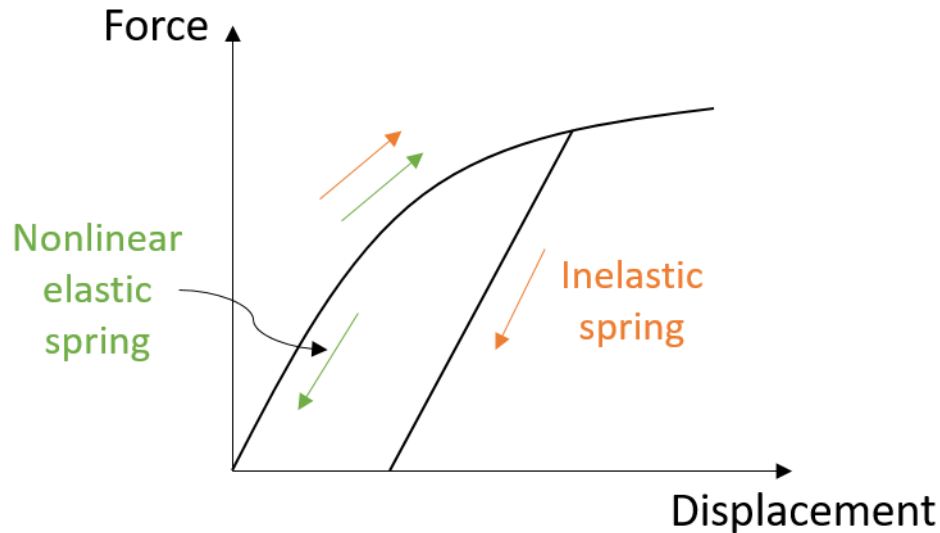

Loading and unloading of nonlinear elastic and inelastic springs

The spring response is governed by a backbone curve (page 29) representing a force-deformation relationship. The backbone curve is specified based on the material properties. The inelastic spring model can account for deteriorating structural behavior due to repeated cyclic loading. This is achieved through modeling of stiffness and strength degradation, as well as hysteresis loops pinching (see Spring Property Definitions (page 29) for corresponding model parameters).

This element should be used in nonlinear analysis types. It is crucial that the spring force is calculated accurately during transitions between various response stages (for example, elastic, yielding, unloading). Therefore, the load should be applied with small increments. For example, in nonlinear time history analysis (page 211), the time step size should be small to avoid convergence issues. In nonlinear pushover analysis (page 199), initial and maximum load factors should be decreased if the convergence issues are experienced. When used in linear analysis, the inelastic spring behaves in the same way as the linear spring element, with the stiffness equal to the pre-yield stiffness defined by the backbone curve (page 29).

The hysteretic spring can be used to model energy dissipating devices (such as yielding and friction dampers), Lead Rubber Bearings (LRB), and fasteners in Rail-Structure Interaction (RSI) models.

General Attributes

ID

Spring numbers are assigned for identification purposes. They can be any integer, and they must be uniquely assigned among all springs in a project, but they need not be assigned consecutively.

Start Joint (I Joint)

The starting connectivity of the spring.

End Joint (J Joint)

The end connectivity of the spring. For grounded springs, leave this field unset.

Type

The behavior of the spring: linear, nonlinear elastic, or hysteretic (nonlinear inelastic). For more information on the different types, see above.

Direction

Defines the direction of force or moment to which the spring reacts.

Local Axial & Local Torsional - Only available for two-node springs. The axis from joint I to joint J establishes the direction of the spring. For Local Axial, the motion is in the I-J direction. For Local Torsional, the motion is about the axis joining the joints. The length of the spring must be nonzero.

Translation X/Y/Z or Rotation X/Y/Z - Used to specify that the direction of the spring is relative to the global coordinate system or the displacement coordinate system of the spring's start joint. The directions are along or about the global coordinate system axes if the spring's start-joint has not been assigned a joint displacement coordinate system (page 59), or along or about a user coordinate system (page 39) if it has been assigned as the start-joint's displacement coordinate system. The end-joint's displacement coordinate system is ignored for determining the direction of the spring.

Structure/Construction Group

Structure groups can be assigned directly to the springs. User have option to select an existing structure group or specify a new one. Structure groups are used to modularize the geometry of the model and plays a key role in staged construction analysis. For more information see Structure Groups Explorer [see "Structure Groups Explorer" in *LARSA 4D User's Manual*].

Stiffness Attributes

The stiffness of linear grounded springs, nonlinear elastic grounded springs, and linear two-node springs can be given using the following properties. For linear springs, only K Tension may be used. K Compression is automatically given the same value. A 6x6 stiffness matrix may be provided instead for linear grounded springs, and a nonlinear spring curve may be provided instead for nonlinear grounded springs (see below).

These fields are not used for nonlinear two-node springs, which require a nonlinear spring curve. To model the nonlinear properties for a nonlinear two-node spring, modify the nonlinear spring curve property definition assigned to the spring accordingly.

K Tension

The elastic stiffness for the spring in tension in the specified spring direction. The spring stiffness for translation is force per linear translational displacement, such as kip/in. The spring stiffness for rotation is moment per unit rotation, such as kip-ft/radian. This number must be positive or zero.

K Compression

The elastic stiffness for the spring in compression in the specified spring direction. The nonlinear spring element can have compressive stiffness that differs from its tensile stiffness, but the linear spring cannot. This number must be positive or zero.

Maximum Tension/Compression

The spring element force can be restricted to a maximum specified value. Once this capacity is reached, the element will deform without any increase in the element force. The element can have a different force capacity for tension and compression.

Hook Distance

The element can be restricted to react to tension after the displacement exceeds the specified hook distance.

Gap Distance

The element can be restricted to react to compression after the displacement exceeds the specified gap distance.

The following can be used to define the nonlinear behavior of nonlinear elastic grounded springs and is used to define the behavior of all nonlinear two-node springs.

Spring Properties Definition

The spring property definition specifies other spring properties (page 29).

Additional Commands

Some additional related commands are available. These commands are used to modify input data or to access additional attributes of the data referenced above. The commands can generally be accessed in one of several ways.

In the Springs spreadsheet, the commands are available in the Springs menu, or by right-clicking the spreadsheet. Some commands can be applied to more than one row in the spreadsheet at once by selecting multiple rows before activating the command.

In the graphics window, activate the Pointer mouse tool from the toolbar, and then right-click an object in the graphical display to get the list of commands to apply to that object only.

To apply the command to multiple springs at once, first select those springs and unselect everything else, then go to the Modify menu, find the Springs menu, and choose a command from within that menu. Activating these commands from the Modify menu will apply the action to all selected springs.

The additional commands are as follows:

Edit Spring Curve

This command opens the spring property spreadsheet on the spring property definition assigned to the spring.

Renumbering Setup

This command sets up renumbering options for springs. The user can choose the starting ID and the step.

Renumber

Renumbers the selected plates according to the renumbering setup options, which must be set first.

For More Information, please refer to the following documentation.

- For help on using spreadsheets, see Using the Model Spreadsheets in *LARSA 4D User's Manual*.
- Spring Property Definitions on page 29.
- Joints on page 59.

Isolators

Isolators are two-node elements often used for protection from seismic forces. They have the behavior of a dashpot.

An isolator element has the behavior of a dashpot, such as a viscous damping device. These devices are widely used as structural protective systems for extreme loading (wind and earthquake) cases. Due to their combined benefits in terms of overall displacement reduction and energy dissipation, dampers are considered to be one of the most effective structural protective systems. For more details, see *Isolator Property Definitions* (page 37).

This element can only be used in the time history analysis (and only in the nonlinear time history analysis before LARSA 4D version 8.0) because the response of the element is velocity-dependent.

The fields required for isolator elements are given below:

ID

Isolator numbers are assigned to these elements for identification purposes. They can be any integer, and they must be uniquely assigned among all isolators in a project, but they need not be assigned consecutively.

Start (I) and End (J) Joints

An isolator's connectivity is described using two non-coincident joints. Isolators must have two joints and may not have zero length. The joints' IDs are used here.

Properties Definition

The behavior of the isolator is determined by the isolator property definition (page 37) selected for this field.

Direction

Defines the direction of velocity to which the isolator reacts.

Local Axial - The isolator reacts to velocities parallel to the axis from the I-Joint to the J-Joint of the isolator.

Trans. X/Y/Z - The isolator reacts to velocities parallel to one of the three global directions, or if the isolator's I-Joint has a joint displacement coordinate system (page 59) assigned then parallel to the X, Y, or Z local direction of that displacement coordinate system. The J-Joint's displacement coordinate system is ignored for determining the direction of the isolator.

Local Torsional - The isolator reacts to angular velocities about the axis from the I-Joint to the J-Joint. The damping coefficient must be given in units of moment per units of velocity.

Rot. X/Y/Z - The isolator reacts to angular velocities about one of the three global directions, or if the isolator's I-Joint has a joint displacement coordinate system (page 59) assigned then about the X, Y, or Z local direction of that displacement coordinate system. The J-Joint's displacement coordinate system is ignored for determining the direction of the isolator. The damping coefficient must be given in units of moment per units of velocity.

For More Information, please refer to the following documentation.

- For help on using spreadsheets, see *Using the Model Spreadsheets in LARSA 4D User's Manual*.
- *Isolator Property Definitions* on page 37.

Mass Elements

Mass elements represent concentrated masses or mass moments of inertia at joints for dynamic analyses. They are not used to apply static weight loads.

The mass of the structure is used to compute inertial forces in a dynamic analysis. The mass matrix of the structure is obtained by computing the contribution of each element connected to that joint using the weight density of the material and the volume of the element. If the weight density is zero, then the contribution of that element to the mass of the structure becomes zero.

If it is necessary to place additional concentrated masses or mass moments of inertia at the joints, the lumped masses and rotational mass moments inertia can be defined at the joints of the structure using Mass Elements. The mass at a joint includes the mass assigned to that joint using the mass element data plus the contributions from the weight of all elements connected to the joint.

Mass at restrained degrees of freedom are ignored in the analysis. The masses are always specified in the directions of the displacement coordinate systems assigned to the joints, if one has been assigned. If the joint is not assigned a displacement coordinate system, then the masses are in the global directions.

Mass values are entered as weights. The mass is automatically calculated by dividing the weight by gravitational acceleration.

Joint

The ID of the joint (page 59) to which this mass will be applied.

Translational Mass (X/Y/Z)

The applied translational mass.

Rotational Mass (X/Y/Z)

The applied rotational mass.

For More Information, please refer to the following documentation.

- For help on using spreadsheets, see Using the Model Spreadsheets in *LARSA 4D User's Manual*.
- Joints on page 59.

DOF Constraints

Degree of Freedom (DOF) Constraints can be used to enforce equal-displacement behavior of two joints in any degree of freedom.

A practical use of DOF constraints is for connecting different parts of a model or in reducing the number of equilibrium equations for certain types of structures.

The use of this feature can be illustrated where a bridge girder is supported vertically on a pier but is free to move laterally. To model such behavior, the joint on the beam and the joint on the column are defined as two separate joints sharing the same location. To simulate the interfacing with equal vertical displacement, the degree of freedom in the vertical direction of the column joint is linked to the vertical displacement direction of the joint on the beam. The joints will move independently in the horizontal direction while they will have the same vertical displacement.

The directions of motion are with respect to the displacement coordinate systems of the dependent and master joints. When no displacement coordinate systems are specified, the global coordinate system is used.

When the displacement directions of the dependent and master joints are not the same, bear in mind that degrees of freedom, and not particular directions of displacement, are being linked. For instance, if the X-Translation degree of freedom for the dependent joint is in the direction of the global y-axis, and the X-Translation degree of freedom for the master joint is in the direction of the global z-axis, then applying a DOF constraint for X-Translation between these joints will cause the dependent joint's global y-displacement to be equal to the master joint's global z-displacement.

Dependent Joint

The ID of a joint to constrain. The dependent joint will move together with equal displacement as of the master joint specified for each direction (degree of freedom). The dependent joint will move independently in the degrees of freedom where a master joint is not specified.

Master Joint for X-Translation

If a joint is specified, then the X-Translation of the dependent joint will be equal to X-Translation of this joint.

Master Joint for Y-Translation

If a joint is specified, then the Y-Translation of the dependent joint will be equal to Y-Translation of this joint.

Master Joint for Z-Translation

If a joint is specified, then the Z-Translation of the dependent joint will be equal to Z-Translation of this joint.

Master Joint for X-Rotation

If a joint is specified, then the X-Rotation of the dependent joint will be equal to X-Rotation of this joint.

Master Joint for Y-Rotation

If a joint is specified, then the Y-Rotation of the dependent joint will be equal to Y-Rotation of this joint.

Master Joint for Z-Rotation

If a joint is specified, then the Z-Rotation of the dependent joint will be equal to Z-Rotation of this joint.

For More Information, please refer to the following documentation.

- For help on using spreadsheets, see *Using the Model Spreadsheets in LARSA 4D User's Manual*.
- Joints on page 59.

Tendons

Tendons can be included in a structure for modeling the pre- and post-tensioning of members. Tendons are generally used in the Staged Construction Analysis (page 247) and include both short-term and long-term losses.

Tendons are groups of strands, wires, or rods that are stressed against a concrete member after the concrete is set. The tendons are typically given a profile to enhance their load resisting characteristics.

Tendons are defined in two parts. First, the basic properties like material and jacking force are set in the Tendons spreadsheet. Then, the tendon path geometry through the structure is set.

About the Tendon

The tendon modeling technique used in LARSA is known as *Equivalent Load through Discretization of Tendon Force*. The tendon force is discretized along its length to account for the following:

- Variation of force along the tendon length caused by the short-term effects of friction and seating of the tendon at stressing.
- Long-term losses in prestressing due to relaxation, creep, shrinkage, and elastic shortening.

This method has the advantage of implicitly accounting for the change in geometry of nonprismatic sections, which are commonly used in bridge construction projects. An added advantage is that when the primary moment at each section is computed using the adjusted force at the section, the prestress losses along the tendon are included.

For an internal tendon idealized as a series of straight segments there is a gradual stress loss along each segment due to wobble friction and curvature. External tendons are subject to losses due to curvature at the deviators. The component of friction due to curvature (angle change) is concentrated at the intersection of the segments. Hence the force distribution is represented by a series of sloping lines with steps at the discretization points.

Using this method, both the immediate prestress losses and the long-term losses are rigorously accounted for. With the iterative solution method employed in the nonlinear analysis, at each load step (construction stage) the prestress losses are adjusted based on the current prestressing force, deformation caused by subsequently stressed tendons, applied loads, creep, and shrinkage. The current prestressing force is then used to compute the equivalent forces which will in turn change the long-term losses.

Friction Losses

For post-tensioned members, tendons are usually anchored at one end and stretched with the jacks at the other end. As the steel tendon slides through the duct, frictional resistance is developed. The tension at the anchored end is less than the tension at the jack. The total friction loss is the sum of the wobble friction due to unintentional misalignment, and the curvature friction due to the intentional curvature of the tendon. These effects are considered separately and then combined. The following is the relationship between the jacking force and the reduced force due to friction at a distance on the tendon:

$$\ln(P_s/P_x) = Kx + \mu\alpha$$

where P_s is the prestress force at the jack and P_x is the reduced value at a distance x from the jack. K is the wobble coefficient. μ is the curvature friction and α is the change in angle.

External tendons are not subject to friction loss, and since they do not have curvature between deviators, loss due to angle change occurs only at deviators.

When using design codes that define friction loss differently, care must be taken to enter the wobble and curvature friction coefficients according to the formula definition above, which is based on AASHTO LRFD. For example, in CEB-FIP 90/2010 the wobble coefficient is multiplied with the curvature friction term, and to comply with these design codes the wobble coefficient times the curvature friction coefficient should be entered as the Wobble Coefficient input ($K=K \times \mu$) and the curvature friction coefficient should additionally be entered in the Curvature Friction Coefficient input (since the angle change effect is considered the same way in AASHTO LRFD and CEB-FIP 90/2010). (The design code choice for time-dependent analysis (page 261) does not affect the considered formula for the force loss due to wobble and curvature friction in LARSA 4D.)

AASHTO LRFD :

$$\Delta f_{pF} = f_{pj} (1 - e^{-(K \cdot x + \mu \cdot \alpha)}) \quad (5.9.3.2.2b-1)$$

CEB-FIP 90/2010 :

$$\sigma_{p0}(x) = \sigma_{p0,max} e^{-\mu(\alpha + k \cdot x)} \quad \begin{array}{l} (4.3 - 1) - \text{CEB-FIP 90} \\ (5.4 - 6) - \text{CEB-FIP 2010} \end{array}$$

Code-Based Friction Loss Formulas

Anchorage Slip Losses

In post-tensioned members, when the jacking force is released, the steel tension is transferred to the concrete by special anchorages. Inevitably, there is small amount of slip at the anchorages upon transfer, as the wedges seat themselves into the tendons or as the anchorage hardware deforms.

Losses due to anchor slip are computed and displayed along with short-term losses prior to an analysis.

Elastic Shortening of Concrete Losses

The stress loss in each tendon due to elastic shortening of concrete will depend on the total number of tendons in the concrete member and the sequence of stressing.

When the prestressing force is transferred to a concrete member, there will be elastic shortening of the concrete as it is compressed. For post-tensioned members having a single tendon, the elastic deformation of the concrete takes place when the jacking force is applied, and there is automatic compensation for elastic shortening loss, which therefore need not be calculated. If all the steel tendons in a post-tensioned beam are tensioned at the same time, there will be no loss due to elastic shortening.

However, for the common case where multiple tendons are used, with the tendons tensioned in sequence, there will be losses due to elastic shortening of the concrete. As each tendon is stressed, the compression in concrete members increases. The elastic shortening of the concrete due to the increase in compressive stress causes a loss of prestressing force in tendons which were previously stressed and anchored. For example, the first tendon will lose stress when the second is tensioned, and the first and second will lose stress when the third tendon is stressed. The elastic shortening loss is calculated for each tendon starting with the last tendon, for which there will be no loss due to elastic shortening.

This type of loss is included with long-term losses, calculated in the time-dependent staged construction analysis.

Other Losses

Creep and shrinkage of concrete and the application of other loads result in stress loss in post-tensioning. These are computed and accumulated through the Staged Construction Analysis.

Stress gain in post-tensioning due to the application of loading, which creates elongation in members, is also taken into account in the Staged Construction Analysis.

There is a gradual reduction of stress in post-tensioning resulting from relaxation even though the length of the tendon is held constant. The amount of relaxation depends on the intensity of steel stress as well as time.

Attributes

These properties are in the Tendons tab of the Geometry Spreadsheets, which is under the Input Data menu. Alternatively, double-click the name of the tendon in the tendons section of the Model Data Explorer [in *LARSA 4D User's Manual*].

Tendon Name

Names are assigned to identify tendons.

Design Group

This is a name assigned by the user and does not affect the analysis.

Material

The material (page 19) of the tendon.

Strand Area

Cross-sectional area of each strand.

of Strands

Total number of strands in the tendon.

Proposed Jacking Force

The proposed jacking force applied to the tendon from which the applied jacking forces are computed.

Applied Jacking Force (at Start/End)

The jacking force applied to the tendon in the analysis. It is automatically computed based on the proposed jacking force, anchor set, and peak stress ratios. This field must be manually updated by the Compute Jacking Force command (see below).

Jacking End

The application point or sequence of the jacking force: At Start, At End, or At Start Then End.

Anchor Set

The length of the anchor set.

Wobble Coefficient

The wobble coefficient. Wobble friction is due to unintentional misalignment. It is specified per unit length. External tendons may not have a wobble coefficient.

Curvature Friction Coefficient

The curvature friction coefficient, which is due to the intentional curvature of the tendon. This coefficient is unitless. Since external tendons may only have curvature at deviators, the wobble coefficient is only applied at deviators.

Peak Stress Ratio - Interior

The limiting stress for the interior points of the tendon as a proportion from 0.0 to 1.0 of the guaranteed ultimate tensile strength (GUTS) specified in the tendon's material, used to compute the Applied Jacking Force.

Peak Stress Ratio - Ends

The limiting stress for the start and end points of the tendon as a proportion from 0.0 to 1.0 of the guaranteed ultimate tensile strength (GUTS) specified in the tendon's material, used to compute the Applied Jacking Force.

Elongation

The elongation of the tendon after each pull and at each stationary, automatically computed by LARSA for informational purposes.

Path Geometry

Path geometry for a tendon is accessed from the tendons spreadsheet above by right-clicking a tendon and choosing *Edit Path & View*. Alternatively, right-click the name of the tendon in the tendons section of the Model Data Explorer [in *LARSA 4D User's Manual*] and choose the same command.

Paths consist of a list of *geometry points* that determine the points in space that the path follows. A path can contain any number of geometry points, and they are specified with reference to the member that the point falls within. The force in the tendon will be applied to the structure only within the members specified in the path.

By default, the path will consist of straight line segments connecting each of the geometry points. Parabolic, cubic, and circular curve fitting may be applied at geometry points to smooth out transitions between segments, as described below.

The following describes the data used to define each point in a path.

Point Type

Not every member that a tendon passes through will need a geometry point, but each member passed through must be specified in the path, in the order in which the tendon passes through them. For those members the tendon passes through but in which no geometry control point is needed, use the **path only** point type. Otherwise, use the **geometry** point type. The **span break** point type is not used for tendons.

Reference Object Type

Only the **member** option is applicable for tendons.

Reference Object or Range

- For geometry points, specify the ID of the member that this point is within. The offset coordinate for this point is specified in the local coordinate system of this member. Specify a range of IDs, such as *12-36*, or even *36-12*, to repeat this point for each member in the range, in the order specified.
- For path only points, specify an ID or range of IDs for the members that this point is acting as a placeholder for.

The remaining fields are for geometry point only.

Offset (X, Y and Z)

The offset of this point from some reference position within the member given above.

Offset directions are in the member's reference axis directions, rather than in global axis directions. The reference axis is generally the same as the member local axis, along the joint-to-joint line of the member. However, if member end offsets (page 61) or section centroid offsets (page 23) are applied to the member, the reference axis may not match either the joint-to-joint line or the member local axis. If there are member end offsets (page 61), the reference line follows the member local axis, shifted from the joint-to-joint line by the end offsets. The reference axis is not affected by section centroid offsets (page 23), which means the reference line is constant despite any nonprismatic variation in the section affecting the location of the centroid. If there are section centroid offsets (page 23), which do affect the member local axis, then the reference axis and the member local axis will not match.

The meaning of the x, y, and z offset fields depends on the choices made in the x, y, and z reference fields, described next. The **X** offset is specified in coordinate units, for convenience, while the **Y** and **Z** offsets are specified in section units.

X Reference

The position that the **X Offset** starts from.

Start: The **X Offset** is the x-distance from the start of the member, going toward the end of the member.

End: The **X Offset** is the x-distance from the end of the member, going toward the start. Positive values for **X Offset** are toward the start of the member.

Y Reference

The position that the **Y Offset** starts from.

+Y1 Local Edge: The **Y Offset** is the y-distance from the 1st stress recovery point of the member's section, which is generally used to specify the top of a member. Positive values are "down" into the member, in the negative-y direction. (Note that this differs from the **Z Offset**.)

Reference Line: The **Y Offset** is the y-distance from the reference line of the member, which is the joint-to-joint line of the member. For standard sections, the reference line is the same as the COG. Positive values are "up" or in the positive direction of the member y-axis.

-Y3 Local Edge: The **Y Offset** is the y-distance from the 3rd stress recovery point of the member's section, which is generally used to specify the bottom of a member. Positive values are "up" into the member, in the positive-y direction. (Note that this differs from the **Z Offset**.)

Z Reference

The position that the **Z Offset** starts from.

-Z3 Local Edge: The **Z Offset** is the z-distance from the 3rd stress recovery point of the member's section, which is generally used to specify the left side of a member. Positive values are "left" away from the member, in the negative-z direction. (Note that this differs from the **Y Offset**.)

Reference Line: The **Z Offset** is the z-distance from the centerline of the member (the center of gravity, generally speaking). Positive values are "toward the right" or in the positive direction of the member z-axis.

+Z1 Local Edge: The **Z Offset** is the z-distance from the 1st stress recovery point of the member's section, which is generally used to specify the right side of a member. Positive values are "right" away from the member, in the positive-z direction. (Note that this differs from the **Y Offset**.)

The figure below shows three geometry points in a tendon path. The first two points have X Reference set to "start", so their X Offset is the distance from the start of the member; for the third point, whose X Reference is "end", the X Offset is the distance from the end of the member. Each point also has a different Y Reference, changing how the Y Offset is applied.

Member Side View

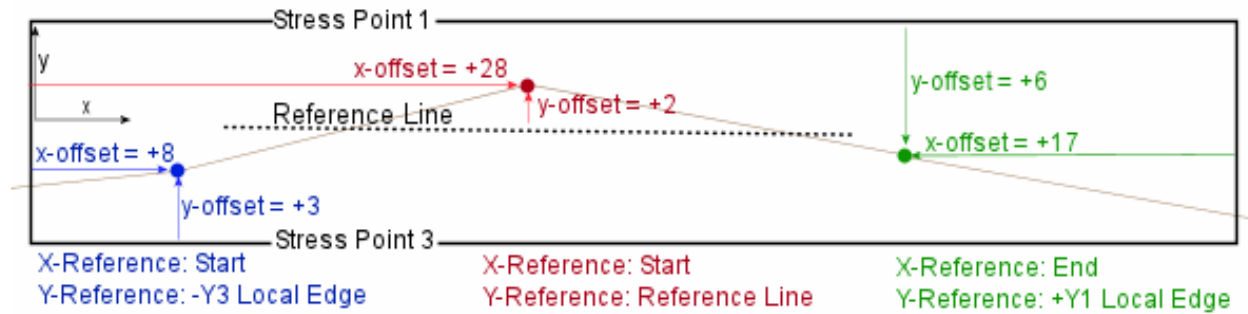

Using Offsets and References

In a nonprismatic section, the reference axis does not match the member local axis at the centroid. The figure below shows two geometry points and that they are offset perpendicularly from the joint-to-joint line of the member, which is the reference axis.

Member Side View - Nonprismatic Section

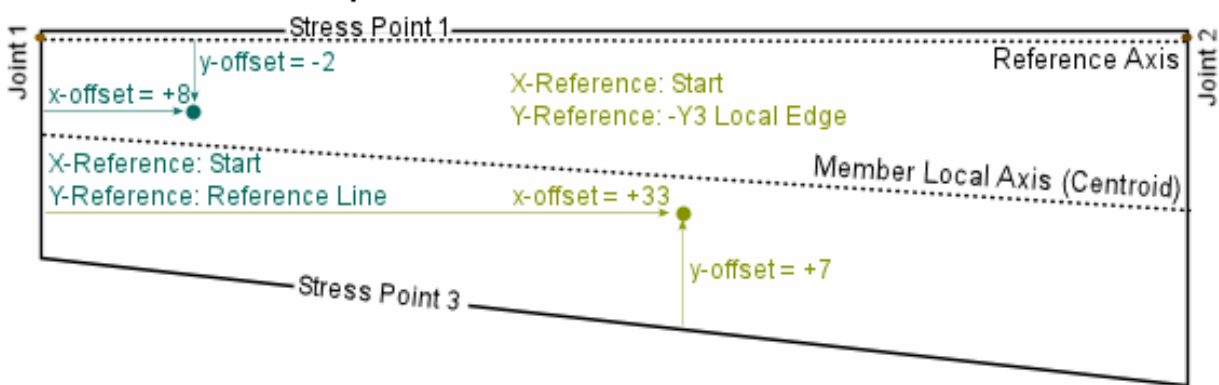

Offsets and Reference in a Nonprismatic Section

Curvature Type

Determines how curve fitting is applied at this point.

No Curve: No curve fitting will be used at this point. There will be a sharp corner at this point if the tendon turns.

No Curve

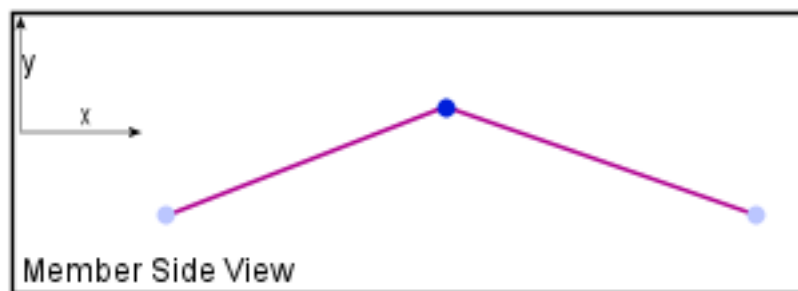

The "No Curve" Curve Type

Parabolic:

Parabolic curve fitting is used on either side of this point. The direction of a tangent line to the path at this point is specified as tangency angles in the XY and XZ planes of the member reference axis. Zero degrees specifies the curve's tangent at this point is parallel to the member reference axis.

Note that each segment between consecutive rows in the path spreadsheet is fit as a separate curve. Since each segment is between two points, and not three, LARSA 4D does not do the typical process of fitting a parabola between three points. Instead, it fits the curve between two points according to the tangent directions at each point. The largest curve that fits between the two points will be used. Two independent parabolic equations are solved in separate planes and then combined to produce the three-dimensional curve.

To solve the parabolic equation, the tangent lines must intersect. If no such point exists in one of the two planes, cubic curve fitting may be used in that plane. If no such point exists in either plane, cubic curve fitting will be used in an arbitrary plane instead.

Tangent directions perpendicular to the reference axis (plus or minus 90 degrees), or perpendicular to the lines connecting this point with the previous or next point, will not be accepted. To use parabolic curve fitting, specify the **parabolic** curve type for the two points on either side of the curve.

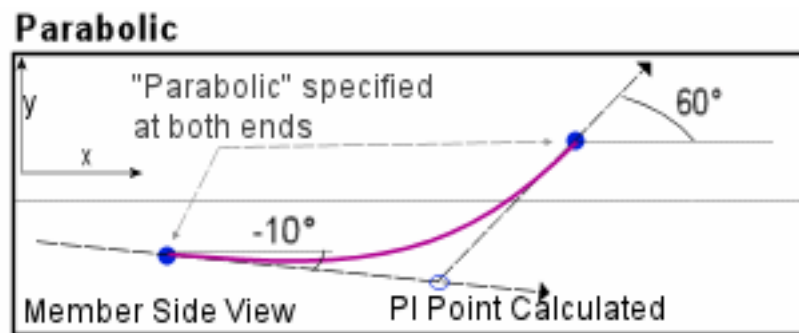

Parabolic Curve Fitting

Circular Radius.: A sharp corner at this point is smoothed using the arc of a circle. The radius of the arc is specified, and the tendon will not actually pass through this point. The coordinates of this point give the PI point (point of intersection) for the curve. The PT and PC points are automatically determined from the radius. This method is similar to parabolic curve fitting, except the PI point is given to determine the tangent directions, and the radius of the arc is given by the user. Circular radius curvature cannot be used at the start or end of a tendon path.

The circular arc is created in the plane defined by the PI point and the geometry points immediately before and after the PI point.

Circular Radius

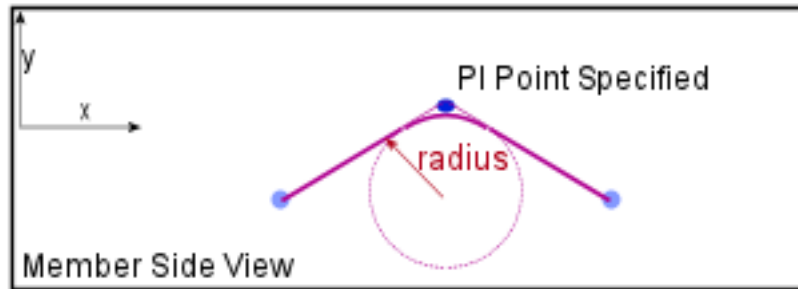

Circular Radius Curve Fitting

Cubic: Cubic curve fitting is used on either side of this point. The direction of a tangent line to the path at this point is specified as tangency angles as with parabolic curve fitting. Two independent cubic equations are solved in separate planes and then combined to produce the three-dimensional curve. To use cubic curve fitting, specify the **cubic** curve type for the two points on either side of the curve.

Cubic

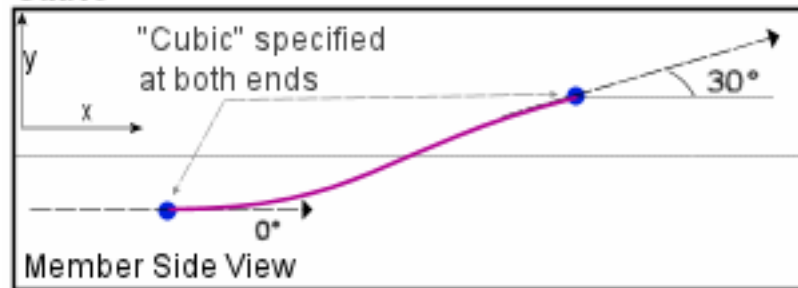

Cubic Curve Fitting

Example Path

The image below shows a tendon passing through five members. From members 1 to 3, the tendon is straight. From members 3 to 5, the tendon follows a parabolic curve. Three geometry points are used to create the path, the first two at the ends of the linear section, and the last two around the parabolic section.

Member Side View

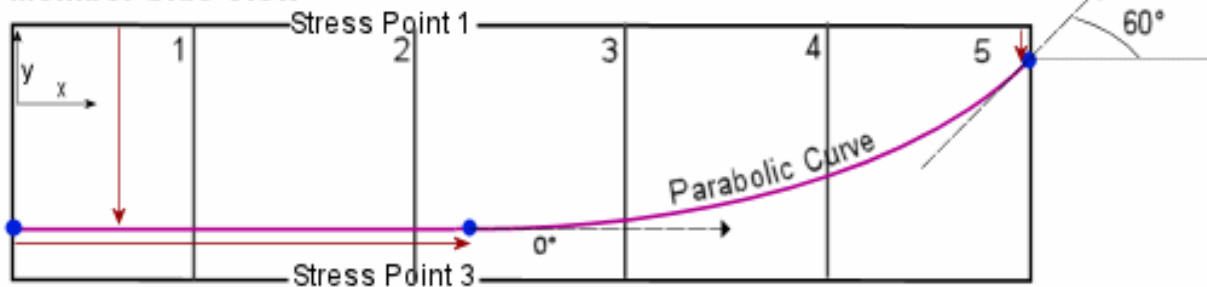

An Example Tendon Path

This tendon would be defined as follows. The Z offset, reference, and angle columns have been omitted for brevity. Note that members 2 and 4 are not relevant for the path geometry, but they are included at path points in the appropriate locations.

Point Type	Ref. Type	Ref. Object	Offset X	Offset Y	X Ref	Y Ref	Curve Type	Angle XY
geometry	member	1	0	8	Start	+Y1 Edge	No Curve	
path	member	2						
geometry	member	3	0	8	Start	+Y1 Edge	Parabolic	0
path	member	4						
geometry	member	5	0	2	End	+Y1 Edge	Parabolic	60

Additional Commands

Some additional related commands are available. These commands are used to modify input data or to access additional attributes of the data referenced above. The commands can generally be accessed in one of several ways.

In the Tendons spreadsheet, the commands are available in the Tendons menu, or by right-clicking the spreadsheet. Some commands can be applied to more than one row in the spreadsheet at once by selecting multiple rows before activating the command.

In the Model Data Explorer, change to the display for Tendons. Then right-click an object to get this list of commands. You can also apply the command to multiple at once by clicking on the first object, then holding the SHIFT key and clicking on the last object, and last right-clicking any of the to get the list of commands.

In the graphics window, activate the Pointer mouse tool from the toolbar, and then right-click an object in the graphical display to get the list of commands to apply to that object.

The additional commands are as follows:

Edit Path and View

This command opens a new spreadsheet window for editing the tendon path and a new graphics window for viewing the path.

Edit Material

This command opens the materials spreadsheet to the material assigned to the tendon.

Duplicate Tendon

This command duplicates the tendon.

Generate Equivalent Loads

This command creates a new load case (page 113) with equivalent member loads based on the forces in the tendon, including anchor set.

Generate Equivalent Loads (before Anchor Set)

This command creates a new load case (page 113) with equivalent member loads based on the forces in the tendon before anchor set is applied.

Compute Jacking Force

Based on the limiting peak stress ratio, proposed jacking force, and short term losses, the applied jacking force is computed. After changing any values that alter the computation of the applied jacking force, this command must be re-run.

The applied jacking force is determined as follows. The limiting force is calculated as the product of the peak stress ratio, material GUTS, strand area, and number of strands. The maximum proposed force is calculated as the maximum force in the tendon jacked with the proposed jacking force, immediately after anchor set. If the maximum proposed force does not exceed the limiting force, the applied jacking force is set to the proposed jacking force. Otherwise, the applied jacking force is taken as the proposed jacking force multiplied by the ratio of the limiting force to the maximum proposed force. This procedure is done twice, first using the interior peak stress ratio and the forces all along the tendon, then using the end peak stress ratio and only the force at the start and end of the tendon. The minimum of the two applied jacking forces found is used.

Mirror Y Offsets

This tool changes all y-offsets in the tendon path to the negative of the offset provided

Mirror Z Offsets

This tool changes all z-offsets in the tendon path to the negative of the offset provided

For More Information, please refer to the following documentation.

- For help on using spreadsheets, see Using the Model Spreadsheets in *LARSA 4D User's Manual*.

Lanes

Lanes define loading paths for vehicles in the moving load analysis (page 217) and for influence-based analysis (page 223).

A lane is a line or surface that travels through a structure. In moving load and influence analysis, the load pattern applied to the structure follows a defined lane path, starting at one end of the path and moving toward the other end. The path of a lane is determined by geometry control points between which straight lines or curves are fit.

Geometry control points are given as offsets relative to members or plates in the model. A lane's geometry points may reference either all members or all plates. When a lane is defined with reference to members, every member that the lane passes through must be present in the path. Loads will be applied directly to the members listed in the path, with added moment loads as needed if the lane does not follow the member centroid. If the path references plates, only plates containing geometry control points need to be included in the path. Loads will be applied to any plates that the path passes through.

For influence surfaces, the lane must be defined with reference to plates, and not members. Only in this case may a lane width be specified. For a standard moving load analysis and for influence line analysis when the lane reference members, the lane width is ignored for the purposes of the analysis. It may be used by design tools, however.

The type of vehicle to march on the lane is set independently of the lane definition. Use Moving Loads (page 133) or Influence Loads (page 135) to set vehicle parameters.

Basic Properties

These properties are in the Lanes tab of the Geometry Spreadsheets, which is under the Input Data menu. Alternatively, double-click the name of the lane in the lanes section of the Model Data Explorer [in *LARSA 4D User's Manual*].

Lane Name

A name is assigned by the user to identify the lane.

Lane Width

The width of the lane where loads can be positioned. This field is used only for influence surface analysis. Note that for influence surfaces, the lane path must reference only plates and not members, and must have a nonzero width.

Skew at Start/End

When the lane width is nonzero, skews the start and end of the lane so that the lane is trapezoidal rather than rectangular. The skew value represents the slope of the edge, with 0 being perpendicular to the direction of the lane and 1 being a 45-degree skew. To compute the skew, find the values of x and y in the figure below. The value of skew-at-start is x/y . In an influence-based live load analysis with UDL patch loading, skew-at-start and skew-at-end must be equal.

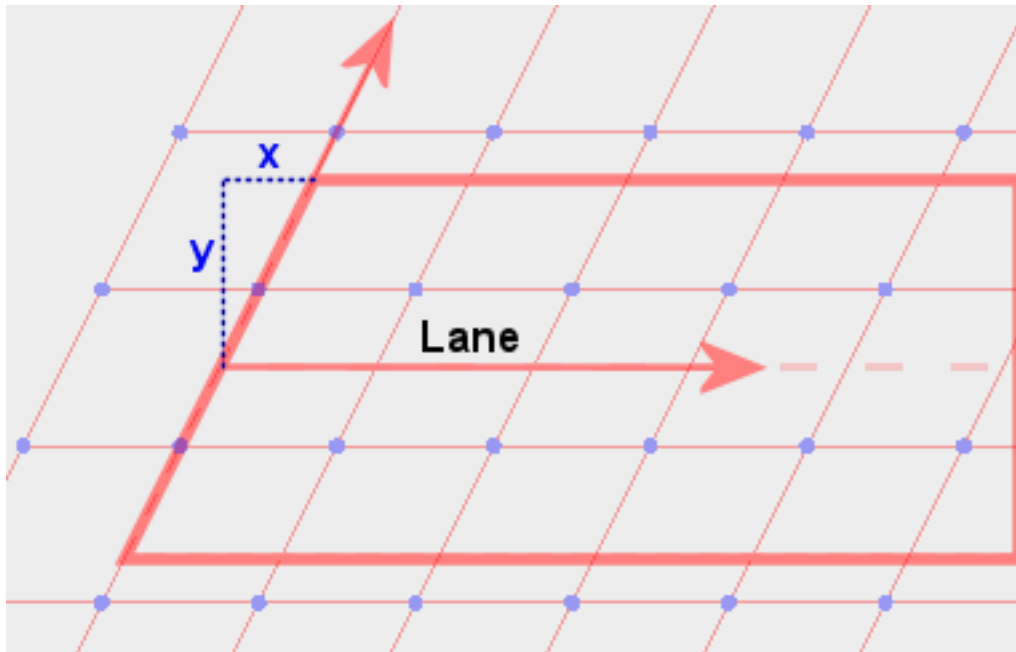

Skew at Start

Path Geometry

Path geometry for a lane is accessed from the lanes spreadsheet above by right-clicking a lane and choosing *Edit Path & View*. Alternatively, right-click the name of the lane in the lanes section of the Model Data Explorer [in *LARSA 4D User's Manual*] and choose the same command.

Paths consist of a list of *geometry control points* and *path-only points*. Geometry points determine the points in space that the path follows. A path can contain any number of geometry points, and they are specified with reference to the member or plate that the point falls within. Geometry points can be offset from member centroids to model lanes with eccentricity.

A path may reference either members or plates, but not both. When a path references members, it must list every member the path passes through in the right order. Although every member must be listed, there does not need to be a geometry control point in each member. For instance, a straight line lane needs only two geometry points, one at the start and one at the end, but must list every member that the lane passes through between the geometry points. Include those members with path-only points mixed in with the geometry points so that the members appear in the order in which the lane passes through them.

When a path is used to create an influence surface, bear in mind that the geometry of the surface (a rectangle in 3D space) is distinct from the set of plates to which influence surface unit loading will be applied. It is typically not necessary to list all of the plate elements to which influence surface loading will be applied in the path spreadsheet. LARSA 4D will automatically determine which plates to load. However, if the surface is elevated above the plate elements or if the model has other plate elements below the surface that do not intersect with the surface, then it may be necessary to list the plate elements that the influence surface loading should be applied to as path-only rows in the path spreadsheet. If no path-only rows are in the path spreadsheet, LARSA 4D may attempt to load any plate in the model that is close to the surface. If any path-only rows are given, then LARSA 4D will only attempt to load plates that are included in the path spreadsheet (either as geometry points or as path-only points).

The following describes the data used to define each point in a path.

Point Type

Not every member that a lane passes through will need a geometry point, but each member passed through must be specified in the path, in the order in which the lane passes through them. For those members the lane passes through but in which no geometry control point is needed, use the **path only** point type. Otherwise, use the **geometry** point type.

For lanes used for influence surfaces, if any path-only rows are given, then LARSA 4D will only attempt to load plates that are included in the path spreadsheet (either as geometry points or as path-only points). If no path-only rows are present, LARSA 4D may attempt to load any plate elements in the model.

The **span break** point type is a marker indicating that the lane has crossed into another span on a bridge, for design purposes. This does not affect the computation of the influence coefficients, but the location of span breaks are used in influence-based results (page 223) for compliance with the AASHTO LFD and BS5400 codes. The span break marker indicates that the previous geometry point gives the coordinates of the end of a span; thus, span break markers should immediately follow a geometry point positioned over a support.

Reference Object Type

Select whether this point references a **member** or **plate**.

Reference Object or Range

- For geometry points, specify the ID of the member or plate that this point is within. The offset coordinate for this point is specified in the local coordinate system of this member or plate. Specify a range of IDs, such as *12-36*, or even *36-12*, to repeat this point for each member or plate in the range, in the order specified.
- For path only points, specify an ID or range of IDs for the members that this point is acting as a placeholder for.

The remaining fields are for geometry point only.

Offset (X, Y and Z)

For geometry points, the offset of this point from some position within the referenced object. Offset directions are in the element's reference axis directions, rather than in global axis directions. The offset is by default relative to the start of the member or the I-joint of the plate. Y- and z-offsets in lanes on members will create moments. For influence surfaces, a z-offset will create a moment if the load direction is either Local X or Local Y.

Reference (X, Y and Z)

For points referencing members, set the X Reference to **End** to position the point relative to the end of the member. Positive values for X Offset are then toward the beginning of the member.

The y and z reference fields are not normally changed from **Reference Line** so that the y and z offset fields are in the member reference axes. See the documentation for tendon paths (page 95) for more on the other choices for the y and z reference fields.

By default, geometry points on members will fall at the start of the member on its reference line, which normally is at its centroid (except see section centroid offsets (page 23)). Loading at this position will be applied directly to the member without any eccentricity. To apply eccentricity, use the offset fields described above.

Points that reference plates by default will fall at the I-joint of the plate. Use the X and Y offsets, which are in the plate's local coordinate system, to position the geometry point.

The geometry points on the path will by default be connected by straight lines, meeting at hard corners if the lane turns. For descriptions of the curve fitting options, see the documentation for tendon paths (page 95).

Lane Path Example

A straight lane that passes through members 1 through 10 should be defined as follows:

Point Type	Ref. Type	Ref. Object or Range	Offset X	Offset Y	Offset Z	X Ref	Y Ref	Z Ref
geometry	member	1	0	0	0	Start	Reference Line	Reference Line
path	member	2-9						
geometry	member	10	0	0	0	End	Reference Line	Reference Line

Note that the last point has its X Reference set to **End** so that the lane goes through all of member 10, rather than stopping at its start joint.

If members 1 through 10 are on a curve, the lane above will not follow the curve. It will only be a straight line between the two geometry points defined. To have the lane follow the curve, there should be a geometry point at the start and end of every member. Without these geometry points, the lane will not exactly following the centroids of the members, leading to inadvertent eccentricities. That lane is defined as follows:

Point Type	Ref. Type	Ref. Object or Range	Offset X	Offset Y	Offset Z	X Ref	Y Ref	Z Ref
geometry	member	1	0	0	0	Start	Reference Line	Reference Line
geometry	member	2	0	0	0	Start	Reference Line	Reference Line
geometry	member	3	0	0	0	Start	Reference Line	Reference Line
...								
geometry	member	10	0	0	0	Start	Reference Line	Reference Line
geometry	member	10	0	0	0	End	Reference Line	Reference Line

Note that member 10 is referenced twice so that a point is placed at its start and end. This can be abbreviated as:

Point Type	Ref. Type	Ref. Object or Range	Offset X	Offset Y	Offset Z	X Ref	Y Ref	Z Ref
geometry	member	1-10	0	0	0	Start	Reference Line	Reference Line
geometry	member	10	0	0	0	End	Reference Line	Reference Line

Additional Commands

Some additional related commands are available. These commands are used to modify input data or to access additional attributes of the data referenced above. The commands can generally be accessed in one of several ways.

In the Lanes spreadsheet, the commands are available in the Lanes menu, or by right-clicking the spreadsheet. Some commands can be applied to more than one row in the spreadsheet at once by selecting multiple rows before activating the command.

In the Model Data Explorer, change to the display for Lanes. Then right-click an object to get this list of commands. You can also apply the command to multiple at once by clicking on the first object, then holding the SHIFT key and clicking on the last object, and last right-clicking any of the to get the list of commands.

In the graphics window, activate the Pointer mouse tool from the toolbar, and then right-click an object in the graphical display to get the list of commands to apply to that object.

The additional commands are as follows:

Edit Path and View

This command opens a new spreadsheet window for editing the lane path and a new graphics window for viewing the path.

Transfer to Plates

This command duplicates the lane and modifies all member-based geometry points in the path that fall within a plate element to reference the plate element instead. The offset fields are updated appropriately.

For More Information, please refer to the following documentation.

- For help on using spreadsheets, see Using the Model Spreadsheets in *LARSA 4D User's Manual*.
- Moving Loads on page 133.
- Influence Loads on page 135.
- Linear Static Moving Load Analysis and Dynamic Rolling Stock Analysis on page 217.

Loads

Structure loading is defined in load cases. There are several types of load cases, the most commonly used of which is the static load case. In static load cases, joint, member, plate, thermal, and other types of static loads can be applied to the structure. The other load case types include moving load cases, time history cases, and response spectra cases.

The type of analysis chosen determines how load cases are used. Static analyses (Linear Static Analysis (page 169), P-Delta Analysis (page 171), and Nonlinear Static Analysis (page 173)) require static load cases and load combinations of static load cases. Eigenvalue analyses (page 181) do not make use of load cases at all. The moving load analyses (Linear Static Moving Load Analysis and Dynamic Rolling Stock Analysis (page 217) and Influence Line & Surface Analysis (page 223)) require moving load cases with moving loads. The time history analyses (page 207) require a time history load case with time history excitation loads and, for some models, initial conditions.

The Response Spectra Analysis (page 187) can be performed with or without static load cases, but it requires a response spectra case with setup information.

In Staged Construction Analysis (page 247), static load cases are used to define the patterns of loading that will be applied on the structure at points throughout construction, but they are not applied to the structure until they are assigned to construction stages.

Static Load Cases	113
Static Load Types	113
Load Case Options	113
Additional Dynamic Mass	113
Load Combinations	115
Including Response Spectra Cases	115
Including Moving Load Cases	115
Use in Nonlinear Analysis	115
Self Weight	117
Weight Factor and Gravity Load Directions	117
Self Weight Computation	117
In Staged Construction Analysis	117
Joint Loads	119
Support Displacements	121
Member Loads	123
Member Thermal Loads	127
Load Input	127
Nonlinear Thermal Gradient Curves	128
Plate Loads	129

Plate Load Fields	129
Point Load Coordinates	130
Moving Loads	133
Influence Loads	135
Time History Loads	137
Excitation Functions	137
Initial Conditions	138

Static Load Cases

A static load case represents one scenario of static loading.

Static Load Types

The following loads may be applied in static load cases.

- Self Weight (page 117) for automatic computation of gravitational loading based on section and material properties of elements
- Joint Loads (page 119): Forces and moments applied at joints
- Support Displacements (page 121): Specified displacements at joints
- Member Loads (page 123): Point loads, uniformly or partially distributed loads, and triangular loads, and pre- and post-tensioning of members such as cables
- Member Thermal Loads (page 127): Uniform thermal loads for beam, truss, and cable elements, and thermal gradients for beam elements
- Plate Loads (page 129): Concentrated and uniform loads applied on plate and shell elements
- Thermal Plate Loads (page 129): Temperature change through the thickness of plate and shell elements resulting in uniform and thermal gradients

Load Case Options

Load cases can be marked *Inactive*. Inactive load cases are excluded from analysis runs.

Load cases can be assigned a load class, such as dead load, wind, and vehicular live load. These classes have been gathered from various codes and are used to pick out class-based results and to automate the process of creating class-based load combinations. Load classes can be chosen from the Load Cases Explorer [in *LARSA 4D User's Manual*]. To create code-based load combinations, the Automatic Code-Based Load Combinations [in *LARSA 4D User's Manual*] tool is useful. Class-based cumulative results can be obtained in the results spreadsheets [see "Results Spreadsheets" in *LARSA 4D User's Manual*] in staged construction analysis.

Additional Dynamic Mass

Load cases also have the option "Is Dynamic Mass?". This option affects the dynamic analysis types only, including eigenvalue, response spectrum, and time history. When this option is Yes, the loads in this case are treated as representing mass. All load cases with the option set to Yes are included as dynamic mass, in addition to any other mass specified in the model, in all dynamic analysis types.

In Staged Construction Analysis, eigenvalue and time history analysis scenarios will include the additional dynamic mass from all load cases in the project in which the Is Dynamic Mass? option is Yes. These load cases should therefore not be included in the construction sequence as loading activities.

Loads are converted into translational mass at joints according to the following rules:

- Joint loads create a mass at the selected joint. A force in any direction (F_x , F_y , or F_z) will create a mass of the same magnitude in all three translational directions. Therefore the desired mass is typically specified in F_z only, and F_x and F_y can be set to zero.
- Member loads on active members create mass at the joints at the ends of the member element. Point, uniform, and trapezoidal force loads in any direction create a mass equal to the total force applied, and the mass is apportioned to the two joints according to the location of the force on the element (for uniform loads, the mass is divided evenly between the two joints). The direction of the load has no effect. Member loads on inactive members and other types of member loads do not create mass.
- Plate loads on active plates create mass at the joints at the corners of the plate element. Point and uniform force loads in any direction create a mass equal to the total force applied, and the mass is divided evenly across the plate's joints. The direction of the load has no effect. Plate loads on inactive plates and other types of plate loads do not create mass.
- The Weight Factor properties of the load case does *not* create mass. To create additional mass proportional to an element's default mass, modify the element's unit weight.

For More Information, please refer to the following documentation.

- For help creating and editing load cases, see Load Cases Explorer in *LARSA 4D User's Manual*.
- For help on using spreadsheets, see Using the Model Spreadsheets in *LARSA 4D User's Manual*.
- Analysis Reference on page 163.

Load Combinations

Load combinations represent the combined application of load cases. They are defined before an analysis is run.

In a linear analysis, load combinations are computed by linearly combining the results of the static cases. However, in the nonlinear analysis types, load combinations are computed by analyzing the load combination's load cases consecutively, carrying the effect from each case into the next.

Load combinations are most often used for combining static load cases with other static load cases and combining static cases with seismic cases. They can also combine static cases with moving load cases, but the behavior of load combinations varies slightly when non-static load cases are included. Use Linear Result Combinations [in *LARSA 4D User's Manual*] to combine the results of a Time History Analysis with other results.

Load combinations can be analyzed in static, moving load, and response spectra analyses.

Each load case in a combination can be assigned a *Load Factor* which determines its contribution to the combination.

Load combinations are primarily needed for codes, to check or design the structure under various loading conditions. Linear Result Combinations [in *LARSA 4D User's Manual*] can also be used to combine results. Automatic Code-Based Load Combinations [in *LARSA 4D User's Manual*] can be used to automatically create code-based combinations.

Including Response Spectra Cases

Response Spectra Analysis (page 187) results generally do not have a sign convention. When an RSA case is included in any combination, its contribution is included with positive sign multiplied by the load factor.

To account for both the positive and negative directions of an earthquake, create two load combinations using the RSA case, one with a positive load factor for the RSA case and the other with a negative load factor.

Including Moving Load Cases

Up to two Linear Static Moving Load Analysis and Dynamic Rolling Stock Analysis (page 217) cases can be included in a Load Combination. If one moving load case is included in a combination, then LARSA creates a group of result cases, one for each generated case for the moving load case, each combining the effects of the static loads in the combination and the corresponding moving load result case.

If two moving load cases are included in a combination, then LARSA generates a group of generated load cases, one for each combination of a generated case from the first moving load case and a generated case from the second moving load case. If there are 1,000 generated cases in the first group and 1,000 in the second group, then one million cases will be generated. Because the number of generated load cases can quickly grow out of hand, using the Influence Line & Surface Analysis (page 223) is recommended instead.

Use in Nonlinear Analysis

In a nonlinear static analysis, load combinations are treated differently than in a linear static analysis, and their behavior can vary between analysis types.

Nonlinear Static Analysis (page 173)

Load cases within a Load Combination represent increments. The analysis is performed for each case in the combination as the load vector of the case multiplied by the corresponding load factor. The results of each increment are not saved and cannot be viewed later. Only the results after all cases have been applied are reported.

Nonlinear Buckling (page 197) **and Restart Analysis**

Load combinations themselves are treated as incremental load steps. Results are accumulated from one load combination to the next. Only static load cases can be included in the combinations.

For More Information, please refer to the following documentation.

- For help on using spreadsheets, see Using the Model Spreadsheets in *LARSA 4D User's Manual*.
- For help on using the Load Cases Explorer, see Load Cases Explorer in *LARSA 4D User's Manual*.
- Linear Result Combinations in *LARSA 4D User's Manual*.

Self Weight

The automatic computation of self-weight (gravity loading) can be included in static load cases (page 113) by specifying a weight factor in the direction of gravity. The weight factor for X, Y and Z are specified with the load case description data.

Weight Factor and Gravity Load Directions

The gravity load directions are the directions of the Global Coordinate System. A positive factor implies that self-weight is acting in the positive direction of the axes. A negative factor implies that self-weight is acting in the negative direction.

The user may choose to apply the gravity loading in one direction at a time or in any combination of X, Y and Z directions.

A value of -1.00 for Weight Factor Z would instruct the program to apply 100 percent of the computed self weight of the structure in the negative Z-axis direction, which properly simulates gravity for a structure where the Z-axis is up. A value of 1.00 for Weight Factor X and 0.50 for Weight Factor Y would instruct the program to apply 100 percent of the computed self weight in the direction of X-axis and 50 percent in the direction of Y-axis simultaneously.

The self weight factors are used in static analyses only. For dynamic analysis, the mass due to the weight of an element is computed and applied automatically in all translational directions X, Y and Z when the weight density of the material is specified as nonzero. See also Mass elements (page 91). You can create additional mass with the dynamic mass option on static load cases (page 113).

Self Weight Computation

The weight of members (page 61) are computed using the cross sectional area, element length and weight density. The weight of plates (page 75) are computed using the element volume and the weight density.

The self-weight of beam elements are modeled using uniformly distributed loads. This approach generates a consistent load vector considering the bending and shear effects due to the self-weight. The program computes the equivalent uniform load using the gravitational factors, direction, section area and weight density. Nonprismatic members use the average of the cross-sectional area at the member ends.

For plates, self-weight is computed based on material weight and thickness. Uniform pressure loads are used.

Springs, isolators, and tendons do not contribute to the weight of the model.

In Staged Construction Analysis

In a Staged Construction Analysis (page 247), self-weight loading must be applied to include the self-weight of elements in the analysis. Place a load case with self-weight turned on in every step in which new elements are constructed if self-weight is desired for those elements.

Self-weight load cases only apply self-weight to elements constructed in the same construction step as the self-weight load case. Therefore you must place a self-weight load case in the same construction step in which elements are constructed.

If a self-weight load case is placed in a construction step without a construction activity, self-weight loading will be applied (possibly again) to all elements in the model constructed up to that point.

To omit self-weight for elements in Staged Construction Analysis, there are two options. You may omit the self-weight load case in the construction step in which the elements are constructed. Alternatively, you may construct the elements with the stiffness-only option. In the Construction Stages Explorer [in *LARSA 4D User's Manual*] right-click the structure group of elements and choose Stiffness Only. With this option, self-weight will be skipped even if a self-weight load case is present.

When a dynamic analysis is performed as an analysis scenario (page 161) in Staged Construction Analysis, element mass is computed automatically for elements constructed normally. Elements constructed with the stiffness-only option will not have mass. (If an element is constructed normally, that is with stiffness and weight, but a self-weight load case is not applied, mass will still be included.)

For More Information, please refer to the following documentation.

- For help on using spreadsheets, see Using the Model Spreadsheets in *LARSA 4D User's Manual*.

Joint Loads

Joint loads can be applied at the joints of the structure. The applied forces are specified in the displacement coordinate system of the joint, which is by default the Global Coordinate System.

Multiple joint loads can be applied to the same joint in a load case.

Joint loads are static loads and are applied in static load cases (page 113).

Joint

The ID of the joint to which this joint load will be applied.

Force X/Y/Z

The applied translational force in the joint's displacement coordinate system.

Moment X/Y/Z

The applied moment in the joint's displacement coordinate system.

If the joint is assigned a cylindrical coordinate system, the X, Y, and Z components of the load correspond to the R, Theta, and Z axes of the UCS. Specifying an x-component results in a load directed radially from the center of the UCS, with positive loads directed away from the origin. Specifying a y-component results in a tangentially-directed load, with positive loads directed counter-clockwise about the origin.

If the joint is assigned a spherical coordinate system, the X, Y, and Z components of the load correspond to the R, Phi, and Theta axes of the UCS. Specifying an x-component results in a load directed radially from the center of the UCS, with positive loads directed away from the origin. Specifying a y- or z-component results in a tangentially-directed load in the phi and theta directions, respectively.

For More Information, please refer to the following documentation.

- For help on using spreadsheets, see Using the Model Spreadsheets in *LARSA 4D User's Manual*.
- Joints on page 59.

Support Displacements

Support displacement loads can be applied at the joints of the structure. The applied displacements are specified in the displacement coordinate system of the joint, which is by default the Global Coordinate System.

Support displacement loads can only be applied to joints in degrees of freedom that are fixed at the joint. If a support displacement load in any load case is applied to a joint in a direction in which the joint is not restrained, the joint will become restrained in that direction in all load cases in the project.

Support displacement loads are static loads and are applied in static load cases (page 113). A joint can have only one support displacement in a load case.

Support displacements are also referred to as support settlements and joint displacement loads.

Joint

The ID of the joint to which this joint load will be applied.

Translation X/Y/Z

The translational displacement in the joint's displacement coordinate system.

Rotation X/Y/Z

The rotational displacement in the joint's displacement coordinate system.

For More Information, please refer to the following documentation.

- For help on using spreadsheets, see Using the Model Spreadsheets in *LARSA 4D User's Manual*.

Member Loads

Member loads encompass a wide range of loads that can be applied to members, including concentrated forces and moments and distributed forces and moments.

Member loads can be in local coordinate system directions of the member (see Members (page 61)) or in global coordinate system directions. Distributed loads are specified as a force (or moment) per unit length along the member. These loads are positive when acting in the positive direction of the specified axis. The loads act on the centroid axis of the member.

Distributed loads acting in global coordinate system directions can also be specified per “projected” unit of length, i.e. according to the length of the member when projected on the plane perpendicular to the load.

Because truss and cable elements have only axial stiffness, laterally applied loads are transferred to the joints the member is connected to, unlike in beam elements for which the fixed-end-force concept is used.

Multiple member loads may be applied to the same member in a load case.

Member

The ID of the member to which the load will be applied.

Type

The type of the load.

- **Point Force/Point Moment** - A force or moment applied at a single point on the member.
- **Uniform Force/Moment** - A uniform force or moment applied along a part or all of the length of the member.
- **Trapezoidal Force/Moment** - A force or moment applied along a part of the length of the member with varying magnitude at the beginning and at the end of the applied load.
- **Pre-Tension** - This load type is typically used with cable elements in Nonlinear Static and Staged Construction Analysis but can also be used with truss and beam elements. The pre-tension load is an additional initial cable force at the beginning of the analysis step, but the force in the cable may be reduced or increased due to applied loads or other structural changes as they are applied. (Pre-tension can also be specified on the members spreadsheet for other analysis types or in Staged Construction Analysis when it applies at initial conditions.)
- **Post-Tension** - This load type is typically used with cable elements and can be used in Nonlinear Static and Staged Construction Analysis. The post-tension load specifies a target force for the cable at the end of the load case or construction step. The rest of the structure may adjust to keep the cable force constant at the specified magnitude (within a tolerance) during the load case or construction step, simulating a jacking operation.
- **Jacking Elongation** - This load type is typically used with cable elements and can only be used in Nonlinear Static and Staged Construction Analysis to simulate the jacking operation in cable tensioning. The jacking elongation load specifies the change in the length of the member.

Direction

Loads can be applied in the local or the global coordinate system. Positive magnitude loads are in the direction of the positive axis selected. Specify negative magnitudes to apply the load in the negative axis direction.

Local X/Y/Z. The load acts in the direction of the local axis of the member.

Global X/Y/Z. The load acts in the direction of the global axis.

Projection on Global X/Y/Z. Applies to uniform or partially distributed loads. The direction of the load is in the direction of the global axis, and the magnitude of the load is measured per projected length. The projected length is in the plane perpendicular to the direction of loading.

The direction is not applicable for pre/post-tension loads or jacking elongation, which are applied axially.

Magnitude at Start

For point and uniform loads, the magnitude of the load. For trapezoidal loads, the magnitude at the beginning of the load application. For point loads, pre-tension, and post-tension loads, the magnitude is given in force (or moment) units. Uniform and trapezoidal loads are given as a force (or moment) per unit length. Jacking Elongation loads are given as an elongation length.

Magnitude at End

For trapezoidal loads, the magnitude at the end of the load application. Not applicable for other load types.

Start Position

For point loads and pre-/post-tension loads, the location of the load. For distributed loads, the location of the start of the load application. Specified relative to the member length (e.g. 0.0 is the start of the member at the I-Joint and 1.0 is the end of the member at the J-Joint), or in absolute length units, measured along the length of the member. If the member has an end offset, the position is not measured from the joints but instead from the offsetted end positions.

End Position

For distributed loads, the location of the end of the load application, specified in the same way as the Start Position, relative to the start of the member. Not applicable for other load types.

Shortening

The shortening length. Only applicable for Jacking Elongation loads.

Additional Commands

Some additional related commands are available. These commands are used to modify input data or to access additional attributes of the data referenced above. The commands can generally be accessed in one of several ways.

In the Member Loads spreadsheet, the commands are available in the Member Loads menu, or by right-clicking the spreadsheet. Some commands can be applied to more than one row in the spreadsheet at once by selecting multiple rows before activating the command.

The additional commands are as follows:

Enter Absolute Positions

Choosing this option sets the start and end position fields to use absolute length units. 0.0 represents the start of the member, and the length of the member is used to give the position at the end of the member.

Enter Relative Positions

Choosing this option sets the start and end position fields to use relative units. 0.0 represents the start of the member, and 1.0 represents the end of the member.

For More Information, please refer to the following documentation.

- Members on page 61.
- For help on using spreadsheets, see Using the Model Spreadsheets in *LARSA 4D User's Manual*.

Member Thermal Loads

The loading due to temperature change in a member can be specified using Member Thermal Loads.

With uniform thermal loading, a constant temperature change is applied to the entire member cross-section. Uniform thermal loading normally produces axial strain only. Linear and nonlinear thermal gradients create a temperature change that is uniform along the length of the member but that varies either from section top to bottom or from section left to section right. All thermal loads are constant along the length of the member.

When applied to composite sections, thermal loading will use the material assigned to each shape in the section if a material is assigned to section shapes. If either the material modulus of elasticity or coefficient of thermal expansion differ between shapes in the section, rotational strain may result and self-equilibrating stresses (also known as eigenstresses) will be accumulated and included in member stress results (page 289). Nonlinear thermal gradients may also create self-equilibrating stresses that will be included in member stress results. (Prior to LARSA 4D version 8, the material assigned to the member was assumed constant throughout the cross-section and, therefore, no self-equilibrating stresses were possible. Nonlinear thermal gradients became available in LARSA 4D version 8.)

For linear and nonlinear thermal gradients, temperature change is specified at (or, for nonlinear thermal gradients, relative to) the + y/z and - y/z edges of the member cross-section. The location of the + y/z and - y/z edges are determined by the maximum and minimum y and z coordinates of the points that define the section geometry of the member (either from Section Composer or section dimensions (page 23)). If a member has no section geometry (i.e. its section has Unspecified shape, see Section Dimensions (page 23)), the first and third section stress recovery points (page 23) determine the section extents instead. (Prior to LARSA 4D version 8, the first and third stress recovery points were always used to determine the section positive and negative extents, respectively.)

Nonlinear thermal gradients must be used with sections that have geometry either from Section Composer or section dimensions (page 23) because the results depend on the distribution of mass in the cross-section.

The coefficient of thermal expansion specified in the material data of the element (or shapes) must have a nonzero value, otherwise there will be no thermal effects for the element. Only uniform thermal loads should be applied to truss and cable elements.

Multiple member thermal loads can be applied to a member in a load case.

Load Input

Member

The ID of the member to which the load will be applied.

Type

The type of the load: Uniform, Linear, or Nonlinear.

Variation Direction

For linear or nonlinear gradient thermal loading, specifies whether the variation changes along the local-y or local-z axis of the member.

Temperature Change at Top

For uniform loads, specifies the change in temperature. For linearly varying loads, specifies the temperature change at the top edge (+y) or right edge (+z) of the member. Not applicable for nonlinear gradients.

Temperature Change at Bottom

For linearly varying loads, specifies the temperature change at the bottom edge (-y) or left edge (-z) of the member. Not applicable for uniform loads or nonlinear gradients.

Nonlinear Temperature Curve

Specifies the nonlinear temperature curve to apply. Create a curve in the **Input Data** → **Properties** → **Temperature Curve** spreadsheet first.

Nonlinear Thermal Gradient Curves

Nonlinear thermal gradient curves are entered in a spreadsheet located at **Input Data** → **Properties** → **Temperature Curve**. Add a row to this spreadsheet and name the curve. Then right-click the spreadsheet and choose **Edit Curve**.

Add rows to this spreadsheet to specify location and temperature change values on the curve.

Temperature Change

Each temperature value is specified in load-temperature units (see Model Units [in *LARSA 4D User's Manual*]). It is the temperature change at a location in the cross-section.

Location Reference

The location of each temperature coordinate is specified in one of four ways: + Edge indicates the location is measured from the extreme +y or +z fiber (depending on the Variation Direction specified in the load spreadsheet). - Edge indicates the location is measured from the extreme -y or -z fiber. In both cases positive values are toward the centroid. Rel. indicates that the location is specified relative to the member depth or width in the range from 0.0 to 1.0. Abs. indicates the location is specified in section length units. For instance, using the + Edge, Rel. option, the value 0.0 indicates the top or right edge of the section and 0.25 specifies a location 1/4th the way into the section from the top or right. Or, using the - Edge, Abs. option, the value 0.0 indicates the bottom or left edge of the section and 5.8 specifies a location 5.8 section units into the section measured from the left or bottom.

For More Information, please refer to the following documentation.

- Sections on page 23.
- Members on page 61.
- For help on using spreadsheets, see Using the Model Spreadsheets in *LARSA 4D User's Manual*.

Plate Loads

Uniformly distributed pressure loads, concentrated point forces, thermal loads, and strain loads can be applied to plates.

To apply a uniform pressure load, a point force load, or a strain load, use the Type, Direction, and Load fields. Keep the Uniform Temperature Change and Temperature Gradient fields as zero.

To apply a thermal load, use the Uniform Temperature Change and Temperature Gradient fields. The Load field should be kept as zero so that the Type and Direction fields are not used. Alternatively, a thermal load can be combined with another type of load by using all five fields.

Temperature loads on plates can be specified as a uniform change or as a linear temperature gradient through the thickness of the element. The temperature effects are constant over the lateral directions of the element. The coefficient of thermal expansion specified in the material data of the element must have a nonzero value, otherwise there will be no thermal effects. Uniform temperature loading causes in-plane (lateral) expansion. Temperature gradient loading causes out-of-plane bending only. Uniform temperature loads and temperature gradient loads can be combined.

Multiple plate loads can be applied to a plate in a load case.

Plate Load Fields

Plate

The ID of the plate to which the load will be applied.

Type

The type of the load.

- **Uniform Force** - A uniform force applied on the surface of the element.
- **Point Force** - A force applied at a single point on the element.
- **Strain** - A strain added to the element. Available starting in version 8.01.

Direction

Uniformly distributed loads can be specified in the local coordinate directions of the plate or in the Global Coordinate System directions, or as projected loads in the Global Coordinate System directions. Point loads can be specified in the local coordinate directions of the plate or in the Global Coordinate System directions. Strain loads can be applied in the local x or y directions only. Positive magnitude uniform and point force loads are in the direction of the positive axis selected and for strain loads are tensile.

Local X/Y/Z. The load acts in the direction of the local axis of the plate.

Global X/Y/Z. The load acts in the direction of the global axis.

Projection on Global X/Y/Z. Applies to uniform loads. The direction of the load is in the direction of the global axis, and the magnitude of the load is measured per projected area. The projected area is in the plane perpendicular to the direction of loading.

Load

The magnitude of the pressure, force, or strain. For uniform loads, the load is constant throughout the plate. Not used for thermal loads.

Relative X Location (x/XL)

For point loads, the relative distance of the load with respect to the I-J or K-L sides of the element, as explained below.

Relative Y Location (x/XL)

For point loads, the relative distance of the load with respect to the J-K side of the element for quadrilateral plates and with respect to the local y-axis for triangular plates, as explained below.

Uniform Temperature Change

The uniform temperature change through the thickness of the element. Positive values are an increase in temperature by that many degrees.

Temperature Gradient

The temperature change per unit of length measured perpendicular to the plate, i.e. through the thickness of the element. Positive values mean the top (+z side) is subject to a temperature increase while the bottom (-z side) is subject to a temperature decrease. The middle of the plate (z=0) has no temperature change. For example, if a plate 3 inches thick is given a 1 degree/inch temperature gradient, it experiences a 1.5 degree temperature increase at its top surface, no temperature change through its midplane, and a -1.5 degree temperature change at its bottom surface. Entering both a uniform temperature change and a temperature gradient applies a linear gradient with a non-zero temperature change through the element's midplane. For example, a 10 degree uniform temperature change combined with a 1 degree per inch temperature gradient applied to the same 3 inch thick plate creates a 11.5 degree temperature increase at the top surface, a 10 degree temperature increase at the midplane, and a -8.5 degree temperature change at the bottom surface.

Point Load Coordinates

The locations of point force loads on plates are specified in a special coordinate system which is neither the global nor plate local coordinates. The choice of coordinate system is intended to simplify the specification of the location so that the x- and y-coordinates are both in the range [0, 1].

For quadrilateral plates, the load coordinates of the four corners of the plate from I to L are (0,0), (1,0), (1,1), (0,1). For rectangular plates, the load coordinates are simply scaled plate local coordinates. For irregularly shaped plates, the load coordinates are essentially warped to fit in the quadrilateral shape. See the following figure:

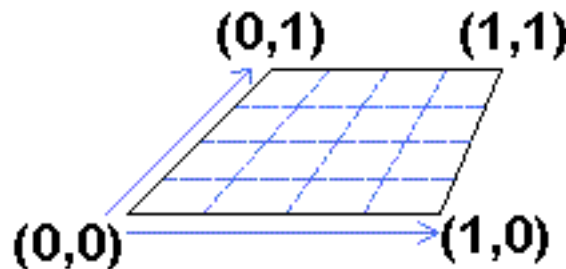

Load coordinate specification for quadrilateral plates

(I-, J-, K-, and L-joints refer to the first, second, third, and fourth joints, respectively, that define the plate geometry in the plates spreadsheet (page 75).)

The load location specification for triangular plates is on a scaled local coordinate system, as with perfectly rectangular plates. The load coordinates of the three corners of the plate from I to K are (0,0), (1,0), and (q,1), for some q. For triangular plates, unlike quadrilateral plates, not every coordinate with components in the range [0, 1] will actually fall within the plate area. The coordinate grid for load specification on triangular plates is shown below:

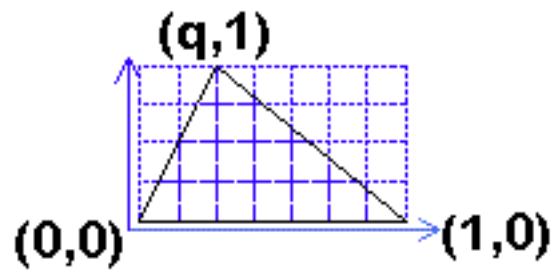

Load coordinate specification for triangular plates

For More Information, please refer to the following documentation.

- Plates on page 75.
- For help on using spreadsheets, see Using the Model Spreadsheets in *LARSA 4D User's Manual*.

Moving Loads

Moving loads are added into moving load cases for the Linear Static Moving Load Analysis and Dynamic Rolling Stock Analysis (page 217). These loads specify how to generate the result cases for a vehicle moving on a user-defined path (lane) on a structure.

The analysis requires a database file containing the load patterns [see “Connecting Databases” in *LARSA 4D User’s Manual*], geometry definition of lanes (page 105), and load cases in which the user can specify the load pattern, the loaded lane and related data for a traveling load pattern.

A single load case with multiple moving loads simulates the simultaneous marching of the loads. Multiple load cases can be used to simulate multiple independent vehicles on the same lane or multiple lanes.

Moving load cases can be combined with static load cases, response spectra cases, and with other moving load cases. Combinations can be made within the analysis using Load Combinations (page 115) or after the analysis using Linear Result Combinations [in *LARSA 4D User’s Manual*].

Lane Loaded

The lane (page 105) on which the load pattern will be marching.

Load Pattern

The load pattern to march on the lane. All load patterns from connected moving load pattern databases are available to choose from. See Connecting Databases [in *LARSA 4D User’s Manual*].

Applied Load Direction

The direction of the load application. The direction can be in the local coordinate systems of the members the lane passes through, or in global directions. Positive magnitude loads are in the direction of the positive axis selected.

Load Factor

A factor to scale the load pattern. The default is 1.0.

Direction of Travel

The load pattern can march forward on the lane or backward. In Static Moving Load Analysis, both means first forward then backward.

Position Increment

The distance between each successive position of the load pattern as it marches along the lane. Smaller increments will generate more result cases but may be more informative and accurate. Static Moving Load Analysis only.

Vehicle Speed

The speed of the vehicle as it moves along the lane. Dynamic Rolling Stock Analysis only.

Start Position

The starting position of the load, measured in length units along the lane from the start of the lane. 0.0 is the start of the lane.

For More Information, please refer to the following documentation.

- For help on using spreadsheets, see Using the Model Spreadsheets in *LARSA 4D User's Manual*.
- Lanes on page 105.
- Standard Vehicles on page 219.
- Linear Static Moving Load Analysis and Dynamic Rolling Stock Analysis on page 217.
- Connecting Databases in *LARSA 4D User's Manual*.
- Influence Loads on page 135.

Influence Loads

Influence loads are added into moving load cases for the Influence Line & Surface Analysis (page 223). These loads specify how to generate the result cases for a unit load moving on a user-defined path or surface.

The analysis requires the geometry definition of lanes (page 105) and load cases in which the the loaded lane and related data for a traveling load pattern are specified.

Generally speaking, a separate moving load case is required for each lane or surface to be considered. In each load case, a single influence load is applied to that lane.

In some circumstance, it may be appropriate to apply two or more simultaneous influence loads in a single moving load case. To simulate the distribution of vehicle axle loads onto multiple girders in an influence line analysis, you may place multiple influence loads within the same moving load case, each influence load applied to a lane on a different girder, so long as the factors sum to 1.0 and the lanes are of the same length. In an influence line or influence surface analysis, you may combine dead load (in global -Z), centrifugal (local +y), or braking (local +x) forces in one case by including multiple influence loads within the same moving load case, each in a different direction.

Lane Loaded

The lane (page 105) on which the unit load will be marching. If the lane is defined with reference to members, it is a linear path for an influence line. If the lane is defined with reference to plates, it is a surface for an influence surface analysis and width should be specified for the lane.

Applied Load Direction

The direction of the load application. The direction can be in the local coordinate systems of the members or plates the lane passes through or in global directions. Local directions are recommended. When the lane includes offsets from the member centroid (such as for live load centrifugal and braking forces conditions), local directions must be used. Moments due to the offset will not be created when the applied load direction is in a global direction. Positive magnitude loads are in the direction of the positive axis selected.

Load Factor

A factor to scale the unit load. The default is 1.0.

Forward Increment

The distance between each successive position of the load pattern as it marches along the lane. In an influence surface load case with simultaneous loads, the forward increment of the first influence load will be applied to all influence loads in the load case.

Transverse Increment

Used for influence surfaces only. The transverse distance between lateral strips used to approximate the surface. The transverse increment must divide the lane width evenly; if it does not, LARSA will round-up the increment. A transverse increment of zero instructs LARSA to choose a sensible increment based on the forward increment. In an influence surface load case with simultaneous loads, the transverse increment of the first influence load will be applied to all influence loads in the load case.

Smaller increments will generate more result cases but may be more informative and accurate.

For More Information, please refer to the following documentation.

- For help on using spreadsheets, see Using the Model Spreadsheets in *LARSA 4D User's Manual*.

- Lanes on page 105.
- Standard Vehicles on page 219.
- Linear Static Moving Load Analysis and Dynamic Rolling Stock Analysis on page 217.
- Influence Line & Surface Analysis on page 223.

Time History Loads

Time history loads include Applied Excitation Functions and Initial Conditions. They are applied in time history load cases for the Linear Time History Analysis (page 207) and Nonlinear Time History Analysis (page 211).

Excitation Functions

There are three types of excitation functions:

1. Uniform base excitations, which must be acceleration functions, are applied to all free joints in the model. Fixed joints represent the ground.
2. Joint-localized excitations are applied in a single direction at a joint. Displacement excitation functions are applied to joints fixed in the direction of the excitation function, while force and acceleration excitation functions are applied to joints free to move in the direction of the excitation function. Multiple excitation functions can be simultaneously applied to achieve an excitation in more than one direction at the same joint, or at more than one joint.
3. A static load case containing joint, member, and plate loads can be chosen in conjunction with a “factor” excitation function. The “factor” function is unitless and is applied as a scale factor to the loads in the static load case in each time step. Joint loads, member force, moment, and self-weight loads, and plate force and self-weight loads can be used. An “inconsistent load vector” method is used, meaning element loads are transferred to joints and element-internal forces (such as Member Sectional Forces (page 287) and Plate Forces on Center (page 303)) will not account for these loads. Static load case excitations are available starting in version 8.01.

When an acceleration excitation curve is chosen, whether for a uniform base acceleration or as a joint-localized excitation, an equivalent force is applied at applicable joints computed as the acceleration multiplied by the mass at the joint. The mass is the sum of the mass due to elements connected to the joint (computed in the same way as self-weight (page 117)), mass specified on a mass element (page 91) at the joint (in the applied direction of the excitation function), and equivalent mass specified in load cases (page 113) with the Is Dynamic Mass option turned on.

Before entering the load data for a time history excitation, a database file containing the time history excitation curve must be connected to the project. See Connecting Databases [in *LARSA 4D User's Manual*].

The time history excitation loads spreadsheet has the following fields:

Time History Curve

The time history excitation curve to be applied, selected from all of the time history curves in databases connected to the project. A displacement, force, acceleration, or factor function can be chosen.

Joint ID

The ID of the joint to which a joint-localized excitation will be applied. For a uniform base excitation, enter zero. This field is not applicable for static load case excitations.

Applied Direction

The direction of the applied displacement, force, or acceleration: translation x, y, or z or rotation x, y, or z. The excitation function is applied in joint displacement coordinate system directions, which is by default the Global Coordinate System. This field is used with uniform base excitations and joint-localized excitations but not factored static load case excitations.

Static Load Case

When a “factor” excitation function is used as the time history curve, any Static Load Case (page 113) can be chosen to apply factored loads in each time step.

Initial Conditions

Initial conditions are for initial nonzero displacements, velocities, and accelerations. When no initial conditions are specified, the structure is assumed at rest initially.

The following data is used for initial conditions:

Joint

The ID of the joint for which this initial condition applies.

Displacement

The initial displacement of the joint.

Velocity

The initial velocity of the joint.

Acceleration

The initial acceleration of the joint.

Direction

The direction of the specified displacement, velocity, and acceleration. May be translational or rotational in x, y, or z. The directions are in the joint's displacement coordinate system.

Additional Commands

Some additional related commands are available. These commands are used to modify input data or to access additional attributes of the data referenced above. The commands can generally be accessed in one of several ways.

In the Time History Excitations spreadsheet, the commands are available in the Time History Excitations menu, or by right-clicking the spreadsheet. Some commands can be applied to more than one row in the spreadsheet at once by selecting multiple rows before activating the command.

The additional commands are as follows:

Add Excitation for Selected Joints

This command adds excitation records to the active load case for every selected joint.

For More Information, please refer to the following documentation.

- For help on using spreadsheets, see Using the Model Spreadsheets in *LARSA 4D User's Manual*.
- Linear Time History Analysis on page 207.
- Nonlinear Time History Analysis on page 211.
- Connecting Databases in *LARSA 4D User's Manual*.

Construction Activities

In the Staged Construction Analysis, changes to the structure are modeled as construction activities. Data input for construction activities is described in this section.

Construction activities are used in the Staged Construction Analysis (page 247) and are added in the Construction Stages Explorer [in *LARSA 4D User's Manual*], or with the Construction Stage Editor [see “Construction Stage Editor” in *LARSA 4D User's Manual*] in the **Input Data** menu.

For More Information, please refer to the following documentation.

- Staged Construction Analysis on page 247.
- Construction Stages Explorer in *LARSA 4D User's Manual*.

Construct and Deconstruct Activities	141
Deconstruction	141
Self Weight	141
Segmental Construction Methods	141
Load Activities	145
Creating Load Activities	145
Using Load Activities	145
Self-Weight Load Cases	145
Support and Hoist Activities	147
Support Activities	147
Hoist Activities	147
Activity Fields	147
DOF Constraint Change Activities	149
Activity Fields	149
Tendon Stressing and Slackening Activities	151
Activity Fields	151
Displacement Initializations	153
What It Does	154
Activity Fields	154
Cast Concrete Activities	155
Composite Section Construction Activities	157
Analysis Scenarios	161

Construct and Deconstruct Activities

The construct and deconstruct staged construction activities add and remove structural elements from the model.

Structural elements are at any point constructed or unconstructed. Constructed elements are used in the analysis of the structure, while unconstructed elements are ignored. Elements start off unconstructed until they are explicitly constructed in a step.

To construct or deconstruct a part of the model, form a structure group [see “Structure Groups Explorer” in *LARSA 4D User’s Manual*] and then drag that group from the Structure Groups Explorer into the Construction Stages Explorer [in *LARSA 4D User’s Manual*]. The elements in that group will be constructed. To deconstruct those elements, right-click the stage, choose Properties, and mark the Deconstruct option.

Elements may be constructed in locations relative to the deformed state of the structure. Segmental construction methods (described below), Support and Hoist Activities (page 147), and Displacement Initializations (page 153) are used to specify such behavior. Normally, elements are constructed in the position that they are initially defined in.

Deconstruction

Unless otherwise marked, structure groups included in a stage are constructed in that stage.

To deconstruct elements, right-click the step in which the elements are to be deconstructed, choose **Properties**, and then choose the Deconstruct option. All structure groups included in the step are deconstructed.

When elements are deconstructed, the internal forces in the elements are removed, resulting in unbalanced forces at the joints that connected the deconstructed elements to the model. These unbalanced forces are resolved during the construction step. Any automatic self-weight applied to deconstructed elements is also removed. See Load Class Tracking (page 265).

Self Weight

Self-weight is not automatically included in Staged Construction Analysis. To include self-weight for newly constructed elements, add a load activity (page 145) for a self-weight (page 117) load case in the same step the construction activity is placed in. Self-weight will be applied to all and only the elements constructed in that stage. Self-weight will not be applied again on elements already constructed. However, if an element is included a second time in a group included in a stage, and self-weight is applied in both stages, self-weight loads may be applied *twice* to that element.

If a self-weight load case is placed in a construction step without a construction activity, self-weight loading will be applied (possibly again) to all elements in the model constructed up to that point.

Segmental Construction Methods

In Staged Construction Analysis, when joints are activated they normally enter at the location that was initially given to them. Joints sometimes need to become active in a location relative to the deformed structure of the model, rather than in an exact position known ahead of time. The segmental construction method option of construction steps and joint displacement initialization activities specify how to place a joint relative to the deformed location of other joints.

The segmental construction method option of construction steps specifies that the locations of all joints becoming active in the step will be updated according to a segmental construction rule. The segmental construction method can be chosen by right-clicking a step, choosing **Properties**, and choosing among the options described below. Segmental construction methods have been designed to work with line element models of segmentally constructed structures and are not yet intended to be used when plate elements are used to model the segmental parts. Displacement Initializations (page 153) should be used in plate models.

The example below shows why a special segmental construction method might be necessary. It is a simple segmental bridge built in stages.

In the first stage, only the left segment is activated.

After the application of loads, the segment deforms. The center node is displaced, but the right node is left unchanged because inactive joints are ignored in the analysis.

As a result, when the next segment is constructed, the segments form an angle, even though there was no angle when the segments were initially modeled. This may not be the desired model.

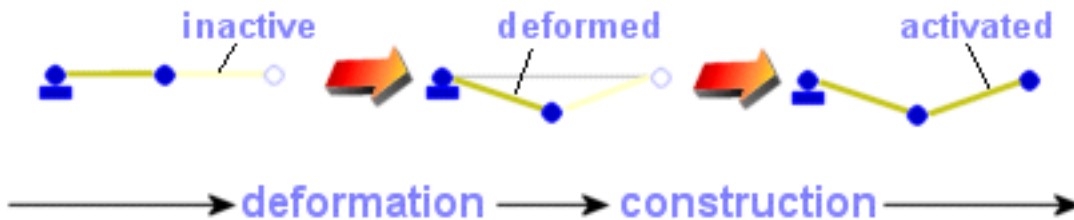

A Use for Segmental Construction Method

Two other behaviors might have been desired:

Hinged Cast

The next segment should be constructed by shifting the end node down to match the translational displacement of the center node. i.e. The segment was drawn horizontal, and it should remain horizontal.

Matched Cast

The next segment should be constructed by shifting the end node down to match the angular displacement of the center node. i.e. The segment was drawn parallel to the last, and it should remain parallel.

These are shown in the figure below.

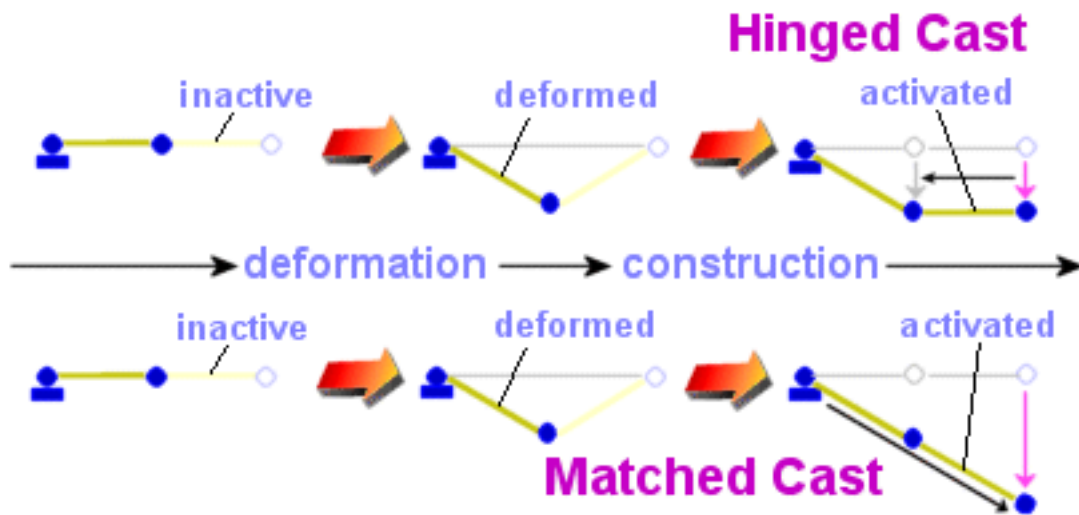

Hinged Cast versus Matched Cast

Displacement Initializations (page 153) are also used to construct elements in locations relative to the deformed position of other elements.

For More Information, please refer to the following documentation.

- Staged Construction Analysis on page 247.
- Geometry on page 57.
- Construction Stages Explorer in *LARSA 4D User's Manual*.
- Structure Groups Explorer in *LARSA 4D User's Manual*.
- Displacement Initializations on page 153.

Load Activities

Load activities in the Staged Construction Analysis apply and remove loading from the model.

A static load case (page 113) is applied to the structure in a load activity. Loads are applied cumulatively; that is, a load applied in one stage will automatically continue to be applied in all future stages.

Creating Load Activities

To apply loads in a construction step, form a load case [see “Load Cases Explorer” in *LARSA 4D User’s Manual*] and then drag that group from the Load Cases Explorer into the Construction Stages Explorer [in *LARSA 4D User’s Manual*].

A loading factor can be applied to load cases included in a stage. In the Construction Stages Explorer [in *LARSA 4D User’s Manual*], click the load case as it appears in a construction step. At the bottom of the explorer, enter a factor in the *Loading Factor* field, and then click the checkmark to confirm the change.

Using Load Activities

To “turn off” a load, there are two methods. The *Temporary Loads* option of steps can be turned on in step properties, by right-clicking a step, choosing **Properties**, and then checking the *Auto-remove loads prior to next step* option. All load cases included in the step will be removed in the following construction step. You can also apply the load again with a -1 load factor.

Create a load case with a Self Weight (page 117) to include self-weight in a Staged Construction Analysis. However, see the notes on self-weight in Construct and Deconstruct Activities (page 141).

The pre-/post-tension and jacking elongation member load (page 123) types are of particular interest in the Staged Construction Analysis.

Self-Weight Load Cases

Self-weight load cases are treated specially in Staged Construction Analysis. See the note in Construct and Deconstruct Activities (page 141).

For More Information, please refer to the following documentation.

- Staged Construction Analysis on page 247.
- Loads on page 111.
- Construction Stages Explorer in *LARSA 4D User’s Manual*.
- Load Cases Explorer in *LARSA 4D User’s Manual*.

Support and Hoist Activities

Support activities are used to change support conditions in a model during construction. Hoist activities are used to hoist a joint in a direction by the same but opposite amount it deformed.

When a support or hoist activity is applied to a joint, the new support conditions for all six degrees of freedom at the joint must be specified. In each of the six directions, which as with joint restraints (page 59) are in global directions unless a joint displacement coordinate system is set on the joint, the joint must be specified as free, fixed, or hoisted.

Do not leave a direction as *free* to mean that the joint's support conditions have not changed. This will remove a support in that direction if one was previously specified.

Support Activities

A support activity changes the support conditions of a joint in the model.

When a support is removed, by changing a direction to *free* if the joint was already supported in that direction, the reactions at that joint are applied back into the model. See Load Class Tracking (page 265).

When a grounded spring (page 83) is attached to the joint and the support activity restrains the joint in the same direction as the spring, the spring is considered released from the structure and will report zero force in that direction, until the restraint is removed using a second support activity.

Hoist Activities

A hoist activity applies a displacement to a joint, in one of its six directions of displacement, with a magnitude equal and opposite to the total displacement of the joint since initial conditions in that direction, and then restrains the joint in that direction.

Activity Fields

Joint

The ID of the joint whose support conditions are changing.

X/Y/Z-Translation and X/Y/Z-Rotation

The new support condition of the joint in each direction: free, fixed, or hoist. These are described above.

For More Information, please refer to the following documentation.

- Staged Construction Analysis on page 247.
- Construction Stages Explorer in *LARSA 4D User's Manual*.
- Joints on page 59.

DOF Constraint Change Activities

DOF Constraint activities in the Staged Construction Analysis apply and remove DOF Constraints between degrees of freedom of two joints.

Like the DOF Constraints (page 93) specified for other analysis types and for initial conditions in the Staged Construction Analysis (page 247), DOF Constraint activities are used to manage equal-displacement constrained behavior between two degrees of freedom in the model. A DOF constraint activity adds or removes such constraints during a step of construction.

When a DOF constraint activity is applied to a joint, the conditions of each of that joint's six degrees of freedom must be specified. A condition for a direction can be left as (*none*) when the joint is free to move in that direction, or the ID number of a so-called "master" joint can be specified to ensure that displacements in that direction are equal between the master and the dependent joint.

Do not leave a condition field (master joint ID) as (*none*) to mean that the constraints do not change in the step. Leaving a field as (*none*) means that the joint becomes free in that direction in the step.

If a DOF constraint is removed through an activity, the new unbalanced forces from the elements on the joint are added back into the structure. See Load Class Tracking (page 265).

Activity Fields

Dependent Joint

The ID of a joint to constrain or unconstrain.

Master Joint for Translation X/Y/Z and Rotation X/Y/Z

If a Joint ID is specified, then the displacement in this direction of the dependent joint will be equal to the displacement in the same direction as this master joint, replacing any previously set master joint in this direction. If no joint ID is specified, then the displacement in this direction of the dependent joint will be free (and any previously set master joint in this direction will be unset).

For More Information, please refer to the following documentation.

- Staged Construction Analysis on page 247.
- DOF Constraints on page 93.
- Construction Stages Explorer in *LARSA 4D User's Manual*.

Tendon Stressing and Slackening Activities

Tendon stress/slacken activities apply or remove the effect of pre- and post-tensioning tendons (page 95) in the model.

The effect of Tendons (page 95) defined in the model is not applied until they are stressed in a Staged Construction Analysis (page 247) activity. A tendon stressing activity indicates that the equivalent loading representing the tendon is to be added into the model.

If a Time-Dependent Staged Construction Analysis is run and the appropriate time-dependent effects are selected, these effects on tendons will be automatically included in the results. See Time Effects on Materials (page 261).

It is also possible to slacken a tendon by choosing *Slacken* as the activity type.

Activity Fields

Tendon

The tendon being stressed or slackened.

Activity

Stress or Slacken

For More Information, please refer to the following documentation.

- Staged Construction Analysis on page 247.
- Tendons on page 95.
- Construction Stages Explorer in *LARSA 4D User's Manual*.

Displacement Initializations

Displacement initialization construction activities specify that a joint's location should be updated based on the displacements of one or two other joints or a fixed offset.

When joints are constructed at different times, geometrical relationships between joints may be altered due to displacements in the model. For instance, although three joints may be colinear in initial conditions specified in the geometry spreadsheet, displacement at two of the joints before the third is constructed may alter that geometric relationship. When the third joint is constructed, the members connecting the joints may form an angle rather than a straight line. This is depicted in the figure below.

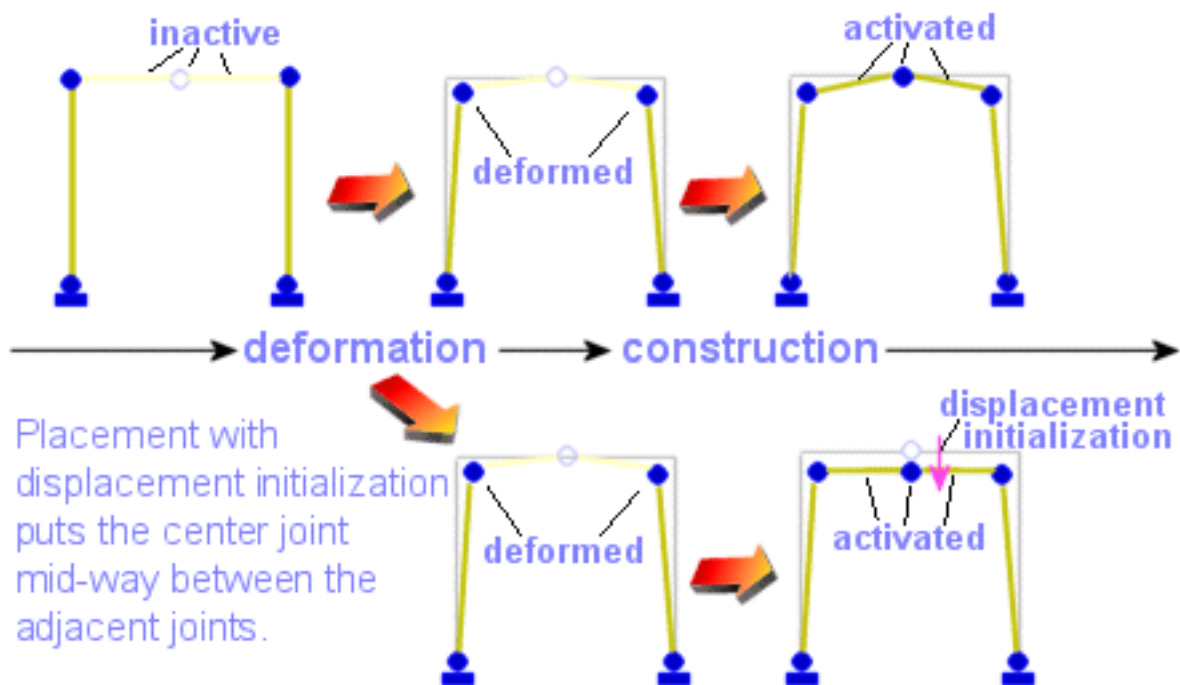

A Use for Displacement Initializations

Displacement initializations are used to update the initial conditions of a joint before it is constructed based on the displacement of one or two other joints. Displacement initializations can also be used to specify an exact geometry update so that the joint coordinates in the joints spreadsheet (page 59) can be overridden in Staged Construction Analysis.

Displacement initializations cannot be used in the first construction step.

See also the segmental construction methods (page 141) for other options to update joint coordinates based on displacement during Staged Construction Analysis.

What It Does

One dependent and up to two master joints are specified. The dependent joint is the non-constructed joint whose location is to be updated. The master joint(s) are already constructed and probably have had displacement by the time of the previous construction step.

If no master joints are specified, then the dependent joint's coordinates are updated by adding in the values in the Displacement X/Y/Z columns.

If one master joint is specified, or if two master joints are specified but they are coincident in initial conditions, then the dependent joint's location is updated by adding to it the total displacement of the (first) master joint at the end of the previous construction step, plus any additional displacement entered into the Displacement X/Y/Z columns.

If two master joints are specified and they are not coincident in initial conditions, then the dependent joint's location is updated by adding to it a linear interpolation between the two master joint's total displacements at the end of the previous construction step, plus any additional displacement entered into the Displacement X/Y/Z columns. If the three joints are colinear in initial conditions (master 1--dependent--master 2), then the interpolation is simply linear along that line. For instance, if the dependent joint is mid-way between the two master joints, then it will be adjusted by an amount equal to the average of the two displacements. However, in the general case, the interpolation is linear using the ratio of the distance between the first master and the dependent joint to the distance between the two master joints.

The Direction column limits the update to only certain components of the dependent joint's location. If the Direction is all, the coordinate update is as describe above. If the Direction is y, for instance, then the x- and z-components of the computed dependent joint displacement are reset to zero.

Activity Fields

Joint

The ID of the joint whose location is to be updated (the dependent joint).

Master Joint 1/2

The zero, one, or two master joints whose displacements in the previous construction step are used to adjust the location of the dependent joint.

Direction

The translational degrees of freedom of the joint to update. Select *all* to update the joint normally. Or, for example, specify just *x* to update the joint's *x* location only, leaving its *y* and *z* coordinates unchanged.

Displacement X/Y/Z

Additional displacement values to apply to the dependent joint. Displacements in directions that are not specified in the Direction column are ignored.

For More Information, please refer to the following documentation.

- Staged Construction Analysis on page 247.
- Construction Stages Explorer in *LARSA 4D User's Manual*.
- Construct and Deconstruct Activities on page 141.
- Joints on page 59.

Cast Concrete Activities

The Cast Concrete staged construction activity is used to set the casting day of member elements and plate elements for use in Time-Dependent Staged Construction Analysis.

The activity sets the casting day of the element or shape to the day of construction set on the stage in which the activity occurs. The member and plate elements are chosen using a Structure Group.

For a member whose section is defined with a single shape or for a plate element, the casting day of the element can be set by using the Cast Concrete activity within stages of construction, similar to entering the Casting Day information into members or plates spreadsheet.

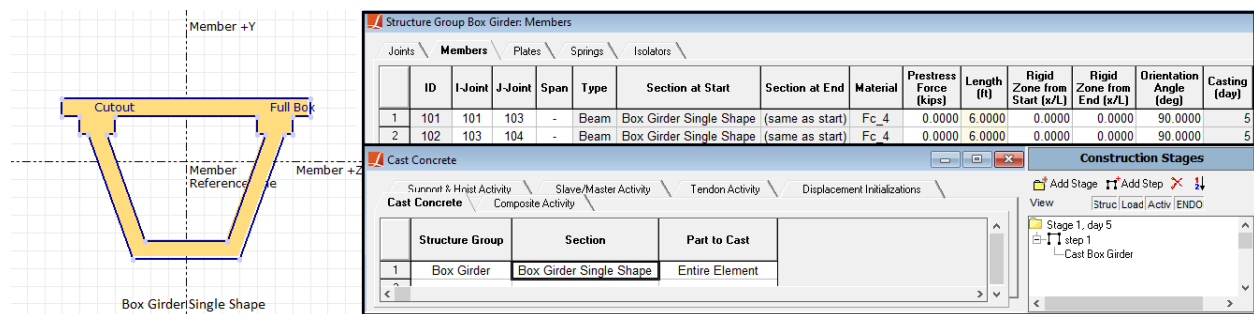

Section Composed Of A Single Shape

For a member whose section is defined with multiple shapes, i.e. a built-up section, in order to assign a different casting day to each individual shape, the Cast Concrete activity must be used instead of the members spreadsheet. In that case, the Part to Cast should be set to the name of the shape to set the casting day of. The Part to Cast column will only be available if all of the elements in the chosen Structure Group are members with the same section property assigned.

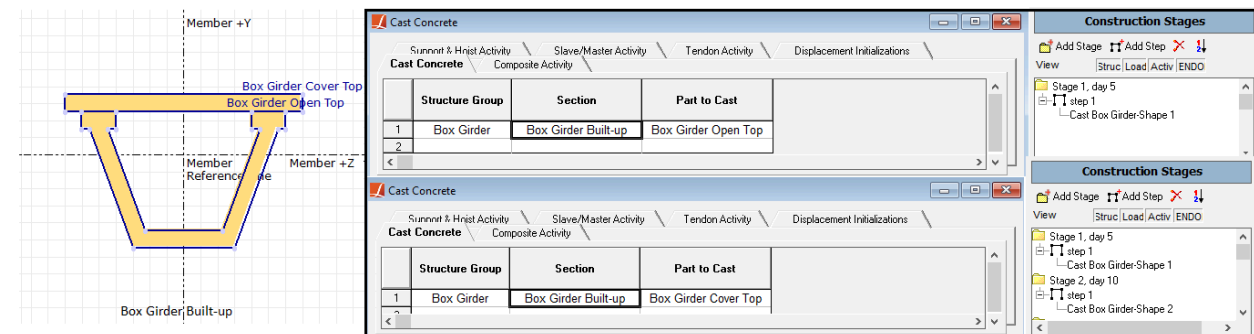

Built-up Section

The Cast Concrete activity is available starting with LARSA 4D version 8.0. In version 8.00.9010 and later, it also works for plate elements in addition to member elements.

For More Information, please refer to the following documentation.

- Staged Construction Analysis on page 247.
- Members on page 61.

- Construction Stages Explorer in *LARSA 4D User's Manual*.

Composite Section Construction Activities

Composite Construction activities are used to change the composite construction sequence state [see “Composite Construction Sections” in *LARSA Section Composer Manual*] of member elements in order to add individual shapes within built-up cross sections into the model.

For sections assembled part-by-part during Staged Construction Analysis, the construction sequence states defined in the Section Composer are activated using construction activities. A Composite Construction Activity is used each time the section changes. These activities are assigned within construction steps to structure groups containing members with the same section.

Consider a member section with its composite construction sequence states defined in the Section Composer as in the below figure:

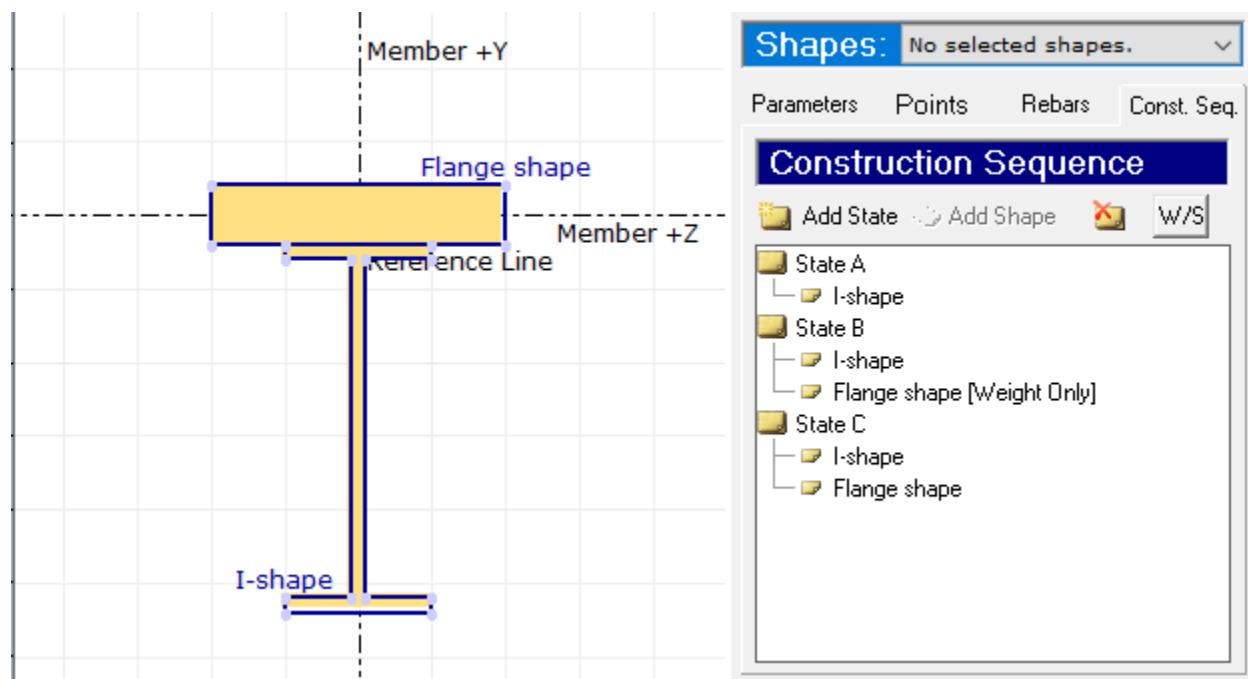

Construction Sequence States

Before using the composite construction activities within stages of construction, the member(s) whose sections will change during the Staged Construction Analysis are put into a structure group, here named “Composite.”

A Composite Construction Activity is created by right-clicking the step in the Construction Stages Explorer at the point where the activity is to occur and then by choosing **Composite Activities**. When the composite activity spreadsheet for that step is shown, a new row is created for the structure group “Composite,” and the new construction state for the section is chosen which will take effect beginning with this step.

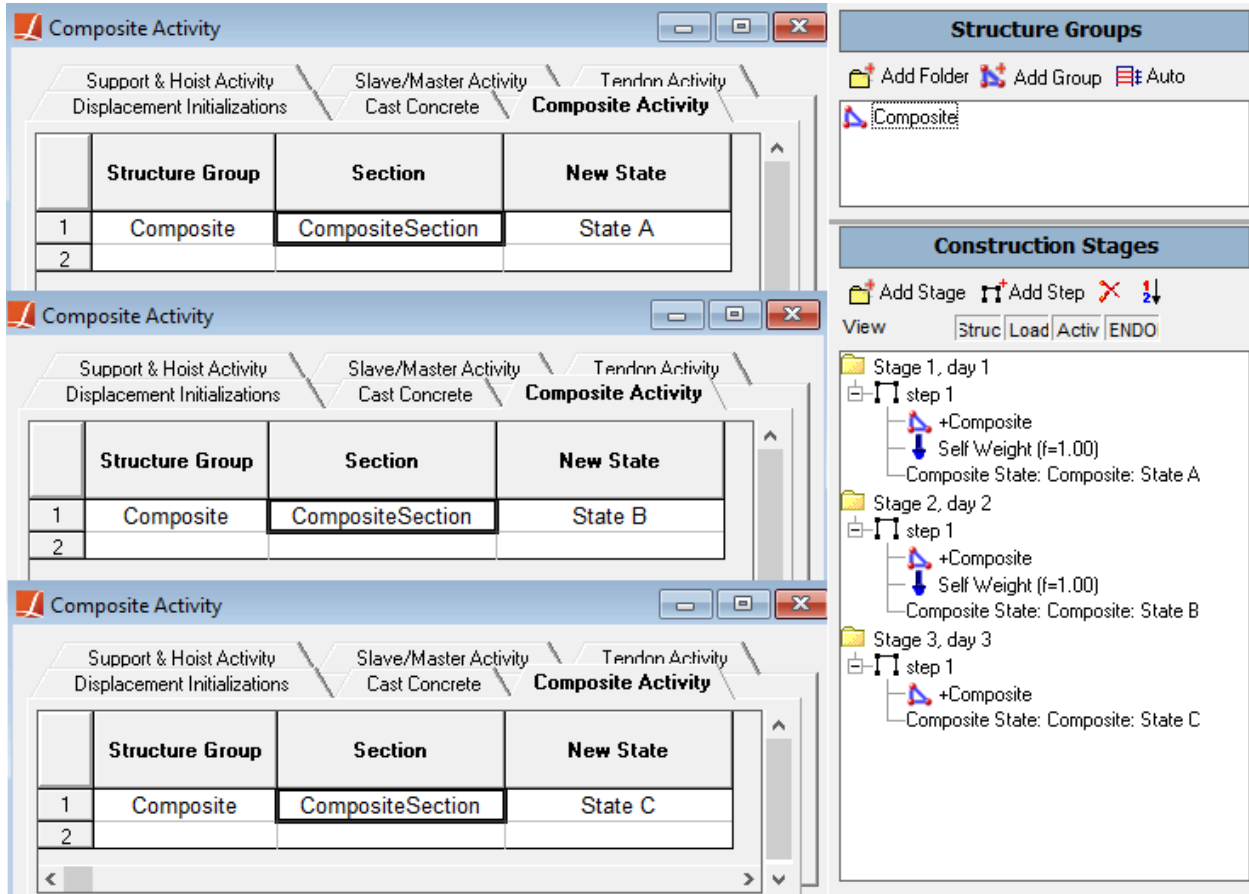

Composite Activities

Instead of defining State C in Section Composer, “All Shapes Active” can be used instead in the composite activity spreadsheet, under the **New State** column.

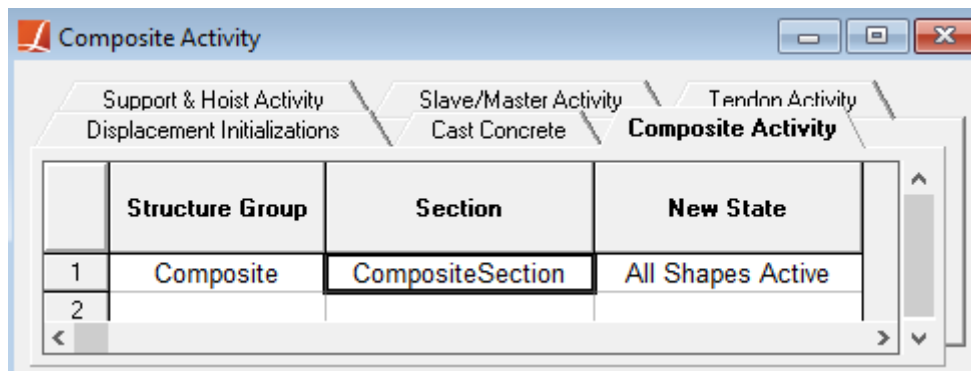

All Shapes Active

The composite construction activity is available starting with LARSA 4D version 8.0.

For More Information, please refer to the following documentation.

- Staged Construction Analysis on page 247.
- Members on page 61.
- LARSA Section Composer in *LARSA Section Composer Manual*.
- Construction Stages Explorer in *LARSA 4D User's Manual*.

Analysis Scenarios

Analysis Scenarios are analyses performed during a Staged Construction Analysis (page 247), such as a live load analysis or pushover, based on the deformed state of the structure at any time.

Any time of analysis can be performed in a construction step. To change the analysis type, right-click the construction step and choose **Properties**. Then at the bottom right of the window, choose the analysis type.

You will also need to add a load case into the construction step as a load activity (page 145) that specifies the parameters for the scenario. For instance, for a live load (moving load or influence) scenario, include a load case with a moving load or influence set-up load.

For More Information, please refer to the following documentation.

- Staged Construction Analysis on page 247.
- Construction Stages Explorer in *LARSA 4D User's Manual*.
- Load Cases Explorer in *LARSA 4D User's Manual*.

Part II

Analysis Reference

Each of the analysis types available in LARSA 4D are described in the sections below.

Linear and Nonlinear Static Analysis	167
Linear Static Analysis	169
Structure Model for Linear Static Analysis	169
Analysis Results	169
Assumptions in a Linear Static Analysis	170
P-Delta Analysis	171
Using Load Combinations for the P-Delta	171
Caveats	171
Method	171
Convergence Criteria	171
Nonlinear Static Analysis	173
Why a Nonlinear Analysis	173
Applications of the Nonlinear Analysis	174
Equations of Equilibrium and Solution	174
Caveats	174
Incremental Loading	175
Convergence Criteria	175
Displacement Convergence and Unbalanced Forces	175
Load Case Data for Nonlinear Static Analysis	176
Nonlinear Static Analysis Options	177
Eigenvalue and Response Spectra Analysis	179
Eigenvalue and Stressed Eigenvalue Analysis	181
Unstressed (Standard) Eigenvalue Analysis	181
Stressed Eigenvalue Analysis	181
Eigenvalue Analysis within Staged Construction Analysis	181
Eigenvalue Analysis Options	183
Stressed Eigenvalue Analysis Options	185
Response Spectra Analysis	187
Response Spectrum Curves	187
Preparing the Eigenvalue Analysis	189
Using the Response Spectra Case Tool	189
Tool Options	191
Accessing RSA Results	193

Nonlinear Buckling and Pushover Analysis	195
Nonlinear Buckling Analysis	197
Advantages of a Nonlinear Analysis	197
Using the Nonlinear Buckling Analysis	197
Nonlinear Pushover Analysis	199
Incremental Nonlinear and Nonlinear Buckling Analysis Options	201
Nonlinear Pushover Analysis Options	203
Linear and Nonlinear Time History Analysis	205
Linear Time History Analysis	207
Linear Time History Analysis within Staged Construction Analysis	207
Linear Time History Analysis Options	209
Nonlinear Time History Analysis	211
Overview	211
Newmark-Beta with Newton-Raphson	211
Sparse Solver Technology	211
Nonlinear Time History Data	211
Nonlinear Time History Analysis within Staged Construction Analysis	211
Nonlinear Time-History Analysis Options	213
Geometric Nonlinearity	213
Static Moving Load Analysis, Dynamic Rolling Stock Analysis, Influence-based Live Load Analysis, and Vehicle-Track-Structure Interaction Analysis	215
Linear Static Moving Load Analysis and Dynamic Rolling Stock Analysis	217
Preparing a Moving Load Analysis	217
Linear Static Moving Load Analysis	217
Linear Dynamic Rolling Stock Analysis	218
Standard Vehicles	219
AASHTO and CALTRANS Vehicles	219
AASHTO Load Patterns for Influence Analysis	219
IRC Load Patterns for Influence Analysis	220
Influence Line & Surface Analysis	223
Influence Analysis Overview and Options	225
The Assumption of Linearity	225
The Vehicle Loading Algorithm	225
Performing an Influence Analysis	226
General Loading Parameters	227
Vehicular Loading Options	230
Uniform/Patch Loading Options	234
Procedure: Getting Results	234
Suggestions for Influence Analysis	237
Suggestions for Speed	237
Vehicle-Track-Structure Interaction Analysis	239

Methodology and Rationale	239
Model Setup Procedure	240
Accessing Dynamic Results	244
Staged Construction Analysis	247
Overview of Staged Construction Analysis	249
Staged Construction Activities	251
Setting Up the Model	253
Preparation	253
Creating Activities in the Explorer	254
Creating Activities in the Stage Editor	256
Time Effects on Materials	261
Material Time Effects	261
Design Codes	263
Load Class Tracking	265
Setting up the model	265
The Load Classes of Result Cases	265
Accessing Class-Based Results	266
Staged Construction Analysis Options	267
Options for Analysis Scenarios	268
Solver Options	271

Linear and Nonlinear Static Analysis

Linear Static Analysis	169
Structure Model for Linear Static Analysis	169
Analysis Results	169
Assumptions in a Linear Static Analysis	170
P-Delta Analysis	171
Using Load Combinations for the P-Delta	171
Caveats	171
Method	171
Convergence Criteria	171
Nonlinear Static Analysis	173
Why a Nonlinear Analysis	173
Applications of the Nonlinear Analysis	174
Equations of Equilibrium and Solution	174
Caveats	174
Incremental Loading	175
Convergence Criteria	175
Displacement Convergence and Unbalanced Forces	175
Load Case Data for Nonlinear Static Analysis	176
Nonlinear Static Analysis Options	177

Linear Static Analysis

The linear elastic static analysis is a first order analysis that excludes nonlinearity.

The following are the basic assumptions:

- Materials are assumed to be elastic and unyielding with their properties invariable.
- The equations of equilibrium are formulated on the geometry of the unloaded structure.
- The deformations are assumed to be so small as to be insignificant in their effect on the equilibrium.
- Strains are small and stresses are proportional to strains.

Linear static analysis can compute the response of the structure to various types of static loads in the form of self weight, joint loads, joint displacements, loads applied to beam elements, thermal loads applied to beam, truss, and cable elements, and surface and thermal loads applied on plate and shell elements.

Linear static analysis is performed on load cases (page 113) whose types are set to *Static* and factored combination of these load cases (load combinations (page 115)). The load conditions are solved simultaneously in a single solution.

Structure Model for Linear Static Analysis

In the linear static analysis, the structure must include only linear elements. Cable and compression only foundation spring elements are examples of nonlinear elements that cannot be used in the linear static analysis. If nonlinear elements are used in the structure model while performing linear static analysis, LARSA will replace these elements with their equivalent linear elements on-the-fly without modifying the model data. For example, a cable element is automatically replaced by a truss element in linear static analysis.

Here is a list of nonlinear elements that are replaced with their linear equivalent if used in a linear static analysis:

- Cable Element
- Tension-Only and Compression-Only Truss Elements
- Grounded Spring Element with different stiffness for tension and compression
- One- or Two-Node Spring Element with a nonlinear spring property definition
- Hysteretic Beam Element
- Connection Beam Element
- Hysteretic Spring Element
- Seismic Isolator and Bearing Elements

Analysis Results

Typical results from the linear static analysis are:

- Joint displacements
- Reaction forces at support joints
- Member end forces in global XYZ or in member local directions

- Member sectional forces, stresses, and displacements
- Plate center forces and stresses, and joint forces
- Spring forces

Assumptions in a Linear Static Analysis

By definition, the linear elastic static analysis is a first order analysis that excludes both geometric and material nonlinearity. In practical terms the assumptions of this analysis means:

- The geometry of the elements remains unchanged during the loading.
- First order, infinitesimal, and linear strain approximations can be used.
- The material behavior of the elements is linear.

When the acceleration dependent inertia forces and velocity dependent damping forces are ignored, the equations of equilibrium for static analysis are reduced to the following:

$$\mathbf{K}_t \mathbf{U} = \mathbf{R}$$

where

\mathbf{U} = Joint displacement vector

\mathbf{R} = Applied joint force vector

with the tangent stiffness matrix, in the following form:

$$\mathbf{K}_t = \mathbf{K}_o + \mathbf{K}_g + \mathbf{K}_s$$

where

- \mathbf{K}_t = Tangent stiffness
- \mathbf{K}_o = Small displacement stiffness
- \mathbf{K}_g = Large displacement stiffness for geometry change
- \mathbf{K}_s = Geometric stiffness (stress stiffening)

In the linear static analysis, the displacements are assumed small, the effect of stress stiffening is ignored, and material behavior is assumed linear elastic. Therefore, the stiffness due to the change of geometry (\mathbf{K}_g) and stress stiffening (\mathbf{K}_s) are not considered. Then tangent stiffness matrix (\mathbf{K}_t) becomes the same as the stiffness matrix corresponding to linear small displacement behavior:

$$\mathbf{K}_t = \mathbf{K}_o$$

It should be noted that for the linear analysis, the terms in the stiffness matrix are constant values and do not depend on the unknown displacements. The equilibrium equations are linear simultaneous equations and the closed-form solution is obtained directly for the unknown joint displacements. The element end forces are computed by simply multiplying the element end deformations by the element stiffness matrix.

For More Information, please refer to the following documentation.

- Running an Analysis in *LARSA 4D User's Manual*.

P-Delta Analysis

If the loads applied to the structure change the geometry and stiffness, the first order linear elastic static analysis may not be satisfactory. It is then recommended to use some form of nonlinear analysis where second-order effects are considered. P-Delta is the most basic type of second order or nonlinear analysis.

The P-Delta can be defined as the secondary effect of column axial loads and lateral deflections on the moments in members. These effects can be separated as:

- A destabilizing moment equal to a gravity load times the horizontal displacement it undergoes as a result of the lateral displacement of the supporting structure.
- The influence of axial force on the flexural stiffness of individual members.

The most common situation where a second-order effect must be considered is a multi-story building under lateral loading (wind and/or earthquake) that must rely on the stiffness of the beams and columns to resist sway. A member subjected to a large axial force combined with transverse loads or to transverse end translation or rotation represents a typical P-Delta or geometric nonlinear problem. These type of second-order effects are often referred to as the beam-column problem, or a P-Delta problem.

Using Load Combinations for the P-Delta

When performing a P-Delta analysis, only active load combinations will be analyzed. The load cases within the load combination must be static load cases. The load combinations are solved separately but within a single analysis run.

The load cases are applied incrementally in the same order as entered in the load combination data. For the load combination $1.2*(\text{Dead Load}) + 1.6*(\text{Live Load})$, LARSA will first apply and solve for the load vector as 1.2 times Dead Load and after convergence is established, 1.6 times the live load is applied and solved for.

Caveats

P-Delta analysis should not be used as a substitute for a nonlinear static analysis for any type of cable structure such as suspension bridges, cable-stayed bridges, and other cable structures like stadium roofs or guyed towers.

Method

The method for P-Delta in LARSA is the same method employed in all nonlinear analysis options but with a limited number of iterations and without any nonlinear elements. The method used here is the iterative full Newton-Raphson method, updating the tangent stiffness matrix in every iteration for the P-Delta effects. The equilibrium at the joints are based on the deformed shape of the elements in the structure. Therefore, the P-Delta effects are incorporated directly into the stiffness matrix as part of the geometric stiffness including geometry change and stress-stiffening.

Convergence Criteria

The Displacement Tolerance, Force Tolerance, and Maximum Number of Iterations are the basic convergence criteria specified in any of the nonlinear static analysis based options. However, for the P-Delta analysis, these values are preset.

The Displacement Tolerance is the ratio of the incremental displacement computed in the last iteration to the total displacement for the same degree of freedom. This criteria is set to 0.01 (1%) for P-Delta.

The Maximum Number of Iterations is the maximum number of iterations that can be performed for each load step. The value is set to 5 for P-Delta. The iterative analysis continues until all degrees of freedom in the model satisfy Displacement Tolerance of 0.01 but up to the maximum 5 iterations.

If the solution for a load step within a load combination is not convergent when number of iterations performed is equal or exceeds the maximum specified, a message is displayed on the screen and captured in the run log reporting nonconvergence. If there are additional load steps for the same load combination, analysis will continue if the structure has not become unstable. The unbalanced forces are carried into the next load step and a convergent solution may be obtained in the next load step. This may imply that your structure is fine and you either have to use smaller factored load steps within the load combinations or use a nonlinear static analysis where the user can increase the maximum number of iterations or use less restrictive tolerances.

For More Information, please refer to the following documentation.

- Running an Analysis in *LARSA 4D User's Manual*.

Nonlinear Static Analysis

In structures, nonlinearity can be classified as material nonlinearity or as geometric nonlinearity. Material nonlinearity is associated with changes in material properties: inelastic behavior. Geometric nonlinearity is associated with changes in configuration, such as large deflections of a slender elastic beam or structures with cables.

The nonlinear static analysis takes into account geometric and material nonlinearity by iteratively solving for the displacements of a structure, stopping when convergence criteria have been met.

Deformations can significantly alter the location or distribution of loads so that equilibrium equations must be written with respect to the deformed geometry, which is not known in advance. One seeks a displacement state in which the deformed structure is in equilibrium with the loads applied to it.

Geometric nonlinearity in LARSA includes both the change in geometry and the effects of stress stiffening such as that encountered when a cable or a thin member is stressed in tension or in compression.

Structures can include several types of material nonlinearities at the element level. The inelastic beam element (a hysteretic beam element based on spread plasticity using a yield surface), the connection beam element with inelastic rotational connection springs, the nonlinear elastic and nonlinear inelastic springs, gap and hook elements, and foundation springs with nonlinear elastic or inelastic material behavior all exhibit these properties.

The nonlinear static analysis takes into consideration the following:

- Large displacements. The stiffness matrices of the elements are based on deformed geometry.
- Stress stiffening due to the internal axial forces in beam, truss, and cable elements, but not plate elements.
- Effects of follower forces from joint loads due to displaced geometry.
- Gaps and hooks which open, close, and slide.
- Nonlinear elastic and inelastic material behavior of spring elements.
- Compression-only grounded springs with zero stiffness when open.
- Yield force capacity in foundation elements.
- Inelastic material behavior in beam elements using tri-axial yield surfaces.
- Ability to have plastic hinges along the member length without specifying locations.
- Different paths during post-yield.
- Plastic moment capacity in beams.

Why a Nonlinear Analysis

It is fortunate that the linear analysis based on linear approximations works quite well for many problems in structures. In a linear analysis, the material is assumed to be unyielding and its properties invariable, and the equations of equilibrium are formulated on the geometry of the unloaded structure.

Although most analyses and designs stay within the linear elastic range, many physical situations present nonlinearities, and more and more structures demand that nonlinearities be considered for more accurate analysis and design. Slender structures such as suspension systems, arches, tall buildings, and structures subject to local yielding and cracking are basic types among structures requiring nonlinear analysis.

The fundamental goal of using the nonlinear analysis is to improve the quality of design with a more reliable prediction of performance of a structure. Nonlinear analysis can help us reduce the uncertainty regarding actual behavior of a structure. Meanwhile, the effort for modeling the structure and handling the equations of analysis is significantly increased.

Applications of the Nonlinear Analysis

Suspension bridges, cable-stay bridges, and cable domes are structures with high geometric nonlinearity. These structures are complex in shape, and usually the final deformed shape of the structure is given. The analysis involves finding the initial shape of the structure along with the prestress forces to be applied to bring the structure to its final shape under given loading conditions. The analysis needs to consider the deformed geometry and the stress stiffening effects.

Similarly, for the computation of the eigenvalues and mode shapes for suspension bridges and similar structures, the effects of large displacements and stress stiffening need to be considered. Neglecting the nonlinear effects may result in incorrect values for natural frequencies of the structure.

Consider foundations and bridge piers. These structures are usually supported by soil or friction bearing piles which may not sustain tensile forces. The model for these structures may consist of a combination of beam and plate elements representing the bridge structure. The piles and soil can be represented using the nonlinear foundation elements. The stiffness of the foundation elements will depend on the displacements. The solution can be obtained in one single analysis run using the nonlinear analysis.

Many of the seismic design and analysis procedures for bridges require consideration of nonlinear behavior. These methods assume plastic hinges will form to utilize the full displacement capacity during an earthquake. Abutments, hinges, and restrainers in bridge structures are nonlinear elements. Abutments and hinges can transfer only load in compression. Restrainers transfer only load in tension. Nonlinear analysis is a more reasonable tool to use than a series of linear analyses for these types of analyses.

Plastic deformations of steel structures, cracking or creep of reinforced concrete structures, inelastic interaction of axial force and bending moments, connection deformations, and panel zone deformations are among the many sources of nonlinearity. Rarely is it possible to model all sources of nonlinearity for a practical structure. Normally, the goal is to choose a model that does provide adequate analytical simulation of the actual behavior.

Equations of Equilibrium and Solution

In a nonlinear analysis, the equilibrium equations are formulated with respect to the deformed geometry of the structure, which is not known in advance and will change with the applied loads. The stiffness matrix depends on the unknown displacements. The result is a set of nonlinear simultaneous equations. It is necessary to employ an iterative technique to obtain a solution in nonlinear analysis. An iterative scheme based on Newton-Raphson Method has been implemented in LARSA.

Caveats

Using nonlinear analysis is not difficult, but misuse of it without understanding the methodology may lead to disasters. It is always a good practice to explore and understand the implementation of the nonlinear analysis in the computer program that is used. Users should always keep in mind that a nonlinear analysis may not have a unique solution as with the linear analysis. Therefore, any solution obtained must be verified by the user. We recommend the user knows:

- Sources of nonlinearity that are significant.

- How to represent these nonlinearities in the model.
- The formulation of the element stiffness matrices: tangent, secant or initial.
- The material nonlinearity formulation of the elements.
- The solution technique used - Full or Modified Newton-Raphson.
- How convergence criteria are satisfied.
- The number of iterations required for convergence.
- The magnitudes of unbalanced forces on the structure.

Incremental Loading

It must be kept in mind that in computing displacements for a given set of loads within a range of nonlinear behavior, it is essential to apply the loads incrementally. In general, it may not be possible to start from the unloaded state and apply the total loading in a single step due to numerical instabilities in the solution of the simultaneous equations.

The user must be cautioned that the solutions for nonlinear analyses are not direct closed form solutions as in linear analysis. Any loading causing abnormal displacements may not result in convergence.

The computed displacements, reactions and element forces at the end of any load step are the accumulated effects from all the load steps considered.

Convergence Criteria

The convergence criteria are specified by the user as the tolerable error ratio for displacement, maximum unbalanced force and maximum number of iterations. The tolerable error ratio is the incremental displacement computed in the last iteration divided by the total displacement for the same degree of freedom. The default value is 0.001 (0.10%). The iterative analysis continues until all degrees of freedom in the model satisfy both criteria. However, the number of iterations performed for each load step is limited not to exceed the maximum number of iterations specified by the user.

If the solution is not convergent for a load step, a message is displayed on the screen. If there are additional load steps, analysis continues as long as the structure is not unstable. LARSA carries the unbalanced forces into the next load step and a convergent solution may be obtained in the next load step. This may imply that your structure model is fine and you either have to increase the maximum number of iterations or use a less restrictive error ratio.

Displacement Convergence and Unbalanced Forces

The displacement convergence and unbalanced force reports include important information in evaluating the results of the nonlinear analysis. These reports are used for accepting the convergence of the results for the solution. The displacement convergence report provides the maximum error in the displacements during each iteration. The unbalanced force report tells us the error about the internal force equilibrium of the structure.

The structure must be in equilibrium for a convergent solution. When any unbalanced force remains, the structure is not in equilibrium. The unbalanced forces at the end of each load step are recorded in the log file. The report includes the joints with significant unbalanced forces and summarizes the maximum and total unbalanced force vector for all six DOF in the structure.

It is imperative that the user comprehend the information provided in these reports. In the best case, both reports have all zeros.

Load Case Data for Nonlinear Static Analysis

In LARSA, the nonlinear static analysis can be performed for:

- Computing the response of the structure to several load cases.
- Computing the response of the structure to several independent factored load cases.
- Tracing the load-deflection response of the structure.

Most of the nonlinear analysis falls in the second category where the response of the structure is computed for several load combinations in the same run. The complete load-deflection response of the structure to a series of incremental loads is required in a pushover analysis (page 199) or in a nonlinear buckling analysis (page 197).

The load cases and applied loads are defined exactly in the same manner as for the linear static analysis.

For More Information, please refer to the following documentation.

- Nonlinear Static Analysis Options on page 177.
- Nonlinear Buckling Analysis on page 197.
- Nonlinear Pushover Analysis on page 199.

Nonlinear Static Analysis Options

Solution Convergence

Equilibrium iterations at a given load level can cease when the result is "close enough" according to one or more criteria. Two criteria used in LARSA are that the unbalanced force be a small fraction of the total applied force in the current load level and that the current displacement increment be a small fraction of the displacement increment. The convergence criteria are specified by the user as the displacement tolerance, force tolerance and maximum number of iterations. The iterative analysis continues until all degrees of freedom in the model satisfy displacement and force tolerance criteria within the maximum number of iterations.

If the solution is not convergent for a load step, a message is displayed on the screen. If there are additional load steps, analysis will continue if the structure is not unstable. LARSA carries the unbalanced forces into the next load step and a convergent solution may be obtained in the next load step. This may imply that your structure is fine and you either have to increase the maximum number of iterations or use a less restrictive error ratio.

Max # of Iterations

The number of iterations performed for each load step will not exceed the maximum number of iterations specified by the user. We recommend 10 to 20 as a maximum number of iterations.

Displacement Tolerance

The displacement tolerance is the error ratio of the incremental displacement computed in the last iteration divided by the total displacement for the same degree of freedom. The default value is 0.001 (0.10%).

Force Tolerance

The force tolerance is the maximum unbalanced force at any degree of freedom.

Analyze For

Nonlinear static analysis can be performed for load cases and for load combinations in the same analysis run.

Analyze Load Cases

If this option is checked, nonlinear static analysis is performed for all active load cases.

Increments

When analyzing load cases, each load case is divided into this many equal load steps.

Analyze Load Combinations

The nonlinear static analysis is performed for each load combination by accumulating the loads on the structure in the same sequence as specified in the load combination data.

For More Information, please refer to the following documentation.

- Nonlinear Static Analysis on page 173.
- Running an Analysis in *LARSA 4D User's Manual*.

Eigenvalue and Response Spectra Analysis

Eigenvalue and Stressed Eigenvalue Analysis	181
Unstressed (Standard) Eigenvalue Analysis	181
Stressed Eigenvalue Analysis	181
Eigenvalue Analysis within Staged Construction Analysis	181
Eigenvalue Analysis Options	183
Stressed Eigenvalue Analysis Options	185
Response Spectra Analysis	187
Response Spectrum Curves	187
Preparing the Eigenvalue Analysis	189
Using the Response Spectra Case Tool	189
Tool Options	191
Accessing RSA Results	193

Eigenvalue and Stressed Eigenvalue Analysis

The eigenvalue analysis is performed to extract the undamped free-vibration mode shapes and frequencies of a structure. The eigenvalue analysis is important as a precursor to any dynamic analysis because knowledge of the structure's natural frequencies and modes can help to characterize its dynamic response. The results of an eigenvalue analysis also help determine the number of modes to be used in a response spectra analysis.

Each eigenvalue-eigenvector pair is called a natural vibration mode of the structure. The modes are identified by numbers from 1 to n in the order of increasing frequency. The eigenvalue is the square of the circular frequency for that mode. The cyclic frequency, f , and period, T , of the mode are multiplicative inverses.

The mass matrix automatically includes the mass of members (from section area and weight density) and plates (from thickness and weight density). Element mass is computed as a lumped mass matrix. When the element has an end offset, this matrix becomes non-diagonal when transformed to the element's joints. No other elements automatically include mass in dynamic analysis. Mass elements (page 91), which are ignored in static analysis, are used to add additional (usually nonstructural) mass for dynamic analysis. It is also possible to compute mass from static loads by putting static loads in a load case (page 113) marked as representing dynamic mass rather than static loading.

When an eigenvalue analysis is performed, the results from a previous eigenvalue analysis are automatically overwritten in the results database.

Unstressed (Standard) Eigenvalue Analysis

When an eigenvalue analysis of the undeformed structure is requested, the stiffness matrix is computed using the undeformed geometry of the structure. Because no loads are applied, stress stiffening is not included. Static load cases are not used in this type of eigenvalue analysis.

Stressed Eigenvalue Analysis

In the stressed eigenvalue analysis, an eigenvalue analysis performed based on a nonlinear static analysis. The stiffness matrix includes the effects of static loads (stress stiffening) and the deformed geometry of the structure.

The user selects the load case for which the program performs a nonlinear static analysis. Eigenvalues are extracted based on the stiffness of the structure after the applied load.

Eigenvalue Analysis within Staged Construction Analysis

Eigenvalue analysis can be performed as a scenario within Staged Construction Analysis. If the Include Geometric Nonlinearity (page 267) option is turned on, then the stiffness matrix includes the effects of static loads applied on the structure in previous construction steps (stress stiffening) and the deformed geometry of the structure as of the previous construction step.

The mass matrix includes element mass only for elements that are constructed and have had self-weight applied in previous construction steps, i.e., unconstructed elements, elements constructed with the stiffness-only option, and elements that have not yet had a self-weight load case applied will not have their mass included. Additional dynamic mass is included from all load cases in the project with the Is Dynamic Mass? (page 113) option set to Yes (and so these load cases should not be included as loading activities in the construction sequence).

Only one eigenvalue analysis scenario can be performed in a Staged Construction Analysis.

For More Information, please refer to the following documentation.

- Eigenvalue Analysis Options on page 183.
- Stressed Eigenvalue Analysis Options on page 185.

Eigenvalue Analysis Options

Modal Analysis

The eigenvalue analysis is used to determine the natural frequencies and mode shapes of a structure. The equations of motion are solved for an undamped system without any applied forces.

The dynamic characteristics, which are the resonant frequencies (eigenvalues) and mode shapes (eigenvectors) of the undamped structure are determined.

Number of Mode Shapes

The number of mode shapes to be extracted. The requested number of mode shapes can not be greater than the number of mass degrees of freedom.

For More Information, please refer to the following documentation.

- Running an Analysis in *LARSA 4D User's Manual*.
- Eigenvalue and Stressed Eigenvalue Analysis on page 181.

Stressed Eigenvalue Analysis Options

Solution convergence control from the nonlinear static analysis (page 177) and mode shape options from the standard eigenvalue analysis (page 183) apply to this analysis type as well.

Load Case

Stressed eigenvalue analysis requires finding the deformed position of a structure along with the forces in the members prior to calculating the mode shapes. These options determine which static loads will be applied on the structure.

Load Case

This option is not currently supported.

Load Combination

Select a load combination from which the static loads will be applied to the structure.

For More Information, please refer to the following documentation.

- Running an Analysis in *LARSA 4D User's Manual*.
- Eigenvalue and Stressed Eigenvalue Analysis on page 181.

Response Spectra Analysis

Response Spectra Analysis (RSA) provides an estimate for the response of forces and deformations of a structure to shock loading conditions, such as in seismic analysis. RSA is a statistical type of analysis where the peak response of a multi-degree-of-freedom system can be calculated. Results of RSA are not exact but are accurate enough for structural design applications.

RSA is not a true dynamic analysis but is instead considered a procedure for dynamic analysis. RSA is considered a dynamic analysis procedure because it uses the structure's natural frequencies and corresponding mode shapes, modal damping ratios, and the dynamic characteristics of the ground motion through its response spectrum. But compared to Time History Analysis (page 207), it excludes the structure's response history.

RSA requires the results of an Eigenvalue Analysis (page 181) along with a known spectrum to calculate the most likely peak responses for displacements, forces and stresses that occur in the structure. The eigenvalue analysis can be performed using natural frequencies and mode shapes of the undeformed structure (Eigenvalue Analysis) or of the deformed structure subject to loads (Stressed Eigenvalue Analysis or Eigenvalue Analysis within Staged Construction Analysis (page 247)).

*The recommended way to perform Response Spectra Analysis is using the **Results** → **Response Spectra Case** tool. The Response Spectrum Analysis option in the LARSA 4D **Analysis** menu is no longer recommended. See below for more information about using this analysis type.*

Response Spectrum Curves

About Response Spectrum Curves

Response spectrum curves are graphs of the maximum response (displacement, velocity, or acceleration) to a specified excitation for a single degree-of-freedom system. The abscissa of the curve is the natural frequency (or period) of the structure, and the ordinate is the maximum response.

The construction of these plots requires the solution of single degree-of-freedom systems for a sequence of values of the natural frequency and of the damping ratio. Each solution provides only one point of the response spectrum and the task is lengthy to obtain the maximum response value for all frequencies of interest. Once these curves are available for the seismic excitation, the RSA is reduced to calculation of the natural frequencies and mode shapes of the structure and the use of the response spectrum curves.

In general, the user does not develop the response spectrum curves but obtains and use them in the program as a database of RSA curves.

Creating or Selecting a Response Spectrum Curve

Prior to using the Response Spectra Case tool, a response spectrum curve database must be connected to the project. Response spectrum curve databases have the file extension .drs.

To create a new response spectrum curve database, see The Database Editor [in *LARSA 4D User's Manual*] The values for the abscissa and ordinate of response spectrum curves must be positive or zero. The ordinates can be the actual values or values normalized with respect to a ground acceleration of 1.0 g. If the curve ordinate is normalized with respect to g, then you must enter g as the scale value for the curve in the database editor.

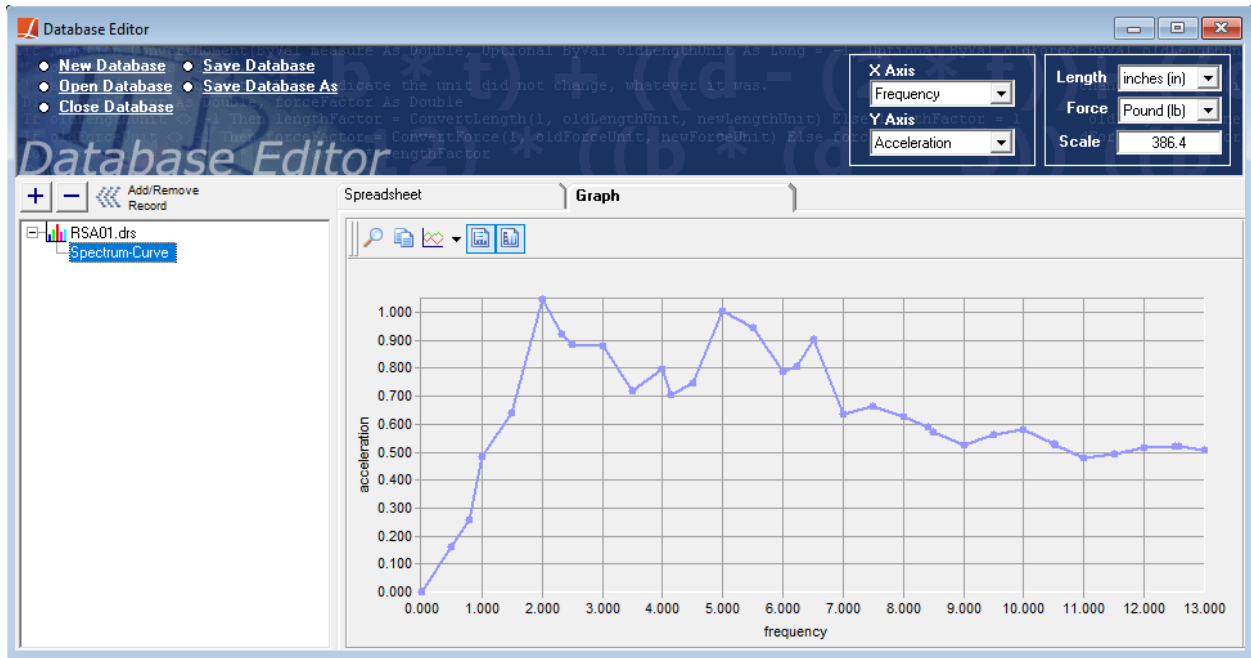

RSA Curve in the Database Editor

After creating or obtaining a response spectrum curve database, use Connecting Databases [in *LARSA 4D User's Manual*] to connect the database to the project.

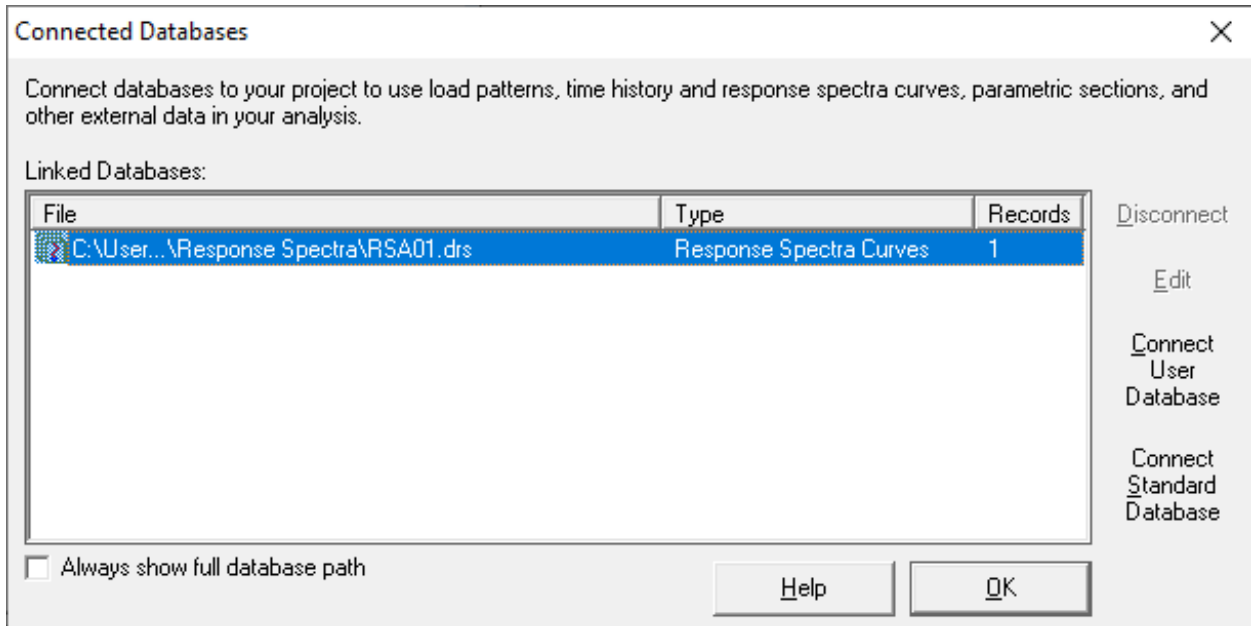

Connecting an RSA Curve Database

Preparing the Eigenvalue Analysis

An eigenvalue analysis must be run prior to using the Response Spectra Case tool. See Eigenvalue and Stressed Eigenvalue Analysis (page 181).

Run Eigenvalue & Response Spectra Analysis

Select Analysis Type

Modal Analysis Other Options

Eigenvalue
Eigenvalue on Deformed
Response Spectra
Linear Static + Eigenvalue + RSA

Number of Mode Shapes

Analyze

Close

Cancel

Help

Keep Previous Results

Perform Quick Integrity Check

Description:

Performs an eigenvalue analysis on the undeformed structure.

Running an Eigenvalue Analysis

Eigenvalue Analysis can also be run as a scenario within Staged Construction Analysis (page 247) by changing the analysis type for a construction step to **Eigenvalue**. When the Geometric Nonlinearity option is turned on, this analysis is similar to a Stressed Eigenvalue analysis.

Using the Response Spectra Case Tool

After running the Eigenvalue or Staged Construction Analysis, use **Results** → **Response Spectra Case** to create a new Response Spectra Analysis result case.

Response Spectrum Result Case [X]

Name:

Response-Spectrum Curve in Direction 1: Scale in Direction 1:

Response-Spectrum Curve in Direction 2: Scale in Direction 2:

Response-Spectrum Curve in Direction 3: Scale in Direction 3:

Modal Combination Method: Spatial Combination Method:

Modal Damping Curve: Modal Damping Ratio:

Angle From Global X to Direction 1: Sign Assigned to Results:

Response Spectra Case Tool

The options are described below.

After clicking OK, the new RSA result case will be added to a new Response Spectra group at the bottom of the Analysis Results Explorer.

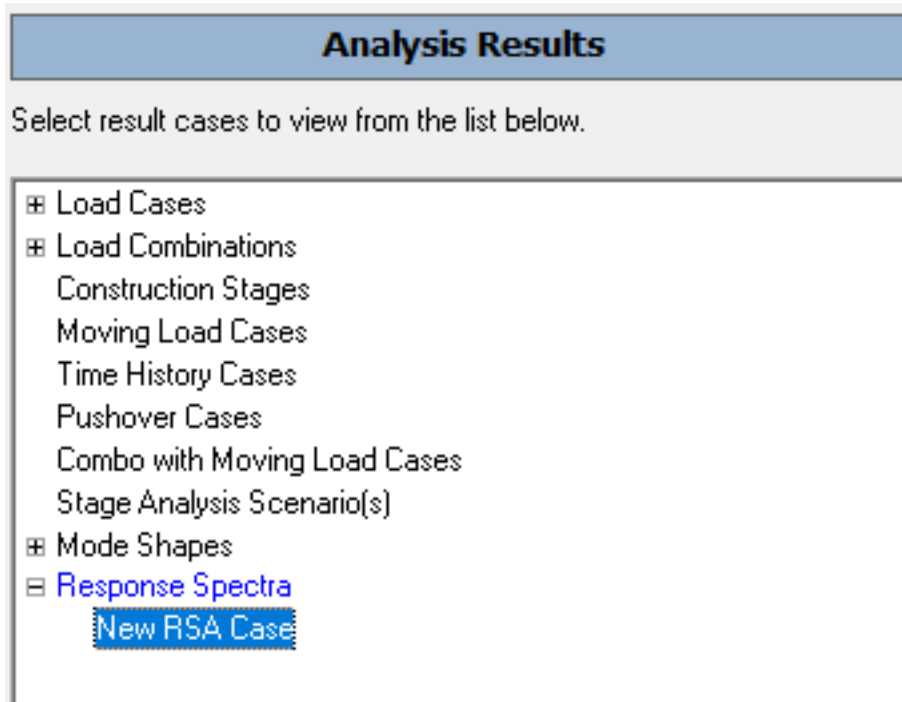

New RSA Result Case

This tool can be used multiple times to create multiple RSA cases.

*Creating Response Spectrum load cases in the Load Cases Explorer or Load Cases & Combinations spreadsheet in the **Input Data** menu and using the Response Spectrum Analysis option in the LARSA 4D **Analysis** menu are no longer recommended.*

Tool Options

Basic Options

Spectrum Curve in Direction 1

The response spectrum curve describing the ground motion applied in the global X direction (or the first direction if an angle is given).

Scale in Direction 1

A multiplier applied to the amplitudes on the curve applied in the first direction

Angle

The angle in the xy-plane from the global x-axis to the direction of the first spectrum curve, in degrees.

Modal Combination Method

The modal combination method determines how the modal values are to be combined into final results. The modal combination options are CQC for Complete Quadratic Combination and SRSS for Square Root of Sum of Squares.

The modal combination rules are for combining the peak modal responses to determine the peak value of the total response. In general, the peaks for modal responses are at different instants and the peak for combined response

is at a different instant with no information about when the peak modal values occur. Modal combination rules are approximations introduced in combining the peaks of all modal responses determined using the earthquake response spectra.

The square-root-of-sum-of-squares (SRSS) modal combination rule, developed by E. Rosenblueth (1951), provides good response estimates for structures with well-separated natural frequencies. In SRSS, the peak response in each mode is squared, the squared modal peaks are summed, and the square root of the sum is the estimate of the peak total response.

Starting in the late 1960s, there have been several formulations for the complete quadratic combination (CQC) modal combination rule that is applicable to a wider class of structures. CQC eliminates the limitations of SRSS. E. Rosenblueth and J. Elorduy (1969) were the earliest in CQC formulation. However, the most widely used CQC formulation now is by A. Der Kiureghian (1981) and his formulation is used in LARSA 4D.

According to the CQC rule, the product of the modal peak responses of the i th mode and j th mode and the correlation coefficient relating these 2 modes are summed and the square root of the sum becomes the estimate of the peak total response. The correlation coefficient varies from 0 to 1 with the value as 1 when i and j refer to the same mode. When i is not equal to j , each of the modal peak values may be positive or negative. A cross term is negative when the modal static responses assume opposite signs. Therefore, the estimate obtained by the CQC rule may be larger or smaller than the estimate provided by the SRSS rule.

Modal Damping Curve / Modal Damping Ratio

Used and required in CQC based modal combination in computation of correlation coefficients. The damping in the structure affects the shape of the response spectrum curve and it also affects the coupling between the modes for modal combination when using CQC. The damping in the structure is included in the shape of the response spectrum curve. The modal damping curve or ratio must be the damping used to develop the response spectrum curve.

Modal damping is given as either a critical damping ratio or as a modal damping curve. One is required. Both cannot be used. If the damping is not constant throughout the frequency range of the structure, a curve where the critical damping ratio can be defined as a function frequency can be assigned. This curve data is created and saved within the same database file as the response spectrum curves.

Sign Assigned to Results

Usually the results from a response spectra analysis are signless and are displayed positive. This option can be used to assign sign to the results using the sign from the mode with largest mass participation.

Options for Ground Excitation in Multiple Directions

Usually ground excitation occurs simultaneously in three directions (X, Y, and Z). The ground excitation for each direction can be given. In this case, the spatial combination method for combining the results from each direction must also be given.

Spectrum Curve in Direction 2

The response spectrum curve describing the ground motion applied in the global Y direction (or the second direction if an angle is given).

Scale in Direction 2

A multiplier applied to the amplitudes on the curve applied in the second direction.

Spectrum Curve in Direction 3

The response spectrum curve describing the ground motion applied in the global-Z direction.

Scale in Direction 3

A multiplier applied to the amplitudes on the curve applied in Z.

Spatial Combination Method

If more than one ground excitation is specified in a load case, you must also select the Spatial Combination method for combining the results from each direction. The Spatial Combination Method can be SRSS for Square Root of Sum of Squares or ABS for Absolute Sum. If the excitation is for a single direction, the Spatial Combination Method is ignored.

Ground motion in up to three directions can be specified. The directions usually coincide with the global x/y/z directions. By default, spectrum curves 1 and 2 are applied in the global x- and y- directions, respectively. The angle parameter specifies a rotation about the global z-axis to change those directions. The third direction is always in the direction of the global z-axis.

Accessing RSA Results

RSA results can be accessed in spreadsheets and graphically similar to other result cases. Modal and spatial combination are performed on-the-fly as results are requested.

When using result types that perform transformations, including joint displacements and reactions reported in user coordinate systems, member sectional forces, and compound element forces, the modal and spatial combination are correctly performed as the last step.

Caveat About Sign

Response spectra analysis combines the maxima of all modes and for all spatial directions. The response maxima of the modes are first combined for a given motion in a spatial direction. Then it is followed by a spatial combination if more than one excitation direction is specified. Due to the nature of the modal and spatial combination methods, sign information is lost in producing results.

The sign of the results is important for many reasons. Without the sign, the deformed shape of the structure can be displayed using only node-to-node displacements. The force diagrams cannot be displayed in a meaningful manner.

Modal Contribution Cases

Right-clicking the response spectra case from the Analysis Results explorer and selecting **Create Modal Contribution Cases** will create modal contribution cases for each mode of the selected response spectra case, under the "RSA Modal" result group. After creating modal contribution cases, they can be accessed similar to other result cases. Calculation of the contributions are performed on-the-fly as results are requested.

Each modal contribution case represents the contribution of a mode to the RSA result according to the response spectra case options. These cases do not include modal or spatial combination. Instead, each modal contribution is the sum of the components of the contribution from each axis (x, y, and z). Consequently, when using RSA curves in direction 1 or direction 2 in combination with direction 3, it is recommended that modal contributions are obtained from two separate RSA cases in which directions 1 and 2 have been separated from direction 3.

For More Information, please refer to the following documentation.

- Running an Analysis in *LARSA 4D User's Manual*.
- Connecting Databases in *LARSA 4D User's Manual*.

Nonlinear Buckling and Pushover Analysis

Nonlinear Buckling Analysis	197
Advantages of a Nonlinear Analysis	197
Using the Nonlinear Buckling Analysis	197
Nonlinear Pushover Analysis	199
Incremental Nonlinear and Nonlinear Buckling Analysis Options	201
Nonlinear Pushover Analysis Options	203

Nonlinear Buckling Analysis

The nonlinear buckling analysis provides an accurate indication of the loads that will cause a structure to fail. The analysis traces the deformation of the structure using incremental load applications until the structure becomes unstable. After the analysis, load-deformation curves throughout the structure show the nature of buckling leading up to collapse.

Buckling occurs when compressive membrane forces in elements are large enough to cause a reduction in bending stiffness. In beam-column elements, this is when compressive axial force reduces bending stiffness. In plates, buckling occurs when in-plane forces reduce out-of-plane stiffness.

This analysis effectively plots load versus displacements for all parts of the structure up to collapse. The slope of these plots indicates how different parts of the structure are buckling before collapse. Just before buckling, small changes in force will yield rapid deformations.

Collapse occurs when the stiffness matrix of the structure becomes singular and thus unsolvable. A singular matrix indicates the structure has no predictable deformation under any loading. Analysis stops at this point.

Advantages of a Nonlinear Analysis

The nonlinear buckling analysis provides a more accurate indication of buckling than other methods. A linear bifurcation buckling analysis, usually based on eigenvalue solutions, oversimplifies buckling behavior and often under- or over-estimates buckling conditions. A linear analysis cannot account for important nonlinearities in a structure that play a crucial role in buckling. For instance, post-buckling strength in inelastic elements could not be accounted for, and the effects of changes in geometry and load directions are also ignored. By applying small load increments in a nonlinear analysis, the nonlinear buckling analysis accurately computes the effect of buckling as the structure approaches collapse.

Using the Nonlinear Buckling Analysis

The nonlinear buckling analysis is usually performed by first applying loads known not to cause buckling, and then incrementally applying additional loads until further analysis cannot be performed because the structure has become unstable. Loads are defined in static load cases (page 113).

Appropriate increment sizes depend entirely on the structure and nature of loads. Practically, the increment on the first condition should be 1.0 because the first condition should not cause buckling. The next condition may start with a factor of 1.0, and if it causes buckling the factor should be reduced to find the point of collapse. Once the point of collapse is known, the final loading condition should be applied in small increments, such as 10 increments of 0.1 factors. The increments and number of load applications can then be refined as needed.

When performing the analysis, the analysis engine will treat all load combinations (page 115) in the project cumulatively. Each load combination will be analyzed based on the deformation that occurred in the previous combination. Factors within the load combinations determine how to incrementally load the structure.

For instance, to apply a load case in 10 increments, create a load combination that includes the static load case to apply. Assign the static load case a factor of 0.1 in the combination, and then repeat the combination 10 times.

Factors need not be equal, and load combinations can be repeated as many times as is necessary to obtain results for the desired loading conditions.

For More Information, please refer to the following documentation.

- Nonlinear Static Analysis on page 173.
- Incremental Nonlinear and Nonlinear Buckling Analysis Options on page 201.

Nonlinear Pushover Analysis

Pushover analysis is the application of a static load case with progressively increasing scale. The pushover analysis is generally used along with the response spectra analysis (page 187) for seismic analysis, and can be used for buckling analysis as well. It is a nonlinear analysis.

Models analyzed with the pushover analysis usually contain elements with inelastic material properties, such as inelastic members (page 61) and springs (page 83), because the behavior of the model beyond its elastic limits is generally the interest of the analysis. For example, plastic hinges can be modeled with inelastic hysteretic springs. Elastic beams with yielding end connections can be modeled with the connection beam element, a type of member. When spread of plasticity with a beam is of interest, the beam can be modeled as a hysteretic beam, which is also a type of member.

The initial load factor is given by the user. The stopping criteria can be specified as a maximum displacement of a joint in a particular direction.

The analysis engine automatically chooses load factor increments based on auto-stepping and arc-length options. The user can specify the minimum and maximum step size. The maximum step size will be used except when the solution does not converge or it converges too slowly, in which case smaller step sizes are used.

For More Information, please refer to the following documentation.

- Nonlinear Pushover Analysis Options on page 203.
- Nonlinear Static Analysis on page 173.

Incremental Nonlinear and Nonlinear Buckling Analysis Options

The Incremental Nonlinear Analysis is used for computing the load-deflection response of the structure as in the plastic push-over or nonlinear buckling analysis. It can also be used as a simplified staged construction analysis.

Solution convergence control from the nonlinear static analysis (page 177) applies to this analysis type as well.

Load Combinations

In this analysis option, all active load combination cases are treated as load increments. A nonlinear static analysis is performed by accumulating the loads on the structure in the same sequence as specified from all load combinations. LARSA starts with the load cases specified for the *starting load combination* and performs nonlinear static analysis for all load combination steps until it reaches the *ending load combination*.

For example, a push-over analysis will be performed on a structure to compute the nonlinear load-deflection response of the structure as the lateral loads are incremented by 10% after its dead load is applied. We want to have the results for the following load combinations:

- Dead
- Dead + 10% Lateral
- Dead + 20% Lateral
- Dead + 30% Lateral
- Dead + 40% Lateral

The load combination data for this problem will be specified as shown below:

Description	Case	Factor
Dead	Dead	1.0
Dead + 0.10*Lateral	Lateral	0.10
Dead + 0.20*Lateral	Lateral	0.10
Dead + 0.30*Lateral	Lateral	0.10
Dead + 0.40*Lateral	Lateral	0.10

This load combination data will instruct the program to do the following sequence of load applications in Restart Nonlinear Static:

- Load combination 1 (Step 1) - apply 100% of 'Dead'.
- Load combination 2 (Step 2) - add 10% of 'Lateral'.
- Load combination 3 (Step 3) - add 10% more 'Lateral'.
- Load combination 4 (Step 4) - add 10% more 'Lateral'.

- Load combination 5 (Step 5) - add 10% more 'Lateral'.

Starting Load Combination

The nonlinear static analysis starts with loads applied from this load combination case. Normally you will select the very first load combination in the data as the starting load combination. However the analysis can also start from a combination where the previous load combination has been solved in a prior run. There are limitations on the type of elements that can be used in a restart analysis performed from a previously solved load combination.

Ending Load Combination

The analysis is performed for all load combinations including the one specified as the ending one.

For More Information, please refer to the following documentation.

- Nonlinear Static Analysis on page 173.
- Running an Analysis in *LARSA 4D User's Manual*.

Nonlinear Pushover Analysis Options

Solution convergence control from the nonlinear static analysis (page 177) applies to this analysis type as well.

Pushover Stopping Criteria

Analysis will stop based upon the criteria specified here. Select the joint, the direction and the value for maximum displacement.

Auto-Increment Options

The pushover analysis is based on automatically incrementing the load vector. Specify here the multipliers for the load vector that will be used in computing the initial load vector and the incremental load vector limitation.

Initial

This is the factor multiplying the load vector for computing the load to be applied on the structure in the first load step.

Minimum

The minimum factor multiplying the load vector that is used in any load step. When the iterative analysis requires reduction in the magnitude of the load vector, the multiplier cannot be smaller than this value.

Maximum

The maximum factor multiplying the load vector that is used in any load step.

For More Information, please refer to the following documentation.

- Running an Analysis in *LARSA 4D User's Manual*.

Linear and Nonlinear Time History Analysis

Linear Time History Analysis	207
Linear Time History Analysis within Staged Construction Analysis	207
Linear Time History Analysis Options	209
Nonlinear Time History Analysis	211
Overview	211
Newmark-Beta with Newton-Raphson	211
Sparse Solver Technology	211
Nonlinear Time History Data	211
Nonlinear Time History Analysis within Staged Construction Analysis	211
Nonlinear Time-History Analysis Options	213
Geometric Nonlinearity	213

Linear Time History Analysis

Time history analysis is for computing the response of the structure to time-dependent loads which are specified as force, displacement, or acceleration excitation curves at joints, uniform base acceleration, or factored static loads. Multiple excitations can be specified simultaneously.

The excitations in a time history analysis are organized into time history load cases (page 137) containing excitations and initial conditions at joints. Multiple excitations can be specified simultaneously within a load case. For example, different displacement-based time history excitations at different supports can be applied to simulate variable multi-support excitation such as in long-span bridge structures. Or, separate load cases can be used to perform multiple analyses. Each time history load case generates a group of result cases for all the integration time steps solved and saved.

Excitation curves are loaded from external time-history databases. See Connecting Databases [in *LARSA 4D User's Manual*].

The initial displacement, velocity, and acceleration conditions of the structure can be specified in time history load cases. The default assumes the structure is initially at rest with zero displacements, velocities and accelerations.

A static load case containing joint, member, and plate loads can be chosen in conjunction with a “factor” excitation function (starting in version 8.01). An “inconsistent load vector” method is used for these element loads, meaning element loads are transferred to joints and element-internal forces (such as Member Sectional Forces (page 287) and Plate Forces on Center (page 303)) will not account for these loads. When using factored static element loads, only results reported at joints should be used.

The mass matrix automatically includes the mass of members (from section area and weight density) and plates (from thickness and weight density). Element mass is computed as a lumped mass matrix. When the element has an end offset, this matrix becomes non-diagonal when transformed to the element's joints. No other elements automatically include mass in dynamic analysis. Mass elements (page 91), which are ignored in static analysis, are used to add additional (usually nonstructural) mass in dynamic analysis. It is also possible to compute mass from static loads by putting static loads in a load case (page 113) marked as representing dynamic mass rather than static loading.

Dynamic Rolling Stock Analysis is a type of Linear Time History Analysis. See Linear Static Moving Load Analysis and Dynamic Rolling Stock Analysis (page 217). Available starting in version 8.01.

Linear Time History Analysis within Staged Construction Analysis

Linear time history analysis can be performed as a scenario within Staged Construction Analysis.

The mass matrix includes element mass only for elements that are constructed and have had self-weight applied in previous construction steps, i.e., unconstructed elements, elements constructed with the stiffness-only option, and elements that have not yet had a self-weight load case applied will not have their mass included. Additional dynamic mass is included from all load cases in the project with the Is Dynamic Mass? (page 113) option set to Yes (and so these load cases should not be included as loading activities in the construction sequence).

For More Information, please refer to the following documentation.

- Time History Loads on page 137.

- Nonlinear Time History Analysis on page 211.
- Linear Time History Analysis Options on page 209.

Linear Time History Analysis Options

Time Step Size

Specify the time step sizes used in Newmark Integration.

Time Step Size

The time step interval, in seconds.

Save/End Options

This entry determines the ending time step to be analyzed and at what time interval solutions should be recorded.

Solution Ending Time

The analysis starts at time zero and ends with the time specified here. The value specified here depends on how time is measured in the excitation records.

Step Interval for Saving Results

The step interval for saving results. The results for the computed displacements, velocities, accelerations, and element forces are saved at the interval specified here. If the interval is 1, the results are saved for all integration steps. Two, for instance, specifies to save every other integration step.

Rayleigh Damping Constants

Rayleigh damping, \mathbf{c} , is defined as $a_0\mathbf{m} + a_1\mathbf{k}$, where a_0 is the mass-proportional Rayleigh damping constant and a_1 is the stiffness-proportional Rayleigh damping constant.

The coefficients a_0 and a_1 can be determined from specified modal damping ratios, r_i and r_j , for the i and j modes, respectively. If both modes are assumed to have the same damping ratio r , then

$$a_0 = (2 r w_i w_j) / (w_i + w_j) \quad a_1 = 2 r / (w_i + w_j) \quad \text{where } w_i \text{ and } w_j \text{ are the two natural frequencies in rad per sec.}$$

Note: Rayleigh damping constants are not the modal damping ratios.

For More Information, please refer to the following documentation.

- Running an Analysis in *LARSA 4D User's Manual*.
- Linear Time History Analysis on page 207.

Nonlinear Time History Analysis

Overview

The nonlinear time history analysis is an extension of the Linear Time History Analysis (page 207) in which elements with geometric nonlinearity (e.g. cables) and elements with material nonlinear behavior (e.g. nonlinear elastic and inelastic springs) can be included. The use of such an advanced analysis method also may be the most cost effective approach to estimate the response of a structure to dynamic loads when nonlinear behavior needs to be accounted for realistically.

The most common applications of nonlinear time history in structural engineering are dynamic response to seismic and blast loadings when the structure includes elements with geometric nonlinearity like cables, or protective devices like seismic isolators, or elements with material nonlinearity such as inelastic springs with energy dissipater characteristics.

Newmark-Beta with Newton-Raphson

The nonlinear time history analysis is carried out by using the Newmark-Beta time integration algorithm with the (full) Newton-Raphson method using iterations within each integration time step. The number of iterations performed within each time step is controlled by user specified convergence criteria.

Newark and Newton-Raphson methods are used because of their superior accuracy. The solution is carried out in an incremental form. The forces from the seismic isolation elements and the energy dissipation elements (viscous, frictional and hysteretic devices) are computed at every iteration during the solution process.

The solution algorithm has the option of using a constant time step or adaptive variable time step. In the variable time step option, the step size is reduced automatically to a fraction of its value when needed for better convergence.

Sparse Solver Technology

The nonlinear time history analysis requires significant computational effort and computer time. With the use of the sparse solver technology, the computational effort is drastically reduced when compared to more widely known and used skyline methods. The nonlinear time history analysis in LARSA 4D requires the Direct Sparse Solver.

Nonlinear Time History Data

The setup for a nonlinear time history analysis is identical to that of the Linear Time History Analysis (page 207), with extra analysis options specified.

The nonlinear time history analysis requires more solution control parameters than other analysis options. These parameters include options to choose integration method, constant or self-adaptive time steps, choice of iterative method, and setting the convergence criteria. See Nonlinear Time-History Analysis Options (page 213).

Nonlinear Time History Analysis within Staged Construction Analysis

Nonlinear time history analysis can be performed as a scenario within Staged Construction Analysis.

The mass matrix includes element mass only for elements that are constructed and have had self-weight applied in previous construction steps, i.e., unconstructed elements, elements constructed with the stiffness-only option, and elements that have not yet had a self-weight load case applied will not have their mass included. Additional dynamic mass is included from all load cases in the project with the Is Dynamic Mass? (page 113) option set to Yes (and so these load cases should not be included as loading activities in the construction sequence).

For More Information, please refer to the following documentation.

- Linear Time History Analysis on page 207.
- Nonlinear Time-History Analysis Options on page 213.

Nonlinear Time-History Analysis Options

Geometric Nonlinearity

Include Geometric Nonlinearity

If this option is checked, geometric nonlinearity is included in the analysis.

For More Information, please refer to the following documentation.

- Running an Analysis in *LARSA 4D User's Manual*.
- Nonlinear Time History Analysis on page 211.

Static Moving Load Analysis, Dynamic Rolling Stock Analysis, Influence-based Live Load Analysis, and Vehicle-Track-Structure Interaction Analysis

Linear Static Moving Load Analysis and Dynamic Rolling Stock Analysis	217
Preparing a Moving Load Analysis	217
Linear Static Moving Load Analysis	217
Linear Dynamic Rolling Stock Analysis	218
Standard Vehicles	219
AASHTO and CALTRANS Vehicles	219
AASHTO Load Patterns for Influence Analysis	219
IRC Load Patterns for Influence Analysis	220
Influence Line & Surface Analysis	223
Influence Analysis Overview and Options	225
The Assumption of Linearity	225
The Vehicle Loading Algorithm	225
Performing an Influence Analysis	226
General Loading Parameters	227
Vehicular Loading Options	230
Uniform/Patch Loading Options	234
Procedure: Getting Results	234
Suggestions for Influence Analysis	237
Suggestions for Speed	237
Vehicle-Track-Structure Interaction Analysis	239
Methodology and Rationale	239
Model Setup Procedure	240
Accessing Dynamic Results	244

Linear Static Moving Load Analysis and Dynamic Rolling Stock Analysis

The moving load analysis simulates the movement of one or more vehicles passing over a structure on a user-defined path. Linear Static Moving Load Analysis and Linear Dynamic Rolling Stock Analysis are available.

Preparing a Moving Load Analysis

To prepare a moving load analysis, begin by creating a lane (page 105), which defines the path of the vehicle load on the structure. The torsion effects on beam elements are computed and included if lane eccentricity is specified.

Then connect a vehicle load pattern database (see Connecting Databases [in *LARSA 4D User's Manual*]). LARSA 4D includes several Standard Vehicles (page 219) that can be used. User-defined vehicle patterns can be created using the Database Editor [see “The Database Editor” in *LARSA 4D User's Manual*].

Then, create a load case. The type of the load case in which the moving loads are entered should be set to Moving (Static) for a Linear Static Moving Load Analysis or Time History for a Linear Dynamic Rolling Stock Analysis.

Finally, add Moving Loads (page 133) to the load case. For each moving load, select a lane, a vehicle pattern, a direction of loading (typically Global -Z) and motion information including an initial position, a forward increment or speed (depending on the analysis type), and a direction (forward or backward). If multiple Moving Loads are given in the same load case, the vehicles are applied simultaneously. By loading multiple lanes simultaneously with loading factors, the effect of distributing the load of a vehicle across lanes can be simulated.

Linear Static Moving Load Analysis

This analysis automatically generates all of the load cases for vehicle positions along the user-defined path and performs a Linear Static Analysis (page 169) on each generated case. In each successive case, the vehicle load pattern is moved forward by the Position Increment given in the moving load (page 133).

The moving load analysis is a linear analysis and therefore the structure should not include nonlinear elements such as cable elements or compression only foundation spring type nonlinear elements. If nonlinear elements are used in the model during moving load analysis, the elements will be analyzed as an equivalent linear element.

The type of the load case in which the moving loads are entered should be set to Moving (Static).

The results of the generated moving load cases can be combined with any other load case using Load Combinations (page 115) or Linear Result Combinations [in *LARSA 4D User's Manual*], and envelopes are simplified with Extreme Effect Groups [in *LARSA 4D User's Manual*].

Linear static moving load analysis is also used in the first step of influence-based live load analysis. See Influence Line & Surface Analysis (page 223).

Linear Dynamic Rolling Stock Analysis

The Linear Dynamic Rolling Stock Analysis is a Linear Time History Analysis (page 207). In each time step, the vehicle is moved forward according to the Vehicle Speed given in the moving load (page 133). This analysis type is available starting in version 8.01.

Like the Linear Static Moving Load Analysis, the Linear Dynamic Rolling Stock Analysis is a linear analysis and therefore the structure should not include nonlinear elements (see above). However, it is a dynamic analysis in which the mass and motion of the structure is considered. The mass of the vehicle is not considered and should be small relative to the mass of the structure and uncoupled with the resonances of the structure.

An “inconsistent load vector” method is used, meaning element loads are transferred to joints and element-internal forces (such as Member Sectional Forces (page 287) and Plate Forces on Center (page 303)) will not account for these loads. Only results reported at joints should be used.

The type of the load case in which the moving loads are entered should be set to Time History.

The Linear Time History Analysis Options (page 209) are applicable to this analysis type.

For More Information, please refer to the following documentation.

- Lanes on page 105.
- Standard Vehicles on page 219.
- Connecting Databases in *LARSA 4D User's Manual*.
- The Database Editor in *LARSA 4D User's Manual*.
- Moving Loads on page 133.
- Linear Time History Analysis on page 207.
- Vehicle-Track-Structure Interaction Analysis on page 239.

Standard Vehicles

Various standard vehicle types are supplied with LARSA 4D. These vehicles include AASHTO (American Association of State Highway and Transportation Officials) trucks, AASHTO alternate military loads, CALTRANS P type permit loads and Indian Roads Congress vehicles.

AASHTO and CALTRANS Vehicles

The AASTHO H loadings consist of a two-axle truck, the HS loadings consist of a tractor with semi-trailers, and CALTRANS P loadings are special vehicular loads. These loads are found in the file `movedata.dml`.

The patterns are one dimensional: Axles are point loads applied to the center-line of lanes.

- HS20-44 is an AASHTO HS truck consisting of a tractor truck with a semi-trailer. The total weight is 72 kips.
- HS15-44 is an AASHTO HS truck with 75 percent loading of HS20.
- H20-44 is an AASHTO H truck consisting of a two-axle truck. The total weight is 40 kips.
- H15-44 is the Standard H truck with 75 percent loading of H20.
- H20-S16-T16 consists of five axles with total weight of 104 kips.
- HN-72 is a highway normal truck with total weight of 54 kips.
- HO-72 is a highway overweight truck with total weight of 108 kips.
- LEGAL-TYPE3 is an AASHTO Legal Load Type 3 with three axles and the total weight is 50 kips.
- LEGAL-TYPE3S2 is an AASHTO Legal Load Type 3S2 with five axles and the total weight is 72 kips. Input Data Description 9-137
- LEGAL-TYPE3-3 is an AASHTO Legal Load Type 3-3 with six axles and the total weight is 80 kips.
- P5, P7, P9, P11 and P13 are CALTRANS-P loads (permit design live loads). The distance between each axle is 18 feet. The first axle is 26 kips and the remaining axles are 48 kips. The vehicles have 3, 4, 5, 6, and 7 axles, respectively.

AASHTO Load Patterns for Influence Analysis

These load patterns are provided primarily for use in influence-based analysis following the AASHTO LRFD design code for live load analysis. Some are defined with variable axle spacing, which only applies in that type of analysis. These patterns are found in the files `movedata.dml` or `AASHTO Vehicle Patterns.dml`.

Some of these patterns are two dimensional. 2D load patterns can only be used with influence-based analysis.

- HL-93/HS20-44 Design Truck has three axles of 8, 32, and 32 kips. The spacing between the front two axles is 14 feet, and in influence-based analysis the spacing between the rear axles varies between 14 and 30 feet. This load pattern does not specify a width for the vehicle, so should not be used in influence surface analysis without noting the implications for vehicle placement and the side-to-side spacing option.
- HL-93 Design Tandem consists of two 25 kip loads spaced 4 feet apart. This load pattern does not specify a width for the vehicle, so should not be used in influence surface analysis without noting the implications for vehicle placement and the side-to-side spacing option.

- HL-93/HS20-44 2D Design Truck has six wheels, modeled as point loads offset 3 feet each way from the vehicle center. It has the same spacing, including variable axle spacing, as the one-dimensional HL-93 pattern above, except that the axles are split into pairs of wheels.
- AASHTO Point 18 kip moment/26 kip shear/13.5 kip moment/19.5 kip shear are point load patterns with the given type and magnitude. They are provided for using the influence-based analysis with span loading in the AASHTO code.

There are two vehicle load patterns that model tire contact area with distributed loads. Tire contact area is specified as uniformly distributed loads over a rectangular surface at the appropriate transverse coordinates.

- HL-93 Design Truck T/C is similar to the HL-93 Design Truck, except that tire contact area is more precisely modeled by specifying two tires per axle at the appropriate transverse positions, and by including transverse width and tire length. This pattern does not include variable axle spacing, however, and tire contact area rarely plays a role, so the HL-93/HS20-44 2D Design Truck Pattern is recommended to be used in place of this pattern.
- HL-93 Design Tandem T/C or HL-93 Design Tandem 2D is similar to the HL-93 Design Tandem, except it has four loads, two for the front axle and two for the back, each 12.5 kips distributed over a 10x20 inch area. The tires are laterally offset from the center-line by 3 feet.

Other load patterns are available but are no longer recommended for use:

- HL-93 Design Two Trucks consists of two HL-93 design trucks at variable spacing, but each truck having fixed axle spacing at 14'. The use of this load pattern is deprecated in favor of using the number of vehicles to load and minimum vehicle spacing options of the influence-based analysis.

IRC Load Patterns for Influence Analysis

These load patterns are provided primarily for use in influence-based analysis following the Indian Roads Congress design code for live load analysis. These patterns are found in the file `IRC Load Patterns.dml`.

These patterns are all two dimensional: Rather than specifying axles, the actual wheels of the load patterns are specified (generally two per axle) at the appropriate transverse position. In patterns marked "Distributed," tire contact area is specified as uniformly distributed loads over a rectangular surface. Those not marked "Distributed" have wheels modeled as point loads. Distributed patterns are provided for the influence surface analysis.

When used in the standard moving load analysis, transverse positions of wheels are ignored. All wheels are lumped on the center-line of the lane.

- IRC Class AA Tracked is the Class AA tracked tank pattern, comprising two 350 kN distributed loads 3.6 meters long and .85 meters wide, offset by 1 meter in each direction from the lane center-line.
- IRC Class AA Wheeled is the Class AA wheeled tank pattern, comprising two axles with four wheels per axle of 37.5 and 62.5 kN.
- IRC Class 70R Tracked is the Class 70R tracked tank similar to the Class AA tracked tank but with a length of 4.57 meters.
- IRC Class 70R Load Train is the 7-axle train with load intensities of 40, 60, and 85 kN per wheel (two wheels per axle).
- IRC Class 70R Bogie is the bogie pattern with two axles comprising four wheels of 100 kN each.
- IRC Class A Train is the 8-axle train with load intensities of 13.5, 57, and 34 kN per wheel (two wheels per axle).

- IRC Class B Train is the 8-axle train with load intensities of 8, 34, and 20.5 kN per wheel (two wheels per axle).

For More Information, please refer to the following documentation.

- Linear Static Moving Load Analysis and Dynamic Rolling Stock Analysis on page 217.

Influence Line & Surface Analysis

Influence line and surface analysis is an extension of the moving load analysis which uses the effects of a unit load placed at many locations to rapidly compute the envelope of effects of arbitrarily complex load patterns.

Influence Analysis Overview and Options	225
The Assumption of Linearity	225
The Vehicle Loading Algorithm	225
Performing an Influence Analysis	226
General Loading Parameters	227
Vehicular Loading Options	230
Uniform/Patch Loading Options	234
Procedure: Getting Results	234
Suggestions for Influence Analysis	237
Suggestions for Speed	237

Influence Analysis Overview and Options

Influence line and surface analysis is an extension of the moving load analysis which uses the effects of a unit load placed at many locations to rapidly compute the envelope of effects of arbitrarily complex load patterns.

An influence line or surface analysis is often needed to determine the design conditions that are required in bridge design codes. In these codes, it is not sufficient to envelope the results of a single vehicle placed at each station along a girder. There are a large number of variables, including vehicle location and length, number of vehicles, and lane locations, that need to be controlled simultaneously to determine the worst case scenarios. In many cases there are so many loading possibilities that it would not be cost effective to run a complete analysis for each.

Influence analysis is the combination of 1) an assumption of linearity, and 2) efficiently searching the loading possibilities for the extreme effects using an appropriate algorithm.

The Assumption of Linearity

The core of an influence line or surface analysis is the assumption of linearity, that is, that the result of two simultaneous loads is equal to the sum of the results of the two loads when each is placed alone. This assumption allows results to be computed for different design conditions without the need to re-run a full model analysis because new results can be determined simply by adding and multiplying previous results.

In practice, influence analysis is carried out by first computing the results for a load of magnitude 1.0 (a unit load) either at pre-set increments along a line or curve (an influence line) or on a grid of locations (an influence surface). For instance, an influence line analysis of a 100-foot span with a 1-foot increment would require 100 result cases; an influence surface analysis of a 100-foot by 24-foot lane surface, with a 1-foot longitudinal and half-foot transverse grid spacing would require 4,800 result cases. The results are called influence coefficients. The effect of a wheel or axle is computed by multiplying the results of the unit load (the coefficient) at the location of the wheel/axle by the magnitude of the wheel/axle (or, if the wheel/axle does not fall directly on the location of a unit load, then by interpolating the results of the two (for influence lines) or four (for influence surfaces) nearest unit loads). The effect of vehicle is the sum of the effects of its wheels or axles, etc.

Uniform lane loading is similarly computed from unit loads by adding together the effects of the unit loads within the region of lane loading, and multiplying by an appropriate factor according to the magnitude of the load (and for influence surfaces, the transverse width over which the load is placed).

Bear in mind that the quality of influence analysis results rests on the suitability of the assumption of linearity as well as on the choice of unit load spacing.

For use with AASHTO LRFD, please see Guide to AASHTO LRFD Section 3.6: Live Loads [in *LARSA 4D User's Manual*].

The Vehicle Loading Algorithm

The second part of influence analysis is the vehicle loading algorithm. No loading algorithm could try each possible combination of vehicle locations one-by-one. Such a process would take an inordinate amount of computing time.

The current algorithm implemented by LARSA 4D (starting with version 7.5) will find the worst-case loading configurations of vehicles and lane load. Note that although the unit loads are computed at a finite number of locations

(i.e. at fixed spacing), through interpolation it is possible to compute the effects of loading at any location on or off the grid of influence coefficients. Nevertheless, LARSA 4D's influence algorithm assumes that if two loads are spaced no closer than the coefficient spacing, then one must have the maximum effect (that is, the maximum cannot occur between them). Additionally, vehicles with variable axle spacing are in some cases assumed to have either their minimum or maximum spacing. Only point force loads are supported in vehicle patterns.

This so-called "standard solution method" replaces and improves on the algorithm used in LARSA 4D version 7.01 and earlier. The improvements include the ability for trucks to be placed at the very edges of design lanes regardless of the transverse coefficient spacing, improved accuracy by solving for the best lane and vehicle positions simultaneously, improved speed especially on multi-core/multi-processor computers, simultaneous optimization over multiple lane configurations (different truck types and limits on the number of trucks of any type), and the ability to combine the span-by-span requirement of AASHTO LFD with multiple presence factors. The previous algorithm was a heuristic which for a large number of vehicles approximated and did not necessarily solve for the most extreme effect.

The influence algorithm effectively simulates all of the vehicle configurations that arise from the different number and location of design (traffic) lanes and vehicles placed, the direction of each vehicle (forward or backward), and the length of variable-axle-position load patterns. A traffic lane is a single row of vehicles. Design lanes are always parallel to the centerline of the influence surface. An influence line is always exactly one design lane.

One advantage of the influence surface method over the influence line method is the ability to apply "two-dimensional" load patterns. The load patterns are so named because the axles are arranged over a surface, rather than in a line. It is always recommended to use "2D" vehicle load patterns when using influence surfaces. For AASHTO LFD and LRFD, see the standard database AASHTO Vehicle Patterns. Only 2D load patterns model the width of vehicles, which plays a role in the requirements for vehicle placement within lanes.

Performing an Influence Analysis

An influence analysis is performed in the following manner:

- A lane or surface (page 105) is defined specifying the path of vehicles on the structure (for influence lines) or the surface on plate elements on which vehicles will be placed (for influence surface). This defines the path or surface on which unit loads are placed to compute the coefficients that make up the influence line or influence surface. A lane can be placed on member or plate elements, while a surface must be defined on plate elements only and its width must be given.
- Note that for influence surfaces, what LARSA 4D calls a "lane" is the complete deck surface with possibly multiple rows of traffic, not an individual traffic or design lane. This rectangular "lane" surface may extend over the bounds of the structure in the case that the structure is skewed or otherwise non-rectangular.
- An influence load (page 135) is created on each lane. The influence load is simply a point load with a magnitude of 1 with forward (longitudinal) and for influence surfaces transverse grid spacing. The elements in the lane (or surface) determine how the loading is distributed onto the structure. For influence line analysis that requires the distribution of the axles across multiple girders, specify multiple lanes, one on each girder, within a single load case, and use factors that add to 1.0. (In this case, each influence coefficient will actually be generated by two loads whose magnitude sums to 1.0, with the loads marching along the girders simultaneously.)
- Run a Linear Static Moving Load Analysis and Dynamic Rolling Stock Analysis (page 217) to generate an influence line or surface, i.e. the results of unit loading called influence coefficients.
- Influence result cases described below are set up with the design-appropriate vehicle and lane loading parameters. These result cases will compute and show the worst-case results and corresponding loading configuration.

In an influence line analysis, each axle or wheel of the loaded vehicles will be lumped on the centerlines of the members in the lane path, unless either 1) the lane is specified with offsets that take it away from the member centerline, 2) if a transverse offset is specified in the influence result case options, or 3) the load pattern has transverse offsets specified on the wheels. In cases 2 and 3, a second set of influence coefficients, based on a one-unit torque, is used to compute the moment induced by the eccentricity. Method 1 should not be combined with methods 2 and 3. Additionally, load distributions across multiple girders can be accomplished either through rigid cross-beams connecting girders, or by loading multiple lanes simultaneously (see below).

With the influence surface method, load distribution is accomplished automatically because of the nature of the models used for influence surfaces. Plate decks by their nature will spread load from the point of contact with the wheel throughout the deck, and to any connected elements.

General Loading Parameters

After the Moving Load Analysis is complete, create an influence result case by opening the **Results** menu and choosing **Influence Line/Surface Case**. This is where the lane and load pattern, and other options, are chosen. The first screen of options is shown below:

The screenshot shows the 'Influence Analysis' dialog box with the following settings:

- Result Case Name:** LL
- Standard Solution Method:** Standard Solution Method
- Influence Coefficients:** Influence Surface - Influence Load
- Design Lane Width:** 12 ft
- Overall Factor:** 1
- Multiple Presence Factors:** 1.2, 1, 0.85, 0.65
- Transverse Offset:** 0 ft
- Overturning Effect Factors (+side):** (none)
- Longitudinal Factors:** (none)
- Load for Extreme Force Effects
- Complete Patterns Only
- Coefficients are Signless

General Parameters for an Influence Result Case

The following options are presented.

Solution Method

The Standard Solution Method should be used for all new projects. Also available is the algorithm used in LARSA 4D prior to version 7.5, called the 7.01 Compatible Method, with either the one-vehicle-per-lane or two-vehicles-per-lane options.

Influence Coefficients

Choose the lane from the list. The list shows all influence coefficient results already generated by the last Moving Load Analysis.

Design Lane Width

For influence surfaces, the width of a design lane, i.e. a single row of traffic. Typically 12 feet. With the standard solution method, LARSA 4D will place as many lanes as will fit on the surface, according to the width of the surface specified in the input geometry, simultaneously maximizing the effect according to any multiple presence factors. (With the 7.01-compatible algorithm, LARSA 4D will load only as many lanes as are needed to place the maximum number of vehicles specified.)

Transverse Offset

This option for influence lines simplifies the creation of multiple lanes at different transverse locations. With this method, moments on the girder are computed by adding in the effect of special unit-torque influence coefficients, multiplied by the transverse offset and the axle/wheel magnitude. This method may be more useful than adjusting the lane geometry because it eliminates the need to create a separate lane definition (page 105) for each traffic lane. Only a single lane definition, specified on the centerline of the bridge girder, is necessary to compute the effects of vehicles on parallel lanes. The sign convention generally follows the right-hand-rule but is truly determined by the orientation of the member elements and the direction of the unit force loading, so it is always best to verify this by inspection.

Load for Extreme Force Effects

When this option is checked, vehicle wheels/axles and lane loading locations that do not contribute to extreme forces are not considered. For example, when enveloping for maximum forces, axles that cause negative forces are ignored. Normally this option should be on. In LARSA 4D 7.6, this option does not affect lane loading which is always applied in a patch loading manner. In LARSA 4D 7.1, this option must be turned on to apply lane loading as patch loading.

Complete Patterns Only

Often the worst position of a vehicle is when it is only partially on the lane or surface. When this option is checked, only vehicle positions where all wheels/axles fall on the lane or surface are considered. When no wheel/axle is at the zero-position of the vehicle load pattern, the zero-position must also be on the surface. When this option is not checked, the vehicle may extend past the beginning or end of the line or surface (longitudinally), but for an influence surface vehicles will never extend transversely outside of a design lane, which are always fully contained within the defined surface area.

Overall Factor

The overall factor is applied to the final influence results. Usually this is 1.0.

Multiple Presence Factors

For influence surfaces, this is a set of factors to apply to the final results depending on the number of lanes actually loaded. The number of lanes loaded will depend on how many lanes fit on the roadway surface and whether adding additional vehicles can produce a more extreme effect (since more lanes usually means a reduced factor). When editing multiple presence factors, enter a table whose first column is the number of lanes loaded and whose second column is the corresponding factor (see below). (With the 7.01-compatible solution algorithm, this option applies only to the one- or two-vehicles-per-lane option.)

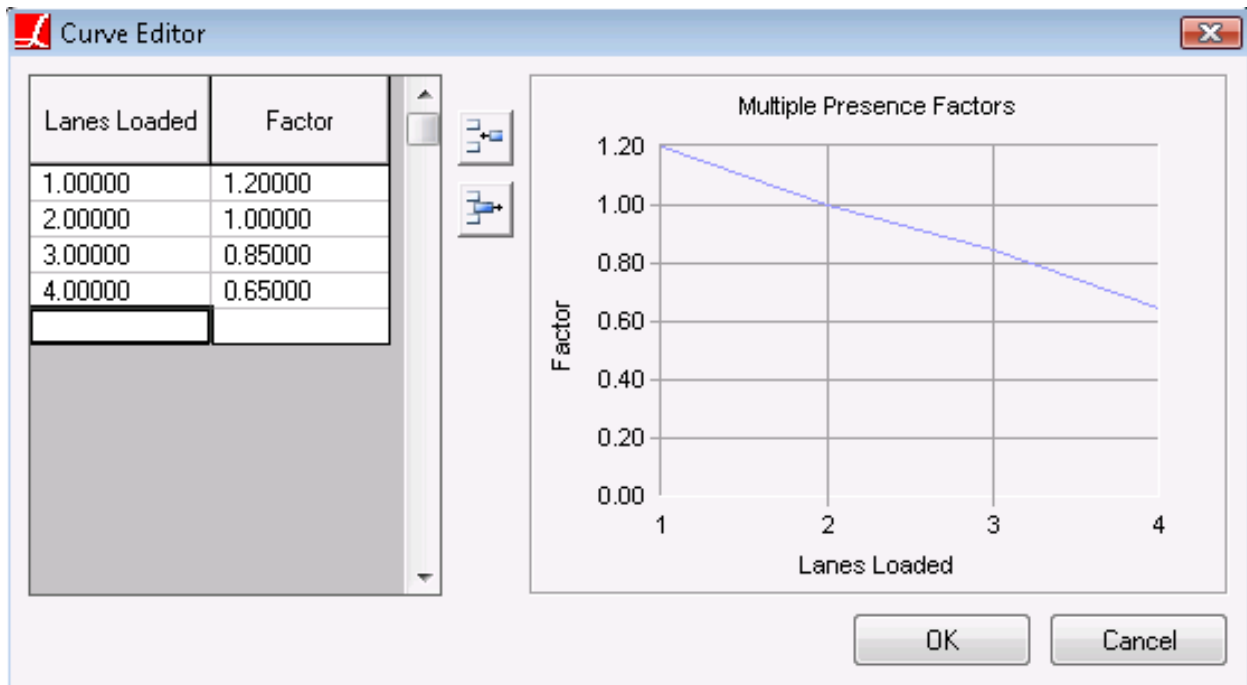

Multiple Presence Factors

Overturning Effect Factors

For influence surfaces, this option allows the vehicle load pattern to be modified according to a common factoring scheme used with superelevation. Load factors are specified for the wheels on the side of the vehicle closest to the positive transverse side of the influence surface (always check which way this is by inspection). On the assumption of two wheels of equal magnitude per axle, a corresponding factor of 2.0 minus the factor will be applied to the wheels on the other side of the vehicle (thus resulting in no overall change in applied force). To accommodate varying superelevation along the roadway, the factor is entered as a curve with stations measured from the start of the surface. If the roadway has a superelevation in which the negative transverse side of the surface is elevated, the overturning effect will cause the vehicle load to shift toward the positive transverse side. In this case, specify a factor between 1.0 and 2.0. If the superelevation is angled the opposite way, specify a factor between 0.0 and 1.0. The figure below shows how to enter a factor that is constant along the length of a 1000-foot bridge. (Although a similar factoring scheme has been used for centrifugal force effects, those effects should not be included using this feature when modeling live load as described in Guide to AASHTO LRFD Section 3.6: Live Loads [in *LARSA 4D User's Manual*] because the overturning effect is captured by the vertical offset of the surface instead.)

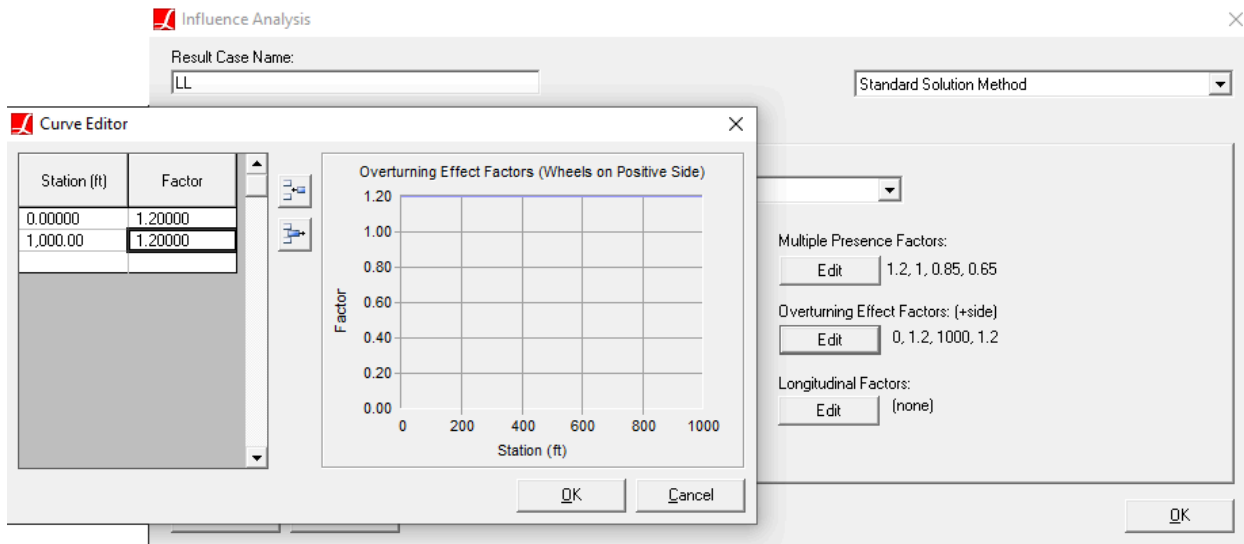

Overturning Effect Factors

The following advanced options are for modeling centrifugal and braking effects.

Longitudinal Factors

This option allows an overall factor to be applied that varies longitudinally. It is primarily intended to be used when modeling centrifugal forces on a multi-curve bridge. For an example, see Guide to AASHTO LRFD Section 3.6: Live Loads [in *LARSA 4D User's Manual*].

Coefficients are Signless

This option is used to model braking forces, which can occur in either longitudinal direction if vehicles are permitted to travel in either direction. When this option is on, each influence coefficient is treated as if it were its absolute value.

Vehicular Loading Options

The second set of options pertains to vehicular loading. With the standard solution method, vehicular loading may be omitted to apply only uniform lane loading. The options are shown in the following figure and are described below. The figure shows standard options for AASHTO LRFD.

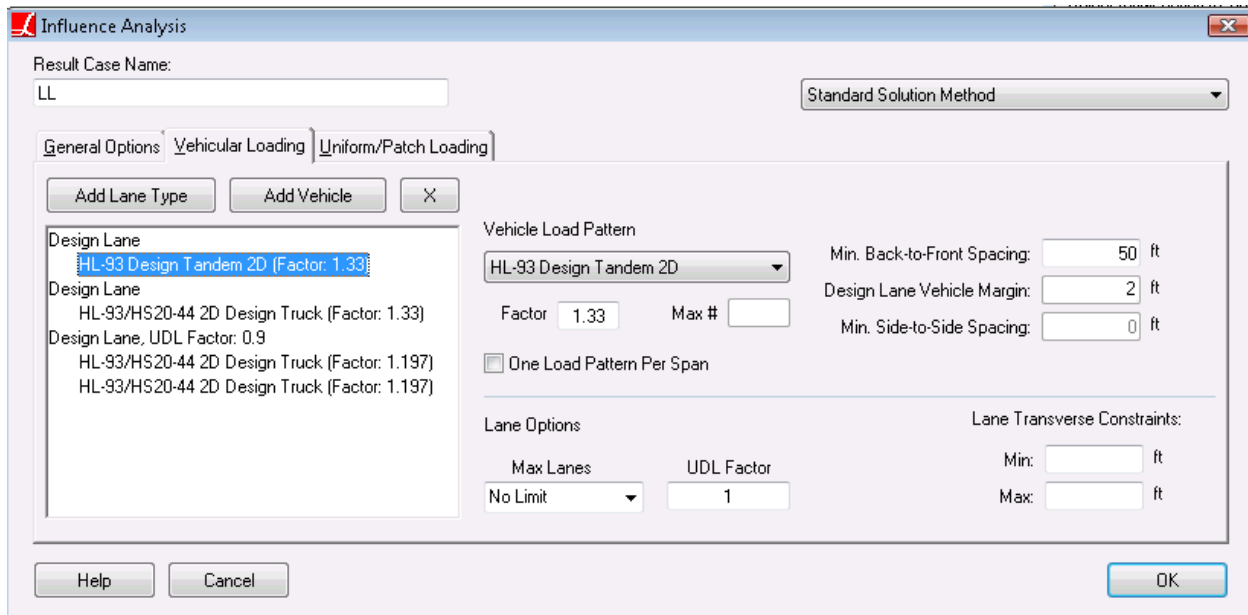

Combined Cases

The following explanation applies to the standard solution method only.

In the vehicular loading options tab, the user specifies the vehicle type(s) to apply to the structure, and associated options. In the simplest case, a single vehicle type is applied to the structure. However, it is also possible to apply different vehicle types in each lane. This is explained later.

Vehicle Load Pattern

The load pattern to apply to the structure, from the load patterns in any connected databases (see *Connecting Databases* [in *LARSA 4D User's Manual*]). The vehicle load pattern does not include lane loading.

Factor

For each load pattern, a factor may be applied to the magnitudes of the loads. The factor is applied to the vehicle axles only, and not any additional uniform lane loading specified.

To place two vehicles within a design lane, click the Add Vehicle button and then set the load pattern and factor of the second vehicle. (By default it will copy the settings of the first vehicle.)

The following options apply to all lane types (explained below):

Min. Back-to-Front Spacing

When multiple vehicles are placed in the same lane configuration, this is the smallest space allowed between the rear-most axle of one vehicle and the start of another (station zero in the vehicle definition).

Design Lane Margin

For influence surfaces, the margin on *each* side of design lanes in which vehicle loading is excluded. Thus for a 12 foot lane, a 1 foot margin means a possible loading area of 10 feet. This is depicted in the following figure:

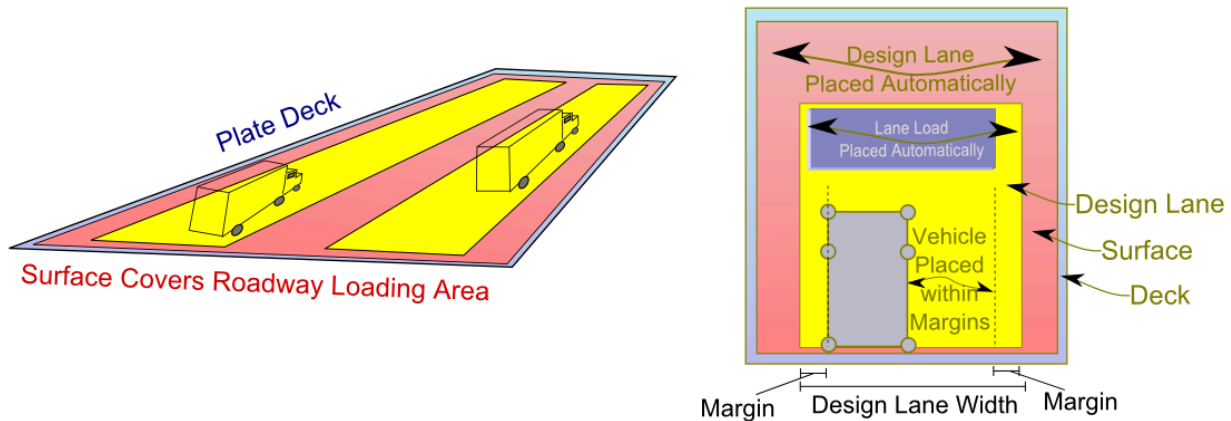

Design Lanes and Vehicle Margin

One Load Pattern Per Span

The AASHTO LFD design code requires that in certain cases loads be applied only once per span. This option enforces that constraint. Be sure to add multiple load patterns to the lane configuration and to place *span break markers* in the lane path definition (page 105). Place span break markers between geometry points that fall on different spans in the structure. Span break markers should be placed in the row immediately following a geometry point positioned at the end of a span. For instance, if a span ends between members 3 and 4, a geometry point should be created either on member 3 but with an *x-offset of end* or, as is usually done, on member 4 but with the default *x-offset of start*. A span break marker then follows this row. Thus note that a span break marker usually follows a geometry point on a member that is actually on the next span. Span break markers must be added to the lane definition before the moving load analysis is performed.

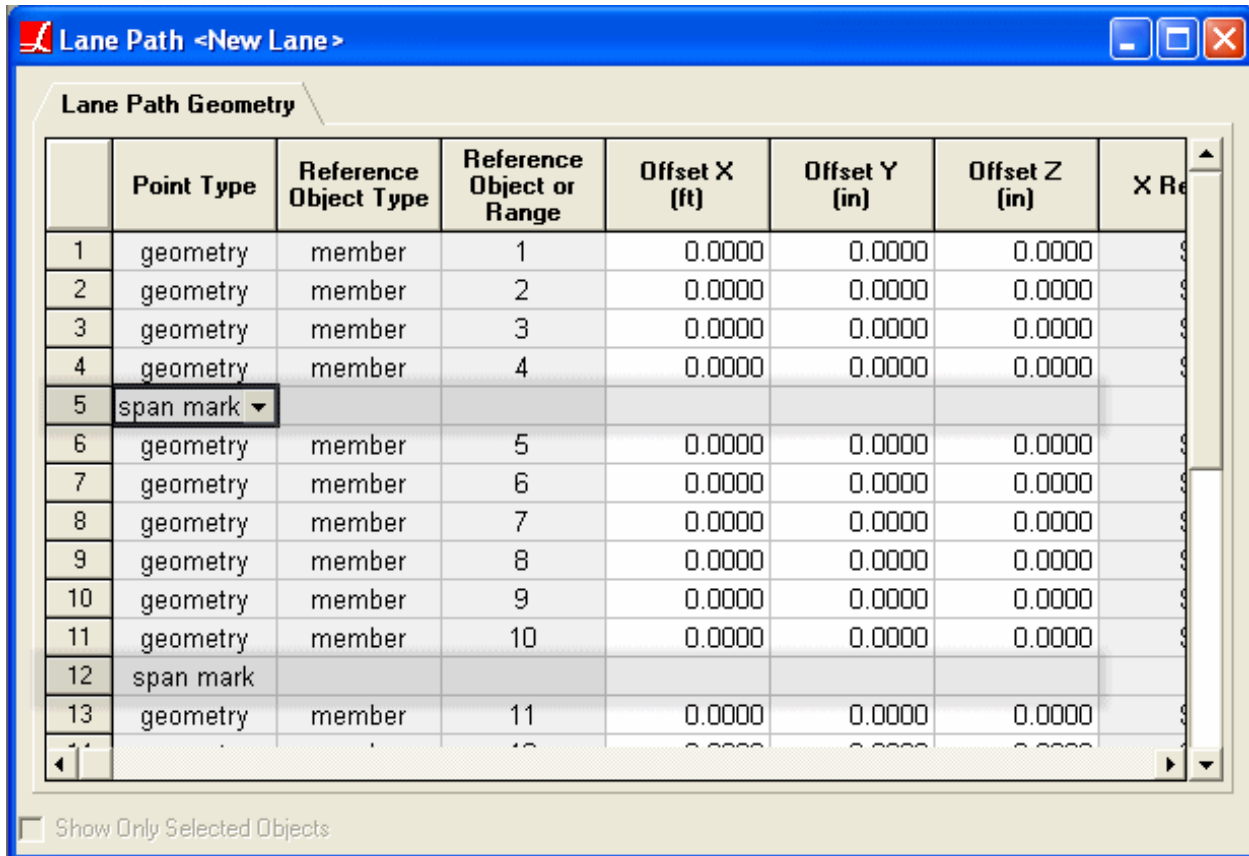

Span Break Markers in the Lane Path Definition

The standard solution method supports the notion of a lane type. A lane type is a loading scenario. In AASHTO LRFD, for instance, there are three loading scenarios which can be entered as three lane types: 1) one design truck, 2) two design trucks with a factor, and 3) a design tandem. To create additional lane types after the first, click the **Add Lane Type** button and then set the Vehicle Load Pattern and Factor options for each vehicle entered within the new lane type.

The LARSA 4D influence vehicle loading algorithm will choose the lane type for each design lane that causes the most extreme effect. Each design lane may be assigned a different lane type.

Each lane type has two additional options:

Max Lanes

Some design codes require a special "permit" vehicle which may be placed on up to a single lane. This can be entered as an additional lane type, with Max Lanes for the lane type set to 1. Normally, this option is left as No Limit. Any positive integer may be used.

UDL Factor

Some design codes require the lane types to have different factors for the lane load. This field allows an additional factor to be applied to the lane load for design lanes assigned to this lane type. The factor is applied in addition to other factors relevant to the lane load.

Lane Transverse Constraints Min/Max

In some cases, vehicular and UDL loading must be constrained to a particular transverse location on the surface. In the Min field, provide the minimum distance from the negative-side edge of the surface (typically the right side) to the near edge of any design lanes of this lane type, in the length unit indicated. In the Max

field, provide the maximum distance from the negative-side edge of the surface (typically the right side) to the far-side edge of any design lanes of this lane type. If either Min or Max is zero or left blank, the corresponding constraint will not apply.

Uniform/Patch Loading Options

This set of options is for uniform/patch/lane loading.

Lane Load Method

The "simple" method indicates to place a uniform load throughout the lane surface, except in locations that do not contribute to the extreme effect (i.e. patch loading). This is the only method currently supported for the standard solution method.

Load Magnitude

This value is the magnitude of the uniformly distributed force. The magnitude is entered in force per linear length, per design lane, i.e. kip/ft per design lane.

Exclude Under Vehicles

Exclude the uniform lane load from the positions where vehicles are placed.

Procedure: Getting Results

Overview

The influence analysis result case can provide results in the same manner as any other load case: through the spreadsheet, graphically, or using any of the tools on the **Results** menu. The results presented reflect the positive and negative worst-case possibility for the application of the load pattern on the selected lane.

Because influence-based results are calculated on-the-fly (that is, when the actual data is requested), each data request involved calculating the extreme values. Influence-based results will operate slower than standard results, but they do not require additional analysis engine time or hard drive space. See *Suggestions for Influence Analysis* (page 237).

Envelopes

Because influence-based results search for a minimum and maximum, LARSA 4D must know which column from a result spreadsheet to envelope on. If LARSA 4D is enveloping on the member's z-moment, the member's corresponding y-moment will not be the minimum/maximum y-moment but instead will be the y-moment produced from the same axle positions that produced the greatest z-moment. In this way, an entire row of a spreadsheet comes from the same axle positions. You must use envelopes to view influence-based results so that LARSA 4D knows which value to envelope on.

Not all graphical results use envelopes automatically. The other results, such as member forces and stresses, automatically envelope on the result column being displayed. If axial force is being shown graphically, then the influence results will envelope on axial force.

Special Graphical Results Tools

A special influence coefficients graphical view [see "Influence Coefficients Graphical View" in *LARSA 4D User's Manual*] is available, showing the influence coefficients as well as computed truck axle positions.

Special Spreadsheet Results Features

In results spreadsheets, the Result Case column of influence-based results indicates the specific loading configuration that yielded the extreme result of each row.

The cell value lists the coordinate of each placed vehicle in the form of “s4./t35.25,” for example. This example means the head of the vehicle is 4 coordinate units from the start of the lane/surface (“s” stands for “station”) and at a transverse location of 35.25 coordinate units where zero is at the centerline of the surface and sign follows the right hand rule (“t” stands for transverse). The head of the vehicle is the (0,0) coordinate in the load pattern definition, which is typically at the location of the front wheels on the centerline of the vehicle. When the vehicle may be placed in either direction, “/d0” indicates the vehicle is facing backward (i.e. the head of the vehicle is toward the start of the lane/surface) and “/d1” indicates the vehicle is facing forward (the head of the vehicle is toward the end of the lane/surface; “d” stands for direction).

If the configuration text is followed by “UDL”, it indicates that uniform lane loading was applied.

If the configuration text is followed by “* 1.2 (mp)”, a multiple presence factor (such as 1.2) was applied.

If the configuration text is followed by “* .9”, it indicates an overall factor was applied.

For More Information, please refer to the following documentation.

- Lanes on page 105.
- Influence Loads on page 135.
- Linear Static Moving Load Analysis and Dynamic Rolling Stock Analysis on page 217.

Suggestions for Influence Analysis

This section provides some suggestions for running influence analysis.

Suggestions for Speed

Because of the large number of computations involved in influence analysis, speed can be a concern.

Using Larger Increments

Try increasing the forward and transverse increments in the influence coefficients load case. With fewer coefficients generated, there are fewer results to scan through to optimize vehicle and UDL positions.

Cache Results (Tools → Options → General Options)

As influence based results are requested, the computed results are saved into a cache file. This way, the next time same influence result is requested, it can be retrieved from the cache quickly. Optimization occurs as user requests data.

Pre-cache Results (Results → Pre-cache Results)

You may want to use this tool before the leaving office so that it works during the night. The next day you can access all influence results just like static runs.

I/O Optimization (Results → I/O Optimization)

The first time LARSA tries to access a result file, the complete file will be loaded into system memory (assuming enough memory exist on the system). This way repeated disk access is avoided. The files are loaded into the memory as they are requested. This feature only loads original analysis engine generated result files, not the files generated by the above methods.

Vehicle-Track-Structure Interaction Analysis

The LARSA 4D Vehicle-Track-Structure Interaction Analysis is an advanced analysis for high-speed rail structures. The analysis includes a) the coupling of the moving mass of the vehicle with the structure through a track, and b) an explicit representation of the vehicle's suspension system and structure. The analysis is an extension of the Time History Analysis and currently is limited to straight bridges with no material or geometric nonlinearity.

Methodology and Rationale

Traditionally, railway bridges are designed based on a static analysis of loads multiplied by a dynamic magnification factor. However, dynamic analysis with time-varying loading is required for many bridges supporting trains travelling at speeds of 200km/h and upwards. At high speeds, such as the 400km/h proposed for the new California high-speed rail project, resonance and coupling of the vehicle with the natural frequencies of the structure exacerbate structural demands. In this case, a dynamic vehicle model must be built and must include the masses of wheelsets, bogies, and car bodies, as well as stiffness and damping of the suspension systems.

Mathematically, vehicle-track-structure-interaction can be represented as a system of three sets of equations of motion – for the vehicle, track, and bridge subsystems – coupled with one another. VTSI analysis calculates displacements, velocities and accelerations at locations on both the bridge and the vehicle, as well as contact forces between the wheels and the rails. These can then be checked to ensure compliance with design requirements. For example, vertical deck accelerations must be limited to guarantee traffic safety and avoid destabilization of the ballast; passenger comfort is checked based on car body accelerations, and the track safety is verified based on the time-varying contact forces.

The LARSA 4D VTSI analysis is based on combining the three systems of equations of motion for the vehicle, track, and main structure with constraint conditions. This approach has many advantages over the use of specialized VTSI software that analyzes the complete vehicle-structure system monolithically, but may limit the types of structures that can be analyzed, or iterative procedures that solve the vehicle and structure systems separately, which may require significant computational resources since the convergence of the solution can be slow.

In the LARSA 4D VTSI analysis, the main structure (e.g., the bridge) is modelled using standard structural or finite elements, such as beam and shell elements. Any of the linear elements available in LARSA 4D may be used; therefore, any bridge structure that can be analyzed in LARSA 4D's Linear Time History Analysis can be analyzed using the VTSI analysis as well. Currently the analysis is limited to straight bridges. The vehicle (e.g., the train) is modelled as a sequence of cars drawn from the LARSA 4D VTSI parametric vehicle library. Each car is represented as a multi-body system composed of rigid bodies, springs and dashpots.

The train and the track are coupled together by means of kinematic constraints. In order to provide higher continuity in the interpolation of these constraints, non-uniform rational B-splines or 'nurbs' are used to construct the time-dependent influence matrix which corresponds to the positions of wheels on the rail. The rail is modelled as a 3D beam using an isogeometric approach, which employs the same interpolation functions, or nurbs, for both geometry and displacements to achieve higher order continuity at the inter-element boundaries.

The system of constrained equations of motion to be solved requires careful consideration of the time-integration scheme. As available research suggests, some amount of numerical damping is necessary to avoid spurious high-frequency numerical oscillations in the contact forces. Therefore, the Generalized- α method is employed to discretize equations of motion in time. This scheme provides accuracy at low frequency and the desired numerical damping at high-frequency.

Model Setup Procedure

Preparing for a LARSA 4D Vehicle-Track-Structure Interaction Analysis involves four steps: Preparing the main structure model, entering the vehicle parameters, inserting a ghost of the vehicle into the project, and entering analysis parameters.

The Main Structure

In general, any 3D structure that can be analyzed in LARSA 4D's Linear Time History Analysis is permitted in VTSI analysis, as long as the track is straight and supported by member elements.

The structure that supports the track must be included in the model and modeled as beam elements. This structure may either be at the centerline of the track or it can be two lines of beams beneath the two rails. The model must not include the stiffness of the track rails themselves, which is automatically added by the VTSI analysis.

The model may include additional superstructure and substructure details at the user's discretion. There are no other requirements for the main structure model in the VTSI analysis.

Track

The track must be straight (i.e., not horizontally curved). (This necessitates that the model be a straight bridge, but an expansion of this analysis type to curved bridges is planned. VTSI models are therefore typically "2D.")

The stiffness of the two rails of the track and their geometry are defined in two steps.

For the stiffness of the rails, a material (page 19) and section (page 23) are added to the project. A material named "Rail" must be added to the project and set to the rail material's modulus of elasticity, shear modulus, and unit weight (from which the rails' mass is determined). A section named "Rail" must also be added to the project to hold each rail's cross-section area, shear areas, moments of inertia, and torsion constant. The weight of the rail will be automatically included in the analysis.

The geometry and connectivity of the two rails of the track are modeled using lane objects. Two methods are available:

Simplified Track Centerline Method: In the simplified method, a single lane (page 105) object is defined at the centerline of the rails. The lane must have a "geometry point" at the start or end of each beam element in the track-supporting structure and at no other locations (i.e., geometry points at mid-points on beam elements are not permitted). The name of the lane can be chosen by the user. The rails are assumed to be spaced 1.435m apart perpendicular to the direction of gravity (defined later).

Explicit Rail Method: In the explicit rail method, two lane (page 105) objects are defined in the project and must be named "Right Rail" and "Left Rail." Each must have a "geometry point" at the start or end of each beam element in supporting structure beneath each rail and at no other locations (i.e., geometry points at mid-points on beam elements are not permitted). The "Right Rail" lane defines the rail on the -y side of the bridge, and the "Left Rail" lane defines the rail on the +y side of the bridge. Typically the lane objects may be supported by different beam elements, although the supporting structure may be the same beam elements for both rails if offsets are applied to the geometry points in the lane objects.

Vehicle Parameters

A spreadsheet for vehicle parameters is located at **Input Data** → **Geometry** → **VTSI Trains**. Typically a single row is added to this spreadsheet to define a vehicle (e.g., a train) for the analysis. However, multiple rows can be added to this spreadsheet to analyze multiple vehicles in independent VTSI analyses.

A vehicle is defined by parameters according to LARSA 4D's vehicle library. Currently only one vehicle type is defined in the LARSA 4D vehicle library. This vehicle is composed of a user-provided number of cars of an identical form shown in the image below:

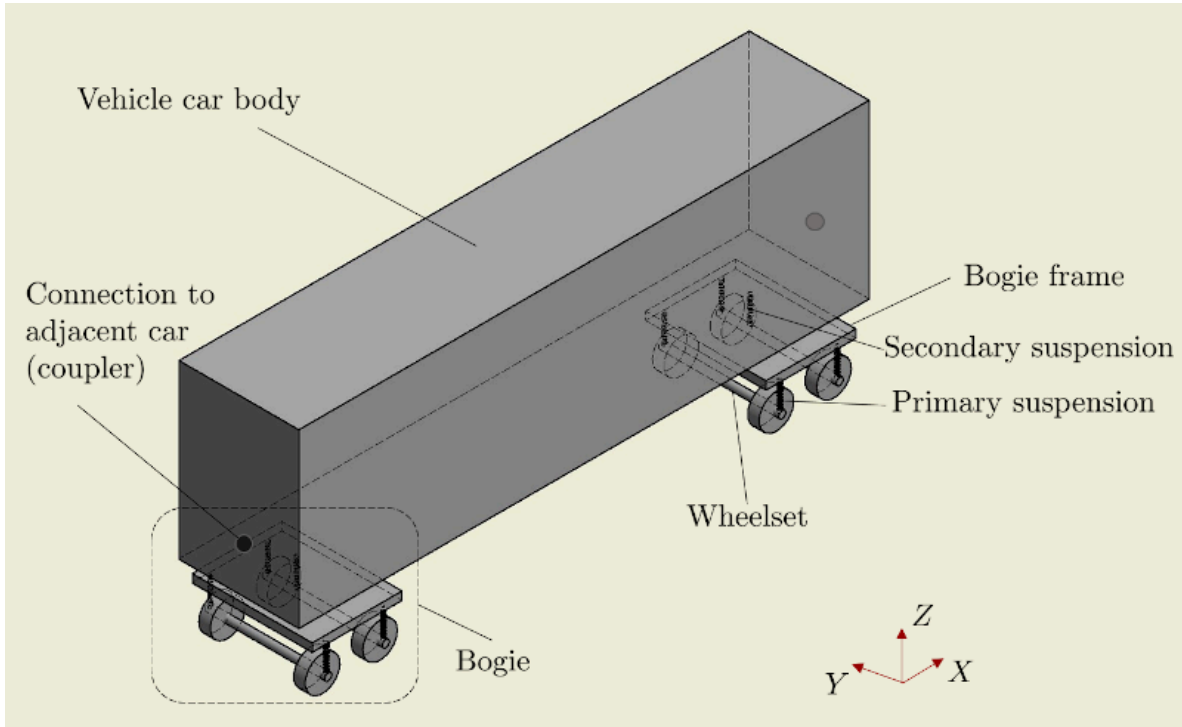

VTSI Parametric Car

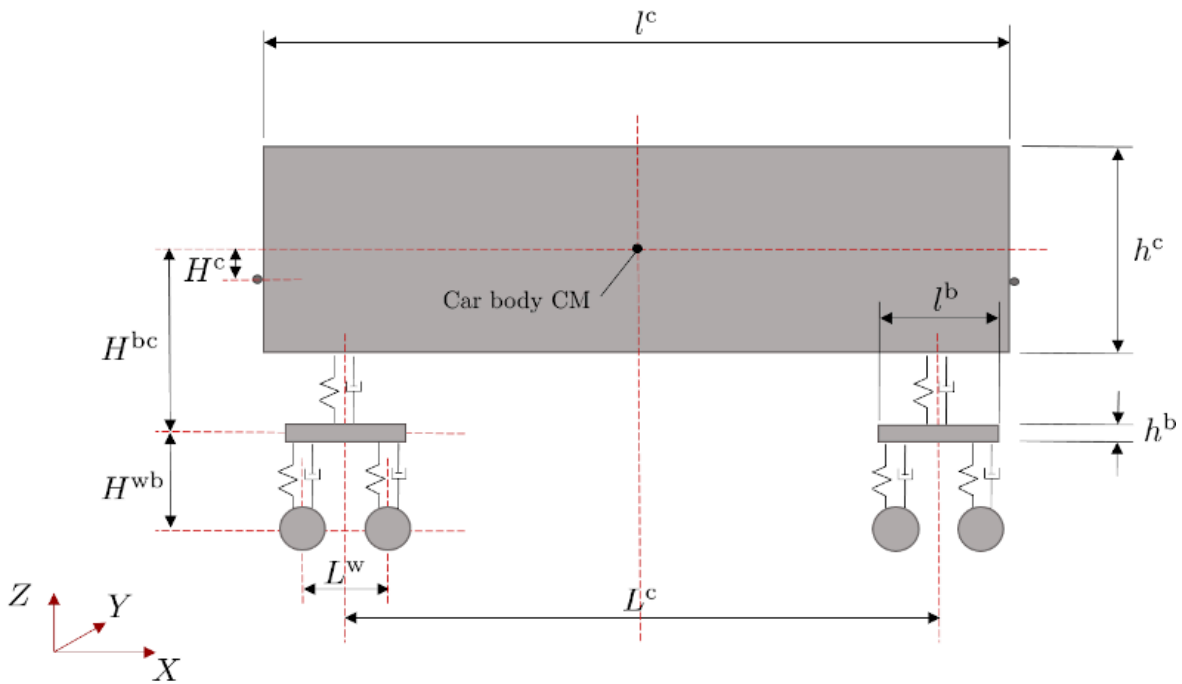

Geometric properties of a VTSI Parametric Car

The following vehicle parameters have to be specified:

- Number of cars
- Car body length l^c - dimension of the car along the X-axis
- Number of bogies per car
- Bogie offset from car centroid H^{bc} - vertical distance between bogie centroid and car centroid
- Wheel offset from bogie H^{wb} - vertical distance between wheel center and bogie centroid
- Bogie spacing L^c - longitudinal (along the X-axis) spacing between bogies centroids
- Car weight
- Car mass moment of inertia about the Y-axis
- Number of wheels per bogie
- Wheel spacing L^w - longitudinal (along the X-axis) spacing between wheels centers
- Bogie weight
- Bogie mass moment of inertia about the X-axis
- Bogie mass moment of inertia about the Y-axis
- Secondary suspension stiffness - stiffness of the suspension between the bogie and car
- Secondary suspension damping - damping of the suspension between the bogie and car
- Wheelset width - width of the wheelset in the Y direction; should be the same as the rail gauge
- Wheel diameter
- Wheelset weight - the total of the weight of the two wheels that make up the wheelset

- Wheelset mass moment of inertia about the X axis
- Primary suspension stiffness - stiffness of the suspension between the wheel and bogie
- Primary suspension damping - damping of the suspension between the wheel and bogie
- Car coupler length - distance between adjacent cars along the X-axis

The following vehicle parameters can be specified for visualization purposes:

- Car body width - dimension of the car along the Y-axis
- Car body height h^c - dimension of the car along the Z-axis
- Coupler offset from car centroid H^c - positive value correspond to the coupler below the car centroid
- Bogie length l^b - dimension of the bogie along the X-axis
- Bogie width - dimension of the bogie along the Y-axis
- Bogie height h^b - dimension of the bogie along the Z-axis

It should be noted that the masses of the car, bogie, and wheelset are calculated from the entered weights. The mass moment of inertia values are entered using units of force-length² and are obtained by multiplying the mass moment of inertia values in units of mass-length² by the acceleration due to gravity g .

The analytical elements of the vehicle are not explicitly modeled. Instead, the VTSI analysis computes the vehicle structural model from the parameters given. However, a “ghost” vehicle is added to the project file, as described next.

Ghost Vehicle

The stiffness and connectivity of the vehicle is not explicitly represented in the LARSA 4D project file since they are automatically computed during the VTSI analysis based on the vehicle parameters given in the VTSI Trains spreadsheet. However, a “ghost” vehicle is added to the project for the purposes of results reporting and visualization. The ghost vehicle will not move forward during the analysis — its joints are essentially fixed in the Tx direction — but its joints and springs will report vertical displacements and contact forces.

This ghost vehicle can be placed anywhere in space and is typically positioned a short way before the beginning of the track. It is not connected to the bridge structure, and so its position is arbitrary. To position the ghost vehicle, a User Coordinate System (page 39) is used. A rectangular User Coordinate System must be created whose origin is at the head of the ghost vehicle. For example, if the bridge begins at the coordinate (0, 0, 0), the User Coordinate System might be created with an origin at (-20, 0, 0). The ghost vehicle will extend from this point in the -x direction.

Assign the User Coordinate System to the vehicle on the VTSI Trains spreadsheet by choosing it in the Virtual Location column. Then right-click the spreadsheet row and choose Create Train Model. If the vehicle parameters or the User Coordinate System is modified, click Create Train Model again to update the ghost vehicle.

The ghost vehicle includes structural joints and elements, springs for reporting contact forces, and non-structural joints and elements. The structural joints and elements represent the mechanical definition of the vehicle: car, bogie, and wheel centroids, springs, and dashpots. Grounded springs generated at the wheel centroids are used for reporting contact forces between the wheels and the rail but do not represent any stiffness in the analysis. Results are computed at the structural joints and are reported at the structural joints and contact springs. Non-structural joints and surface elements are also generated in the ghost vehicle for visualization purposes only and indicate the physical bounds of the car and bogie.

Load Case Setup and Analysis Options

Create a new load case and set its Type to Time History. However, use the Moving Loads (page 133) tab of the load cases spreadsheet to add a moving load entry.

When using the Simplified Track Centerline Method described above, select the track centerline lane in the Lane Loaded column; however, when using the Explicit Rail Method the Lane Loaded should be left as “(None)” as the lane names will be used to identify the rail information. The Load Pattern must be set to the VTSI Trains spreadsheet entry created previously. The Applied Load Direction, Load Factor, Direction of Travel, and Start Position must be Global -Z, 1.0, Forward, and 0.0. The Vehicle Speed may be set by the user.

Start the analysis from **Analysis** → **Moving Load Analysis** → **Vehicle-Track Structure Interaction**. This analysis is an extension of the Time History Analysis (page 207) so typical Time History Analysis options must be set: the time step size, the ending time interval, and Rayleigh mass proportional and stiffness proportional damping constants. Additionally, the Generalized- α numerical damping constant should be set: This constant applies no damping when set to 1.0 and maximal damping when set to 0.0.

It is also possible to perform VTSI analysis as an analysis scenario (page 161) within Staged Construction Analysis. As an analysis scenario, it is possible to add additional static loading prior to the VTSI analysis, such as self-weight for the main structure (excluding the rail, which is automatically added). This method may be necessary if other static loading (such as self-weight) creates significant deformation of the rails, as the deformed geometry of the rails may have a significant impact on the analysis. When running the analysis as an “analysis scenario,” start a standard Staged Construction Analysis (page 247) instead.)

Accessing Dynamic Results

After the analysis completes, results (page 273) will be available at each time step from the Analysis Results Explorer. Typical time history results such as joint displacements, reactions, velocities, accelerations, member forces, and so on will be available throughout the main structure in the usual way. Additionally, results for the vehicle and special contact force results are also reported at the ghost vehicle’s joints and elements:

Vehicle displacements, velocities, and accelerations are computed and reported at the ghost vehicle’s structural joints for the wheel, bogie, and car centroids. Only vertical results are reported: The vehicle’s forward motion is not included in the results. (Note that the wheels are constrained to touch the rails so the displacements at wheel centroids always indicate the relative location of the rail to the wheel’s vertical position at time zero.) These results are reported in the Joint Displacements (page 277), Velocities, and Accelerations (page 281) spreadsheets and when viewing the Deformed Model graphically.

Contact forces between the vehicle and the rail are reported in the Spring Forces (Local) (page 319) spreadsheet for the grounded springs generated at the wheel centroids.

The ghost vehicle also includes non-structural joints for visualization purposes that indicate the physical bounds of the car and bogie. Displacements at these joints are approximate.

The results at each time step include deformation due to the static weight of the rail and, when run as an analysis scenario in Staged Construction Analysis, any deformation due to prior static loading.

For More Information, please refer to the following documentation.

- Lanes on page 105.
- Moving Loads on page 133.

- Linear Static Moving Load Analysis and Dynamic Rolling Stock Analysis on page 217.
- Linear Time History Analysis on page 207.
- Linear Time History Analysis Options on page 209.

Staged Construction Analysis

Staged Construction Analysis analyzes a series of construction steps, which represent the steps in the evolution of a structure's construction, demolition, or rehabilitation. The Staged Construction Analysis is a form of nonlinear static analysis (page 173) that retains the state of the structure from step to step, automatically applying construction activities specified by the user. Staged Construction Analysis makes scenario testing an automated process.

Overview of Staged Construction Analysis	249
Staged Construction Activities	251
Setting Up the Model	253
Preparation	253
Creating Activities in the Explorer	254
Creating Activities in the Stage Editor	256
Time Effects on Materials	261
Material Time Effects	261
Design Codes	263
Load Class Tracking	265
Setting up the model	265
The Load Classes of Result Cases	265
Accessing Class-Based Results	266
Staged Construction Analysis Options	267
Options for Analysis Scenarios	268

Overview of Staged Construction Analysis

Changes to a structure over time are defined in a series of construction steps. Construction steps can include construction activities, such as constructing parts of the structure, applying loads, and modifying support conditions. Time-effects on material behavior, including the effect of super-imposed loads, can be automatically accounted for.

Because the Staged Construction Analysis is a nonlinear analysis, geometric nonlinearity is included, a necessary feature for any structure with nonlinear elements, such as cables.

Staged Construction Analysis comes in two types. In the Standard type, a Nonlinear Static Analysis (page 173) is performed for each construction step, retaining the deformed properties of the structure from step to step. Time-effects on materials are ignored. In the Time-Dependent type, the same nonlinear analysis is performed, but time-effects on materials are included.

Elements are activated and deactivated through their inclusion in construction activities. When a Staged Construction Analysis begins, LARSA assumes no elements have been activated. Only elements explicitly constructed in construction activities contribute to the stiffness of the structure. If the structure is to start off constructed, the first construction activity should assemble the structure into its constructed state.

A structure can change over time any number of ways in the real world. LARSA supports the following construction activities:

- **Construction:** Parts to the structure are added (assembled). Joint locations can be automatically adjusted based on the deformed shape of the structure according to construction methods, a necessary tool for segmental projects such as balanced cantilever bridges.
- **Deconstruction:** Parts of the structure are removed (disassembled).
- **Weight and Stiffness:** Self-weight and stiffness can be activated in different steps.
- **Supports and Constraints:** Joints are restrained or released, and constraints can be added/removed.
- **Loads:** Loads are applied or removed.
- **Tendons:** Stressed or slackened.
- **Materials:** Creep and shrinkage for concrete, and relaxation for steel.

Staged construction often comes hand-in-hand with pre- and post-tensioning elements. Such tensioning is generally accomplished with tendons, which are discussed in the tendons section in the Model Data Reference (page 95).

Staged Construction Activities

LARSA is able to model continuous changes to a structure over time involving a useful set of construction activities.

Construction activities are specified in two ways, using the Construction Stages Explorer or the Construction Stages Editor. See *Setting Up the Model* (page 253).

LARSA arranges construction activities into **stages** and **steps**.

Stages

A stage represents one day of construction, which can consist of one or more steps. Stages are labeled with a day number, a temperature and a humidity value, which apply to all steps within the stage. The day of the stage is used for computing time-effects on materials.

Steps

A step represents one set of construction activities to accomplish a goal. Steps occur within stages. All construction activities occur within steps.

Both stages and steps can be given descriptive names.

The construction activities that can be placed within steps are given below. They are described in more detail in *Construction Activities* (page 139).

Construction/Deconstruction

Structural elements are at any point constructed or unconstructed. Constructed elements are used in the analysis of the structure, while unconstructed elements are ignored. Elements start off unconstructed until they are explicitly constructed in a step.

To construct or deconstruct (page 141) a part of the model, form a structure group [see “Structure Groups Explorer” in *LARSA 4D User’s Manual*] and then drag that group from the Structure Groups Explorer into the Construction Stages Explorer [in *LARSA 4D User’s Manual*]. The elements in that group will be constructed. To deconstruct those elements, right-click the stage, choose Properties, and mark the Deconstruct option.

Elements may be constructed in locations relative to the deformed state of the structure. The segmental construction methods (page 141) and joint displacement initialization (below) are used to specify such behavior. Normally, elements are constructed in the position that they are initially defined in.

See *Construct and Deconstruct Activities* (page 141).

Support Change and Hoist Activity

A support's properties have changed, or a joint is becoming a support. Support activities (page 147) specify the new restraints of a joint (page 59) in all six degrees of freedom.

See *Support and Hoist Activities* (page 147).

DOF Constraint Activity

A joint (page 59)'s DOF Constraint (page 93) is changed. DOF Constraint activities specify the new DOF Constraints of a joint. Old DOF Constraint connections in all degrees of freedom are discarded for the joint whenever a new activity for that joint is encountered.

See DOF Constraint Change Activities (page 149).

Load Application

A static load case (page 113) is applied to the structure. Loads are applied **cumulatively**; that is, a load applied in one stage will automatically continue to be applied in all future stages. To "turn off" a load, apply the load again with a negative load factor.

Tendon Application

A tendon (page 95) is stressed or slackened.

See Tendon Stressing and Slackening Activities (page 151).

Displacement Initialization

Alters the initial location of a joint. Normally, when joints are activated they enter at the location that was initially given to them. Joints sometimes need to become active in a location relative to the deformed structure of the model, rather than in an exact position known ahead of time. Displacement Initializations specify how to place a joint relative to the deformed location of other joints..

See Displacement Initializations (page 153).

Setting Up the Model

Construction activities are specified in two ways, using the Construction Stages Explorer or the Construction Stages Editor. This section explains how to use each method.

Structural changes occur in a serial or linear fashion. An example of staged construction might be . . .

1. Construct Left Pier
2. Construct Right Pier
3. Construct Center Temporary Pier (modeled as fixing center joint in space)
4. Construct Span from Left to Temporary Pier
5. Construct Span from Right to Temporary Pier
6. Stress Tendons
7. Deconstruct Temporary Pier (modeled as releasing center joint)

Each of those steps is referred to as a *construction activity*.

Preparation

Before defining construction activities in LARSA,

1. All elements in the structure that will ever be assembled must be modeled.

Structures should be modeled as if every member, plate, and spring used at any point during construction are all present at the same time. The time at which elements are constructed will be specified later.

As a result, all joints that will ever be a part of the model must be in the project. Joints are automatically included in the model when elements attached to it become constructed and are automatically removed from the model when all attached elements are deconstructed.

Tendons (page 95) and other structural objects must also be entered before proceeding on to modeling construction activities.

2. Restraints must be set to initial conditions

Joints will be initially restrained as their restraints are specified in the project, taking into account standard restraints (page 59) and DOF constraints (page 93).

3. Groups of elements that will be constructed or deconstructed together should be put into structure groups [see “Structure Groups Explorer” in *LARSA 4D User’s Manual*].

Although structure groups need not be defined ahead of time, it will save time later.

The steps outlined from this point on assume that the above tasks have been completed.

Creating Activities in the Explorer

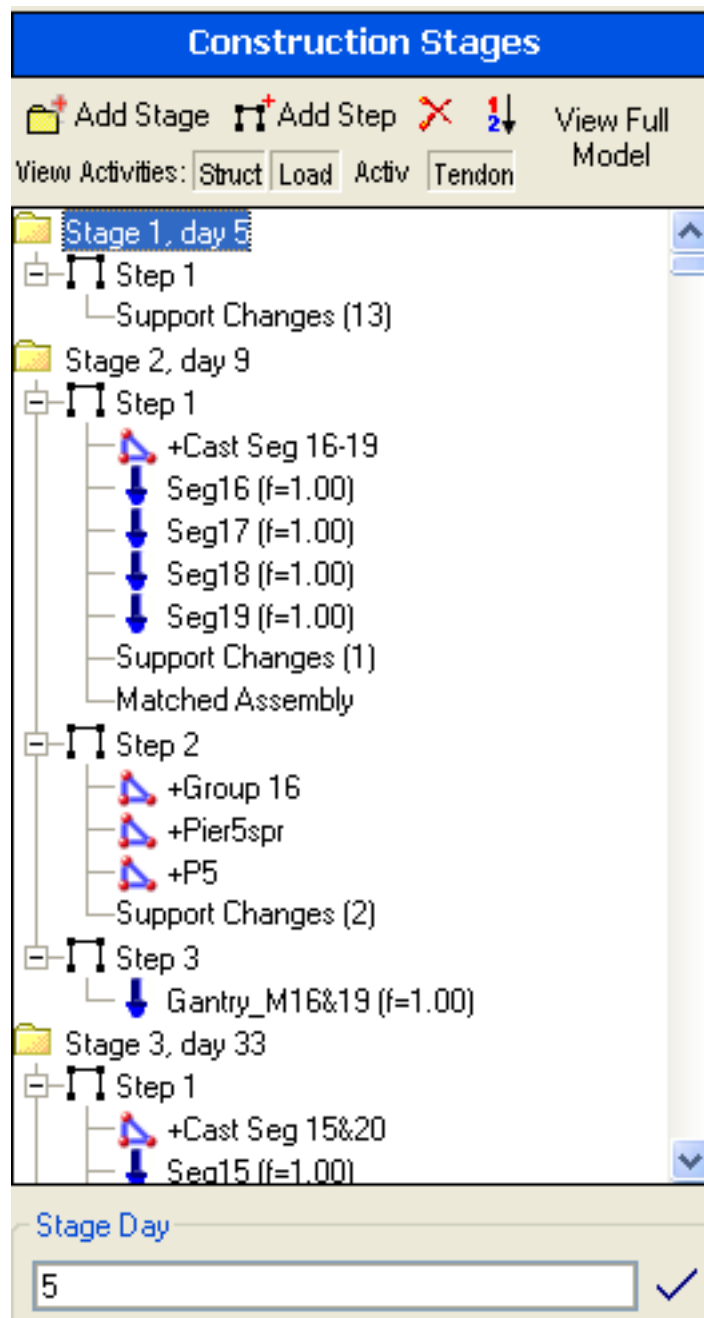

Construction Stages Explorer

The Construction Stages Explorer presents the construction stages and steps in the same style as the example above. A screenshot is on the right.

For more information on the meaning of each type of construction activity, see Staged Construction Activities (page 251).

Using the Explorer:

- To open the Explorer if it is not already open, right click the title bar area of the open Explorer (where it reads "Construction Stages" in the figure) and choose *Construction Stages*.
- To **add a construction stage**, click the Add Stage button, which looks like a folder. A new stage will be added to the bottom of the list of stages. Each stage is labeled with the day on which its steps' activity occurs, which is "day 0" by default.
- To **add a construction step** to the project, select the stage in which to add the new step, and then click the Add Step button, which looks like a small frame.
- To **delete** a stage or step, select the stage or step and then click the Delete button, which looks like an X.
- To **rename** a stage or a step, select the stage or step, and then hit **F2**. Type the new name, and then hit **Enter**.
- If after adding various stages they have become out of **chronological order**, click the Sort button. The stages will be sorted by Day.

Preparing for Time Effects in the Explorer:

- To include **time-effects on materials** in construction analysis, each construction stage must have a time assigned, determined by a stage's Day. To edit a stage's day, select the stage. Then, make the change in the text box at the bottom of the explorer. Hit the checkmark to finalize the change.
- To modify the **humidity or temperature** of a stage, which is used to compute time-effects on materials in construction analysis, open the Load Groups & Stages spreadsheet window, which can be found in the **Input Data** menu. Select the Construction Stages tab. This spreadsheet will show a list of the stages added to the project, but not the construction steps.

Adding Construction Activities in the Explorer:

- If part of the structure is to be **constructed or deconstructed** in a step, click and drag a Structure Group [see "Structure Groups Explorer" in *LARSA 4D User's Manual*] of those elements from the Structure Groups Explorer onto the step in the Construction Stages Explorer during which they will be constructed.

To see the two Explorers at once, double-click the title bar area of the open Explorer (where it reads "Construction Stages" in the figure). The right click the title area of the Explorer on the bottom and choose *Structure Groups*. Double click the title area of the top Explorer again to close the lower Explorer.

Structure groups in a step must be either all constructed or all deconstructed. Use multiple steps if both construction and deconstruction will occur.

If that structure group is to be **deconstructed**, right-click the construction step (not the group). Click **Properties** and choose the *Deconstruct* option. The step will become a deconstruction step, indicated by a red X through the step's icon.

Structure groups can be constructed in **weight-only mode** in which the self-weight of the group is applied to the structure but the group adds no stiffness to the structure. This is useful when a concrete member is poured but not immediately hardened. To specify that a structure group be weight-only, right click the group and select *Weight Only*. To have the group contribute stiffness in a later stage, add the group to the Construction Stages Explorer again, but without the weight-only option.

- Static **load cases** are applied during a step by dragging a load case from the Load Cases Explorer [see "Load Cases Explorer" in *LARSA 4D User's Manual*] onto the step in the Construction Stages Explorer during which the load case should be applied. To see the two Explorers at once, see the previous point.
- **Other activities** are accessed
- Using the Construction Stage Editor, which is explained below, or

- Through spreadsheets [see “Using the Model Spreadsheets” in *LARSA 4D User’s Manual*]. To add these activities to a step, right-click the step and then select Support, DOF Constraint, Tendon Activity.

Creating Activities in the Stage Editor

The construction stage editor is an alternative way of building/editing the stage construction data in LARSA 4D. Unlike the Construction Stages Explorer, the Construction Stage Editor uses a spreadsheet based approach to organize the data.

The spreadsheet does not only contains the data but also some commands with a self explanatory label to their functionality. These commands can be easily distinguished by their red, italic, underlined format. Double clicking on these commands will activate them.

Each spreadsheet contains the commands to add, remove, and rename stages and steps.

The dialog box is composed of six tab menus. Each menu represents a type of spreadsheet. Below you find the explanation on each tab menu and how it is being used.

For more information on the meaning of each type of construction activity, see Staged Construction Activities (page 251).

On the **Stage/Steps** spreadsheet, you can:

- Add, remove, and rename stages and steps,
- Specify whether each step is for construction or deconstruction, and
- Define the segmental construction method (page 141) of each step. Unless your model needs to update joint locations to account for deformation, the Standard method should be chosen.

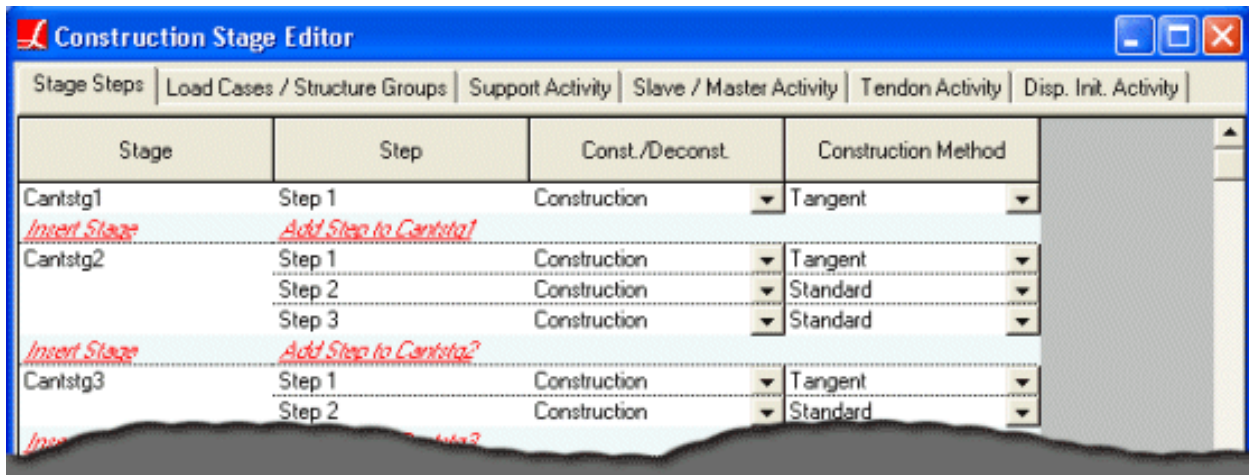

Construction Stage Editor: Stage Steps

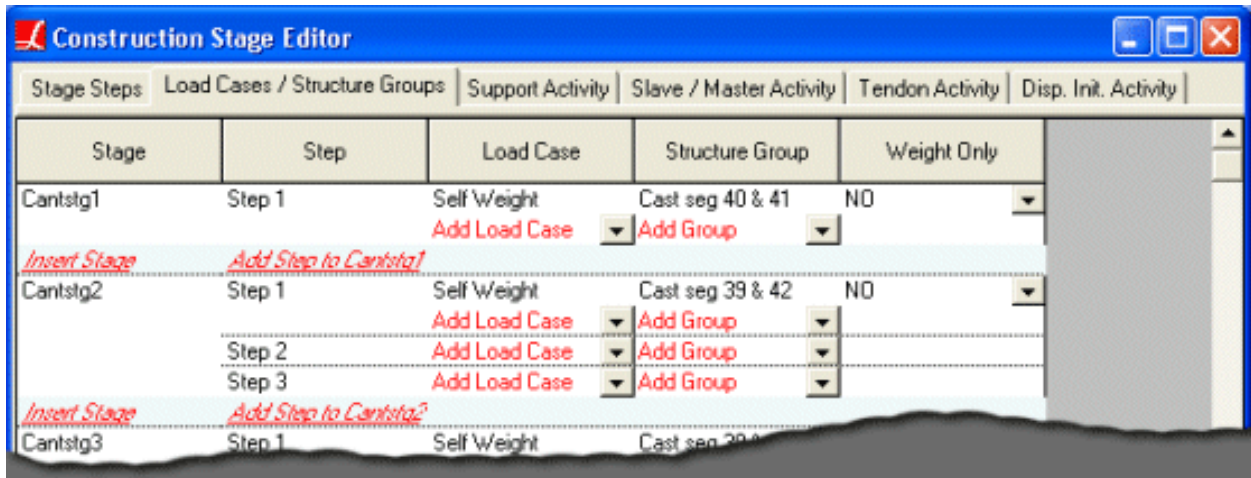

Construction Stage Editor: Load Cases / Structure Groups

On the **Load Cases/Structure Groups** spreadsheet, you can :

- Add and remove load cases to steps,
- Add and remove geometry groups to steps, and
- Specify whether geometry groups are weight-only. (For an explanation of weight-only groups, see the previous section.)

On the **Support Activity** spreadsheet, you can add or remove support activity for each step by specifying the joint number and six degrees of freedom.

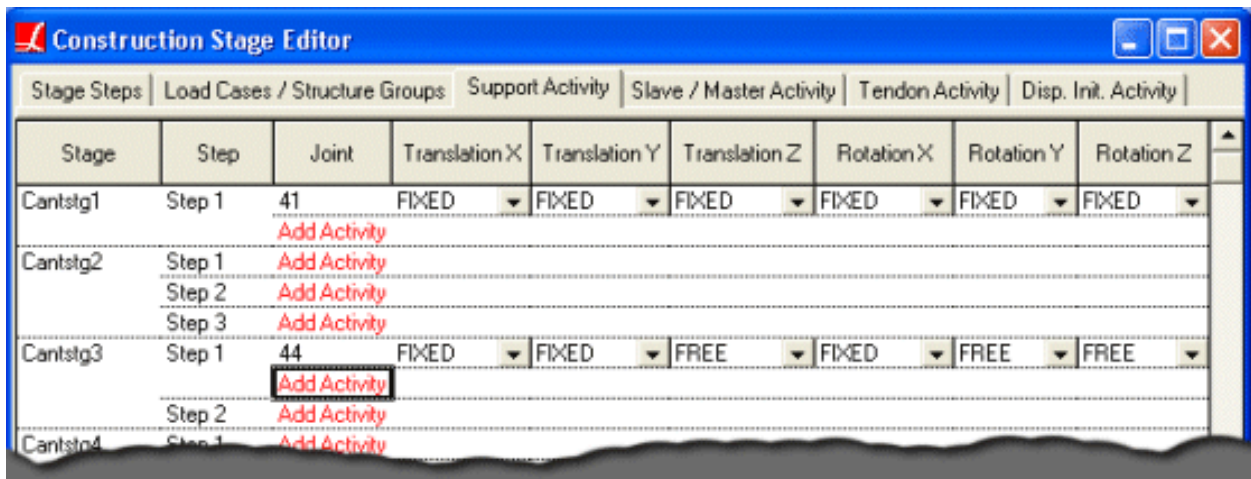

Construction Stage Editor: Support Activity

Stage	Step	Slave Joint	Master Joint X-Tran	Master Joint Y-Tran	Master Joint Z-Tran	Master Joint X-Rot	Master Joint Y-Rot	Master Joint Z-Rot
Cantstg1	Step 1	1	51	51	51	NONE	NONE	NONE
		Add Slave/Master						
Cantstg2	Step 1	2	52	52	52	NONE	NONE	NONE
		Add Slave/Master						
	Step 2	Add Slave/Master						
	Step 3	4	54	54	55	55	NONE	NONE
		5	55	56	56	56	NONE	NONE
		Add Slave/Master						
Cantstg3	Step 1							

Construction Stage Editor: DOF Constraint Activity

On the **DOF Constraint Activity** spreadsheet, you can add and remove DOF constraint activity for each step by specifying the joint number and the master joint at six degrees of freedom.

On the **Tendon Activity** spreadsheet, you can

- Add and remove tendon activity for each step, and
- Specify whether each tendon is stressed or slackened.

Stage	Step	Tendon	Activity
Cantstg1	Step 1	Add Tendon	
Cantstg2	Step 1	Add Tendon	
	Step 2	TP2N	Stress
		TP2S	Stress
		Add Tendon	
	Step 3	2C1	Stress
		2C8	Stress
		Add Tendon	
Cantstg3	Step 1	Add Tendon	

Construction Stage Editor: Tendon Activity

The screenshot shows the 'Construction Stage Editor' window with the 'Disp. Init. Activity' tab selected. The spreadsheet contains the following data:

Stage	Step	Joint	Master Joint 1	Master Joint 2	Direction
Cantstg1	Step 1	Add Disp.Init. Activity			
Cantstg2	Step 1	15	1	30	all
		50	35	55	x, y
	Step 2	Add Disp.Init. Activity			
	Step 3	40	35	56	x, z
Cantstg3	Step 1	Add Disp.Init. Activity			
	Step 2	Add Disp.Init. Activity			

Construction Stage Editor: Displacement Initialization Activity

On the **Displacement Initialization Activity** spreadsheet, you can add and remove displacement initialization activities for each step by specifying the joint number that the initialization process will take place, the joints at both ends, and the adjustment direction.

Time Effects on Materials

Time effects on materials account for concrete creep and shrinkage and the time-effect on elastic modulus, steel relaxation, and other material changes.

Conventional analysis does not account for materials whose properties change over time. Concrete is subject to creep and shrinkage. Steel is subject to relaxation. These changes and elastic modulus variation are accounted for in LARSA 4D's Time-Dependent Stage Construction Analysis.

Time-dependent deformation of concrete resulting from creep and shrinkage is of crucial importance in the design of prestressed concrete structures because these changes result in a partial loss of prestress force with significant changes in deflections.

Time-Dependent Stage Construction Analysis also requires time, temperature, and humidity conditions at each stage.

To set other options, including the design code, open the **Analysis** and choose **Time-Dependent Analysis Options**.

Time-Dependent Analysis Options

Creep & Shrinkage & Time Effect on Modulus

Include Creep Include Shrinkage Include Time Effect on Modulus

Code For Creep & Shrinkage: CEB-FIP 90 Include creep of tensile axial force for beams

Tendon Stress Losses

Include Steel Relaxation Losses due to Creep/ Shrinkage/ SI Loads

OK
Cancel

Setting Time-Dependent Analysis Options

Material Time Effects

The following time-dependent material effects can be computed by LARSA 4D. Each effect can be turned on or off in the Time-Dependent Analysis Options.

Concrete Creep

Creep is the property of many materials by which they continue deforming over considerable lengths of time at constant stress or load. Creep strain for concrete depends not only time, but on the mix proportions, humidity, curing conditions and the age of concrete when it is first loaded. The rate of strain increase is rapid at first, but decreases with time until a constant value is approached asymptotically. In LARSA 4D, creep is available for member and plate elements and includes creep due to axial force and the two bending moments.

Creep is applied to all member and plate elements with materials that have a *concrete cement hardening type* set to anything except *Not Concrete*. (See Materials (page 19).)

The volume-to-surface-area ratio is computed for member elements with the assumption that the entire perimeter of all shapes in the element cross-section are exposed to air but the end faces of the element are not exposed to air (e.g. a column-like layout of beam elements). It is computed for plate elements with the assumption that the top and bottom surfaces of the plate element are exposed to air but the side faces along the thickness of the plate are not exposed to air (e.g. a slab-like plate mesh).

Creep due to incremental tensile strain is ignored unless **Include creep from tension forces** is turned on. This option should be considered when elements participate in composite action or when creep recovery is desired. (In members, tensile strain refers to tensile axial force. In plates, it refers to tensile strain in both in-plane directions.)

Creep is not applied if **Include Creep** is turned off.

Concrete Shrinkage

Normal concrete mixes contain more water than is required for hydration of the cement where the free water evaporates in time. Drying of concrete is accompanied by a reduction in volume. The rate of drying depends on the humidity, ambient temperature, and the size and shape of the concrete element and the change in volume occurs at a higher rate initially.

Shrinkage is applied to all member and plate elements with materials that have a *concrete cement hardening type* set to anything except *Not Concrete*. (See Materials (page 19).)

See the explanation for creep for how the volume-to-surface-area ratio is computed for member and plate elements.

It is assumed that the elements undergoing shrinkage represent pre-cast segments. Consequently, shrinkage that occurs before the day of construction is not applied to the model.

Shrinkage is not applied if **Include Shrinkage** is turned off.

Time Effect on Modulus of Elasticity

The strength of concrete varies significantly from initial days to day 28, although from day 28 on the variation is very slow. This variation of strength is caused by changes to the elastic modulus. LARSA 4D can vary the elastic modulus of concrete materials according to a built-in curve or a user-defined curve.

If a user-defined curve is not entered, LARSA 4D uses the formula:

$$(t/(4.0+0.857t))^{0.5}$$

where t is the age of the element in days since its casting day. This curve has a value of 1.0 on and after day 28.

This effect is not applied if **Include Time Effect on Modulus** is turned off.

Steel Relaxation

When prestressing steel is stressed to the levels that are customary during initial tensioning and at service loads, it exhibits a property known as relaxation. Relaxation is defined as the loss of stress in a stressed material held at a constant length. This same phenomenon is known as creep when defined in terms of change in length of a material under constant stress. In prestressed concrete members, creep and shrinkage of the

concrete as well as fluctuations in superimposed loads cause change in tendon length. Relaxation is not a short-lived phenomenon, it continues almost indefinitely, although at a diminishing rate.

Relaxation must accurately be accounted for in the design because it produces significant loss of prestress force. The amount of relaxation varies depending on the type and grade of steel, but most significant parameters are time and intensity of the initial stress.

Prestressing tendons are held stressed at essentially constant length during the lifetime of a member, although there is some reduction in length due to concrete creep and shrinkage and superimposed loads. There will be a gradual reduction of stress in the steel under these conditions resulting from relaxation, even though the length is held nearly constant.

The amount of relaxation depends on the intensity of steel stress as well as time and, for stress-relieved steel, the ratio of stress to initial stress.

Relaxation curves (explained above) must be entered into the project and assigned to any material that will undergo relaxation, and those materials must be assigned to the tendons.

Relaxation is not applied if Include Steel Relaxation is turned off.

The Effect of Creep, Shrinkage, and Superimposed Loads on Post-Tensioning

Concrete creep and shrinkage and other loads applied after a tendon is stressed (superimposed loads) generate strain, which alters the forces (loss or gain) in the post-tensioning.

This effect is not applied if Losses due to Creep/Shrinkage/SI Loads is turned off.

Design Codes

The following design codes are available for time-dependent material effects:

CEB-FIP 78

This code uses a user-defined material model based on the CEB-FIP 78 guidelines. Use this option to supply custom curves for special environmental conditions. This code requires the following time-dependent material curves (page 53) to be entered by the user:

- Concrete Shrinkage Curve
- Concrete Delayed Plastic Strain Curve
- Concrete Delayed Elastic Strain Curve
- Stress/GUTS vs. Relaxation Curve
- Time vs. Relaxation Curve
- Time versus Elastic Modulus Curve.

Temperature-adjusted time is not implemented for this code.

CEB-FIP 90

This code requires the following time-dependent material curves (page 53) to be entered by the user:

- Stress/GUTS vs. Relaxation Curve
- Time vs. Relaxation Curve

This code has built-in equations for the computation of creep and shrinkage coefficients and therefore does not require the following curves to be entered by the user.

- Concrete Shrinkage Curve
- Concrete Delayed Plastic Strain Curve
- Concrete Delayed Elastic Strain Curve
- Time versus Elastic Modulus Curve

Drying is assumed to begin 3 days after the element's casting day (i.e., $t_s = 3$).

Temperature-adjusted time is not implemented for this code.

CEB-FIP 2010

Drying is assumed to begin 3 days after the element's casting day (i.e., $t_s = 3$).

Temperature-adjusted time is not implemented for this code.

EN1992-1-1:2004(E) (Eurocode)

Drying is assumed to begin 14 days after the element's casting day (i.e., $t_s = 14$).

Temperature-adjusted time is not implemented for this code.

AS 3600-2009

Drying is assumed to begin on the element's casting day (i.e., $t_s = 0$).

AASHTO LRFD v6

Drying is assumed to begin on the element's casting day (i.e., $t_s = 0$).

Load Class Tracking

Code compliance requires creating factored load combinations, with different factors applied to different classes of loading, such as dead load, live load, creep, and shrinkage. The Staged Construction Analysis of LARSA 4D reports cumulative effects after each construction step, but it is also possible to extract the partial effects of each load class. Starting with 7.01.60, the partial class-based effects of support, DOF constraint, and element deconstruction activities are now available, and these are crucial for creating code-based load combinations in a Staged Construction Analysis.

We discuss below setting up a model for tracking class-based loading in Staged Construction Analysis and how this method applies to support changes and element deconstruction.

Setting up the model

In a Staged Construction Analysis model that will use class-based load tracking, it is necessary to ensure that each load case is assigned a load class. Load classes can be chosen from a pre-set list of 45 classes including "Dead Load", "Live Load", "Creep", "Snow Load", and "Prestress". The choice of class does not impact the analysis and is used only for reporting partial effects during post-processing. To choose a load class for a load case, use the Load Cases & Combinations Spreadsheet or the Load Cases Explorer [see "Load Cases Explorer" in *LARSA 4D User's Manual*]. In the Load Cases Explorer, right-click on a load case, choose Properties, and select a load class. Don't forget to set the "Dead Load" load class to load cases for self-weight.

When setting up construction stages and steps, do not group activities together into a single step if they are assigned different load classes. For example, dead load and live load cases should be placed into separate construction steps. Element construction and support addition activities do not add forces to the model and can be grouped with any other activity. Tendon stressing activities are analyzed separately from other activities and are automatically assigned the Prestress Load class in results.

Three other types of activities redistribute existing forces in the structure: support removal, DOF constraint removal, and element deconstruction. Each of these activities must be handled properly if load class tracking is needed. Because a reaction force may be the result of loading from several load classes, when the support and reaction are removed the effects on the structure must be attributed correctly to the load classes that created the reaction force. For example, if Dead Load is responsible for a reaction at a support, then when the support is removed the resulting deformation of the structure must be attributed to Dead Load. If loading from several load classes has contributed to the reaction, LARSA 4D uses an incremental balanced removal procedure that generates a separate result case during the analysis for each load class's component of the reaction, allowing the effect of each load class to be included in factored combinations later. DOF constraint removal and element deconstruction are handled similarly.

Before running a Staged Construction Analysis, activate load class tracking in the analysis window by changing to the Staged Construction Options tab and selecting "Enable Class-Based Load Tracking." If this option is not turned on, redistributed forces from the construction activities mentioned above will be assigned to the "none" load class or will be grouped with loading from a load case applied within the construction step.

The Load Classes of Result Cases

In analysis results, each result case is assigned a single load class. You can check which class a result case is marked as by clicking the case in the Analysis Results Explorer [see "Analysis Results Explorer" in *LARSA 4D User's Manual*] and then looking at the information box below the explorer.

For result cases that correspond directly to a construction step in the input data, the load class will be the same as the load class of any load cases applied in the construction step. If a self-weight load case marked as the Dead Load class is applied in a construction step, the results for that step will be marked as Dead Load as well. If the construction step contained only element construction and support additions but no load cases, the results will have the "none" load class for that step.

LARSA 4D will also generate special result cases. "PT Activity" result cases are generated for construction steps in which tendons are stressed: these load cases are marked as "Prestress Load" automatically. In the Time-Dependent Staged Construction Analysis, special Creep, Shrinkage, PT Relaxation, and Other PT Losses cases are created. These cases are assigned to separate load classes for these effects.

When a construction step contains a support or DOF constraint removal or element deconstruction, LARSA 4D automatically redistributes forces separately by load class, as described above. When this occurs, separate result cases will be generated for each load class that contributed to the element internal forces. By creating separate result cases, the partial effects of each load class in the support, DOF constraint or element removal can be inspected.

Accessing Class-Based Results

LARSA 4D has several results tools which make use of load classes.

In spreadsheets [see "Results Spreadsheets" in *LARSA 4D User's Manual*] and graphical results [see "Viewing Results Graphically" in *LARSA 4D User's Manual*], the user has the option to view 1) full cumulative results, meaning the total effect on the structure of all loading and activities up to the construction step selected, 2) incremental results, meaning the changes since the immediately preceding result case, and 3) load-class extracted results, which reports the partial effect due to a single load class up to the construction step selected, by adding together the incremental effects of all construction steps for that load class up to and including the selected construction step. See Incremental and Cumulative Results [in *LARSA 4D User's Manual*].

Factored combinations of class-based results can be created with Linear Result Combinations [see "Linear Result Combinations" in *LARSA 4D User's Manual*], found in the Results menu. Using Linear Result Combinations, one can combine both the full cumulative results reported by a result case or the load-class extracted results. Full cumulative results are normally used to combine separate result cases of a basic static analysis. In Staged Construction Analysis, one can use load-class extracted results to make a factored combination of the partial effects at the last construction step. Here, one factors the extracted effects of different load classes but for the same result case. For instance, one can combine the dead load at the last step of construction with the prestress losses at the last step of construction, or at any other step of construction.

The Auto Load Combinations [see "Automatic Code-Based Load Combinations" in *LARSA 4D User's Manual*] tool in the results menu can be used to create linear result combinations automatically for code-specified combinations by selecting from the available results cases for each of the load classes referred to by the code.

Staged Construction Analysis Options

If you will be including time-effects on materials, please read the section Time Effects on Materials (page 261) to see how to set those options.

For the difference between the Standard and Time Dependent analysis types, see Overview of Staged Construction Analysis (page 249).

Because the Staged Construction Analysis is a derivative of the nonlinear static analysis, the analysis shares some of the same options, which are explained below. In addition, the Standard analysis may perform plastic pushover analyses at certain stages. Plastic pushover's auto-increment options for those steps are explained below.

Construction Stages

Choose which construction stages are to be analyzed. The analysis can only pick up from any stage up to where it last left off, or from the start.

Starting Construction Stage

The stage that the analysis will begin at.

Ending Construction Stage

The stage that the analysis will stop at.

Staged Construction Options

Choose whether geometric nonlinear will be included in the analysis.

Included Geometric Nonlinearity

Whether geometric nonlinearity will be included in the analysis. For models involving tendons, this option should be unchecked as the equivalent loads used to represent tendons do not currently follow the deformation of the model. For models involving cables, this option must be selected. When turning on this option, care must be taken when models include both geometrically nonlinear elements such as beams and geometrically linear elements such as plates/shells.

Enable Class-Based Load Tracking

Class-based load tracking is enabled so that support change and deconstruction activities apply the proportion of the reactions and element internal forces back onto the structure grouped under the load class in which the forces were created. If this option is checked, result cases will be generated as needed for each load class involved in each construction step. If this option is not checked, class-based load tracking is not enabled and support change and deconstruction activities cause reactions and element internal forces to be applied back into the model under the load class set for the deconstruction step.

Analyze Load Cases Incrementally

Analyze Load Cases Incrementally is used for improved solution convergence in highly nonlinear, soft structures when solution convergence cannot be achieved at a construction step. When the option is on, the load cases applied in each construction step are analyzed in sequence, with each load case added into the model only after solution convergence for the previous load cases has been achieved. This allows loading in a construction step to be divided and applied in smaller increments within the construction step. (When this option is off, all

loads in a construction step are applied simultaneously.) This is an advanced option that should not normally be used. As an alternative to this option, loads can be spread across multiple sequential construction steps instead of applied in a single construction step. This option cannot be combined with Enable Class-Based Load Tracking, and when this option is on the "Auto-remove loads prior to next step" option for temporary loads cannot be used.

Solution Convergence

Equilibrium iterations at a given load level can cease when the result is "close enough" according to one or more criteria. Two criteria used in LARSA are that the unbalanced force be a small fraction of the total applied force in the current load level and that the current displacement increment be a small fraction of the displacement increment. The convergence criteria are specified by the user as the displacement tolerance, force tolerance and maximum number of iterations. The iterative analysis continues until all degrees of freedom in the model satisfy displacement and force tolerance criteria within the maximum number of iterations.

If the solution is not convergent for a load step, a message is displayed on the screen. If there are additional load steps, analysis will continue if the structure is not unstable. LARSA carries the unbalanced forces into the next load step and a convergent solution may be obtained in the next load step. This may imply that your structure is fine and you either have to increase the maximum number of iterations or use a less restrictive error ratio.

Max # of Iterations

The number of iterations performed for each load step will not exceed the maximum number of iterations specified by the user. We recommend 10 to 20 as a maximum number of iterations.

Displacement Tolerance

The displacement tolerance is the error ratio of the incremental displacement computed in the last iteration divided by the total displacement for the same degree of freedom. The default value is 0.001 (0.10%).

Force Tolerance

The force tolerance is the maximum unbalanced force at any degree of freedom.

Options for Analysis Scenarios

The options below are available for pushover analysis scenarios, i.e. pushover analysis steps within Staged Construction Analysis.

Auto-Increment Options

The pushover analysis is based on automatically incrementing the load vector. Specify here the multipliers for the load vector that will be used in computing the initial load vector and the incremental load vector limitation.

Initial

This is the factor multiplying the load vector for computing the load to be applied on the structure in the first load step.

Minimum

The minimum factor multiplying the load vector that is used in any load step. When the iterative analysis requires reduction in the magnitude of the load vector, the multiplier cannot be smaller than this value.

Maximum

The maximum factor multiplying the load vector that is used in any load step.

For More Information, please refer to the following documentation.

- Running an Analysis in *LARSA 4D User's Manual*.

Solver Options

The core of the LARSA 4D analysis is the solution of the stiffness equations for displacements given forces at joints. The stiffness equations form the stiffness matrix K such that $Kd = p$, where d is a displacement vector and p is a force vector. Several numerical methods are provided to solve this system for d . The options are listed in [Analysis](#) → [Solver Options](#).

The choice of solver is a trade-off between speed and error checking. Fast numerical methods often come at the cost of not detecting all forms of numerical instability or reporting less detailed error messages. The stiffness matrix is numerically unstable when there are free degrees of freedom, also called rigid body motions. In other words, the structure is unstable. The solvers able to report which degrees of freedom are free are also the slowest.

Models may not have rigid body motions, meaning unconstrained motions. For example, two-dimensional models must have constraints in all three directions (or use Universal Restraints [in *LARSA 4D User's Manual*]) even when all loading is limited to two dimensions. A model with unconstrained motion results in a stiffness matrix K that is "singular." Some solvers detect some cases of a singular stiffness matrix and will report the problem and halt.

It is computationally expensive to know for sure whether a matrix is singular. Fast solvers will not attempt detect all types of instability. It is up to the user to ensure the model is entered correctly. These solvers may continue to report results even in these cases, but an inspection of the deformed model by the user typically will reveal there is a problem.

The **LAPACK Banded Storage Solver** is the recommended solver for small to medium sized models. This solver is optimized for Intel processors and uses a banded storage format to reduce memory consumption. It uses LU factorization with partial pivoting (similar to Gaussian elimination) and then forward/backward substitution. If the stiffness matrix is singular, the LAPACK Banded Storage Solver will report at least one degree of freedom (a joint number and direction) involved in rigid body motion.

The **Intel PARDISO Direct Sparse Solver** is recommended for large models. It is the fastest and most memory-efficient solver. As a sparse solver, it only stores the non-zero terms of the stiffness matrix in memory. The PARDISO solver is also multi-threaded, meaning it can take advantage of multi-core processors. This solver does not check the stiffness matrix for instability and may continue to produce results even for unstable models.

The **Skyline Solver** is LARSA 4D's oldest solver. It uses banded storage and a solution procedure similar to the LAPACK Banded Storage Solver. The Skyline solver currently reports the most informative error messages in the case of model instability. It is also the slowest solver.

The **Dense Matrix Storage Solver** is used for debugging unstable models only. It stores the complete matrix in memory as a dense 2D array and uses a diagonal pivoting factorization method to solve the system of equations. With the Run Instability Check option turned on, Singular Value Decomposition is used to compute the largest and smallest eigenvalues of the stiffness matrix. An eigenvalue of zero, or extremely close to zero, indicates instability. Degrees of freedom (joint number and direction) in rigid body motions are reported.

As a convenience, all solvers remove degrees of freedom with no stiffness on the diagonal of the stiffness matrix. This usually occurs in joints that are not connected to active elements or intermediate joints on spans of cable elements where there is no rotational stiffness. If these degrees of freedom were not removed, the stiffness matrix would be singular and unsolvable.

The default solver selection is Automatic Selection, which uses the LAPACK Banded Storage Solver for small models and the PARDISO Direct Sparse Solver for large models.

Part III

Analysis Results Reference

This section is a reference for each type of result produced by the analysis engine.

For More Information, please refer to the following documentation.

- Getting Results in *LARSA 4D User's Manual*.

Joint Results	275
Joint Displacements	277
Definitions	277
Joint Reactions	279
Definitions	279
Joint Velocities & Accelerations	281
Definitions	281
Member Results	283
Member End Forces	285
Definitions - General	285
Definitions - When Reported in Local Directions	285
Definitions - When Reported in Global Directions	286
Member Sectional Forces	287
Definitions	287
Member Stresses	289
Computation of Normal Stress	289
Definitions	289
Member Displacements	291
Definitions	291
Member Plastic Deformation	293
Definitions	293
Member Yield and Strains	295
Definitions	295
Span Displacements and Span Sectional Forces	297
Analyzed Member Loads	299
Definitions	299
Plate Results	301

Plate Forces on Center	303
Definitions	303
Plate Forces at Joints - External	307
Definitions	307
Plate Forces at Joints - Internal	309
Definitions	309
Plate Stresses on Center and at Joints	313
Definitions	314
Spring Results	317
Spring Forces	319
Local Axial/Local Torsional Springs	319
Translation/Rotation X/Y/Z Directions	319
Spring Deformations	321
Local Axial/Local Torsional Springs	321
Translation/Rotation X/Y/Z Directions	321
Compound Element Forces	323
Procedure	323
Sample Problem	323
Definitions	326
Tendon Results	329
Eigenvalue Results	331
Modal Frequencies	333
Definitions	333
Mode Shapes	335
Definitions	335
Modal Reactions and Modal Member/Plate Forces	337

Joint Results

Joint Displacements	277
Definitions	277
Joint Reactions	279
Definitions	279
Joint Velocities & Accelerations	281
Definitions	281

Joint Displacements

Joint displacements are the translational and rotational displacements of the joints as a result of the loading on the structure.

Every joint has, by default, six degrees of freedom: translation x/y/z and rotation x/y/z. Unless a joint's degree of freedom has been restrained by a support the joint is free to displace in that direction. (To exclude degrees of freedom from an analysis, see Universal Restraints [in *LARSA 4D User's Manual*].)

In Staged Construction or incremental nonlinear analysis, displacements are accumulated from the start of the analysis and reflect the total displacement of the joint from its undeformed position.

Definitions

Joint

The ID of the joint that this row of data refers to.

Result Case

The name of the result case that this row of data refers to.

Translation (X/Y/Z)

The translation of the joint in x, y, and z.

specified w.r.t. global coordinates, or, if *Report in Local UCS* is chosen, the displacement coordinate system of the joint (see Joints (page 59))

positive values are in the positive direction of the corresponding axis

units: displacement-category units (see Results Units)

Rotation (X/Y/Z)

The rotation of the joint about the x-, y-, and z-axes.

specified w.r.t. global coordinates, or, if *Report in Local UCS* is chosen, the displacement coordinate system of the joint (see Joints (page 59))

positive values are about the corresponding axis using the right-hand rule

units: displacement-category units (see Results Units)

For More Information, please refer to the following documentation.

- Joints on page 59.

Joint Reactions

Joint reactions are the restraining forces caused by supports.

Reactions are reported for joints that are fully or partially supported in at least one degree of freedom either from restraints (supports), grounded springs, or support activities.

Definitions

Joint

The ID of the joint that this row of data refers to. Reactions only apply for joints restrained in one or more degrees of freedom.

Result Case

The name of the result case that this row of data refers to.

Force (X/Y/Z)

The force reactions at the joint in x, y, and z.

specified w.r.t. global coordinates, or, if *Report in Local UCS* is chosen, the displacement coordinate system of the joint (see Joints (page 59))

positive values are in the positive direction of the corresponding axis

units: force-category units (see Results Units)

Moment (X/Y/Z)

The moment reactions at the joint about the x-, y-, and z-axes.

specified w.r.t. global coordinates, or, if *Report in Local UCS* is chosen, the displacement coordinate system of the joint (see Joints (page 59))

positive values are about the corresponding axis using the right-hand rule

units: force-category units (see Results Units)

For More Information, please refer to the following documentation.

- Joints on page 59.
- Springs on page 83.
- Support and Hoist Activities on page 147.

Joint Velocities & Accelerations

Joint velocities and accelerations are the velocities and accelerations at the joints.

Definitions

Joint

The ID of the joint that this row of data refers to.

Result Case

The name of the result case that this row of data refers to.

Translation (X/Y/Z)

The translational velocity or acceleration of the joint in x, y, and z.

specified w.r.t. global coordinates, or, if *Report in Local UCS* is chosen, the displacement coordinate system of the joint (see Joints (page 59))

positive values are in the positive direction of the corresponding axis

units: displacement-category units (see Results Units)

Rotation (X/Y/Z)

The rotational velocity or acceleration of the joint about the x-, y-, and z-axes.

specified w.r.t. global coordinates, or, if *Report in Local UCS* is chosen, the displacement coordinate system of the joint (see Joints (page 59))

positive values are about the corresponding axis using the right-hand rule

units: displacement-category units (see Results Units)

For More Information, please refer to the following documentation.

- Joints on page 59.

Member Results

Member End Forces	285
Definitions - General	285
Definitions - When Reported in Local Directions	285
Definitions - When Reported in Global Directions	286
Member Sectional Forces	287
Definitions	287
Member Stresses	289
Computation of Normal Stress	289
Definitions	289
Member Displacements	291
Definitions	291
Member Plastic Deformation	293
Definitions	293
Member Yield and Strains	295
Definitions	295
Span Displacements and Span Sectional Forces	297
Analyzed Member Loads	299
Definitions	299

Member End Forces

Member end forces are the resultant forces and moments acting on the ends of members, representing the effect of the structure that caused deformation of the members.

Member end forces are reported at the start and at the end of the member and are always in equilibrium. The forces and moments are reported at the centroid of the element, which may differ from the end joint locations if the member has end offsets or if the section centroid is not aligned with the member reference axis. When Composite Section Construction Activities (page 157) are used, the location of the centroid may change during the course of the analysis.

Member end forces can be reported in either in the members' local coordinate systems or in global directions. If member end forces are reported in the local systems, the results should not be summed across members unless the members are all parallel and have the same orientation angle. Similarly, when Composite Section Construction Activities (page 157) are used, the reported moments cannot be summed across construction steps because the origin about which the moments are reported may not be the same (however Incremental and Cumulative Results [in *LARSA 4D User's Manual*] can be used as they apply a transformation before summing or subtracting the results).

Definitions - General

Member

The ID of the member that this row of data refers to.

Joint

The ID of the joint at one of the ends of the member that this row of data refers to.

Result Case

The name of the result case that this row of data refers to.

Definitions - When Reported in Local Directions

This section describes the meaning of the forces and moments when member end forces are reported in local directions.

Force X

The axial force at the member end.

specified w.r.t. the local coordinate system of the member (see Members (page 61))

positive values At the start, positive values are compressive. At the end, positive values are tensile.

units: force-category units (see Results Units)

Force Y

The shear force at the member end in the member's local xy-plane.

specified w.r.t. the local coordinate system of the member (see Members (page 61))

positive values are in the positive direction of the local y-axis

units: force-category units (see Results Units)

Force Z

The shear force at the member end in the member's local xz-plane.

specified w.r.t. the local coordinate system of the member (see Members (page 61))

positive values are in the positive direction of the local z-axis

units: force-category units (see Results Units)

Moment X

The axial torque (torsion) at the member end.

specified w.r.t. the local coordinate system of the member at the member centroid (see Members (page 61))

positive values are about the member's local x-axis using the right-hand rule

units: force-category units (see Results Units)

Moment Y

The bending moment in the member's xz-plane (about the member local y-axis) at the member end.

specified w.r.t. the local coordinate system of the member at the member centroid (see Members (page 61))

positive values are about the member's local y-axis using the right-hand rule

units: force-category units (see Results Units)

Moment Z

The bending moment in the member's xy-plane (about the member local z-axis) at the member end.

specified w.r.t. the local coordinate system of the member at the member centroid (see Members (page 61))

positive values are about the member's local z-axis using the right-hand rule

units: force-category units (see Results Units)

Definitions - When Reported in Global Directions

This section describes the meaning of the forces and moments when member end forces are reported in global directions.

Force (X/Y/Z)

The forces at the member end in x, y, and z.

specified w.r.t. global directions

positive values are in the positive direction of the corresponding axis

units: force-category units (see Results Units)

Moment (X/Y/Z)

The moments at the member end about the x-, y-, and z-axes.

specified w.r.t. global directions at the member centroid

positive values are about the corresponding axis using the right-hand rule

units: force-category units (see Results Units)

For More Information, please refer to the following documentation.

- Members on page 61.

Member Sectional Forces

Member sectional forces are the internal forces and moments along the length of the member, in member local directions.

Sectional forces are reported at stations along the member. The number of stations is set in Graphical Results Options [in *LARSA 4D User's Manual*]. Sectional forces are reported at sections (faces) with a positive normal directed along the member's positive x-axis, similar to Member End Forces (page 285) at the member end. x- and z-moments are reported with the right-hand rule, while y-moments are reported with the left-hand rule. (This inconsistency has been kept for compatibility reasons over the years.)

When reporting at more than two stations, i.e. more than just the start and end of the member, sectional forces are computed using numerical integration over the length of the element based on the Member End Forces (page 285) at the start of the element and applied member loads. Because numerical integration is an approximation, results toward the ends of members may have a small degree of error.

The forces and moments are reported along the centroidal axis of the element, which may not be on the imaginary line between the member end joints if the member has end offsets or if the section centroid is not aligned with the member reference axis. When Composite Section Construction Activities (page 157) are used, the location of the centroid may change during the course of the analysis.

Because sectional forces are reported in the local systems of the members, the results should not be summed across members unless the members are all parallel and have the same orientation angle. Similarly, when Composite Section Construction Activities (page 157) are used, the reported moments cannot be summed across construction steps because the origin about which the moments are reported may not be the same (however Incremental and Cumulative Results [in *LARSA 4D User's Manual*] can be used as they apply a transformation before summing or subtracting the results).

Definitions

Member

The ID of the member that this row of data refers to.

Station

The station along the member that this row of data refers to. Stations range from 0 (the start of the member) to the number of segments specified in Graphical Results Options [in *LARSA 4D User's Manual*] (the end of the member). Stations are equally spaced.

Result Case

The name of the result case that this row of data refers to.

Force X

The axial force at the station.

specified w.r.t. the local coordinate system of the member (see Members (page 61))

positive values are always tensile (in the direction of the local x-axis)

units: force-category units (see Results Units)

Force Y

The shear force at the station in the member's local xy-plane.

specified w.r.t. the local coordinate system of the member (see Members (page 61))

positive values are in the positive direction of the local y-axis

units: force-category units (see Results Units)

Force Z

The shear force at the station in the member's local xz-plane.

specified w.r.t. the local coordinate system of the member (see Members (page 61))

positive values are in the positive direction of the local z-axis

units: force-category units (see Results Units)

Moment X

The axial torque (torsion) at the station.

specified w.r.t. the local coordinate system of the member at the member centroid (see Members (page 61))

positive values are about the member's local x-axis using the right-hand rule

units: force-category units (see Results Units)

Moment Y

The bending moment in the member's xz-plane (about the member local y-axis) at the station.

specified w.r.t. the local coordinate system of the member at the member centroid (see Members (page 61))

positive values cause compression at the positive-z side of the member (positive y-moments are about the member's local y-axis using the **left-hand rule**)

units: force-category units (see Results Units)

Moment Z

The bending moment in the member's xy-plane (about the member local z-axis) at the station.

specified w.r.t. the local coordinate system of the member at the member centroid (see Members (page 61))

positive values cause compression at the positive-y side of the member (positive z-moments are about the member's local z-axis using the right-hand rule)

units: force-category units (see Results Units)

For More Information, please refer to the following documentation.

- Members on page 61.

Member Stresses

Member stresses are the internal stresses along the length of the member, in member local directions.

Stresses are reported at stations along the member. The number of stations is set in Graphical Results Options [in *LARSA 4D User's Manual*]. Stresses at stations other than the start and end of the member are not available for members with composite sections or members that a nonlinear thermal gradient load has been applied to.

Computation of Normal Stress

Normal stress is the sum of continuity stress (extensional stresses caused by axial force and bending moments) and self-equilibrating stress.

Continuity stress is computed by the formula $F_x/\text{Area} + z \times M_y/I_{yy} + y \times M_z/I_{zz}$. For most sections, Area, I_{yy} , and I_{zz} are determined from sectional properties (page 23) and F_x , M_y , and M_z from Member Sectional Forces (page 287).

For composite sections defined in the Section Composer, Area, I_{yy} , and I_{zz} are instead the properties of the shape containing the stress recovery point and F_x , M_y , and M_z are the sectional forces in the shape containing the stress point. The sectional forces may vary across the shapes that make up a section, and differ from the total member sectional force, due to force distribution within the section, being constructed or cast at different construction stages, or having different time-dependent material properties.

Self-equilibrating stress (also known as eigenstress) may occur from several types of loading. Nonlinear thermal gradient loads (page 127) may cause self-equilibrating stress. In members with composite sections, self-equilibrating stress may also arise from time-dependent material effects (creep and shrinkage).

Definitions

Member

The ID of the member that this row of data refers to.

Station

The station along the member that this row of data refers to. Stations range from 0 (the start of the member) to the number of segments specified in Graphical Results Options [in *LARSA 4D User's Manual*] (the end of the member). Stations are equally spaced.

Result Case

The name of the result case that this row of data refers to.

P/A at Centroid

The axial stress at the centroid of the member, computed by dividing the total axial force by the total section area. For members with non-composite sections, this is also the component of any normal stress caused only by the axial force at the station. For composite sections, this value may not be meaningful.

positive values are tensile

specified w.r.t. the local coordinate system of the member (see Members (page 61))

units: stress-category units (see Results Units)

Normal Stress at Point 1...6

The normal stress at the points on the plane of the station defined by the user-specified stress recovery points (page 23). See above for the definition of normal stress.

positive values are always tensile

specified w.r.t. the local x-axis of the member (see Members (page 61)) at the member's section's stress recovery points (see Sections (page 23))

units: stress-category units (see Results Units)

Max ABS Total Stress

The maximum absolute value of the normal stresses.

positive values are always tensile

specified w.r.t. the local x-axis of the member (see Members (page 61)) at the member's section's stress recovery points (see Sections (page 23))

units: stress-category units (see Results Units)

Shear Stress (Y/Z)

The shear stresses are F_y/A_y and F_z/A_z . Shear stresses can only be reported if sectional shear areas have been specified (see Sections (page 23)). Shear stresses caused by torsion are not included. For built-up sections this value is reported as not-applicable because the component of stress due to axial force varies from location to location on the cross-section depending on the material at the point and the history of activity of the shape containing the point.

positive values are in the direction of the corresponding positive member local y- or z-axis

specified w.r.t. the local coordinate system of the member (see Members (page 61))

units: stress-category units (see Results Units)

For More Information, please refer to the following documentation.

- Members on page 61.

Member Displacements

Member displacements are the span deflections and deformations along the members.

Member displacements are computed using numerical integration over the length of the element, based on the joint forces at the start joint and applied member loads. They are reported at stations along the member. The number of stations (which is also used for the number of integration points) is set in Graphical Results Options [in *LARSA 4D User's Manual*]. Because numerical integration is an approximation, results toward the ends of members may have a small degree of error.

Member displacements are with respect to the undeformed position of the member and so include the displacements of the member end joints. These are not displacements from the chord connecting the deformed location of the end joints.

Definitions

Member

The ID of the member that this row of data refers to.

Station

The station along the member that this row of data refers to. Stations range from 0 (the start of the member) to the number of segments specified in Graphical Results Options [in *LARSA 4D User's Manual*] (the end of the member). Stations are equally spaced.

Result Case

The name of the result case that this row of data refers to.

Translation (X/Y/Z)

The translational displacement of the member at this station in x, y, and z from its undeformed position.

specified w.r.t. the local coordinate system of the member (see Members (page 61))

units: displacement-category units (see Results Units)

Rotation (X/Y/Z)

The rotational displacement of the member at this station about the x-, y-, and z-axes.

specified w.r.t. the local coordinate system of the member (see Members (page 61))

units: displacement-category units (see Results Units)

For More Information, please refer to the following documentation.

- Joints on page 59.
- Members on page 61.

Member Plastic Deformation

Member plastic deformations are the components of the deformation of a members that result from yielding, which can occur in members with hysteretic behavior. Unlike elastic deformation, plastic deformation cannot be recovered.

The hysteretic beam inelastic behavior includes both axial force-moment-moment interaction (3D coupled plasticity) and the spread of yielding along the length of the member due to hardening (distributed yield model).

Definitions

Member

The ID of the member that this row of data refers to.

Result Case

The name of the result case that this row of data refers to.

Axial Plastic Deformation

[This information has not yet been entered into the documentation. We apologize for the delay.]

Start Joint Plastic Rotation YY/ZZ

[This information has not yet been entered into the documentation. We apologize for the delay.]

positive values

specified w.r.t. the local coordinate system of the member (see Members (page 61))

units: displacement-category units (see Results Units)

End Joint Plastic Rotation YY/ZZ

[This information has not yet been entered into the documentation. We apologize for the delay.]

positive values

specified w.r.t. the local coordinate system of the member (see Members (page 61))

units: displacement-category units (see Results Units)

For More Information, please refer to the following documentation.

- Members on page 61.
- Materials on page 19.

Member Yield and Strains

Member yield and strains are reported for hysteretic beam elements. The hysteretic beam inelastic behavior includes both axial force-moment-moment interaction (3D coupled plasticity) and the spread of yielding along the length of the member due to hardening (distributed yield model).

Total strain is the summation of the axial strain and the curvature multiplied by the distance from the centroid to the fiber.

Definitions

Member

The ID of the member that this row of data refers to.

Result Case

The name of the result case that this row of data refers to.

Station

The station along the member that this row of data refers to. Stations range from 0 (the start of the member) to 1 (the end of the member). There are always 5 stations reported. Stations are at the Gauss integration points of the member.

Yield Ratio

An indication of the amount of yielding at this station on the member. Zero indicates there is no stress on the member. One indicates the member is at the point of yielding. Values greater than 1 indicate the extent of post-yielding.

Strain (Axial Only)

The total axial strain at this station on the member.

Curvature YY/ZZ

The curvature at this station on the member about the local y- or z-axis of the member.

positive values are about the corresponding axis using the right-hand rule

specified w.r.t. the local coordinate system of the member (see Members (page 61))

units: displacement-category units (see Results Units)

Span Displacements and Span Sectional Forces

Span Displacements and Span Sectional Forces report the member displacements and sectional forces for an entire span.

Span Displacements have the same definition as Member Displacements (page 291), and Span Sectional Forces have the same definition as Member Sectional Forces (page 287).

In both types of results, the locations of the stations where the displacements are reported are distributed evenly throughout the span according to the number of stations set in Graphical Results Options [in *LARSA 4D User's Manual*]. The first station in a span is the start of the first member in the span, and the last station is the end of the last member in the span.

Spans (page 73) are special entities in LARSA 4D that describe a series of connected members. The order of the members in a span is defined by the user and can be seen in the Spans spreadsheet.

For More Information, please refer to the following documentation.

- Members on page 61.
- Spans on page 73.
- Member Displacements on page 291.
- Member Sectional Forces on page 287.

Analyzed Member Loads

LARSA reports back what member loads were included in the analysis for verification purposes. The reported loads include input loads (page 111) entered by the user, computed self-weight (page 117), moving load patterns (page 133) for each generated moving load case, and tendon (page 95) equivalent forces.

For an explanation of member loads, see Member Loads (page 123) and Member Thermal Loads (page 127).

Definitions

Member

The ID of the member that the load described by this row of data is applied to.

Result Case

The name of the result case that this row of data refers to.

Load Type

Whether the load is a point force, point moment, uniform force, uniform moment, trapezoidal force or moment, thermal load, or other type of member load.

Load Direction

The direction that the load is applied in.

Magnitude at Start

The magnitude of the load at its start. For point loads, this is just the magnitude of the load.

Magnitude at End

The magnitude of the load at its end, if applicable.

Start Position

The position of the start of the load, in relative units where 0 is the start of the member and 1 is the end of the member.

End Position

The position of the end of the load, if applicable, in relative units where 0 is the start of the member and 1 is the end of the member.

For More Information, please refer to the following documentation.

- Member Loads on page 123.
- Linear Static Moving Load Analysis and Dynamic Rolling Stock Analysis on page 217.

Plate Results

Plate Forces on Center	303
Definitions	303
Plate Forces at Joints - External	307
Definitions	307
Plate Forces at Joints - Internal	309
Definitions	309
Plate Stresses on Center and at Joints	313
Definitions	314

Plate Forces on Center

Plate Forces on Center are the internal forces and moments of plates at the center of the area of the element and reported in the element's local coordinate system.

Plate forces on center are reported in plate local directions (page 75) per unit of in-plane length.

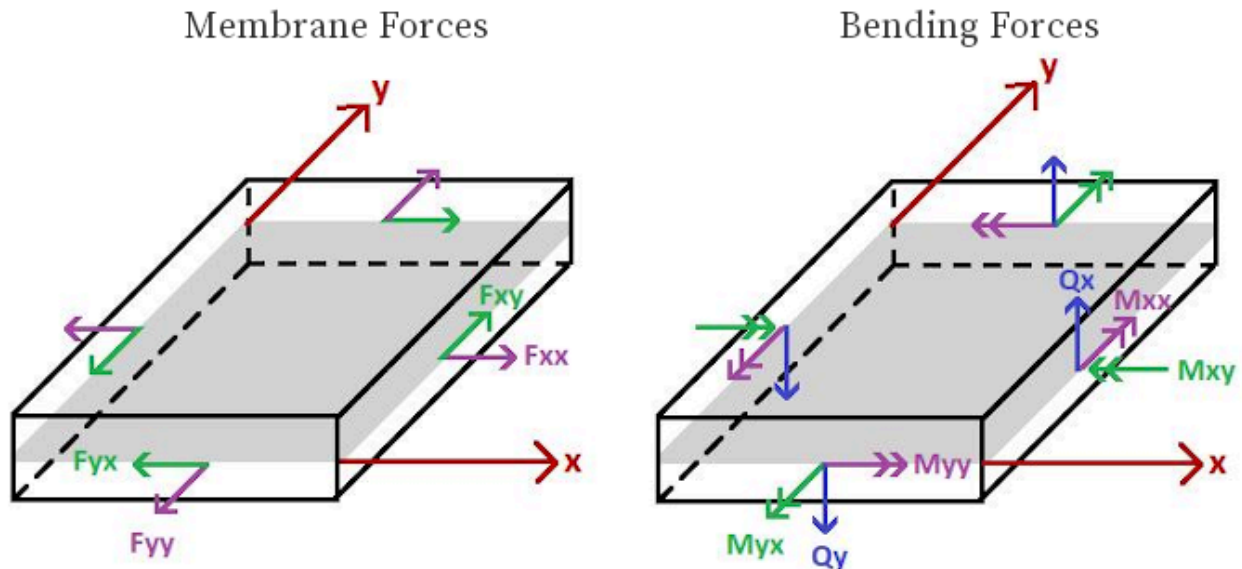

Plate Internal Force Directions

Plate forces on center are computed as the arithmetic average of element's Plate Forces at Joints - Internal (page 309) for plates without geometric nonlinearity (plates with the bilinear, incompatible, drilling, thin, think, and classic element behaviors, and the MITC4 element with geometric nonlinearity turned off). For plate elements with geometric nonlinearity (the MITC4 behavior except when geometric nonlinearity is turned off), plate forces on center are computed at the center of the element directly by the element formulation.

Plate forces on center are used for graphical result diagrams of plate forces when the solid shading option is on. When contour diagrams are turned on, Plate Forces at Joints - Internal (page 309) are used. See Viewing Results Graphically [in *LARSA 4D User's Manual*].

Definitions

Plate

The ID of the plate that this row of data refers to.

Result Case

The name of the result case that this row of data refers to.

Membrane Force F_{xx}

Membrane force in the element's local x-axis, caused by the membrane behavior of the element.

positive values are tensile

specified w.r.t. the local coordinate system of the plate (see Plates (page 75))

units: force-category units (see Results Units)

Membrane Force F_{yy}

Membrane force in the element's local y-axis, caused by the membrane behavior of the element.

positive values are tensile

specified w.r.t. the local coordinate system of the plate (see Plates (page 75))

units: force-category units (see Results Units)

In-Plane Shear F_{xy}

The in-plane shear force, caused by the membrane behavior of the element. F_{xy}, the in-plane shear force on the face normal to the x-axis and in the direction of y, is equal to F_{yx}, the in-plane shear force on the face normal to the y-axis and in the direction of x.

positive values are in the direction of the positive local x- and y-axes

specified w.r.t. the local coordinate system of the plate (see Plates (page 75))

units: force-category units (see Results Units)

Moment M_{xx}

Bending moment in the face normal to the local x-axis in the y direction, caused by the plate bending behavior of the element.

positive values cause tension on the top (positive local z) surface of the element

specified w.r.t. the local coordinate system of the plate (see Plates (page 75))

units: force-category units (see Results Units)

Moment M_{yy}

Bending moment in the face normal to the local y-axis in the x direction, caused by the plate bending behavior of the element.

positive values cause tension on the top (positive local z) surface of the element

specified w.r.t. the local coordinate system of the plate (see Plates (page 75))

units: force-category units (see Results Units)

Torsion M_{xy}

Twisting (torsional) moment on the x- and y-faces of the element, caused by the plate bending behavior of the element.

positive values cause tension on the top (positive local z) surface of the element

specified w.r.t. the local coordinate system of the plate (see Plates (page 75))

units: force-category units (see Results Units)

Shear Q_x

Shear force corresponding to the moment M_{xx}, in the local z direction.

units: force-category units (see Results Units)

Shear Q_y

Shear force corresponding to the moment M_{yy}, in the local z direction.

units: force-category units (see Results Units)

For More Information, please refer to the following documentation.

- Plates on page 75.
- Plate Forces at Joints - External on page 307.
- Plate Forces at Joints - Internal on page 309.

Plate Forces at Joints - External

Plate Forces at Joints - External are the resultant forces and moments acting on the joints of plates, representing the effect of the structure that caused deformation of the plates.

Plate external forces are similar to Member End Forces (page 285): They are the total forces the element is exerting at each joint. These are the forces used in equilibrium checks in nonlinear analysis. They can be considered as the integrated values of Plate Forces at Joints - Internal (page 309) over a portion of the area of the element. They are calculated by simply multiplying the element stiffness matrix by the displacements at its corners.

While plate internal forces are reported per unit length and in plate local directions, the external forces are the total force and may be reported with respect to one of four coordinate systems depending on the model and spreadsheet options, as described below.

External forces represent the total force at the joints, as opposed to Plate Forces on Center (page 303) and plate internal forces at joints which are per unit of in-plane length. Since external forces do not involve taking the derivative of the displacements, these forces are less prone to discontinuities at joints as plate internal forces are.

Plate force graphical result diagrams are based on Plate Forces on Center (page 303) and Plate Forces at Joints - Internal (page 309) (see Viewing Results Graphically [in *LARSA 4D User's Manual*]). Plate external forces are used in the computation of Compound Element Forces (page 323).

Definitions

Plate

The ID of the plate that this row of data refers to.

Joint

The ID of the joint at the corner of the plate that this row of data refers to.

Result Case

The name of the result case that this row of data refers to.

Force (Fx/Fy/Fz)

The forces at the joint in x, y, and z directions.

specified w.r.t. Forces and moments may be reported with respect to one of four coordinate systems depending on the model and spreadsheet options: When the "Report in UCS" option is turned off in the results spreadsheet, if the joint has a displacement user coordinate system, those directions are used, otherwise, if the joint does not have a displacement UCS, the global coordinate system directions are used. If the "Report in UCS" option is turned on in the results spreadsheet, forces and moments are reported in the active user coordinate system's directions if a UCS is active, otherwise the plate's local coordinate system directions are used.

positive values are in the positive direction of the corresponding axis

units: force-category units (see Results Units)

Moment (Mx/My/Mz)

The moments at the joint about the x-, y-, and z-axes.

specified w.r.t. Forces and moments may be reported with respect to one of four coordinate systems depending on the model and spreadsheet options: When the “Report in UCS” option is turned off in the results spreadsheet, if the joint has a displacement user coordinate system, those directions are used, otherwise, if the joint does not have a displacement UCS, the global coordinate system directions are used. If the “Report in UCS” option is turned on in the results spreadsheet, forces and moments are reported in the active user coordinate system’s directions if a UCS is active, otherwise the plate’s local coordinate system directions are used.

positive values are about the corresponding axis using the right-hand rule

units: force-category units (see Results Units)

For More Information, please refer to the following documentation.

- Plates on page 75.
- Plate Forces at Joints - Internal on page 309.
- Plate Forces on Center on page 303.

Plate Forces at Joints - Internal

Plate Forces at Joints - Internal are the forces and moments within a plate element at each corner of the plate.

Internal plate forces at joints are reported in plate local directions (page 75) per unit of in-plane length. Internal forces may not be the same when obtained from two different plate elements at the same joint because the internal strains are very sensitive to errors in displacements, or if the local coordinate systems of the two elements are not aligned. When the plate has end offsets, these are the forces at the corners of the plate (not at the joints).

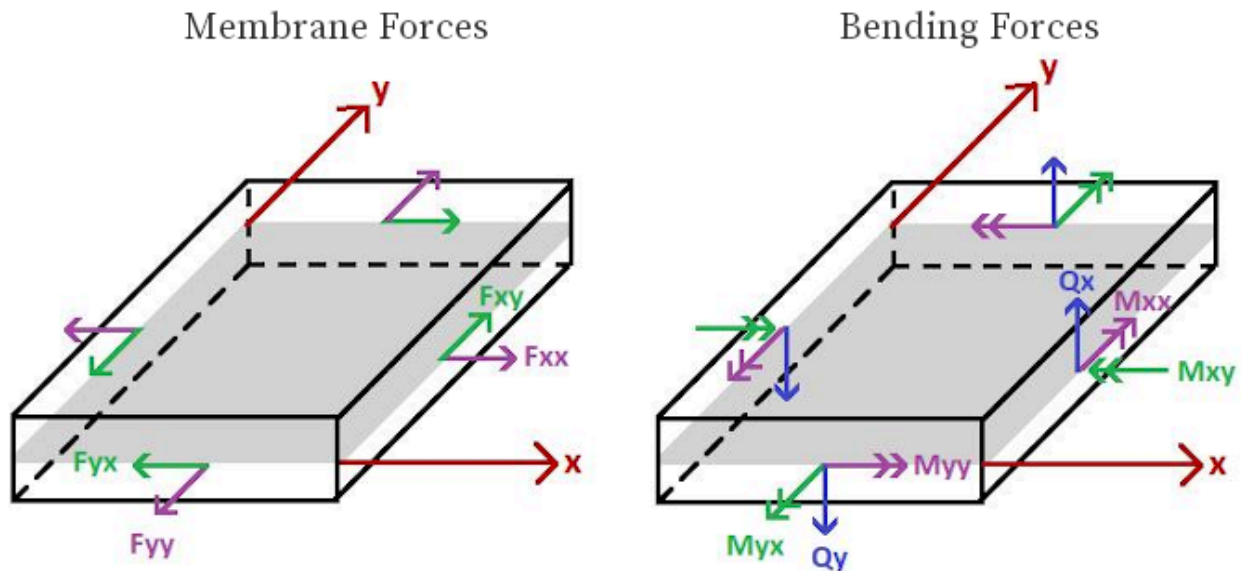

Plate Internal Force Directions

These results are used for graphical result diagrams of plate forces when the contour diagrams option is turned on. When plotted in the LARSA 4D graphics window, the force shown at each plate corner is the average of the forces at the joint across all of the plate elements connected to that joint, to smooth out the discontinuities discussed above. (This occurs regardless of whether the plates are oriented in the same manner or whether the plates have equal offsets. No transformation is performed.) When the solid shading option is on, Plate Forces on Center (page 303) are used. Plate Forces on Center (page 303) are used. (See Viewing Results Graphically [in *LARSA 4D User's Manual*].)

Internal forces are determined by combining the forces due to the membrane behavior and the bending behavior of the element. For membrane elements, the in-plane strains from displacements are used to compute in-plane stresses which are then multiplied by the element thickness. For plate bending elements, the curvatures from displacements are used to compute moments. Each membrane and bending behavior has a different shape function.

Plate Forces on Center (page 303) are the average of these forces. Plate Forces at Joints - External (page 307) are resultant forces. Instead of using plate internal forces, also consider using Compound Element Forces (page 323) over a tributary area.

Definitions

Plate

The ID of the plate that this row of data refers to.

Joint

The ID of the joint at the corner of the plate that this row of data refers to.

Result Case

The name of the result case that this row of data refers to.

Membrane Force (Fxx/Fyy)

Membrane force in the element's local x- and y-axes, caused by the membrane behavior of the element, in local directions, per unit of in-plane length.

specified w.r.t. local directions

positive values are in the positive direction of the corresponding axis

units: force-category units (see Results Units)

In-Plane Shear Fxy

The in-plane shear force, caused by the membrane behavior of the element, in local directions, per unit of in-plane length. F_{xy} , the in-plane shear force on the face normal to the x-axis and in the direction of y, is equal to F_{yx} , the in-plane shear force on the face normal to the y-axis and in the direction of x.

specified w.r.t. local directions

positive values are in the positive direction of the corresponding axis

units: force-category units (see Results Units)

Moment (Mx/My)

Bending moment in the face normal to the local x-axis in the y direction, caused by the plate bending behavior of the element, in local directions, per unit of in-plane length.

specified w.r.t. local directions

positive values are about the corresponding axis using the right-hand rule

units: force-category units (see Results Units)

Torsion (Mxy)

Twisting (torsional) moment on the x- and y-faces of the element, caused by the plate bending behavior of the element, in local directions, per unit of in-plane length.

specified w.r.t. local directions

positive values are about the corresponding axis using the right-hand rule

units: force-category units (see Results Units)

Shear (Qx/Qy)

Shear force Q_x corresponding to the moment M_x , and likewise for Q_y and M_y , in the local z direction, per unit of in-plane length.

specified w.r.t. local directions

units: force-category units (see Results Units)

For More Information, please refer to the following documentation.

- Plates on page 75.

- Plate Forces at Joints - External on page 307.
- Plate Forces on Center on page 303.

Plate Stresses on Center and at Joints

Plate stresses are the internal stresses of plates. Stresses are reported either at the center of the plate, in the spreadsheet named Plate Stresses on Center, or at the corners of the plate, in the spreadsheet named Plate Stresses at Joints.

For each plate, three results are available: stresses at the top (local +z), middle, and bottom (local -z) of the plate. For Plate Stresses at Joints, these three stresses are reported at each of the plate's three (for triangular plates) or four (for quadrilateral plates) corners. (When the plate has end offsets, these are the forces at the corners of the plate, not at the joints.)

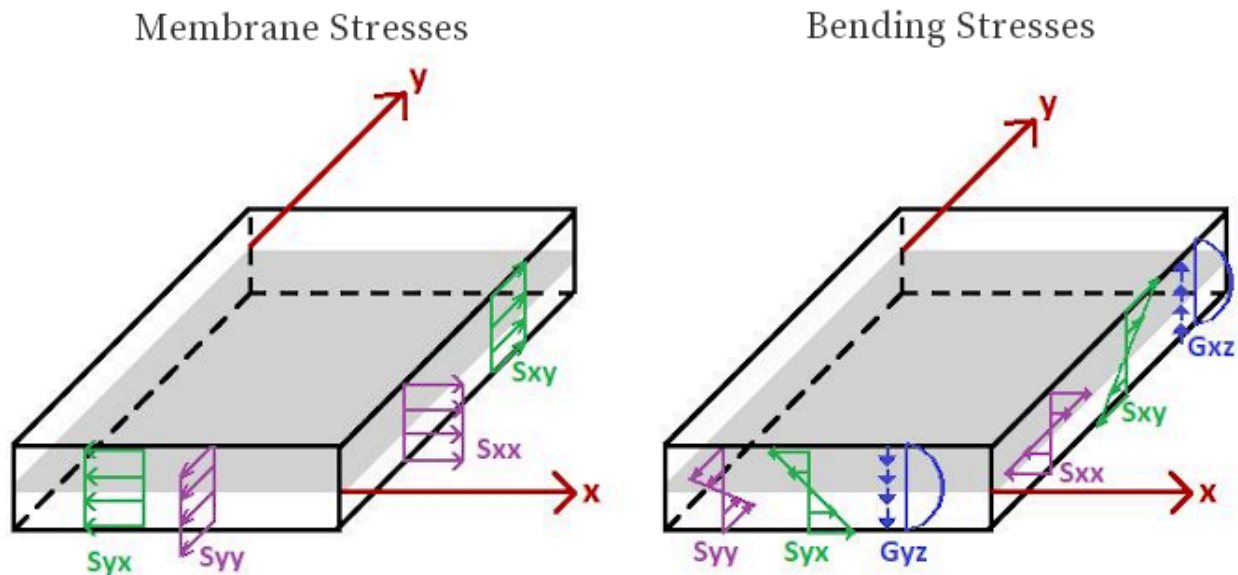

Plate Stress Directions

Plate Stresses on Center are computed from Plate Forces on Center (page 303) and element thickness. In the LARSA 4D graphics window, plate stress diagrams are based on Plate Stresses on Center when the solid shading option is on.

Plate Stresses at Joints are computed from Plate Forces at Joints - Internal (page 309) and as discussed in that section, discontinuities are expected at joints. In the LARSA 4D graphics window, plate stress diagrams are based on Plate Stresses at Joints when the contour diagrams option is on. When plotted in the LARSA 4D graphics window, the stress shown at each joint is the average of the stresses that are reported across all of the plate elements connected to that joint, to smooth out those discontinuities. (This occurs regardless of whether the plates are oriented in the same manner or whether the plates have equal offsets. No transformation is performed.)

Plate elements with the MITC4 behavior report Second Piola Kirchoff stresses in the local coordinates of the element. In the strain range applicable to the MITC4 element, Second Piola Kirchoff stresses are close to the engineering stresses.

In the graphics window, the principal stresses can also be shown. See Viewing Results Graphically [in *LARSA 4D User's Manual*].

Definitions

Plate

The ID of the plate that this row of data refers to.

Result Case

The name of the result case that this row of data refers to.

Joint

For Plate Stresses at Joints, this column indicates the joint ID at which the stress is being reported at. For triangular plates, a blank row may be entered in the spreadsheet for the K-Joint field although it is not used.

Location

The location on the plate for where the stress is reported: Top (+z local), Middle (z=0), Bottom (-z local).

Stress Sxx

The stress on the face normal to the local x-axis and in the direction of the local x-axis.

positive values are always tensile

specified w.r.t. the local coordinate system of the plate (see Plates (page 75))

units: stress-category units (see Results Units)

Stress Syy

The stress on the face normal to the local y-axis and in the direction of the local y-axis.

positive values are always tensile

specified w.r.t. the local coordinate system of the plate (see Plates (page 75))

units: stress-category units (see Results Units)

Stress Sxy

The stress on the face normal to the local x- or y-axis and in the direction of the other. The stress on the x-face in the direction of y is equal to the stress on the y-face in the direction of x.

positive values are always tensile

specified w.r.t. the local coordinate system of the plate (see Plates (page 75))

units: stress-category units (see Results Units)

Principal Max/Min

The largest possible normal stress and the smallest possible normal stress, which are always in orthogonal directions and may not be aligned with the x- and y-axes of the plate. On planes on which maximum or minimum normal stresses occur, there are no shear stresses. These planes are called the principal planes of stress. The direction of the principal planes of stress with respect to the local coordinate system of the plate is reported in the *Angle* field, described below.

The maximum shear stress can be computed by using the principal stresses as follows:

$$T_{\max} = (\text{Principal}_{\max} - \text{Principal}_{\min}) / 2$$

$$T_{\min} = -(\text{Principal}_{\max} - \text{Principal}_{\min}) / 2$$

positive values are always tensile

units: stress-category units (see Results Units)

Von Mises Stress

Von Misss Stress is usually used in yield and fracture criteria.

units: stress-category units (see Results Units)

Angle

The direction of the principal max stress as the angular offset from the local x-axis, in degrees. If Angle is 0, the principal max stress is in the direction of the positive local x-axis.

specified w.r.t. the local coordinate system of the plate (see Plates (page 75))

units: stress-category units (see Results Units)

For More Information, please refer to the following documentation.

- Plates on page 75.

Spring Results

Spring Forces	319
Local Axial/Local Torsional Springs	319
Translation/Rotation X/Y/Z Directions	319
Spring Deformations	321
Local Axial/Local Torsional Springs	321
Translation/Rotation X/Y/Z Directions	321

Spring Forces

Spring forces report the forces and moments acting on grounded and two-node springs.

The spring element has forces that are equal at both ends.

Forces are reported differently for the different spring directions. The following two fields are common to all spring force results.

Spring

The ID of the spring that this row of data refers to.

Result Case

The name of the result case that this row of data refers to.

The meaning of the remaining fields vary depending on the spring's direction attribute.

Local Axial/Local Torsional Springs

Spring forces for local axial and local torsional springs are reported in or about the axis from the start joint to the end joint. These directions are applicable to two-node springs only.

Either Force F_x or Moment M_x will have a nonzero value, depending on the spring direction.

Force F_x

The axial translational force in the spring.

positive values are compressive

units: force-category units (see Results Units)

Moment M_x

The axial moment in the spring.

positive values are about the local axis in the direction of the right-hand rule

units: force-category units (see Results Units)

Translation/Rotation X/Y/Z Directions

Springs acting in these directions have forces reported in global directions, except when a spring's start joint (or for a grounded spring its only joint) has a displacement coordinate system assigned, in which case the displacement system directions of that joint are used (regardless of any displacement coordinate system assigned to the end joint).

Only springs with 6x6 stiffness matrices assigned can have stiffness in more than one direction. Other springs will only have one non-zero force component.

For these springs, there is no notion of tension or compression. The spring forces are reported as the forces at the start of the spring element, in the spring's direction. For a grounded (one-node) spring, the sign of the spring force is same as that of the displacement of the joint in the spring's direction. For a two-node spring, the sign of the spring force matches the sign of the displacement of the first node minus the displacement of the second node, in the spring's direction.

Force Fx/Fy/Fz

The translational forces in the x-, y-, and z-directions.

units: force-category units (see Results Units)

Moment Mx/My/Mz

The moments about the x-, y-, and z-axes.

units: force-category units (see Results Units)

For More Information, please refer to the following documentation.

- Springs on page 83.

Spring Deformations

Spring deformations report the deformation (elongation) of grounded and two-node springs.

Deformations are reported differently for the different spring directions. The following two fields are common to all spring force results.

Spring

The ID of the spring that this row of data refers to.

Result Case

The name of the result case that this row of data refers to.

The meaning of the remaining fields vary depending on the spring's direction attribute.

Local Axial/Local Torsional Springs

Spring deformations for local axial and local torsional springs are reported in or about the axis from the start joint to the end joint. These directions are applicable to two-node springs only.

Either Translation X or Rotation X will have a nonzero value, depending on the spring direction.

Translation X

The axial elongation of the spring.

positive values are elongation

units: length-category units (see Results Units)

Rotation X

The axial rotation of the spring.

positive values are about the local axis in the direction of the right-hand rule

units: angle-category units (see Results Units)

Translation/Rotation X/Y/Z Directions

Springs acting in these directions have deformation reported in global directions, except when a spring's start joint (or for a grounded spring its only joint) has a displacement coordinate system assigned, in which case the displacement system directions of that joint are used (regardless of any displacement coordinate system assigned to the end joint).

Only springs with 6x6 stiffness matrices assigned can have deformation in more than one direction. Other springs will only have one non-zero deformation component. A spring's deformation may not match the relative displacements of the spring's joint or end joints because deformation is only counted in the direction(s) the spring acts in.

For these springs, there is no notion of elongation or shortening. Positive values correspond to a relative displacement of the end joint in the positive directive compared to the displacement of the start joint (That is, the end joint's displacement minus start joint's displacement), in the direction chosen.

Translation X/Y/Z

The translational deformation in the x-, y-, and z-directions.

positive values are in the direction of the positive axis

units: length-category units (see Results Units)

Moment Mx/My/Mz

The rotations about the x-, y-, and z-axes.

positive values are about the axis in the direction of the right-hand rule

units: length-category units (see Results Units)

For More Information, please refer to the following documentation.

- Springs on page 83.

Compound Element Forces

Compound Element Forces report the combined forces and moments of a group of elements about their combined centroid. These results are usually used to determine the forces in a girder or composite girder modeled as a combination of beam and plate elements.

LARSA 4D can be used to model complex 3D bridge deck configurations using shell elements and beam elements. This may be required to conduct influence surface calculations for live load code analyses. A 3D model may also be necessary for curved or skewed bridge configurations or in order to determine stress results in the complex structural configuration.

Having completed a 3D analysis, code checking may require the values of the resultant section forces acting at the center of gravity of the composite cross section. The procedure outlined here presents a method of obtaining the required forces.

Procedure

The user constructs the 3D model of the girder made up of many elements using either global coordinates or a user coordinate system such as a Bridge Path Coordinate System (page 47). The user also enters a number of stations along the selected coordinate system x-axis to be used for the computation of the compound element forces. At each station, a section plane is created laterally perpendicular to the bridge path and perpendicular to the XY plane. This plane passes through elements in the model representing the bridge girder. The analysis results Member End Forces (page 285) and Plate Forces at Joints - External (page 307) present the forces and moments acting at each node of each element through which the section plane passes. The forces at the nodes of each element are then proportioned to determine their values at the location of the intersection with the section plane. This is done for each element intersection at every station along the length of the girder. The forces and moments at each intersection point in the section plane are then used to compute the equivalent forces and moments at the center of gravity of the cross section. The center of gravity is computed by the program for the respective cross sections at every station along the length of the deck.

The section locations are selected by the program at each unit of the coordinate measured along the length of the bridge path. For example, if the bridge path length is 50 feet and the units of length are in feet then there will be 50 stations, one at every foot of length.

Sample Problem

This tutorial guides you through an analysis which determines the compound element forces in a bridge deck with a tub box cross section. The example structure is a curved bridge deck as shown in Figure 1. The actual deck cross section is shown in Figure 2. The cross section is constant along the entire length of the bridge. The only load case considered here is the dead load of the tub box deck.

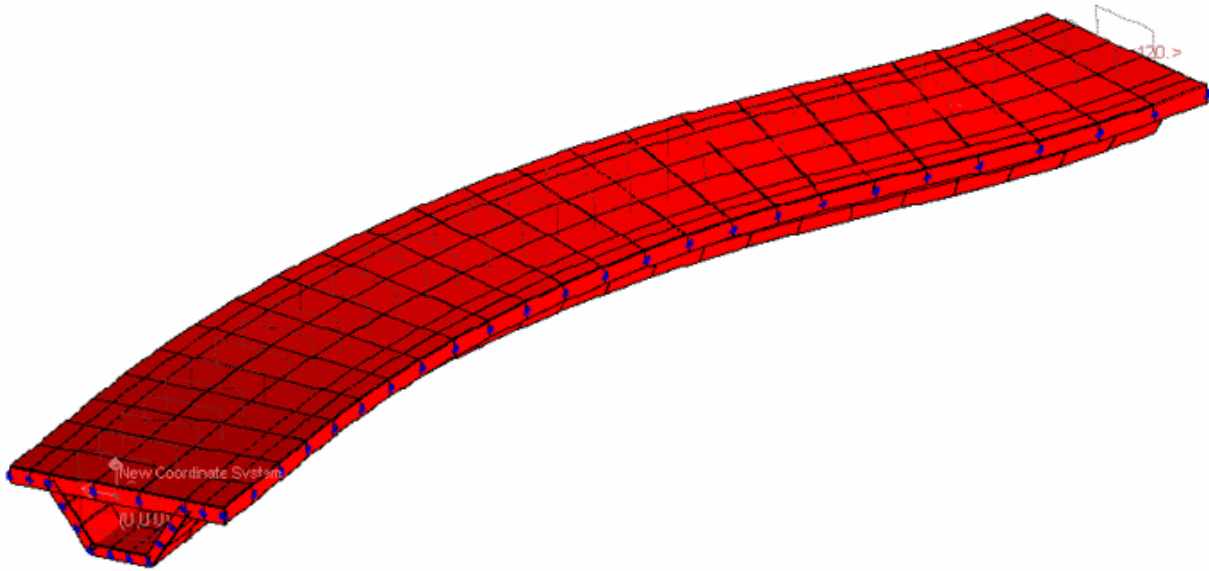

Figure 1: Example Structure

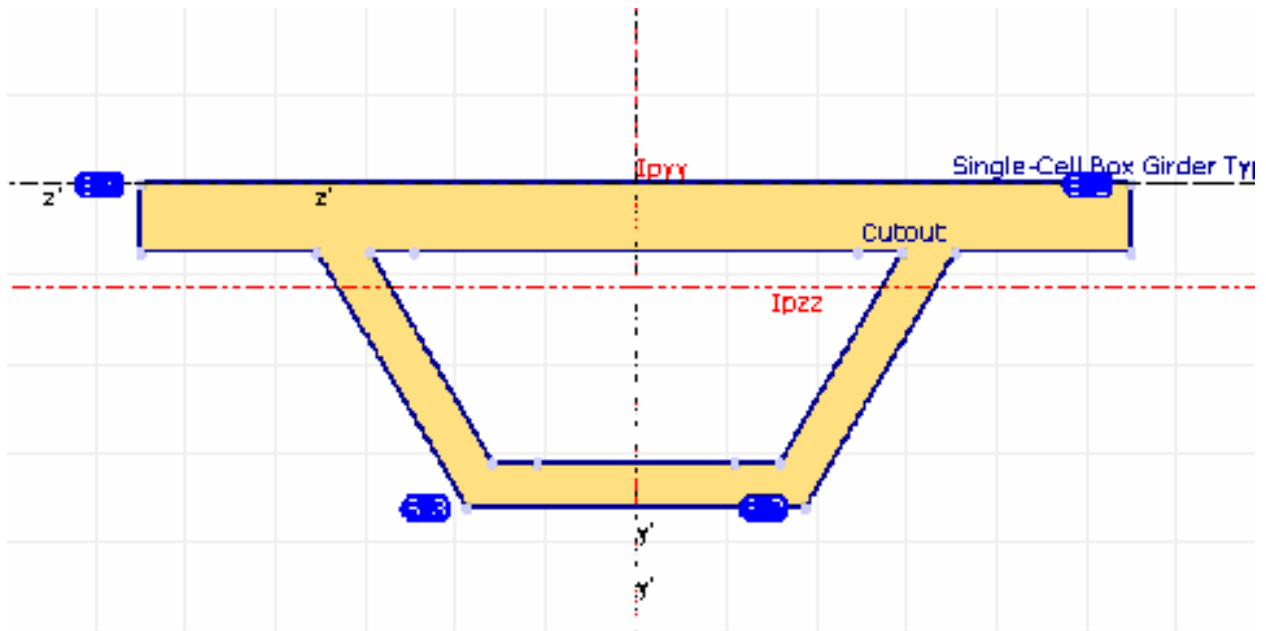

Figure 2: Deck Cross-Section

The bridge model is constructed using the bridge path coordinate system. Shell elements are used to model the tub box cross section as shown in Figure 3. Thicknesses of the shell elements are taken to match the thickness of each section of the tub box. The top plate is 20" thick and the side walls and bottom plate are 12" thick. The modulus of elasticity is 3.605 106 PSI, unit weight is 0.086 lb/in³ and Poisson's ratio is 0.17.

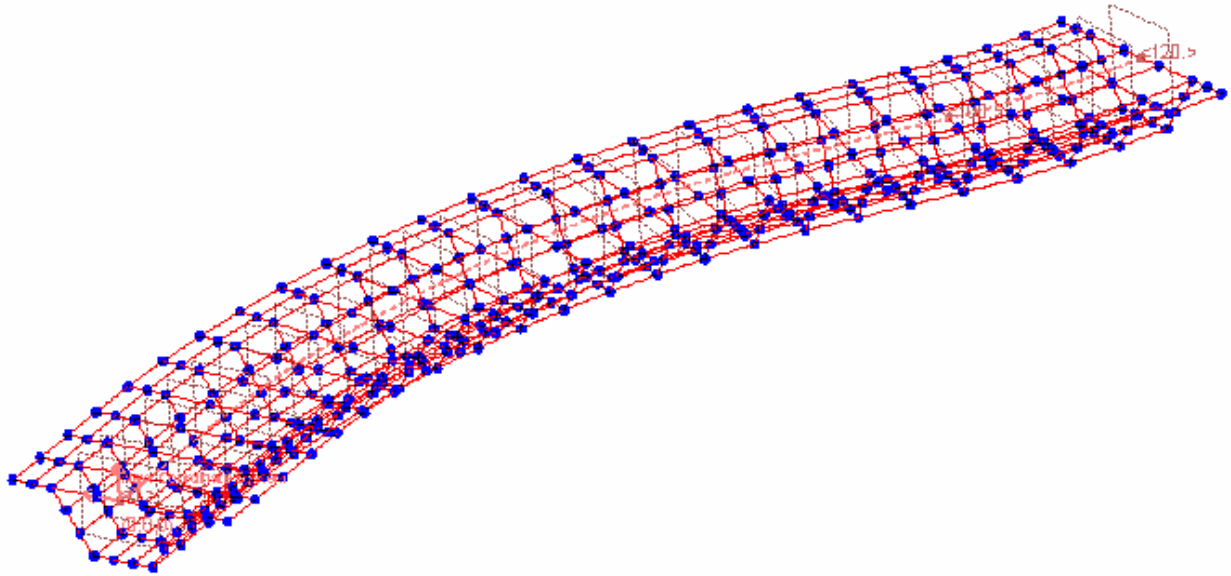

Figure 3: Shell Model of Girder

The next step is to conduct a stress analysis of the bridge deck. To this point nothing different has been required of the modeling or analysis in order to obtain the compound element forces. The compound element force computation is done entirely using the analysis results.

Activate the appropriate result case from the Analysis Results Explorer and then right click to select Compound Element Forces. The values of the compound element forces and moments acting at the sections centers of gravity will then be presented for each station along the length of the beam. These force and moment values are presented in a coordinate system which has the three orthogonal coordinates described below.

This coordinate system is always centered at the intersection of the bridge path with the section plane. The length along the bridge line is 120 feet. Therefore there are 120 stations along the length of the bridge.

In order to evaluate the results computed for this sample problem, an equivalent beam model of the deck was made and the analysis results were compared to those obtained using the shell element model and the Compound Element Force generator. For this beam model the area and moment of inertia of the section were determined using the LARSA Section Composer. The member length was arranged so that the nodes connecting each member coincided with the location of the intersecting planes in the shell model.

Figure 4 presents a comparison of the moment about the Y direction in the reference coordinate system. The curve labeled Plate 1 was obtained using the model shown in Figure 3. Although the values do not differ greatly from the values obtained using the beam model (shown as "Member") the curve is irregular and therefore questionable. In order to obtain a better comparison, the number of elements along the length of the deck was doubled by breaking each shell element in half in that direction. The mesh size in the lateral direction was left unchanged. The results are presented in the figure with the label Plate 2. There is a marked improvement with the curve almost coincident with the beam model with just a few areas of irregularity. An additional analysis was conducted by repeating the process of doubling the number of elements with the results presented as Plate 3. Here the results are almost coincident without major irregularities.

As with all finite element analyses, the user may chose the mesh size that will provide the required accuracy of results.

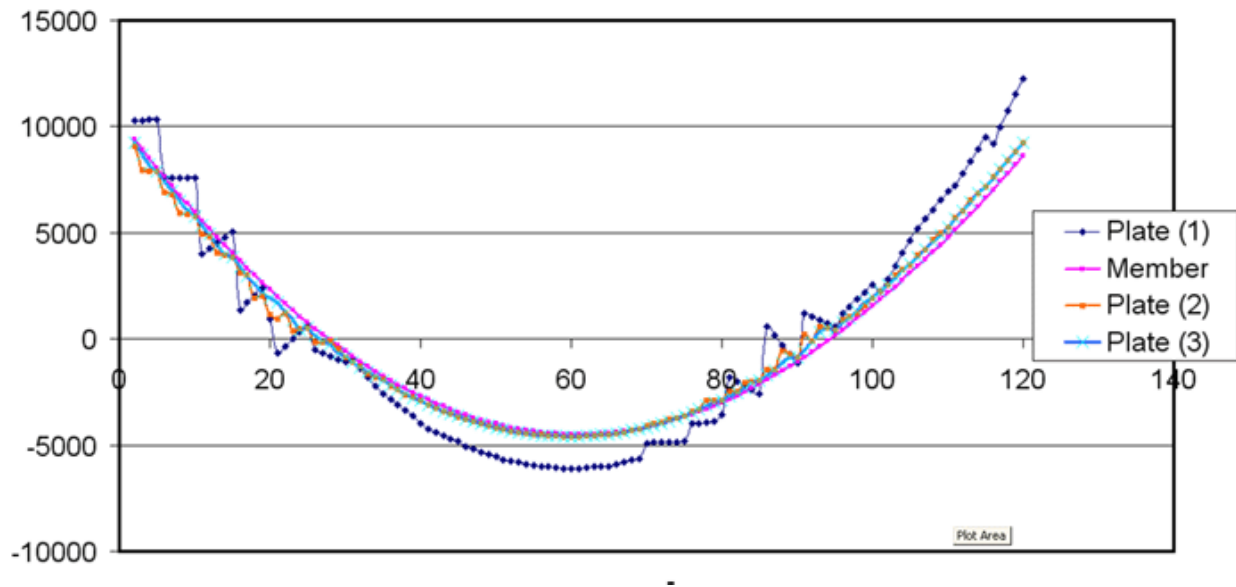

Figure 4: Comparison of Compound Element Forces and Member Sectional Forces for an Equivalent Model, for different plate mesh sizes

Definitions

Each row in the Compound Element Forces spreadsheet represents a section plane, which occur at intervals along the x-axis of the active user coordinate system, the station axis of an active Bridge Path Coordinate System, or if no user coordinate system is active then the x-axis of the global coordinate system.

Elements

A list of elements found on the section plane. "M" precedes the IDs of members, and "P" precedes the IDs of plates.

Path

The name of the active user coordinate system, if one is active.

Station

The location of the section plane on the x-axis or station-axis of the active coordinate system.

specified w.r.t. the x-axis of the active coordinate system, or the global coordinate system if no user coordinate system is active

Result Case

The name of the result case that element forces were drawn from.

Centroid (X/Y/Z)

The location of the centroid of the elements that intersect the section plane in local coordinates of the active user coordinate system, or in global coordinates if no user coordinate system is active. The Centroid X column is always zero as the x-coordinate is reported in the Station column.

specified w.r.t. the active coordinate system, or the global coordinate system if no user coordinate system is active

Force (X/Y/Z)

The combined forces in the elements found in the section plane transformed to the location of their compound centroid.

specified w.r.t. the active coordinate system, or the global coordinate system if no user coordinate system is active

units: force-category units (see Results Units)

Moment (X/Y/Z)

The combined moments in the elements found in the section plane transformed to the location of their compound centroid.

specified w.r.t. the active coordinate system, or the global coordinate system if no user coordinate system is active

units: force-category units (see Results Units)

Tendon Results

Tendon results include tendon forces along the tendon, forces at member ends, and detailed forces at member ends. These results are available in the Staged Construction Analysis.

This section describes the four related tendon results.

Tendon Forces Variation Along Length

Reports the forces of a specific tendon along its path. Forces are reported at roughly 1-foot intervals.

Tendon Forces Total at Member Ends

For selected members, reports the total of all tendon forces passing through the ends of the member.

Tendon Forces Detailed at Member Ends

For selected members, reports the forces of each tendon passing through the member's ends.

Tendon Forces Detailed at Member Ends for PT Path

For a selected tendon, reports each member along the path of the tendon and the forces of each tendon passing through the members' ends.

Tendon

The name of the tendon that this row of data refers to.

Member

The ID of the member that this point on the tendon falls within.

Location

Specifies whether this row of data refers to a point at the start or end of the member.

of Tendons

The total number of tendons passing through at the given location.

Distance

The distance of the station from the start of the specified tendon path.

Stage

The construction stage result case for which this result applies.

Force in Tendon

Total force in the tendon at the given distance.

Force Fx/Fy/Fz

The force in the tendon at the given distance in each direction in member local directions.

X/Y/Z in Member Local

The coordinates of the tendon at the given distance along the tendon path relative to the member local coordinate system.

Primary Mx/My/Mz

The primary moment caused by this tendon in each direction in member local directions.

Secondary Mx/My/Mz

The secondary moment caused by this tendon in each direction in member local directions.

For More Information, please refer to the following documentation.

- Tendons on page 95.
- Tendon Results Tools in *LARSA 4D User's Manual*.

Eigenvalue Results

Modal Frequencies	333
Definitions	333
Mode Shapes	335
Definitions	335
Modal Reactions and Modal Member/Plate Forces	337

Modal Frequencies

Modal frequencies are the undamped, free vibration frequencies of the structure, computed by an eigenvalue analysis.

LARSA computes the modes starting with the lowest frequency modes of a structure. The number of modes computed is limited by the number of modes requested when the analysis is run (Eigenvalue Analysis Options (page 183)) and the number of mass degrees of freedom.

Mode frequencies are reported in order of increasing frequency.

The participating mass ratio indicates the importance of this mode in the computation of the dynamic response, such as in Response Spectra Analysis (page 187).

Mode Shapes (page 335) are available for each mode frequency.

Definitions

Mode Shape

The name of the mode shape.

Frequency

The frequency of the mode shape.

units: cycles per second

Period

The period of the mode shape.

units: seconds

Participating Mass Percent (X/Y/Z)

The modal participating mass in each global direction, reported as a percent of the total mass.

Cumulative Participating Mass Percent (X/Y/Z)

The cumulative sum of all participating mass ratios for all mode frequencies below and including this one, reported as a percent of the total mass.

Mode Shapes

Mode shapes (eigenvectors, characteristic vectors, or normal modes) represent the amplitudes of motion of the structure for each dynamic mode.

The amplitudes are normalized with respect to the mass matrix of the structure.

Mode shapes are reported for each modal frequency (page 333).

Definitions

Joint

The ID of the joint that this row of data refers to.

Result Case (Mode Shape)

The name of the mode shape that this row of data refers to.

Translation (X/Y/Z)

The translation of the joint in x, y, and z. These values are unitless.

positive values are in the positive directions of the global coordinate system

specified w.r.t. global coordinates

Rotation (X/Y/Z)

The rotation of the joint about the x-, y-, and z-axes. These values are unitless.

positive values are about the global axes using the right-hand rule

specified w.r.t. global coordinates

For More Information, please refer to the following documentation.

- Modal Frequencies on page 333.

Modal Reactions and Modal Member/Plate Forces

Modal internal forces and reactions are computed for each mode (page 333) using the mode shapes (page 335) as the displacements of the structure.

For more information on these modal results, see the corresponding results for a static/dynamic analysis:

- Joint Reactions (page 279)
- Member End Forces (page 285)
- Plate Forces on Center (page 303)

Index

- AASHTO LRFD, 261
- acceleration, 281
- acceleration excitation function, 137
- active/inactive option, 113
- analysis options, 271
- analysis scenarios, 161
- analytical members, 73
- analyzed loads, 299
- anchor set, 95
- axial force
 - Member End Forces, 285
 - Member Sectional Forces, 287
 - Spring Forces, 319
- backbone, 29
- banded storage solver, 271
- beams, 61
- bearings
 - Isolator Property Definitions, 37
 - Isolators, 89
- beta angle, 61
- bridge coordinate systems, 47
- bridge paths, 47
- buckling, 197
- cables, 61
- cast in place, 141
- casting day
 - Cast Concrete Activities, 155
 - Members, 61
- CEB-FIP 2010, 261
- CEB-FIP 78, 261
- CEB-FIP 90, 261
- cement hardening, 19
- chains of members, 73
- characteristic vectors, 335
- coefficient of thermal expansion, 19
- collapse, 197
- combining results, 115
- composite sections, 157
- compound element forces, 323
- compression
 - Member End Forces, 285
 - Member Sectional Forces, 287
- compressive strength, 19
- concrete
 - Cast Concrete Activities, 155
 - Members, 61
- concrete creep and shrinkage
 - Time Effects on Materials, 261
 - Time-Dependent Material Property Definitions, 53
- constraints
 - DOF Constraints, 93
 - Joints, 59

- construct, 157
- construct activity, 251
- constructing elements, 141
- construction activities
 - Analysis Scenarios, 161
 - Cast Concrete Activities, 155
 - Composite Section Construction Activities, 157
 - Construct and Deconstruct Activities, 141
 - Construction Activities, 139
 - Displacement Initializations, 153
 - DOF Constraint Change Activities, 149
 - Load Activities, 145
 - Support and Hoist Activities, 147
 - Tendon Stressing and Slackening Activities, 151
- construction steps, 249
- coordinate systems
 - Bridge Paths, 47
 - User Coordinate Systems, 39
- coordinates, 59
- creep
 - Sections, 23
 - Time Effects on Materials, 261
 - Time-Dependent Material Property Definitions, 53
- cross-sectional properties, 23
- curvature, 295
- cylindrical coordinate systems, 39
- deconstruct activity
 - Load Class Tracking, 265
 - Staged Construction Activities, 251
- deconstructing elements, 141
- deconstruction/demolition, 249
- deformation, 293
- deformations, 321
- dense matrix storage solver, 271
- dependent joint, 93
- direct sparse solver, 271
- displacement, 321
- displacement excitation function, 137
- displacement initialization, 251
- displacement initializations, 153
- displacement loads, 121
- displacements
 - Joint Displacements, 277
 - Member Displacements, 291
 - Span Displacements and Span Sectional Forces, 297
- distributed loads
 - Member Loads, 123
 - Plate Loads, 129
- DOF Constraint activity
 - Load Class Tracking, 265
 - Staged Construction Activities, 251
- DOF Constraints
 - DOF Constraint Change Activities, 149
 - DOF Constraints, 93
- ductility, 23
- dynamic analysis
 - Linear Time History Analysis, 207
 - Nonlinear Time History Analysis, 211

- Response Spectra Analysis, 187
 - Time History Loads, 137
- dynamic mass, 137
- eigenstress, 127
- eigenvalue analysis
 - Eigenvalue Analysis Options, 183
 - Eigenvalue and Stressed Eigenvalue Analysis, 181
 - Response Spectra Analysis, 187
 - Stressed Eigenvalue Analysis Options, 185
- eigenvectors, 335
- elastic modulus
 - Materials, 19
 - Time Effects on Materials, 261
- EN1992-1-1:2004(E), 261
- end offsets and releases, 61
- Eurocode, 261
- excitations, 137
- fck, 19
- follower forces, 173
- force excitation function, 137
- forces
 - Compound Element Forces, 323
 - Joint Reactions, 279
 - Member End Forces, 285
 - Member Sectional Forces, 287
 - Plate Forces at Joints - External, 307
 - Plate Forces at Joints - Internal, 309
 - Plate Forces on Center, 303
 - Spring Forces, 319
 - Tendon Results, 329
- frequencies, 333
- generated loads, 299
- groups of members, 73
- guaranteed ultimate tensile strength, 19
- hinged cast, 141
- hoist, 147
- hoist activity, 251
- HSXX vehicles, 219
- hysteretic members
 - Member Yield and Strains, 295
 - Members, 61
- hysteretic springs
 - Spring Property Definitions, 29
 - Springs, 83
- incremental loading, 197
- inelastic material properties, 19
- inelastic members, 295
- influence lines and surfaces
 - Influence Analysis Overview and Options, 225
 - Influence Line & Surface Analysis, 223
 - Influence Loads, 135
- initial conditions, 137
- in-plane shear, 303
- instability, 271
- Intel PARDISO Direct Sparse Solver, 271
- IRC vehicles, 219
- Is Dynamic Mass option, 113
- isolators

- Isolator Property Definitions, 37
- Isolators, 89
- isotropic material properties, 19
- joint displacement
 - Joint Displacements, 277
 - Joint Velocities & Accelerations, 281
- joint displacement loads, 121
- joint loads
 - Joint Loads, 119
 - Support Displacements, 121
- joint reactions, 279
- joints, 59
- lanes, 105
- LAPACK Banded Storage Solver, 271
- large displacements, 173
- linear static analysis, 169
- live load analysis
 - Influence Line & Surface Analysis, 223
 - Linear Static Moving Load Analysis and Dynamic Rolling Stock Analysis, 217
 - Vehicle-Track-Structure Interaction Analysis, 239
- live loads
 - Influence Loads, 135
 - Moving Loads, 133
- load activity, 251
- load cases
 - Load Activities, 145
 - Static Load Cases, 113
 - Tendon Stressing and Slackening Activities, 151
- load classes, 265
- load combinations, 115
- loads, 111
- loads in Staged Construction Analysis
 - Load Activities, 145
 - Tendon Stressing and Slackening Activities, 151
- local coordinate system
 - Members, 61
 - Plates, 75
- locking translation, 93
- mass, 137
- mass elements, 91
- master joint, 93
- matched cast, 141
- materials, 19
- maximum absolute stress, 289
- member deflections, 291
- member deformation/displacements, 293
- member displacements, 297
- member forces
 - Member End Forces, 285
 - Member Sectional Forces, 287
 - Span Displacements and Span Sectional Forces, 297
- member loads
 - Analyzed Member Loads, 299
 - Member Loads, 123
 - Member Thermal Loads, 127
- member sectional stresses, 289
- member stresses, 289
- member thermal loads, 127

- member yield and strains, 295
- members
 - Members, 61
 - Spans, 73
- membrane force, 303
- modal frequencies, 333
- mode shapes
 - Eigenvalue and Stressed Eigenvalue Analysis, 181
 - Mode Shapes, 335
 - Response Spectra Analysis, 187
- modulus of elasticity, 19
- moment of inertia, 23
- moments
 - Joint Reactions, 279
 - Member End Forces, 285
 - Member Sectional Forces, 287
 - Plate Forces at Joints - External, 307
 - Plate Forces at Joints - Internal, 309
 - Plate Forces on Center, 303
 - Spring Forces, 319
- moving load analysis
 - Influence Line & Surface Analysis, 223
 - Lanes, 105
 - Linear Static Moving Load Analysis and Dynamic Rolling Stock Analysis, 217
 - Vehicle-Track-Structure Interaction Analysis, 239
- moving loads
 - Influence Loads, 135
 - Moving Loads, 133
- natural frequencies, 181
- Newmark-Beta, 211
- Newton-Raphson, 211
- nodes, 59
- nonlinear buckling analysis, 197
- nonlinear pushover analysis, 199
- nonlinear restart analysis, 201
- nonlinear springs
 - Spring Property Definitions, 29
 - Springs, 83
- nonlinear static analysis
 - Nonlinear Static Analysis, 173
 - Nonlinear Static Analysis Options, 177
 - Overview of Staged Construction Analysis, 249
 - P-Delta Analysis, 171
- nonlinear thermal gradient, 127
- nonlinear time history analysis
 - Nonlinear Time History Analysis, 211
 - Nonlinear Time-History Analysis Options, 213
- normal modes, 335
- normal stress, 289
- orientation angle, 61
- orthotropic material properties, 19
- P/A, 289
- PARDISO solver, 271
- partial loads, 123
- participating mass, 333
- pastic section modulus, 23
- p-delta analysis, 171
- perimeter, 23

- physical members, 73
- pin connection, 61
- plastic deformation, 293
- plate forces
 - Plate Forces at Joints - External, 307
 - Plate Forces at Joints - Internal, 309
 - Plate Forces on Center, 303
- plate loads, 129
- plate stresses, 313
- plates, 75
- point loads
 - Joint Loads, 119
 - Member Loads, 123
 - Plate Loads, 129
- Poisson ratio, 19
- post-tensioning
 - Tendon Results, 329
 - Tendons, 95
- prestress force, 61
- pre-tensioned tendons, 95
- primary moments, 329
- principal stress, 313
- pushover analysis
 - Nonlinear Pushover Analysis, 199
 - Nonlinear Pushover Analysis Options, 203
- reactions, 279
- rehabilitation, 249
- relaxation
 - Time Effects on Materials, 261
 - Time-Dependent Material Property Definitions, 53
- releases, 61
- removing elements in Staged Construction Analysis, 141
- residual strength, 23
- response spectra analysis, 187
- restraints
 - DOF Constraint Change Activities, 149
 - DOF Constraints, 93
 - Joints, 59
- rigid body motion, 271
- rigid zones, 61
- rolling stock analysis
 - Linear Static Moving Load Analysis and Dynamic Rolling Stock Analysis, 217
 - Vehicle-Track-Structure Interaction Analysis, 239
- rotation
 - Joint Displacements, 277
 - Joint Velocities & Accelerations, 281
 - Member Displacements, 291
 - Mode Shapes, 335
 - Span Displacements and Span Sectional Forces, 297
 - Spring Deformations, 321
- section properties and dimensions, 23
- segmental construction methods
 - Construct and Deconstruct Activities, 141
 - Support and Hoist Activities, 147
- seismic analysis, 187
- self-equilibrating stresses, 127
- self-weight, 117
- self-weight in Staged Construction Analysis

- Construct and Deconstruct Activities, 141
- Load Activities, 145
- Tendon Stressing and Slackening Activities, 151
- semi-rigid end connections, 61
- shear area, 23
- shear force
 - Member End Forces, 285
 - Member Sectional Forces, 287
 - Spring Forces, 319
- shear forces, 303
- shear modulus, 19
- shear stress, 289
- shells, 75
- shock loading, 187
- shrinkage
 - Sections, 23
 - Time Effects on Materials, 261
 - Time-Dependent Material Property Definitions, 53
- Skyline Solver, 271
- slave/masters, 93
- solution convergence, 177
- solvers, 271
- span displacements, 297
- span forces, 297
- spans, 73
- sparse solver, 271
- spherical coordinate systems, 39
- spring deformations, 321
- spring forces, 319
- spring properties, 29
- springs
 - Spring Property Definitions, 29
 - Springs, 83
- staged construction activities, 251
- staged construction analysis, 247
- Staged Construction Analysis
 - Analysis Scenarios, 161
 - Cast Concrete Activities, 155
 - Composite Section Construction Activities, 157
 - Construct and Deconstruct Activities, 141
 - Construction Activities, 139
 - Displacement Initializations, 153
 - DOF Constraint Change Activities, 149
 - Load Activities, 145
 - Support and Hoist Activities, 147
 - Tendon Stressing and Slackening Activities, 151
- stages, 251
- static analysis
 - Linear Static Analysis, 169
 - Nonlinear Static Analysis, 173
 - P-Delta Analysis, 171
- static loads, 113
- steel relaxation
 - Time Effects on Materials, 261
 - Time-Dependent Material Property Definitions, 53
- steps, 251
- stiffness degradation, 29
- stiffness matrix, 271

- strain, 295
- strand area, 95
- stress
 - Member Stresses, 289
 - Plate Stresses on Center and at Joints, 313
- stress direction, 313
- stress recovery points, 23
- stress stiffening, 173
- stress tendon activity, 251
- stress trajectory, 313
- stressed eigenvalue analysis, 181
- structure groups, 141
- support change activity
 - Load Class Tracking, 265
 - Staged Construction Activities, 251
- support changes, 147
- support displacements, 121
- support settlements, 121
- tendon GUTS, 19
- tendon relaxation, 19
- tendon results, 329
- tendon stressing activity, 251
- tendons
 - Tendon Results, 329
 - Tendons, 95
- tension
 - Member End Forces, 285
 - Member Sectional Forces, 287
- thermal expansion, 19
- thermal loads
 - Member Thermal Loads, 127
 - Plate Loads, 129
- time effect on elastic modulus, 261
- time history analysis
 - Linear Time History Analysis, 207
 - Linear Time History Analysis Options, 209
 - Nonlinear Time History Analysis, 211
 - Nonlinear Time-History Analysis Options, 213
 - Time History Loads, 137
 - Vehicle-Track-Structure Interaction Analysis, 239
- time-dependent material properties
 - Overview of Staged Construction Analysis, 249
 - Time Effects on Materials, 261
 - Time-Dependent Material Property Definitions, 53
- torsion
 - Plate Forces on Center, 303
 - Spring Forces, 319
- torsional constant, 23
- translation
 - Joint Displacements, 277
 - Joint Velocities & Accelerations, 281
 - Member Displacements, 291
 - Mode Shapes, 335
 - Span Displacements and Span Sectional Forces, 297
 - Spring Deformations, 321
- trapezoidal loads, 123
- trusses, 61
- ultimate stress, 19

- uniform base excitation, 137
- uniform loads, 123
- unit weight, 19
- unstable model, 271
- user coordinate systems
 - Bridge Paths, 47
 - User Coordinate Systems, 39
- Vectorized Direct Sparse Solver, 271
- vehicles
 - Lanes, 105
 - Standard Vehicles, 219
- vehicular loads
 - Influence Loads, 135
 - Linear Static Moving Load Analysis and Dynamic Rolling Stock Analysis, 217
 - Moving Loads, 133
 - Vehicle-Track-Structure Interaction Analysis, 239
- velocity, 281
- Von Misses stress, 313
- weight, 117
- wobble, 95
- yield ratio, 295
- yield stress, 19
- Young's modulus, 19