

STANFORD LINEAR ACCELERATOR CENTER

Fall 2001, Vol. 31, No. 3

# Beam Line

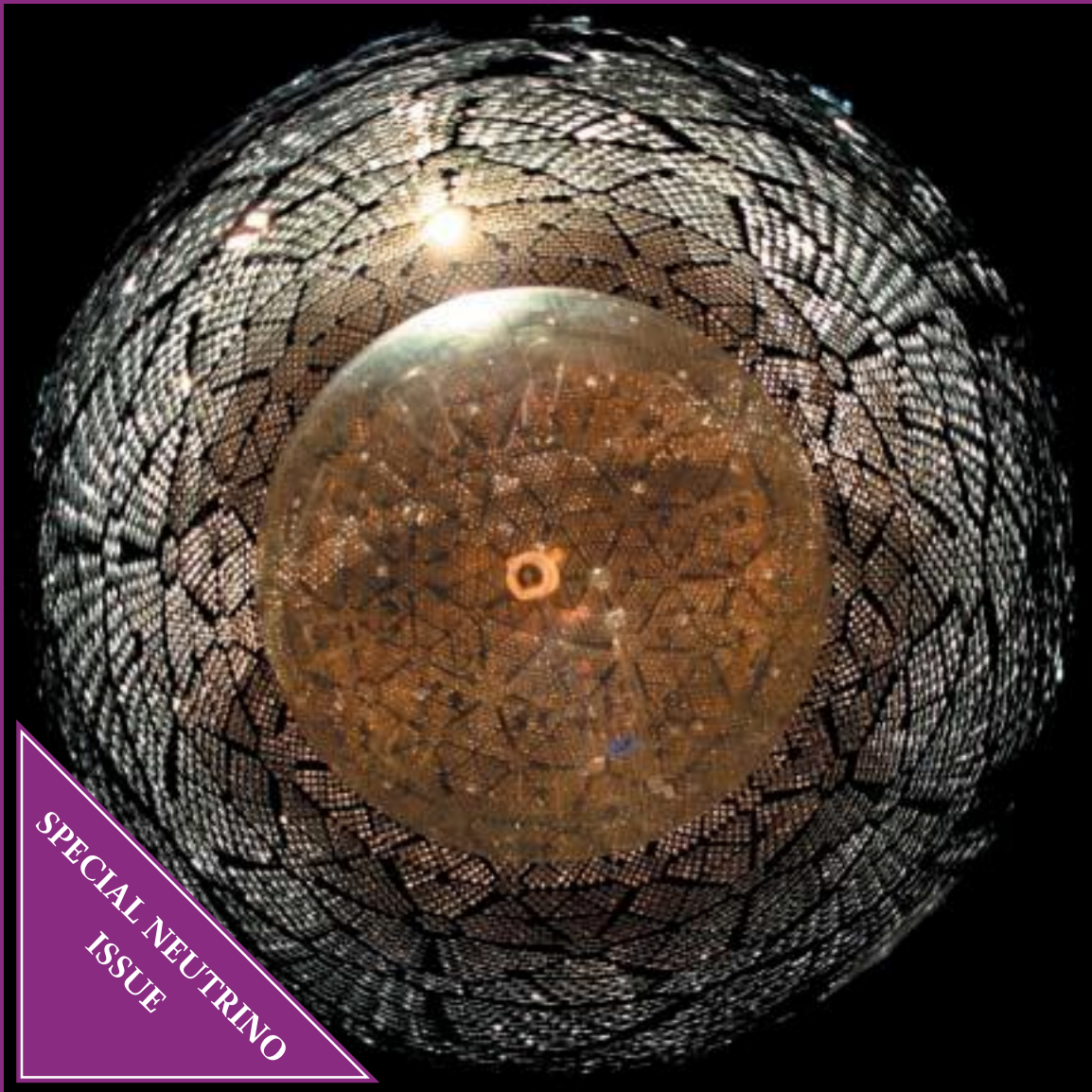

SPECIAL NEUTRINO  
ISSUE

# Beam Line

A PERIODICAL OF PARTICLE PHYSICS

FALL 2001

VOL. 31, NUMBER 3

## Guest Editor

MICHAEL RIORDAN

## Editors

RENE DONALDSON, BILL KIRK

## Contributing Editors

GORDON FRASER

JUDY JACKSON, AKIHIRO MAKI

MICHAEL RIORDAN, PEDRO WALOSCHEK

## Editorial Advisory Board

PATRICIA BURCHAT, DAVID BURKE

LANCE DIXON, EDWARD HARTOUNI

ABRAHAM SEIDEN, GEORGE SMOOT

HERMAN WINICK

## Illustrations

TERRY ANDERSON

## Distribution

CRYSTAL TILGHMAN

The *Beam Line* is published quarterly by the Stanford Linear Accelerator Center, Box 4349, Stanford, CA 94309. Telephone: (650) 926-2585. EMAIL: [beamline@slac.stanford.edu](mailto:beamline@slac.stanford.edu) FAX: (650) 926-4500

Issues of the *Beam Line* are accessible electronically on the World Wide Web at <http://www.slac.stanford.edu/pubs/beamline>. SLAC is operated by Stanford University under contract with the U.S. Department of Energy. The opinions of the authors do not necessarily reflect the policies of the Stanford Linear Accelerator Center.

*Cover: The Sudbury Neutrino Observatory detects neutrinos from the sun. This interior view from beneath the detector shows the acrylic vessel containing 1000 tons of heavy water, surrounded by photomultiplier tubes. (Courtesy SNO Collaboration)*

Printed on recycled paper



## CONTENTS

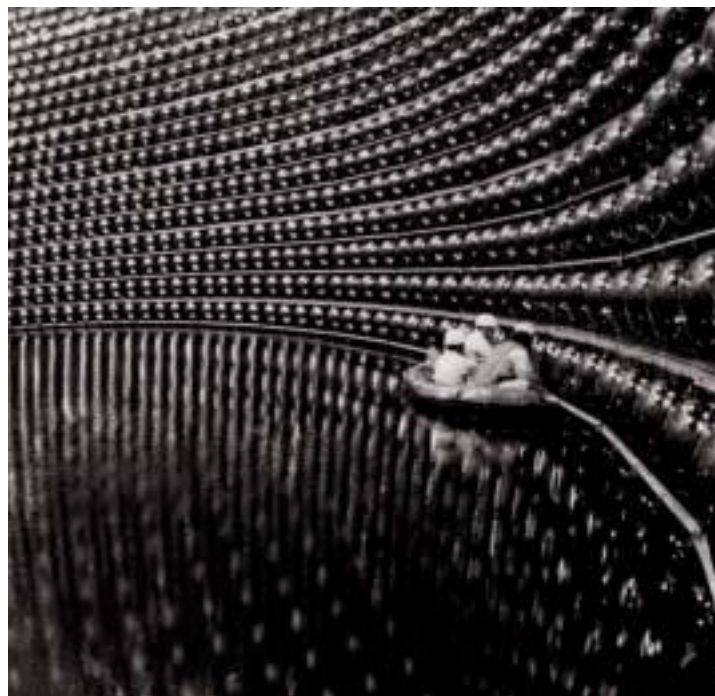

---

2 **FOREWORD**  
David O. Caldwell

## FEATURES

4 **PAULI'S GHOST**  
*A seventy-year saga of the conception and discovery of neutrinos.*  
Michael Riordan

15 **MINING SUNSHINE**  
*The first results from the Sudbury Neutrino Observatory reveal the "missing" solar neutrinos.*  
Joshua Klein

24 **NEUTRINO EXPERIMENTS AT FERMILAB**  
*Neutrino physics is thriving in the Nation's heartland.*  
Paul Nienaber

32 **THE ENIGMATIC WORLD OF NEUTRINOS**  
*Trying to discern the patterns of neutrino masses and mixing.*  
Boris Kayser

42 **THE K2K NEUTRINO EXPERIMENT**  
*The world's first long-baseline neutrino experiment is beginning to produce results.*  
Koichiro Nishikawa & Jeffrey Wilkes

50 **WHATEVER HAPPENED TO HOT DARK MATTER?**  
*Neutrinos may have had a significant impact on the structure of the Universe.*  
Joel R. Primack

58 **CONTRIBUTORS**

DATES TO REMEMBER





---

# FOREWORD

DAVID O. CALDWELL

---

## NEUTRINO TIMELINE

- 1930** Wolfgang Pauli predicts that neutrinos exist.
- 1956** Frederick Reines and Clyde Cowan discover the electron neutrino.
- 1961** Muon neutrinos are discovered at the Brookhaven National Laboratory.
- 1968** Ray Davis and colleagues begin the first solar neutrino experiment.
- 1989** Experiments at SLAC and CERN prove that there are only three kinds of light neutrinos.
- 1998** Super-Kamiokande experiment reports conclusive evidence for neutrino oscillations.
- 2000** DONUT experiment reports direct observation of tau neutrinos.
- 2001** SNO experiment finds evidence that solar neutrinos indeed oscillate.

**T**HE PAST FEW YEARS have been an exceptionally exciting time for physicists involved in research on neutrinos. We now have two different confirmed (and one unconfirmed) pieces of evidence that neutrinos oscillate from one type into another, which implies that they possess mass. These experiments have provided the first convincing experimental evidence for new physics beyond the Standard Model, today's dominant theory of elementary particles and the interactions among them. For two decades, ever since this theory took firm hold within the community during the late 1970s, particle physicists have been looking in every possible corner and under every accessible rock for this new physics. Now that we have such evidence, neutrino studies will lead the research into what lies beyond the Standard Model.

As a probe for new physics, neutrinos are unique among particles. As far as we know today, they are elementary particles, but unlike their fellow leptons and quarks, neutrinos are unencumbered by electrical charge and do not take part in the complicated strong interactions. They seem about as elementary as particles can be—possessing just the tiniest bits of mass and engaging only in weak interactions with other leptons and quarks. Neutrinos' exceptionally small mass may in fact provide a valuable window into the very high-energy scales that are otherwise completely inaccessible at today's particle accelerators. And despite the smallness of their mass, neutrinos may have played an important role in establishing the structure of the Universe during the years immediately after the Big Bang.

---

This special issue of the *Beam Line* appears at a pivotal moment in the evolution of the neutrino physics, when we take stock of the new advances and try to glimpse what discoveries may lie just over the horizon. A historical article by Michael Riordan helps familiarize readers with Wolfgang Pauli's 1930 conception of the neutrino and its evolution over seven decades of research. Joshua Klein, Paul Nienaber, Koichiro Nishikawa, and Jeffrey Wilkes bring us up to date on recent neutrino experiments as well as others planned for the near future. Theorists Boris Kayser and Joel Primack attempt to interpret the pattern of neutrino masses that seems to be emerging and assess what impact these ghostly particles might have had on the structure of the Universe.

Despite all the recent advances, there appears to be no end of questions about these elusive, fascinating particles and the effects that they may produce. This special *Beam Line* issue on neutrino physics, edited by Michael Riordan, captures the excitement of this field.

## UPDATE

AS THIS ISSUE was going to press, we learned about the extensive damage to most of the phototubes in the Super-Kamiokande experiment. This accident is not only devastating for that research group but also for all of physics. Super-Kamiokande has yielded so many insights about neutrinos and into physics beyond the Standard Model that the inevitable delays are a severe blow. We wish them as rapid a recovery as possible.

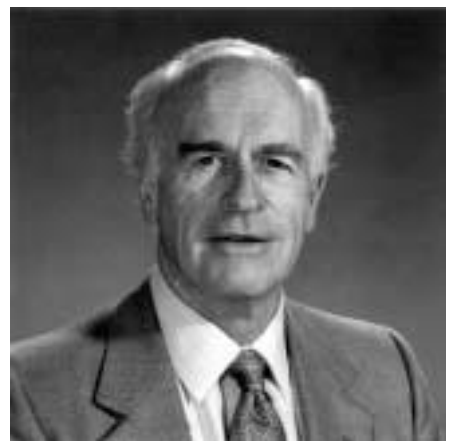

*David O. Caldwell has been doing research on neutrinos since 1980. He earned his Ph.D. in nuclear physics at UCLA in 1953 and since 1965 has been a member of the physics department faculty at the University of California, Santa Barbara. A Guggenheim Fellow and a Fellow of the American Physical Society, he is editor of the recently published book, Current Aspects of Neutrino Physics.*

# Pauli's Ghost

## A Seventy-Year Saga of the Conception

by MICHAEL RIORDAN

*The idea  
of the  
neutrino  
has evolved  
substantially  
over the  
seven decades  
of its  
existence.*

**W**HEN WOLFGANG PAULI conceived his idea of the neutrino in 1930, it was substantially different from the ghostly particles recognized today. That December he proposed this light, neutral, spin-1/2 particle as a “desperate remedy” for the energy crisis of that time: that electrons emitted in nuclear beta decay had a continuous, rather than discrete, energy spectrum. The crisis had grown so severe by the late 1920s that Niels Bohr began to contemplate abandoning the sacrosanct law of energy conservation in nuclear processes. Pauli could not countenance such radical unorthodoxy. Instead, he suggested that very light poltergeists might inhabit the nucleus along with protons and electrons. They should have a mass “of the same order of magnitude as the electron mass.” Normally bound within nuclei, they would have “about 10 times the penetrating capacity of a gamma ray” after their emission. He could account for continuous beta-decay spectra by assuming that this particle “is emitted together with the electron, in such a way that the sum of the energies . . . is constant.”

Pauli clearly thought of his ghosts as actual constituents of atomic nuclei, with a small mass and substantial interaction strength. He was trying not only to preserve energy conservation in nuclear processes but also to dodge the severe problems with spin and statistics that cropped up in nuclei—then imagined to consist only of protons and electrons. The nitrogen nucleus, for example, was widely pictured as having 14 protons and 7 electrons, but it did not seem to obey Fermi statistics, as expected of any object containing an odd number of fermions. By adding seven more fermions to the heap,

Adapted from “Pauli’s Ghost: The Conception and Discovery of Neutrinos,” by Michael Riordan, in *Current Aspects of Neutrino Physics*, D. O. Caldwell, Editor (Springer-Verlag Berlin, 2001).

# tion and Discovery of Neutrinos



*Wolfgang Pauli, left, Niels Bohr, center, Erwin Schrödinger, and Lise Meitner at the 1933 Solvay Congress (Courtesy Niels Bohr Archives).*

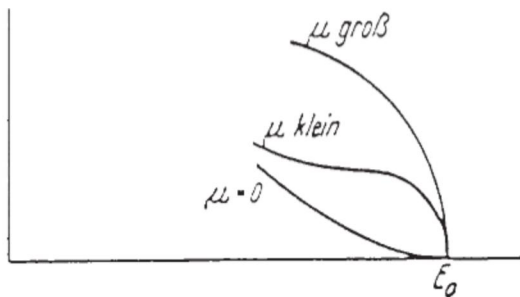

Graph from Fermi's paper on the theory of beta decay, showing how the shape of the emitted electron's energy spectrum varies with the possible mass of the neutrino.

Pauli could explain why it behaved like a boson. But nobody could figure out how to cloister such light, speedy particles within the narrow confines of a nucleus.

James Chadwick's 1932 discovery of a heavy fermion he dubbed the neutron resolved most of these problems. Composed of seven protons and seven almost equally massive neutrons, the nitrogen nucleus now had an even number of fermions inside and could easily behave like a boson. Enrico Fermi's famous theory of beta decay put the capstone on the growing edifice. Instead of inhabiting the nucleus as constituents, the electron and "neutrino" (a name coined by Fermi in 1931 to mean "little neutral object") were to be created the moment a neutron transformed into a proton. Fermi even went so far as to indicate how the energy spectrum of beta-decay electrons depends critically on the neutrino's mass. By comparing his theoretical curves with the measured spectra near their high-energy endpoint, he concluded that "the rest mass of the neutrino is either zero, or, in any case, very small in comparison to the mass of the electron."

Shortly thereafter, Hans Bethe and Rudolf Peierls used Fermi's theory to show that the interaction of neutrinos with matter had to be essentially negligible. In the energy range characteristic of beta-decay neutrinos, they would have a mean free path in water of more than 1000 light years! Bethe and Peierls concluded "there is no practically possible way of observing the neutrino." Pauli himself was dismayed. "I have done a terrible thing," he said. "I have postulated a particle that cannot be detected."

Thus was the idea of the neutrino born, but it remained mostly an intriguing possibility for years. Even after reading Fermi's paper, Bohr was still not convinced of its reality. "In an ordinary way I might say that I do not believe in neutrinos," Sir Arthur Eddington remarked, "Dare I say that experimental physicists will not have sufficient ingenuity to make neutrinos?"

**W**HEN George Gamow wrote "The Reality of Neutrinos" in 1948, however, he could discourse about them with confidence that they indeed existed. Although nobody had yet detected one directly, there were several indirect experimental proofs of their reality. Sensitive measurements of the energy and momentum of beta-decay electrons and their recoiling nuclei in Wilson cloud chambers indicated that substantial quantities of energy and momentum were missing. "This means some other particle must have been ejected at the same time as the electron," he wrote. "These single-process experiments leave little doubt that a third particle must be involved."

Gamow even speculated that neutrinos might be involved in the lethargic disintegration of the recently discovered pi-mesons and their lighter counterparts, then known as mu-mesons. After all, some kind of invisible entity was spiting energy away from these two-body and three-body decay processes. Why not the same elusive particle involved in beta decays?

But little could be said conclusively about a particle that had thus far evaded direct detection. Whether



its antiparticle was a completely distinct entity or just a different spin state of the same poltergeist could not then be determined. And the best attempts at measuring its mass could only establish an upper limit of about one-twentieth the electron mass. As the 1950s began, however, this situation was about to change dramatically.

In 1951, following atomic-bomb testing at Eniwetok atoll, Los Alamos physicist Frederick Reines began contemplating experiments in fundamental physics he might attempt. The Manhattan Project had provided intense new sources of neutrinos that could be used to ascertain more about them. Reines and Clyde Cowan recognized that the recently developed organic scintillating liquids would allow them to build the massive detector required to observe such ghostly particles. Together with the intense neutrino fluxes generated by atomic blasts or close to a fission reactor, such a large detector might finally overcome the dauntingly miniscule probability of a neutrino interacting.

Reines and Cowan elected to search for evidence of the interaction

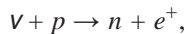

which should yield a prompt light flash in the organic scintillator due to the positron's annihilation with an atomic electron, followed a few microseconds later by another flash due to neutron capture. (Savvy readers will protest that antineutrinos, not neutrinos, participate in such an "inverse beta-decay" interaction, but this distinction was not clear at the time.) After considering and rejecting

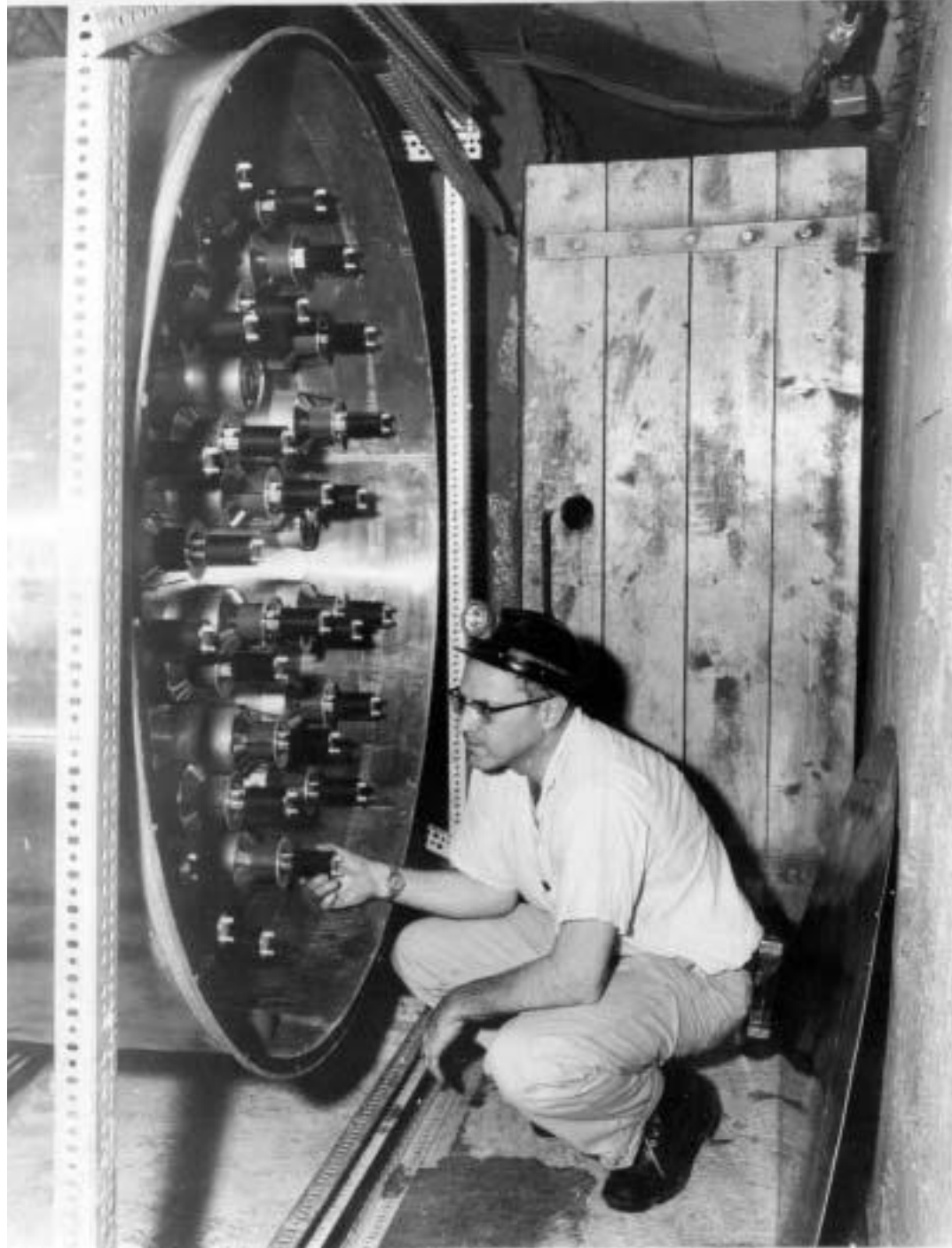

the idea of placing a detector within 100 meters of an atomic-bomb explosion, they decided instead to put it close to one of the nuclear reactors then in operation. Their first experiment, placed near one of the Hanford Engineering Works reactors used to breed plutonium for the Manhattan Project, involved a 300-liter tank of liquid scintillator. But the marginal increase in signal they observed with the reactor in operation was

*Frederick Reines at work on an underground experiment in a South African mine in 1966. (Courtesy University of California, Irvine)*

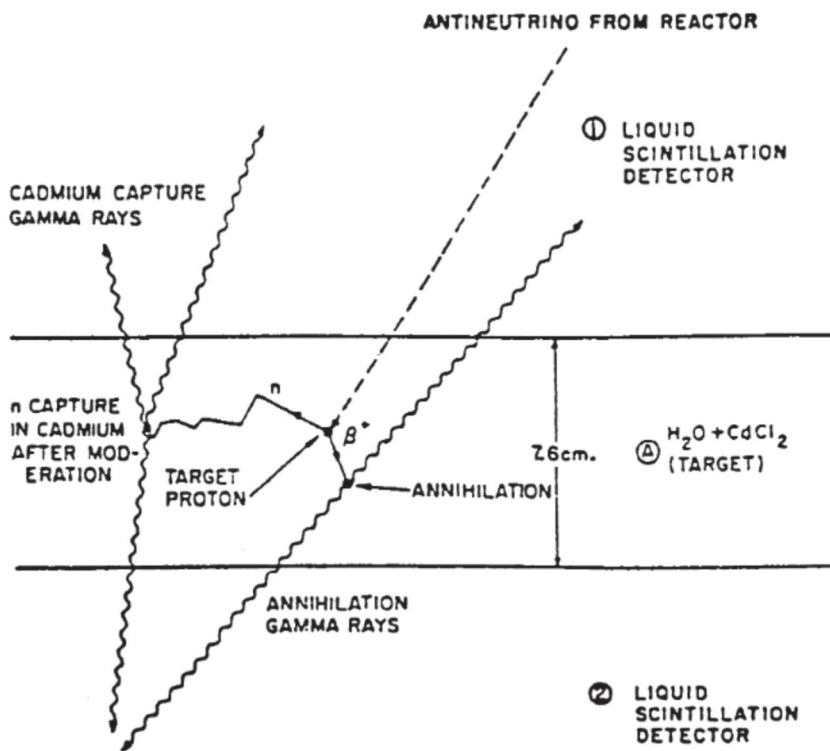

Diagram of the antineutrino-detection scheme used in the Savannah River experiment.

nearly swamped by cosmic-ray backgrounds.

Reines and Cowan then did a second experiment at the Savannah River reactor, which could generate a flux of 10 trillion antineutrinos per square centimeter per second at a position 11 meters away. (By then it was becoming recognized that the neutrino and antineutrino are distinct particles, with the latter being produced in tandem with an electron in beta-decay.) The detector, positioned 12 meters underground to reject cosmic-ray backgrounds, consisted of three tanks of organic scintillator, each viewed by 110 phototubes; between them sat two tanks of water with dissolved cadmium chloride to promote neutron capture (see illustration on next page).

An antineutrino from the reactor occasionally interacted with a proton in the water, producing a positron and a neutron. The positron annihilated almost immediately with an atomic electron, yielding two gamma rays that were detected in the scintillator; about 10 microseconds later, neutron capture by a cadmium nucleus resulted in another burst of

gamma rays (see illustration at left). A delayed coincidence between the first and second gamma-ray bursts was taken as the signature of an antineutrino event; Reines and Cowan observed three events per hour with the reactor operating—much greater than backgrounds due to cosmic rays or accidental coincidences.

Elated by their discovery, Reines and Cowan sent Pauli a telegram on June 14, 1956: “We are happy to inform you that we have definitely detected neutrinos from fission fragments by observing inverse beta-decay of protons.” According to Reines, Pauli drank a whole case of champagne with his friends to celebrate the discovery and drunkenly penned a reply. “Thanks for the message,” he wrote; “Everything comes to him who knows how to wait.”

**R**EVIEWING the status of neutrino physics a year later, Reines and Cowan could cite a variety of major improvements in the understanding of this previously invisible poltergeist. Delicate measurements of the electron spectrum in tritium beta decays had established that the neutrino’s mass was less than 1/2000th that of the electron. The lack of evidence for double beta-decay (in which two electrons are emitted) indicated that it was most probably a Dirac particle like the electron, with neutrino and antineutrino distinctly different entities. And the failure of Brookhaven scientist Ray Davis to find any  $\text{Cl}^{37} \rightarrow \text{Ar}^{37}$  conversions in a tank containing a thousand gallons of carbon tetrachloride placed near the Savannah River reactor could also be

explained in the same way: antineutrinos could not induce such transitions, while neutrinos should have.

The most striking advance in understanding neutrinos had come the previous year in the wake of the earthshaking discovery of parity violation. Tsung-Dao Lee and Chen-Ning Yang (among others) proposed to rescue the deteriorating situation by invoking a peculiarity of neutrinos. If they were indeed Dirac particles with absolutely no mass, neutrinos themselves would violate parity because their spin vectors would always be aligned along their direction of motion, while the spins of antineutrinos would only point the opposite way. We say neutrinos are “left-handed” and antineutrinos “right-handed.” “Since this new model for the neutrino does not obey the simple parity principle, no reaction involving such a neutrino can be expected to conserve parity,” wrote Reines and Cowan.

A further consequence of this hypothesis was that the probability of reactor-produced antineutrinos interacting with protons had to be twice as large—an effect that Reines and Cowan had already begun to observe. But the most convincing proof came from a sensitive experiment at Brookhaven led by Maurice Goldhaber. He determined the spin direction of the recoiling nucleus that emerged after a europium-152 nucleus had captured one of its atomic electrons and emitted a neutrino. From this he concluded that the neutrino is always left-handed, just as Lee and Yang had suggested. Thus the neutrino and antineutrino appeared to be distinctly different, massless entities.

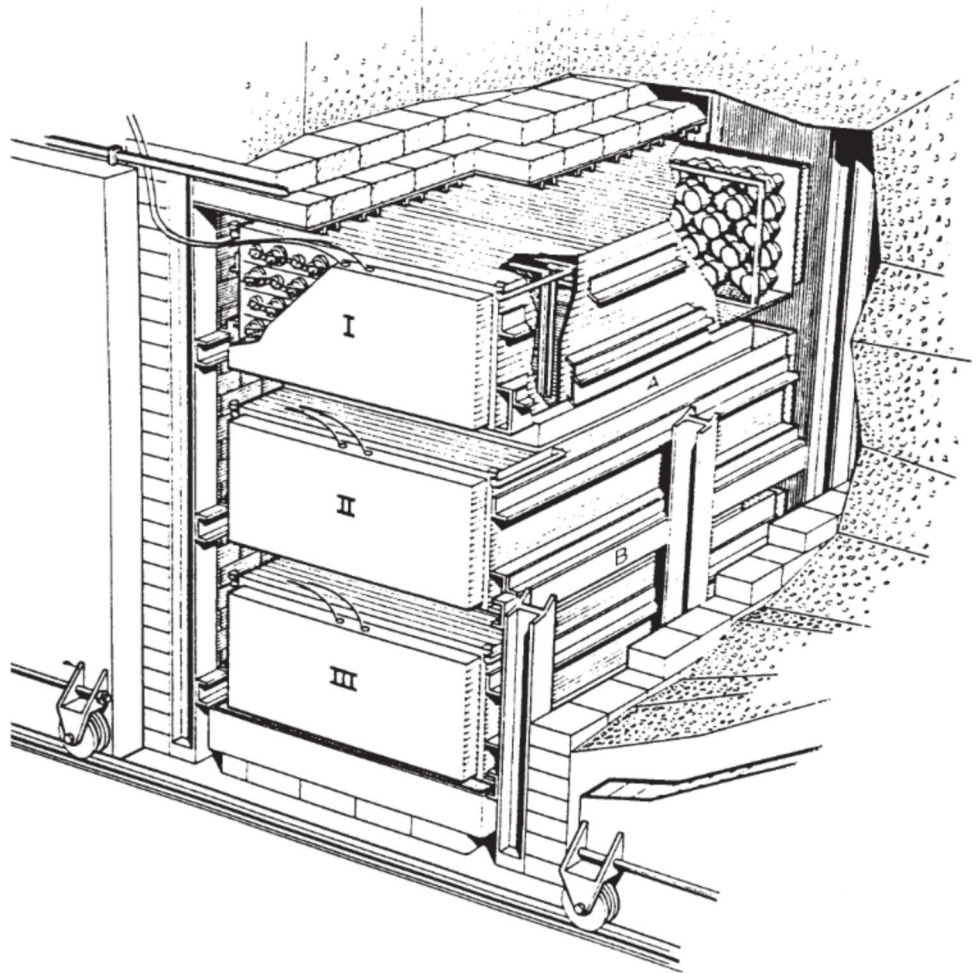

**A MAJOR MYSTERY** in the late 1950s was whether the neutral particles emitted in pion and muon decays were the same neutrino and antineutrino as observed in nuclear decays—or something else. Because the strengths of these interactions were similar, and because they also violated parity, it was widely assumed that the very same particles were involved. But if this were the case, then muons should occasionally have been seen decaying into an electron and a photon ( $\mu \rightarrow e + \gamma$ ). If so, the neutrino and antineutrino generated in three-body decays of muons could occasionally annihilate each other, yielding a photon in addition to the departing electron. Theorists calculated that such processes should occur about once in every 10,000 muon decays, but accurate measurements indicated that nothing like this occurred in many millions

*Artist's conception of the detector used by Reines and Cowan in their Savannah River experiment. Tanks I, II, and III contained liquid scintillator viewed on each end by 55 phototubes. Tanks A and B, containing 200 liters of water with dissolved cadmium chloride for neutron capture, served as the target volume.*



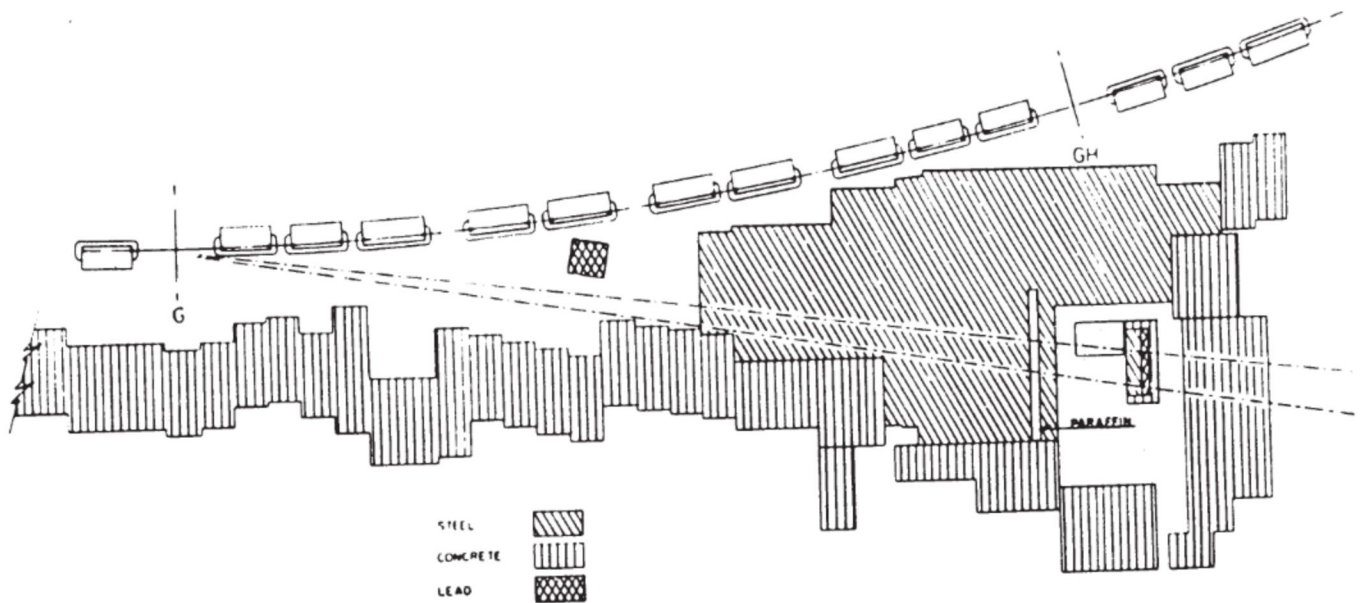

*Plan view of the two-neutrino experiment at Brookhaven National Laboratory. Pions and kaons produced by protons hitting a beryllium target at far left decayed, yielding neutrinos (and anti-neutrinos) that traveled from left to right, penetrating the massive steel shielding and striking the detector at the far right.*

of events. One way to accommodate this apparent discrepancy was to say that two different kinds of neutrinos were involved in muon decay.

Intrigued by these questions and the possibility of resolving them by making neutrino beams, Melvin Schwartz, Leon Lederman, Jack Steinberger and their colleagues began planning an experiment at Brookhaven. Spurred by his discussions with T. D. Lee, Schwartz recognized that intense, high energy beams of protons soon to be available from its Alternating Gradient Synchrotron would allow them to generate neutrino beams with sufficient intensity (see illustration above).

With energies ranging up to several billion electron volts, these neutrinos had interaction probabilities more than a hundred times greater than reactor-born neutrinos, but a large, massive detector was still required to observe a sufficient number of them. Schwartz and his colleagues elected to build a 10 ton spark

chamber from aluminum plates. If neutrinos produced in pion or kaon decays (e.g.,  $\pi \rightarrow \mu + \nu$ ) were distinct from those in beta-decays, they expected to see only the long, penetrating tracks of muons generated by neutrinos that interacted in the aluminum. However, Schwartz recalled, "If there had been only one kind of neutrino, there should have been as many electron-type as muon-type events."

In the initial run of this experiment, which began in late 1961, they recorded 34 events in which there appeared a single muon track originating in the aluminum plates. There were another 22 events having a muon and other particles, plus six ambiguous events that might have been interpreted as electrons. But comparisons with actual electron events from a separate run showed little similarity.

Thus the neutrinos produced in tandem with muons in pion and kaon decay are distinct from those



produced together with electrons in nuclear beta decay. After Schwartz's pivotal experiment, particle physicists began calling the former "muon neutrinos" (or  $\nu_\mu$ ) to distinguish these particles from the latter, known as "electron neutrinos" (or  $\nu_e$ ). Whenever a positive muon decays, for example, it yields a positron, an electron neutrino and a muon anti-neutrino ( $\mu^+ \rightarrow e^+ + \nu_e + \bar{\nu}_\mu$ ). By 1962 physicists recognized four distinct "leptons," or light particles: the electron, the muon, and their two respective neutrinos (plus antiparticles).

**T**HEORETICAL and experimental advances over the ensuing decade resulted in a revolutionary new picture of the subatomic realm that came to be known as the Standard Model of particle physics. In this theory, leptons and other particles called "quarks" are regarded as elementary, point-like entities. The electromagnetic and weak interactions, previously thought of as distinct forces with vastly differing strengths, are now considered to be just two different aspects of one and the same "electroweak" interaction. The extreme feebleness of the weak interaction arises because it occurs via the exchange of ponderous spin-1 particles known as "gauge bosons," which are difficult to conjure up out of sheer nothingness. In beta decay, for example, a neutron coughs up a massive, negatively charged  $W$  boson and transforms into a proton ( $n \rightarrow p + W^-$ ); the  $W^-$  immediately converts into an electron plus its antineutrino ( $W^- \rightarrow e^- + \bar{\nu}_e$ ). Only the left-handed electrons and neutrinos (and their right-handed antiparticles) participate in these weak



interactions, thereby yielding their characteristic parity-violating property.

An inescapable requirement of this unification of the electromagnetic and weak interactions is the existence of "neutral currents" that occur due to exchange of another massive, but neutral, boson  $Z$ . Instead of converting into a muon when it interacts with a nucleus via the exchange of a  $W$  boson, for example, a muon neutrino can instead glance away unaltered, remaining a muon neutrino.

After years of searching, neutral currents were discovered in 1973 by an international collaboration of physicists working at the European Center for Nuclear Research (CERN) on the Gargamelle bubble chamber. Filled with liquid freon, it was exposed to beams of muon neutrinos and antineutrinos from CERN's proton synchrotron. The initial evidence came from a few rare events in which these spookinos rebounded elastically from atomic electrons (for example,  $\nu_\mu + e^- \rightarrow \nu_\mu + e^-$ ), and imparted energy to them. These

*One of the first neutral current events observed in the Gargamelle bubble chamber at CERN. A muon neutrino traveling invisibly from left to right strikes an atomic electron, which makes the gently arcing track in this photograph. (Courtesy CERN)*

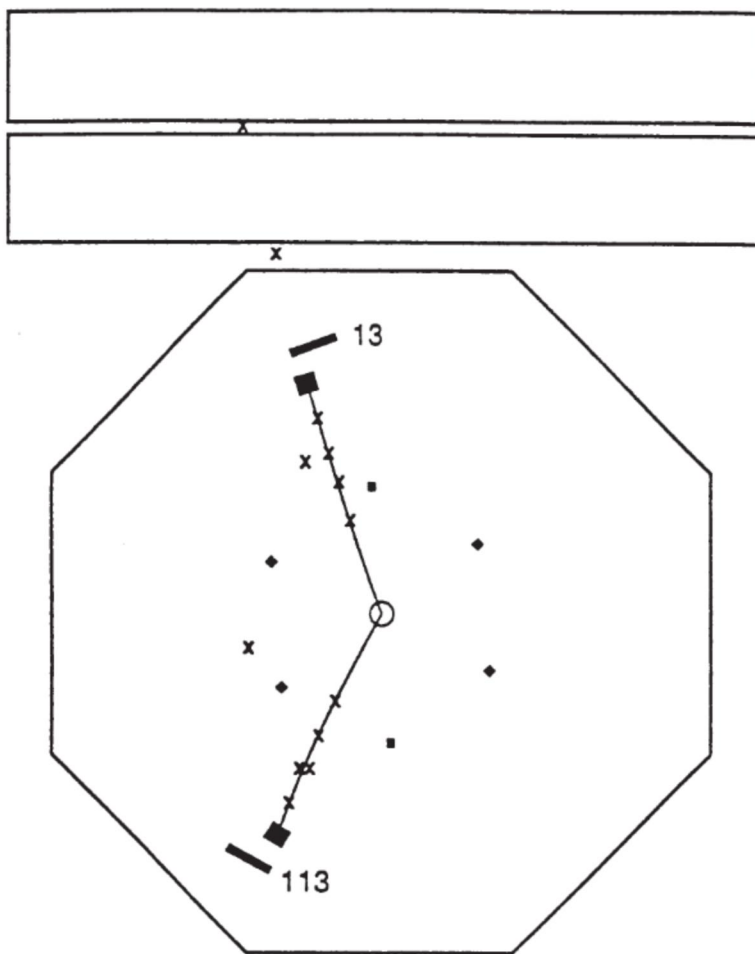

One of the first anomalous  $e\mu$  events observed after a “muon tower” had been added in 1975 to the SLAC-LBL detector at the SPEAR collider. The muon travels upwards through the tower in this computer reconstruction of the detector’s cross section, while the electron moves downward.

electrons left wispy tracks in the chamber, whereas the neutrinos or antineutrinos crept away undetected. Subsequent confirmation came from Gargamelle and two experiments at Fermilab in which muon neutrinos scattered inelastically from nuclei.

By the mid-1970s, it was clear that neutrinos (and, in fact, all the other leptons and quarks) were capable of a new kind of weak interaction in which they maintained their identity instead of transforming into a partner lepton (or quark). The discovery of these neutral currents, together with conclusive evidence for a fourth, or charm, quark  $c$  to accompany the initial trio—up  $u$ , down  $d$ , and strange  $s$ —provided strong support for the Standard Model. Quarks and leptons come in pairs:  $u$  and  $d$ ,  $e$  and  $\nu_e$ ;  $c$  and  $s$ ,  $\mu$  and  $\nu_\mu$ . What’s more, quark and lepton pairs can be grouped into families of four, often called “generations.” Two such

families were recognized by 1976: the first includes the up and down quarks plus the electron and electron neutrino, while the second contains the charm and strange quarks plus the muon and muon neutrino. Particle physicists could now discern a highly satisfying symmetry among the elementary entities in their new ontology.

**T**HREE YEARS earlier, two Japanese theorists had suggested that a third family of quarks and leptons might exist. Makoto Kobayashi and Toshihide Maskawa were seeking a way to incorporate the mysterious phenomenon of CP violation within the emerging structure of what was soon recognized as the Standard Model. Discovered in 1964 by James Cronin, Valentine Fitch, and their colleagues, this phenomenon indicated that—at least in certain decays of kaons—Nature is asymmetric under the combined operations of charge conjugation ( $C$ ) and parity inversion ( $P$ ). They observed that kaons behave differently, that is, if one replaces particles by antiparticles and views their interactions in a mirror. Kobayashi and Maskawa could not obtain this CP violation using only the two known families of quarks and leptons. But if they added a third family to the mix, including two more quarks plus another charged lepton and its neutrino, they discovered that it arose naturally.

At about the same time, Martin Perl and his colleagues were beginning their search for another heavy, charged lepton using the SLAC-LBL detector at the new electron-positron collider SPEAR. If such a heavy lepton

*Particle physicists*

*could now discern*

*a highly satisfying*

*symmetry among*

*the elementary*

*entities in their*

*new ontology.*

$\lambda$  existed, he reasoned, pairs of them should be produced in high-energy electron-positron collisions:

$$e^+ + e^- \rightarrow \lambda^+ + \lambda^-.$$

Depending on their mass, such leptons could have a variety of decays, two of which would be similar (by analogy) to the muon's. By searching for events in which one of these hypothetical motes decayed into an electron and the other into an oppositely-charged muon (plus unseen neutrinos and antineutrinos), they hoped to find evidence for the existence of a new heavy lepton—and (again by analogy) a third neutrino.

By 1974 Perl's group began to find such "anomalous  $e\mu$  events" in the data samples being collected on the SLAC-LBL detector, and by 1975 they had dozens (see diagram on the left). But convincing their colleagues that these events were conclusive evidence for a heavy lepton took longer. In 1977, confirmation of the SLAC results began to come in from the DORIS electron-positron collider in Hamburg. Further experiments on SPEAR and DORIS showed the mass of this tau lepton  $\tau$  to be around 1.78 GeV and identified its decay into a pion and tau neutrino ( $\tau^- \rightarrow \pi^- + \nu_\tau$ ). By the following summer, there was little doubt among particle physicists regarding the existence of the tau lepton.

**S**TILL, IT TOOK physicists over two more decades to achieve the direct detection of a free tau neutrino, well separated from its point of production. The problem occurred due to the

difficulties of making a sufficiently intense beam of tau neutrinos and detecting them unambiguously. Meanwhile, the two quarks expected in the third family—the bottom  $b$  and top  $t$  quarks—were isolated at Cornell and Fermilab, leaving only the elusive tau neutrino remaining to be discovered. So dominant had the Standard Model become that few particle physicists seriously questioned its existence.

Cosmological arguments about nucleosynthesis of light elements during the first few minutes of the Big Bang required that a third neutrino—and perhaps even a fourth—ought to exist. The abundance of primordial helium-4 synthesized during this process is determined by the expansion rate of the Universe at that time, which is sensitively related to the number of different kinds of light neutrinos. As measurements became more accurate during the 1980s, primordial helium-4 was observed to contribute about a quarter of the visible mass in the Universe, suggesting a third (and a remotely possible fourth) kind of neutrino.

The issue was settled in 1989 by terrestrial experiments at new electron-positron colliders—the SLC at SLAC and LEP at CERN—that were capable of producing hordes of  $Z$  bosons. Within the structure of the Standard Model, additional kinds of neutrinos give this particle additional pathways to decay, thereby shortening its lifetime. By making precision measurements of the  $Z$  resonance peak, physicists at the two facilities concluded that there are three, and *only* three, kinds of "conventional" light, weakly interacting neutrinos. Confirming the cosmological predictions, these experiments put a firm lid on the complexity of the Universe. Its table of fundamental entities could have only three families of quarks and leptons (see illustration below).

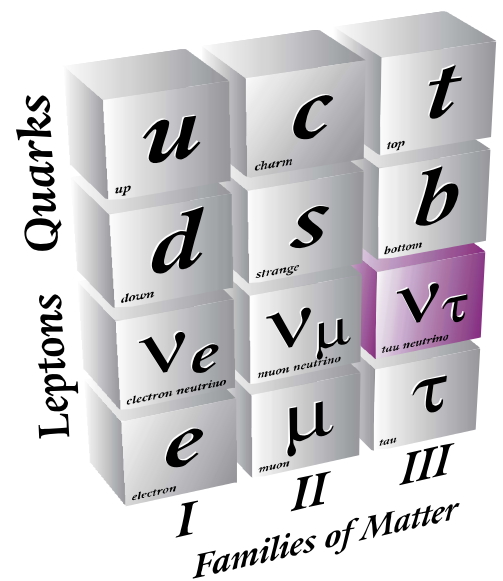

*The quarks and leptons in the Standard Model. There are three, and only three, families of quarks and leptons. The last to be isolated, by the DONUT experiment at Fermilab, was the tau neutrino,  $\nu_\tau$ .*

Direct experimental evidence for the tau neutrino came finally in 2000, seventy years after Pauli conceived his novel idea. By examining millions of particle tracks left on special three-dimensional photographic film, physicists working on the DONUT experiment at Fermilab found four events that could only be interpreted as a tau neutrino colliding with a nucleus and producing a tau lepton. (For further details, see the article by Paul Nienaber, this issue.) The third and final neutrino had finally left subtle, indirect footprints that confirmed its long-anticipated existence.

**T**HE IDEA of the neutrino has therefore evolved substantially since its conception in the early 1930s. Pauli's tenuous hypothesis was just the starting point for a lengthy process of theoretical and experimental elaboration that continues today. Where he at first regarded neutrinos as nuclear constituents, Fermi showed how they can instead be created in nuclear transformations. Where Pauli sought a minimal way to preserve the conservation of energy and angular momentum in individual beta decays, physicists have recently established that at least two—and most likely all three—of the neutrinos have a tiny bit of mass. And where he speculated that this mass might well be greater than an electron's, physicists now think it must be at least a million times smaller.

But despite the great transformations that have occurred in the idea of the neutrino since 1930, Pauli deserves due credit for being the one daring enough to take the great conceptual leap of introducing

another fundamental entity into the minimalist ontology of his day. No doubt the enduring success of his bold scheme has encouraged theorists of later decades to repeat this exercise whenever a cherished symmetry or conservation law appears to be violated. In this subtle way, the ghost of Wolfgang Pauli still haunts the way particle physics is practiced today.



### For Further Information

Good summaries of the history of neutrinos can be found at:

<http://www.lapp.in2p3.fr/neutrinos/aneut.html>

<http://www.ps.uci.edu/~superk/neutrino.html>

On Wolfgang Pauli, see:

<http://www.physicstoday.com/pt/vol-54/iss-2/p43.html>

<http://www-groups.dcs.st-andrews.ac.uk/~history/Mathematicians/Pauli.html>



# MINING SUNSHINE

by JOSHUA KLEIN

*The first  
results  
from the  
Sudbury  
Neutrino  
Observatory  
reveal the  
“missing”  
solar neutrinos.*

**T**HE COMMUTE is only four kilometers, but it can take an hour each way. The problem is neither traffic nor mass-transit delays, but the fact that the trip takes you 6800 feet below the surface of the Earth. Much of the time is taken up by the required safety rituals: donning the reflective coveralls and hardhat, lacing up the steel-toed work boots, buckling the headlamp battery into the safety belt and placing your name tag on the peg board.

The schedule of a busy mine is driven by the need to move equipment—not people—from level to level. You wait by the mine shaft until the “on-shift boss” decides it is convenient to bring you down and calls for your levels: “Sixty-two to seven-thousand!—going down.” Both miners and physicists then climb into an open steel box (the “cage”), which is suspended by a cable as thick as a man’s leg. The cage comfortably fits twenty people; it usually holds closer to sixty. On a good day, you can place both feet on the floor.

While the drop downward starts slowly, it eventually reaches a top speed of about 2200 feet/minute. Headlamps provide the only light, and you can just make out the rock wall of the shaft as it rushes upward past your face. Occasionally the darkness is broken by a brief glimpse of one of the shallower mining levels blinking by so fast that you barely register an image of a lighted tunnel receding away. By the 4000-foot level, your ears start to feel the additional pressure, and even the most seasoned miners snort and work their jaws trying to adjust.



*The SNO detector just before completion of the bottom of the acrylic vessel. The acrylic used for this vessel is over 2.5 inches thick and built to hold 1000 tons of heavy water.*

If they don't stop to let off miners on one of the shallower levels, the trip down to the 6800-foot level takes less than four minutes. As you step off the cage, a sign long-ago covered in grime declares that this is "The Home of the Sudbury Neutrino Observatory." To the miners, it is just another level rich with nickel.

The commute is not yet over, however, as there is still over a mile's worth of hiking left at this level. The dark and the dust and the mud are typical of any of the mine's other tunnels (called "drifts"), as is the fact that the rock above your head—nearly a mile and a half of it—is kept from collapsing only by a brute-force combination of bolts 30-feet long, steel screening, and concrete. Without that support, the pressures at this

depth are so great that the rock would quickly crumble.

A stiff breeze blows at your back, ventilation that keeps the air throughout most of the mine near 70°F all year round—much cooler than the natural 100°F of the rock. In some pockets where the ventilation doesn't reach, the air is as hot and humid as a summer day in Philadelphia.

The (quite literal) light at the end of this tunnel shines on two plain-looking blue doorways—one for people and one for railcars. The accumulated dirt and mud on your boots must be washed off before you enter, and once inside, the contrast with the conditions in the drift could not be more striking: bright lights, dust-free air, spotless floors, and white painted walls suddenly make it hard to remember that you're at the bottom of one of the world's deepest mines. To go further inside, you need to clean off even more: the boots, hardhat, and coveralls come off, and everyone must shower and change into clean clothes and a hairnet.

Computers, fax machines, coffee makers, telephones—they make it almost impossible to convince yourself that there is a mile and a half of rock above your head! And there is more: a water purification plant, a control room where shift operators monitor and alter the way data are taken, and a darkened, domed area with rack upon rack of flickering data-acquisition electronics. Only the fact that there are no windows—no way to see the Sun from a mile and a half underground—reminds you of where you are. Which is perhaps ironic, given that the principal purpose of the Sudbury Neutrino

Observatory (SNO) is to study sunshine—not the sunshine visible to the human eye, but sunshine made of neutrinos, which travel to the bottom of the mine more easily than sunlight through a pane of glass.

### THE SOLAR NEUTRINO PROBLEM

The sunshine that flows through windows—and down to the bottom of mines—is born in a tremendous nuclear reactor that rests at the center of the Sun. Sir Arthur Eddington first suggested that the energy stored in atomic nuclei provides the Sun’s power, pointing out in 1920 that this source was “well-nigh inexhaustible” and “sufficient . . . to maintain [an] output of heat for 15 billion years.” (See John Bahcall’s article in the Winter 2001 *Beam Line*, Vol. 31, No. 1.) But proving that the Sun is tapping nuclei for energy is not easy—it requires the detection of some specific signature other than the light and heat that we see and feel (most of which is coming directly from the boiling surface of the Sun, not its center). Fortunately for us, the neutrino is a common by-product of nuclear reactions, and therefore observation of solar neutrinos on Earth can prove Eddington’s hypothesis.

It was not until 1967, however, that Brookhaven National Laboratory scientist Ray Davis and his co-workers constructed the first detector to look for neutrinos coming from the Sun. Davis’s experiment was not only expected to be a triumphant confirmation of the theory but also to usher in a new era of solar physics in which neutrinos would be used to

probe the details of the solar core. Yet, while Davis did prove that the Sun emits neutrinos, his measurements also produced a surprise: compared to the detailed calculations made by John Bahcall and others, he detected far fewer neutrinos than expected. The five experiments that came after his also saw similar deficits. The mystery of these “missing” neutrinos is known as the solar neutrino problem, the oldest puzzle in experimental particle physics.

Essentially there are three possible ways in which neutrinos from the Sun might seem to be missing. First, the measurements may simply be incorrect: the neutrinos are present, but we have undercounted them. But the different detectors and approaches used by the various solar neutrino experiments make a common error between them very unlikely. Second, the theory of the Sun may be wrong in some way; perhaps the Sun’s interior properties are different from what is expected, and fewer neutrinos are being created. The theory of the Sun correctly predicts other solar characteristics, such as the way in which the Sun’s surface vibrates in response to seismic activity, and it is therefore unlikely that we would grossly miscalculate the number of neutrinos. We are left with a third possibility: that the problem is not due to our measurement of neutrinos or our understanding of the Sun, but to something about the neutrino itself.

Davis’s experiment therefore provided much more than a new way to study the Sun: it raised questions about a part of fundamental particle physics we thought we already understood. Our best theory of

*Ray Davis, circa 1966. The photograph was taken in the Homestake gold mine in South Dakota shortly before the first solar neutrino experiment began operation. (Courtesy John Bahcall)*





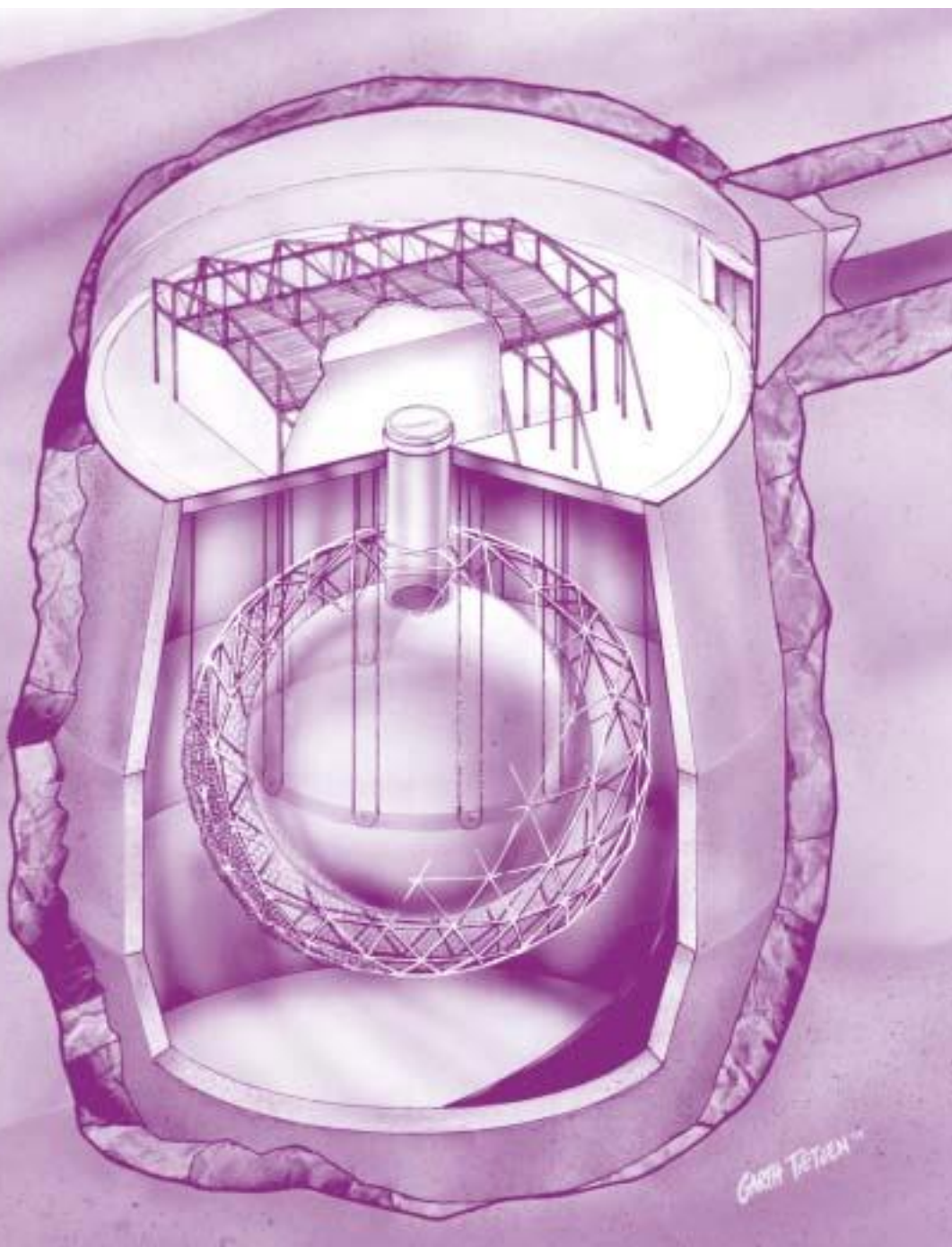

*Cut-away view of the SNO detector, showing the acrylic vessel containing 1000 tons of heavy water at its core.*

elementary particles, the Standard Model, holds that there are three different types (or flavors) of neutrinos—electron neutrinos (written  $\nu_e$ ), muon neutrinos ( $\nu_\mu$ ), and tau neutrinos ( $\nu_\tau$ ) each closely associated with the corresponding charged particle. The Sun can produce only electron neutrinos, and therefore the six solar-neutrino experiments prior to SNO have searched primarily for this one flavor. But if the Standard Model is wrong, and the three flavors of neutrinos are not completely distinct but can change from one type into another, we may have an explanation for the solar neutrino problem. If the electron neutrinos born in the center of the Sun change into one of the other types on their way to Earth, then the earlier experiments will have recorded fewer neutrinos than expected; the changelings would sail right through the detectors without being noticed.

The changing of neutrinos back and forth from one flavor to another is usually referred to as neutrino oscillations (see Maury Goodman's article in the Spring 1998 *Beam Line*, Vol. 28, No. 1). Strong evidence that neutrinos can oscillate from one flavor to another was reported in 1998 by the Super-Kamiokande experiment in Japan, which observed muon neutrinos produced in the Earth's upper atmosphere by cosmic rays. What Super-Kamiokande observed was that the number of muon neutrinos measured depends on where the muon neutrinos were produced—above the detector, where they needed to travel only 10–100 km before observation, or below it all the way on the other side of the Earth, where they would have to travel



thousands of kilometers to reach the detector. If muon neutrinos can oscillate into another type of neutrino, they would produce exactly the type of up-down, distance-dependent difference in the number of neutrinos witnessed by Super-Kamiokande (see John Learned's article in the Winter 1999 *Beam Line*, Vol. 29, No. 3).

For solar neutrinos, however, the distance from the production point (the Sun) to the detection point (the Earth) does not vary enough to allow the kind of measurements made with Super-Kamiokande's atmospheric muon neutrinos. Rather than look for distance-dependent effects, the way to prove that the electron neutrinos produced in the Sun are oscillating into muon neutrinos or tau neutrinos is to search directly for evidence of these neutrinos. SNO is designed to do just that: determine whether or not solar neutrinos other than electron neutrinos are arriving from the Sun. If this were true, it would not only solve the long-standing solar neutrino problem, but also provide the most direct evidence yet that neutrinos do indeed oscillate.

## THE SUDBURY NEUTRINO OBSERVATORY

Like an invisible man on the beach who can be "seen" only by tracking his footprints, neutrinos can be observed only by the traces they leave behind as they pass through a detector. We cannot see them directly. In Davis's experiment, these traces came in the form of atoms of the element argon, which were created when neutrinos collided with atoms of chlorine. Every so often the physicists would flush out the detec-

tor and count the number of argon atoms that had accumulated, deducing from this evidence how many solar neutrinos must have traversed the detector. Other experiments that used gallium rather than chlorine operated in a similar way: essentially visiting the beach now and then just to see if any additional footprints had been made.

A different approach was taken by the Kamiokande experiment—and subsequently by Super-Kamiokande—which was able to view the neutrino "footprints" as they were being made. In these experiments, the detectors were made primarily of water, but rather than changing the atoms of water into something else, neutrinos scattered their electrons in the same way that one billiard ball collides with another. Each time this happened, the scattered electron produced a cone-shaped flash of blue light called Cerenkov light, which was quickly converted into electrical signals by photon detectors placed outside the water volume.

The footprint metaphor however fails to highlight the most critical problem of neutrino detection. Neutrino interactions with matter are so weak that the chances of a footprint occurring are incredibly small; a typical neutrino can travel easily through a light year's worth of lead. Even then, every so often—essentially just by accident—one does collide with something, such as a chlorine atom in Davis's experiment or an electron in the Super-Kamiokande experiment. To increase the chances of observing neutrinos, a detector must therefore contain lots of material—lots of chlorine or lots of electrons, for example—thus giving

the neutrinos many opportunities for an accidental collision. Solar neutrino detectors therefore tend to be very big: the Super-Kamiokande experiment, for example, holds over 50,000 tons of water.

There is one further difficulty in trying to detect neutrinos from the Sun. To return one last time to our invisible man, imagine that the beach is crowded with swimmers and sunbathers each of whom also leaves footprints. Trying to figure out which footprints are meaningful (especially given that the number made by the other beachgoers is far larger than those made by our invisible stroller) is an extremely difficult task. Cosmic rays are one example of this problem, since they can create Cerenkov light in the same way neutrino interactions do. And we are being bombarded by cosmic rays all the time: if each cosmic ray were a raindrop hitting the surface of the Earth, we would be soaked by a steady downpour amounting to about one inch every few hours. The bottom of a mine is therefore an ideal place to study neutrinos because most cosmic rays are stopped by the rock before they reach the detector, while neutrinos are unaffected. To solar neutrinos, a kilometer of rock hardly matters at all, nor do the thousands of kilometers below the detector through which they travel upward during the night.

The Sudbury Neutrino Observatory uses the same basic technique as the Kamiokande experiments—looking for Cerenkov light produced by neutrinos interacting in water. A total of 7000 tons of water sits in a cavern 22 m wide by 34 m high, carved out of rock 2000 m beneath the surface of INCO Ltd.'s Creighton

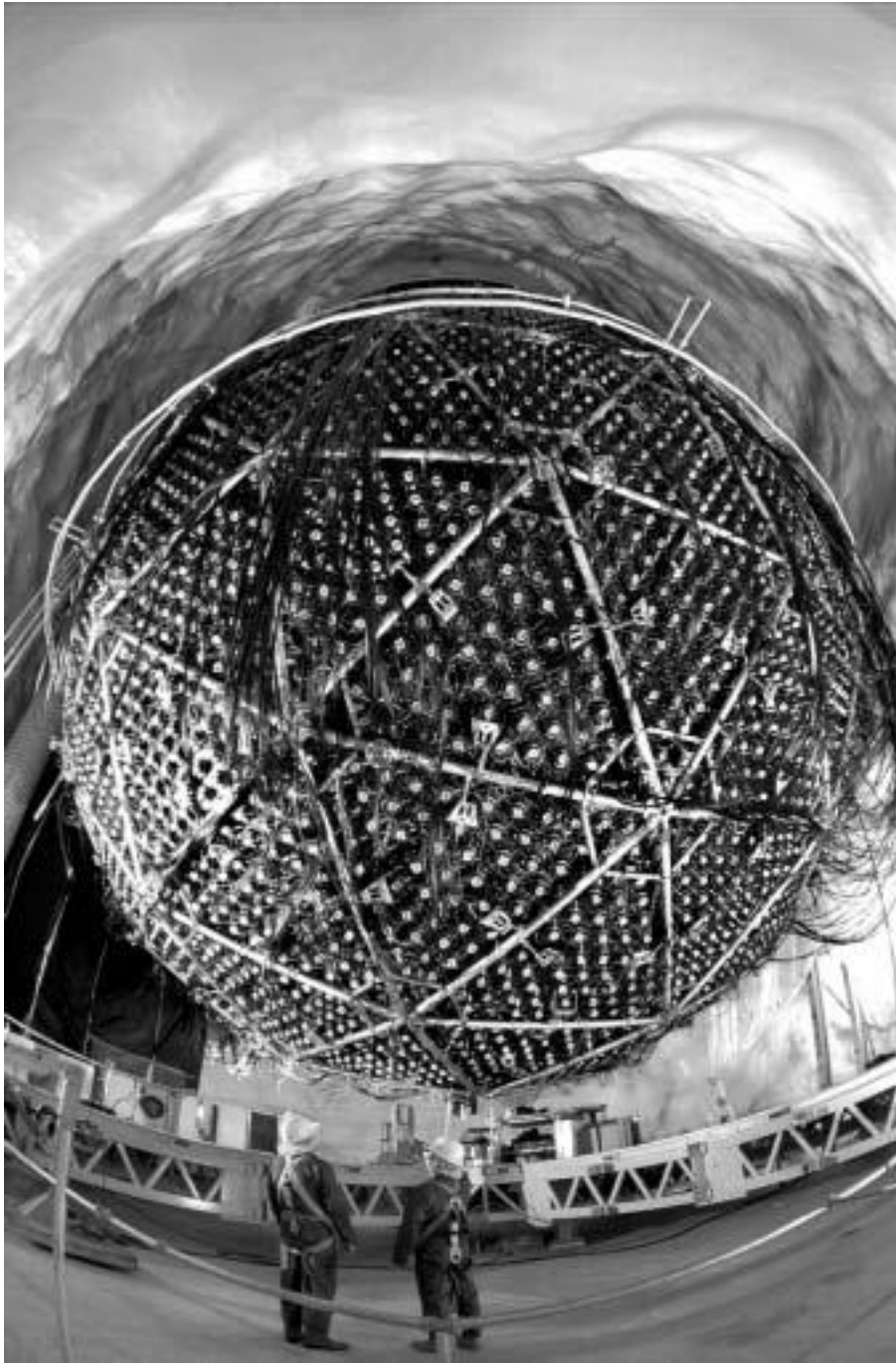

*Outside view of the SNO detector after construction was complete. Supported by a geodesic sphere, 9500 photomultiplier tubes view the acrylic sphere within. (Courtesy Lawrence Berkeley National Laboratory)*

Mine in Sudbury, Ontario (see illustration on page 18). At SNO's depth—deeper than any other solar neutrino experiment—only three cosmic rays pass through the detector each hour. The Cerenkov light created by the neutrino interactions is detected by an array of 9500 photomultiplier tubes (PMTs), each capable of registering a single photon of light. This sensitivity to single photons is necessary because a neutrino event typically produces only 500 photons. The PMTs are supported by a stainless steel geodesic sphere 17.8 m in diameter.

Nested inside the PMT support sphere is a second sphere 12 m in diameter, built from 5.5-cm thick transparent acrylic. This vessel and its contents are what makes SNO unique: rather than holding ordinary water, which has two hydrogen atoms bound to one oxygen atom ( $\text{H}_2\text{O}$ ), the acrylic vessel holds 275,000 gallons (1000 metric tons) of heavy water, which has two deuterium atoms bound to one oxygen atom ( $\text{D}_2\text{O}$ ). Deuterium is the same as hydrogen in all respects except that it has a proton and a neutron in its nucleus (called a deuteron). It is this extra neutron that allows SNO to distinguish different types of neutrinos and thus determine whether there are neutrinos other than electron neutrinos reaching Earth from the Sun.

Cosmic rays are not the only source of false signals that SNO has been designed to avoid. Just about any material one can find on Earth—water, steel, mine dust—has a tiny amount of naturally occurring radioactive contamination. These radioactive nuclei produce charged particles that can generate the same

Cerenkov light as neutrino interactions or cosmic rays. For this reason, nearly everything used in the construction of the detector—even the glass used in the photomultiplier tubes—was designed specifically for SNO out of materials that are low in radioactivity. Locating the detector in an active mine adds an extra challenge, since the dust and mud have relatively high levels of radioactive contamination. Just a tablespoon of mine dust dropped into the 275,000 gallons of heavy water would have enough radioactivity in it to mask the neutrino signals.

The entire underground lab is therefore operated as a clean room, the air is continuously filtered and everything and every person entering it must be cleaned off to remove any telltale remnants of the outside mine. The heavy water in the detector is also purified, removing not just dust but radon, a radioactive gas. And as a last line of defense, ordinary water fills the space outside the acrylic vessel, shielding the heavy water from radioactive signals originating in the surrounding rock. This H<sub>2</sub>O shielding, the great depth, and the insistence on ultrapure materials as well as dust-free air and very clean people, has made the center of the SNO detector the point of lowest radioactivity on Earth.

## DETECTING NEUTRINOS

When a neutrino enters the SNO detector, several things can happen. By far the most likely is that it sails straight through unobserved; although about five million solar neutrinos pass through each square centimeter of the detector every

second, only about five of them produce a signal in the entire detector in any given day. For those few neutrinos that do interact, SNO's heavy water allows three possible scenarios. For one, an electron neutrino can be absorbed by a neutron inside a deuteron; the neutron then becomes a proton and emits an electron (see top diagram at right) which then produces Cerenkov light that is detected by the PMTs. This neutrino-absorption reaction is special because it only occurs for electron neutrinos.

SNO's second reaction is the same electron-scattering interaction as witnessed by the Kamiokande and Super-Kamiokande experiments. A solar neutrino collides with an electron and kicks it out of its D<sub>2</sub>O molecule. As with the neutrino-absorption reaction, the scattered electron produces Cerenkov light that is detected by the photomultiplier tubes. SNO can distinguish these electrons from those created in the neutrino-absorption reaction by the fact that, like a billiard ball struck dead on by the cue ball, the scattered electron emerges close to the direction of the incoming neutrino. Therefore knowledge of the electron's direction and the Sun's position when the event occurred are required to identify it as an electron-scattering event. Although this reaction can occur for either muon neutrinos or tau neutrinos, it happens most often (6.5 times more often) for the electron neutrinos.

In the third reaction, which is also sensitive to muon and tau neutrinos, the neutrino breaks the deuteron up into a separate neutron and proton. The neutron itself cannot produce Cerenkov light, but eventually it is

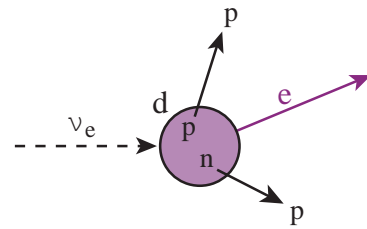

*Absorption of a neutrino by a neutron in a deuteron. The neutron changes into a proton, emitting an energetic electron.*

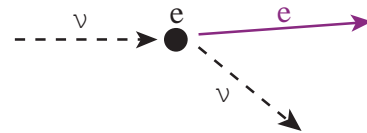

*Scattering of an electron by a neutrino. This process occurs most often with electron neutrinos, but can also occur for muon and tau neutrinos.*

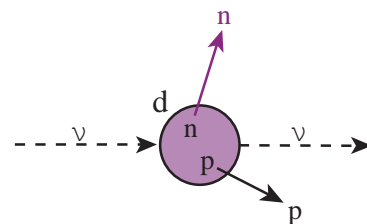

*Breakup of a deuteron by a neutrino. This process happens with equal probability for any neutrino type.*

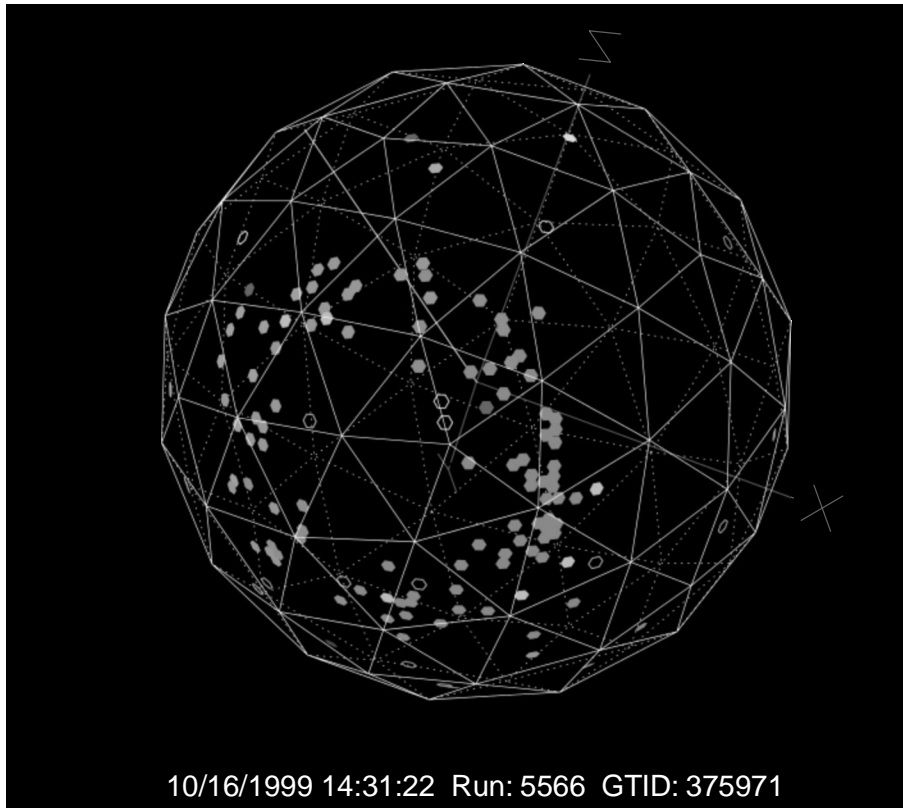

*Computer reconstruction of a typical solar neutrino event in the SNO detector. The filled-in dots correspond to photomultiplier tubes that have detected photons; the resulting cone of Cerenkov light produces a ring when projected onto the sphere.*

captured by one of the other deuterons in the heavy water, producing a gamma ray that scatters an electron in the water. This secondary electron then produces Cerenkov light. In this deuteron-breakup reaction, all neutrino flavors are on an equal footing—a muon neutrino or a tau neutrino has the same probability of interacting this way as has an electron neutrino.

Using these three reactions, proving that neutrino oscillations explain the solar neutrino problem becomes very simple: if the number of neutrinos measured with either the electron-scattering reaction or the deuteron-breakup reaction is greater than the number measured with the neutrino-absorption reaction, their must be neutrinos other than electron neutrinos coming from

the Sun. For this to be true, neutrinos born as electron neutrinos in the solar center must be changing their flavor somewhere on their way to the Earth.

### THE FIRST RESULTS

The SNO experiment therefore has two good ways of demonstrating the presence of muon and tau neutrinos coming from the Sun. The deuteron-breakup reaction has the advantage that it occurs for all neutrino flavors equally, and thus it directly measures the Sun's total neutrino output. Because of this, we would expect to find a big difference between the number of neutrinos measured through deuteron breakup (all kinds) and the number measured through neutrino absorption (just electron neutrinos). Using the electron-scattering reaction is not as easy. Because it occurs less than one sixth of the time for muon and tau neutrinos as for electron neutrinos, the difference between the total number of interactions measured with this reaction and the number measured with the neutrino-absorption reaction will not be very large unless most of the neutrinos coming from the Sun have changed from electron neutrinos into muon or tau neutrinos.

But the electron-scattering reaction does have one great advantage: the Super-Kamiokande experiment has already used this reaction to observe neutrinos from the Sun. Over several years, this experiment has observed that the number of neutrinos producing electron-scattering reactions in the detector was 45 percent of what had been required by theory. If the theory of the Sun is correct,



then the missing 55 percent are muon or tau neutrinos that the electron-scattering reaction has failed to detect. What is needed, therefore, is a separate determination of the flux of electron neutrinos alone; once this is known, we can conclude that any additional flux is due to these other kinds of neutrinos.

SNO's first order of business was thus to use the neutrino-absorption reaction to measure the number of electron neutrinos and to compare this to Super-Kamiokande's measurement of the number of neutrinos observed with the electron-scattering reaction. In 241 days of taking data, SNO detected 1169 neutrino events, about 950 of which were determined to have been due to neutrino-absorption reactions. The theory of the Sun predicted that there should have been over 2700 electron neutrinos detected this way (assuming no oscillations) during this time—in other words, SNO only observed 35 percent of the expected number. The fact that Super-Kamiokande measures 45 percent of the expected number using a reaction that can detect *all* neutrino flavors, while SNO measures just 35 percent of the expected number using a reaction that detects only electron neutrinos, can mean just one thing: there are other kinds of neutrinos coming from the Sun.

For the first time, therefore, there is clear evidence that neutrinos from the Sun can change from one type into another. The Standard Model, which predicts that the three neutrino flavors are separate and distinct, must be altered to accommodate this effect. But there is an added bonus, one that starts to bring to an end the

long search begun over 30 years ago by Ray Davis. The additional neutrinos that Super-Kamiokande observes with the electron-scattering reaction are the first confirmation that the theory of the Sun is indeed correct!

Recall that the electron-scattering reaction only detects 1/6.5 of the muon and tau neutrino flavors, so the 10 percent extra flux that Super-Kamiokande sees must mean that actually about 65 percent of neutrinos coming from the Sun are muon or tau neutrinos. Adding this 65 percent to the 35 percent worth of electron neutrinos which SNO measures gives us *100 percent* of the expected total. After 30 years, we find that there really aren't any neutrinos "missing" after all. They were just more difficult to detect! Our theory of the Sun therefore appears to be more correct than our fundamental theory of matter.

## THE FUTURE

There is still much left for SNO to do. In particular, measurements with the deuteron-breakup reaction will provide a much more accurate determination of the total number of neutrinos coming from the Sun. Comparing the number of neutrinos measured with the deuteron-breakup reaction to those that are measured with the neutrino-absorption reaction will provide a much better determination of the degree to which neutrinos oscillate. In addition to this, SNO should be able to look for changes over time in the Sun's output of neutrinos, observe their energies, and measure other characteristics that can tell us about properties of the solar core.

Gazing at sunshine from the bottom of Creighton mine, the Sudbury Neutrino Observatory has already learned two important things: that neutrinos born in the Sun do change into other kinds on their journey toward Earth, and that this change is responsible for the neutrino deficit first noticed by Ray Davis. He started out trying to learn something about the Sun, but what he and the rest of us discovered was that we first needed to learn something more about the neutrinos themselves. And while there are still many ways yet in which we will use the Sun to help us understand neutrinos, we can now begin anew the project that was postponed after Davis's first observations—and start using neutrinos to understand the Sun itself.



## For Further Information

To learn more about the Sudbury Neutrino Observatory, go to:

<http://owl.phy.queensu.ca>

# Neutrino Experiments at

by PAUL NIENABER

*Neutrino physics  
is thriving  
in the  
Nation's  
heartland.*

**P**ARTICLE PHYSICS EXPERIMENTS often get lumped under the general heading of “big science.” Particle accelerators are gargantuan, detectors are huge and complex, and today’s multi-institutional collaborations generate social dynamics whose unraveling would baffle the most sophisticated supercomputer. Neutrino experiments are no exception to this observation; the detectors come in three sizes: large, extra-large, and positively Bunyanesque. Yet, like the graceful hippopotami in Walt Disney’s *Fantasia*, a “little” neutrino experiment can on occasion dance briskly in, do some beautiful tour-de-force physics, and take a bow—all for a relatively modest ticket price. Two premier danseurs of this sort on the Fermilab stage are the DONUT and BooNE experiments. DONUT (Direct Observation of the Nu-Tau) has completed its run and is now accepting bravos for being the first experiment to detect the tau neutrino. BooNE (Booster Neutrino Experiment) is waiting in the wings, warming up to delve more deeply into the peculiar pas de deux of neutrino oscillations.

According to the Standard Model, our current best working theory of elementary particles and fundamental forces, a neutrino can interact and change into its electrically charged lepton partner by emitting or absorbing the charged carrier of the weak force, the  $W$  boson. This type of exchange is called a “charged-current” interaction (to distinguish it



# Fermilab

from the exchange of a neutral  $Z$  boson). The weak force also obeys a two-fold lepton-number conservation rule: both the number of leptons and their kind remains unchanged. Interacting electron neutrinos yield only electrons, muon neutrinos only muons, tau neutrinos only taus. Neutrinos and their charged partners can switch back and forth within a Standard Model generation, but they cannot jump between generations. This conservation rule makes the charged-current interaction a useful “generation tagger”: if you see a muon zipping through your neutrino detector, and you can ascertain that it came directly from a neutrino interaction, you can be sure it was produced by a muon neutrino.

Because neutrinos are immune to the strong and electromagnetic interactions, they provide a unique “weak force scalpel” for investigating the properties of particles. Electron neutrinos are difficult to concentrate into a beam whose direction and energy can be varied, so muon neutrinos have become the scalpel of choice. The recipe is fairly straightforward: take a proton beam, smack it into a block of material, magnetically focus and direct the charged pions and kaons spewing forth from the collision, allow them to decay into muons and muon neutrinos, filter out the charged decay products and any other unwanted debris, and voila! You have a beam of muon neutrinos.

But because neutrinos interact so weakly, the chances of any single one interacting in a detector are minuscule. The probability of witnessing an interaction depends on the number of neutrinos, their energy, and the number of other particles available for them to hit. Getting a reasonable number of events therefore requires lots of neutrinos, lots of energy, and lots and lots of detector material—hence the Brobdingnagian scale of neutrino experiments.



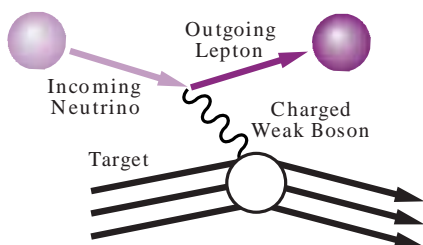

*A neutrino charged-current interaction.*

*DONUT detector for direct observation of tau neutrinos.*

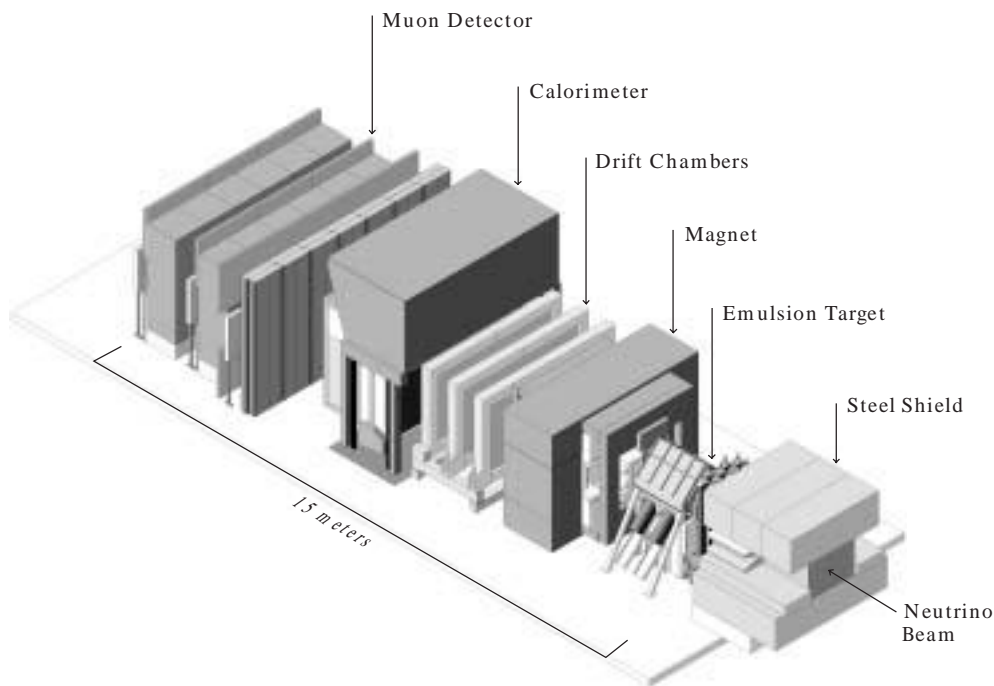

**W**ITH THE DISCOVERY of the top quark at Fermilab in 1995, the set of six fundamental constituents of the strongly interacting particles in the Standard Model was complete. The lepton six-pack, however, still had one gaping hole—the tau neutrino remained the most elusive of its standoffish cousins. Experiments at SLAC and CERN had determined that there were at most three conventional, lightweight neutrinos, and there was indirect evidence from the missing momentum observed in decays of the tau lepton, but no definitive sightings (see “Pauli’s Ghost,” by Michael Riordan, this issue).

Understanding why the tau neutrino is so camera shy takes us back to the charged-current interaction. Electron neutrinos make electrons,

which interact almost immediately in detector material and produce a distinctive shower of particles. Muon neutrinos engender muons, which travel relatively undisturbed through matter before decaying and thus leave long tracks in detectors. Tau neutrinos make taus—and there’s the rub. The tau lifetime is less than one third of a trillionth of a second; multiply this brief instant by the speed of light and you get a decay length literally the size of a gnat’s whisker, about 90 microns. If a tau is extremely relativistic, it may travel a few millimeters before decaying, but tracing these microscopic paths to discover any kinks in them demands extremely high-precision tracking. This requirement, coupled with the small likelihood of tau neutrinos ever interacting, makes detecting them an extraordinary challenge. To rise to that challenge came the DONUT experiment, which ran at the Fermilab Tevatron in 1997.

There are two hurdles to overcome if you want to bag a tau neutrino: first you gotta make ‘em, and then you gotta take ‘em. To make tau neutrinos, you employ a variation on the muon-neutrino recipe, but instead of using pions and kaons as the parents, you must employ much heavier mesons. The lepton-number conservation rule says you can only make a tau or its neutrino in tandem with an antilepton of the third generation. To get tau neutrinos, therefore, you have to produce a parent particle that includes a tau (whose mass is a whopping 1777 MeV, almost twice the mass of a proton) in its decay chain. DONUT’s tau neutrinos come from the decay of  $D_s$  mesons, produced by slamming the Tevatron’s



800 GeV protons into a tungsten target. These mesons are also heavy (1970 MeV) and short-lived, so no attempt to focus them is made.

The aim of the experiment is to look for charged-current scattering of the resulting tau neutrinos. This process will make final-state taus, but how does one corral these evanescent heavyweights? The key to this experiment, the factor that makes it both beautiful and rather difficult, is the use of a large target composed of photographic emulsion plates. These plates are just standard black-and-white film medium, silver bromide, suspended in a gel. Instead of a thin layer of this substance coating a 35 mm piece of plastic film, however, DONUT's plates contain the bulk emulsion deposited on square sheets about the size of a large pizza box (50 cm square). Charged particles traversing the emulsion leave tracks of exposed grains, and finding a vertex (where the tau neutrino interacted) that spawns a kinked track (where the resulting tau lepton subsequently decayed) provides the "smoking gun," evidence for a tau neutrino.

Isolating such a vertex with a track that kinks a scant few millimeters downstream of it is no easy feat. The emulsion stack is only 36 meters downstream of the tungsten target, which means that extensive shielding must be used to keep the emulsion from being swamped by superfluous tracks. The usual passive shielding (which filters out unwanted particles by letting them interact in material) is not enough; DONUT's emulsion stack needed active elements (magnetic fields to divert charged detritus) as well.

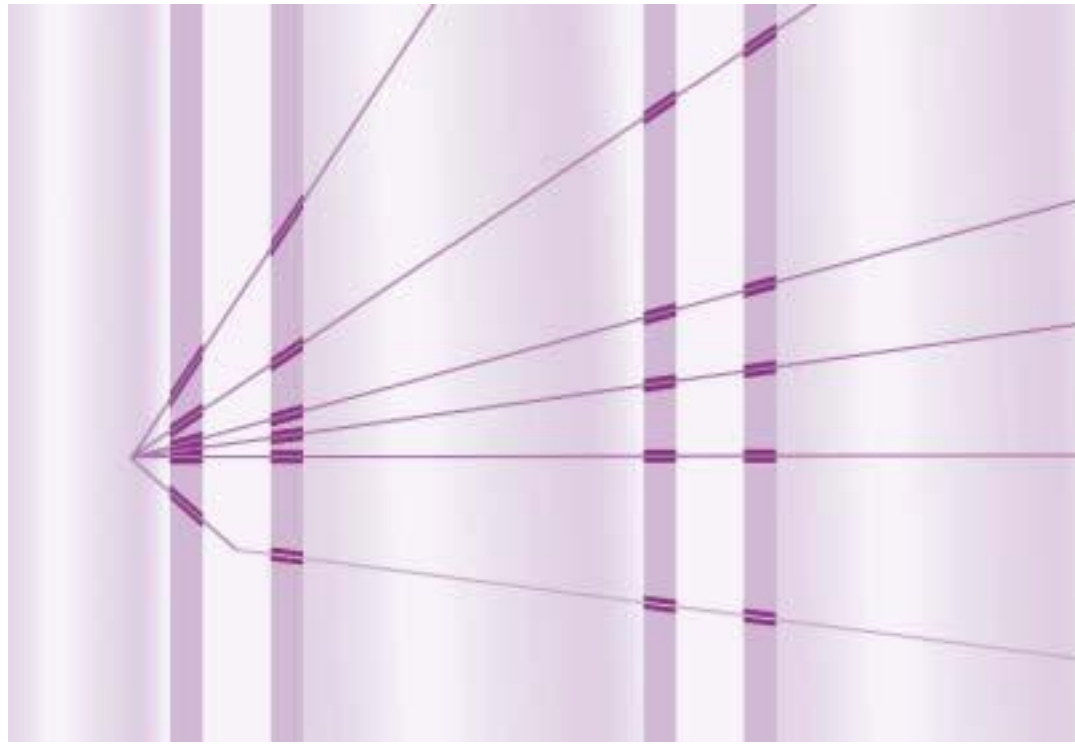

DONUT was also in the unusual position of having to deal with neutrino backgrounds, since the proton interactions in the tungsten produce plenty of electron and muon neutrinos, too. These extra neutrinos can interact in the emulsion as well and render the stack awash in tracks.

To help pick out a few specific bent needles from this huge haystack of tracks, the experimenters positioned a series of scintillating-fiber tracking detectors among the emulsion plates. These trackers, together with other detectors downstream of the emulsion array, helped identify the particles and trace out their paths. The vertex and track reconstruction enabled a tiny, precisely selected region of the emulsion to be pinpointed for closer scanning and measurement. The actual digitization and scanning of the emulsion,

*One of the four tau neutrino events recorded by the DONUT detector. The track with a kink is a tau lepton decaying into an invisible tau neutrino and another particle.*

section by tiny section, was done at a unique facility in Nagoya, Japan, one of the few of its kind in the world. In July 2000, after data reduction and a careful analysis to screen out backgrounds, the DONUT team showed the world four events with a distinctive kink in one track, indicating a tau lepton decay. The first

direct sightings of the tau neutrino, these events confirmed at last that it indeed exists.

**A**T ABOUT THE TIME that the DONUT collaboration was looking for telltale kinks, evidence was accumulating from other quarters that the Standard Model might not be quite right. Several experiments had seen hints that two fundamental features thought to hold for neutrinos—the expectation that they are massless and that they cannot change from one kind to another—were in fact incorrect. Rather loose upper bounds had been set on the neutrino masses by carefully adding up all the visible energy in certain particle decays that produce neutrinos. And the prohibition on leptons jumping from one generation to another had been probed by searches for exotic processes such as  $\mu \rightarrow e\gamma$ .

One way to establish more stringent limits is to examine the curious possibility of neutrino oscillations (see box at left). Understanding how such oscillations might occur requires us to step into the sometimes-counterintuitive world of quantum mechanics. According to the Standard Model, neutrinos are massless and conserve lepton number. But if this is not in fact the case, then neutrinos can have different masses, and a neutrino created as one kind (say an electron neutrino, produced in the nuclear reactions occurring in the Sun's core) could evolve, or oscillate, into another kind as it zooms along through space.

Quantum mechanics tells us that the characteristics of any neutrino oscillation—its amplitude and repeat

## Neutrino Oscillations

**H**ERE'S A GOOD WAY to think about neutrino oscillations. Suppose you could only hear a single pitch (or frequency) of sound at a time: That is, your "sound detector" could only tell that a note was a G, or a B, or a D; it could not detect a mixture of these notes. If a note (you hear) starts out as a G (or a B or D for that matter), it would stay that way forever. This is the way that charged leptons behave.

Neutrinos play by different rules, however, and admit the possibility that a note originating as a G (an electron neutrino, say) can "detune" as it travels, developing B or D components (a muon or tau neutrino). This kind of behavior is analogous to that of the strings in a guitar, which—once plucked—can excite lesser vibrations on the other strings.

Does this mean that one would hear chords in neutrino beams? No—remember, you can detect only one "pitch" at a time. What it does mean, however, is that if you create a pure beam of 1000 Gs, say, and set up a listening post some distance away, you might get 990 Gs and 10 Bs. What fluctuates in neutrino oscillations is the probability that a neutrino created as one specific kind will be detected as that same kind (or another kind) of neutrino.

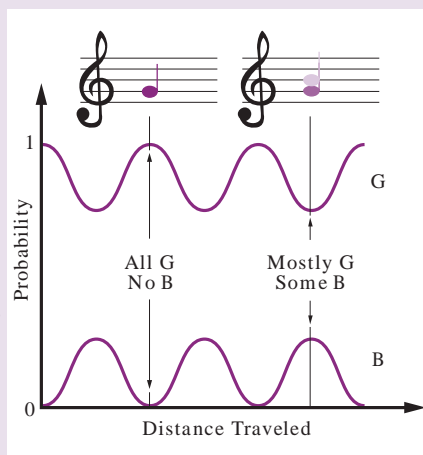

*Oscillation probability: even though the neutrino beam starts out as 100 percent G's, as it moves through space, the beam can gain (and lose, and then regain) some B's. What oscillates is the probability.*

length—are governed by four factors. Two of them are experiment-specific: the neutrino energy  $E$  and the source-to-detector distance  $L$ . The other two are intrinsic properties of how the neutrinos fluctuate back and forth from one kind to another: the oscillation strength itself (the amplitude of the wave) and the absolute difference between the squares of their two masses  $\Delta m^2 = |m_1^2 - m_2^2|$ . One of the current problems in neutrino-oscillation physics has to do with this last parameter,  $\Delta m^2$ . Since there are three known kinds of neutrino, there can only be two independent differences between their mass states. The three classes of experiments currently yielding positive indications of neutrino oscillations—those studying neutrinos from the Sun, those observing neutrinos from muons produced in Earth’s atmosphere, and two accelerator-based experiments—do not yield a coherent set of  $\Delta m^2$  values (see article by Boris Kayser, this issue). This discrepancy could point to a new, fourth kind of neutrino (called a “sterile” neutrino because it cannot interact with ordinary matter). Or it could imply that one (or more) of these experiments is not really seeing oscillations but another effect.

The one accelerator-based experiment that reported a neutrino-oscillation signal is the Liquid Scintillator Neutrino Detector (LSND), which detected neutrinos from pions produced by a medium-energy proton beam at the Los Alamos National Laboratory. The collaboration observed an excess of events above background that can be explained by the oscillation of muon neutrinos into electron neutrinos, with a  $\Delta m^2$

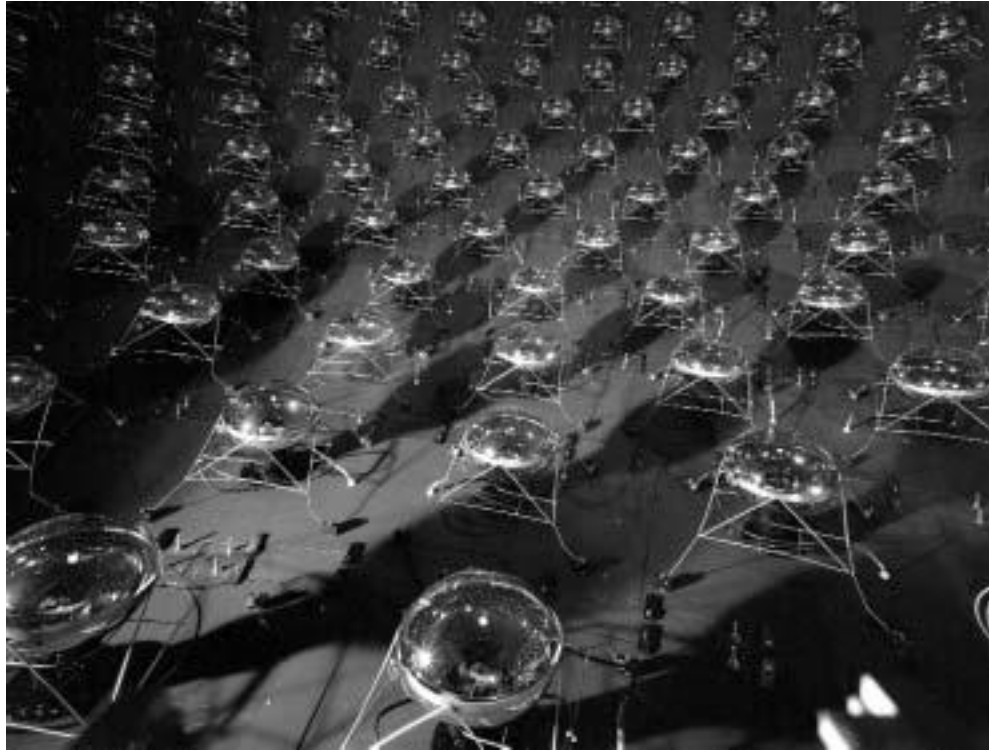

of about 1–2 eV<sup>2</sup>. A result of no small importance, it cries out for independent confirmation. Enter the second of Fermilab’s lissome leviathans, the Booster Neutrino Experiment.

BoONE’s main raison d’être is to test the LSND result. It will either provide confirming evidence (and get enough events to establish the  $\nu_\mu$  to  $\nu_e$  transformation once and for all) or prove LSND wrong—and set more stringent limits on this particular type of oscillation. There are some surface similarities between LSND and BoONE: both use large tanks filled with mineral oil and lined with photomultiplier tubes. But the detector geometries are different (LSND is cylindrical, while BoONE is spherical), the source-to-detector distance  $L$  and beam energy  $E$  are different (although the ratio  $L/E$  for the two

*Some of the 1200 photomultiplier tubes on the inside of the BoONE detector.*

experiments is the same), and the backgrounds for BoONE will be different from those of LSND.

The BoONE experiment will follow the standard recipe for making a muon neutrino beam, starting with 8 GeV protons from the Fermilab Booster, a low-energy synchrotron in the Tevatron acceleration chain used to boost protons from 400 MeV to 8 GeV before passing them on to the Main Injector. Protons extracted from the Booster will strike a beryllium target; pions generated by these collisions will be focused by a magnetic horn, and their decay will produce the muon neutrinos speeding off toward the detector.

*Artist's conception of the BoONE detector, showing some of the photomultiplier tubes lining its 250,000-gallon tank.*

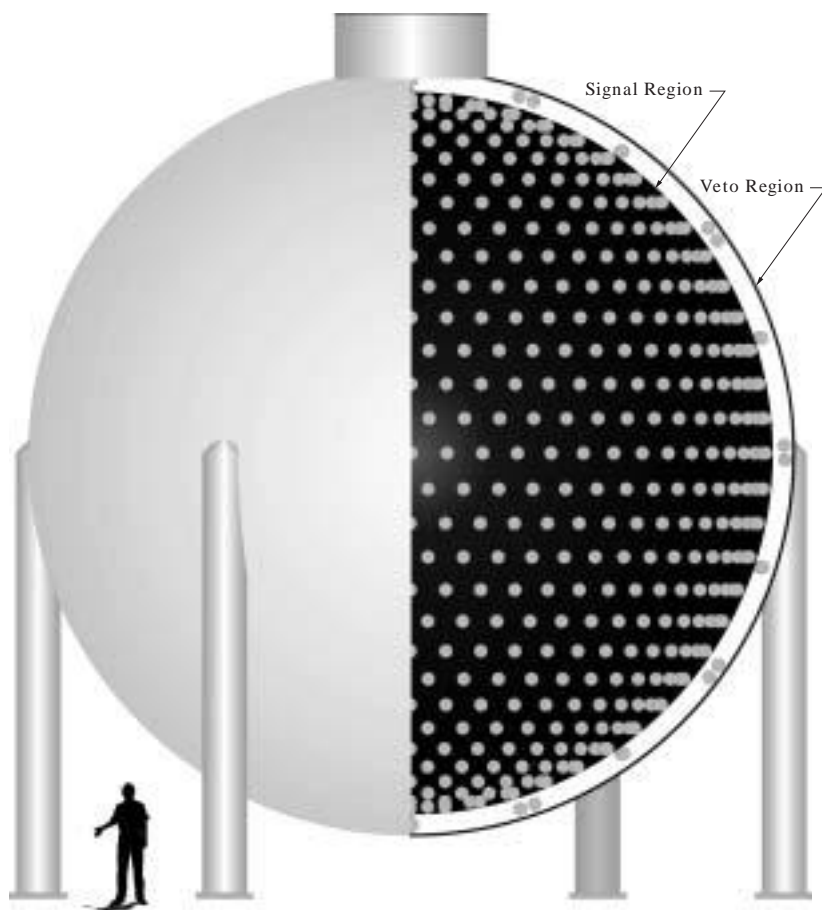

The BoONE detector is a 12 m diameter steel sphere filled with 770 tons (about 250,000 gallons) of mineral oil (see illustration on this page). A second light-tight inner wall divides the tank into an active central sphere and an outer “veto” shell used to flag exiting or extraneous incoming particles. Charged particles produced by neutrino interactions in the oil are detected by means of the blue Cerenkov light they generate, which will be detected by 1280 photomultiplier tubes lining the inner surface of the central sphere or the 330 tubes in the veto shell. Again, the charged-current interaction will allow physicists to identify the kind of neutrino involved; a long muon track (from the interaction of a  $\nu_\mu$  in the mineral oil) will generate a pattern of Cerenkov light distinct from that produced by an electron shower (from a  $\nu_e$  interaction).

As this article goes to press, construction of the BoONE detector is nearing completion, and the proton-extraction beam line and target-horn systems are well underway. Data taking is expected to commence in early 2002, after which the experiment should run for one to two years. If a signal is observed, a second detector can be built downstream of the first—to make further detailed measurements of the parameters for  $\nu_\mu \rightarrow \nu_e$  oscillations. Such a result would add to the growing body of evidence that neutrinos do indeed have mass, and point to the exciting possibility of new physics beyond the Standard Model.

**N**EUTRINO PHYSICS has long been a featured performer in Fermilab's



multifaceted particle physics program. DONUT has made a major contribution, and the upcoming BooNE experiment bids fair to continue that history. Future neutrino-beam opportunities might include upgrading the Booster to allow it to provide even greater fluxes of neutrinos. There are also the exciting prospects of “long-baseline” neutrino experiments where the distance between the source and detector is hundreds of kilometers rather than hundreds of meters.

One such Bunyanesque experiment stretches all the way from Fermilab to the Soudan mine in northern Minnesota, where the detector for the MINOS (Main Injector Neutrino Oscillation Search) experiment will be located. The MINOS beam starts with 120 GeV protons from the Main Injector, which feeds the Fermilab Tevatron. The neutrino beam produced by these protons hitting a target will be directed north and slightly downward, to intercept a six-kiloton steel-and-scintillator detector in an iron mine some 750 km away—making MINOS one of the largest neutrino experiments on the planet. When this football field-length detector is complete, it will capture neutrinos beamed from Fermilab and further probe the mysteries of neutrino oscillations. The combination of neutrino energies and the long baseline between source and detector make MINOS sensitive to values of  $\Delta m^2$  a hundred times smaller than BooNE. This is the same range of values that has been observed for oscillations of neutrinos in the upper atmosphere (see article by John Learned in the Winter 1999 *Beam Line*, Vol. 29, No. 3).

Peering still further into the future, one can glimpse the intriguing possibility of a “neutrino factory”—a storage ring for muons whose decay would provide a copious source of muon and electron neutrinos. Such a high-energy source of electron neutrinos would open whole new vistas for further exploration of the weak interaction. But whatever scenarios the future contains, neutrinos will surely play leading roles in them.

## For Further Information

DONUT home page:  
<http://www-donut.fnal.gov>

BooNE home page:  
<http://www-boone.fnal.gov/>

Juha Peltoniemi’s “ultimate neutrino” page:  
<http://cupp oulu.fi/neutrino/>

*Members of the MINOS collaboration before one of its enormous steel plates.*

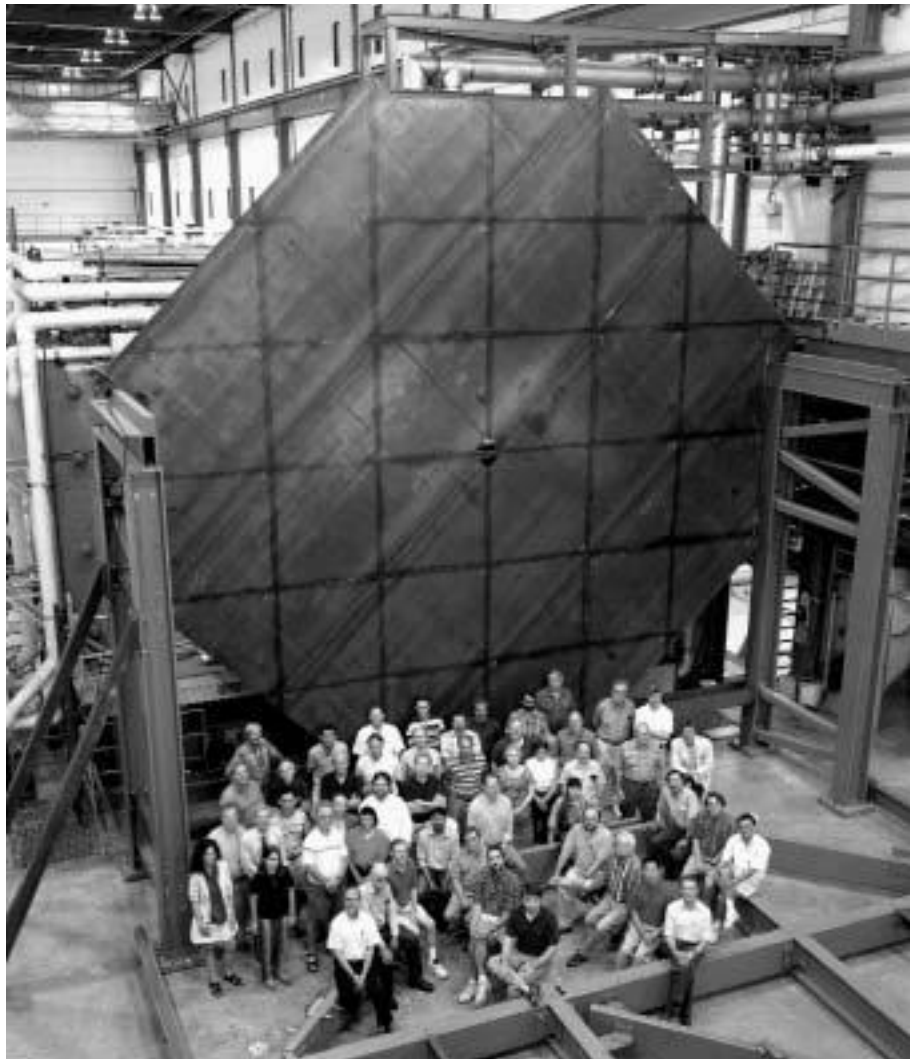

# The Enigmatic World of

by BORIS KAYSER

*Trying  
to  
discern  
the  
patterns  
of  
neutrino  
masses  
and  
mixing.*

**N**EURINOS ARE AMONG THE MOST ABUNDANT elementary particles in the Universe. They are a billion times more abundant than nucleons or electrons. If we would like to understand the Universe, we must therefore understand neutrinos. Learning about the world of neutrinos is not easy, however, because their interaction with other matter is extremely feeble.

In the last few years, however, dramatic progress has been made. An experiment has now confirmed (see article by Paul Nienaber, this issue) that neutrinos come in three different varieties, or “flavors”:  $\nu_e$ ,  $\nu_\mu$ , and  $\nu_\tau$ . These three neutrino flavors correspond to the three charged leptons: the electron  $e$ , its heavier cousin the muon  $\mu$ , and its still heavier cousin called the tau lepton  $\tau$ . Neutrinos of different flavor are distinctly different objects, but it has been convincingly demonstrated that a neutrino can spontaneously change its flavor! This metamorphosis is known as neutrino flavor oscillation, or simply neutrino oscillation. The evidence that neutrinos oscillate between flavors is particularly compelling in the case of atmospheric neutrinos—neutrinos made in the Earth’s atmosphere by cosmic rays. In 2001, the evidence also became rather strong in the case of solar neutrinos—neutrinos made in the Sun by nuclear processes (see article by Joshua Klein, this issue).

Any neutrino oscillation necessarily implies that neutrinos have mass. Thus, even though neutrino masses are extremely tiny, the observation that neutrinos oscillate tells us that these masses are not zero. These neutrino masses could have very interesting consequences for both particle physics and cosmology.

How big are the neutrino masses? Unfortunately, oscillation experiments cannot tell us, because oscillation depends only on the differences—or “splittings”—between the squared masses of different neutrinos. Of course,

# Neutrinos



these splittings can teach us about the pattern of neutrino masses but not about the absolute scale of this pattern. To discover this scale, we will have to carry out very different kinds of experiments.

While finding experimental evidence for neutrino masses has been a challenge, many theoretical physicists have strongly suspected that these masses do indeed exist. Neutrinos are close relatives of the other constituents of matter—the quarks and the charged leptons—and interact with them via the weak nuclear force. Moreover, the quarks, charged leptons, and neutrinos have very similar weak interactions. The very successful theory of the elementary particle interactions known as the Standard Model relates the quarks, charged leptons, and neutrinos to one another by placing them into families. Each family contains two quarks, or else one neutrino and one charged lepton, and the weak force can turn one member of any family into the other. With these hints that neutrinos are related to the charged leptons and quarks, and the observation that all of the charged leptons and all of the quarks have nonzero masses, one expects that the neutrinos probably have nonzero masses as well.

The masses of the charged leptons and quarks are incorporated, although not explained, in the Standard Model—which may also be able to include neutrino masses. But because the neutrino masses are very tiny, any such inclusion would have to involve some extremely small numbers that are not terribly likely to be ingredients of a genuine physical explanation. Thus, the complete explanation of neutrino masses will almost certainly take us to new physics beyond the Standard Model. Such physics is almost universally believed to exist because of the many questions this theory leaves open. However, this new physics has proved remarkably elusive. By opening a window on the new physics, neutrino masses could become very interesting indeed.

Owing to their great abundance, the neutrinos might well play a significant role in shaping the evolution and destiny of the Universe (see article by Joel Primack, this issue). Exactly what role they play depends on their masses, and on how big these masses are.

How is it possible for neutrinos to oscillate between different flavors, and why does this phenomenon imply that neutrinos have mass? To help explain the physics of neutrino oscillation (see box on next page), let me first sharpen the concept of neutrino flavor. By the neutrino  $\nu_\ell$  of flavor  $\ell$  ( $= e, \mu, \text{ or } \tau$ ), physicists mean the neutrino produced together with a particular charged lepton  $\ell$  in any process where there was no neutrino or charged lepton to begin with; one neutrino plus one charged lepton are created. For example, the  $\nu_\mu$  is the neutrino produced together with a muon in the pion decay  $\pi^+ \rightarrow \mu^+ + \nu_\mu$ .

Furthermore, when a neutrino interacts with matter and gives birth to a charged lepton, that lepton always has the same flavor as the neutrino. A  $\nu_e$  always begets an  $e$ , a  $\nu_\mu$  a  $\mu$ , and a  $\nu_\tau$  a  $\tau$ . This is how we know that  $\nu_e$ ,  $\nu_\mu$  and  $\nu_\tau$  must be distinctly different objects.

**T**HE MOST convincing single piece of evidence for neutrino oscillation in Nature comes from the behavior of the atmospheric neutrinos. These neutrinos have been detected by several underground detectors and studied most extensively by the Super-Kamiokande detector in a zinc mine in Japan. Atmospheric neutrinos studied by an underground detector can originate in the atmosphere directly above the detector, on the opposite side of the Earth, or above any other point on Earth (see illustration on the left). By detecting muons created in the Super-Kamiokande detector by incoming atmospheric muon neutrinos, the Super-Kamiokande collaboration has determined how the flux of them depends on the direction from which they are coming. The upward-going flux, coming up from all directions below the horizon at the location of the detector, is only about *half* the corresponding downward-going flux. Of course, the upward-going neutrinos originated in distant parts of the atmosphere, while the downward-going ones started much closer and traveled a much smaller distance.

The flux of cosmic rays energetic enough to produce atmospheric neutrinos with energies above a few billion electron volts is known to be isotropic. The atmospheric muon

*Atmospheric neutrinos incident on an underground detector (labeled D). The neutrinos originate from all around the world. Upward-going neutrinos (colored lines) have much more time to oscillate than downward-going ones (black lines).*

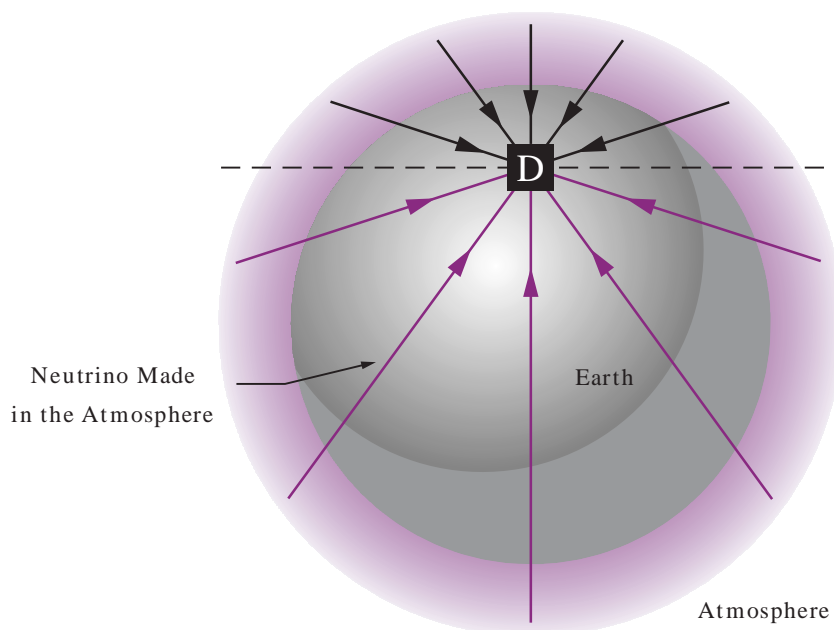



# Neutrino Mass and Mixing

IF NEUTRINOS HAVE MASSES, then the neutrino,  $\nu_\ell$ , produced together with a specific charged lepton,  $\ell$ , need not be a particle with a definite mass. Instead, it can be a quantum-mechanical superposition of such particles. This perplexing sleight-of-hand is called neutrino mixing. Let us call the neutrinos that do have definite masses—that is, the neutrino “mass eigenstates”— $\nu_1$ ,  $\nu_2$  and  $\nu_3$ , and so on. Then  $\nu_\ell$  can be a superposition of these eigenstates. Quantum mechanically, the  $\nu_\ell$  at its moment of birth is described by the wave labeled “At Birth” in the figure below, where we have made the simplifying assumption that  $\nu_\ell$  has only two significant components of definite mass,  $\nu_1$  and  $\nu_2$ . Each of these mass-eigenstate components is represented by a traveling wave. When  $\nu_\ell$  is born, the peaks of the waves coincide, and the two waves then add up to a resultant wave with the properties of  $\nu_\ell$ . If  $\nu_1$  and  $\nu_2$  have different masses  $M_1$  and  $M_2$  and our neutrino has a certain average momentum, then its  $\nu_1$  and  $\nu_2$  pieces will travel at different speeds. Consequently, after the neutrino has traveled awhile, the peak of the wave corresponding to the lighter mass-eigenstate component ( $\nu_1$  say) will have forged ahead of the peak of the wave corresponding to the heavier component.

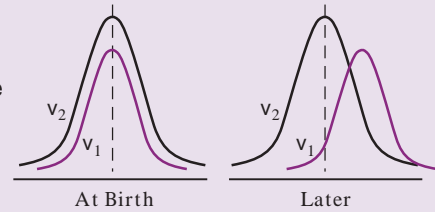

*A propagating neutrino wave consisting of  $\nu_1$  and  $\nu_2$  pieces. The vertical line passes through the peak of the  $\nu_2$  wave. When the neutrino is born (At Birth), this line coincides with the peak of the  $\nu_1$  wave, but at a later time (Later) it does not.*

Now, at any given time, the wave representing our neutrino is the sum (obtained using the usual rules for adding waves characterized by both amplitudes and phases) of the  $\nu_1$  and  $\nu_2$  contributions. Clearly, this sum is not the same “Later” as it was “At Birth.” After the neutrino has traveled for awhile, it therefore cannot be a pure  $\nu_\ell$  anymore. If one were to analyze this neutrino in terms of its flavor content, one would quickly find that it has developed components bearing flavors other than its original flavor. Thus, if the neutrino interacts in a detector and produces a charged lepton, there is some probability that this charged lepton is of another flavor. For example, our neutrino can be born together with a muon, so that it starts life as a  $\nu_\mu$ , but after developing components with other flavors, it can interact to produce a  $\tau$ . We describe this sequence of events by saying that our  $\nu_\mu$  had turned into a  $\nu_\tau$ . This is how a neutrino can spontaneously change flavor.

The possibility of this flavor change depends intrinsically on having neutrino mass eigenstates with *unequal* masses, which in turn requires that at least one of these masses be nonzero. Thus, neutrino oscillation implies neutrino mass. A calculation shows that when only two neutrino mass eigenstates  $\nu_1$  and  $\nu_2$  play a significant role, the probability for a neutrino to change flavor is proportional to  $\sin^2[(\delta M_{21}^2/4)(L/E)]$ . Here,  $\delta M_{21}^2 = M_2^2 - M_1^2$  is the splitting between the squared masses of the contributing mass eigenstates,  $L$  the distance traveled by the neutrino between its birth and detection, and  $E$  its energy. Note that the probability for neutrino oscillation really does oscillate, as the name implies. This probability depends only on the splitting between the neutrino squared masses, and not on the individual masses. This remains true when more than two mass eigenstates (hence more than one splitting) are involved.

neutrinos in this energy range are therefore being produced at the same rate everywhere around the Earth. Now one can easily formulate a neutrino-flux version of the Gauss’s Law familiar to any student of electricity and magnetism. From this law and the equality of neutrino production rates around the Earth, it follows that as long as atmospheric muon neutrinos neither appear nor disappear within the Earth, the upward and downward  $\nu_\mu$  fluxes studied by Super-Kamiokande should be equal. Thus, independent of any theoretical assumptions, the observed inequality of these two fluxes implies that *something* is adding or taking away muon neutrinos within the Earth. The dominant candidate for the culprit is neutrino oscillation. Since the upward neutrinos come from more distant parts of the atmosphere than the downward ones and consequently have more time to oscillate, the upward muon neutrinos can oscillate away into neutrinos of another flavor, while the downward ones simply do not get the chance. This mechanism would explain why fewer muon neutrinos are observed going upward than downward. From upper limits on the oscillation of electron neutrinos generated by nuclear reactors, we know that the oscillating atmospheric  $\nu_\mu$  are not (or at least not appreciably) turning into  $\nu_e$ . Thus they must be turning into  $\nu_\tau$ —or perhaps into some new kind of neutrino not seen before. High-precision experiments at CERN and SLAC have taught us that only three species of neutrinos— $\nu_e$ ,  $\nu_\mu$  and  $\nu_\tau$ —interact with matter through the weak nuclear force. Consequently, any new, fourth kind of neutrino

*The Super-Kamiokande detector during filling in 1996. Physicists in a rubber raft are polishing the 20-inch photomultipliers as the water slowly rises. (Courtesy ICRR, University of Tokyo)*



would be even more of a ghost, since it would not interact with matter through *any* known force save gravity. Such a neutrino is called a “sterile” neutrino,  $\nu_s$ .

The hypothesis that the atmospheric muon neutrinos are oscillating into tau neutrinos fits a host of data—including the detailed dependence of the  $\nu_\mu$  flux on the direction

from which the neutrinos are coming—extremely well. The Super-Kamiokande results are supported by those of the MACRO experiment in the Gran Sasso underground laboratory in Italy, and by those of the Soudan-2 experiment in the Soudan mine in Minnesota. The neutrino squared-mass splitting  $\delta M^2$  required by the data is approximately  $0.003 \text{ eV}^2$ . This value allows neutrinos with typical atmospheric neutrino energies to oscillate significantly if they travel upward to the detector from the other side of the Earth, but not if they travel downward from just above.

The neutrino mixing required by the atmospheric oscillation data is quite large. That is, a  $\nu_\mu$  is a superposition of mass eigenstates in which no single one of them dominates. Rather, the  $\nu_\mu$  is an almost 50–50 mixture of two mass eigenstates. And while it is still possible that some of the atmospheric  $\nu_\mu$  are oscillating into sterile neutrinos, Super-Kamiokande analyses tell us that no more than 25 percent of them are doing so. Oscillation into tau neutrinos is the favored path.

Compelling as the evidence for atmospheric muon neutrino oscillation is, one would like to confirm this observation by showing that muon neutrinos produced by a particle accelerator also undergo the same oscillation. Several experiments aim to do just that, and one of them, K2K, has already reported preliminary results (see article by Koichiro Nishikawa and Jeffrey Wilkes, this issue). These results are not yet conclusive, but they do seem to indicate that muon neutrinos are oscillating into something else.

**A**N INDEPENDENT strong piece of evidence for oscillation is the behavior of solar neutrinos, which are generated in huge numbers by the nuclear reactions that power the Sun. At birth, all of these neutrinos are electron neutrinos, since they are created in association with electrons (or, more precisely, positrons). Solar neutrinos have been detected here on Earth by several underground detectors, all of which are sensitive largely—or exclusively—to electron neutrinos. Interestingly, all these detectors report solar neutrino fluxes that are only 30 to 60 percent of those expected from the theoretical calculations of neutrino production in the Sun. Valiant attempts to modify the theory of the Sun, without invoking neutrino mass or oscillation, have been notably unsuccessful in explaining this deficit. Hence, it has been hypothesized that the deficit is caused by the oscillation of electron neutrinos into another, hard-to-see flavor. Perhaps this oscillation is occurring in outer space between the Sun and the Earth. Or perhaps a matter-enhanced neutrino oscillation, known as the Mikheyev-Smirnov-Wolfenstein (MSW) effect after the theorists who first explored its physics, is occurring within the Sun itself as the neutrinos produced by the solar core stream outward. Either way (if we neglect the possibility of sterile neutrinos),  $\nu_\mu$  or  $\nu_\tau$  (or both) are eventually produced. To confirm that the solar neutrinos are undergoing oscillation, one would therefore like to verify that  $\nu_\mu$  or  $\nu_\tau$ , which are not being forged in the solar furnace, are nevertheless arriving here on Earth from the Sun.

This past June, the Sudbury Neutrino Observatory (SNO) reported a new result that, when compared to an earlier Super-Kamiokande result, implies that  $\nu_\mu$  or  $\nu_\tau$  are indeed arriving here from the Sun! The SNO collaboration has succeeded in measuring the solar  $\nu_e$  flux arriving at Earth, independently of whether any other flavors of neutrinos might be

*The heart of the solar neutrino detector operated by Brookhaven/University of Pennsylvania chemist Raymond Davis and his collaborators. The vessel contains about 615 tons of perchlorethylene and is located almost a mile underground in the Homestake Gold Mine in Lead, South Dakota. (Courtesy Brookhaven National Laboratory)*





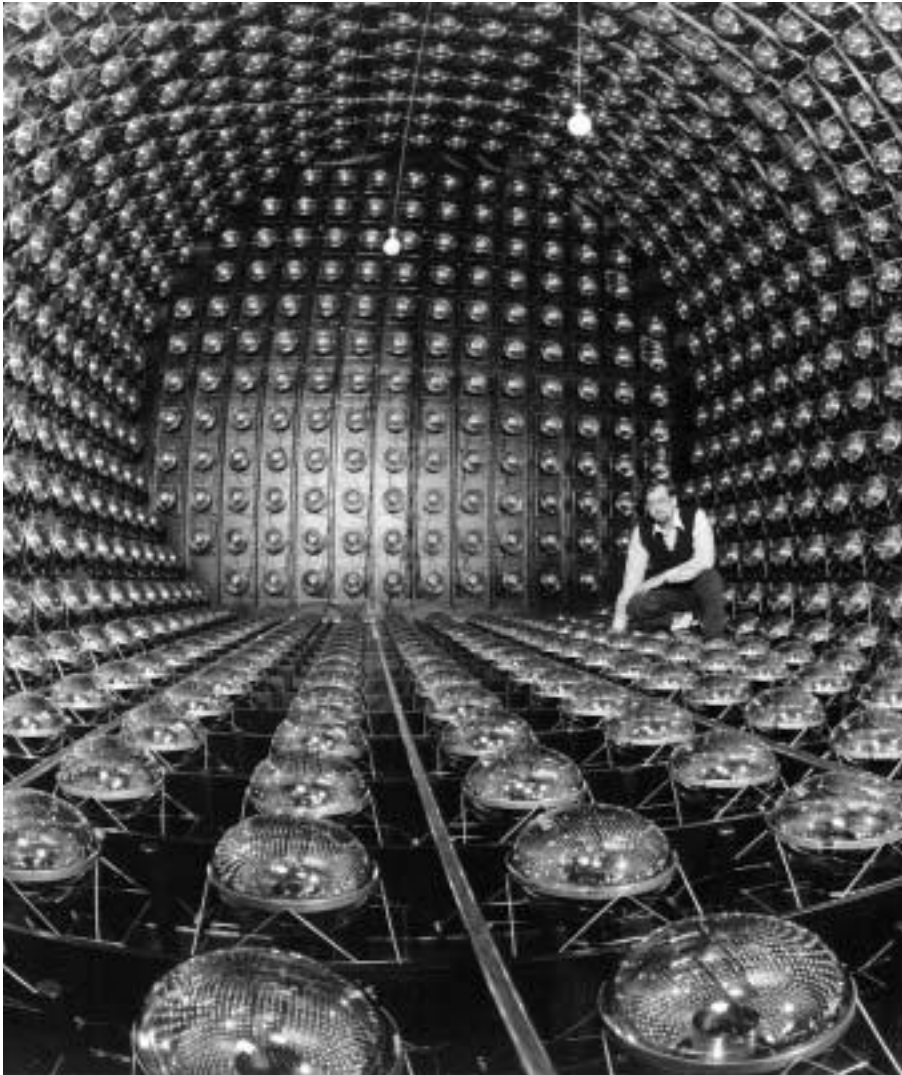

*The LSND experiment was designed to search for the presence of electron antineutrinos. Over 1200 photomultiplier tubes line the inner surface of the mineral oil tank, shown above with LSND physicist Richard Bolton of Los Alamos. (Courtesy Los Alamos National Laboratory)*

arriving as well (see article by Joshua Klein, this issue). In contrast, the earlier Super-Kamiokande result (from the same detector that studied the atmospheric neutrinos) measured this same  $\nu_e$  flux plus an admixture of one-sixth of the  $\nu_\mu$  and  $\nu_\tau$  fluxes arriving from the direction of the Sun. By subtracting from this total the  $\nu_e$  flux measured by SNO, physicists can extract the  $\nu_\mu + \nu_\tau$  flux. They find that, at a strong—albeit not yet completely conclusive—level of confidence, the  $\nu_\mu + \nu_\tau$  flux arriving at Earth from the Sun is not zero. This is an important result.

The neutrino squared-mass splitting  $\delta M^2$  required by the solar-neutrino data falls somewhere between  $10^{-11} \text{ eV}^2$  and  $10^{-4} \text{ eV}^2$ , depending on whether or not the MSW effect is involved. Either way, the splitting is

smaller than what is called for by the atmospheric-neutrino oscillation. This means that the solar oscillation does not involve the same two neutrino mass eigenstates. To a certain extent, the solar-neutrino data suggest that the MSW effect is indeed involved, that  $\delta M^2$  falls in the range  $10^{-5} \text{ eV}^2$  to  $10^{-4} \text{ eV}^2$ , and that the neutrino mixing that is playing a role is large—like its analogue in the atmospheric-neutrino oscillation.

The MSW effect, like neutrino oscillation in empty space, requires neutrino mass. Thus, whether or not the solar  $\nu_e$  are turning into  $\nu_\mu$  or  $\nu_\tau$  through the MSW effect, the observation that they are also undergoing a metamorphosis is another powerful piece of evidence that neutrinos indeed have masses.

**T**HERE IS A THIRD piece of evidence that neutrinos oscillate, but it is unconfirmed. This evidence comes from the Liquid Scintillator Neutrino Detector (LSND) experiment at Los Alamos, which has recorded the appearance of electron antineutrinos in a neutrino beam produced via the decays of positively charged muons. As these decays do not yield electron antineutrinos directly, their appearance has been interpreted as resulting from the oscillation of the muon antineutrinos that  $\mu^+$  decays do create.

The squared-mass splitting demanded by the reported LSND oscillation is around  $1 \text{ eV}^2$ , much larger than what is called for by the atmospheric and solar oscillations, which gives rise to an interesting situation. Suppose there are only three different flavors of neutrino:  $\nu_e$ ,  $\nu_\mu$ ,

and  $\nu_\tau$ . Then there are only three corresponding neutrino mass eigenstates:  $\nu_1$ ,  $\nu_2$ , and  $\nu_3$ . To accommodate the solar and atmospheric oscillations, the neutrino squared-mass spectrum must be as pictured in the illustration on the right. There must be a closely-spaced pair of neutrinos we shall call  $\nu_1$  and  $\nu_2$ , whose splitting  $\delta M_{\text{solar}}^2$  is the small one called for by the solar data. This pair must be separated from the third eigenstate,  $\nu_3$ , by the bigger splitting  $\delta M_{\text{atm}}^2$  required by the atmospheric data. Since both  $\delta M_{\text{solar}}^2$  and  $\delta M_{\text{atm}}^2$  are much smaller than  $1 \text{ eV}^2$ , this three-neutrino spectrum cannot include any pair of neutrinos whose splitting is the large  $1 \text{ eV}^2$  demanded by LSND. No three-neutrino spectrum that fits both the solar and atmospheric oscillations can also fit the LSND oscillation. If the LSND oscillation is confirmed by future experiments, then Nature must contain at least *four* different kinds of neutrinos. As Nature contains only three kinds of neutrinos that interact with matter via the weak nuclear force, any additional kinds would have to be of the almost totally non-interacting sterile variety. Thus, it is very interesting, to say the least, to find out whether the oscillation reported by LSND is genuine.

**N**OW THAT physicists have ascertained that neutrinos almost certainly have nonzero masses, there are some major questions we would like to see answered:

- How many different neutrino flavors are there in all? Just  $\nu_e$ ,  $\nu_\mu$  and  $\nu_\tau$ ? These three plus one sterile flavor? These three plus *many* sterile

flavors? Equivalently, how many different neutrinos of definite mass—that is, mass eigenstates—are there?

- What are the masses of these eigenstates? From neutrino oscillation experiments, we already know something about the squared-mass splittings between the different eigenstates, but what are their individual masses?

- Is each neutrino mass eigenstate identical to its antiparticle, as is a photon, or distinct from it like an electron?

Alone among all the spin-1/2 constituents of matter—the quarks and leptons—neutrinos may be their own antiparticles. No quark or charged lepton can be identical to its antiparticle because it is electrically charged, so its antiparticle must be oppositely charged. However, a *neutral* lepton—that is to say, a neutrino—is electrically neutral and as far as we know does not carry any other charge-like attribute either. Thus, a neutrino could well be identical to its antiparticle.

An important question is whether the properties of neutrinos are related in a deep way to the fact that we exist. That existence depends on the fact that the Universe contains nucleons and electrons—the particles of which we are made—but very few of the corresponding antiparticles. That is, the Universe currently contains far more matter than antimatter. Since the Big Bang presumably produced equal amounts of matter and antimatter, the present asymmetry must have arisen after the Big Bang. But for this to have occurred, matter particles and their corresponding antiparticles must behave differently, at least under

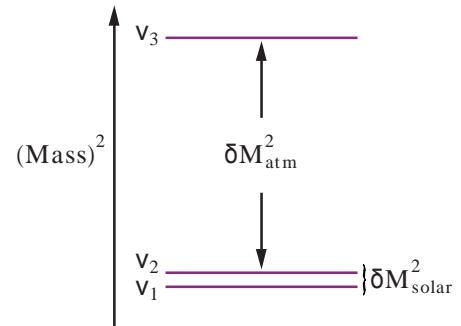

*A three-neutrino (Mass)<sup>2</sup> spectrum that can accommodate both the solar and atmospheric neutrino oscillations. An equally possible spectrum places the closely-spaced pair of neutrinos at the top rather than at the bottom.*

*Thanks to the  
dramatic discoveries  
of the past few years,  
we now know that  
there is a rich world  
of massive neutrinos  
waiting to be explored,  
but we have only begun  
to explore it.*

certain conditions. Otherwise, a matter-antimatter symmetrical Universe would have remained that way. One possibility is that there was a time in the early Universe when electrons were produced more copiously than positrons by the decays of some very heavy parent particles. Subsequently, the electrons participated in processes that created nucleons but not antinucleons.

If indeed there was an early epoch in which electrons were produced more abundantly than positrons, then neutrinos may exhibit related behavior. For example, it may be that the probability for an antineutrino to oscillate is different from that for the corresponding neutrino. If so, this would be a clear difference between the behavior of antimatter and that of matter. Any such difference would be extremely interesting to observe.

Essentially this same difference can still occur even if a neutrino and its antineutrino are the same particle. If so, an interacting neutrino whose spin is antiparallel to its momentum will make a charged lepton ( $e^-$ ,  $\mu^-$ , or  $\tau^-$ ), while one whose spin is parallel to its momentum will make an *antilepton* ( $e^+$ ,  $\mu^+$ , or  $\tau^+$ ). The oscillation patterns of the lepton- and antilepton-producing neutrinos can differ. If they do, we will once again have a distinction between the behavior of matter and that of antimatter.

The biggest question of all about the neutrinos is: What is the underlying physics responsible for the neutrino masses, mixings, and other properties? And is this physics also responsible for the masses of the charged leptons and quarks, or can it only be glimpsed by studying the neutrinos?

The most popular explanation of the fact that the neutrinos are so much lighter than the charged leptons and quarks is called the “see-saw mechanism.” This mechanism can apply only to the neutrinos—it cannot be the physics behind the masses of quarks or charged leptons. The see-saw mechanism requires that the neutrinos are their own antiparticles. It predicts that a typical neutrino will have a mass of order  $M_{\text{quark}}^2/M_{\text{Big}}$ . Here  $M_{\text{quark}}$  is a typical quark (or charged lepton) mass, and  $M_{\text{Big}}$  is a very large mass far beyond the reach of present-day accelerators. The new physics responsible for the neutrino masses and other phenomena supposedly resides at the high, presently-inaccessible mass scale represented by  $M_{\text{Big}}$ . Obviously, the bigger  $M_{\text{Big}}$  is, the smaller the neutrino mass  $M_{\text{quark}}^2/M_{\text{Big}}$  will be. Hence, the name “see-saw mechanism.”

**H**OW CAN WE answer all these neutrino questions? The evidence that there are more than three neutrinos is the neutrino-oscillation signal observed by the LSND experiment. A similar

experiment known as KARMEN, carried out at the Rutherford Laboratory in England, does not see any such oscillation. However, the two experiments have different sensitivities and are not necessarily in conflict. To find out whether or not the LSND oscillation signal is genuine, an experiment known as BoONE, presently under construction at Fermilab, will be carried out (see article by Paul Nienaber, this issue).

The splittings  $\delta M^2$  among the different neutrino eigenstates will be determined through a broad program of neutrino-oscillation studies. Together, these splittings will tell us the  $M^2$  spectrum, but not its baseline. Determining this baseline—that is, the absolute scale of neutrino mass—will not be easy. One approach will be to study very carefully the high-energy end of the electron energy spectrum in tritium beta decays:  ${}^3\text{H} \rightarrow {}^3\text{He} + e^- + \nu_m$ . Here,  ${}^3\text{H}$  is the nucleus of a tritium atom (one proton plus two neutrons),  ${}^3\text{He}$  is the nucleus of a helium-3 atom (two protons plus one neutron), and  $\nu_m$  ( $m = 1, 2, 3, \dots$ ), is any one of the neutrino mass eigenstates. Through the kinematics of these decays, the masses of the neutrinos  $\nu_m$  will be reflected in the energy spectrum of the electron. However, this effect will be experimentally invisible unless at least one  $\nu_m$  has a mass big enough to be within range of the mass sensitivity of the experiment, and this particular  $\nu_m$  is emitted in a substantial fraction of all the tritium decays.

A tritium experiment sensitive to neutrino masses as small as 0.3 eV is now in the planning stages. Known as KATRIN, it will be performed in



Karlsruhe, Germany. If the LSND neutrino oscillation is genuine, then the LSND data tell us that there are two definite-mass neutrinos,  $\nu_m$  and  $\nu_n$ , separated from one another by  $\delta M_{mn}^2 = M_m^2 - M_n^2 > 0.2 \text{ eV}^2$ . It follows that  $M_m$ , the mass of  $\nu_m$ , is no smaller than 0.4 eV, which is within range of the experiment.

It is amusing that the search for the absolute scale of neutrino mass brings us back to take a very detailed look at the energy spectra in nuclear beta decay. It was the observation that these spectra are continuous, rather than discrete, that originally led Pauli to propose the existence of neutrinos!

To test whether the electron neutrino is identical to its antiparticle, we can search for neutrinoless double beta-decay—in which one nucleus decays into another with the emission of *two* electrons, and nothing else. Since there are no electrons before the decay, and two electrons after it, such a process clearly does not conserve the hypothetical, charge-like “lepton number” that would distinguish charged and neutral leptons like  $e^-$  and  $\nu_e$  on the one hand from charged and neutral antileptons like  $e^+$  and  $\bar{\nu}_e$  on the other hand. Indeed, the occurrence of this decay would indicate that  $\bar{\nu}_e = \nu_e$ , so that there is no conserved lepton number to distinguish leptons from their antiparticles. Several groups around the world are hoping to carry out sensitive searches for this potentially very informative decay. In principle, these searches could yield a bonus: The rate for neutrinoless double beta-decay depends, albeit in a nontrivial way, on the absolute scale of neutrino mass. Thus the

observation of this process would yield information about this scale. The proposed searches should be sensitive to a mass scale an order of magnitude smaller than the planned tritium experiment can reach.

To probe the possible connection between neutrinos and our existence, we will need very intense neutrino beams produced by accelerators. These beams will probably have to be “bright” enough to remain relatively intense even after traveling several thousand kilometers to a distant detector. Then it will be possible to use them to see whether neutrino oscillations depend on whether the neutrinos in the beam are of the kind that produce particles of matter or of the kind that produce particles of antimatter.

**A**S FOR the *big* question—what’s behind it all—who can say how we will answer that? The answer may include ingredients presently being considered, and it may well include physics that nobody has yet dreamed of.

Thanks to the dramatic discoveries of the past few years, we now know that there is a rich world of massive neutrinos waiting to be explored, but we have only begun to explore it. Major, fundamental questions about the neutrinos need to be answered. To attempt to answer them, a diverse experimental program will occur in the coming years. This program will include experiments on accelerator-generated neutrinos that travel to both near and far detectors, and others on neutrinos produced by tritium decay, nuclear reactions in power plants, cosmic rays, the Sun, and perhaps supernova explosions. It will also entail

searches for neutrinoless double beta decay and astrophysical studies of the neutrinos that, eons ago, helped shape the Universe that we see today. If the recent past is any guide, this future exploration of the enigmatic world of neutrinos will be very exciting indeed.



# The K2K Neutrino Experiment

by KOICHIRO NISHIKAWA & JEFFREY WILKES

*The world's first  
long-baseline  
neutrino experiment  
is beginning  
to produce results.*

**T**HREE YEARS AGO, it was already evident that our standard picture of neutrinos needed work. Unexpected shortfalls in the fluxes of solar and atmospheric neutrinos were not about to go away; these deficits had primed many physicists to accept the clear evidence for neutrino mass that the Super-Kamiokande Collaboration presented in 1998. But the Super-Kamiokande results indicated only that at least one kind of neutrino indeed has mass. Many other questions remain unanswered. What is the complete pattern of neutrino masses? How are the three known kinds of neutrinos connected to the mass eigenstates? Do we really need a fourth neutrino, which would have to be “sterile”? And how does the new information fit within the framework of the Standard Model, which has worked so well for us for so long?

The next steps are to confirm and extend the Super-Kamiokande results and then try to map out, at least in outline, the pattern of neutrino masses. Groups in the United States, Europe and Japan are now working to develop the neutrino beams and detectors needed for this next generation of neutrino experiments, in which beams of well-known composition are directed over a distance of hundreds of kilometers from an accelerator to a remote neutrino detector. One group, however, has a big head start on the others. Since 1999, the K2K (KEK to Kamioka) experiment, the world's first long-baseline neutrino experiment to begin operations, has slowly but surely been logging data.

# Experiment

## PREHISTORY OF THE EXPERIMENT

In the early 1980s, underground water Cerenkov detectors were built in Japan and the United States by Masatoshi Koshiba, Frederick Reines, and others to search for nucleon decay. A few thousand tons of water contained the requisite nucleons, and the water itself also served as the track-sensitive medium, generating Cerenkov light from relativistic particles. To reduce cosmic ray backgrounds to manageable levels, the detectors had to be located deep within the earth in underground mines. Kamiokande (Kamioka Nucleon Decay Experiment), built in the Kamioka-Mozumi mine in the Japanese Alps, was essentially a 10 m diameter by 10 m tall cylindrical tank of ultra-pure water, viewed by hundreds of large photomultiplier tubes (PMTs). The IMB (Irvine-Michigan-Brookhaven) experiment, built in the Morton Salt mine under Lake Erie, near Cleveland, had a similar arrangement, with a cubic tank of water about 10 m on a side. Neither experiment found convincing evidence for nucleon decay, but they were fortunately sensitive to neutrinos from extraterrestrial sources.

Thus nucleon-decay seekers became astrophysical neutrino observers, and found plenty to write home about. Previous solar neutrino observations, conducted by Ray Davis and collaborators since 1967 at the Homestake gold mine in South Dakota, had reported a significant deficit compared to theoretical predictions. The Kamiokande and IMB experiments confirmed this result and added a new puzzle to the picture. While the Homestake experiment was insensitive to high-energy neutrinos, the two water Cerenkov detectors could easily observe neutrinos created in the upper atmosphere by cosmic rays. But the experimental observations of these “atmospheric” neutrinos fell well short of theoretical expectations, adding another deficit to the growing list of neutrino puzzles.



It became clear that a new, much larger detector could be of great value in solving both the solar and atmospheric neutrino puzzles. Thus Yoji Totsuka and collaborators began planning the next-generation detector called Super-Kamiokande, even as the original experiments continued collecting data. Super-Kamiokande was designed on a truly gargantuan scale, with a 40 m diameter, 40 m tall cylindrical tank holding 50,000 tons of water that is monitored by over 11,000 giant phototubes, each 50 cm in diameter (see photo on page 36 and drawing below). To construct and operate such a huge detector required pooling resources, so members of both the Kamiokande and IMB groups joined forces.

The two groups each brought their own independent ideas and approaches to the experiment. When Super-Kamiokande began taking data

in April 1996, two separate analysis groups began to reduce the data and provide independent checks upon one another. One group took as its starting point the analysis methods and software from IMB, and the other from Kamiokande. Such careful procedures helped ensure the prompt acceptance of Super-Kamiokande results by the physics community.

By June 1998, collaboration members had enough data and confidence in their analyses to present a truly historic result at the Neutrino-98 Conference, held in nearby Takayama, Japan: the first convincing evidence for neutrino oscillations, which emerged from their atmospheric neutrino data (see John Learned's article in the Winter 1999 issue of *Beam Line*, Vol. 29, No. 3). Distributions of neutrino flux versus incidence angle showed a clear deficit (relative to expected fluxes) for upward-going muon neutrinos coming from the other side of the Earth, while downward-going muon neutrinos (and all electron neutrino distributions) agreed with theoretical predictions. The difference could not be explained by the fact that upward-going neutrinos had to pass through a lot more matter, since the Earth is essentially transparent to these neutrinos. But the deficit *could* be explained by neutrino oscillations, since the upward-going neutrinos must have trekked 10,000 km or so from their point of birth, while downward-going neutrinos traveled only 15 or 20 km. In fact, the hypothesis that particles produced as muon neutrinos oscillate into tau neutrinos fits the data very well, since the Super-Kamiokande detector cannot efficiently identify tau neutrinos—

Artist's conception of the Super-Kamiokande detector.

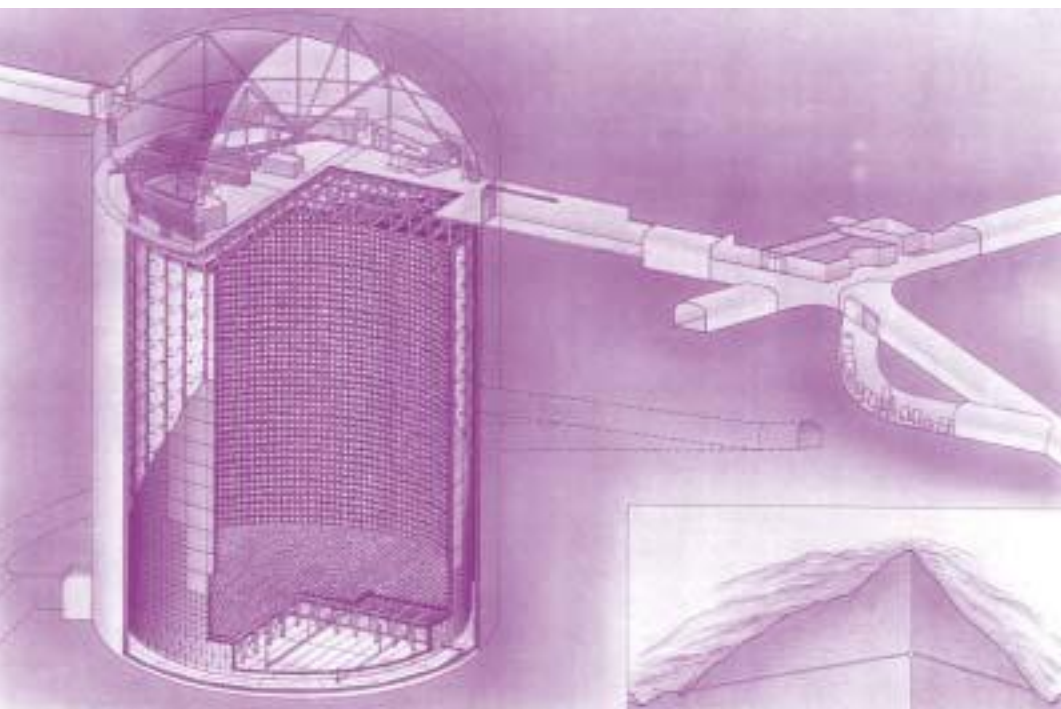

leading to an apparent deficit of muon neutrinos. Such oscillations can occur only if at least one of these neutrinos has mass.

## HISTORY OF K2K

The idea of directing a neutrino beam toward a distant detector had long been discussed by Koshiba, Reines, Al Mann, and others. Until recently, however, the high cost of constructing a far detector as well as a new, downward-directed beam line at any suitable accelerator was prohibitive. But Super-Kamiokande could serve as a perfect detector for a neutrino beam from KEK, the Japanese national particle-physics laboratory at Tsukuba, 150 miles from Tokyo. The 12 GeV proton synchrotron at KEK could produce a neutrino beam with the energy range required to test the oscillation parameters suggested by the early Kamiokande results; a relatively modest 1 degree downward angle was required for this beam. And many components of past experiments could be recycled to build a near detector on the KEK site, to sample the outgoing neutrino beam. In particular, a 1000-ton water tank was already available, as well as a muon detector system (iron plates and proportional tubes) and a lead-glass detector. The only major equipment needed was a scintillating-fiber tracking detector plus new photo-multiplier tubes for the water tank. The KEK synchrotron was steadily upgraded, and a significant increase in its luminosity was achieved. Bending magnets on loan from SLAC were used to bend the primary proton beam about 90 degrees into the orientation needed to direct the neutrino

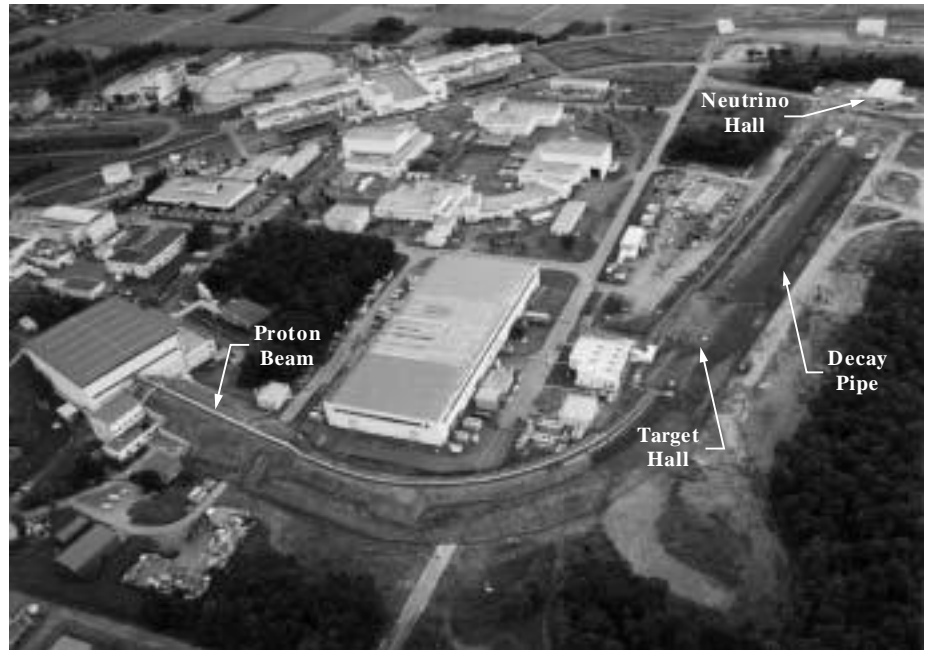

beam toward Super-Kamiokande (see photo above).

With remarkable rapidity, plans for the K2K experiment were approved in 1995. It was organized as a scientific collaboration distinct from Super-Kamiokande, although there is substantial overlap in membership. Civil construction of the neutrino beam line and experimental hall began in 1996, with an extremely tight project timeline. This was especially true when KEK was a prime contender to be the future site of the Japan Hadron Facility (now officially named the High Intensity Proton Accelerator Facility), which would have required upgrading the proton synchrotron from 12 to 50 GeV and left K2K only two years of running time. The decision to site the facility at Tokai relieved much of this pressure—but only after the construction and commissioning phases were completed.

*Aerial view of the KEK neutrino beam line. The extracted 12-GeV proton beam enters at left, goes through a 90-degree bend and then enters the target hall. Neutrinos from the 200 m decay pipe pass through the neutrino hall at right before heading toward Super-Kamiokande.*

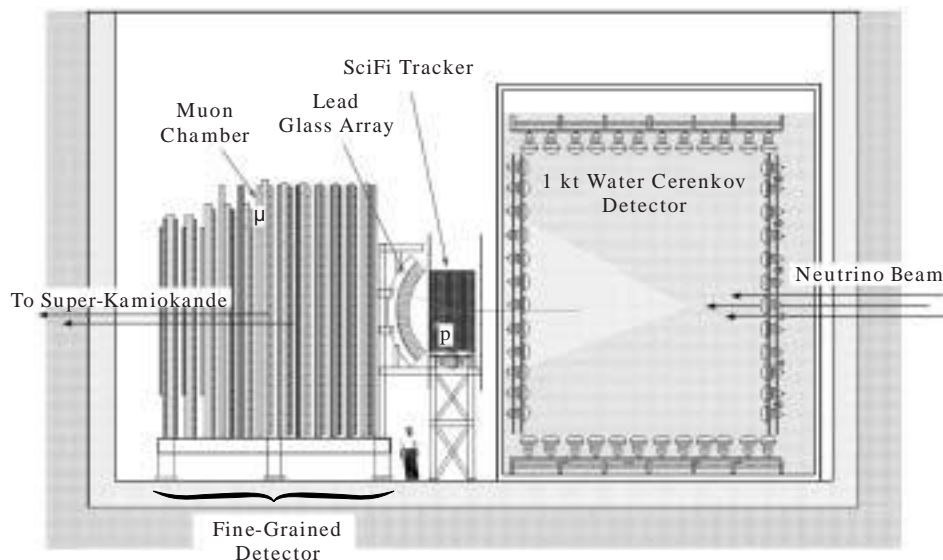

*Schematic view of the K2K near detectors, showing (right to left) the 1 kiloton water Cerenkov detector, the SciFi tracker, lead-glass array, and the muon detector.*

Civil construction was rapidly completed, and experimental areas became available to scientists by the summer of 1998. All beam line and target area components were quickly installed and tested. Meanwhile, the experimenters took a few months to install the detector elements in the new Neutrino Hall, a cylindrical pit 24 m in diameter located about 300 m downstream of the production target. Filling the tank and water purification began in December 1998, with commissioning of other detector elements completed during the next few months.

Tuning of the neutrino beam began in early 1999, followed by a series of engineering runs to test the beam and near detectors together. The 20 millimeter diameter aluminum target used to produce neutrinos failed mechanically under the severe thermal stresses and was replaced by a 30 millimeter target, which meant that the neutrino intensity is a bit lower than originally

designed. Thus K2K may take longer to reach its experimental goals. The shakedown process was completed by April 1999, and data-taking runs began in earnest. Since then, K2K has been operating for about six months a year, as the accelerator is shut down during the summer months and other experiments take beam in the autumn.

### THE K2K BEAM LINE

K2K uses a fairly conventional wide-band neutrino beam design. The primary beam is composed of 12 GeV (kinetic energy) protons from the KEK proton synchrotron. Every 2.2 seconds, approximately 6 trillion protons are extracted and focused onto a 66 cm long aluminum target. A double-horn magnet system focuses positive pions produced by  $p$ -Al collisions, while sweeping negative secondary particles out of the beam line. Between the horn system and the 200 m long decay volume (where the  $\pi^+$  decay to  $\nu_\mu$  and  $\mu^+$ ) the pion monitor—a gas-Cerenkov detector of novel design—is periodically inserted in the beam to measure the pion kinematics before they decay. With these kinematic distributions known, it is possible to predict the neutrino spectrum at any distance from the source.

Following the decay volume, an iron-and-concrete beam dump filters out essentially all charged particles except muons with energy greater than 5.5 GeV. Downstream of the dump there is a muon monitor system, which measures the residual muons to check beam centering and muon yield. Steering and monitoring of the neutrino beam are carried out



based on data from this system. The  $\nu_\mu$  and  $\mu^\pm$  in the decay volume originate from the same pion decays, so the measured central position of the muon profile is well correlated with the neutrino beam direction. The beam line was aligned by an engineering survey using the Global Positioning System (GPS) to determine the line from the target to the Super Kamiokande far detector to better than 0.01 mrad; the construction precision for the beam alignment is better than 0.1 mrad, which is much better than required.

### THE NEAR DETECTOR

The near detector array (see illustration on opposite page and photograph at right) is located in an underground experimental hall about 300 m from the pion production target, after an earth berm about 70 m thick that eliminates virtually all prompt beam products other than neutrinos. The one kiloton (1 kt) water Cerenkov detector uses the same techniques and analysis algorithms as the far detector, with 680 20-inch diameter hemispherical PMTs lining a cylindrical volume 8.6 m in diameter and 8.6 m high. Because this detector has the same target material, PMTs, and basic geometry as Super-Kamiokande and uses the same event identification and analysis methods, many potential biases and systematic errors cancel between the two detectors. Thus the 1 kt detector is the primary source of data on neutrino event rates at the near site. A beam simulation based on these data is then used to estimate the expected  $\nu_\mu$  signal at the far detector. Other components of the

near detector provide independent checks on the event rates, as well as supplementary data on interactions and rates.

Following the 1 kt detector, the scintillating-fiber detector (SciFi)

*View from ground level into the Neutrino Hall at KEK, showing near detector components: 1 kiloton detector (at top in this view); SciFi tracker; lead-glass array; and muon detector (bottom).*

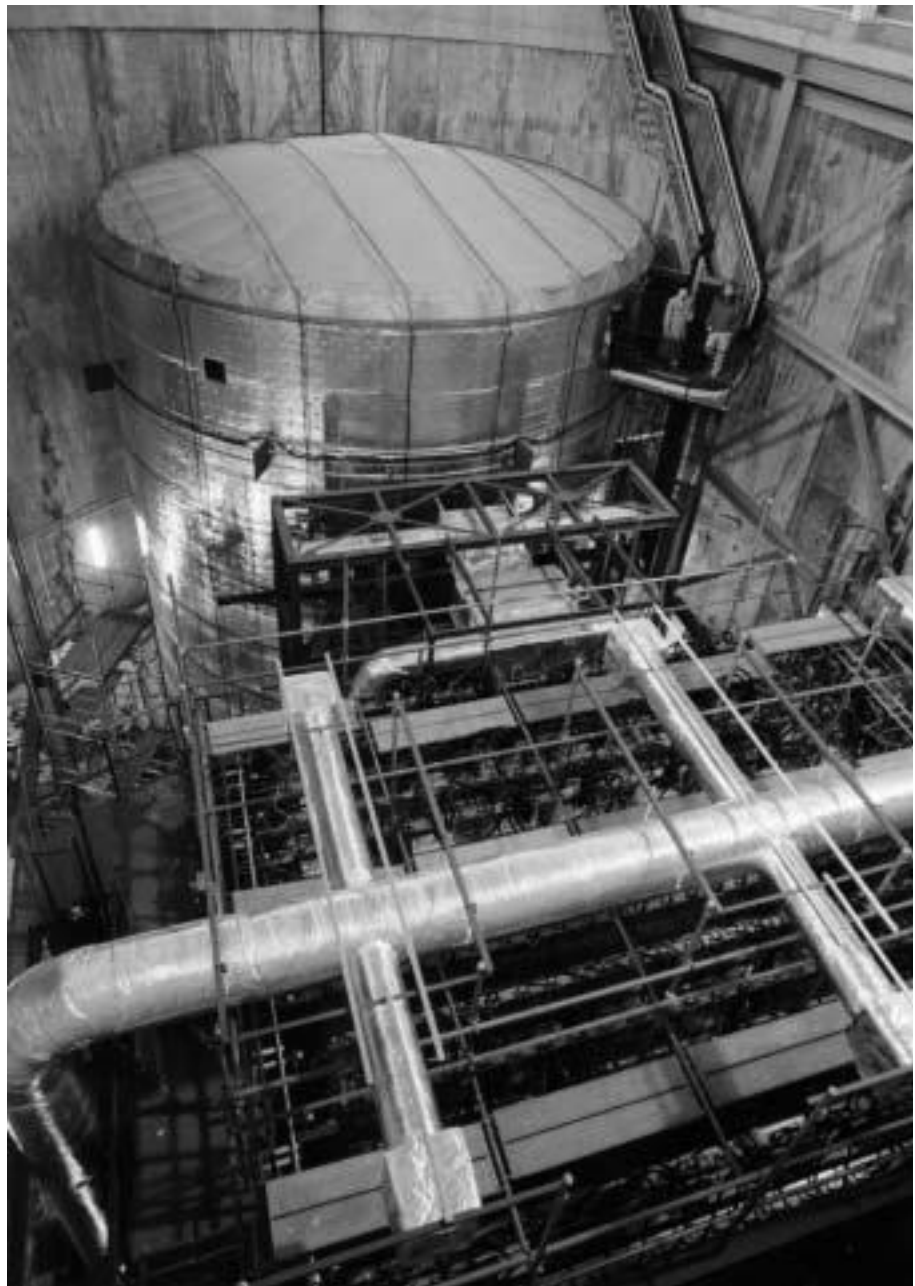

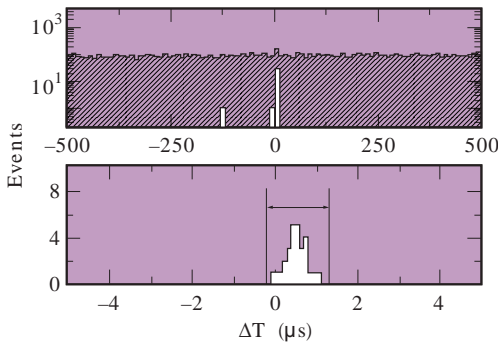

*Top plot:  $\Delta T$  distribution over a  $\pm 500 \mu\text{sec}$  window for events remaining a) after requiring that the total collected charge in a 300 nsec time window is equivalent to more than 20 MeV deposited energy (hatched area); b) after all cuts except timing (white bars). Bottom plot:  $\Delta T$  distribution over a  $\pm 5 \mu\text{sec}$  window for events that originate in the fiducial volume of Super-Kamiokande.*

provides detailed tracking capability, and allows identification of different types of interactions such as quasi-elastic or inelastic scattering. It consists of 19 planes of water target tanks, interleaved with scintillating fiber modules. Downstream of the SciFi detector is the lead-glass array, for tagging electromagnetic showers. The muon detector then measures the energy, angle, and production point of muons from charged-current neutrino interactions. The characteristics and stability of the  $\nu_\mu$  beam are directly monitored at the near site by this detector, whose large transverse area and mass make it possible to measure the beam direction, stability, and intensity profile over a reasonable angular range. The neutrino beam direction has been stable within  $\pm 1$  mrad throughout all data-taking periods.

## PRESENT RESULTS

The basic strategy in a long baseline experiment is to sample the beam at a near detector, thus determining its characteristics before any oscillation effects can occur. Then one uses these observations to determine the expected beam characteristics at the far detector in the absence of oscillations. We use a beam simulation to make this extrapolation; it is validated by comparing its predictions with the pion monitor measurements in the beam line, before the decay volume. The agreement between the simulation and the pion monitor data has been excellent.

Candidate events observed in Super-Kamiokande must be synchronized with the arrival of protons at the production target at KEK,

allowing for the 250 km flight path. Duplicate GPS clock systems are used at the near and far sites to generate time data with 20 nanosecond precision. Beam-induced neutrino interactions at Super-Kamiokande are selected by comparing these two independent time measurements,  $T_{\text{KEK}}$  for the starting time of the KEK beam spill, and  $T_{\text{SK}}$  for the Super-Kamiokande event-trigger times. The time difference  $\Delta T = T_{\text{SK}} - T_{\text{KEK}} - \text{TOF}$ , where TOF is the time of flight at the speed of light between the near and far detectors, should be distributed within an interval of  $1.1 \mu\text{sec}$ , matching the duration of the proton beam spill at KEK. Using a conservative 200 nanosecond estimate of the synchronization accuracy between the two sites, we establish a  $1.5 \mu\text{sec}$  long time interval inside which candidate neutrino interactions must occur. All neutrino events occurring within the time window are carefully examined. Cuts and analysis procedures similar to those used in atmospheric neutrino analyses in Super-Kamiokande are applied to select events that are fully contained within the same 22.5 kiloton fiducial volume. The fiducial-volume and timing cuts have a powerful effect in separating beam-induced events from cosmic-ray and other background events (see graph on this page).

Up until April 2001, 44 fully-contained beam-induced neutrino events were observed in Super-Kamiokande. This number should be compared with the number of events expected in the absence of any neutrino oscillations, which is 60–68 events based on the number of neutrino interactions observed in the

1 kt near detector. The expected numbers of Super-Kamiokande events based on analyses of interactions in the other near detectors are consistent with this value. These results so far are consistent with the oscillations of muon neutrinos into some other kind of neutrino, as reported by the Super-Kamiokande experiment, but more events are needed before the K2K experiment can claim to have reached definitive conclusions to this question.

## FUTURE PLANS

It will take another two years to achieve the original K2K goal, which was to provide a statistically significant test of neutrino oscillations in a long-baseline experiment. It appears likely that the experiment will have time to accumulate at most a few hundred events in Super-Kamiokande before the KEK synchrotron is shut down in 2005. This number is sufficient to provide improved confidence limits on oscillation parameters, which will give valuable guidance for future long-baseline experiments. Meanwhile, KEK and the Japan Atomic Energy Research Institute will be jointly building a very high-intensity proton accelerator in Tokai, scheduled for completion in 2006. After K2K ends, our physics goals will move from exploratory to precision measurements of the two sets of  $\Delta m^2$  and mixing angles (representing the squared-mass difference and the degree of mixing between each pairwise combination of the three underlying neutrino-mass states). A next-generation experiment using the Tokai accelerator will again use

Super-Kamiokande as the far detector, this time about 300 km distant from the production target. Narrow-band neutrino beams will be used, with mean energy below 1 GeV—an energy range well matched to the detection efficiency of Super-Kamiokande.

With such a neutrino beam, we should be able to achieve the following goals:

- Observations of muon neutrino disappearance will allow the parameter  $\Delta m_{\mu x}^2$  for  $\nu_\mu \rightarrow \nu_x$  oscillations to be determined with an accuracy of  $10^{-4}$  eV<sup>2</sup> in one year; a 1 percent measurement of the corresponding mixing parameter can be obtained in five years.

- Although recent results from Super-Kamiokande and SNO make the existence of sterile neutrinos seem unlikely, observations of neutral-current neutrino interactions will allow improved limits to be set on possible sterile neutrino contributions.

- The possibility of neutrino decay can be definitely tested by searching for a clear dip in the  $\nu_\mu$  disappearance rate as a function of energy.

Measurement of CP violation in the lepton sector may even be feasible, but it will require a much larger far detector, with mass of about a megaton. There are no fundamental engineering showstoppers, and the design of a megaton detector (dubbed “Hyper-Kamiokande”) is currently under study. The discovery of CP violation in the lepton sector, and a great improvement of limits on—or the possible observation of—proton decay may finally reveal the secret of the baryon-antibaryon asymmetry in the Universe. ○

## For Further Information

To learn more about the K2K and Super-Kamiokande experiments, go to:

Official K2K home page:  
<http://neutrino.kek.jp/>

K2K FAQ (for the layman):  
[http://www.phys.washington.edu/~superk/k2k/k2k\\_faq.html](http://www.phys.washington.edu/~superk/k2k/k2k_faq.html)

Super-Kamiokande official home page:  
<http://www-sk.icrr.u-tokyo.ac.jp/>  
and SK-USA home page:  
<http://www.phys.washington.edu/~superk/>

Maury Goodman's Neutrino Oscillation Industry page:  
<http://www.hep.anl.gov/ndk/hypertext/nuindustry.html>

Next Generation Long-baseline Neutrino Experiment (JHFnu):  
<http://neutrino.kek.jp/jhfnu/>



# Whatever Happened to H

by JOEL R. PRIMACK

*Neutrinos  
may have had  
a significant  
impact on  
the structure  
of the Universe.*

**T**HE LIGHTEST OF THE FUNDAMENTAL matter particles, neutrinos may play important roles in determining the structure of the Universe. They helped to control the expansion rate of the Universe during its first few minutes, when deuterium and most of its helium were formed. Neutrinos and photons each accounted for nearly half the energy in the Universe during its first few thousand years. The fact that neutrinos are so ubiquitous—with hundreds of them occupying every thimbleful of space today—means that they can have an impact upon how matter is distributed in the Universe. Over the past two decades, the likelihood of this possibility has risen and fallen as more and more data has become available from laboratory experiments and the latest telescopes. We now know from the Super-Kamiokande and SNO experiments that neutrinos indeed have mass. Current estimates suggest that the total neutrino mass in the Universe may even be comparable to that of the visible stars.

By 1979 cosmologists had become convinced that most of the matter in the Universe is completely invisible. This gravitationally dominant component of the Universe was named “Dunkelmaterie,” or “dark matter,” by the astronomer Fritz Zwicky, who in 1933 first described evidence for dark matter in the Coma cluster (see article on Fritz Zwicky by Stephen Maurer, Winter 2001 *Beam Line*, Vol. 31, No. 1). Its galaxies were moving much too fast to be held together by the gravity of its visible matter. This phenomenon was subsequently seen in other galaxy clusters, but since the nature of this

# ot Dark Matter?

dark matter was completely unknown, it was often ignored. During the 1970s, it became clear that the motion of stars and gas in galaxies—and of satellite galaxies around them—required that this dark matter must greatly outweigh the visible matter in galaxies. The data gathered since then provides very strong evidence that most of the matter in the Universe is invisible.



*The Coma cluster of galaxies, which is about 50 million light years distant from the Milky Way.*

**D**ARK MATTER made of light neutrinos, with masses of a few electron volts (eV) or less, is called “hot dark matter” (HDM) by cosmologists, because those neutrinos would have been moving at nearly the speed of light in the early Universe. (See the tables on the next page for a summary of dark-matter types and associated cosmological models.) For a few years in the late 1970s and early 1980s, hot dark matter looked like the best dark-matter candidate. But HDM models of cosmological structure formation led to a “top-down” formation scenario, in which superclusters of galaxies are the first objects to form after the Big Bang, with galaxies and clusters forming through a subsequent process of fragmentation. Such models were abandoned by the mid-1980s after cosmologists realized that

if galaxies had formed early enough to agree with observations, their distribution would be much more inhomogeneous than is the case.

Since 1984, the most successful structure-formation models have been those in which most of the mass in the Universe comes in the form of cold dark matter (CDM)—particles that were moving sluggishly in the early Universe. But the HDM stock rose again a few years later, and for a while in the mid-1990s it appeared that a mixture of mostly CDM with 20–30 percent HDM gave a better fit to the observations than either one or the other. This “cold plus hot dark matter” (CHDM) theory fit data

on nearby galaxies and clusters only if the average density of matter in the Universe were at or close to the critical density ( $\Omega_m = 1$ ). But like all such critical-density models, CHDM required that galaxies and clusters must have formed fairly recently, which disagrees with observations. The evidence now increasingly favors  $\Lambda$ CDM models, in which cold dark matter makes up about a third of the critical density, with a cosmological constant  $\Lambda$  or some other form of “dark energy” contributing the remainder. This model also helped resolve the crisis regarding the age of the Universe (see box on next page). The question has now become one of how much room is left for neutrinos in these cosmological models.

To describe the possible role of neutrinos as dark matter, I must now explain how structures such as galaxies formed as the Universe expanded. The expansion itself is described by our modern theory of gravity and spacetime, Einstein’s theory of general relativity. In order for structure to form, there must have been some small fluctuations in the initial density of matter, or else some mechanism had to generate such fluctuations afterward. The only such mechanisms that have been investigated are “cosmic defects” such as cosmic strings, and the pattern of fluctuations produced by such defects is inconsistent with the temperature fluctuations observed in the cosmic microwave background (CMB) radiation. On the other hand, “adiabatic” fluctuations—in which all components of matter and energy fluctuate together—occur naturally in the simplest cosmic inflation models and are in excellent agreement

## Types of Dark Matter

$\Omega_i$  represents the fraction of the critical density  $\rho_c = 10.54 h^2 \text{ keV/cm}^3$  needed to close the Universe, where  $h$  is the Hubble constant  $H_0$  divided by 100 km/s/Mpc.

Dark Matter Type	Fraction of Critical Density	Comment
Baryonic	$\Omega_b \sim 0.04$	about 10 times the visible matter
Hot	$\Omega_v \sim 0.001\text{--}0.1$	light neutrinos
Cold	$\Omega_c \sim 0.3$	most of the dark matter in galaxy halos

## Dark Matter and Associated Cosmological Models

$\Omega_m$  represents the fraction of the critical density in all types of matter.  $\Omega_\Lambda$  is the fraction contributed by some form of “dark energy.”

Acronym	Cosmological Model	Flourished
HDM	hot dark matter with $\Omega_m = 1$	1978–1984
SCDM	standard cold dark matter with $\Omega_m = 1$	1982–1992
CHDM	cold + hot dark matter with $\Omega_c \sim 0.7$ and $\Omega_v = 0.2\text{--}0.3$	1994–1998
$\Lambda$ CDM	cold dark matter $\Omega_c \sim 1/3$ and $\Omega_\Lambda \sim 2/3$	1996–today



## The Age of the Universe

with the latest CMB results announced at the American Physical Society meeting in April 2001.

The evolution of adiabatic fluctuations into galaxies and clusters is easy to understand if you just think of gravity as the ultimate capitalist principle: the rich always get richer and the poor get poorer. A “rich” region of the Universe is one that has more matter than average. Although the average density of the Universe steadily decreases due to its expansion, those regions that start out with a little higher density than average expand a little slower than average and become relatively more dense, while those with lower density expand a little faster and become relatively less dense. When any region has achieved a density about twice the average, it stops expanding and begins to collapse—typically first in one direction, forming a pancake-shaped structure, and then in the other two directions.

I can now explain why the first hot-dark-matter boom occurred about two decades ago. Improving upper limits on CMB anisotropies were ruling out the previously favored cosmological model, which included only ordinary matter. There was also evidence from a Moscow experiment suggesting that the electron neutrino mass was about 20–30 eV, which would have corresponded to a nearly critical-density Universe in which neutrinos would have dominated the total mass (see box on page 56). In such a cosmology, the primordial fluctuations on galaxy scales are erased by “free streaming” of the relativistic neutrinos in the early Universe. One year after the Big Bang, a region about one light year

across contained the amount of matter (both ordinary and dark) in a large galaxy like our own Milky Way. But the temperature was then about 100 million degrees, so each particle had a thermal energy far higher than the rest energy of light neutrinos. As they would therefore have been moving at nearly the speed of light, these neutrinos would have rapidly spread out, and any fluctuations in density on the scale of galaxies would soon have been smoothed back to the average density.

The first scales to collapse in such a HDM scenario would therefore correspond to the mass inside the cosmic horizon when the temperature dropped to a few eV and the neutrinos inside it became nonrelativistic. This mass turns out to be about 10,000 times the mass of our galaxy, including its dark halo. Evidence was just then becoming available from the first large-scale galaxy surveys that the largest cosmic structures—superclusters—have masses of approximately this size, which at first glance appeared to be a big success for the HDM scenario.

Superclusters of roughly pancake shape were observed to surround roughly spherical voids (regions where few galaxies are found), in agreement with the first cosmological computer simulations, which were run for the HDM model. In this picture superclusters should have formed first, since any smaller-scale fluctuations in the dominant hot dark matter would have been erased by free streaming. Galaxies then had to form by fragmentation of the superclusters. But it was already becoming clear from observations that galaxies are much older than

IN THE MID-1990S there was a crisis in cosmology, because the age of the old globular-cluster stars in the Milky Way, then estimated to be  $t_{GC} = 16 \pm 3$  billion years (Gyr), was higher than the expansion age of the Universe, which for  $\Omega_m = 1$  is  $t_{exp} = 9 \pm 2$  Gyr. Here I have assumed that the Hubble parameter has the value  $h = H_0/(100 \text{ km/s/Mpc}) = 0.72 \pm 0.07$ , the final result from the Hubble Space Telescope project measuring  $H_0$ .

But when the data from the Hipparcos astrometric satellite became available in 1997, it showed that the distances to the globular clusters had been underestimated, which implied in turn that their ages had been overestimated; now  $t_{GC} = 13 \pm 3$  Gyr. The age of the Universe is consequently  $t_U \sim t_{GC} + 1 = 14 \pm 3$  Gyr.

Several lines of evidence now show that the Universe does not have  $\Omega_m = 1$  but rather  $\Omega_m + \Omega_\Lambda = 1.0 \pm 0.1$  and  $\Omega_m = 0.3 \pm 0.1$ . Taken together, these yield  $t_{exp} = 13 \pm 2$  Gyr, in excellent agreement with the revised globular cluster age. The high-redshift supernova data alone give  $t_{SN} = 14.2 \pm 1.7$  Gyr.

Moreover, a new type of age measurement based on radioactive decay of Thorium-232 (half-life 14.1 Gyr) measured in a number of very old stars gives a completely independent age  $t_{decay} = 14 \pm 3$  Gyr. A similar measurement, based on the first detection in a star of Uranium-238 (half-life 4.47 Gyr), reported this past February, gives  $t_{decay} = 12.5 \pm 3$  Gyr. Work in progress should soon improve the precision of these measurements.

All the recent measurements of the age of the Universe are therefore in excellent agreement. It is reassuring that three completely different cosmological clocks—stellar evolution, expansion of the Universe, and radioactive decay—agree so well.



*The Andromeda Galaxy, which together with the Milky Way and several dwarf galaxies, forms the Local Group of galaxies.*

superclusters, contrary to what the HDM scenario implies. And the apparent detection of electron neutrino mass by the Moscow experiment was soon contradicted by results from other laboratories. Hot matter fell into decline.

**I HELPED TO DEVELOP** the cold dark matter model in 1982–1984 just as the problems with the hot dark matter model were becoming clear. Proto-galaxies form first in a CDM cosmology, and galaxies and larger-scale objects form by aggregation of these smaller lumps—although the cross-talk between smaller and larger scales in the CDM theory naturally leads to galaxies forming earlier in clusters than in lower-density regions. In this and other respects, CDM models appeared to fit observations much better than HDM. The first great triumph of cold dark matter was that it successfully

predicted (to within a normalization uncertainty factor of about 2) the magnitude of the CMB temperature fluctuations, which were discovered in 1992 using the COBE satellite. But the simplest CDM model, standard CDM (or  $\Lambda$ CDM) with the matter density equal to the critical value ( $\Omega_m = 1$ ), had already begun to run into trouble.

Cosmological theories predict statistical properties of the Universe—for example, the size of density fluctuations on various scales, described mathematically by a power spectrum. Sound or other fluctuation phenomena can be described in the same way—for example, low frequencies might be loud, corresponding to relatively high power at long wavelengths. Put simply,  $\Lambda$ CDM had difficulty fitting the full spectrum of density fluctuations at both short and long wavelengths—or at small and large scales. With a given amount

## *The detailed studies*

*of cosmological*

*structures now*

*going on or about*

*to begin may*

*eventually reveal*

*something about*

*neutrino mass itself.*

of fluctuation power on the large scales probed by COBE (billions of light years), that is, SCDM has a little too much power on small scales relevant to galaxies and clusters (millions of light years and less). It produces too many of them. But the fact that the SCDM theory could work fairly well across such a wide range of size scales suggested that it had a kernel of truth. Cosmologists began to examine whether some variant of SCDM might work better.

Although these COBE results did not come in until 1992, I became worried that SCDM was in trouble when the large-scale flows of galaxies were first observed by my UC Santa Cruz colleague Sandra Faber and her “Seven Samurai” group of collaborators. Earlier studies had established that the local group of galaxies (including the Milky Way and the “nearby” Andromeda galaxy) is speeding at a velocity of about 600 kilometers per second with respect to the CMB reference frame. But the Seven Samurai and others found that bulk motions of other galaxies often had similar high velocities across regions several tens of millions of light years wide. It soon became clear that this result was inconsistent with the expectations of the “biased” SCDM model that seemed to fit the properties of galaxies on smaller scales. In the late 1980s Jon Holtzman, then Faber’s graduate student, did a theoretical dissertation with me in which he calculated detailed expectations for 96 variants of cold dark matter. When we compared these predictions with the data available in early 1992, it was clear that the best bets were CHDM and  $\Lambda$ CDM, each of which could fit the data on

small scales better than SCDM. Both of these variants had been proposed in 1984, when cold dark matter was still a new idea, but their detailed consequences were not worked out until the problems with SCDM began to surface.

**E**VEN IF MOST of the dark matter is cold, a little hot dark matter can still have dramatic effects on the small scales relevant to the formation and distribution of galaxies. In the early Universe, the free streaming of fast-moving neutrinos would have washed out any spatial inhomogeneities on the scales that later became galaxies, just as in the HDM scenario. Consequently, CDM fluctuations did not grow as fast on these scales, and at the relatively late times when galaxies formed there was less fluctuation power on small scales in CHDM

models. The main problem with  $\Omega_m = 1$  cosmologies containing only cold dark matter plus a small admixture of ordinary baryonic matter is that the galaxy-scale inhomogeneities are too big compared to those on larger scales. Adding a little hot dark matter appeared to be just what was needed to solve this problem.

And there was even a hint from an accelerator experiment that neutrino mass might lie in the relevant range. The experiment was the Liquid Scintillator Neutrino Detector (LSND) experiment at Los Alamos National Laboratory (see photograph on page 38), which recorded a number of events that appear to be  $\nu_\mu \rightarrow \nu_e$  oscillations. Comparison of the LSND data with results from other neutrino experiments allows two discrete values of  $\Delta m_{\mu e}^2$  (see box, next page) around 10.5 and 5.5 eV<sup>2</sup>, or a range of values between 0.2 and 2 eV<sup>2</sup>. If true, this means that at least one neutrino has a mass greater than 0.5 eV, which would imply that the contribution of hot dark matter to the cosmological density is much greater than that of all the visible stars. Such an important conclusion requires independent confirmation. The Karlsruhe Rutherford Medium Energy Neutrino (KARMEN) experiment results exclude a significant portion (but not all) of the LSND parameter space, and the numbers quoted above take into account the current KARMEN limits. The Booster Neutrino Experiment (BooNE) at Fermilab (see article by Paul Nienaber, this issue) should attain greater sensitivity and help to resolve this issue.

By 1995 simulation techniques and supercomputer technology had advanced to the point where it



## Neutrino Mass and Cosmological Density

THE ATMOSPHERIC-NEUTRINO DATA from the Super-Kamiokande underground neutrino detector in Japan provide strong evidence of muon to tau neutrino oscillations, and therefore that these neutrinos have nonzero mass (see the article by John Learned in the Winter 1999 *Beam Line*, Vol. 29, No. 3). This result is now being confirmed by results from the K2K experiment, in which a muon neutrino beam from the KEK accelerator is directed toward Super-Kamiokande and the number of muon neutrinos detected is about as expected from the atmospheric-neutrino data (see article by Jeffrey Wilkes and Koichiro Nishikawa, this issue).

But oscillation experiments cannot measure neutrino masses directly, only the squared mass difference  $\Delta m_{ij}^2 = |m_i^2 - m_j^2|$  between the oscillating species. The Super-Kamiokande atmospheric neutrino data imply that  $1.7 \times 10^{-4} < \Delta m_{\mu\tau}^2 < 4 \times 10^{-3} \text{ eV}^2$  (90 percent confidence), with a central value  $\Delta m_{\mu\tau}^2 = 2.5 \times 10^{-3} \text{ eV}^2$ . If the neutrinos have a hierarchical mass pattern  $m_{\nu_e} \ll m_{\nu_\mu} \ll m_{\nu_\tau}$  like the quarks and charged leptons, then this implies that  $\Delta m_{\mu\tau}^2 \cong m_{\nu_\tau}^2$  so  $m_{\nu_\tau} \sim 0.05 \text{ eV}$ .

These data then imply a lower limit on the HDM (or light neutrino) contribution to the cosmological matter density of  $\Omega_\nu > 0.001$ —almost as much as that of all the stars in the disks of galaxies. There is a connection between neutrino mass and the corresponding contribution to the cosmological density, because the thermodynamics of the early Universe specifies the abundance of neutrinos to be about 112 per cubic centimeter for each of the three species (including both neutrinos and antineutrinos). It follows that the density  $\Omega_\nu$  contributed by neutrinos is  $\Omega_\nu = m(\nu)/(93 h^2 \text{ eV})$ , where  $m(\nu)$  is the sum of the masses of all three neutrinos. Since  $h^2 \sim 0.5$ ,  $m_{\nu_\tau} \sim 0.05 \text{ eV}$  corresponds to  $\Omega_\nu \sim 10^{-3}$ .

This is however a lower limit, since in the alternative case where the oscillating neutrino species have nearly equal masses, the values of the individual masses could be much larger. The only other laboratory approaches to measuring neutrino masses are attempts to detect neutrinoless double beta decay, which are sensitive to a possible Majorana component of the electron neutrino mass, and measurements of the endpoint of the tritium beta-decay spectrum. The latter gives an upper limit on the electron neutrino mass, currently taken to be 3 eV. Because of the small values of both squared-mass differences, this tritium limit becomes an upper limit on all three neutrino masses, corresponding to  $m(\nu) < 9 \text{ eV}$ . A bit surprisingly, cosmology already provides a stronger constraint on neutrino mass than laboratory measurements, based on the effects of neutrinos on large-scale structure formation.

was possible to do reasonably high-resolution cosmological-scale simulations including the random velocities of a hot dark matter component. The results at first appeared very favorable to CHDM. Indeed, as late as 1998 a CHDM model (with Hubble parameter  $h = 0.5$ , mass density  $\Omega_m = 1$ , and neutrino density  $\Omega_\nu = 0.2$ ) was found to be the best fit of any cosmological model to the galaxy distribution in the nearby Universe. But cosmological data was steadily improving, and even by 1998 it had become clear that  $h = 0.5$  and  $\Omega_m = 1$  were increasingly inconsistent with several observations, and that  $h \sim 0.7$  and  $\Omega_m \sim 1/3$  worked much better. For example, CHDM predicts that galaxies and clusters formed relatively recently, but around 1998 increasing numbers of galaxies were discovered to have formed in the first few billion years after the Big Bang. And the fraction of baryons found in clusters, together with the reasonable assumption that this fraction is representative of the Universe as a whole, again gives  $\Omega_m \sim 1/3$ . That there is a large cosmological constant (or some other form of dark energy) yielding  $\Omega_\Lambda \sim 2/3$  then follows from any two of the following three results: (1)  $\Omega_m \sim 0.3$ , (2) CMB anisotropy data implying that  $\Omega_m + \Omega_\Lambda = 1$ , and (3) high-redshift supernova data implying that  $\Omega_\Lambda - \Omega_m \sim 0.4$ .

The abundance of galaxies and clusters in the early Universe agrees well with the predictions of the  $\Lambda$ CDM model. However, the highest-resolution simulations of this model that were possible in the mid-1990s gave a dark matter spectrum that had more power on scales of a few million light years than did the

observed galaxy power spectrum, although the simulations and data agreed on larger scales. This result was inconsistent with the expectations that galaxies would be (if anything) more clustered than the dark matter on small scales, not less. When it became possible to do even higher-resolution simulations that allowed the identification of the dark matter halos of individual galaxies, however, their power spectrum turned out to be in excellent agreement with observations. The galaxies were less clustered than dark matter because galaxies had merged or were destroyed in very dense regions due to interactions with each other and with the cluster center. This explanation turned a troubling discrepancy into a triumph for  $\Lambda$ CDM.

Thus  $\Lambda$ CDM is the favorite theory today. But we know from the Super-Kamiokande evidence for atmospheric neutrino oscillations that there is enough neutrino mass to correspond to some hot dark matter, at least  $\Omega_\nu \sim 10^{-3}$  (see box on opposite page) about one-fourth as much as the visible stars. So the remaining question regarding neutrinos in cosmology is how much room remains for a little hot dark matter in  $\Lambda$ CDM cosmologies. There could be perhaps 10 times the lower limit just quoted, but probably not 100 times. The reason there is any upper limit at all from cosmology is because the free streaming of neutrinos in the early Universe must have slowed the growth of the remaining CDM fluctuations on small scales. Thus to have the galaxy structures we see today, there must be much more cold than hot dark matter. For the observationally favored range  $0.2 \leq \Omega_m \leq$

0.5, the limit on the sum of the neutrino masses is  $m(\nu) < 2.4 (\Omega_m/0.17 - 1)$  eV. Thus for  $\Omega_m < 0.5$ , the sum of all three neutrino masses is less than 5 eV. This limit on the sum of the neutrino masses is much stronger than the best current laboratory limit.

Astronomical observations that may soon lead to stronger upper limits on  $m(\nu)$ —or perhaps even a detection of neutrino mass—include data on the distribution of low-density clouds of hydrogen (the so-called “Lyman-alpha forest”) in the early Universe, large-scale weak gravitational lensing data, and improved measurements of the fluctuations in the CMB radiation temperature at small angles. These data are sensitive to the presence of free-streaming neutrinos in the early Universe, which can lead to fewer galaxies on small scales, depending on the values of the neutrino masses.

The hot dark matter saga thus illustrates once again the fruitful marriage between particle physics and cosmology. While neutrino-oscillation experiments can tell us only about differences between the squared masses of the neutrinos, the structure of the Universe can give us information about the neutrino masses themselves. In an earlier example of this connection, cosmological arguments based on Big Bang nucleosynthesis of light elements put a strict limit on the possible number of light neutrino species; this limit was eventually borne out by high-energy physics experiments on  $Z$  bosons at CERN and SLAC. The detailed studies of cosmological structures now going on or about to begin may eventually reveal something about neutrino mass itself.

## For Further Reading

For a more technical article on the present subject with extensive references, see “Hot Dark Matter in Cosmology,” by Joel R. Primack and Michael A. K. Gross, in *Current Aspects of Neutrino Physics*, D. O. Caldwell, Ed. (Berlin: Springer, 2001); also available on the Internet as [astro-ph/0007165](http://astro-ph/0007165) and interactively as [nedwww.ipac.caltech.edu/level5/Primack4/frames.html](http://nedwww.ipac.caltech.edu/level5/Primack4/frames.html)

The latest published upper limit on the sum of neutrino masses from cosmological structure formation is Rupert A. C. Croft, Wayne Hu, and Romeel Davé, *Phys. Rev. Lett* **83**, 1092 (1999).

X. Wang, M. Tegmark, and M. Zaldarriaga, *astro-ph/0105091*, gives a tighter upper limit of 4.4 eV on  $m(\nu)$ .

---

## CONTRIBUTORS

---



**MICHAEL RIORDAN** is Assistant to the Director at the Stanford Linear Accelerator Center, Lecturer in the History and Philosophy of Science Program at Stanford, and Adjunct Professor of Physics at the University of California, Santa Cruz. A Contributing Editor of the *Beam Line*, he is author of *The Hunting of the Quark*, and coauthor of *The Shadows of Creation: Dark Matter and the Structure of the Universe* and *Crystal Fire: The Birth of the Information Age*. He leads a group of historians and physicists researching and writing the history of the Superconducting Super Collider. In 1999 he received a Guggenheim Fellowship to pursue research on this subject at the Smithsonian Institution in Washington, DC. While there, he also got married again.



**JOSHUA KLEIN** received his Ph.D. from Princeton University in 1994. He then moved to the University of Pennsylvania where he has worked on building and making measurements with the Sudbury Neutrino Observatory. He is currently Research Assistant Professor of Physics at Pennsylvania.

SNO is in many ways the quintessential particle astrophysics experiment featuring the Sun as a neutrino laboratory and neutrinos as solar probes. Klein's interest in SNO encompasses both of these features, including an interest in neutrinos themselves as the Standard Model's most enigmatic particle.



**PAUL NIENABER** has the great good fortune to be part of two extraordinary neutrino groups at Fermilab. He joined the NuTeV collaboration in 1992 and is now working on data analysis from that experiment; in addition, he became a member of the BoONE collaboration in 2000 and is participating in construction and testing of its detector.

The photograph above shows Paul inside the BoONE tank, surrounded by the photomultiplier tubes he helped install. He is a Jesuit priest, a Guest Scientist at Fermilab, and a member of the physics faculty at the College of the Holy Cross in Worcester, Massachusetts, where he thoroughly enjoys infecting college students' minds with the manifold pleasures of doing physics. This is his first article for the *Beam Line*.





**BORIS KAYSER** is a theoretical physicist who has been particularly interested in the physics of massive neutrinos and the asymmetry between matter and antimatter. He also enjoys brachiating around in quantum mechanics. An author of well over 100 scientific papers, he is also co-author of a popular slender book on neutrino physics and a frequent, enthusiastic speaker on particle physics topics.

For nearly three decades, Kayser served as Program Director for Theoretical Physics at the National Science Foundation, in which capacity he was instrumental in establishing the Institute for Theoretical Physics at the University of California, Santa Barbara. He has now joined Fermilab as a Distinguished Scientist and looks forward to spending full time on his first love—physics research.

Kayser enjoys nature, and he is one of the primates in the photo above.



**KOICHIRO NISHIKAWA** is Professor of Physics at Kyoto University. He received his Ph.D. in 1980 from Northwestern University, where his thesis research involved di-muon production using the high energy neutrino beam at Fermilab. As a postdoc at the University of Chicago, he was subsequently involved in an experiment on CP violation in the neutral kaon system.

Nishikawa returned to Japan—to the Institute for Nuclear Study of the University of Tokyo—and joined the Super-Kamiokande experiment. He moved to Kyoto University in 1999. He serves as the spokesman for the K2K long-baseline neutrino experiment.



**JEFFREY WILKES** is Kenneth K. Young Memorial Professor of Physics at the University of Washington in Seattle. His thesis research at the University of Wisconsin involved the last of many cosmic-ray experiments conducted at Echo Lake, Colorado. As a postdoc at the University of Washington, he learned the nuclear emulsion trade as Jere Lord's apprentice and has been there ever since.

After an interlude with the quixotic and habit-forming enterprise called DUMAND, he joined Super-Kamiokande, where he is convener of an analysis group. He is US co-spokesman for the K2K long-baseline neutrino experiment, to which his main contribution seems to be the care and feeding of a wildly fluctuating shift schedule. Most recently, he has been developing WALTA, a school-network cosmic-ray detector project in Seattle.



**JOEL PRIMACK** is Professor of Physics at the University of California, Santa Cruz. He has been working at the interface between particle physics and cosmology since the early 1980s, when he and several colleagues conceived the idea of cold dark matter, which has since become the “standard model” of cosmological structure formation. He is currently doing research in Germany under an award from the Humboldt Foundation.

Primack has also worked extensively on science and public policy issues. He helped initiate the Congressional Fellowship program sponsored by the American Association for the Advancement of Science, as well as the American Physical Society’s Forum on Physics and Society.

## A Brief Neutrino Bibliography

- John N. Bahcall, *Neutrino Astrophysics* (Cambridge University Press, New York, 1989)
- John N. Bahcall, Raymond Davis, et al., Eds., *Solar Neutrinos: The First Thirty Years* (Addison-Wesley, Reading, 1994).
- David O. Caldwell, Ed., *Current Aspects of Neutrino Physics* (Springer Verlag, Berlin, 2001)
- Boris Kayser, *The Physics of Massive Neutrinos* (World Scientific, Singapore, 1989)
- Nickolas Solomey, *The Elusive Neutrino* (Scientific American Library, New York, 1997)
- Christine Sutton, *Spaceship Neutrino* (Cambridge University Press, Cambridge, 1992)

---

## *DATES TO REMEMBER*

---

- Jan 7 - Mar 15      Joint Universities Accelerator School: Courses in the Fundamentals of the Physics, Technologies, and Applications of Particle Accelerators (JUAS 2002), Archamps, France, (J. Delteil, ESI/JUAS, Centre Universitaire de Formation et de Recherche, F-74166 Archamps, France or juas@esi.cur-archamps.fr or <http://www.esi.cur-archamps.fr>)
- Jan 14 - 25      US Particle Accelerator School, Long Beach, CA (uspas@fnal.gov or <http://www.indiana.edu/~uspas/programs/ucla.html>)
- Feb 4 - 8      9th International Workshop on Linear Colliders, Menlo Park, CA (Robbin Nixon, SLAC, MS 66, Box 4349, Stanford, CA 94309 or [lc02@slac.stanford.edu](mailto:lc02@slac.stanford.edu))
- Mar 3 - 8      International Spring School on the Digital Library and E-Publishing for Science and Technology, Geneva, Switzerland (<http://cwis.kub.nl/~ticer/spring02/index.htm>)
- Mar 7 - 9      IUPAP International Conference on Women in Physics, Paris, France (Dr. Judy Franz, American Physical Society, One Physics Ellipse, College Park, MD 20740 or <http://www.if.ufrgs.br/~barbosa/conference.html>)
- Mar 18 - 22      Annual Meeting of the APS, Indianapolis, IN (American Physical Society, One Physics Ellipse, College Park, MD 20740 or <http://www.aps.org/meet/MAR02/>)
- Apr 20 - 23      Meeting of the APS and the High-Energy Astrophysics Division (HEAD) of the American Astronomical Society, Albuquerque, NM (American Physical Society, One Physics Ellipse, College Park, MD 20740 (<http://www.aps.org/meet/APR02/>))
- May 8 - 17      CERN Accelerator School: Superconductivity and Cryogenics for Accelerators and Detectors, Erice, Sicily (CERN Accelerator School, AC Division, 1211 Geneva 23, Switzerland or [suzanne.von.warburg@cern.ch](mailto:suzanne.von.warburg@cern.ch))
- May 24 - 28      DPF 2002: Meeting of the Division of Particles and Fields of the American Physical Society, Williamsburg, VA (Marc Sher, Physics Department, College of William and Mary, Williamsburg, VA 23187 or [sher@physics.wm.edu](mailto:sher@physics.wm.edu) or <http://www.dpf2002.org>)
- May 25 - 30      20th International Conference on Neutrino Physics and Astrophysics (Neutrino 2002), Munich, Germany (NEUTRINO 2002 Secretariat, Technische Universitat Munchen, Physik Department E15, D-85747 Garching, Germany or [neutrino2002@ph.tum.de](mailto:neutrino2002@ph.tum.de) or <http://neutrino2002.ph.tum.de/>)
- Jun 20 - 22      Physics in Collisions, Stanford, CA (Maura Chatwell, MS 81, 2575 Sand Hill Road, Menlo Park, CA 94025 or [maura@slac.stanford.edu](mailto:maura@slac.stanford.edu))