

SC6K

**A standardization initiative on
Sensor Networks in JTC 1 SC 6
- including Visions for Ubiquitous Sensor Network -**

2008. 4. 8.

Yong-Woon Kim
(qkim@etri.re.kr)

ETRI, Republic of KOREA

■ General points

- What is "sensor network"?
- What is "sensor network"? - applications
- Sensor network standardization areas
- Prospective standardization items

■ SC 6-specific points

- Gap analysis between SDOs and SC 6
- SC 6 activities on sensor networks

■ Conclusions

What is "sensor network"?

SC6K

■ What are these?

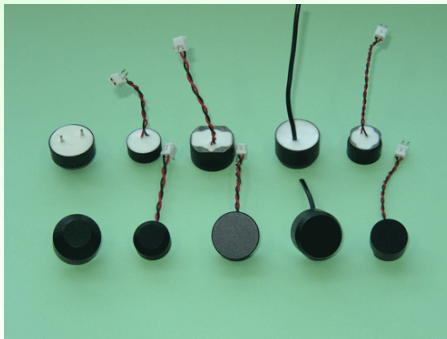

Answer: sensors

What is "sensor network"?

SC6K

■ How can sensed data be transmitted?

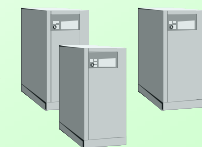
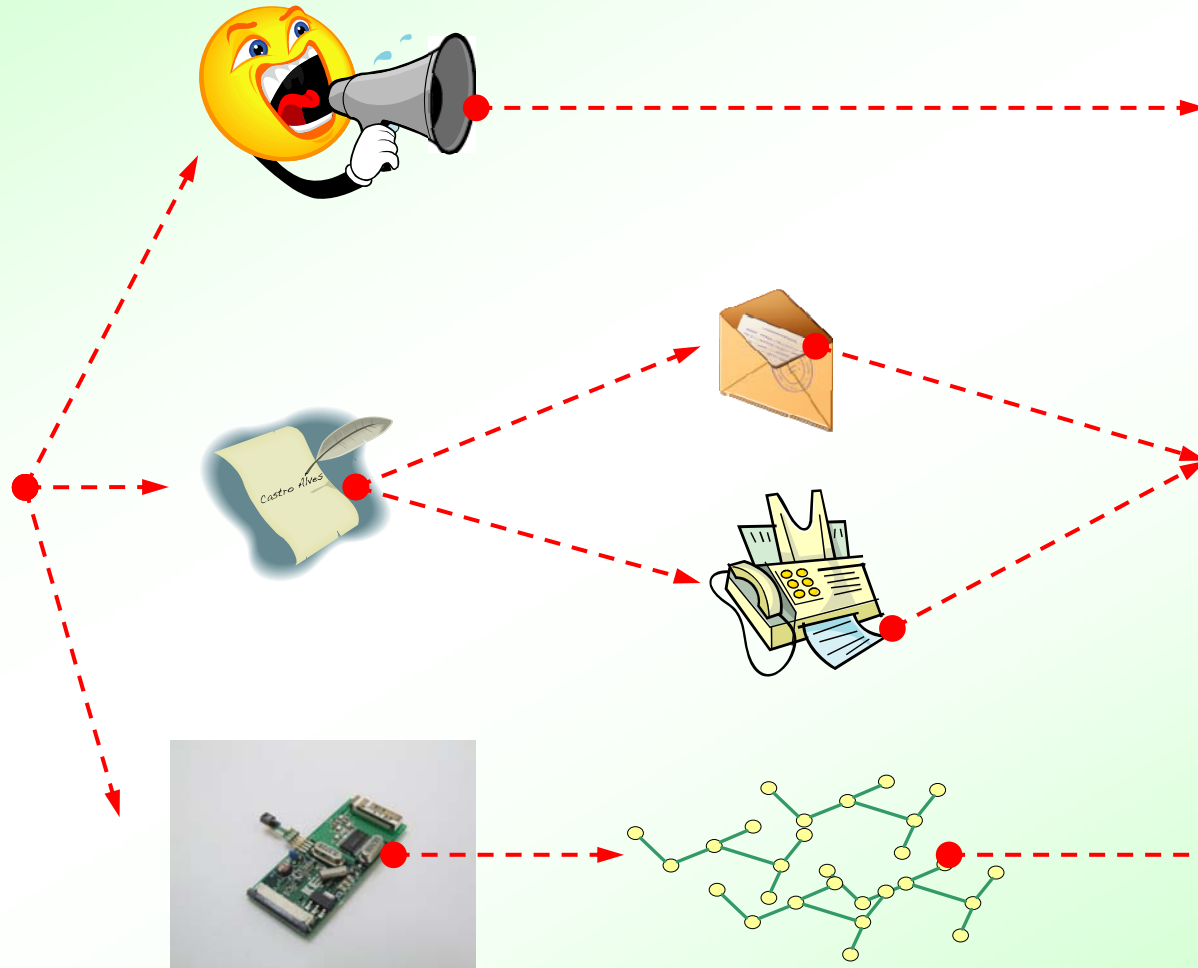

Answer: up to you!

What is "sensor network"?

SC6K

■ How can sensed data be transmitted?

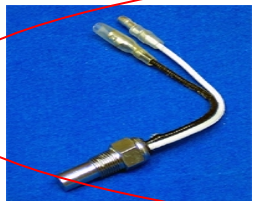

Sensor network case

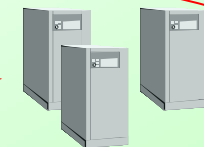
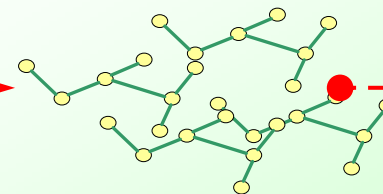
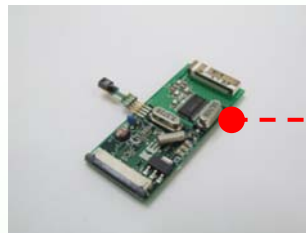

Answer: up to you!

What is "sensor network"?

SC6K

■ Here are three points:

- Sensing physical or environmental conditions;
- Transmitting sensed information; and
- Cooking the sensed information.

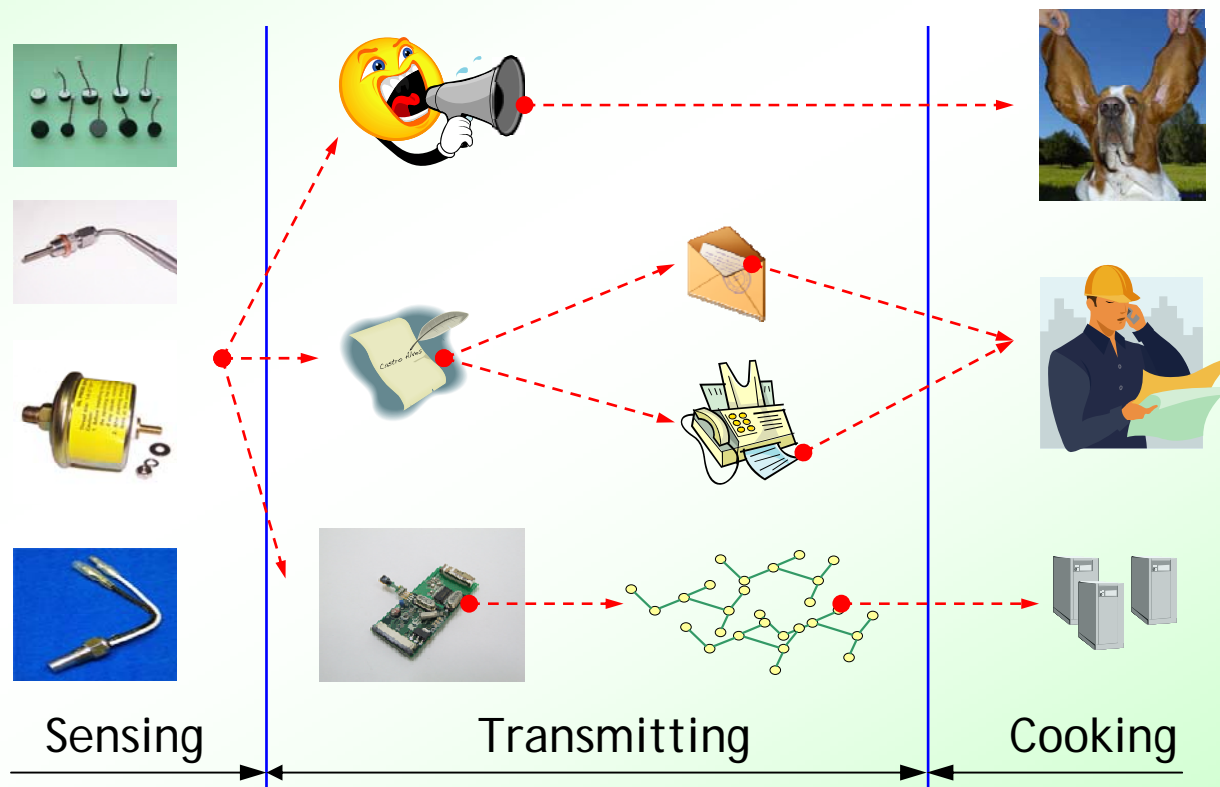

What is "sensor network"?

SC6K

■ We are focusing on:

- How to transmit sensed data; and
- How to cook sensed data.

■ An incarnation of transmitting and cooking sensed data:

- Sensor is built in a machine.



- Machine-to-Machine communication is needed.

- A network is established .
- It is called a sensor network.

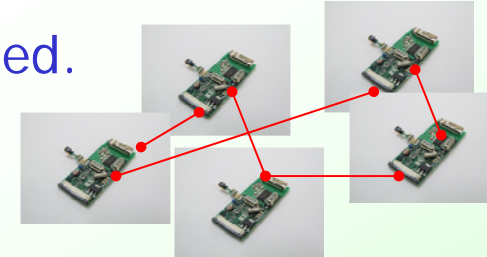

- A sensor network is realized with applications.

- Home control against fire, gas, burglar, electric, etc.

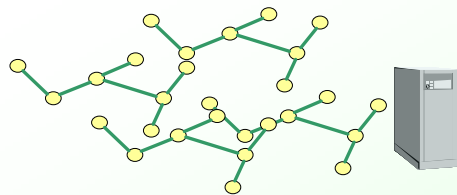

■ How to establish a sensor network?

- Answer: Wire-line or Wireless
- Wire-line sensor networks
 - There are so many use cases.
 - Networking techniques: RS-232, RS-422, RS-485, PLC, etc.
- Wireless sensor networks
 - There are many existing use cases. But they're made by proprietary solutions.
 - Now standardized ways have emerged as hot topics and a new term, WSN (Wireless Sensor Network), was made for technology and business marketing.
 - PHY/MAC networking techniques: IEEE 802.15.4, 802.15.3, etc.
 - Multi-hop networking techniques: ZigBee, 6LoWPAN, etc.

■ What is WSN?

- A formalized description by WIKIPEDIA

- Description: It is a wireless network consisting of spatially distributed autonomous devices using sensors to cooperatively monitor physical or environmental conditions such as temperature, sound, pressure, etc.
- Physical components: small MCU, limited memory, sensors (including specific conditioning circuitry), communication device (usually radio transceivers), battery, etc.
- Characteristics: small-scale sensor nodes, limited power they can harvest or store, harsh environmental conditions, high possibility of node and/or communication failures, mobility of nodes, dynamic network topology, heterogeneity of nodes, large scale of deployment, unattended management, etc.

- New challenges

- Those characteristics challenge various network and application aspects.
- This is the reason why several SDOs took part in the sensor networks area.

■ Structural health monitoring

- Attaching structural health monitoring sensors (vibration, temp., slope change, etc.)
- Collecting and analyzing sensed information via sensor network
- Properties: fixed sensors, pre-defined and lined configuration, outdoor, etc.

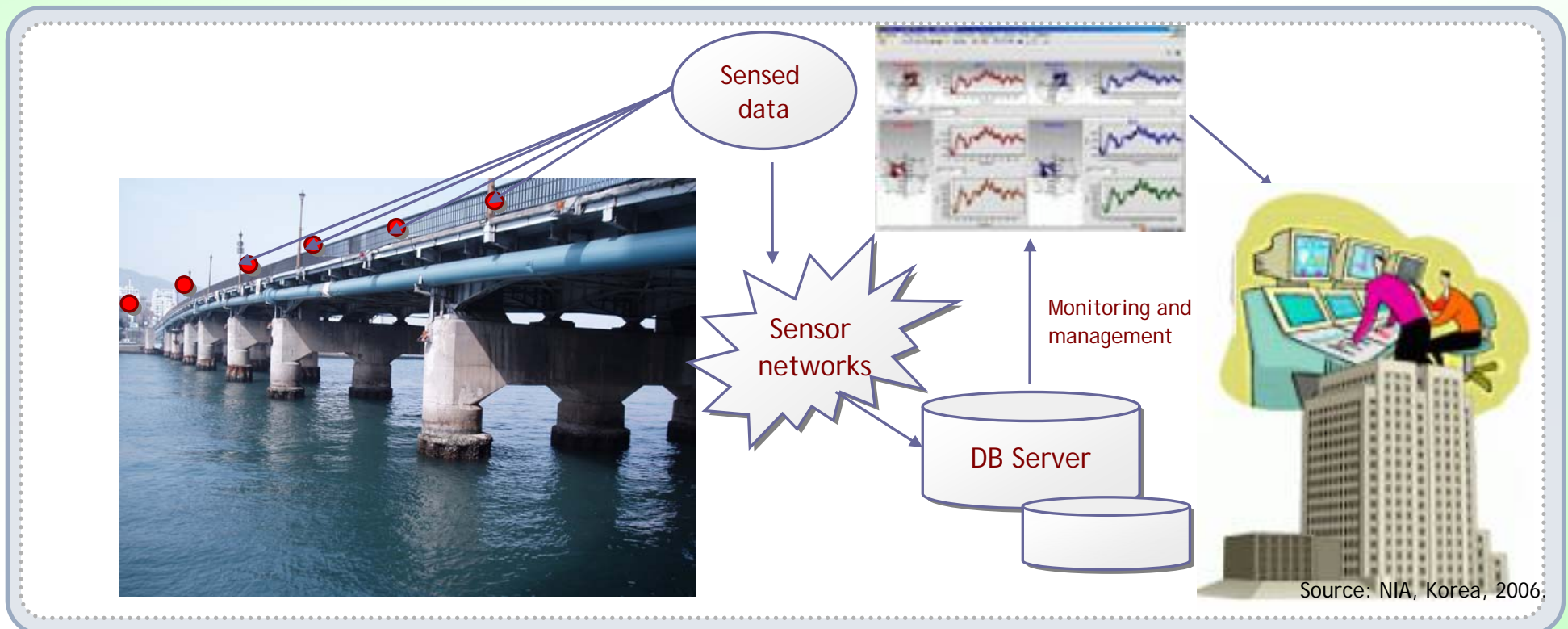

What is “sensor network”? - applications

SC6K

■ Street light control

- Automatic management of the light level
- Based on the crowd level in the street
- With functioning Wi-Fi access points
- Properties: large scale, static deployment, etc.



- Access point of the vendor 1
- Access point of the vendor 2

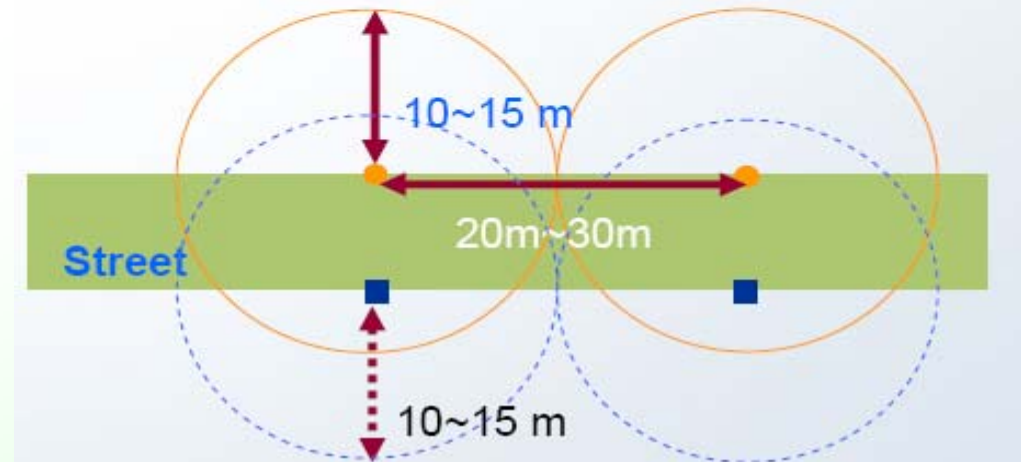

Source: NIA, Korea, 2006.

What is "sensor network"? - applications

SC6K

■ Agriculture monitoring and management

- Monitoring current cultivation conditions and managing optimal conditions for plants
- Properties: fixed sensors, mesh topology, periodic data gathering, etc.

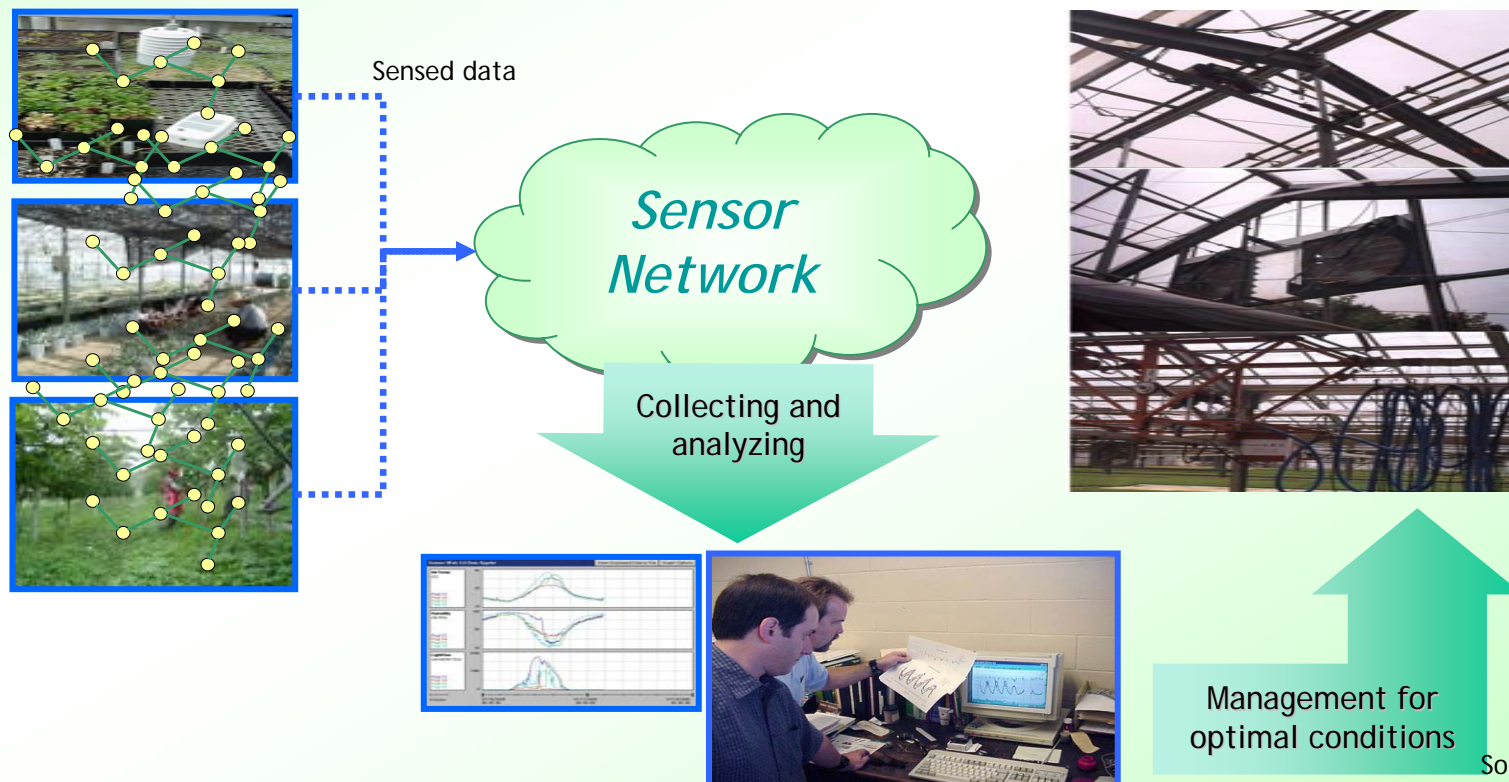

Source: NIA, Korea, 2006.

What is "sensor network"? - applications

SC6K

■ DMZ (Demilitarized Zone) surveillance in military fields

- Implementing unmanned surveillance in military fields
- Properties: large scale, pre-configuration, static + moving sensors, etc.

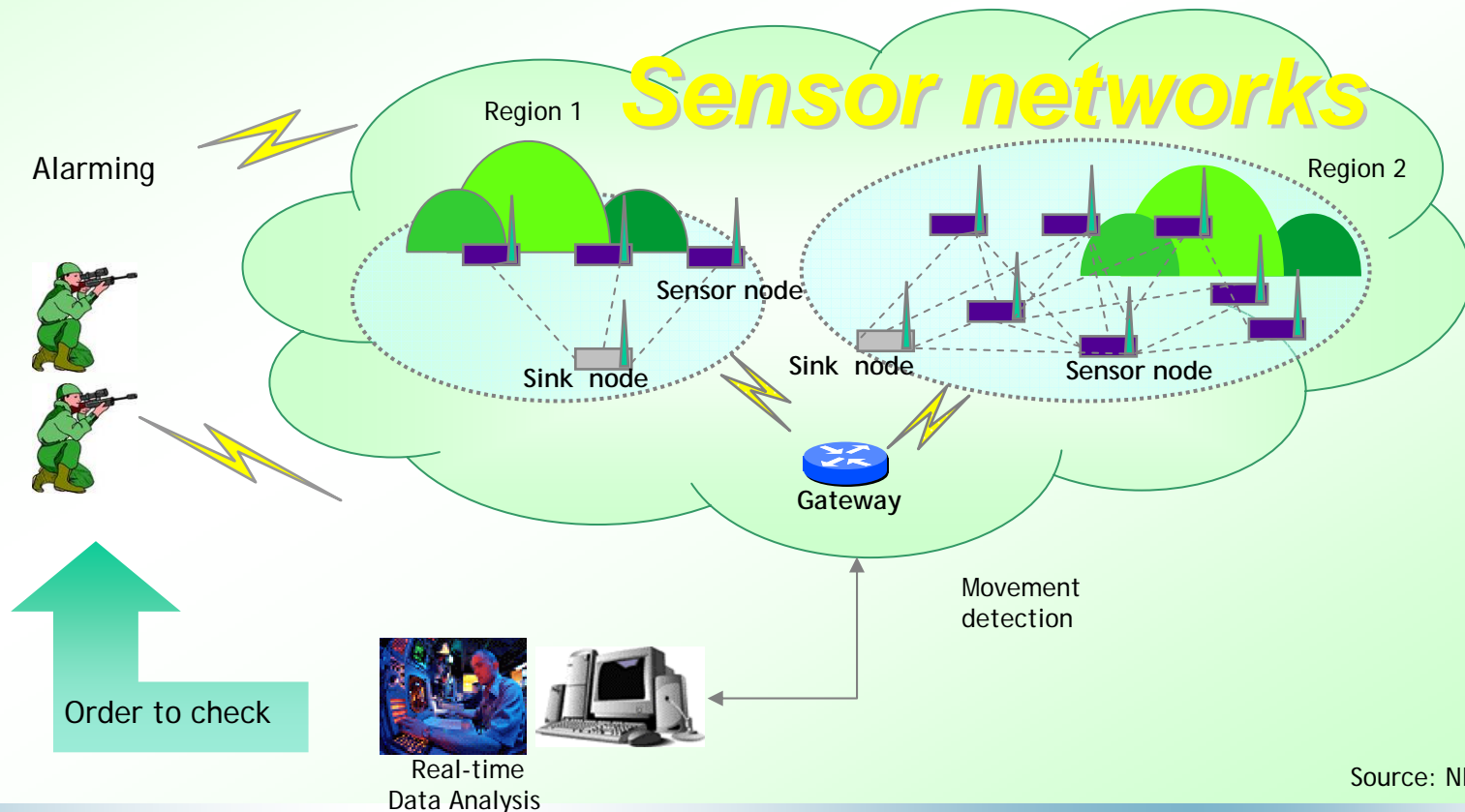

Source: NIA, Korea, 2006.

What is "sensor network"? - applications

SC6K

■ City facilities management

- Monitoring city facilities conditions
- Properties: fixed sensors, pre-configured topology, underground, etc.

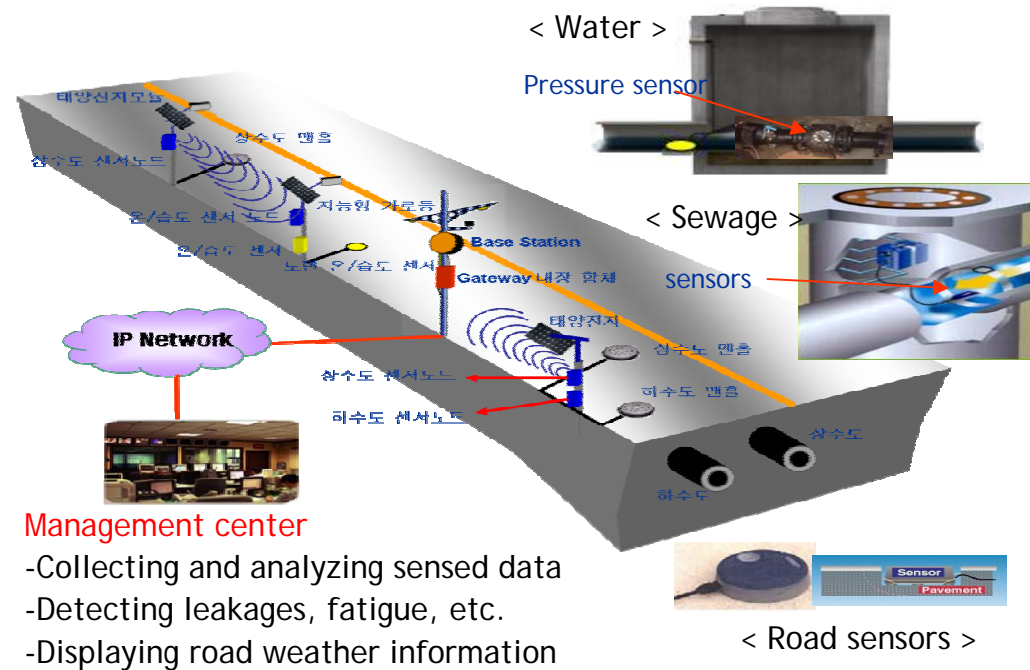
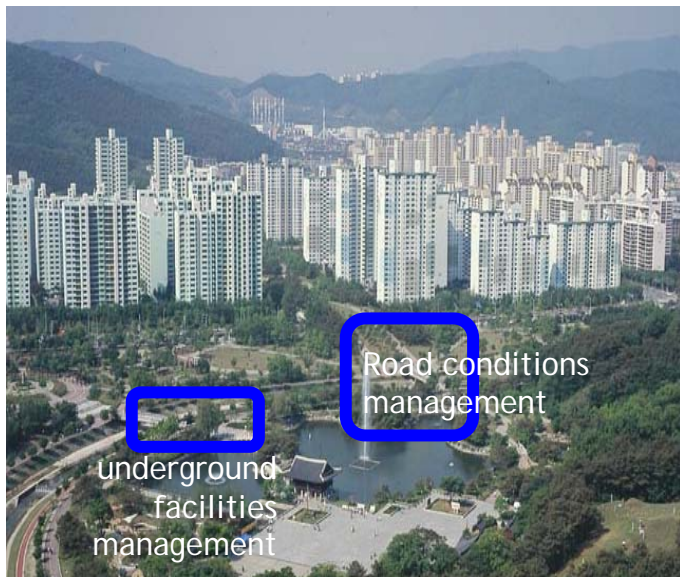

Source: NIA, Korea, 2006.

What is "sensor network"? - applications

SC6K

■ Marine environment monitoring

- Monitoring marine environment
- Properties: energy harvesting, outdoor, periodic and event-driven data, etc.

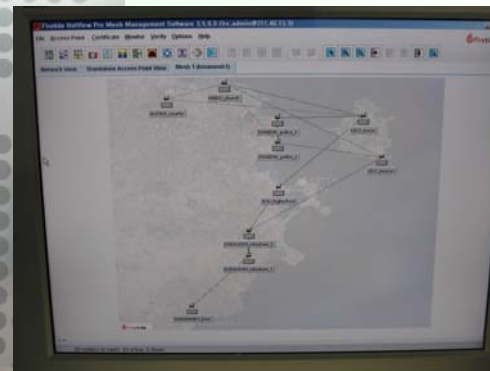
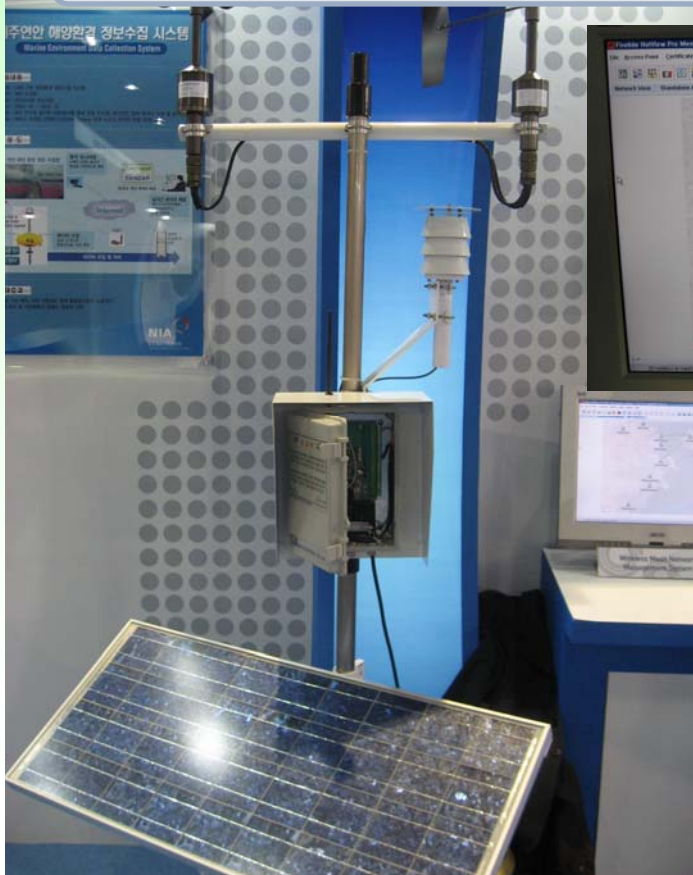

Sungsanpo area, Jeju

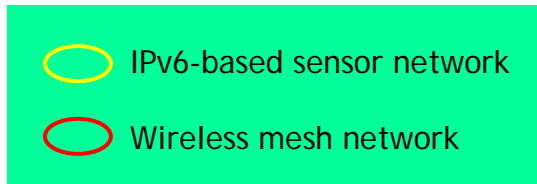

Sungsanpo weather station

Kuja town Jongdal town



Source: NIA, Korea, 2006.

■ Observation for the example sensor network applications

- Static application purposes
 - Sensor networks are installed for specific and static purposes such as structures monitoring, street light control, agriculture monitoring and management, DMZ surveillance, city facilities management, marine environment monitoring, etc.
- Straightforward work process
 - Sensing → transmitting → processing → provisioning
- Single operation domain
 - Sensed data are captured, transmitted, processed and delivered within a single operation domain.
- Dedicated users
 - Processed and value-added data are provided to dedicated users: owner and partners.

- Sensor networks are being evolved as a service infrastructure.
 - Dynamic service models
 - Services depend on users and anybody can be user.
 - For weather information services as an example:
 - Fishermen request on-demand and periodic weather information for fishing.
 - Tourists request periodic and alarming information of the nature condition for a week, a few days, or a month.
 - National disaster center requests the whole weather information to observe the natural phenomena of an area and detect emergency situations.
 - Sophisticated work processes
 - Sensing → transmitting → processing (filtering, analyzing, context processing, data mining, decision making, forecasting, integration, exporting, etc.) → provisioning (data can be delivered in different forms such as text, audio, voice, image, etc. according to information users)

- Sensor networks are being evolved as a service infrastructure.
 - Multi-domain operations
 - Multiple business domains are incorporated by business partnerships.
 - Both dedicated and arbitrary users
 - Pre-defined users by contracts or agreements: B2B-type sensor network services
 - Consumers by service subscription: B2C-type sensor network services
- ITU-T's term: USN
 - ITU-T calls the service infrastructure Ubiquitous Sensor Network (USN).
 - It describes as follows:
 - It delivers user-oriented information and knowledge services which are developed by using context awareness with sensing, storing, processing and integrating physical or environmental information gathered from sensor tags and/or sensor nodes. It is not a network technology term but a service infrastructure term.

What is "sensor network"? - applications

SC6K

Weather information service

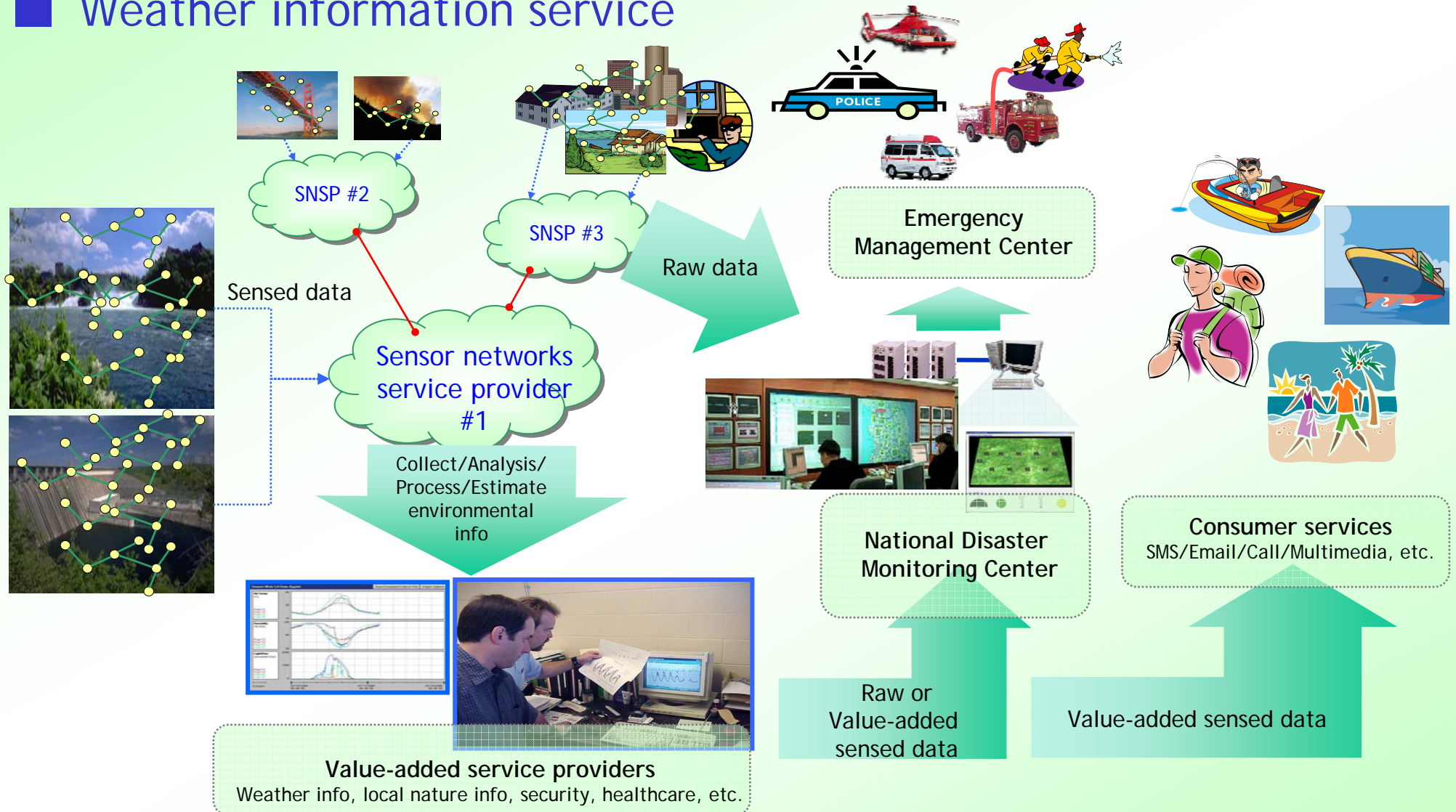

What is "sensor network"? - applications

SC6K

Healthcare service



Sensors on Patients

Sensed data

Sensor networks
service provider

Collect/Analysis/
Process/Estimate
vital body signs



Monitoring vital signs

Raw or
value-added
sensed data

Value-added service providers
Weather info, local nature info, security, healthcare, etc.



Connecting to insurance



Connecting to hospital



Status report to family



Emergency call

What is “sensor network”? - applications

SC6K

- Case for u-City: Cheonggyecheon stream in Seoul



What is "sensor network"? - applications

SC6K

Case for u-City: Cheonggyecheon stream in Seoul

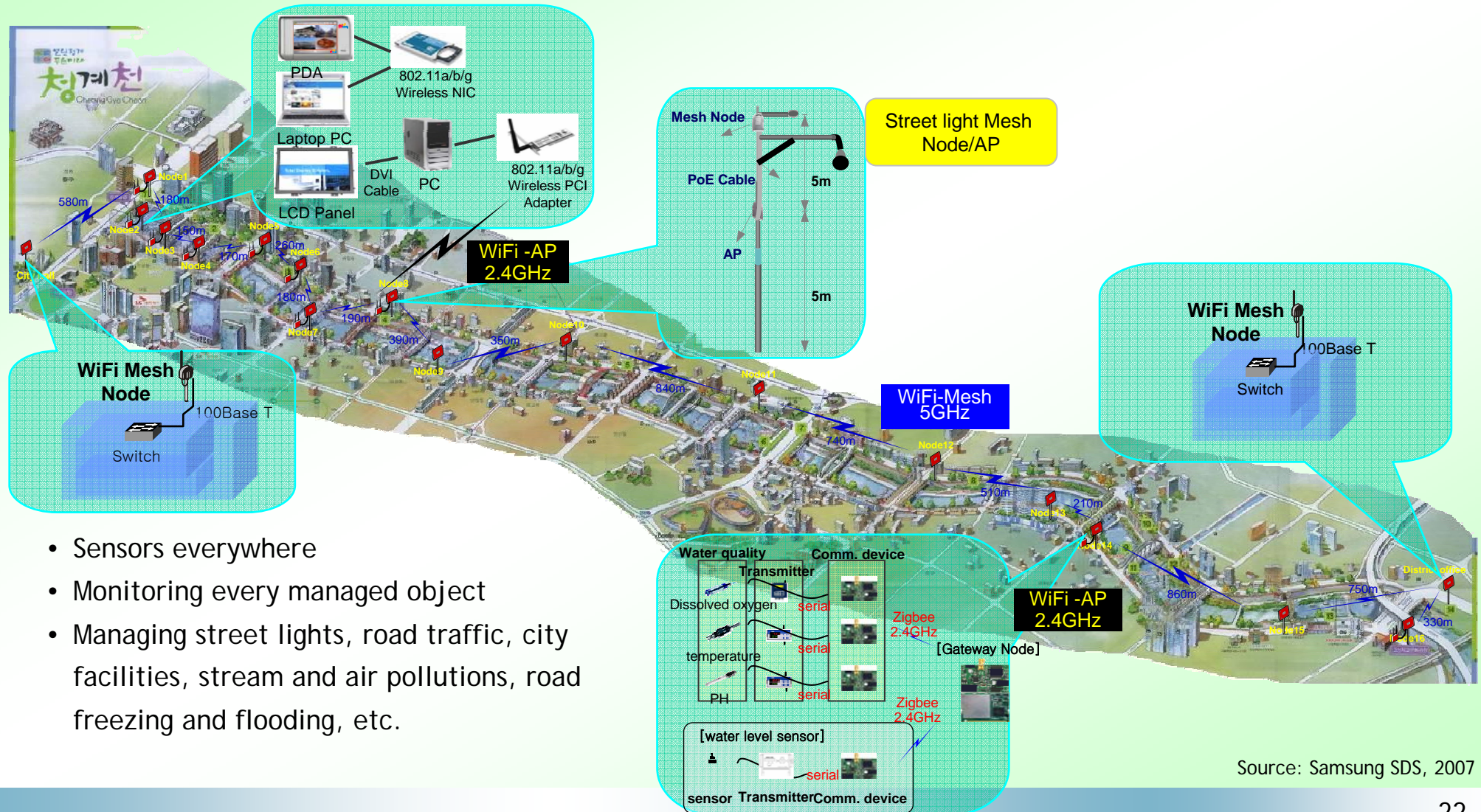

- Sensors everywhere
- Monitoring every managed object
- Managing street lights, road traffic, city facilities, stream and air pollutions, road freezing and flooding, etc.

Source: Samsung SDS, 2007

What is "sensor network"? - applications

SC6K

U-Defense

Unmanned monitoring; unmanned combat; real-time command and control; supplying system; MRO; remote medical care, etc.

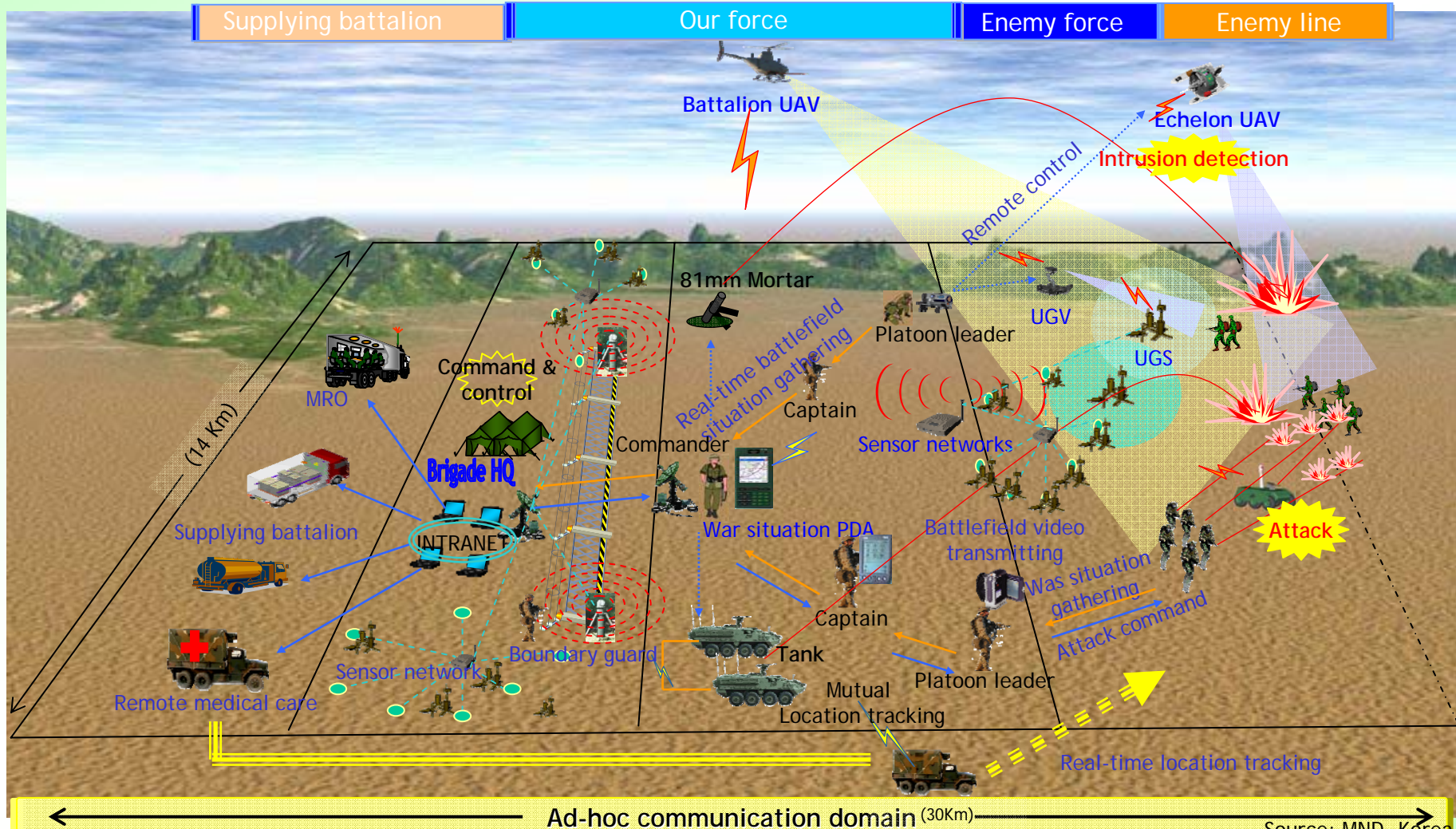

Source: MND, Korea, 2007

What is "sensor network"? - applications

SC6K

■ Solution against climate change

- A global issue in ICT fields as well.
- ITU is holding two symposia on ICTs and climate change.



Wisconsin Univ. 2004

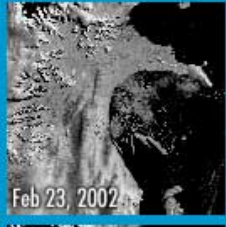
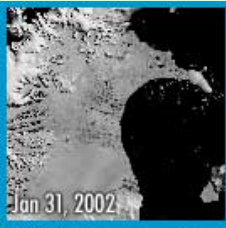

Antarctic ice chunk collapsing



Glacier shrank, Mountain LHOTSE, Himalayas



1916 and 2001, Chamonix, Switzerland (Source: Green peace, Paris)



What is "sensor network"? - applications

SC6K

■ Solution against climate change

- A global issue in ICT fields as well.
- ITU is holding two symposia on ICTs and climate change.



Wisconsin Univ. 2004

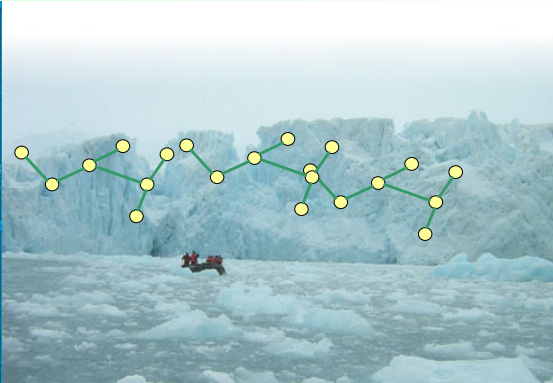
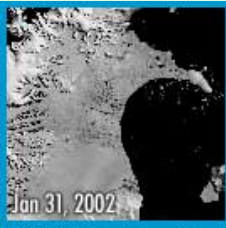

Antarctic ice chunk collapsing

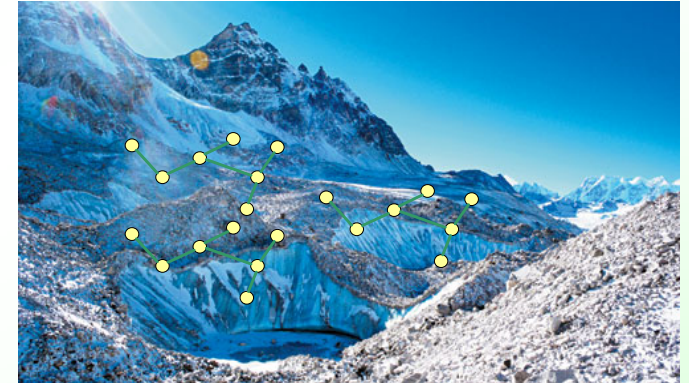

Glacier shrank, Mountain LHOTSE, Himalayas



1916 and 2001, Chamonix, Switzerland (Source: Green peace, Paris)



Sensor network standardization areas (1/2) SC6K

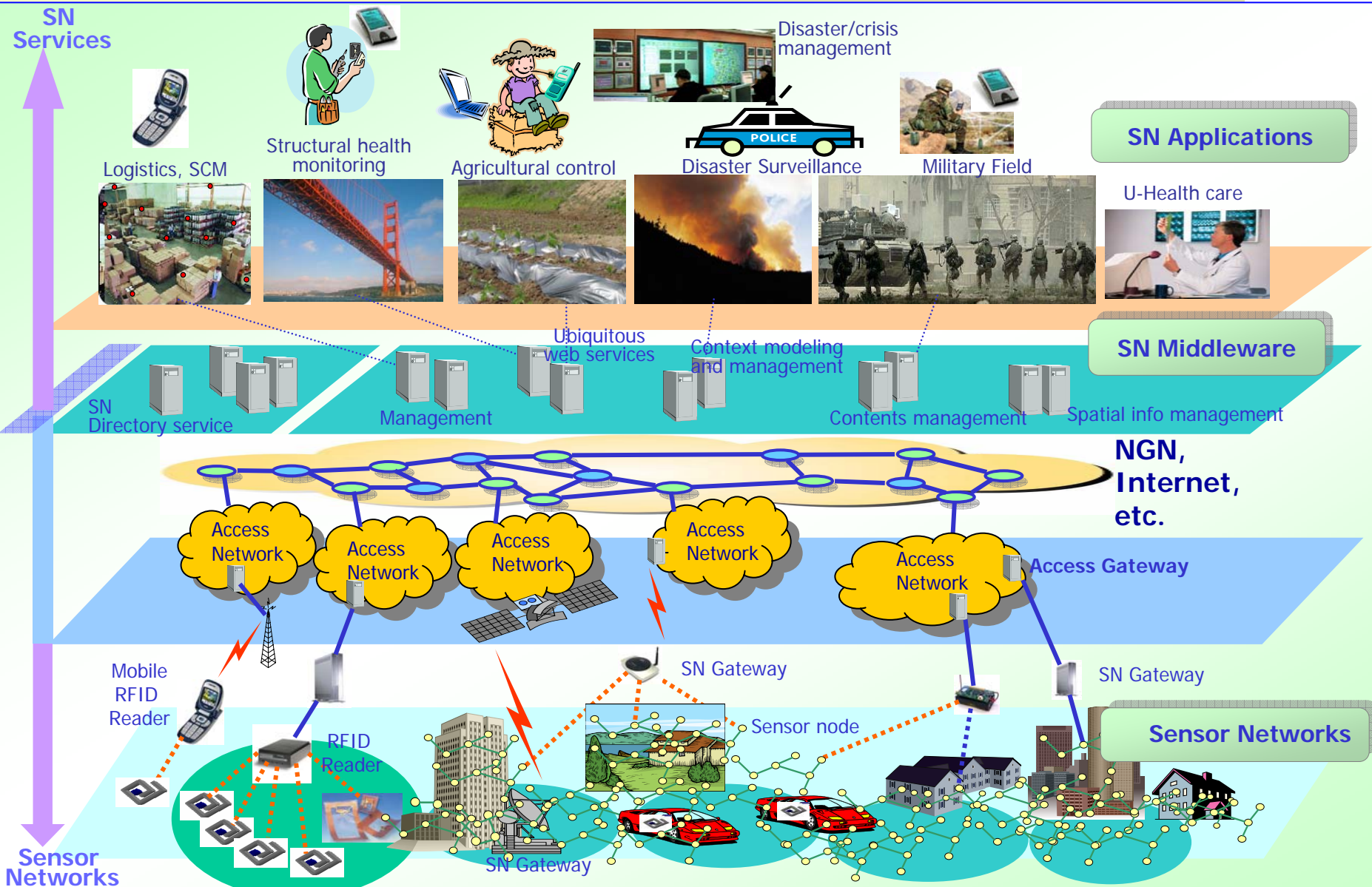

Sensor network standardization areas (2/2) SC6K

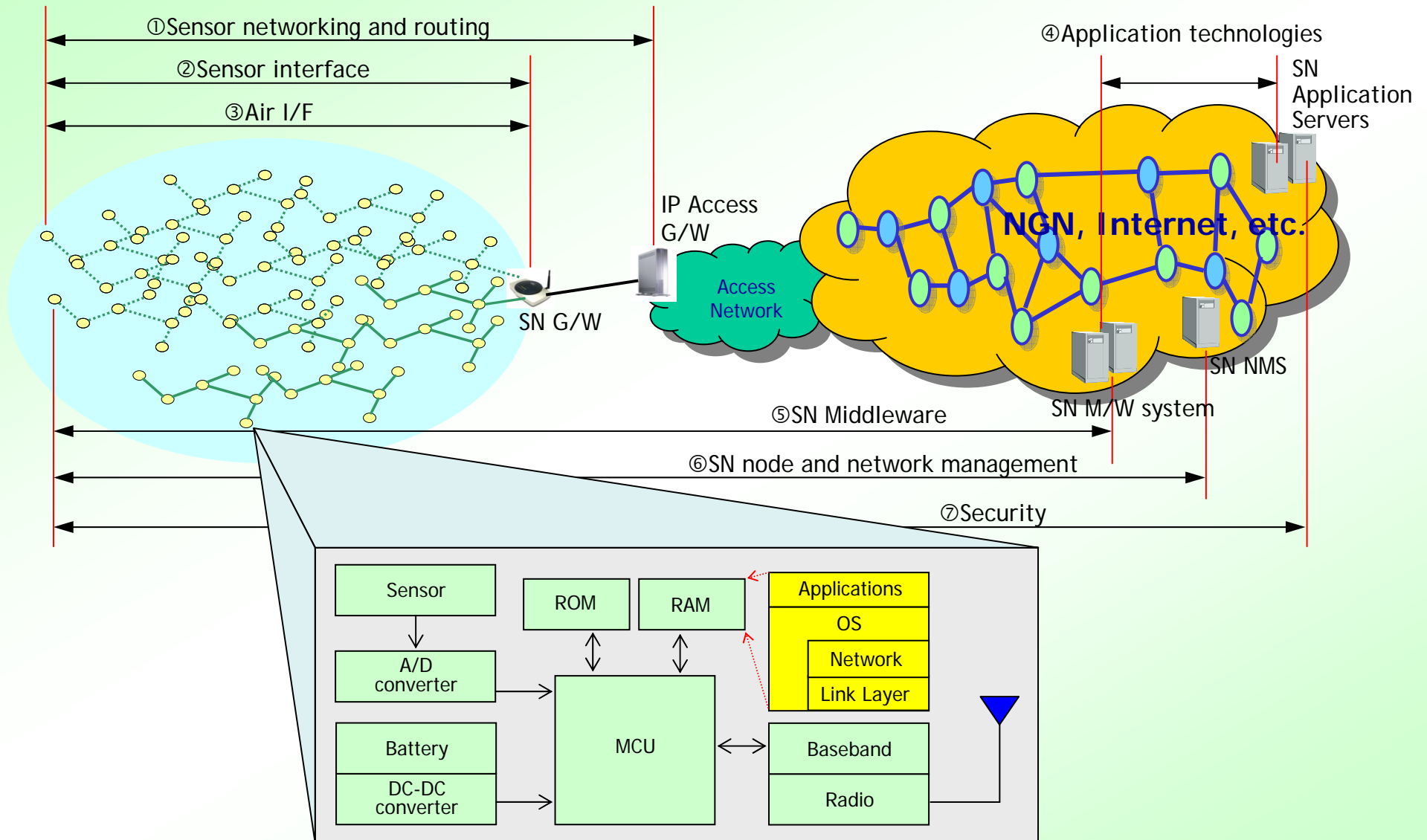

■ Requirements analysis

- Requirements analysis is required to specify features, functions, attributes and to limit supporting scope.
- Works to do:
 - Analysis of sensor network application models and scenarios
 - Analysis of service requirements and functional capability requirements in terms of PHY/MAC, sensor networking and inter-networking aspects and application layer issues



■ Architectural framework

- Architectural framework is required to see overall architectures and interface relationships due to heterogeneous networking factors as follows:

- Sensor network: non-IP or IP
- IP solution alternatives: 6LoWPAN, conventional IPv4, adapted IPv4, etc.
- Non-IP alternatives: ZigBee, TinyOS, etc.
- Access network: IPv4 or IPv6
- Various v4/v6 transitions
- Routing protocols
- Mobility

- Works to do:

- Reference model for system and network configurations and interface relationships

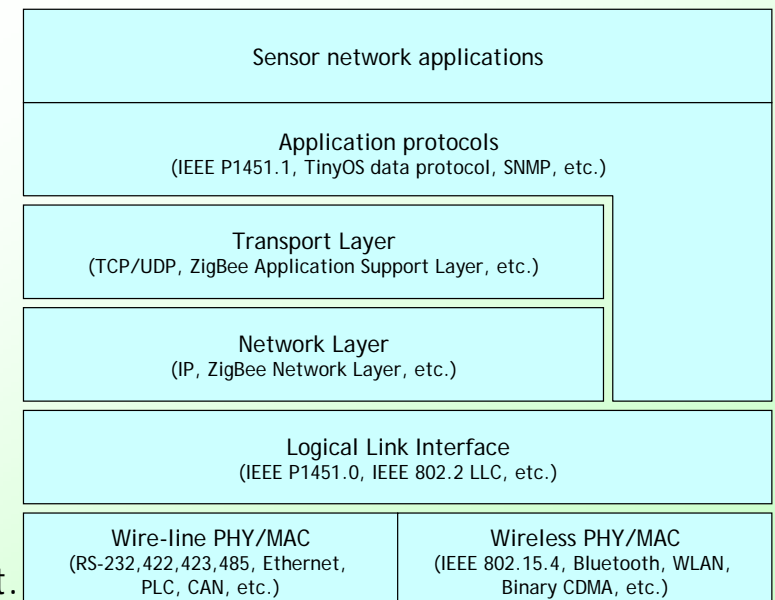

Does this type make sense? Maybe or not.

■ Application profiling

- Sensor network applications have vertical characteristics and each sensor network application may have unique requirements. Thus, application profiles are required.
- Works to do:
 - Application profiles to specify service features, processing functions, interface procedures, operation attributes, attribute values, etc.

■ Wireless sensor network PHY/MAC

- IEEE 802.15 originally focused on wireless networking of portable and mobile computing devices within PANs or short distance networks.
- But, sensor networks are used mainly for outdoor applications with different operation conditions.
- Works to do:
 - Alternative PHY/MAC for outdoor sensor network applications

■ Non-IP sensor networking

- Current solutions: ZigBee, TinyOS, Nano-Qplus, and proprietary solutions
- Works to do:
 - A standardized solution for non-IP sensor networking
 - How to integrate various non-IP solutions and interwork each other

■ IP sensor networking

- 6LoWPAN has been developed. TCP/IPv4 can be alternative. But they have lack of considerations on implementation profiles for IP networking standards. Application- and service-perspective issues should be taken into account.
- Works to do:
 - Implementation profiles for IP networking standards such as ICMP, ARP, IPv4, ICMPv6, NDP, IPv6, TCP, and UDP.
 - Application- and service-perspective issues such as application profiling, middleware functions, service discovery, etc. over IP-based sensor networks.

Existing non-IP sensor network solutions

ZigBee

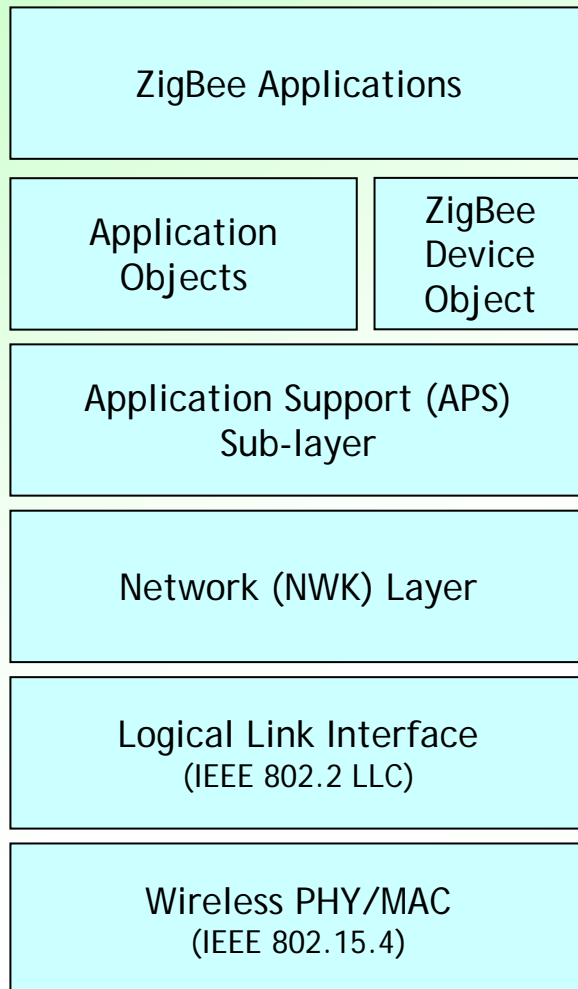

IEEE P1451

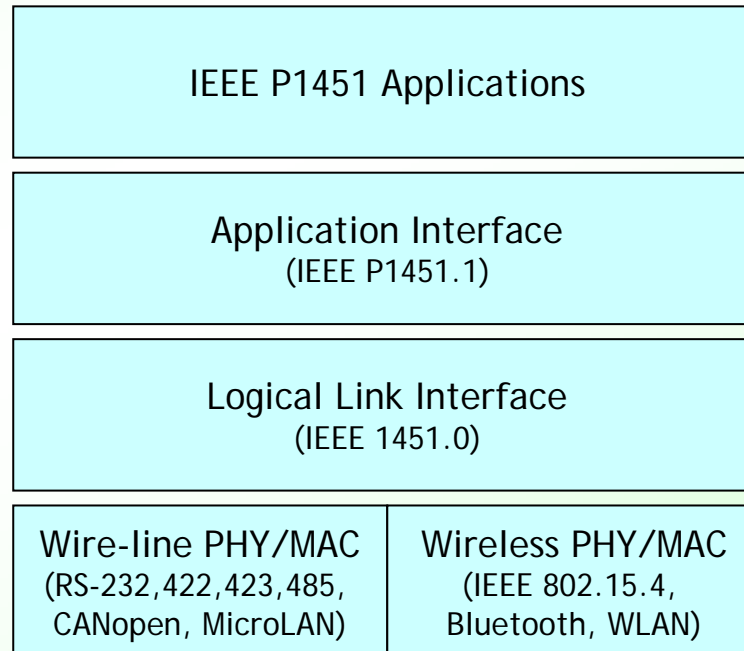

TinyOS

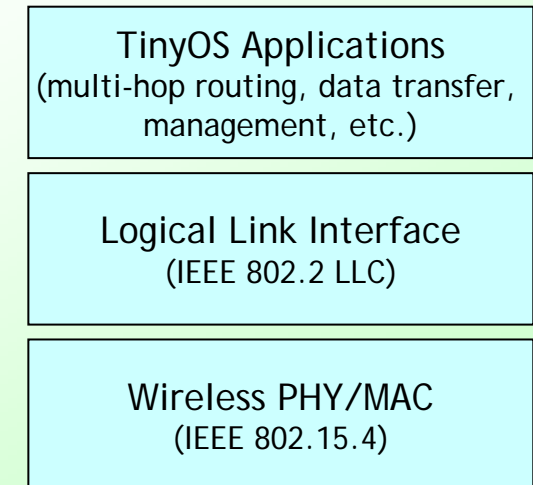

Existing IP sensor network solutions

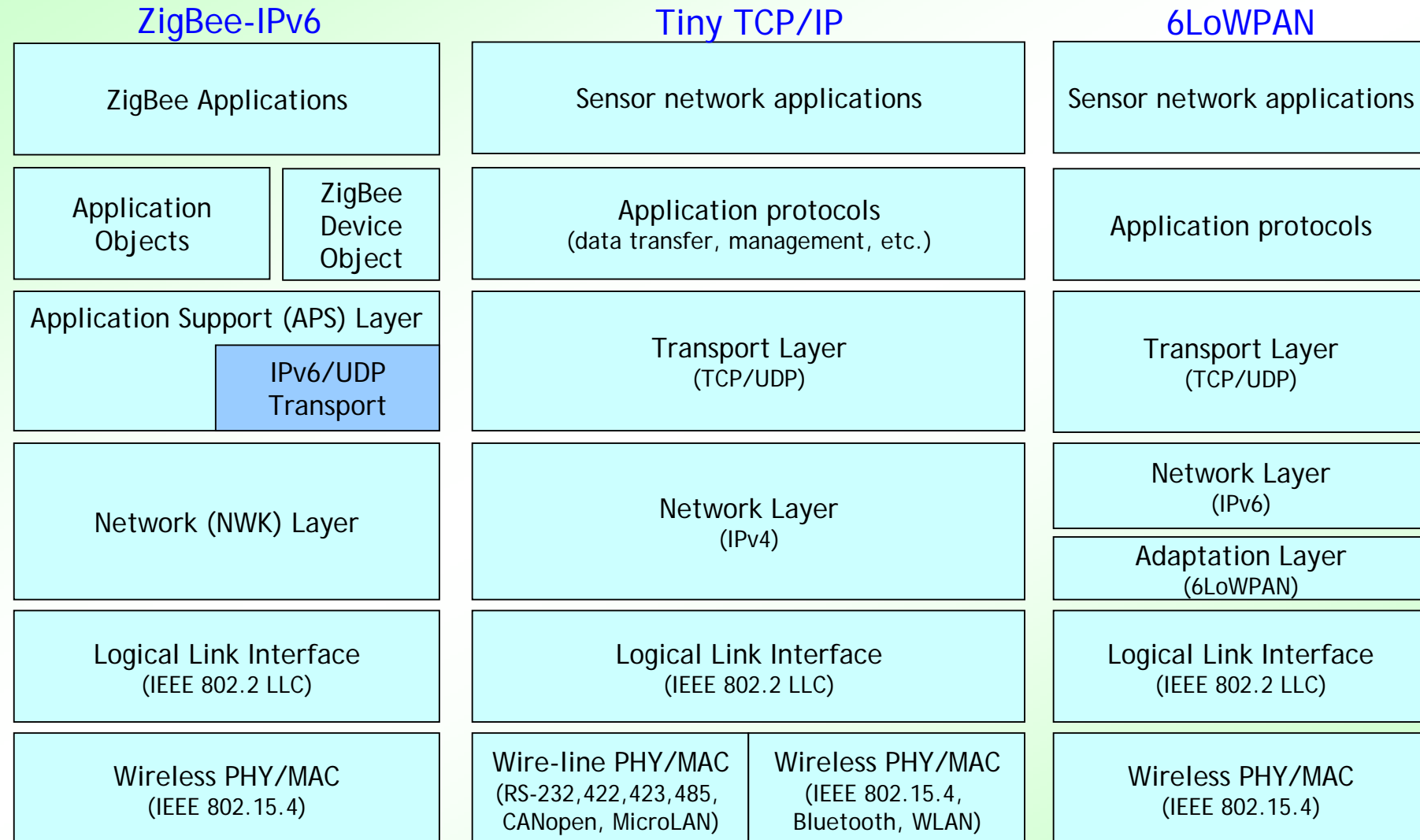

■ Inter-networking and interworking

- Two cases between non-IP and IP sensor networks and between these sensor networks and IP access network including v4/v6 interworking
- Interworking between application protocols, message formats, etc.
- Works to do:
 - Implementation guidelines for those inter-networking and interworking cases

■ Routing

- Sensor network-dedicated routing protocols are required.
- Works to do:
 - Energy efficient routing protocol
 - Routing protocol to handle nodes in sleeping mode during the most of time
 - Data-aware routing protocol, etc.

■ Mobility support

- Three mobility cases: Intra-WPAN; Inter-WPAN; and network mobility
- Works to do:
 - How to fit existing IP mobility technologies into sensor networks
 - Mobility-supporting protocols for non-IP based sensor networks

■ Network management

- IP and non-IP sensor networks have different management environments. A single management domain is required.
- Works to do:
 - Management protocol
 - MIB specifications
 - Node identification scheme
 - OID tree for every managed object
 - Ex) iso(1) org(3) dod(6) internet(1)

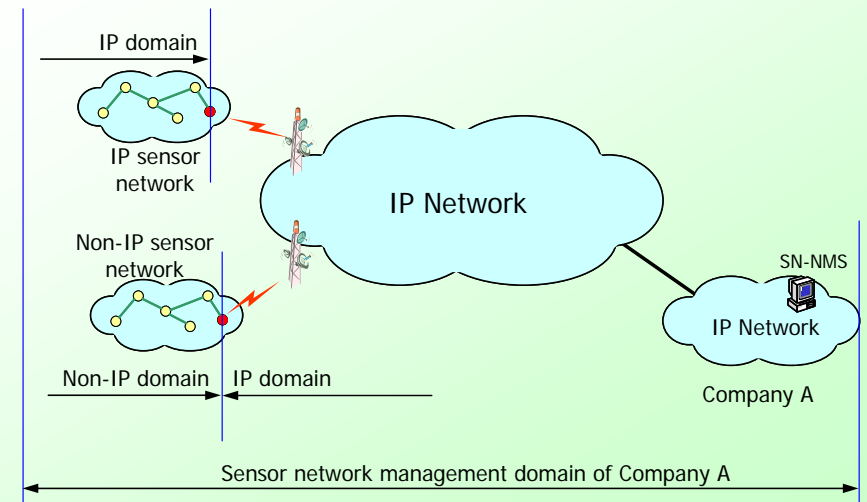

■ QoS

- QoS control is required for mission-critical applications and services but existing QoS mechanisms haven't taken into account sensor network requirements.
- Works to do:
 - A new QoS protocol, or
 - Modifications and/or extensions of existing solutions

■ Directory service

- Identifiers for sensor nodes are required to be resolved by directory service.
- Public information services require a directory service for information consumers to discovery and retrieve situational and environmental information contents.
- Works to do:
 - Extensions, additions and/or modifications to X.500, LDAP, DNS, etc.
 - A new directory service architecture, maybe

■ Middleware functions

- Expected functions:
 - Sensed data gathering, filtering by policy and rule, data aggregation, data comparison and analysis, data mining, context modeling, context-awareness processing, context-aware decision and estimation, service integration, etc.
- Works to do:
 - Technical specifications for these functionalities

Gap analysis between SDOs and SC 6 (1/5)

SC6K

■ IEEE 802.15 and SC 6/WG 1

	IEEE 802.15	SC 6/WG 1
Work items	<ul style="list-style-type: none">• IEEE 802.15.1, WPAN standard based on the Bluetooth v1.1 Foundation Specifications• IEEE 802.15.3, a new standard for high-rate (20Mbit/s or greater) WPANs• IEEE 802.15.4, WPAN standard for a low data rate solution with multi-month to multi-year battery life and very low complexity• IEEE 802.15.6, WPAN standard optimized for low power devices and operation on, in or around the human body (but not limited to humans) to serve a variety of applications including medical, consumer electronics / personal entertainment and other	<ul style="list-style-type: none">• WG 1 covers wire-line and wireless PHY/MAC standards.
Gaps	<ul style="list-style-type: none">• IEEE 802.15 has lack of considerations on outdoor and harsh operation environment such as difficulty in maintenances, long-chained network in tunnels or bridges, interference by moving objects, seasonal changes in mountains, high humidity in raining, etc.	

Gap analysis between SDOs and SC 6 (2/5)

SC6K

■ IEEE 1451/JTC 1 SC 31 and SC 6/WG 1,7

	IEEE 1451 and JTC 1 SC 31/WG 6	SC 6/WG 1 and WG 7
Work items	<ul style="list-style-type: none">• IEEE P1451.0: set of common commands and operations• IEEE 1451.1: common object model describing behavior of smart transducers• IEEE 1451.2: interface for P2P configuration• IEEE 1451.3: interface for multi-drop transducer network• IEEE 1451.4: interface for analog transducers with analog and digital operating modes• IEEE P1451.5: interface for wireless transducers• IEEE P1451.6: interface for high-speed CANopen• IEEE P1451.7: interface for sensors and actuators, transducers-to-RFID-systems-communication protocols and TEDS formats	<ul style="list-style-type: none">• WG 1 may cover interface between different PHY/MAC specifications.• WG 7 may cover how to integrate these interface standards from higher-layer points.
Gaps	<ul style="list-style-type: none">• The IEEE 1451 family is planned to be taken by SC 31/WG 6.• WG 1 and WG 7 may have some work items to communicate with IEEE 1451-based devices over their work layers.	

NCAP (Network Capable Application Processor), TEDS (Transducer Electronic Data Sheet)

Gap analysis between SDOs and SC 6 (3/5)

SC6K

IETF 6LoWPAN/ROLL and SC 6/WG 7

	6LoWPAN and ROLL	SC 6/WG 7
Work items	<ul style="list-style-type: none">• 6LoWPAN WG<ul style="list-style-type: none">- RFC 4919: 6LoWPANs - Overview, assumptions, problem statement, and goals- RFC 4944: Transmission of IPv6 packets over IEEE 802.15.4 networks- Next work items under consideration: interoperability; network management; routing; security; device/service discovery, etc.• ROLL (Routing Over Low power and Lossy networks) WG<ul style="list-style-type: none">- Routing requirements	<ul style="list-style-type: none">• WG 7 can cover some application issues as well as L3 and L4 network aspects.
Gaps	<ul style="list-style-type: none">• IPv4 could be an alternative solution to IPv6.• Implementation profiles for IP networking standards are out of scope of 6LoWPAN.• 6LoWPAN focuses only on IPv6 networking aspects and application- and service-perspective issues are out of scope.	

■ ZigBee Alliance and SC 6/WG 7,8,9

	ZigBee Alliance	SC 6/WG 7, 8 and 9
Work items	<ul style="list-style-type: none">• Working on networking, application, management and security matters over IEEE 802.15.4	<ul style="list-style-type: none">• WG 7 can cover some application issues as well as L3 and L4 network aspects over IEEE 802.15.4• WG 8 covers directory-dependent application matters.• WG 9 covers OID-based management matters.
Gaps	<ul style="list-style-type: none">• ZigBee is one of non-IP networking and application enablers for sensor networks and there are many proprietary solutions.• SC 6 could develop an internationalized standards set of non-IP networking and application.	

Gap analysis between SDOs and SC 6 (5/5)

SC6K

■ ITU-T and SC 6/WG 7, 8 and 9

	ITU-T	SC 6/WG 7, 8 and 9
Work items	<ul style="list-style-type: none">• Y.USN-reqts, ITU-T Q.2/13: Requirements for support of USN applications and services in NGN environment• F.USN-MW, ITU-T Q.22/16: Service description and requirements of USN middleware• X.usnsec-1, ITU-T Q.9/17: Security framework for USN	<ul style="list-style-type: none">• WG 7 can cover some application issues as well as L3 and L4 network aspects.• WG 8 and WG 9 can cover some of application aspects.
Gaps	<ul style="list-style-type: none">• SC 6 and ITU-T have exchanged collaboration liaisons on ITU-T's works.	

■ SC 6 has recognized sensor networks.

- Mesh-enabled USN was discussed at SC 6/WG 1 meetings held in Orlando, USA, Nov. 2004; Frankfurt, Germany, Feb. 2005; Saint Paul De Vence, France, Aug. 2005; and Prague, Czech, June 2006.
- SC 6 took sensor networks for its business plan in Xian, China, April 2007.

■ SC 6 participated in ITU-T JCA-NID/USN meetings.

- JCA (Joint Coordination Activity) on NID (Network aspects of identification systems including RFID) and USN (Ubiquitous Sensor Network)
 - It covers coordination and collaboration activities among ITU-T Study Groups and with other relevant SDOs outside ITU-T.
- Ms. Valerie Barnole participated in the JCA-NID meetings as the liaison representative of SC 6.

- SC 6 coordinated sensor network std initiative with SC 31.
 - SC 31 discussed about new works on sensor networks as well as sensor-assisted RFID matters.
 - SC 6 coordinated sensor network standardization initiative with SC 31 and finally SC 31/WG 6, expected successor of the MIIM ad-hoc group of SC 31, made a resolution to exclude the sensor network area and focus only on sensor-assisted RFID matters and sensor interface standards specified by IEEE 1451.
- SC 6 and ITU-T SGs reached consensus about close collaboration on sensor network activities.
 - ITU-T is developing Y.USN-reqts, F.USN-MW, and X.usnsec-1.
 - SC 6 and ITU-T SG13,SG16,SG17 have exchanged several positive liaison statements for collaboration on the drafting works.
 - Further exchanges are expected to make progress on the works.

- SC 6 needs inter-WG activities within SC 6 and collaboration with ITU-T SGs.
 - Each WG of SC 6 may have new work items to realize sensor network applications and services, which means inter-WG activities are required.
 - ITU-T SGs are working on USN matters and have exchanged relevant liaison statements with SC 6, which means collaboration and coordination activities between SC 6 and relevant ITU-T SGs are required.
 - Thus, it is recommended for SC 6 to designate someone as a sensor network rapporteur to care for its coordination and collaboration activities.

- This standardization initiative of sensor networks can evolve existing sensor network applications and enable smart information society based on emerging sensor network applications penetrated in everywhere.
- SC 6 could take some new work items among the open issues for sensor network standardization.
- Existing relevant SDOs are working on sensor network matters but there are still some missing issues and SC 6 could take new work items as well as missing issues of other SDOs.
- SC 6 has done sensor network standardization activities and now it is the time to start a real work.
- SC 6 needs a collaboration and coordination rapporteur for inter-WG and outside activities.

Q/A