

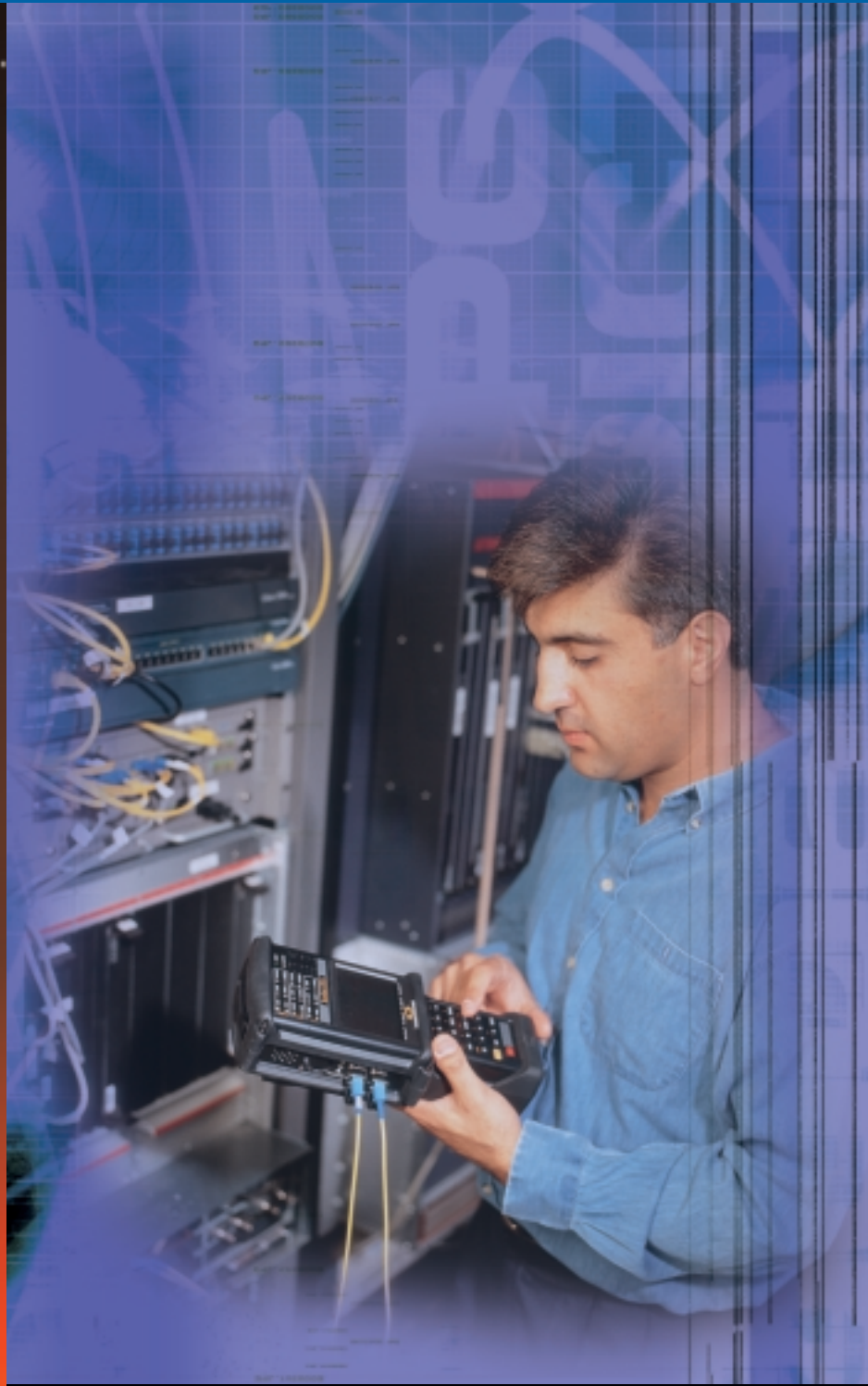

**Advanced Test Equipment Rentals**  
**www.atecorp.com 800-404-ATEC (2832)**



**SUNRISE TELECOM**

*... a step ahead*

**SunSet™ OCx**

Introducing the world's smallest  
optical network test set—the powerful

# SunSet

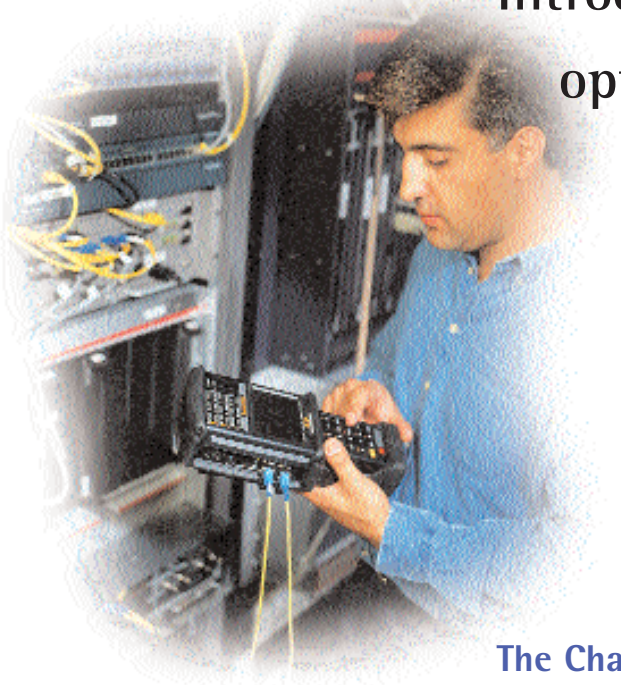

## The Challenge— Comprehensive Access Network Testing

As telecommunications networks expand to higher bandwidths and wider arrays of services, it becomes more and more difficult to properly install, maintain and troubleshoot them. A typical technician may be responsible for turning up and integrating many different services, requiring a host of skills, training and equipment.

In addition, the modern access network combines many independent physical and protocol layers. A single voice or data connection may span the networks of several different companies including Regional Bell Operating Companies (RBOCs), Incumbent and Competitive Local Exchange Carriers (ILECs and CLECs), and other private and public networks.

## A Single Solution for Protocol Analysis and Physical Layer Troubleshooting— The SunSet OCx

The SunSet OCx is the latest generation of access network test sets from Sunrise Telecom, the industry leader in design and manufacture of handheld telecommunications service verification equipment. It offers DS0 to OC-12 testing, along with all the service verification tools you need, including ATM, GR-303, Voice and ISDN PRI. Technicians can increase efficiency, consolidate training, and save time and money by testing all these rates and services with a single handheld unit. Among handheld testers, only the SunSet OCx has the feature set to ensure quality connections across the entire access network.

# OCx



- The next generation access network test set
- DSO to OC-12
- Full ATM analysis
- Signaling support for voice, GR-303, ISDN PRI, SS7

## A Complete Kit of Powerful Protocol Analysis Tools — In One Handheld Unit

Incorporating the most popular and powerful features for testing T-carrier (T1 and T3) and Synchronous Optical NETWORKS (SONET), the SunSet OCx is also a full-featured protocol analyzer with Internet Protocol (IP), Asynchronous Transfer Mode (ATM), Primary Rate Integrated Services Digital Network (ISDN PRI), Bellcore GR-303-CORE, and Signaling System #7 (SS#7), as well as traditional voice frequency (VF) and trunk conditioning functions.

The SunSet OCx is battery powered and field upgradeable. Its light weight, durability, long battery life and low cost make it the ideal tool for field technicians in the Access Network. The comprehensive measurements and advanced features are also well-suited for central office and laboratory environments.

### Power to Grow

The SunSet OCx has the flexibility to grow as your network grows. If you only require DS3 and DS1 testing today, you can add SONET testing later with an easy software upgrade. Add features like ATM and GR-303 when you need them. Maintenance software upgrades and enhancements are available at no cost throughout the 3-year warranty period.

### Dual-color LEDs

Check your circuit's operation at a glance, making testing as simple as "green is good; red is bad." Signal status is displayed simultaneously for all rates.

### Optical Ports

The SunSet OCx can be configured for SC or FC optical connectors, 1310 or 1550 nm.

### Straightforward Results

There is no need to decipher or dig through results. The SunSet OCx provides all results in an intuitive, convenient manner.

### Handset Jack

A convenient connector allows you to plug in a handset, enabling simultaneous communication over two DS1 drops or two PRI voice calls. The handset is also useful for noisy, central office environments.

### Auto Key

The AUTO key eases test configuration, letting you test more quickly, efficiently, and accurately.

### Easy to Use

The OCx has a clear backlit display and well-organized measurement screens that allow for quick access to all test results. The dual-state LEDs give unambiguous alarm and error information. The measurement screens collect all the important data at a glance; the dynamic summary screen provides an up-to-the-moment summary of all errors and alarms. Intuitive menus and function keys allow technicians to configure the test set quickly. The AUTO key simplifies test setup.

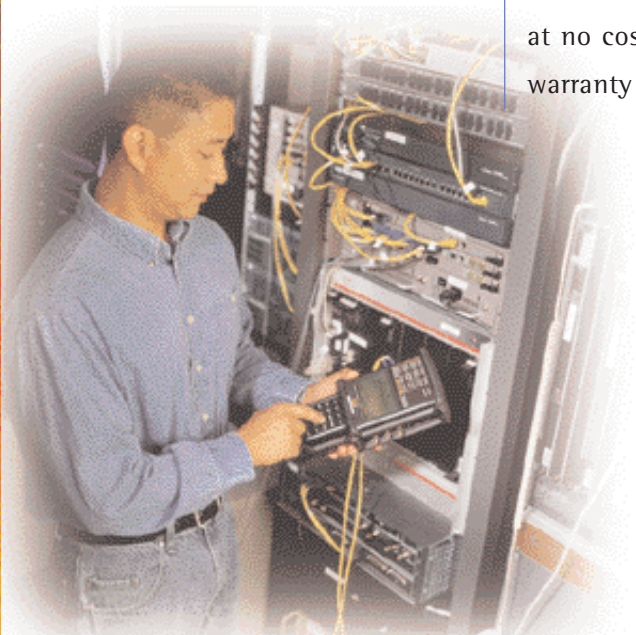



### Serial Port

Print your results or store them on your PC for later review.

### DSI Ports

Dual DSI Tx/Rx ports provide connections for full duplex T1 monitoring and drop/insert testing.

### Built-in Speaker

Listen to speech over DS0, PRI, or orderwire, or listen to DS0 tones using the convenient, hands-free speaker.

### STS-1/DS3 Ports

Test and monitor STS-1 and DS3 circuits.

### ERR INJ Key

Inject errors at DS1, DS3, or SONET rates to verify connectivity and response from network elements or to stress-test the network.

### Built-in Microphone

Talk over DS0, PRI, or orderwire using the convenient, hands-free microphone.

### Basic Testing Features

- BERT up to 622 Mb/s
- Bi-directional DS1 drop/insert
- Loopback and span control
- VF/DSO and fractional T1
- Full complement of test patterns
- Error injection and alarm generation

### Advanced Testing Tools

- Mux/Demux Testing & Emulation
- Pulse Mask Analysis
- SONET Overhead Control
- DS3 FEAC & C-bit Monitoring
- DS1 Datalink (ESF, SLC96)

### Protocol Analysis/Emulation

- ATM/IP
- VF Dialing
- ISDN PRI
- GR-303
- SS#7

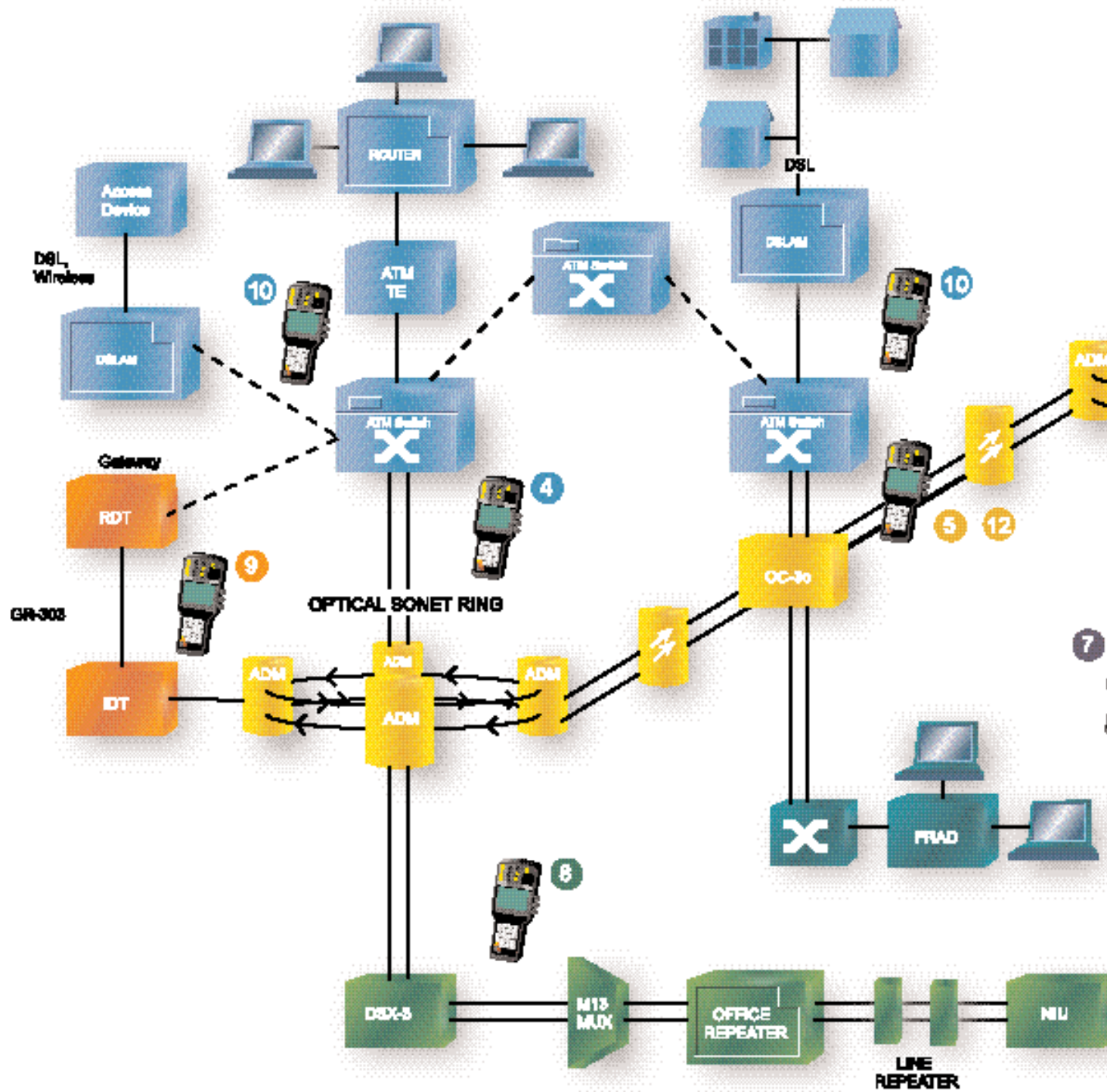

## Access Network Applications

The SunSet OCx can go anywhere your network takes you.

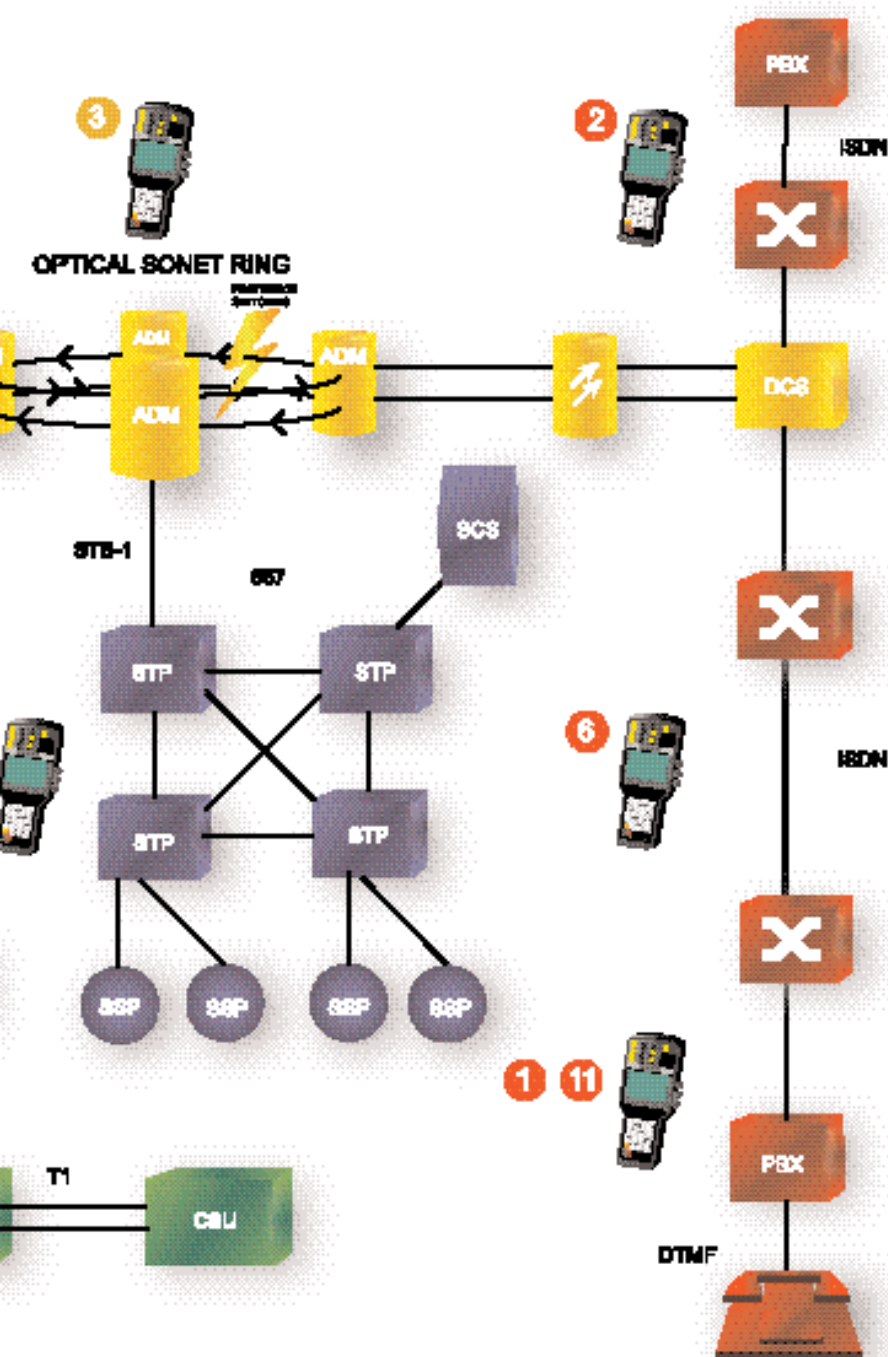

- 1 Place/receive calls toward PBX or switch. Monitor live calls; troubleshoot protocol problems.
- 2 Install and troubleshoot ISDN PRI circuits.
- 3 Test automatic protection switch timing.
- 4 Monitor VCCs, ATM Qos, OAM and BERT.
- 5 Establish & analyze SONET link to Network Elements. Loopback and BERT T1 channels. Place calls on T1 channels.
- 6 Monitor MF signaling on inter-office trunks.
- 7 Perform inexpensive first-pass analysis on SS7 signaling problems.
- 8 Bring T3 or T3/T1 circuits into service. Loopback T1 devices from any access.
- 9 Troubleshoot GR-303 links. Unify voice traffic reaches PSTN; troubleshoot signaling and monitor alarm information.
- 10 Ping the PC or ISP. Point-to-Point test an ATM VPI/VCI.
- 11 Place/receive calls through PBX or switch. Monitor live calls, voice, signaling, winks, digits, call states.
- 12 Troubleshoot new optical circuit turn-ups.

## Advanced SONET transmission testing & analysis—in a handheld

Don't let its size fool you—the SunSet OCx offers extensive features for SONET testing and analysis. With the SunSet OCx, operators can access the SONET network at the optical or electrical interface, including STS/OC-1, OC-3/3c and OC-12/12c. It supports mapping from DS3, DS3/DS1 and VT1.5. Comprehensive SONET errors and alarms are conveniently sorted by near-end and far-end, section, line, and path, complying to Bellcore GR-253. Tests range from simple verification of power level & frequency for efficient field installation and maintenance, to advanced features like overhead control/decode and multiplex testing.

### SONET for the field

The SunSet OCx is uniquely suited for field applications. What other SONET analyzer weighs less than 3 pounds and runs for hours on battery?

### Applications for the field technician include:

- Verify network continuity with BER testing
- Easily detect SONET errors/alarms with LEDs and well-organized results screens
- Verify proper frequency and power level
- Monitor pointer movement in the network or adjust the pointer values to stress network elements
- Check the network's automatic protection switch (APS) function and measure the amount of time it takes for the network to complete a switchover.

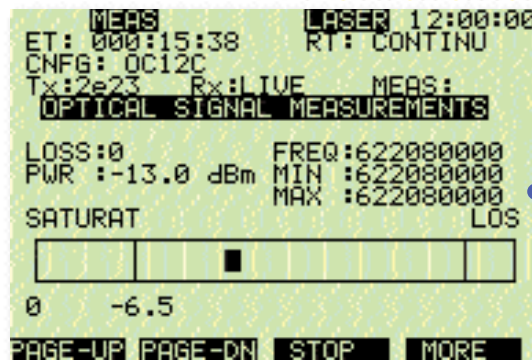

Field operators can quickly verify signal level with an easy to read power measurement.





```

12:00:00
SEND K1,K2 BYTES
K1 BYTE
BITS1-4 REQUEST
1101 SF high priority
BITS5-8 CHANNEL
0001 Working Channel 1
K2 BYTE
BITS1-4 CHANNEL
0001 Working Channel 1
BITS5 ARCHITECT
1 1:N
BITS6-8 ALARM
111 AIS
BIT=0 BIT=1 SEND
    
```

Advanced users can control/read Sonet overhead bytes. The english decodes make overhead simple.

### SONET Overhead Control

The SunSet OCx allows the user to easily access the entire section, line and path overhead to monitor and test the SONET network. Important network properties such as parity (B1, B2, B3 and VTBIP-2), protection switching (K1, K2), pointers (H1-H2), plus network status and alarms (M0/M1, S1, G1) are readily available. The user can also view network traces (J0, J1, J2), IDs and labels (C1-C2), communications channel (D1-D3, D4-D12) and user-defined messaging (F1, F2).

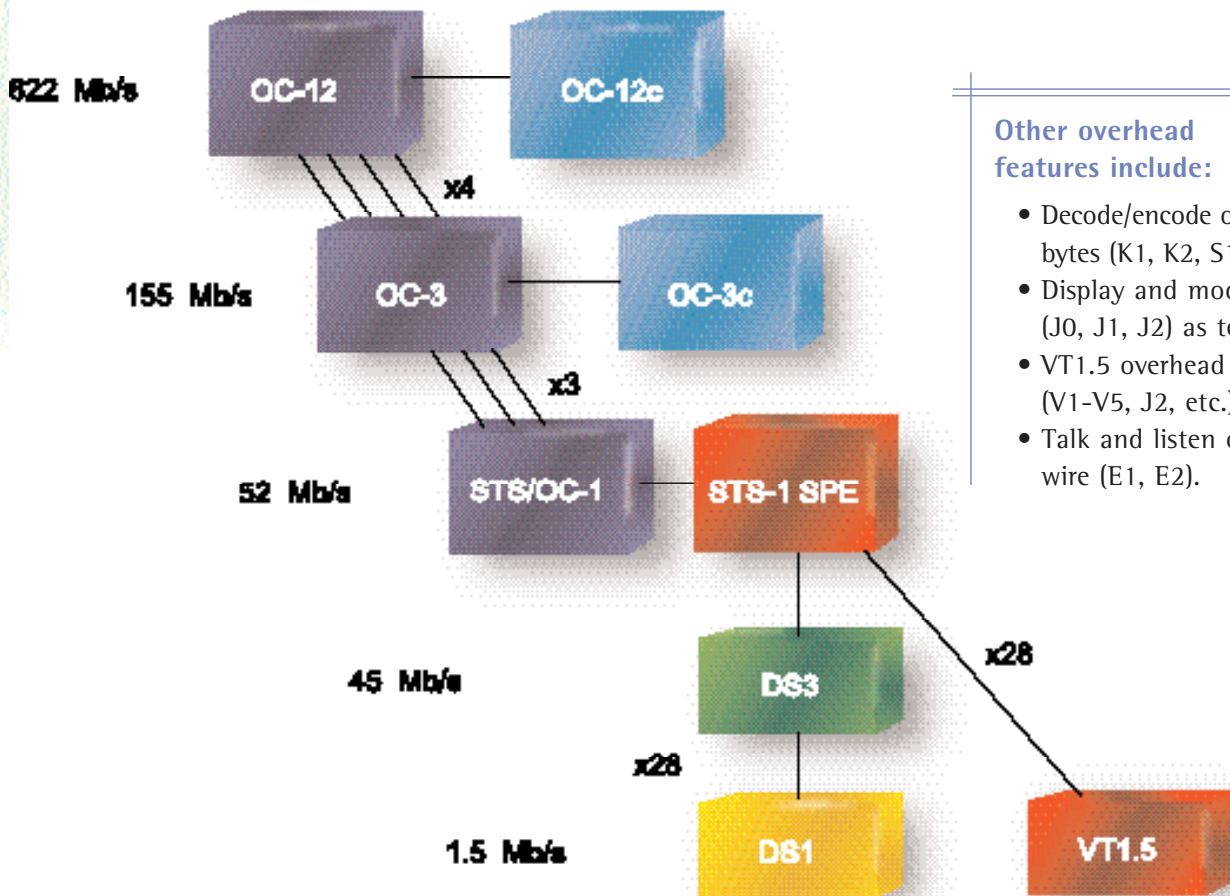

### Other overhead features include:

- Decode/encode of vital overhead bytes (K1, K2, S1, etc.)
- Display and modify traces (J0, J1, J2) as text characters
- VT1.5 overhead control (V1-V5, J2, etc.)
- Talk and listen over order wire (E1, E2).

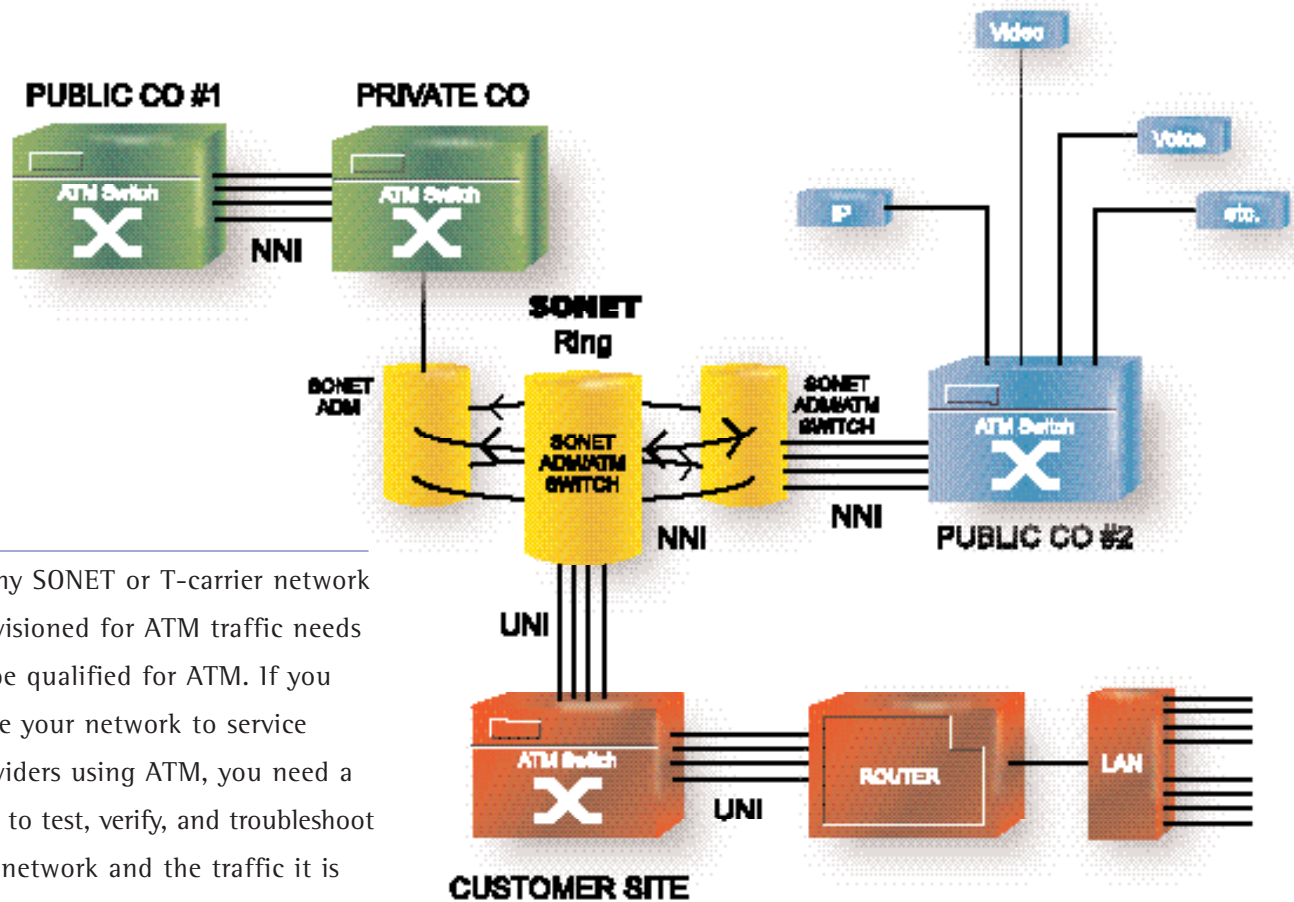

Any SONET or T-carrier network provisioned for ATM traffic needs to be qualified for ATM. If you lease your network to service providers using ATM, you need a tool to test, verify, and troubleshoot the network and the traffic it is carrying. Conversely, if you are responsible for the ATM traffic, you must verify that the network is error-free and functioning properly, especially when you do not own the network. When traffic is disrupted, you cannot waste valuable time and money pointing fingers.

The SunSet OCx is the single testing solution for both the physical layer and ATM layer. With one test set, a single technician can verify network performance with and without ATM traffic. All applicable network rates are available in one chassis, eliminating the need for multiple ATM testers if the ATM network spans several subnetworks.

The full-featured ATM testing capabilities of the SunSet OCx provide the power and flexibility to install and troubleshoot an ATM network from the ground up. The OCx can test and monitor between network elements (NNI) and between the network and edge devices (UNI), verify network provisioning, stress test, BERT, and monitor response to alarms, errors and OAM cells. The SunSet OCx allows you to non-intrusively monitor traffic across the network, gathering statistics on congestion, bandwidth, idle cells OAM cells and errors.

```

MEAS LASER 12:00:00
DETAIL TRANSMIT VCC CONFIG.
# UPI UCI PTI CLP
1 008 00035 001 0
PAYLOAD :2e15 STATUS:ACTIVE
SEQUENCE #:ON TIME STAMP:ON
TRAFFIC: NRTVBR
PCR : 25 % (037.4 Mbps)
SCR : 48 % (088207 Cps)
MBS : 9 CELLS (071.9 Mbps)
(169575 Cps)
NEXT PREU OAM/ERR

```

### Traffic Generation:

- Generate one to six independent VCCs. Perform up to six separate traffic tests at once. Each stream can have different traffic statistics, test patterns and addresses.
- Programmable traffic pattern: CBR, rt-VBR, nrt-VBR, Sequential Cell. Select the peak cell rate, sustained cell, and maximum burst rate, as appropriate, either as a percentage of bandwidth, or an absolute bit rate.
- Insert OAM cells: F4/F5, Segment/End-to-End, FM cells. Verify the alarm and loopback response of ATM network elements.
- Inject errors.

```

MEAS LASER 12:00:00
VCC STATISTICS AND BERT
ET: 000:00:19 RT:CONTINUOUS
# UPI UCI CELL RATE
COUNT CELLS/s
1 8 35 2.063e04 2.948e03
2 987 5632 3.396e04 4.852e03
3 3 16 4.451e04 6.359e03
4 123 45678 2.007e04 2.867e03
5 2763 2582 3.975e04 5.679e03
6 13 130 5.102e04 7.288e03
TOTAL :2.100e05 CHEC :0.000e00
DISCRD:0.000e00 NCHEC:0.000e00
IDLE :5.784e05 HECR :0.000e00
DETAIL STOP CONTINU more

```

### Traffic Supervision:

- Scan 128 VCCs for header information. View the traffic moving across the network including the addresses and cell loss priority. Select suspicious streams to filter and analyze.
- Monitor six traffic streams simultaneously. Measure cell count, cell rate, total cells, discarded cells, idle cells, HEC errors and non-correctable HEC errors and HEC error rate.
- BERT, Quality of Service (QoS), and OAM measurements. The SunSet OCx compiles vital network measurements including bit error rate, cell count, congestion and bandwidth, cell loss and cell error ratios, cell delay and time variation. Users can also view the number and total time of OAM events such as AIS and RDI alarms.

### Cell Capture & Decode:

- Capture and store cells. Save user and/or OAM cells in one of ten memory slots. Each slot holds over one thousand cells. View, decode and analyze saved cells at any time.
- Header decode. The OCx displays the meaning of the header values, including general flow control (GFC), VPI/VCI, and payload type indicator (PTI), plus any time stamps and sequence numbers.
- OAM cell decode. The OCx can decode all forms of OAM cells. Decipher the location IDs for AIS, RDI and Loopback cells. Retrieve and read important PM statistics like total received cell count and block error results. Verify the activated PM block size.

```

MEAS LASER 12:00:00
CELL DISPLAY
FIRST CELL:0001 CURR CELL:1428
LAST CELL:2048 GOTO CELL:0024
(Press ENTER)
00 00 02 3A D9 <-- HEADER
18 01 AA AA AA AA FF FF
FF FF FF FF FF FF FF FF
FF FF FF FF FF FF FF FF
FF FF FF FF FF FF FF FF
FF FF FF FF FF FF 6A 6A
6A 6A 6A 6A 6A 6A 02 36
OAM E5 ETE LOOPBACK
HEADER OAM SAVE more

```

### ATM IP Testing:

- Verify and measure an IP connection through the ATM network.
- Bridge and Route (per RFC 1483), PPP, and DHCP.
- Ping and automated ping response. Specify number of pings and delay between pings. The OCx counts the number of successful pings, lost pings, and response time.

## Powerful signaling and protocol analysis in your hand

### ISDN Primary Rate Testing

PRI trouble can be caused by a variety of sources such as physical layer errors, timing, or switch translations and protocol problems. A PRI test set that combines full-featured T1 and PRI testing lets you identify the trouble the first time and avoid costly revisits. The SunSet OCx's ISDN Primary Rate option rivals protocol analyzers and equipment dedicated solely to PRI testing. The OCx can be used to install new PRI circuits or PBX equipment by placing/receiving voice and data calls. Talk/listen and BERT testing verifies the B-channel connection. In-service monitoring can troubleshoot problems with a full D-channel decode, message filters and storage.



```
>Tx: RR          RDV Rx:RR          12:00:00
ELAPSED TIME:
000:01:34
ERROR COUNT B3:
NO ERROR
PAGE-UP PAGE-DN STOP HOLDSCR
```

```
MEAS          12:00:00
>Tx1:RR       RDV Rx1:RR
CURRENT TRACE
2000-09-09 17:26:41.816 #00014
L1 TE<-NT C/R:IC P/F:0
SAPI : 000 TEI : 000
L2 MSGTYPE I
NS : 000 NR : 000
L3 MSGTYPE SETUP
CALLREFL : 02 CALLREFU : 028
PAGE-UP PAGE-DN HEX InfoElem
```

### PRI Highlights:

- TE/NT Emulation
- National ISDN, AT&T Custom, and Nortel DMS
- 23B+D, 47B+D, or 46B+2D testing
- Talk/listen for voice calls: Standard, 3.1k
- BERT data calls: 56k, 64k, Nx64k
- Backup D-channel test for NFAS circuits
- D-channel monitor with full decode
- Trace filtering and storage.

### SS#7

The SS#7 option places powerful SS#7 protocol analysis and monitoring in the hands of the field technician. Protocol decodes help technicians determine a preliminary diagnosis to SS#7 network problems. Statistics screens shows traffic utilization, frame types and retransmission. Powerful filters aid in quick troubleshooting by focusing on a specific customer, message type, OPC/DPC, etc.

## VF/DSO Testing

SunSet OCx contains complete diagnostic tools necessary to install and troubleshoot voice circuits. Full duplex drop and insert testing allows the user to place a call on one channel while the T1 remains in service.

Verify and monitor service, signaling, digits, noise level, and check the voice path with the integrated microphone and speaker or handset. Full physical layer results allow transmission, verification, signal level and checks for any error or alarm conditions.

### VF/DSO Highlights:

- Full duplex drop and insert testing
- Talk/listen or send/receive test tones
- E&M, loop-start, ground-start with FXO/FXS
- Dialing: DTMF, MF, pulse
- Digit capture and analysis
- Scan mode for receiving calls or digits
- Noise Measurements: S/N, 3k-flat, C-message, C-notch
- Monitor calls: voice, signaling sequences with time-stamps.

```

MEAS 12:00:00
DTMF ANALYSIS
DIGIT-4 : 3          INTD: 99  ms
H/L Hz: 1477 /697  PERD: 102 ms
dBm: -5.1 /-5.2  TWST: 0.1
DIGIT-5 : 2          INTD: 98  ms
H/L Hz: 1336 /697  PERD: 102 ms
dBm: -5.0 /-5.2  TWST: 0.2
DIGIT-6 :           INTD: 99  ms
H/L Hz: 1209 /699  PERD: 101 ms
dBm: -5.1 /-5.2  TWST: 0.1
PAGE-UP PAGE-DN
  
```

```

MEAS 12:00:00
NOISE MEASUREMENT
Rx CHAN: 07

RESULTS
Signal to Noise: -0.1 dB
Noise C-Message: 65.8 dBBrnC
Noise 3K-Flat : 77.2 dBBrn
Noise C-Notch : 65.9 dBBrn

NEXT PREV
  
```

## GR-303

The increased deployment of GR-303-based DLCs and access devices creates new provisioning challenges and troubleshooting problems. The SunSet OCx meets these new testing challenges for all aspects of GR-303 systems: monitoring the TMC/CSC control channel, viewing robbed ABCD signaling and dialed digits,

listening to voice channels, and thoroughly testing the physical layer. The GR-303 option troubleshoots signaling problems between the switch and remote terminal. You can determine call status, monitor for any dropped calls, detect any abnormal conditions and identify when service was unavailable.

### The OCx performs:

- Bi-directional monitoring of TMC/CSC/EOC
- Full L3 decode of TMC/CSC messages including message type, customer, DS1#, DS0# and cause values
- Full L7 decode of EOC channel including ROSE and CMIP protocols
- Quick summary of any abnormal or invalid conditions via statistics screen; i.e., channel unavailable, protocol problems, or ring failure.

## Comprehensive T-Carrier Testing

Just because the SunSet OCx is designed for high speed optical rates and data-centric protocols like ATM does not mean that you need to sacrifice the traditional T-carrier applications. In fact, the SunSet OCx offers all the transmission testing applications for T1 and T3 circuits.

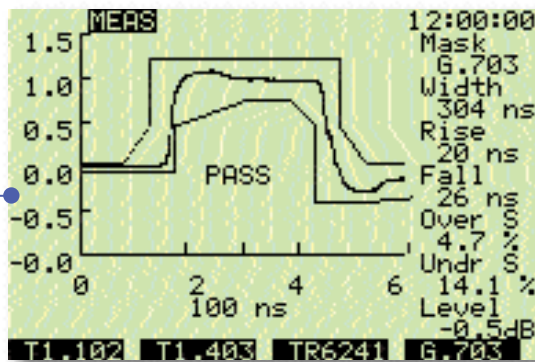

### Pulse Mask Analysis

The pulse mask feature gives the user a quick and powerful tool to analyze and qualify a DS1 or DS3 circuit. The SunSet OCx measures the pulse shape and key parameters and pulse templates based on governing standards provide a simple pass/fail test.

### Highlights:

- Dual DS1 ports for full duplex testing
- Frequency measurements to identify clockslips
- Level and simplex current measurements
- Live display of received data
- Standard stress patterns like 550octet and DALY
- Fractional T1 with auto-configuration

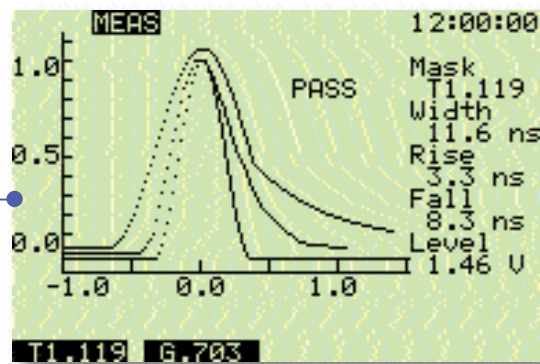

### Loopback Testing

The OCx can loop-up and loop-down CSU and NIU equipment using in-band or ESF datalink codes. The user can also control addressable repeaters and loopback HDSL cards. Such control allows a technician to isolate a fault quickly from a single location, saving time and truck rolls. The OCx can also emulate CSU or NIU equipment and respond to loopback commands.

### Datalink Testing

Monitoring the ESF datalink is an excellent way to discover errors which otherwise could not be detected at your monitoring point. Decodes of bit messages provide valuable information such as alarms, protection switching and network clock synchronization.

### DS3 Testing

DS3 testing capabilities include FEAC, C-bit monitor/control and FEAC stuff-bit loopback control. The OCx supports both DS3 and DS3/DS1, including DS3/DS1 span control.

## Remote Control

Technicians can remotely operate the SunSet OCx from a PC or VT100 terminal. Simply connect the OCx serial port using a standard printer cable and null modem adapter. A graphic user interface that exactly duplicates the look and feel of the OCx is available for Windows-based PCs.

## Related Products



### SunSet™ SDH

Powerful SDH/PDH Access Network Test Set:

- SDH/SONET: STM-0, STM-1e, STM-1o/OC-3
- PDH: 2, 34, and 139 Mbit/s
- T-Carrier: 1.5 and 45 Mbit/s
- VF/DSO Testing
- ATM Testing

The SunSet SDH is the world's most compact and comprehensive SDH handheld test set, incorporating PDH and T-carriers testing capabilities. It provides powerful BER testing with advanced analysis functions.

Sunrise Telecom is a global leader in innovating service verification equipment for a growing variety of telecommunications environments and technologies. We are constantly advancing industry standards in handheld telecom test equipment with leading edge innovations to our SunSet products: our renowned easy-to-use graphical interface for viewing circuit status information; first to market software memory cards that instantly augment or upgrade our SunSets' already impressive feature options; and elegant internal designs with state of the art integrated circuitry to enable ever more feature-rich handheld products.

Sunrise products have found broad acceptance in domestic and international markets, with a customer base that includes local exchange carriers, cellular exchange operators, private network operators, and telecom equipment manufacturers. Telephone companies on five continents have standardized on our products, which are distributed by a network of sales and service representatives in more than 70 countries.

Sunrise Telecom, Inc. was incorporated as a California Corporation on October 1, 1991 with initial funding from the three founders. The company has continuously financed its growth internally through operations, which have been profitable since shipments began in October of 1992. Currently, more than 200 people develop and manufacture the finest test equipment available at our corporate headquarters in San Jose, CA. With offices in Virginia, Beijing and Italy, Sunrise Telecom truly has a global presence.

## Service & Support

---

Sunrise Telecom is proud to give its customers excellent service and support.

Technical assistance is available 24 hours a day from local representatives in over 70 countries; factory experts; on the Internet; and Sunrise's toll-free customer support line.

Contact Sunrise Telecom to find your local Sales Representative or Distributor and discover how the SunSet OCx can solve your testing needs.

### Customer Support

800 701 5208

### e-mail

[info@sunrisetelecom.com](mailto:info@sunrisetelecom.com)

### Visit our web site

[www.sunrisetelecom.com](http://www.sunrisetelecom.com)

### Order Direct

toll-free order hotline 888 242 7077

fax hotline 408 360 1958

e-mail [ordernow@sunrisetelecom.com](mailto:ordernow@sunrisetelecom.com)



Sunrise Telecom  
22 Great Oaks Blvd.  
San Jose, CA 95119  
ph 408 363 8000  
fax 408 363 8313