

INTERNATIONAL® A26

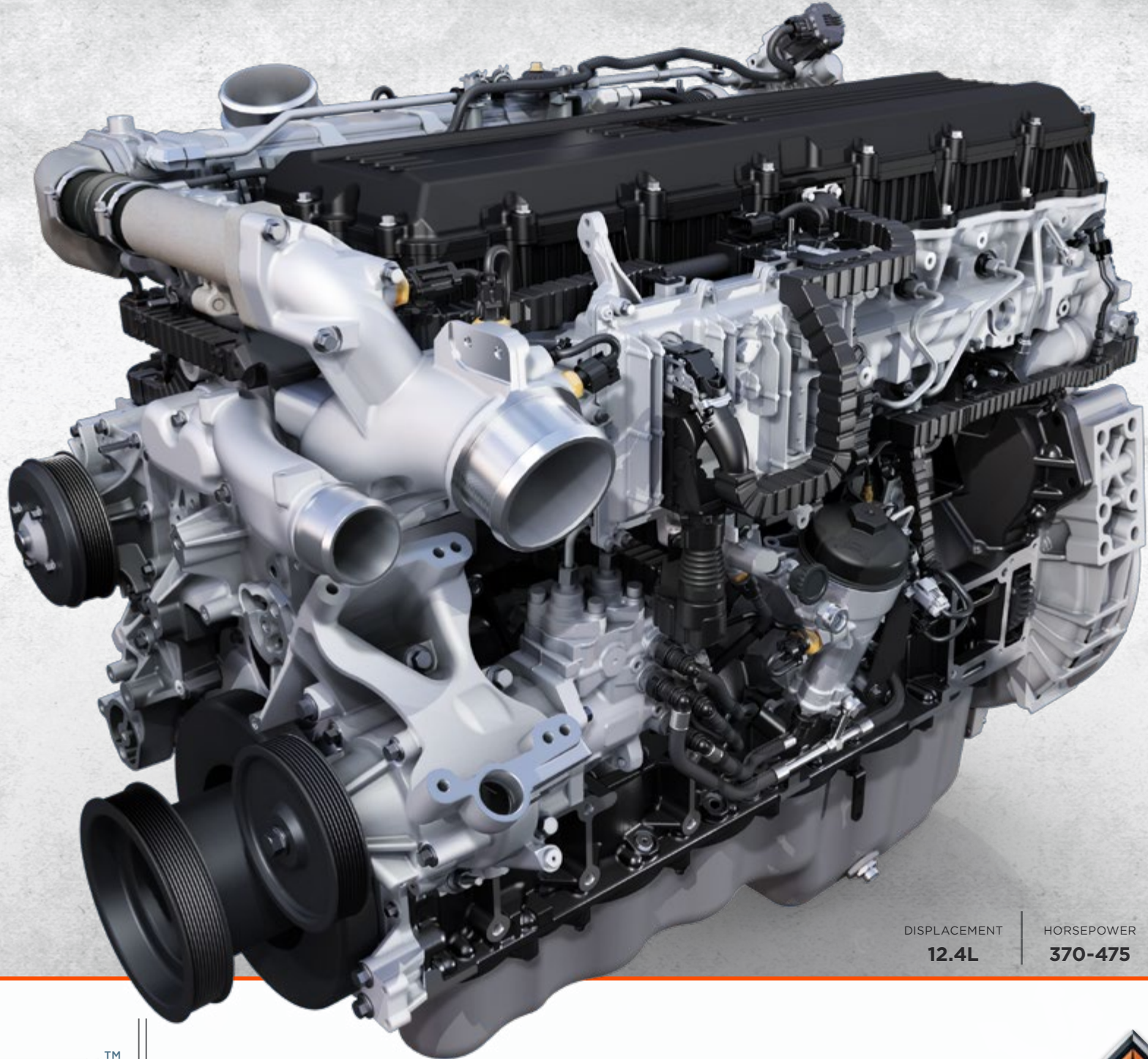

DISPLACEMENT
12.4L

HORSEPOWER
370-475

TORQUE lb.-ft.
1350-1750

A26TM

INTERNATIONAL® A26 ENGINE





**BORN FROM A
NEW WAY OF THINKING.
HOW A DEDICATION TO UPTIME
LED TO THE INTERNATIONAL A26 ENGINE.**

PROJECT ALPHA

Driven by our commitment to our customers, International Truck set out to create a new engine that would deliver what matters most - industry-leading uptime. Along the way, we committed to something much bigger, and fundamentally changed how we design diesel engines.

That's why we launched Project Alpha. It began with a new team of the best powertrain engineers, each with a fresh perspective and a shared vision to deliver unprecedented customer satisfaction. The team had the freedom to bring new ideas to the project, allowing them to develop new concepts, new processes and new methodology that emphasized simplicity over complexity, and favored proven components over experimental technology.

The result? The International A26 -- a remarkable new 12.4L engine for highway applications that's purpose-built to deliver uptime, fuel efficiency and quiet operation like never before.

The A26 engine has been tested to extremes, and backed by an industry-best warranty. It represents much more than a new engine - it's a new beginning at International Truck

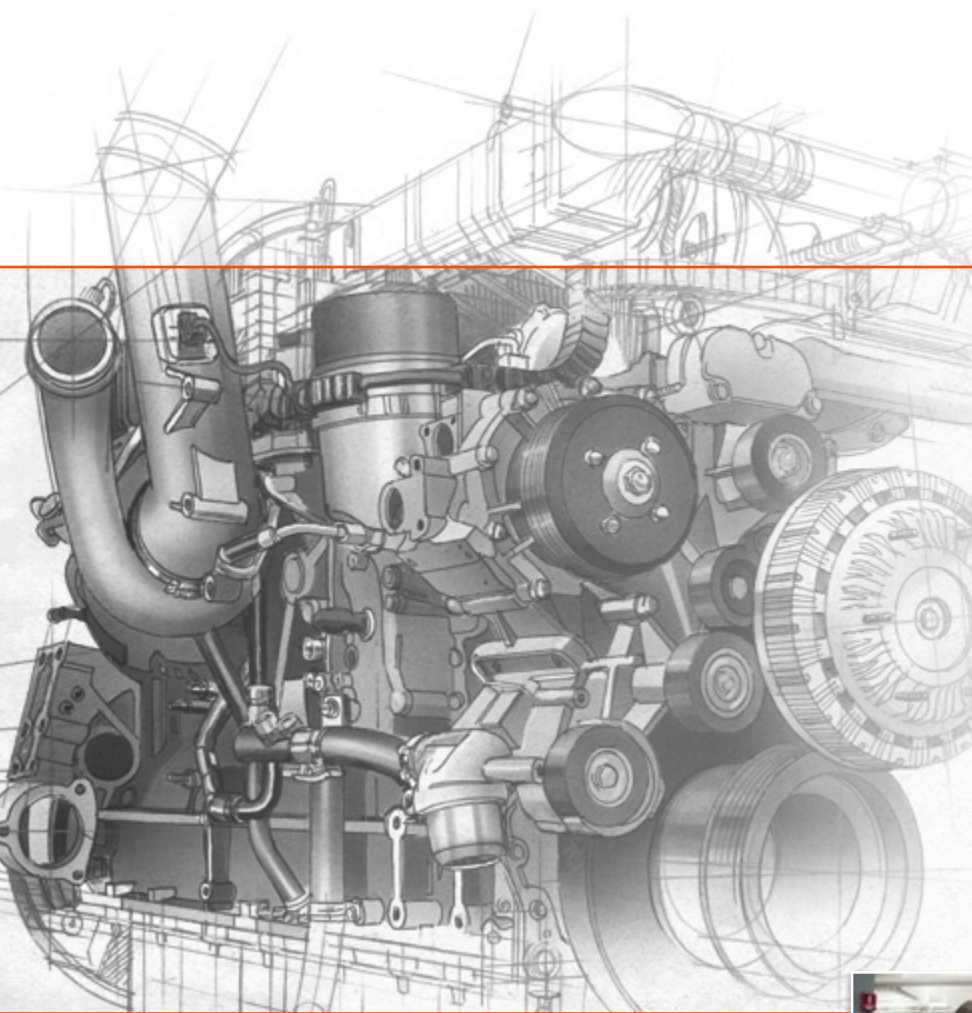

The Project Alpha team brought together some of the brightest minds in the powertrain industry. Their individual talents and combined dedication created the A26, an engine that delivers industry-leading uptime, fuel efficiency and more





LIGHTWEIGHT KNOCKOUT.

THE A26 IS PACKED WITH EFFICIENT MUSCLE AND BUILT TO SET A NEW STANDARD IN ITS CLASS.

A26 engine

The A26 produces up to 475 HP and 1750 lb.-ft. of torque, but its big-bore performance only begins to tell the full story of this engine. The modern simplicity of the A26 design does more than shed weight — every component has been carefully engineered to deliver uncompromising uptime as well as class-leading fuel efficiency, reduced weight and quieter operation.

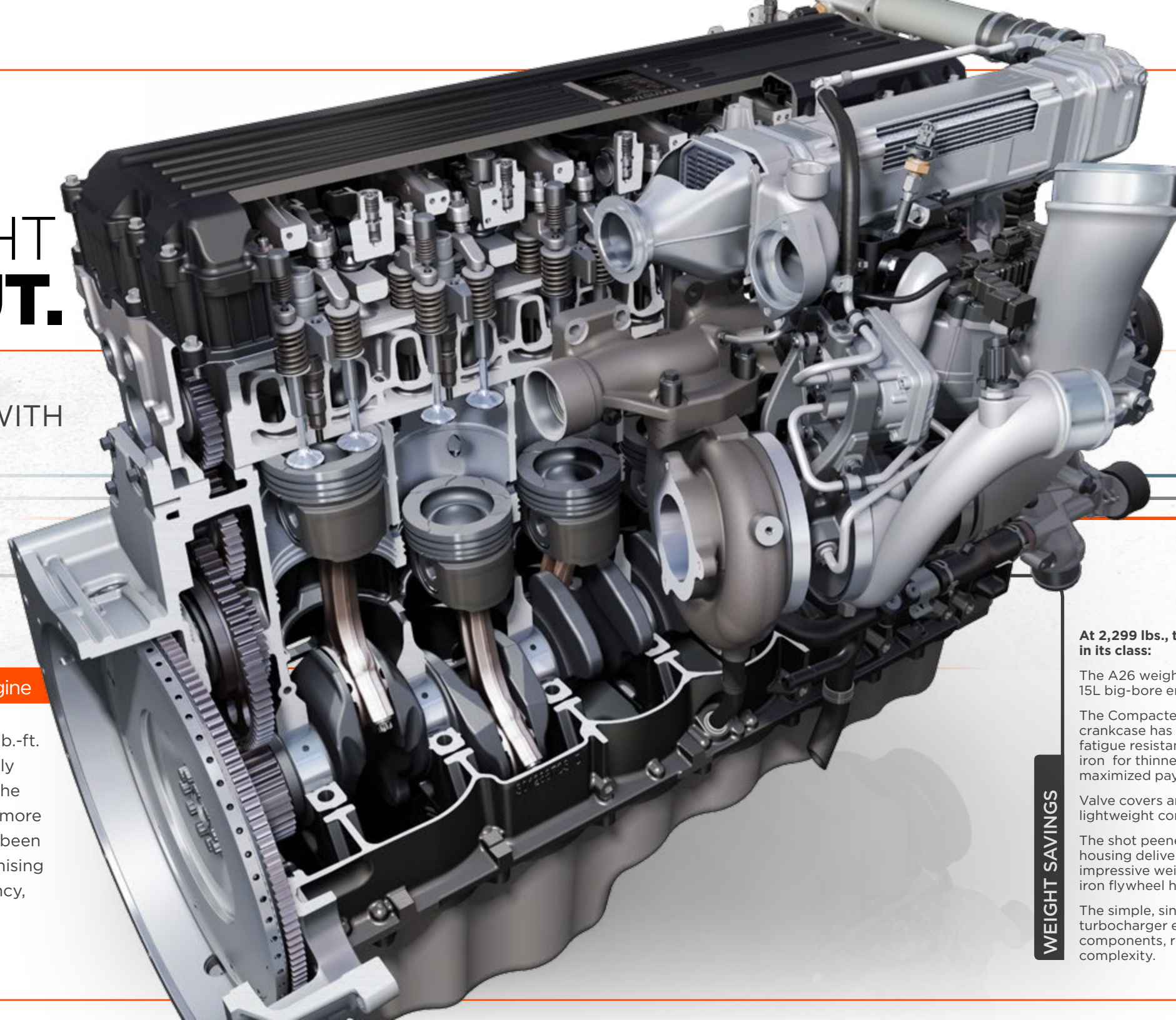

UPTIME

Every component is engineered to maximize uptime:

Larger piston pins, connecting rods and bushings optimize load distribution for enhanced durability.

The Variable Geometry Turbocharger (VGT) features a titanium compressor wheel that delivers superior fatigue life over aluminum designs, with a simplified single stage design to reduce complexity and enhance reliability.

The 2500 bar High Pressure Common Rail (HPCR) fuel system has proven its reliability over 6 years of testing, and has been in production on the MAN® D38 15-liter engine since 2015.

Smaller piston cooling jets increase oil pressure to improve lubrication and engine durability. Exposing less oil to hot pistons also reduces oil oxidation to improve oil drain intervals.

Oil change service interval has been increased to 70,000 miles*

WEIGHT SAVINGS

At 2,299 lbs., the A26 is the lightest engine in its class:

The A26 weighs 600-700 lbs. less than 15L big-bore engines

The Compacted Graphite Iron (CGI) crankcase has greater strength and fatigue resistance than traditional gray iron for thinner walls, reduced weight and maximized payload.

Valve covers are built of a durable, lightweight composite instead of aluminum.

The shot peened aluminum flywheel housing delivers high strength with impressive weight savings over traditional iron flywheel housings.

The simple, single stage design of the turbocharger eliminates several major components, reducing weight and complexity.

NOISE REDUCTION

The A26 is packed with noise-reducing features:

The uniquely sculpted crankcase significantly dampens vibration.

The HPCR fuel system delivers multiple injection events for smooth, quiet operation.

The oil pan and crankcase are isolated through a specially designed rubber gasket that absorbs vibration before it can get amplified through the oil pan.

Sophisticated calibration and programming are specifically designed to reduce engine noise.

The 6-blade fan features fewer blades for quieter operation.



Engine braking power is increased by up to 67% for confident braking performance, particularly at low- to mid-RPMs and at higher altitudes



Start confidently down to -40°F with available oil heater, coolant heater and cold start system

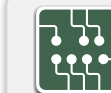

Advanced new engine control software developed by Project Alpha engineers for the single engine control module allows calibration enhancements to reach customers in days instead of months

FUEL EFFICIENCY

Engineered to deliver up to 5% greater fuel economy:

Maximized fuel injection pressure from the 2500 bar (36,300 psi) HPCR fuel system reduces both fuel consumption and emissions.

New cylinder head coolant passages are 50% less restrictive to reduce parasitic loss to the water pump.

A simplified air management system with the new Variable Geometry Turbocharger delivers optimal fuel economy and performance.

An oil cooler thermostat bypass allows oil to bypass the oil cooler in colder weather to improve fuel economy.

*with oil sampling and International approval



DURABILITY IN EVERY DETAIL.

EVERY COMPONENT IN THE A26 IS ENGINEERED FOR UPTIME, AND EXTENSIVELY TESTED TO VALIDATE ITS PERFORMANCE OVER THE LONG HAUL.

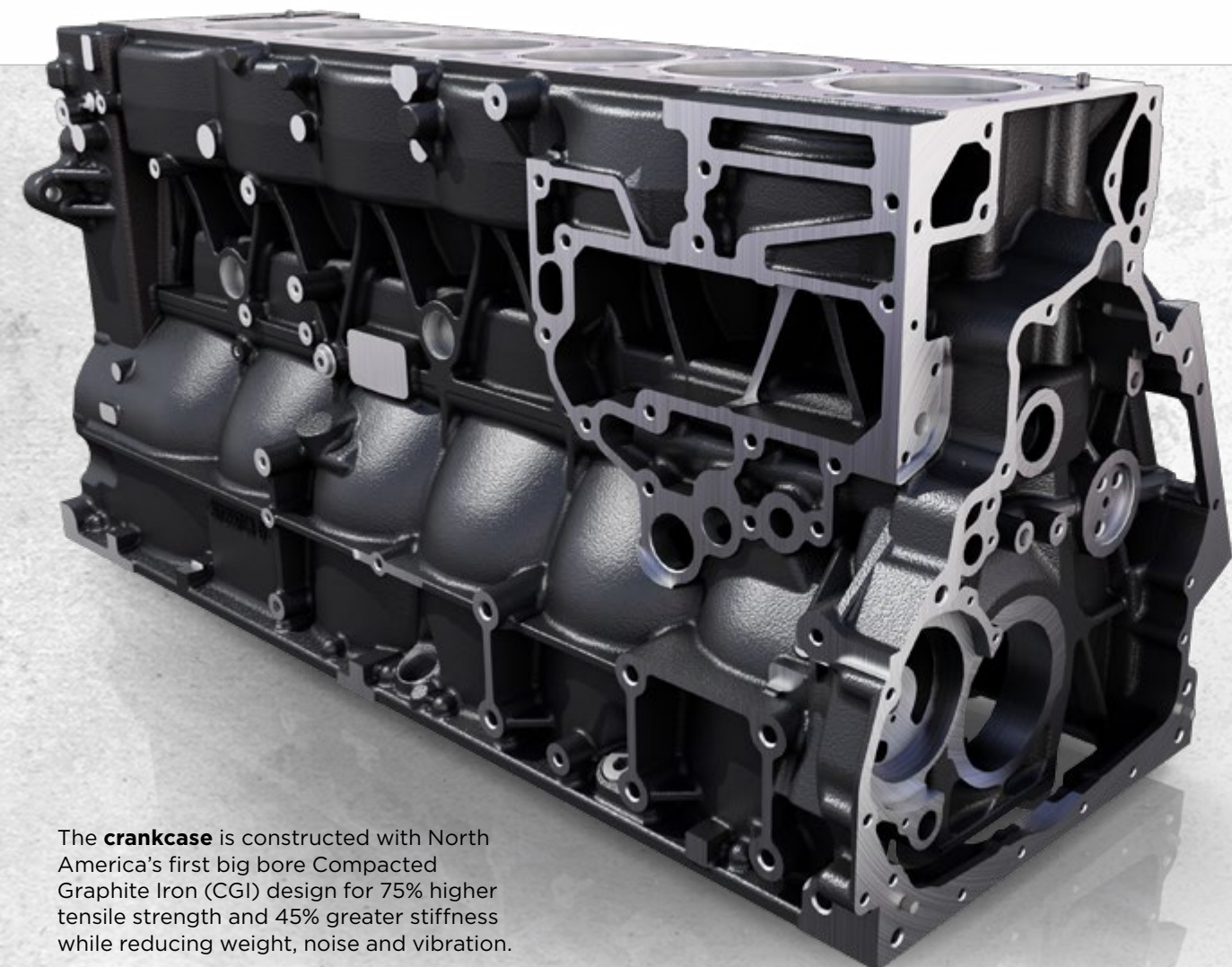

The **crankcase** is constructed with North America's first big bore Compacted Graphite Iron (CGI) design for 75% higher tensile strength and 45% greater stiffness while reducing weight, noise and vibration.



Gear teeth are produced using an innovative grinding process for smoother, harder and quieter gear surfaces.



The **single stage EGR cooler** is constructed of laser-welded stainless steel to deliver proven reliability and performance in a compact, easy to service design.



Pistons are engineered with a low-friction skirt coating and advanced piston ring geometry to reduce parasitic losses and enhance fuel economy.



The **assembled camshaft** features tool-grade steel lobes that are almost as hard as diamonds for unsurpassed durability, with hollow design to minimize weight.



Free breathing intake port geometry

Lower water jacket cools the flame deck first

Better flow achieved through the exhaust ports

ALL-NEW CYLINDER HEAD

The innovative A26 cylinder head achieves the perfect balance between weight, strength, cooling and breathing:

- Innovative gray iron material offers the high strength and thermal conductivity needed for advanced breathing and cooling
- Extensive computer modeling and analysis optimized port flow geometry to substantially reduce air restriction, helping the engine breathe more consistently from cylinder to cylinder for increased fuel efficiency
- New water jacket geometry ensures that more coolant flows to the hottest areas of the cylinder head that need it most, with less restrictive flow that reduces parasitic loss to the water pump for better fuel economy



TESTED AND VALIDATED TO NEW INDUSTRY STANDARDS.

We tested the A26 far beyond ordinary limits: We pushed it in the lab, conducting hundreds of thousands of hours of “key life” and dyno tests at extreme engine speeds and engine loads. Then we pushed it in the real world, covering millions of miles in our reliability test fleet over the harshest North American roads, including development and validation testing for vehicle performance, cold temperature extremes of -40°F, high altitudes, after-treatment development and on-board diagnostics. Through all these grueling tests designed to break the toughest engines, what impressed Project Alpha engineers most is how every component refused to fail.



HUNDREDS OF THOUSANDS OF HOURS OF DYNO TESTING



MILLIONS OF REAL-WORLD TEST MILES



HUNDREDS OF ENGINES TESTED

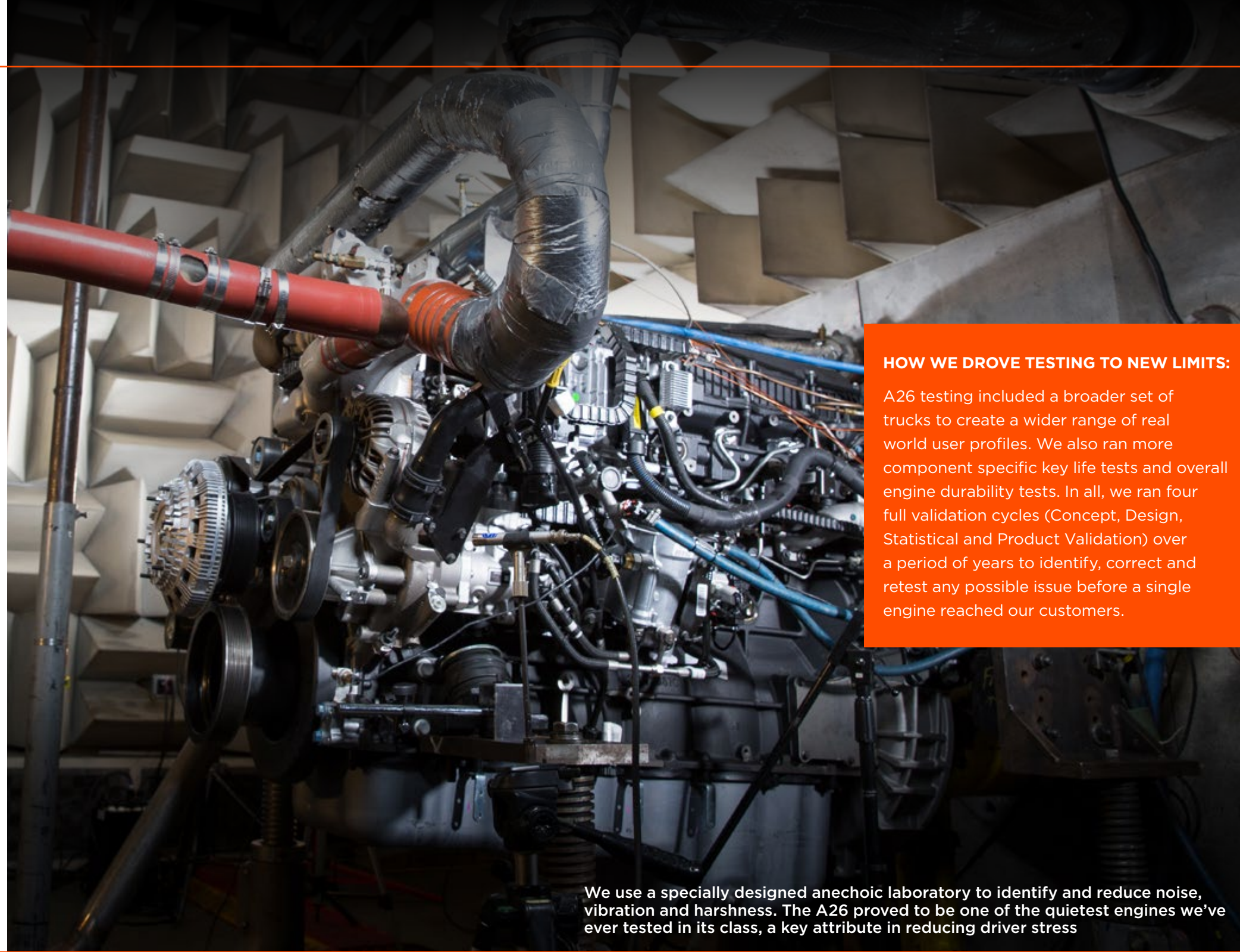
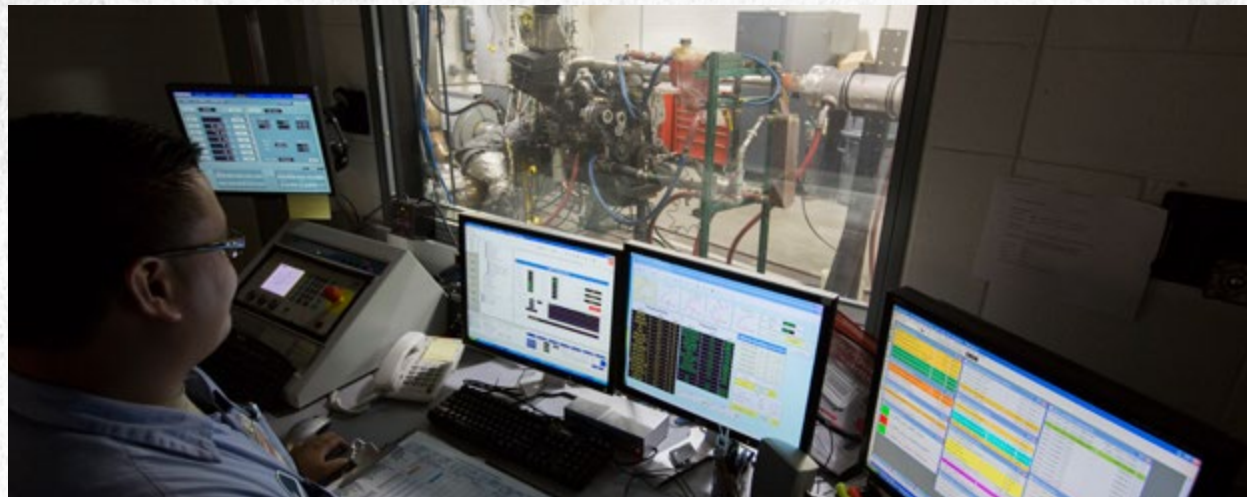

HOW WE DROVE TESTING TO NEW LIMITS:

A26 testing included a broader set of trucks to create a wider range of real world user profiles. We also ran more component specific key life tests and overall engine durability tests. In all, we ran four full validation cycles (Concept, Design, Statistical and Product Validation) over a period of years to identify, correct and retest any possible issue before a single engine reached our customers.

We use a specially designed anechoic laboratory to identify and reduce noise, vibration and harshness. The A26 proved to be one of the quietest engines we’ve ever tested in its class, a key attribute in reducing driver stress



INDUSTRY-BEST B10 DESIGN LIFE.

The A26 is the first engine in the industry to meet rigorous B10 design life standards for an unsurpassed 1,200,000 miles.

The B10 designation requires that 90% of engines meet a mileage standard - typically 1,000,000 miles -- before the cylinder head or oil pan is removed for a major repair. Most competitors use B50 standards that require only 50% of engines go 1,000,000 miles before a major repair.

Only the A26 meets the B10 standard for 1,200,000 miles. If your trucks are averaging 100,000 miles each year, that’s the equivalent of running 2 more years before your first major overhaul - real savings that impact your business.



ACHIEVING B10 DESIGN LIFE STANDARDS.

International B10 standards require 90% of all engines endure 1.2 million miles before the first major repair is needed.

Typical B50 standard require only 50% of engines reach 1.0 million miles before a major overhaul.

B10



B50



KEY A26 SPECIFICATIONS.

Technical Specifications

Engine Type	Diesel, 4-Cycle
Configuration	Inline 6-Cylinder
Displacement	12.4 L (758 cu. in.)
Bore & Stroke	4.96 in. & 6.54 in. (126 mm & 166 mm)
Compression Ratio	18.5:1
Aspiration	Variable Geometry Turbocharger with Charge Air Cooler
Combustion System	2500 bar High Pressure Common Rail
Engine Lubrication	42 Quarts (40 L)
Total Engine Weight (Dry)	2,299 lbs. (1099 kg)
Valves	4 Valves Per Cylinder, Single Overhead Camshaft
B10 Design Life	1,200,000 mi (1,931,000 km)

Maintenance Intervals

Replace Engine Oil and Oil Filter	Up to 70,000 miles with oil sampling and International Truck approval 6.5 or greater mpg: 50,000 miles (80,000 km) 5.5 to 6.5 mpg: 30,000 miles (48,000 km) Less than 5.5 mpg: 20,000 miles (32,000 km)
Replace Fuel Filter	At every oil change or 1,300 hours
Diesel Particulate Filter Cleaning	6.5 or greater mpg: 600,000 miles / 11,000 hours 5.5 to 6.5 mpg: 500,000 miles / 9,000 hours Less than 5.5 mpg: 350,000 miles / 9,000 hours
Replace DEF Filter	300,000 miles (483,000 km)
Add Extended Life Coolant Extender	600,000 miles (966,000 kilometers)
Replace Coolant	1,200,000 miles (1,931,000 km) / 8 years / 15,000 hours
Adjust Valve Lash	At 120,000 miles (193,000 km), at 300,000 miles (483,000 km), then every 300,000 miles (483,000 km)

Linehaul: LT Series and RH Series

HP @ 1700 RPM	Torque [lb-ft*] @ RPM	Governed speed [RPM]	High idle speed [RPM]
370	1350 @ 1000	1800	2000
400	1550-1750 @ 975	1800	2000
410	1450 @ 1000	1800	2000
410	1450-1650 @ 1000	1800	2000
430	1550 @ 1000	1800	2000
450	1700 @ 1000	1800	2000
450	1550-1700 @ 1000	1800	2000
475	1700 @ 1000	1800	2000

Best-in-Class Engine Warranty

Standard Engine Warranty	2 year unlimited mile warranty
Optional Engine Warranties	Up to 7 years and 700,000 miles

A WARRANTY AS STRONG AS THE ENGINE IT COVERS.

THE A26 IS BACKED BY AN INDUSTRY-LEADING TWO-YEAR UNLIMITED MILE WARRANTY. OR CHOOSE ADDITIONAL ASSURANCE WITH AVAILABLE ENGINE WARRANTIES THAT COVER UP TO 7 YEARS AND 700,000 MILES.



BACKING YOUR BUSINESS WITH INDUSTRY-BEST SUPPORT.

YES, WE'RE
OPEN

Saturday
488
Locations

Sunday
47
Locations

So no matter where you drive, you're not far from one of our

720
DEALER LOCATIONS

10
Canadian Provinces
50
U.S. States

Leading all competitors in

7,445
SERVICE BAYS



7,687
TECHNICIANS

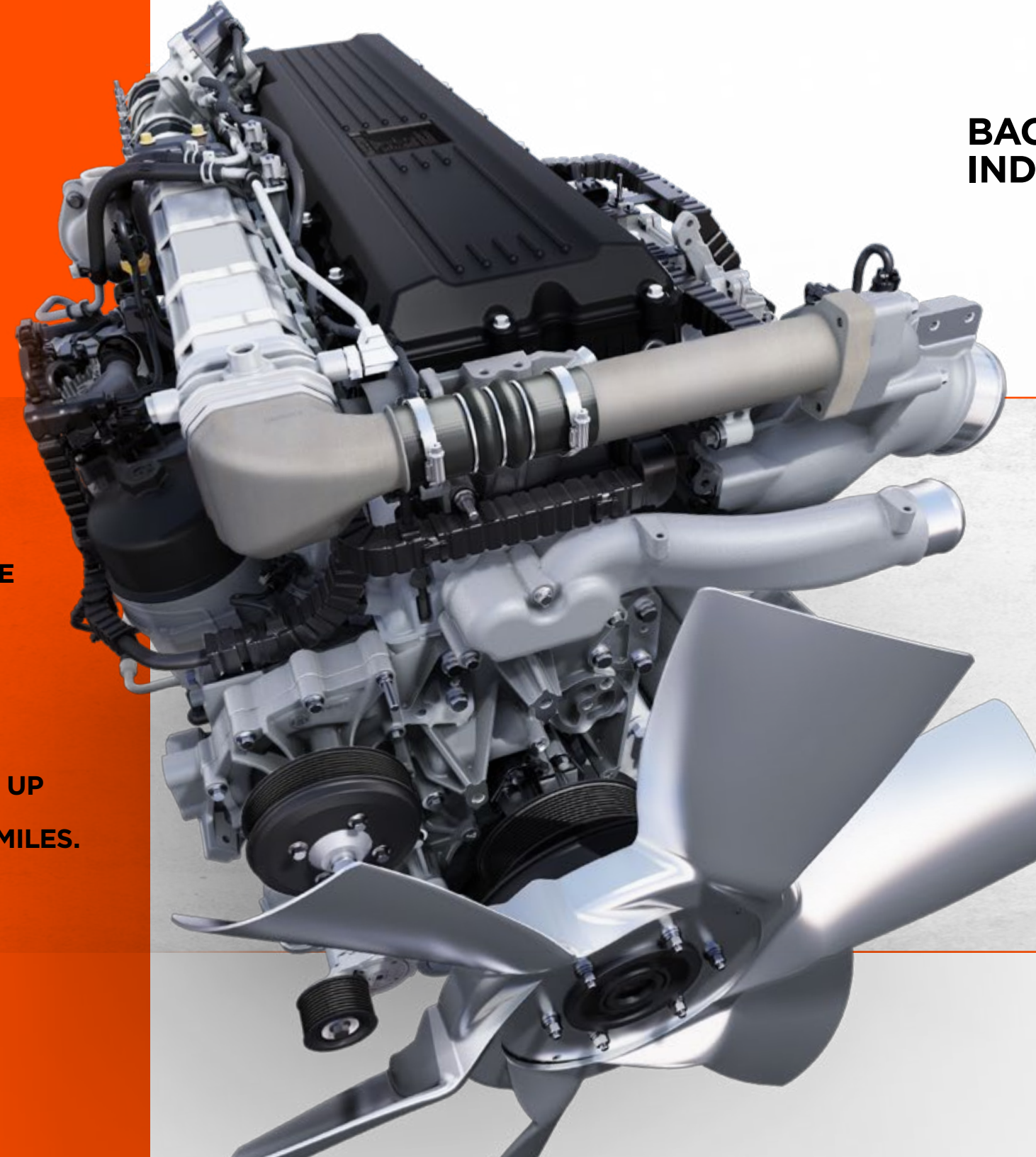



THE INTERNATIONAL A26. BUILT WITH UPTIME IN ITS DNA.

www.InternationalTrucks.com/A26

Note: Engine specifications are subject to change without notice.

TAD17002 02/2017 ©2017 NAVISTAR Inc. All rights reserved.
All marks are trademarks of their respective owners.

