

piccolo®

Operator's Manual



ABAXIS

Piccolo® Point-of-Care Chemistry Analyzer Operator's Manual

For in vitro diagnostic use

**Abaxis, Inc.
3240 Whipple Road
Union City, California, USA
94587**

**800-827-2947
Customer Service and Technical Support**

PN 100-7008 Rev. G

March 13, 2001

Piccolo Operator's Manual

Table of Contents

Section 1: Piccolo Features and Components

1.1	Intended use	1-1
1.2	Universal precautions	1-1
1.3	Near-patient testing efficiency	1-1
1.4	Overview of the procedure	1-1
1.5	External features	1-2
1.5.1	Display and keypad	1-2
1.5.2	Disc drawer	1-2
1.5.3	Result card slot	1-3
1.5.4	Power supply	1-3
1.5.5	Computer ports	1-3
1.5.6	Symbols Used in Labeling	1-3
1.5.7	Physical and environmental specifications.....	1-4
1.6	Internal components	1-4
1.6.1	Optics	1-4
1.6.2	Microprocessors and memory	1-4
1.6.3	Software	1-5
1.7	Piccolo reagent discs	1-5
1.7.1	Disc structure and function	1-5
1.7.2	Disc storage and handling	1-6
1.8	Result cards	1-7
1.9	Intelligent QC (iQC™)	1-7
1.9.1	Instrument iQC™	1-8
1.9.2	Reagent iQC™	1-8
1.9.3	Performance iQC™	1-8
1.10	Setup and power supply	1-9
1.10.1	Shipping verification	1-9
1.10.2	Powering up	1-9
1.10.3	Powering down	1-10
1.11	Connecting to an external computer	1-11
1.12	Consumables and ancillaries	1-11
1.13	Customer service and technical support	1-11

Section 2: Testing Procedure and Interpretation of Results

2.1	Sample requirements	2-1
2.2	Testing procedure	2-1
2.2.1	Preparing the reagent disc	2-2
2.2.2	Running a patient sample	2-3
2.2.3	Canceling an analysis in progress	2-5
2.3	Interpreting patient results	2-6
2.3.1	Reading the result card	2-6
2.3.2	Abnormal results: interpretation and further action	2-7
2.4	Running controls	2-8
2.5	Limitations of the procedure	2-10

Section 3: The Menu Function

3.1	Run controls	3-1
3.2	Change the date and time	3-2
3.3	Select date format	3-4
3.4	Select time format	3-4
3.5	Select Units	3-5
3.6	Customize reference ranges	3-6
3.7	Print reference ranges	3-8
3.8	Transmit reference ranges	3-9
3.9	View analyzer identification	3-10

Section 4: The Recall Function

4.1	Scanning patient results in chronological order	4-1
4.2	Recalling results by specifying patient ID	4-3
4.3	Scanning control results in chronological order	4-5
4.4	Recalling a specific control result	4-6
4.5	Scanning system QC data associated with patient results in chronological order	4-8

4.6	Recalling System QC data associated with patient results by specifying patient ID	4-10
4.7	Scanning system QC data associated with control results in chronological order	4-12
4.8	Recalling system QC data associated with a specific control result	4-13
4.9	Transmitting results to an external computer	4-16
4.10	Transmitting system QC to an external computer	4-17
4.11	No results in memory	4-18
4.12	No system QC in memory	4-18

Section 5: Maintenance and Troubleshooting

5.1	Routine maintenance	5-1
5.1.1	Cleaning the exterior	5-1
5.1.2	Cleaning the printer	5-1
5.1.3	Cleaning the air filter	5-2
5.2	Clearing a paper jam	5-3
5.3	Installing a software card	5-4
5.4	Reinitializing the analyzer	5-5
5.5	Returning the analyzer to Abaxis for service	5-5
5.6	Error messages	5-6

Section 1: Piccolo Features and Components

1.1 Intended use

The Piccolo® Point-of-Care Chemistry Analyzer provides quantitative in vitro determinations of clinical chemistry analytes in heparinized whole blood, heparinized plasma, or serum.

1.2 Universal precautions

Operator health and safety require that universal precautions be observed at all times while handling human blood samples or working with the Piccolo® Point-of-Care Chemistry Analyzer in any way. The complete text of the document “OSHA 29 CFR Part 1910, Occupational Exposure to Bloodborne Pathogens” can be found on the Internet at www.osha-slc.gov/Preamble/Blood_toc_by_sect.html.

1.3 Near-patient testing efficiency

This near-patient portable clinical chemistry system provides the clinician with routine multi-chemistry profiles and electrolytes for panels of blood tests within minutes. Less than 2 minutes of hands-on time is required to perform the test. The Piccolo® Point-of-Care Chemistry Analyzer eliminates the need to transport samples to a central laboratory, and reduces such problems as misplaced samples, inaccurate labeling and transcription, improper icing and bagging, and sample degradation. Test systems must produce reliable results when used by operators with a wide range of skill levels. An important criterion is ease of use, and automated systems with minimal handling and processing steps, like the Piccolo® Point-of-Care Chemistry Analyzer, are easy to operate and are widely used in near-patient environments.

1.4 Overview of the procedure

The Piccolo® system consists of the Piccolo® Point-of-Care Chemistry Analyzer, single-use disposable reagent discs, and result cards printed by the analyzer. External and internal features of the analyzer are described and illustrated below.

The operator begins the Piccolo procedure by introducing whole blood, plasma, or serum sample into a self-contained reagent disc and loading the disc into the analyzer. No premeasuring or sample preparation steps are required. The operator then enters patient, operator, and physician ID numbers using the keypad and display screen. The analyzer performs the remainder of the testing protocol auto-

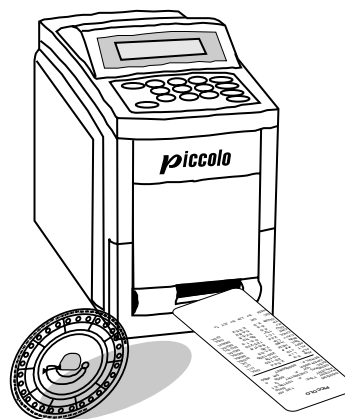

matically in about 12 minutes. The used reagent disc is removed and the analyzer is ready for the next sample.

The chemical reactions carried out by this analyzer are designed to produce a reaction that absorbs light at known wavelengths. Analyte concentration is calculated from light absorbance data. Results can be printed on result cards for purposes of assessment and for inclusion in the patient's medical chart. Results are stored in the analyzer memory, and can be transmitted to an external computer.

1.5 External features

The Piccolo® Point-of-Care Chemistry Analyzer is a lightweight portable instrument that allows patient testing at the point of care. Its small footprint allows convenient placement of the analyzer in a near-patient environment. The top surface has a 4-line display screen and keypad, and a recessed carrying handle. A sliding drawer and a slot for inserting result cards into the internal printer are on the front surface. The back surface has DC power supply and RS232 ports.

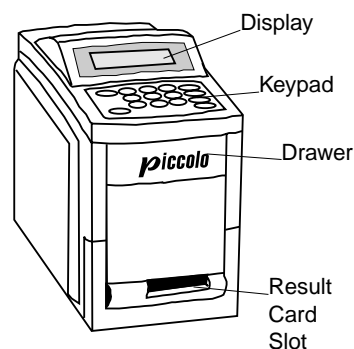

1.5.1 Display and keypad

The keypad and 4-line display screen facilitate interactive communication between the analyzer and the operator. The display indicates the status of the analyzer, and presents procedural instructions and error messages. It also reflects information input via the keyboard so it can be verified or corrected.

The operator inputs data through the 10 numeric keys, 6 function keys, and 2 arrow keys. Refer to the figure at the right for the keyboard layout. The specific uses of these keys are described in Sections 2, 3, and 4.

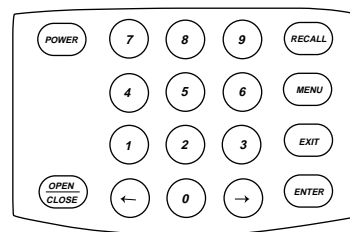

The POWER key is used to power the analyzer up or down and to cancel a run in progress. Refer to 2.2.3.

The OPEN/CLOSE key operates the sliding drawer where the reagent disc sits. This key is referred to in the text as either the OPEN or CLOSE key as appropriate in context. Closing a drawer containing a reagent disc initiates an analysis. Two of the function keys, MENU and RECALL, provide access to special functions described in detail in Sections 3 and 4.

1.5.2 Disc drawer

The disc drawer slides in and out to transport the reagent disc into the analyzer and hold it in place during the analysis. Keep the analyzer drawer closed when not loading or unloading a reagent disc. Always use the OPEN/CLOSE key to change the posi-

tion of the drawer. **Do not push on the drawer to close it. This may damage the instrument.**

1.5.3 Result card slot

The result card slot, on the front surface of the analyzer below the disc drawer, provides access into the internal thermal printer. Refer to 1.6, 2.2.2, and Section 4 for information about printing result cards.

1.5.4 Power supply

The analyzer runs on DC power, providing portability in point-of-care testing environments.

Two power supply components are included. A **DC adaptor** plugs into the socket on the lower left back of the analyzer, allowing the use of a 12-volt battery as the power source. An **AC power cord** connects the power adaptor to a grounded electrical outlet.

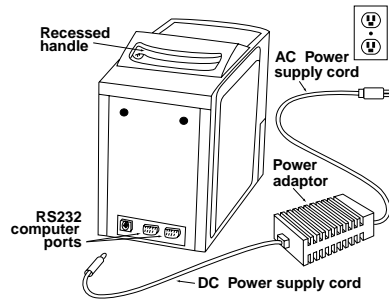



1.5.5 Computer ports

Two RS232 ports support 2-way communication between the analyzer and external devices. Only port 1 [labeled RS232(1)] should be used at this time. Port 2 is reserved for future use. Refer to 1.11 for information on linking the analyzer to an external computer.

1.5.6 Symbols used in labeling

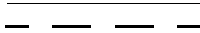
The following symbols are found on the label on the bottom panel or above the connections on the back panel.

Symbol	Explanation
	Direct current
	Caution (refer to accompanying documents)
	Serial ports

1.5.7 Physical and environmental specifications

Height:	24.2 cm	9.5 inches
Width:	15.3 cm	6 inches
Depth:	29.2 cm	11.5 inches
Weight of the analyzer:	6.8 kg	15 pounds
Weight of the power adapter:	0.6 kg	1.3 pounds
Mode of operation:		Continuous
Protection against ingress of fluids:		Ordinary equipment (IPXO)
Ambient operating temperature:		15–32°C 59–90°F
Humidity:		0–95%, non-condensing
Reaction temperature:		37°C 98.6°F
Power requirements:		250–90 volts AC 50–60 Hz or 12–15 volts DC
Thermal protection rating:		70°C 178°F

1.6 Internal components

Inside the analyzer is a variable speed motor to spin the disc, a spectrophotometer to measure analyte concentrations, two microprocessors to control testing and analytical functions, system software on a PCMCIA card, and a thermal line printer for imprinting result cards. A heating system maintains the temperature of the disc at 37°C while reactions are in progress.

1.6.1 Optics

The measurement optics consist of a discrete wavelength spectrophotometer with a xenon lamp as a light source.

1.6.2 Microprocessors and memory

The architecture of the instrument consists of two microprocessors: a real-time controller that monitors and controls all the measurements; and an I/O (input/output) controller for memory management, calculations, and data storage. The two processors cross-check each other's performance continuously, which allows a very high level of confidence in the working of the instrument, and consequently of the results and the integrity of the data.

The analyzer stores 150 patient results, 75 control results, and system quality control data. All data stored in memory can be accessed via the Recall function. Refer to **Section 4**.

1.6.3 Software

The analyzer software comprises two matched programs. One program controls the measurement engine itself, ie, it schedules the flashing of the light source and collects the light intensity data for different cuvettes at different times during the reaction; and it collects all the information generated in the analytical part of the instrument. The second program processes that information and reports analyte concentration. It also stores data related to each run (time, date, user ID, patient results, and control data).

Software upgrades are distributed to registered users on a PCMCIA card and installed on site. Refer to 5.3 for instructions on installing a software card.

1.7 Piccolo reagent discs

1.7.1 Disc structure and function

In the Piccolo system, all chemistry reactions are performed inside clear plastic reagent discs, 8 cm in diameter and 2 cm in depth, specially designed to perform all the steps required to convert a few drops of whole blood, plasma, or serum into a panel of test results. Each disc contains all the components and reagents needed to perform one or more tests on a single sample.

A total of 30 **cuvettes** are located around the periphery: 4 system cuvettes contain QC reagent beads for instrument and chemistry quality control (refer to 1.9); a minimum and a maximum absorbance cuvette are employed in calibrating the spectrophotometer; a specially designed cuvette detects whether sufficient sample volume was applied; one cuvette verifies that a sufficient aliquot of diluted sample was delivered to the reaction cuvettes; an empty cuvette captures excess fluids. The remaining 21 cuvettes contain test-specific lyophilized reagent beads.

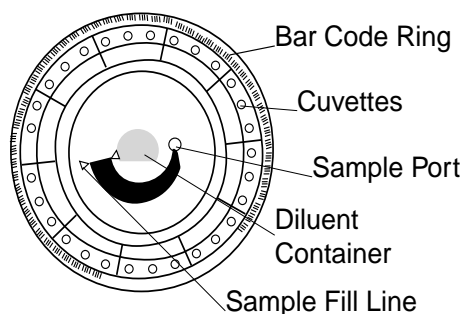

The **bar code ring** attached to the top of the reagent disc contains calibration data specific for the chemistries in the disc. It also contains the disc identification code, lot number, and expiration date. The analyzer automatically checks the code and rejects an expired disc. The bar code ring also protects the optical surfaces of the cuvette from fingerprints and other debris, and helps minimize contamination of the analyzer by capturing small drops of blood that may be on the disc surface.

The **sample port**, demarcated by an arrow pointing to a circle molded onto the upper surface of the disc, provides access to the **sample chamber**. When sufficient sample has been loaded into the sample chamber, the **sample fill line** forms between two arrows molded on the disc surface.

A sample **diluent** is sealed in a container inside the center of the disc. At the beginning of the reaction cycle, the analyzer opens the container and releases the diluent.

The analyzer separates a heparinized whole blood sample by centrifugation inside the disc. Plasma and serum samples are unaffected. Precisely measured quantities of sample and diluent are delivered to the **mixing chamber**. Then centrifugal and capillary forces deliver the diluted sample to the cuvettes, where it dissolves the reagent beads and initiates the chemical reactions. Reaction products in the cuvettes are measured photometrically.

1.7.2 Disc storage and handling

- Store all reagent discs as described on their respective labels. When stored as described as described on their respective labels, all reagents in the disc are stable until the expiration date printed on the foil pouch and encoded on the bar code ring. The analyzer will reject an expired disc.
- A disc can be used directly from the refrigerator without warming.
- A disc can remain in its sealed pouch at room temperature for a cumulative period of 48 hours. Longer time at room temperature can cause suppression of chemistries and disc aborts.
- Do not expose discs, in or out of the foil pouches, to direct sunlight or to temperatures above 32°C (90°F).
- Inspect the unopened foil pouch for tears and punctures. A torn or damaged pouch may allow moisture to reach the disc and adversely affect reagent performance.
- Open the disc pouch at the notch on the top right edge of the package. A disc must be used within 20 minutes of opening the pouch. Once the pouch is opened, do not place the disc back in the refrigerator for use at a later time.
- Discs are fragile. Handle with care. Do not tap the disc on the table or work bench to empty the sample port. Do not use a disc that has been dropped.
- Keep discs clean. Handle them only at the edges to avoid smudges on the optical surfaces. Use a lint-free tissue to remove blood from the disc surface.
- Write the patient identification number on the disc surface in the space indicated in the figure to the right (optional). Do not write anywhere else on the disc or on the bar code ring.
- Hold reagent discs flat after introducing the sample or control to avoid spillage.
- The used disc can be replaced in the pouch for disposal.
- **BIOHAZARD:** Used reagent discs contain body fluids. Follow good laboratory working practices. Handle all used discs as if they are contaminated with hepatitis or other infectious diseases.

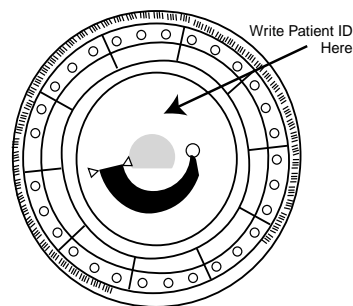

1.8 Result cards

Result cards are durable paper strips, about 6 inches long by 2.5 inches wide, designed for use with the Piccolo® Point-of-Care Chemistry Analyzer, on which test results and other information can be printed after testing is complete. Result cards are also used for printing the QC report and the troubleshooting report to assist in the interpretation of error codes. Additional copies of the result card can be printed at any time for any analysis held in memory. Refer to 2.2.2 and Section 4 for information about printing result cards, QC report cards, and troubleshooting reports. Refer to 1.12 for ordering information.

The result card has an adhesive backing so it can be placed into the patient's file. The operator should follow the institution's procedures for disposition of the result card.

PICCOLO			
04/05/96		1:35 AM	
PATIENT TYPE:		MALE	
PATIENT #:		103195-2-1	
GENERAL CHEMISTRY		12	
DISC LOT #:		6054 A	
OPER 000#:		DR #000	
SERIAL #:		000000827	
.....			
ALB	3.3	2.5-4.4	G/DL
ALP	LIP	20-150	U/L
ALT	<10	10-118	U/L
AMY	***	200-1200	U/L
TBIL	HEM	0.1-0.6	MG/DL
BUN	>180	7-25	MG/DL
CA++	LIP	8.6-11.8	MG/DL
CHOL	2.4.4	125-270	MG/DL
CRE	I C T	0.3-1.3	MG/DL
GLU	112'	80-110	MG/DL
K+	4.5	3.7-5.8	MMO/L
TP	6.3	5.4-8.2	G/DL
GLOB	3.0	2.3-5.2	G/DL
QC	OK		
HEM	3+	LIP 3+	JCT 1+

1.9 Intelligent QC (iQC™)

The Piccolo® Point-of-Care Chemistry Analyzer includes design and user interface features that perform comprehensive system-wide quality control checks during each run. These features, collectively called “intelligent QC” (iQC™), ensure that operators at a wide range of skill levels can achieve accurate and reliable results. Two types of QC reagent beads (instrument and chemistry) are included in each disc. Refer to 1.7.1 for information about disc structure. When these methods confirm that all parameters are within expected ranges, INSTRU QC:OK CHEM QC:OK is printed on the result card. Otherwise, no result card is printed and an error message is displayed. Error messages indicate analyzer or disc malfunctions, and explain why results may not be available. Whenever an error message is displayed, refer to 5.6 for troubleshooting procedures.

System and chemistry QC data from each patient sample are stored in the analyzer memory with the sample results. System and chemistry QC data from each control run are stored with control results, separately from sample results. Standard information storage and retrieval techniques are employed to ensure the integrity of the data. All QC data stored in memory can be called up for review at any time. Refer to Section 4 for complete information and detailed instructions.

iQC™ greatly reduces the requirement for routine control testing. Refer to 2.4 for recommendations and procedure for control testing. Operators requiring assistance setting up control testing procedures should contact Abaxis Technical Support.

1.9.1 Instrument iQC™

The analyzer hardware is subjected to a self-test at power-up. The self-test ensures that all optics, the flash lamp, and the circuit board components are functioning properly, and also verifies the memory functions. If any component does not meet specification, an error message is displayed. The disc motor, flash lamp, temperature, and optics are monitored continuously throughout each analysis. The spectrophotometer is automatically recalibrated at the beginning of each analysis.

Simultaneously with each analysis, advanced optical sensing and electronic systems monitor reactions involving instrument QC reagent beads to verify the functioning of the analyzer and the disc

1.9.2 Reagent iQC™

Reactions involving chemistry QC reagent beads reveal and quantify any degradation of the test-specific reagents in the disc due to suboptimal storage conditions. The value reported is the actual absorbance as a percent of the expected absorbance. The value must exceed a defined minimum for the reagents to meet performance standards. Otherwise, the run is aborted and an error message is displayed.

A lot-specific cutoff value for chemistry QC absorbance is used to separate the various tests on the disc into two groups, based on different sensitivity to heat exposure. If the chemistry QC value falls below this cutoff level but above the defined minimum, the results from the less heat-sensitive tests are expected to meet performance standards. The results of these tests are printed. The results of the more heat-sensitive tests may show some degradation and are suppressed. (This cutoff level is not printed on the quality control report.)

1.9.3 Performance iQC™

Disc checks performed during the analysis include: checking the barcode for current dating and for the presence of all required calibration factors; confirming that sample volume is sufficient; confirming the presence of all reagent beads and that all reagent beads have dissolved in diluted sample; verifying diluent and sample mixing; and monitoring fluid movement throughout the disc for proper sequence and timing of the reactions.

The iQC system monitors the performance of the reactions. For rate chemistries, the analyzer confirms that the reactions are linear; that the absorbances from which the rates are calculated, as well as the rates themselves, are within defined ranges; and whether the substrate has been depleted. In endpoint chemistries, the analyzer verifies that all measurements are within the dynamic range of the photometer and that the reaction has reached completion, ie, there are no changes in absorbance as a function of time.

The analyzer measure the levels of hemolysis, lipemia, and icterus. If there was interference with the analyte, information about the interference is printed on the result card. Refer to 2.3 for additional information.

1.10 Setup and power supply

1.10.1 Shipping verification

Remove the analyzer from the shipping carton and place it on a level surface. Check the components you received against the following list.

- Piccolo® Point-of-Care Chemistry Analyzer
- Piccolo® Operator's Manual
- DC power adapter and connector cord
- AC power cord
- warranty card

Note: Fill out the warranty card and mail it to Abaxis within 10 days of system installation to start the warranty period. You will be put on the Abaxis customer list to receive any information pertaining to your analyzer and ancillary products, including product updates.

1.10.2 Powering up

- Use only the power supply components provided with the analyzer. Using other power supply components will damage the instrument and void the warranty.
- Connect the analyzer only to a *grounded* electrical outlet.
- To prevent power surges or drain, do not plug the analyzer into the same circuit as a centrifuge or any other high-current device. Alternatively, use an ancillary surge protector or uninterruptible power supply (UPS).
- Place the analyzer on a level surface free of vibration and sudden jolts, and where the ambient temperature is 15–32°C (59–90°F). Do not place it near a sunny window or other heat source.
- There should be at least 6 inches clearance behind the analyzer for access to the power connection and RS232 ports.
- Place the analyzer where airborne matter such as dust, lint, and hair is limited; ie, do not place it near a fan or where air circulation is high.

Step 1. Connect the power supply.

Refer to the figure at the right. Plug the DC adapter into the socket on the back of the analyzer. Connect the AC power cord to the DC adapter. Plug the AC power cord into a *grounded* electrical outlet. The self-test message will appear on the display. The self-test is described in 1.9.1. If the display is blank, check all power supply connections.

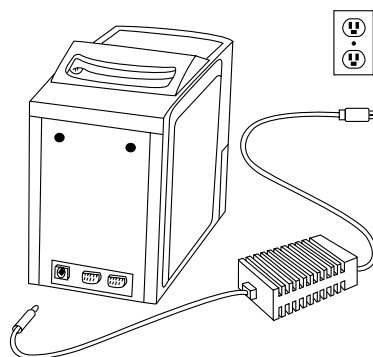
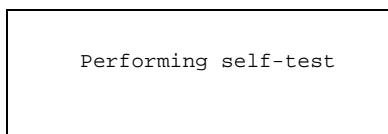

Step 2. Allow the analyzer to warm to operating temperature.

Depending on the ambient temperature, warming may take more time than the self-test.

⇒ *The analyzer is in standby mode, ie, ready to run a disc, when the display reads:*

```
Open drawer to run a
disc
```

Step 3. Check the date and time.

Check the analyzer date and time to ensure they are correct. Refer to 3.2 to change the date and time.

Step 4. Link the analyzer to an external computer. (Optional)

Refer to 1.11.

Step 5. Perform control testing.

Perform one or more runs using recommended controls before running patient samples to confirm that the analyzer is functioning to specification. Refer to 2.4 for control run procedures.

1.10.3 Powering down

The power should remain on unless you are moving the analyzer to a new location. Always power down using the POWER key rather than by unplugging the analyzer. The POWER key does not power down the analyzer when there is a reagent disc in the drawer.

This message appears when the POWER key is pressed. Press EXIT to cancel the system shutdown procedure and return the analyzer to standby mode.

```
Turn analyzer off?
Press POWER to turn
off, or EXIT to
continue operation.
```

Press POWER again to initiate system shutdown. The analyzer turns off when the system shutdown is complete.

```
Performing system
shutdown.
```

1.11 Connecting to an external computer

An institution may wish to connect the analyzer to an external computer for any or all of the following reasons: to incorporate testing data into patient records; to provide records for regulatory compliance; or to connect with automated billing systems. The instrument provides two RS232 ports for connection to external devices. Data from the analyzer are exported to the external computer as text files (*.txt). Contact Abaxis for technical support.

1.12 Consumables and ancillaries

Contact Abaxis or your authorized distributor to order reagent discs, result cards, controls, and sample collection equipment and supplies.

1.13 Customer service and technical support

Call Abaxis Customer Service and Technical Support at 800-822-2947 with questions regarding operation of and problems with the Piccolo[®] Point-of-Care Chemistry Analyzer.

Section 2: Testing Procedure and Interpretation of Results

2.1 Sample requirements

- The Piccolo® Point-of-Care Chemistry Analyzer accepts heparinized whole blood, heparinized plasma, or serum samples.
- Lithium heparin is the only anticoagulant recommended for use with the Piccolo® Point-of-Care Chemistry Analyzer.
- A sample size of 90–120 µL is required.
- Whole blood must be analyzed within 60 minutes of collection, or separated into plasma or serum.
- To prevent hemolysis, do not refrigerate or shake whole blood.
- If not analyzed immediately, plasma or serum may be stored at room temperature for no longer than 5 hours after centrifugation. If storage for more than 5 hours is required, the sample should be refrigerated in the stoppered tube at 2– 8°C (36– 46°F) for no longer than 48 hours; or stored at –10°C for up to 5 weeks in a freezer without a self-defrost cycle. Under these conditions, there will be no clinically important changes in most analyte concentrations.
- For accurate interpretation of glucose results, the sample should be collected from a patient who has fasted for at least 12 hours.
- Operator health and safety require that Universal Precautions be observed at all times while handling human blood samples or working with the Piccolo® Point-of-Care Chemistry Analyzer in any way. The complete text of the document “OSHA 29 CFR Part 1910, Occupational Exposure to Bloodborne Pathogens” can be found on the Internet at www.osha-slc.gov/Preamble/Blood_toc_by_sect.html.

2.2 Testing procedure

- Wear powder-free gloves while handling reagent discs or operating the analyzer. Powder may disrupt the optical components.
- If necessary, power up the analyzer before beginning the procedure. The power-up procedure is described in 1.10.2.
- Ensure that the ambient temperature is 15–32°C (59–90°F).
- **The analyzer is in standby mode, ie, ready to run a disc, when the display reads:**

Open drawer
to run a disc

2.2.1 Preparing the reagent disc

- Refer to 1.7 for complete information about Piccolo® reagent discs, including handling instructions. Please become thoroughly familiar with this information before beginning the procedure.
- Refer to 2.1 for sample handling and storage requirements.
- The analysis must begin immediately (no more than 10 minutes) after dispensing the sample into the reagent disc.

Step 1. Dispense the sample.

Use a micropipette or other transfer device to dispense approximately 100 μL of sample into the disc via the sample port.

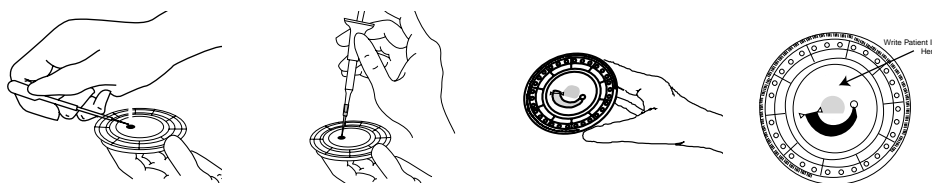

a. Fill the sample port.

Expel air bubbles from the tip of the micropipette. Place the micropipette in the sample port and tilt it until it is perpendicular to the disc surface. Push down on the plunger with a slow, continuous motion.

Take care not to overfill the sample chamber. A 90 μL sample will fill the sample chamber and form a line between the two arrows molded on the disc. More than 120 μL of sample will overfill the chamber. Discard the pipette tip into a biohazard container.

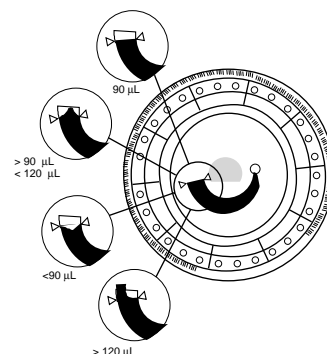

b. Fill the sample chamber.

Tilt the disc to 45° with the sample port above the fill line, so that the entire sample flows into the sample chamber. Clean the reagent disc. Use a lint-free tissue to remove any sample spilled on the outside of the disc, taking care that the tissue does not withdraw any sample from the sample port. Dispose of the tissue in a biohazard container.

c. (Optional) Label the disc.

Write the patient ID on the disc surface in the space indicated in the figure above. Do not write anywhere else on the disc or on the bar code ring.

d. Carry the prepared disc to the analyzer.

Hold the disc by its edges in a flat position.

2.2.2 Running a patient sample

- The analyzer must be in standby mode to begin the procedure.
- Use the numeric and arrow keys to enter patient, operator, and physician IDs while the analysis is proceeding. The → key inserts a dash; the ← key deletes the character to the left.
- The reference range set and patient, operator, and physician IDs must be entered before results can be calculated. If you wait until the run is complete before entering these numbers, the analyzer will require an additional one minute to calculate the results.
- If an error message is displayed at any time during the run, refer to 5.6 for troubleshooting procedures associated with the specific error code.

Step 2. Open the drawer and insert the disc.

Press OPEN. The following messages are displayed sequentially:

```
Opening drawer...
```

```
Close drawer to start  
analysis.
```



Place the disc in the drawer. Press CLOSE. The display reads:

```
Closing drawer...
```

The analysis begins when the drawer closes.

Step 3. Select the reference range set.

By default, the reference range set for the previous sample is displayed. The reference range set for the current sample must be selected for correct interpretation of results. Use the numeric keys to select the correct reference range set. Press enter when the correct number appears to the right of Select Set.

```
Select Set:_ X  
1- Male 2- Female  
3- Special  
ENTER to accept.
```

Step 4. Enter the patient ID.

A patient ID (up to 14 characters) must be entered to continue. Press ENTER.

```
Input Patient #:  
-----  
ENTER when finished.
```

Step 5. Enter the operator ID.

By default, the operator ID for the previous sample is displayed. Enter the operator ID for the current sample, up to 3 characters. Press ENTER.

```
Input Operator #: XXX  
ENTER when finished.
```

Step 6. Enter the physician ID.

By default, the physician ID for the previous sample is displayed. Enter the physician ID for the current sample, up to 3 characters. Press ENTER.

```
Input DR #:  
XXX  
ENTER when finished.
```

Step 7. Automatic sample processing.

The analyzer processes the sample and calculates results in less than 15 minutes with no further operator input. During the run, the analyzer displays the following message, including time remaining to complete the analysis (XX : XX) and patient ID.

```
Results ready in  
XX:XX  
for patient #:  
XXXXXXXXXXXXXXXX
```

Sample processing is complete when the analyzer beeps and displays the message:

```
Analysis complete.  
Open drawer or  
insert card  
to print results.
```

Step 8. Print results.

To end the procedure without printing results, press OPEN and continue to step 9.

If a Run Cancelled error message is displayed, refer to 5.6 for an explanation and further instructions.

Place the result card in the result card slot. Remove the card when directed to do so on the display. These messages appear sequentially:

Printing results...

Remove card.

Opening drawer...

Remove disc and close
drawer.

Step 9. Return the analyzer to standby mode.

Remove the reagent disc from the drawer and dispose of it, following your lab's bio-hazard procedures. Press CLOSE to return the analyzer to standby mode.

2.2.3 Canceling an analysis in progress

Press POWER to cancel an analysis in progress. The display requests verification that the analysis should be canceled:

Cancel analysis?
Press POWER to cancel
run, or EXIT to con-
tinue analysis.

Press POWER again to cancel the analysis. These messages appear sequentially:

Analysis canceled.

Opening drawer...

Remove disc and
close drawer.

Remove the reagent disc from the drawer. Press **CLOSE** to return the analyzer to standby mode.

For the run cancellation to take effect, the operator must press **POWER** before the analyzer has calculated the results. If the cancellation procedure is initiated after the analyzer has calculated the results, the cancellation will not take effect. The results are stored in memory and can be printed. The `Analysis complete` message appears. Continue from step 8, above.

Analysis complete.
Open drawer or insert
card to print results.

2.3 Interpreting patient results

Results are stored in internal memory, and, if the analyzer is connected to an external computer, automatically transmitted. Results can be printed on a result card. Refer to 2.2.2, Step 8. An adhesive backing allows the result card to be placed in the patient's chart and become part of their permanent medical record. Refer to 1.8 for basic information about the result card. Follow your lab or institution's procedure for transferring the card to the patient's chart.

2.3.1 Reading the result card

The **result card heading** includes:

- test date and time
- reference range set
- patient, operator, and physician IDs; or control level
- reagent disc type and lot number
- analyzer serial number.

The **test results section** of the card is printed in three columns:

- analyte
- analyte concentration
- reference range in specified units.

An asterisk (*) printed to the right of the analyte concentration indicates **results outside the reference range**.

A greater than (>) or less than (<) symbol printed to the left of the value in the analyte concentration column indicates **results outside the dynamic range** of the assay. Refer to 2.3.2 A., below.

A row of diamonds (◆◆◆) printed in place of analyte concentration indicates **suppressed results**. Refer to 2.3.2 B. below.

HEM, LIP, or ICT is printed in place of the analyte concentration when results are affected by **interference from hemolysis, lipemia, or icterus**. When a result is affected by hemolysis and either or both of the other interferents, HEM is printed. When a result is affected by both lipemia and icterus, LIP is printed. Examine the sample indices printed at the bottom of the card to determine if more than one interferent is affecting results. Refer to 2.3.2 C. below for further instructions.

INST QC: OK and CHEM QC: OK printed near the bottom of the result card when iQC testing indicates that all instrument, disc, and chemistry parameters meet specifications.

Sample indices for hemolysis, lipemia, and icterus are printed at the bottom of the card. The sample is rated for these interferents on the following scale:

- 0 clear
- 1+ slight
- 2+ moderate
- 3+ gross

2.3.2 Abnormal results: interpretation and further action

A. Results outside the dynamic range

Refer to the disc package insert for information about the dynamic range of any assay included in the disc. When the sample concentration falls below or exceeds the dynamic range of the assay, the analyzer cannot calculate the concentration. The numeric value that appears in the analyte concentration column is the upper or lower limit of the dynamic range of the assay, preceded by > or < , respectively. For example, the dynamic range of glucose is 10–700 mG/DL; a sample concentration of glucose below this range would be printed as <10 mG/DL ; a sample concentration of glucose above this range would be printed as >700 mG/DL.

Results outside the dynamic range should be reported as below or above the value indicated.

B. Suppressed results (◆◆◆)

A result may be suppressed (ie, not held in memory and not able to be printed) when any of the internal QC steps detect an abnormal condition.

Collect a new sample and rerun the test. If results for the second sample are suppressed, call Abaxis Technical Support for further assistance.

C. Interferents

The limits for physical interferents are given in the Piccolo reagent disc package insert.

When the sample is hemolytic, collect a new sample and rerun the test. Abaxis recommends that the new sample be separated into serum or plasma so that the degree of hemolysis can be verified. If the new sample is hemolytic, use an alternative testing method or send the sample to a reference laboratory.

Samples with hematocrit in excess of 60% packed red cell volume may be reported on the result card as HEM. Follow the instructions above for retesting hemolyzed samples.

Lipemia may be due to diet. The patient should be instructed to fast for at least 10 to 12 hours before another sample is collected. For grossly lipemic samples from fasting patients or for icteric samples, use an alternative testing method or send the sample to a reference laboratory.

2.4 Running controls

Abaxis recommends control testing as follows:

- at least every 30 days
- whenever laboratory conditions have changed significantly
- when training or retraining of personnel is indicated
- when test results do not match patient symptoms or clinical findings

Good laboratory practices include the recording of the QC data according to the laboratory's established written procedures. A permanent record of control results should be retained.

Samples and controls are run identically by the analyzer. However, using the Run Controls option in the Menu function stores control results separately from patient results in the analyzer memory. Control results can be printed on a result card immediately after the conclusion of the control run, or whenever the control run results are recalled. Refer to Section 4 for the use of the RECALL key. Control results are automatically transmitted to a linked computer.

Handle the control as described in the control package insert. Call Abaxis Technical support for assistance in interpreting control results.

Step 1. Prepare the reagent disc.

Use a micropipette or other transfer device to dispense approximately 100 μ L of control into the sample port. Refer to 2.2.1 for detailed instructions on preparing the reagent disc.

Step 2. Activate the Run Controls function.

Press MENU one time. Press ENTER.

Press ENTER to
run controls,
MENU for next option
EXIT to leave.

Step 3. Choose the correct control level.

By default, the display shows the control level for the previous control run. Use the numeric keys to choose the correct control level for the current run. Press ENTER.

```
Select level: xxx
1- I3-III
2- II
ENTER to accept.
```

Step 4. Enter the operator ID.

By default, the display shows the operator ID for the previous control run. Enter the operator ID for the current control run, up to 3 characters. Press ENTER.

```
Input Operator #: XXX
ENTER when finished.
```

Step 5. Enter the physician ID.

By default, the display shows the physician ID for the previous control run. Enter the physician ID for the current run, up to 3 characters. Press ENTER.

```
Input DR #:
XXX
ENTER when finished.
```

Step 6. Insert the prepared disc.

Following step 5, the drawer opens and the following messages are displayed sequentially:

```
Opening drawer...
```

```
Close drawer to start
analysis.
Control Level xxx
```

Insert the disc. Press close. This message appears briefly:

```
Closing drawer
```

Step 7. Automatic control processing.

The analyzer displays the control level and time remaining to complete the analysis.

```
Results ready in XX:XX  
for control: Level XXX
```

When the analysis is complete, the analyzer beeps and displays the message:

```
Analysis complete. Open  
drawer or insert card  
to print results.
```

Step 8. Print control results.

If you choose not to print the results immediately following the control run, press OPEN and continue with step 9.

To print results immediately following the control run, insert a result card into the slot. This message is displayed while results are printing:

```
Printing results. . .
```

Remove the result card when directed to do so on the display. After the result card is removed, the drawer opens automatically. Proceed to step 9.

```
Remove card.
```

Step 9. Return the analyzer to standby mode.

Remove the reagent disc from the drawer and dispose of it according to your lab's standard procedures. Press CLOSE. The analyzer returns to standby mode.

2.5 Limitations of the procedure

- Refer to 5.6 when error messages are displayed.
- Samples with hematocrit in excess of 60% packed red cell volume may be reported on the result card as HEM. Refer to 2.3.2 C. for instructions.
- The analyzer suppresses results when the precision is significantly affected by hemolysis, lipemia, or icterus. Refer to 2.3.2 C.

Section 3: The Menu Function

Several special functions programmed into the Piccolo® Point-of-Care Chemistry Analyzer are accessed through the MENU key. You can access the Menu function from standby mode, ie, when no analysis is in progress and the drawer is closed. From within any of these Menu functions, press EXIT to return to the previous display. Press EXIT twice to return to standby mode.

Function	Description	Press MENU	Refer to
Run controls	Run controls	1 time	2.4
Change date and time	Set the date and time	2 times	3.2
Select date format	Choose month/day/year or day/month/year	3 times	3.3
Select time format	Choose 12-hour or 24-hour clock	4 times	3.4
Select units	Choose international units (SI) or units commonly used in the United States	5 times	3.5
Customize reference ranges	Change reference ranges from defaults to ranges specific to the patient population	6 times	3.6
Print reference ranges	Print the reference ranges in a specified reference range set	7 times	3.7
Transmit reference ranges	Transmit all the reference ranges stored in memory to a linked computer	8 times	3.8
View analyzer ID	View the analyzer serial number and software version	9 times	3.9
Escape from MENU function	EXIT		

3.1 Run controls

Refer to 2.4 for the complete procedure for running controls. This Menu function stores control results in memory separate from the sample results, so you can use the Recall function to search specifically for control results. In all other respects, controls and samples are run identically by the analyzer.

3.2 Change the date and time

The date and time are checked during the set up procedure. Refer to 1.10. Change the date or time format, if necessary, before changing the actual date or time. Refer to 3.3 and 3.4.

Step 1. Press MENU twice to reach the Change Date and Time function:

```
Press ENTER to change
date & time,MENU for
next option EXIT to
leave
```

Step 2. Display the date or time in the active format.

Press ENTER. Use the numeric keys 1 or 2 to choose date or time. Press ENTER.

```
Select: 2 Time
xx/xx/xxxx:xx MM
1- Date 2- Time
ENTER to accept.
```

Step 3. Change the date.

Use ← → and the numeric keys to enter the correct date. Press ENTER to return to the screen in step 2.

```
Date:xx/xx/xx
0-9 keys to change,
← → to move cursor,
ENTER to accept.
```

Step 4. Change the time.

Use ← → and the numeric keys to enter the correct time. Press ENTER.

```
Time:xx:xx:xx MM
0-9 keys to change,
← → to move cursor,
ENTER to accept.
```

If the 12-hour clock option is active, use ← → and the numeric keys 1 or 2 to select AM or PM. Press ENTER. (If the 24-hour clock is active, this option will not appear on the screen.)

```
Time:xx:xx:xx MM
1 for AM, 2 for PM
← → to move cursor,
ENTER to accept.
```

If an invalid date (eg, 14 for the month) or time (eg, 30 for hours) has been entered, an invalid entry message appears:

```
Entry for date was
invalid. Enter date
value again.
Press EXIT.
```

or

```
Entry for time was
invalid. Enter time
value again.
Press EXIT.
```

Press EXIT to return to the screen shown in Step 3. or Step 4., where you can correct the date or time.

Step 5. Verify date and time settings.

When the date or time you entered is valid, the following screen is displayed. To make more changes, press either 1 or 2 and ENTER. Repeat Step 3. or Step 4.

```
Select: 2 Time
xx/xx/xx xx:xx MM
1- Date 2-Time
ENTER to accept.
```

Step 6. Return to standby mode.

Press EXIT twice.

3.3 Select date format

Two options are available: month/day/year and day/month/year.

Step 1. Press MENU 3 times to reach the Select Date Format function:

```
Press ENTER to select
date format,
MENU for next option
EXIT to leave.
```

Step 2. Choose the date format.

Press ENTER to display the active date format. To select the alternative format, press 1 or 2. The format you chose will be displayed. Press ENTER to accept.

```
Select:1  MM/DD/YY
1- MM/DD/YY  07/16/95
2- DD/MM/YY  16/07/95
ENTER to accept.
```

Step 3. Return to standby mode.

Press EXIT.

3.4 Select time format

Options are a 12-hour clock and a 24-hour clock.

Step 1. Press MENU 4 times to reach the Select Time Format function:

```
Press ENTER to select
time format,
MENU for next option
EXIT to leave.
```

Step 2. Choose the time format.

Press ENTER to display the active time format. To select the alternative format, press 1 or 2. The format you chose will be displayed. Press ENTER to accept.

```
Select: xx hour
1- 12 hour 02:25 PM
2- 24 hour 14:25
ENTER to accept
```

Step 3. Return to standby mode.

Press EXIT twice

3.5 Select units

Options are common (eg, mg/dL) or SI (eg, mmol/L) units for reporting results.

Step 1. Press MENU 5 times to reach the Select Units function.

```
Press ENTER to select
units,
MENU for next option
EXIT to leave.
```

Step 2. Accept or change the active option.

Press ENTER. The display indicates which option is active. Press ← → to select the alternative option. Press ENTER.

```
Common Units
← → to change
ENTER to accept.
```

or

```
SI (Int'l) units
← → to change
ENTER to accept.
```

Step 3. Return to standby mode.

Press EXIT.

3.6 Customize reference ranges

Change the default or existing reference ranges stored in the analyzer to match the reference ranges specific to the patient population.

NOTE: Change reference ranges in either common units or SI units, not both. The analyzer automatically converts units.

Step 1. Press MENU 6 times to reach the Change Reference Ranges function:

```
Press ENTER to edit
reference ranges,
MENU for next option
EXIT to leave.
```

Step 2. Select the method (analyte).

Press ENTER. Use ← → to choose a method (analyte) other than the one shown on the display.

```
Select Method:
xxxxxxxxxxxxxx
Press ← → to scan,
ENTER to accept.
```

Step 3. Select the reference range set.

Use the numeric keys. Press ENTER.

```
Select Set 1: MALE
1- Male 2- Female
3- Special
ENTER to accept.
```

The method (analyte) and its current reference range set and values are displayed.

```
Method Gender Range
Units 0-9 keys to
change,ENTER to accept.
```

Step 4. Change the reference range set or values.

Use ← → and the numeric keys. Press ENTER to accept the changes. The analyzer returns to the screen displayed in Step 2.

```
Select Method:
xxxxxxxxxxxxxx
Press ← → to scan,
ENTER to accept.
```

Step 5. Correct errors.

If an invalid value has been entered, the following screen is displayed. Press EXIT. The current reference range values will be restored. Repeat step 4 with valid data.

```
Reference range entry
not valid.
Press EXIT.
```

Step 6. Change the reference ranges for other methods (analytes).

Repeat steps 2-4.

Step 7. Print reference ranges.

Verify reference ranges by printing them on a result card. From the screen in Step 4., press EXIT, MENU to bring up the Print Reference Ranges menu option. (Refer to 3.7.) *The date and time shown on the card are the date and time the card was printed, not the date and time the reference ranges were changed. To record the date you changed the ranges, write it on the card.*

Step 8. Return to standby mode.

Press EXIT twice.

3.7 Print reference ranges

Print the reference ranges for a specific reference range set. *The date and time shown on the card are the date and time the card was printed, not the date and time the reference ranges were changed. To record the date you changed the ranges, write the information on the card.*

Step 1. Press MENU 7 times to reach the Print Reference Ranges function:

```
Press ENTER to print
reference ranges,
MENU for next option
EXIT to leave.
```

Step 2. Select the reference range set to be printed.

Press ENTER. Use the numeric keys. Press ENTER again.

```
Select Set : ZZZZZ
1- Male 2- Female
3- Special
ENTER to accept.
```

Step 3. Print.

Verify that the reference range set of interest is displayed. Insert a result card. Follow the instructions on the display:

```
Insert card to print
ZZZZZZZZ
reference ranges or
EXIT to quit.
```

```
Printing ranges.
Remove card
```

Step 4. Print additional reference ranges.

After the card is removed, the display returns to the screen in step 2. Repeat steps 2 and 3.

Step 5. Return to standby mode.

Press EXIT twice.

3.8 Transmit reference ranges

The reference ranges stored in the analyzer memory can be transmitted to a linked computer. *The date and time recorded are those of the transmission, not the date and time the reference ranges were changed.* Refer to 1.11 for instructions for linking to an external computer.

Step 1. Press MENU 8 times to reach the Transmit Reference Ranges function:

```
ENTER to transmit
reference ranges,
MENU for next option
EXIT to leave.
```

Step 2. Select the reference range set to transmit.

Press ENTER. Use the numeric keys. Press ENTER again.

```
Select Set: ZZZZZ
1- Male 2- Female
3- Special
ENTER to accept.
```

During the transmission, the display reads:

```
Transmitting ranges
to computer.
```

Step 3. Transmit additional reference ranges

After transmission is complete, the display returns to the first screen in step 2. Repeat step 2.

Step 4. Return to standby mode.

Press EXIT twice.

3.9 View analyzer identification

Step 1. Press MENU 9 times to reach the View Analyzer ID function:

```
Press ENTER to view
analyzer ID,
MENU for next option
EXIT to leave.
```

Step 2. Display the serial number and software version.

Press ENTER.

```
Serial #:xxxxxxxx-
Software version:X.XXX-
Press ENTER.
```

Step 3. Return to standby mode.

Press EXIT twice.

Section 4: The Recall Function

The RECALL key allows access to patient results, control results, and system QC data stored in the analyzer memory. The analyzer memory stores the results for the last 150 patient samples and the last 75 control samples, in reverse chronological order. (Refer to 1.9 for information about system QC data.) Results or system QC for a specified sample or control that remains in memory can be recalled using run-specific parameters, or by scanning the entries in chronological order.

Note that results stored on an external computer must be accessed through the computer.

The Recall function can be accessed whenever the analyzer is in standby mode. It cannot be accessed from the Menu functions. Press EXIT at any time while in the Recall function to return to the previous display.

- Use the numeric and arrow keys to enter patient, operator, and physician IDs. The → key functions as a dash; the ← key functions as a backspace (delete key).
- The message `No results in memory` may be displayed after the analyzer memory has been cleared during servicing. If it is displayed at any other time, refer to 5.6 for troubleshooting procedures under the error code number. If no error code number is displayed, refer to 4.11 or 4.12

4.1 Scanning patient results in chronological order

Step 1. Access the Recall function.

From standby mode, press RECALL. The display reads:

```
Recall: 1 Results
1-Results
2-System QC
ENTER to accept.
```

Step 2. Access Results.

Press 1, ENTER. The display reads:

```
Recall: 1 Patient
1-Patient Results
2-Control Results
ENTER to accept.
```

Step 3. Choose the results set of interest.

Press 1, ENTER for patient results. The display reads:

```
Select: 1 Print
1-Print result card
2-Transmit result
ENTER to accept
```

Step 4. Accept the print option.

Press 1, ENTER. By default, the patient ID, date, and time of the most recent run are displayed.

```
Pt # XXXXXXXXXXXX
xx/xx/xx   xx:xx
← → to view results,
ENTER to print.
```

Step 5. Scan patient results.

Use ← → to view the results in sequence. Patient results are retrieved in reverse chronological order. The analyzer beeps twice when you have reached either end of the list. To exit without printing results, press EXIT three times to return to standby mode.

Step 6. Print patient results.

When the result of interest is displayed, press ENTER. (Data are automatically transmitted to a linked computer.) The following messages are displayed sequentially:

```
Insert card to print
results.
```

```
Printing results...
```

```
Remove card.
```

Step 7. Scan more patient results.

When the card is removed, the display returns to the screen in step 4. Repeat steps 5 and 6.

Step 8. Return to standby mode.

Press EXIT three times.

4.2 Recalling results by specifying patient ID

Step 1. Access the Recall function.

From standby mode, press RECALL. The display reads:

```
Recall: 1 Results
1-Results
2-System QC
ENTER to accept.
```

Step 2. Access Results.

Press 1, ENTER. The display reads:

```
Recall: 1 Patient
1-Patient Results
2-Control Results
ENTER to accept.
```

Step 3. Choose the results set of interest.

Press 1 and ENTER for patient results. The display reads:

```
Select: 1 Print
Print result card
Transmit result
ENTER to accept
```

Step 4. Accept the Print option.

Press 1, ENTER. By default, the patient ID, date, and time of the most recent run are displayed.

```
Pt # XXXXXXXXXXXX
xx/xx/xx   xx:xx
← → to view results,
ENTER to print.
```

Step 5. Specify the patient ID.

Press RECALL. Key in the patient ID. Press ENTER. The analyzer retrieves all results in memory for the specified patient ID.

```
Search for patient #
XXXXXXXXXXXXXXXXX

ENTER to search.
```

- a. If **no matches** are found for the specified patient ID, the display reads:

```
Pt # XXXXXXXXXXXXXXXX
not found
Press ENTER.
```

Press ENTER to return to the screen in step 4. Verify that the patient ID is correct. Repeat step 5 using a different patient ID; or press EXIT three times to return to standby mode.

- b. If **one or more matches** are found, the display reads:

```
Pt # XXXXXXXXXXXXXXXX
xx/xx/xx   xx:xx
nnn of ttt, ←→ to view
ENTER to print.
```

The total number of matches (runs) found for the specified patient ID is represented by `ttt`. Individual matches, represented by `nnn`, are numbered in reverse chronological order. For example, "1 of 3" means three matches were found for this patient ID, and the most recent of these is selected. Use ← → to scan other matches for this patient ID. To exit without printing results for any run in this set, press EXIT to return to the screen in step 4. Repeat step 5 using a different patient ID; or press EXIT three times to return to standby mode.

Step 6. Print patient results.

When the result of interest is displayed, press ENTER. (The data are automatically transmitted to a linked computer.) The following messages are displayed sequentially:

```
Insert card to print
results.
```

```
Printing results...
```

```
Remove card.
```

Step 7. Retrieve results for a different patient ID.

When the card is removed, the display returns to the screen in step 4. Repeat steps 5–6.

Step 8. Return to standby mode.

Press EXIT three times.

4.3 Scanning control results in chronological order

Step 1. Access the Recall function.

From standby mode, press RECALL. The display reads:

```
Recall: 1 Results
1-Results
2-System QC
ENTER to accept.
```

Step 2. Access Results.

Press 1, ENTER.

```
Recall: 1 Patient
1-Patient Results
2-Control Results
ENTER to accept.
```

Step 3. Choose the results set of interest.

Press 2, ENTER for control results. The display reads:

```
Select: 1 Print
1-Print result card
2-Transmit result
ENTER to accept
```

Step 4. Accept the Print option.

Press 1, ENTER. By default, the control level, date, and time of the most recent control run are displayed.

```
Control level: XXX
xx/xx/xx   xx:xx
←,→ to view results,
ENTER to print.
```

Step 5. Scan control results.

Use ← → to view the results of other control runs. Control run data are retrieved in reverse chronological order. The analyzer beeps twice when you have reached either end of the list. To exit without printing control results, press EXIT three times to return to standby mode.

Step 6. Print control results.

When the control run of interest is displayed, press ENTER to print. The following messages are displayed sequentially:

```
Insert card  
to print results.
```

```
Printing results...
```

```
Remove card.
```

Step 7. Scan more control results.

When the card is removed, the analyzer returns to the display in step 4. Repeat steps 5 and 6.

Step 8. Return to standby mode.

Press EXIT three times.

4.4 Recalling a specific control result

Step 1. Access the Recall function.

From standby mode, press RECALL. The display reads:

```
Recall: 1 Results  
1-Results  
2-System QC  
ENTER to accept.
```

Step 2. Access Results.

Press 1, ENTER. The display reads:

```
Recall: 1 Patient  
1-Patient Results  
2-Control Results  
ENTER to accept.
```

Step 3. Choose the results set of interest.

Press 2, ENTER for control results. The display reads:

```
Select: 1 Print
Print result card
Transmit result
ENTER to accept
```

Step 4. Accept the Print option.

Press ENTER. By default, the control level, date, and time of the most recent control run are displayed.

```
Control level:XXX
xx/xx/xx   xx:xx
←,→ to view results,
ENTER to print.
```

Step 5. Specify the control run.

Press RECALL. Key in the date of the control run of interest. Press ENTER. The analyzer retrieves all control results in memory for the specified date.

```
Search for control
results on xx/xx/xx
ENTER to print.
```

- a. If **no matches** are found for the specified date, the display reads:

```
No control results
found on xx/xx/xx
Press ENTER.
```

Press ENTER to return to the screen in step 4. Verify that the date entered is correct. Key in another date or use ← → to scan other control results; or press EXIT three times to return to standby mode.

- b. If **one or more matches** are found, the display reads:

```
Control Level: XXX
xx/xx/xx   xx:xx
nnn of ttt,← → to view
ENTER to print.
```

In the message above, `ttt` represents the total number of control runs found for the specified date. Individual matches are represented by `nnn`. For example, "1 of 3" means data on three control runs were found for this date, and the first of these is selected. Use `← →` to scan the other matches. To exit without printing results for any run in this set, press `EXIT` and enter another date, or press `EXIT` three times to return to standby mode.

Step 6. Print control results.

When the result of interest is displayed, press `ENTER`. The following messages are displayed sequentially.

```
Insert card
to print results.
```

```
Printing results...
```

```
Remove card.
```

Step 7. Retrieve more control results.

When the card is removed, the display returns to the screen in step 4. Repeat steps 5 and 6.

Step 8. Return to standby mode.

Press `EXIT` three times.

4.5 Scanning system QC data associated with patient results in chronological order

Step 1. Access the Recall function.

From standby mode, press `RECALL`. The display reads:

```
Recall: _XXXXXXX
1-Results
2-System QC
ENTER to accept.
```

Step 2. Access System QC.

Press 2, ENTER.

```
Recall: _XXXXXXX
1-Patient Set
2-Control Set
ENTER to accept.
```

Step 3. Choose the results set of interest.

Press 1, ENTER for patient set. The display reads:

```
Select: 1 Print
1-Print System QC
2-Transmit System QC
ENTER to accept
```

Step 4. Accept the Print System QC option.

Press ENTER. By default, the patient ID, date, and time of the most recent run are displayed.

```
Pt # XXXXXXXXXXXX
xx/xx/xx   xx:xx
← → to view results,
ENTER to print.
```

Step 5. Scan patient results.

Use ← → to view patient results in chronological order. The analyzer beeps twice at either end of the list. To exit without printing results, press EXIT three times to return to standby mode.

Step 6. Print System QC results.

When the result of interest is displayed, press ENTER. (System QC data associated with that result are automatically transmitted to a linked computer.) The following messages are displayed sequentially:

```
Insert card to print
results.
```

```
Printing results...
```

```
Remove card.
```

Step 7. Scan more patient results.

When the card is removed, the display returns to the screen in step 4. Repeat steps 5 and 6.

Step 8. Return to standby mode.

Press EXIT three times.

4.6 Recalling system QC data associated with patient results by specifying patient ID

Step 1. Access the Recall function.

From standby mode, press RECALL. The display reads:

```
Recall: _XXXXXXX
1-Results
2-System QC
ENTER to accept.
```

Step 2. Access system QC.

Press 2, ENTER.

```
Recall: _XXXXXXX
1-Patient Set
2-Control Set
ENTER to accept.
```

Step 3. Choose the results set of interest.

Press 1, ENTER for patient set. The display reads:

```
Select: 1 Print
1-Print System QC
2-Transmit System QC
ENTER to accept
```

Step 4. Accept the Print System QC option.

Press ENTER. By default, the patient ID, date, and time of the most recent run are displayed.

```
Pt # XXXXXXXXXXXX
xx/xx/xx   xx:xx
← → to view results,
ENTER to print.
```

Step 5. Specify the patient ID.

Press **RECALL**. Enter the patient ID. Press **ENTER**. The analyzer retrieves all results in memory for the specified patient ID.

```
Search for patient #
XXXXXXXXXXXXXXXXX
ENTER to search.
```

- a. If **no matches** were found for the specified patient ID, the display reads:

```
Pt # XXXXXXXXXXXXX
not found
Press ENTER.
```

Press **ENTER** to return to the screen in step 4. Verify that the patient ID is correct. To specify a different patient ID, repeat step 5. Press **EXIT** three times to return to standby mode.

- b. If **one or more matches** are found, the display reads:

```
Pt # XXXXXXXXXXXXX
xx/xx/xx   xx:xx
nnn of ttt, ← → to view
ENTER to print.
```

The total number of matches found for the specified patient ID is represented by `ttt`. Individual matches, represented by `nnn`, are numbered in reverse chronological order. For example, "1 of 3" means three matches were found for this patient ID, and the most recent of these is selected. Use `← →` to scan the other matches. To exit without printing results for any run in this set, press **EXIT** to return to the screen in step 4; or press **EXIT** three times to return to standby mode.

Step 6. Print system QC data.

When the run of interest is selected, press **ENTER**. The following messages are displayed sequentially:

```
Insert card to print
results.
```

```
Printing results...
```

```
Remove card.
```

Step 7. Retrieve results for a different patient ID.

When the card is removed, the display returns to the screen in step 4. Repeat steps 5-6.

Step 8. Return to standby mode.

Press EXIT three times.

4.7 Scanning system QC data associated with control results in chronological order

Step 1. Access the Recall function.

From standby mode, press RECALL. The display reads:

```
Recall: _XXXXXXX  
1-Results  
2-System QC  
ENTER to accept.
```

Step 2. Access System QC.

Press 2, ENTER. The display reads:

```
Recall: _XXXXXXXX  
1-Patient Set  
2-Control Set  
ENTER to accept.
```

Step 3. Choose the results set of interest.

Press 2, ENTER for control results. The display reads:

```
Select: 1 Print  
1-Print System QC  
2-Transmit System QC  
ENTER to accept
```

Step 4. Accept the Print System QC option.

Press ENTER. By default, the control level, date, and time of the most recent control run are displayed.

```
Control level: XXX  
xx/xx/xx   xx:xx  
←,→ to view results,  
ENTER to print.
```

Step 5. Scan system QC results.

Use ← → to view the results of control runs in reverse chronological order. The analyzer beeps twice at either end of the list. To exit without printing control results, press EXIT three times to return to standby mode.

Step 6. Print System QC results.

When the control result of interest is displayed, press ENTER. The following messages are displayed sequentially:

```
Insert card to print
results.
```

```
Printing results...
```

```
Remove card.
```

Step 7. Scan other control results.

When the card is removed, the display returns to the screen in step 4. Repeat steps 5 and 6.

Step 8. Return to standby mode.

Press EXIT three times.

4.8 Recalling system QC data associated with a specific control result

Step 1. Access the Recall function.

From standby mode, press RECALL. The display reads:

```
Recall: _ XXXXXXXX
1-Results
2-System QC
ENTER to accept.
```

Step 2. Access System QC.

Press 2, ENTER.

```
Recall: _ XXXXXXXX
1-Patient Set
2-Control Set
ENTER to accept.
```

Step 3. Choose the results set of interest.

Press 2, ENTER for control results. The display reads:

```
Select: 1 Print
1-Print System QC
2-Transmit System QC
ENTER to accept
```

Step 4. Accept the Print System QC option.

Press ENTER. By default, the control level, date, and time displayed are those for the most recent control run.

```
Control level: XXX
xx/xx/xx   xx:xx
←,→ to view QC,
ENTER to print.
```

Step 5. Specify the control run.

Press RECALL. Key in the date of the control run. Press ENTER. The analyzer retrieves all control results in memory for the specified date.

```
Search for control
results on xx/xx/xx
Edit date,
ENTER to search.
```

a. If **no matches** are found with the requested date, the display reads:

```
No control results
found on xx/xx/xx
Press ENTER.
```

Press ENTER to return to the screen in step 4. Verify that the date specified is correct. Use ← → to scan other control results. To exit without printing any system QC data, press EXIT three times to return to standby mode.

b. If **one or more matches** are found, the display reads:

```
Control Level:XXX
xx/xx/xx    xx:xx
nnn of ttt,← → to view
ENTER to print.
```

In the message above, *ttt* represents the total number of control runs found for the specified date. Individual runs are represented by *nnn*. For example, "1 of 3" means data on three control runs were found for this date, and the first of these is selected. Use ← → to scan the other matches. To exit without printing results for any run in this set, press EXIT to return to the screen in step 4; or press EXIT three times to return to standby mode.

Step 6. Print system QC data.

When the run of interest is selected. The following messages are displayed sequentially:

```
Insert card to print
results.
```

```
Printing results...
```

```
Remove card.
```

Step 7. Retrieve more control results.

When the card is removed, the display returns to the screen in step 4. Repeat steps 5 and 6.

Step 8. Return to standby mode.

Press EXIT three times.

4.9 Transmitting results to an external computer

If the analyzer is connected to an external computer, the results are automatically transmitted when the result card is printed. Follow this procedure when you wish to transmit all patient or control results currently stored in the analyzer memory to the computer eg, before reinitializing the software or before returning the analyzer to the Abaxis for service. Refer to 5.4 for information on reinitializing the software.

Step 1. Access the Recall function.

From standby mode, press RECALL. The display reads:

```
Recall: _XXXXXXX
1-Results
2-System QC
ENTER to accept.
```

Step 2. Access the Transmit Results function.

Press 9, *even though this is not shown as an option on the display*. Press ENTER.

```
Recall: 9 All Rslts
1-Results
2-System QC
ENTER to accept.
```

Step 3. Choose results category.

Press 1, ENTER to transmit all patient results or 2, ENTER to transmit all control results in memory. Up to two minutes may be required for all the results to be transmitted.

```
Recall: _XXXXXXXXX
1-Patient Result
2-Control Result
ENTER to accept.
```

During the transmission, the display reads:

```
Transmitting results...
```

When transmission is complete, the display returns to the screen in step 1.

Step 4. Return to standby mode.

Press EXIT three times.

4.10 Transmitting system QC data to an external computer

Step 1. Access the Recall function.

From standby mode, press RECALL. The display reads:

```
Recall: _XXXXXXX
1-Results
2-System QC
ENTER to accept.
```

Step 2. Access the Transmit System QC function.

Press 6, *even though this is not shown as an option on the display*. Press ENTER.

```
Recall: 6 All QC
1-Results
2-System QC
ENTER to accept.
```

Step 3. Choose the set to transmit.

Press 1, ENTER to transmit all patient system QC data, or 2, ENTER to transmit all control system QC data in memory. Up to two minutes may be required for all the results to be transmitted.

```
Recall: _ XXXXXXX
1-Patient Set
2-Control Set
ENTER to accept.
```

During the transmission, the display reads:

```
Transmitting results...
```

When transmission is complete, the display reads:

```
Recall: _ XXXXX
1-Patient Results
2-Control Results
ENTER to accept.
```

Step 4. Return to standby mode.

Press EXIT three times.

4.11 No results in memory

The message `No results found in memory` may be displayed if the analyzer's memory has been cleared during servicing.

Step 1. Return to the Recall screen.

Press `ENTER`. Verify that both patient results and control results are missing from the analyzer memory.

```
Recall: _XXXXXXXX
1-Patient Results
2-Control Results
ENTER to accept.
```

Step 2. Return to standby mode.

Press `EXIT` three times.

4.12 No system QC in memory

In step 3 of the procedure in 4.5, 4.6, 4.7, or 4.8, the analyzer may display a message informing you that there are no patient or control system QC data currently available in the analyzer memory. Press `ENTER` to return to the Recall screen.

Verify that both patient and control system QC data are missing from the analyzer memory.

```
Recall: _XXXXXXXX
1-Patient Results
2-Control Results
ENTER to accept.
```

Step 3. Return to standby mode.

Press `EXIT` three times.

Section 5: Maintenance and Troubleshooting

5.1 Routine maintenance

The Piccolo® Point-of-Care Chemistry Analyzer requires no scheduled servicing.

Maintenance of the analyzer is limited to:

- cleaning the exterior weekly, or as needed
- cleaning the printer and results card slot every 3 months
- cleaning the air filter every 6 months

Biohazard: The interior of the analyzer should be considered contaminated after the first sample or control has been run.

5.1.1 Cleaning the exterior

Clean the outside surface of the analyzer at least every week and immediately after sample, reagent, or other material has been spilled on it. Clean the analyzer with a soft cloth dampened with a mild detergent or cleaning solution, or a 10% bleach solution (1 part bleach to 9 parts water), or a 30% isopropyl alcohol solution. Do not spray or pour detergents or other solution directly onto the analyzer. Wipe the entire surface of the analyzer, including the keypad. Observe Universal Precautions when cleaning spills.

5.1.2 Cleaning the printer

The printer should be cleaned at least once every 3 months to avoid paper jams and printer malfunctions. Dust, debris, hair, or objects may become deposited in the result card slot during the course of operation. If more than one attempt is required to feed a card into the slot, the printer may require cleaning.

Procedure: Expel a steady stream of compressed air directly into the results card slot, sweeping from right to left, pausing momentarily, then sweeping back to the right. It is important to direct a stream of air into the left side of the slot to clear any debris from the print sensor.

If the problem persists, a more thorough cleaning may be required. Access the printer follow the instructions for clearing a paper jam; then expel compressed air directly into the printer. Contact Abaxis Technical Support for further assistance.

5.1.3 Cleaning the air filter

The air filter should be cleaned at least once every 6 months. Check the air filter more frequently if the analyzer is in a dusty environment. To clean the air filter:

Step 1. Remove the filter.

Power down the analyzer and unplug the power cord from the back panel. Remove the back panel by removing the two Phillips screws at the top of the panel. Grasp the black mesh filter in the circular opening and pull the filter free.

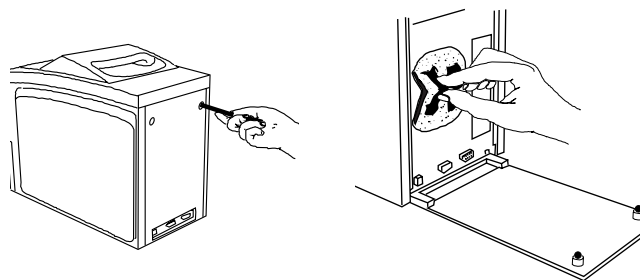

Step 2. Wash the filter.

Use warm soapy water. Dry the filter thoroughly before replacing it in the analyzer.

Step 3. Replace the filter.

Tuck the sides in behind the edges of the circular opening. Replace the rear panel.

Step 4. Power up the analyzer.

Reconnect the analyzer to the power supply and plug it in. The analyzer returns to standby mode.

If the analyzer reports an error, repeat the installation procedure. If the error persists, call Abaxis Technical Support.

5.2 Clearing a paper jam

If a results card becomes jammed in the printer, you can open the analyzer front panel and remove the card.

Step 1. Access the printer.

Open the disc drawer. Power down the analyzer and unplug the power cord from the back panel. Open the front panel by placing your thumbs at points A and B shown in the figure below. Grasp slot C on both sides of the front panel with your fingers and pull the panel toward you. (The panel is hinged at the bottom.) The printer is visible when the front panel is open.

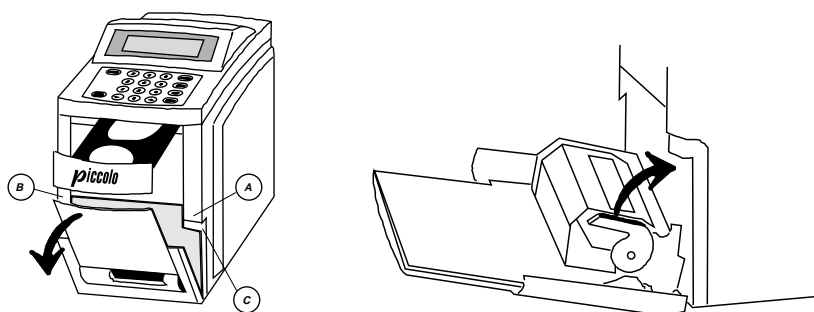

Step 2. Remove the jammed card.

Lift the printer-head lever located on the right side of the printer, as shown in the figure above. Carefully remove the jammed result card. Push the printer-head lever back down to its normal position. Press the front panel firmly into the closed position.

Step 3. Power up the analyzer.

Reconnect the analyzer to the power supply and plug it in. The analyzer returns to standby mode.

5.3 Installing a software card

From time to time, Abaxis will provide software cards to update and add functionality to the analyzer. To install a software card:

Step 1. Remove the existing software card.

Power down the analyzer and unplug the power cord from the back panel. Remove the back panel by removing the two Phillips screws at the top of the panel. Remove the software card retaining bracket by removing the Phillips screw. Take care to avoid losing this very small screw. To eject the card, push the black button at the top of the access slot. Refer to the figures below.

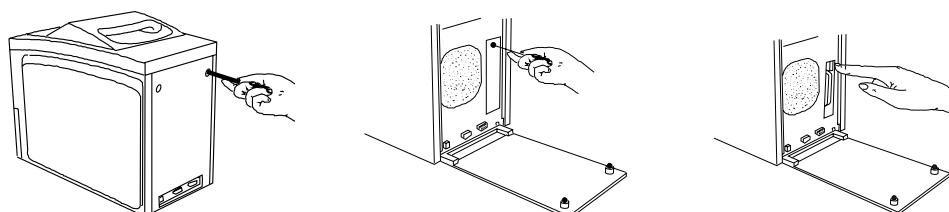

Step 2. Insert the new software card.

Insert the new card with the printed label facing toward the center of the analyzer. Refer to the figure to the right. Push the card in firmly until it clicks into place. Replace the retaining bracket and back panel.

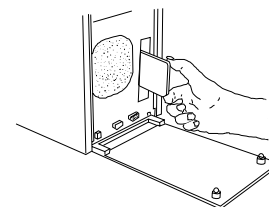

Step 3. Automatic reprogramming.

Power up the analyzer. It performs the self-test and reprogramming in about 10 minutes. Additional time may be required for the analyzer to reach operating temperature. The procedure is complete when the analyzer returns to standby mode.

If the analyzer reports an error, repeat the installation procedure, verifying that the new card is seated properly. If the error persists, call Abaxis Technical Support.

5.4 Reinitializing the analyzer

Reinitializing the analyzer may become necessary if the software becomes corrupted. A Code 28 error message is a warning that the software has become corrupted and must be reinitialized.

The reinitializing process clears all results from memory and deletes all customized reference ranges. After receiving a Code 28 message, check the status of the patient and control results in memory following the procedures in 4.1 and 4.3. If results remain in memory, and the analyzer is linked to an external computer, follow the instructions to transmit all patient and control results (4.9) and system QC data (4.10), respectively, to the external computer before reinitializing the software. If results remain in memory, and the analyzer is not linked to an external computer, print all records (patient, control, and system QC results) that you wish to retain, following the procedures in Section 4. Follow the procedure in 3.7 and/or 3.8 to print or transmit customized reference ranges.

Reinitializing restores all defaults. Refer to Section 3 for procedures for changing the date and time, selecting units, and customizing reference ranges.

Step 1. Access the Reset function.

From standby mode, press 0.

```
RESET
Internal Clock
CLEARING memory
ENTER to accept
```

Step 2. Verify intention to reset.

Press ENTER. The display reads:

```
Are you sure you want
to reset?
ENTER for yes
EXIT for no
```

Step 3. Begin reinitialization.

Press ENTER again. During the reinitialization process, the display reads:

```
Resetting clock ...
Clearing Memory ...
```

5.5 Returning the analyzer to Abaxis for service

If the procedures in Maintenance and Troubleshooting fail to resolve a problem with the operation of the analyzer, call Abaxis Technical Support. Authorization from Technical Support is required before returning an analyzer for repairs.

5.6 Error messages

The following list of warnings and error messages is in order by error code number. Some error codes include an internal error code number displayed flush left on the 4th line of the display. Record this internal error code number before pressing EXIT or calling Abaxis Technical Support. The number helps Technical Support to diagnose the problem. Some error messages generate a troubleshooting report in addition to the error code. Print the troubleshooting report before pressing EXIT. Have any error codes and the troubleshooting report, if applicable, at hand when calling Abaxis Technical Support.

Error Message	Explanation and Solution
<p>Code 10</p> <p>Run canceled: Barcode error. Repeat run with new disc. xxxx See Code 10</p>	<p>The disc bar code is unreadable because of scratches, spills, or other problems; or an outdated version of the software is installed on the analyzer.</p> <p>Record the internal error code (xxxx). Press EXIT to acknowledge the message and open the drawer. Remove and discard the disc. Prepare a new disc using the sample or control and proceed with testing.</p> <p>If this error message appears again during testing of the second disc, record the second internal error code. Insert a result card to print a troubleshooting report. When printing is complete, press EXIT. Remove and discard the disc. Call Abaxis Technical Support with both internal error codes and the troubleshooting report at hand.</p>
<p>Code 11</p> <p>Ambient temperature outside operational range of analyzer. See Code 11</p>	<p>The ambient temperature is outside the analyzer operating range (15-32°C; 59-90°F).</p> <p>Press EXIT to acknowledge the message. Adjust the room temperature, or power down the analyzer and move it to a warmer or cooler environment.</p>

Error Message	Explanation and Solution
<p>Code 12</p> <p>Run canceled. Analyzer temperature outside operating range. See Code 12</p>	<p>The analyzer temperature is too high or too low to run the disc.</p> <p>Press EXIT to acknowledge the message and open the drawer. Remove and discard the disc.</p> <p>Temperature too low: If you are running the first disc after powering up, allow the analyzer more warm-up time. If the ambient temperature is below 15°C (59°F), adjust the room temperature or move the analyzer to a warmer environment. Use a new disc to run the sample or control.</p> <p>Temperature too high: If the analyzer has run several discs, open the drawer and allow it to cool down for about 15 minutes. Use a new disc to run the sample or control.</p>
<p>Code 13</p> <p>Run canceled. Disc out of date. Repeat run with new disc. See Code 13.</p>	<p>The disc expiration date has passed.</p> <p>Press EXIT to acknowledge the message and open the drawer. Remove and discard the disc. Verify that the analyzer is using the correct date. Refer to 3.2. Use a within-date disc to run the sample or control.</p>
<p>Code 14</p> <p>Run canceled. Repeat run with new disc. xxxx See Code 14</p>	<p>The problem may be with the sample, the disc, or the analyzer hardware or software.</p> <p>Record the internal error code (xxxx). Press EXIT to acknowledge the message and open the drawer. Remove and discard the disc. Use a new disc to run the sample or control. There may be a brief delay (10-15 seconds) before testing begins.</p> <p>If this error message appears again during testing of the second disc, record the second internal error code. Insert a result card to print a troubleshooting report. Press EXIT to acknowledge the message and open the drawer. Remove and discard the disc. Call Abaxis Technical Support with both internal error codes and the troubleshooting report at hand.</p>

Error Message	Explanation and Solution
<p>Code 15</p> <p>Run canceled. Insufficient sample. Repeat run with new disc. See Code 15</p>	<p>The run has been canceled due to one of the following:</p> <ul style="list-style-type: none">• Insufficient sample or control is in the disc.• The whole blood sample has clotted.• A used disc has been left in the analyzer. <p>Press EXIT to acknowledge the message and open the drawer. Check the disc for insufficient or coagulated sample. Discard the disc. Use a new disc to run the sample or control.</p>
<p>Code 21</p> <p>Analyzer overheated. Refer to manual. See Code 21</p>	<p>This message may be displayed at the end of a run. The results of that run are not affected and may be reported. However, unless the analyzer is allowed to cool down, the next run may be aborted.</p> <p>Press EXIT to acknowledge the message and open the drawer. Remove and discard the disc. Leave the drawer open and allow the analyzer to cool down for about 15 minutes. If necessary, adjust the room temperature to 32°C (90°F) or less, or move the analyzer to a cooler environment.</p>
<p>Code 22</p> <p>Faulty software card. Refer to manual for card replacement. xxxx See Code 22</p>	<p>This message may be displayed after powering up the analyzer. The software card may not be seated properly or may be faulty.</p> <p>Record the internal error code (xxxxx). Press EXIT to acknowledge the message. The analyzer automatically shuts down. Refer to 5.3 for the procedure to reinstall the software card. If the problem persists, call Abaxis Technical Support.</p>
<p>Code 24</p> <p>Paper jammed in printer. Refer to manual to clear. See Code 24</p>	<p>Refer to 5.2 for instructions on clearing a paper jam.</p>

Error Message	Explanation and Solution
<p>Code 25</p> <p>Drawer malfunction. Refer to manual to clear. See Code 25</p>	<p>The drawer motor has shut down because the drawer cannot completely close or open.</p> <p>Drawer does not close: Press EXIT to acknowledge the message. Inspect the disc to see if the bar code ring has separated from the disc. If no separation is visible, reposition the disc and press close. If separation is visible, prepare a new disc and load it.</p> <p>Drawer does not open: Call Abaxis Technical Support.</p>
<p>Code 26</p> <p>Analyzer failure. Remove from service. xxxx See Code 26</p>	<p>The analyzer has been exposed to very cold temperatures or there is a problem with the analyzer hardware that cannot be corrected by resetting the analyzer (powering down and up). Record the internal error code (xxxx). Press EXIT to acknowledge the message. Power down the analyzer and allow it to sit for 15-30 minutes at an ambient temperature of 15-32°C (59-90°F). Power up the analyzer and allow adequate warm-up time before running a disc.</p> <p>If the analyzer has not been exposed to cold temperatures, there may be a hardware problem. Record the internal error code (xxxx). Press EXIT to acknowledge the message and shut down the analyzer. Call Abaxis Technical Support.</p>
<p>Code 27</p> <p>Run canceled. Disc rubbing. Repeat run with new disc. xxxx See Code 27</p>	<p>The disc is not spinning properly or is rubbing against the walls of the drawer.</p> <p>Record the internal error code (xxxx). Press EXIT to acknowledge the message and open the drawer. Remove and discard the disc. Use a new disc to run the sample or control.</p> <p>If this error appears again during testing of the second disc, record the second internal error code. Call Abaxis Technical Support with both internal error codes at hand.</p>

Error Message	Explanation and Solution
Code 28 Internal clock error corrected. Check analyzer time and date! See Code 28	The software may have become corrupted and may require reinitialization. Press EXIT to acknowledge the message. Refer to 5.4.
Code 31 No results found in memory. Run a disc before printing. See Code 31.	This message appears only before the first use of the analyzer or if the memory was cleared when the analyzer was serviced. Press EXIT to acknowledge the message. Run a sample or control before printing or recalling results.
Code 33 Reference ranges are corrupt. Ranges will be reset to factory values! See Code 33	There is a problem with the customized reference ranges stored in memory. All the ranges have been reset to the default value. Press EXIT to acknowledge the message. Refer to 3.6 for directions on customizing reference ranges.
Code 34 Memory error. All results and settings cleared from memory. See Code 34.	A memory error has been automatically corrected. All patient and control results stored in the analyzer have been lost. Menu functions have been restored to their default settings. Physician, operator, and patient ID numbers have been erased. Results cannot be restored. Press EXIT to acknowledge the message. Refer to Section 3 for instructions on resetting date, time and units, if necessary.
Code 35 Improper date set in analyzer. Correct date and repeat run. See Code 35	The internal clock is set to a date that is earlier than the manufacture date of the reagent disc. Press EXIT to acknowledge the message and open the drawer. Remove and discard the disc. Refer to 3.2 for instructions on resetting the date. Use a new disc to run the sample or control.



3240 Whipple Road
Union City, CA 94587
Tel: 800-822-2947
Fax: 510-441-6150
Email: VetScanDxS@Abaxis.com
www.abaxis.com