ABB DRIVES

Technical guide No. 6

Guide to harmonics with AC drives



Guide to harmonics

This guide is part of ABB's technical guide series, describing harmonic distortion, its sources and effects, and also distortion calculation and evaluation. Special attention has been given to the methods for reducing harmonics with AC drives.

Table of contents

004	Basics of the harmonics
007	Standards for harmonic limits
011	Evaluating harmonics
012	How to reduce harmonics
020	Other methods for harmonics reduction
023	Summary of harmonics reduction
025	Appendix
029	Definitions

Basics of the harmonics

Harmonic currents are created by non-linear loads connected to the power distribution system. Harmonic distortion is a form of pollution in the electric plant that can cause problems if the voltage distribution caused by harmonic currents increases above certain limits. All power electronic converters used in different types of electronic systems can increase harmonic disturbances by injecting harmonic currents directly into the grid.

Harmonic distortion sources and effects

Common non-linear loads include motor starters, variable speed drives, computers and other electronic devices, electronic lighting, welding supplies and uninterrupted power supplies.

The effects of harmonics can include overheating of transformers, cables, motors, generators and capacitors connected to the same power supply with the devices generating the harmonics. Electronic displays and lighting may flicker, circuit breakers may trip, computers may fail and metering may give false readings.

If the cause of the above mentioned symptoms is not known, then there is cause to investigate the harmonic distortion of the electricity distribution at the plant. The effects are likely to show up in the customer's plant before they show on the utility system.

This Technical guide has been published to help customers to understand the possible harmonic problems and make sure the harmonic distortion levels are not excessive.

Harmonic currents

In an ideal case the current in an AC grid is a pure sine wave and does not contain harmonics. In reality the current deviates from this pure sine wave and contains harmonics.

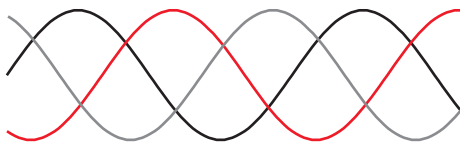

Figure 1.1 A pure sinusoidal voltage and current does not contain any harmonics.



Figure 1.2 Voltage and current that deviate from the sine form contain harmonics.

All continuous periodic signals can be presented as a sum of sinusoidal components: Fundamental + 3rd + 5th + 7th + ...

The harmonic current frequencies of a 6-pulse three phase rectifier are n times the fundamental frequency (50 or 60 Hz). On a 50 Hz network a 150 Hz (3 x 50 Hz) waveform is the 3rd harmonic, a 250 Hz (5 x 50 Hz) waveform is the 5th harmonic, a 350 Hz (7 x 50 Hz) is the 7th harmonic and so on.

The principle of how the harmonic components are added to the fundamental current is shown in figure 1.3, where only the 5th harmonic is shown. Usually harmonics are calculated up to the 40th or 50th order.

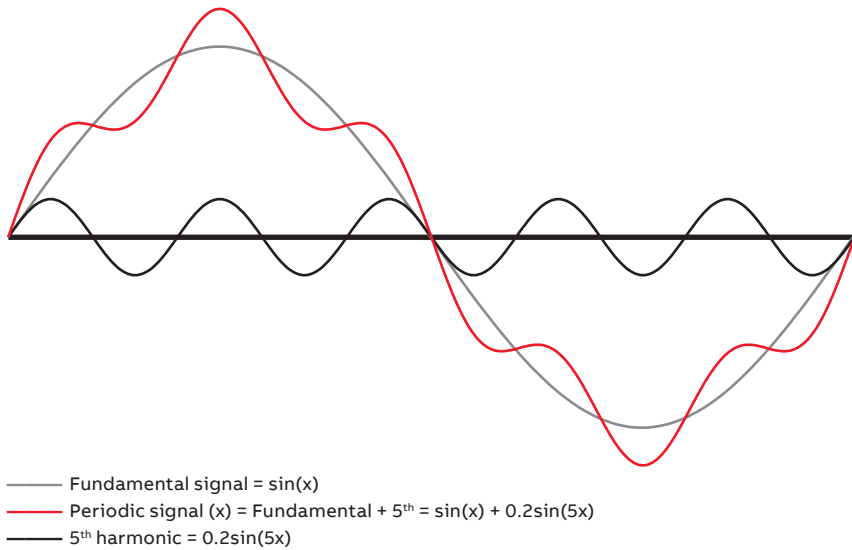

Figure 1.3 The total current as the sum of the fundamental and 5th harmonic.

The amount of harmonic distortion is expressed as a THDI% value:

$$THD = \frac{\sqrt{\sum_{n=2}^{\infty} I_n^2}}{I_1}$$

where I_1 is the rms value of the fundamental frequency current and I_n is the nth harmonic component.

Harmonic components are as shown in Figure 1.4.

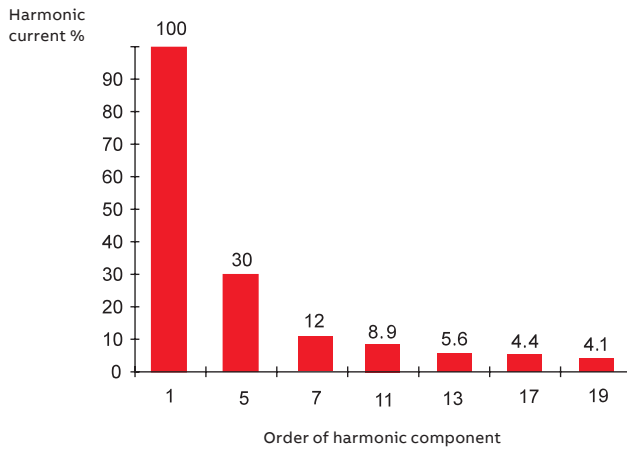

Figure 1.4 The harmonic content in a current of a 6-pulse rectifier (with choke).

Standards for harmonic limits

Limits for harmonic currents are given in several national and international standards. Additionally, many transmission and distribution system operators have issued requirements especially for high power equipment connected directly to medium or high power grids. Certain industries have even set factory-specific regulations.

The most important standards are the ones issued by International Electrotechnical Commission (IEC). These are important especially within the countries of the European Economic Area (EEA) that have agreed on common minimum regulatory requirements in order to ensure the free movement of products within the EEA. The CE marking indicates that the product works in conformity with the directives that are valid for the product. The corresponding European standards specify the requirements that must be met. In general the European EN standards are the same as the IEC ones, only the prefix IEC is replaced by EN.

Another important publisher is the Institute of Electrical and Electronics Engineers (IEEE) located in the USA. IEEE standards are often required outside the USA as well.

The most common international and national standards that set limits on harmonics are described shortly in the following.

EN 61800-3 (IEC 61800-3) Adjustable speed electrical power drive systems Part 3: EMC requirements and specific test methods

IEC 61800-3 is the product standard for drives that defines requirements for electromagnetic compatibility (EMC). Regarding harmonics in a low voltage (230/400 V, 50 Hz) public supply network, the limits and requirements of IEC 61000-3-2 apply for equipment with a rated current of ≤ 16 A. For equipment with a rated current greater than 16 A but less than 75 A standard IEC 61000-3-12 applies.

Note that when one or more power drive systems (PDS) are included in equipment the standards apply to the complete equipment, not the PDS alone. Thus if the equipment contains linear loads such as heating resistors in addition to PDS, higher harmonic emissions from PDS are allowed for equipment in the scope of IEC 61000-3-12 as the rated current of the equipment is higher than the rated current of the PDS alone. For professional equipment in the scope of IEC 61000-3-2 no limits are specified if the total rated power is greater than 1 kW.

For equipment not in the scope of IEC 61000-3-2 or IEC 61000-3-12 standards, the IEC 61800-3 states that the manufacturer shall provide in the documentation of the PDS, or on request, the current harmonic level THC, under rated conditions, as a percentage of the rated RMS current on the power port. The harmonic currents and the corresponding THC shall be calculated for each order up to the 40th. For these standard calculations, the PDS shall be assumed to be connected to a point of coupling (PC) with a short circuit ratio of $R_{sc} = 250$ and with initial voltage distortion less than 1%. The internal impedance of the network shall be assumed to be pure reactance. If a PDS is used in an industrial installation, a reasonable economical approach, which considers the total installation, should be applied. This approach is based on the agreed power, which the supply can deliver at any time. The method for calculating the harmonics of the total installation is agreed

and the limits for either the voltage distortion or the total harmonic current emission are agreed on. The compatibility limits given in IEC 61000-2-4 may be used as the limits for voltage distortion.

IEC 61000-2-2, Electromagnetic compatibility (EMC)

Part 2-2: Environment - Compatibility levels for low frequency conducted disturbances and signalling in public low voltage power supply systems

This standard sets the compatibility limits for low frequency conducted disturbances and signalling in public low voltage power supply systems. The disturbance phenomena include harmonics, inter-harmonics, voltage fluctuations, voltage dips and short interruptions, voltage imbalance and so on. Basically this standard sets the design criteria for the equipment manufacturer, and amounts to the minimum immunity requirements for the equipment. IEC 61000-2-2 is in line with the limits set in EN 50160 for the quality of the voltage the utility owner must provide at the customer's supply-terminals.

IEC 61000-2-4, Electromagnetic compatibility (EMC)

Part 2-4: Environment - Compatibility levels in industrial plants for low frequency conducted disturbances

IEC 61000-2-4 is similar to IEC 61000-2-2, but it gives compatibility levels for industrial and non-public networks. It covers low-voltage networks as well as medium voltage supplies excluding the networks for ships, aircraft, offshore platforms and railways.

IEC 61000-3-2, Electromagnetic compatibility (EMC)

Part 3-2: Limits - Limits for harmonic current emissions (equipment current < 16 A per phase)

This standard deals with the harmonic current emission limits for individual pieces of equipment connected to public networks. This standard is often updated because new devices are constantly arriving on the market and require specific testing conditions.

IEC 61000-3-4, Electromagnetic compatibility (EMC)

This standard has been published as a Type II Technical report. It gives the harmonic current emission limits for individual pieces of equipment having a rated current of more than 16 A. It applies to public networks having nominal voltages from 230 V single phase to 600 V three phase. IEC 61000-3-4 was replaced in the current range from 16 A to 75 A by IEC 61000-3-12 and for currents greater than 75 A no limits are specified by IEC 61000-3-4. Though IEC 61000-3-4 is today quite redundant, references to it may still be found in various documents.

IEC 61000-4-7 Electromagnetic compatibility (EMC)

Part 4-7: Testing and measurement techniques - General guide on harmonics and interharmonics measurements and instrumentation, for power systems and equipment connected there to.

This standard specifies methods used in harmonic measurements. The harmonics can be measured without grouping, with grouping and with sub-grouping. The advantage of grouping and sub-grouping is more steady measured harmonic current values with fluctuating loads.

Grouping means that the spectral components obtained at a 5 Hz frequency resolution from a Fourier-analysis calculated from 200 ms time window of the measured signal are summed together around the harmonic frequencies.

For example, in a 50 Hz grid the 5th harmonic is at 250 Hz frequency. Without grouping the value of the harmonic will be the RMS value of the spectral component at 250 Hz frequency only. When sub-grouping is applied, the RMS spectral components at frequencies 245 Hz, 250 Hz and 255 Hz are squared, summed and then the square root is taken from the sum. With grouping the summing is extended to 225 Hz, 230 Hz, 235 Hz, 240 Hz, 245 Hz, 250 Hz, 255 Hz, 260 Hz, 265 Hz, 270 Hz and 275 Hz spectral components. However, only half of the 225 Hz and 275 Hz frequency component values are used in the calculations.

For diode rectifiers with a constant load the difference between harmonic current values obtained without grouping, grouping and sub-grouping are small. Some increase can be observed if the load is fluctuating rapidly.

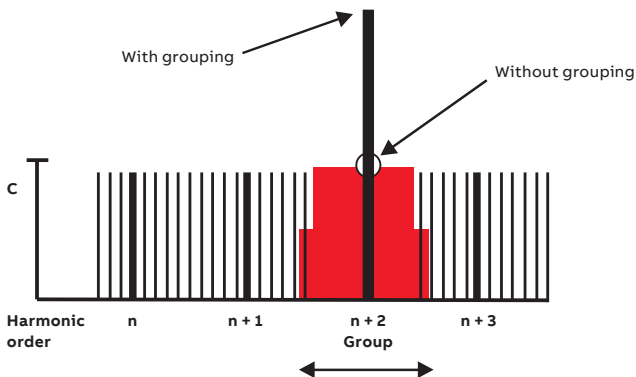

Figure 2.1 Grouping of the spectral components increases the harmonic current value if the spectrum is continuous.

At the moment according to clause 7 of the 2nd edition of IEC 61000-4-7 the manufacturer of the device can carry out the compatibility testing with IEC 61000-3-2 and IEC 61000-3-12 limits with or without grouping. If the measurement has been made without grouping, the test report should state that the measuring instrumentation has been according to the 1991 edition.

Further note that IEEE 519-2014 makes reference to IEC 61000-4-7 and requires measurements to be made with sub-grouping.

IEC 61000-4-30 Electromagnetic compatibility (EMC)

Part 4-30: Testing and measurement techniques - Power quality measurement methods.

This standard specifies requirements for power quality meters. Regarding the harmonics, the most accurate Class A meters should use sub-grouping for both voltage and current harmonics. For less demanding Class S meters the manufacturer of the meter can select either grouping or sub-grouping to be used in their products.

IEC/TR 61000-3-6, IEC/TR 61000-3-13, IEC/TR 61000-3-14 and IEC/TR 61000-3-15

These IEC publications are technical reports. Technical reports cannot contain any requirements but they can present values and methods as suggestions, recommendations and guidance. IEC/TR 61000-3-6 and IEC 61000-3-13 deal with harmonic emissions of installations connected to medium, high and extra high voltage systems. IEC/TR 61000-3-14 deals with harmonic emissions of installations connected to low voltage public systems. IEC/TR 61000-3-15 deals with harmonic emissions of dispersed generation such as photovoltaic generation.

IEEE 519, IEEE Recommended practices and requirements for harmonic control in electrical power systems

The philosophy of developing harmonic limits in this recommended practice is to limit the harmonic injection from individual customers so that they will not cause unacceptable voltage distortion levels for normal system characteristics and to limit the overall harmonic distortion of the system voltage supplied by the utility. This standard is also recognised as the American National Standard and it is widely used in the USA, especially in the municipal public works market.

The standard does not provide limits for individual equipment, but for individual customers. The customers are categorised by the ratio of available short circuit current (I_{sc}) to their maximum demand load current (I_L) at the point of common coupling. The total demand load current is the sum of both linear and non-linear loads. Within an industrial plant, the PCC is clearly defined as the point between the non-linear load and other loads.

The allowed individual harmonic currents and total harmonic distortion is presented as the ratio of available short circuit current to the total demand load current (I_{sc}/I_L) at the point of common coupling. The limits are as a percentage of I_L for all odd and even harmonics from 2 to infinity. The corresponding distortion is called the total demand distortion and it should also be calculated up to infinity. Many authors limit the calculation of both the individual components and TDD to 50.

Table 2 of the 2014 standard version is sometimes misinterpreted to give limits for the harmonic emissions of a single apparatus by using short circuit ratio (R_{sc}) of the equipment instead of I_{sc}/I_L of the whole installation. The limits of the table should not be used this way, since the ratio of the short circuit current to the total demand load current of an installation should always be used.

IEEE 1547 series for distributed resources

IEEE 1547 standards deal with interconnecting distributed resources such as photovoltaic generation with electric power systems. Currently the series contains in addition to IEEE 1547 also standards IEEE 1547.1 to IEEE 1547.4 and IEEE 1547.6 to IEEE 1547.8. The limits for harmonics are defined in IEEE 1547, they are the same as the most restrictive limits in IEEE 519. Testing of harmonic emissions is specified in IEEE 1547.1. Guidance for harmonic studies is given in IEEE 1547.7.

Evaluating harmonics

The IEEE P519.1/D12 “Guide for applying harmonic limits on power systems” (draft) introduces some general rules for evaluating harmonic limits at an industrial facility. The procedure is shown in the flowchart in figure 3.1.

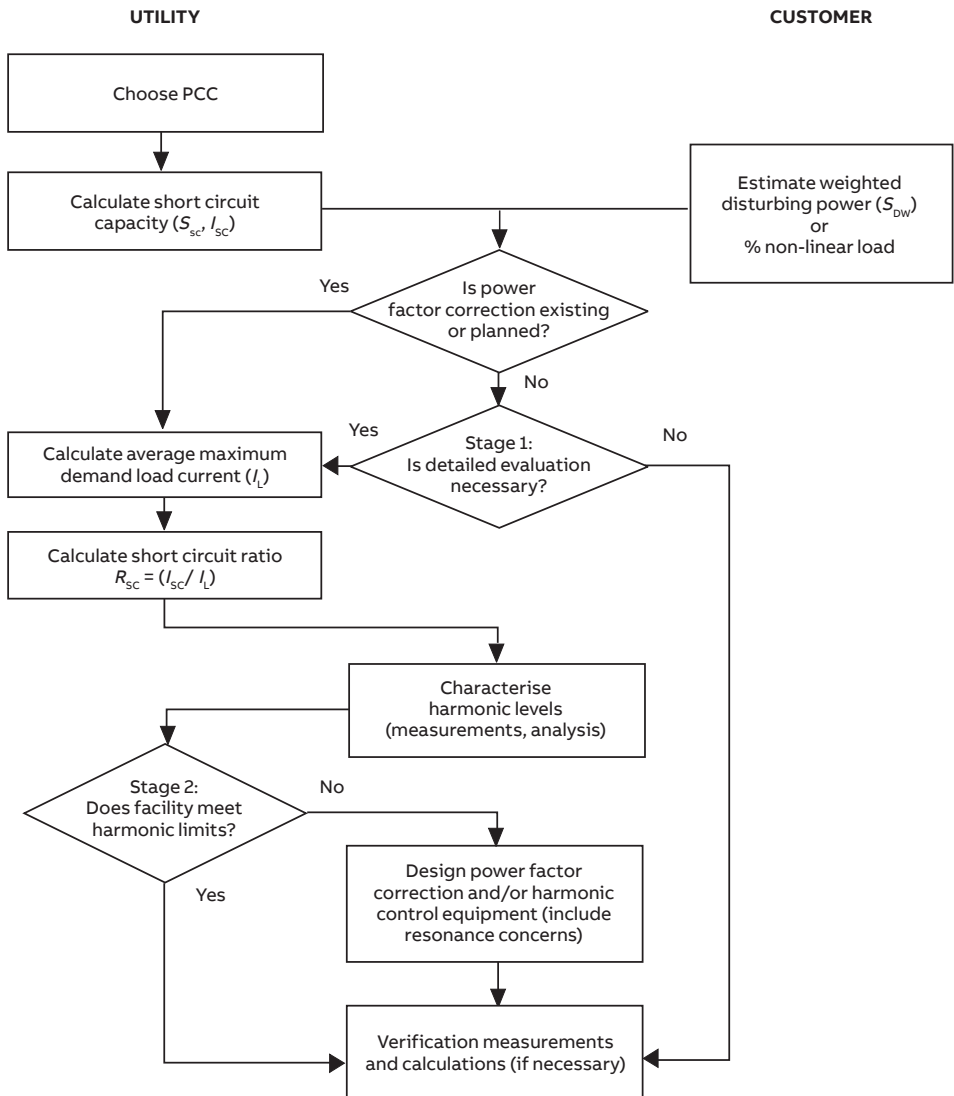

Figure 3.1 Evaluation of harmonic distortion.

How to reduce harmonics

by making structural modifications in the AC drive system

Factors in the AC drive which affect harmonics

Harmonics reduction can be achieved either by structural modifications in the drive system or by using external filtering. The structural modifications may be to strengthen the supply, or to use 12 or more pulse drives, to use a controlled rectifier or to improve the internal filtering in the drive.

Figure 4.1 shows the factors in the AC drive system which have some influence on harmonics. The current harmonics depend on the drive construction and the voltage harmonics are the current harmonics multiplied by the supply impedances.

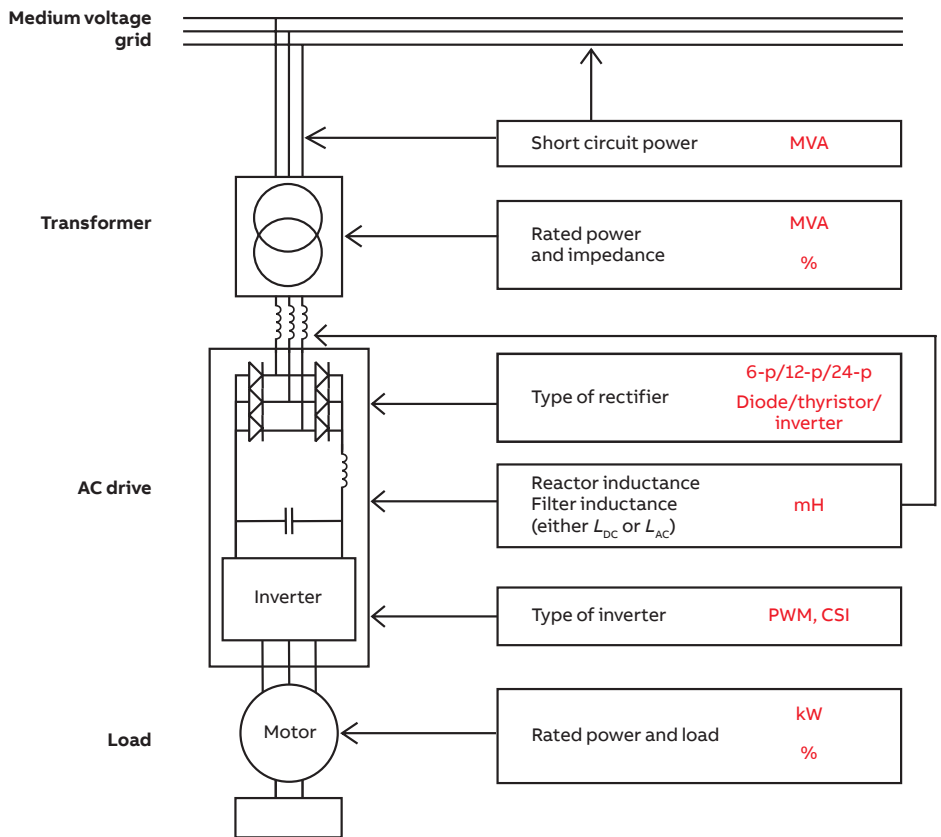

Figure 4.1 Drive system features affecting harmonics.

Using a larger DC or AC choke

The harmonics of a voltage source AC drive can be significantly reduced by connecting a large enough choke to its AC input or DC bus. The trend has been to reduce the size of converter while the choke size has been also reduced, or in several cases it has been omitted totally. The effect of this can be seen from the curve forms in figure 4.2.

The chart in figure 4.3 shows the effect of the size of the DC choke on the harmonics. For the first 25 harmonic components the theoretical THD minimum is 29%. That value is practically reached when the inductance is 100 mH for a 1 kW motor or 1 mH for a 100 kW motor (415 V, 50 Hz). In practice optimum dimensioning can be reached when the product of the motor power in kW and the inductance in mH is close to 25.

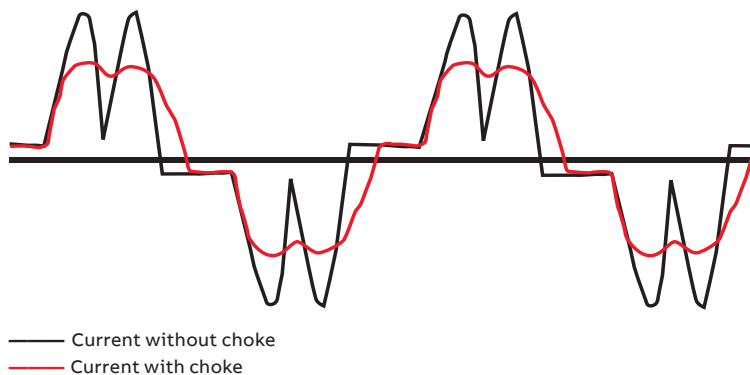

Figure 4.2 The effect of a choke on the line current.

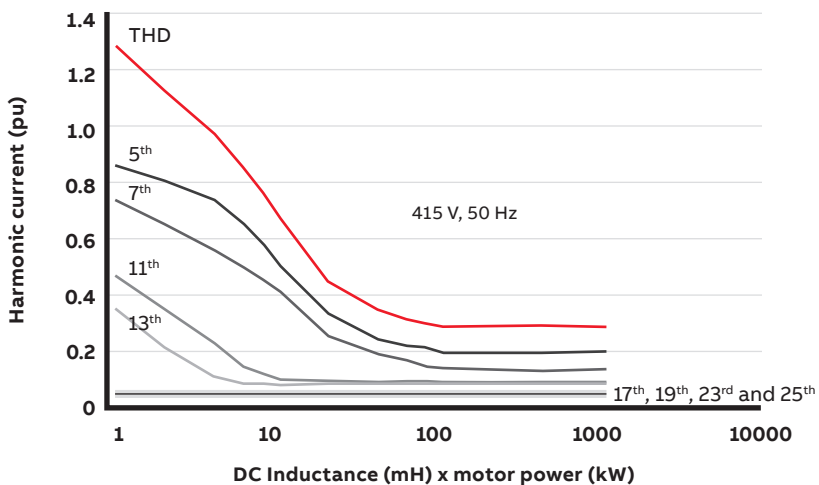

Figure 4.3 Harmonic current as a function of DC inductance.

The voltage distortion with certain current distortion depends on the short circuit ratio R_{sc} of the supply. The higher the ratio, the lower the voltage distortion. This can be seen in Figure 4.4.

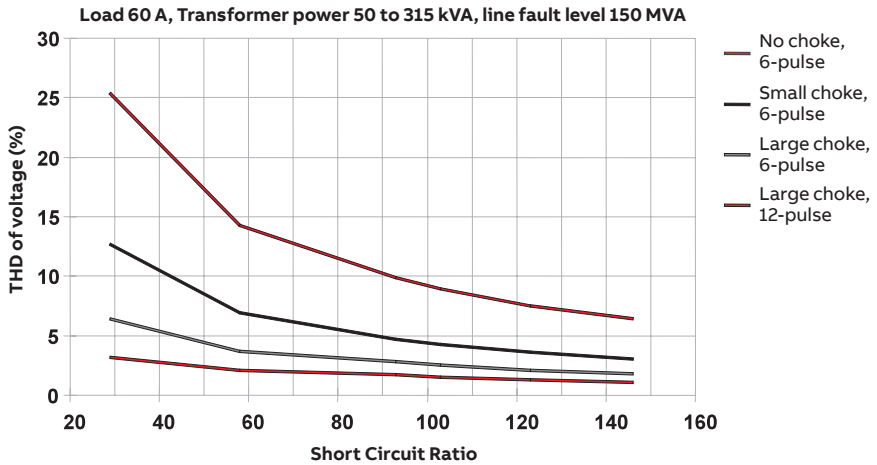
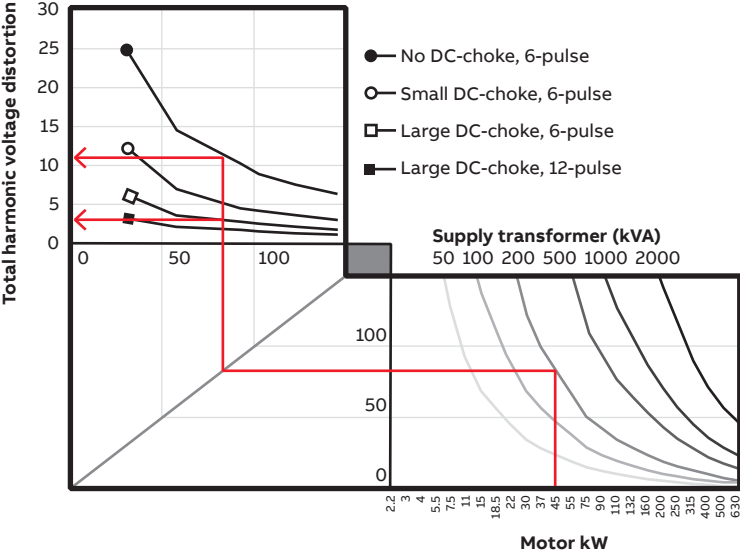

Figure 4.4 THD voltage vs type of AC drive and short circuit ratio.

Figure 4.5 introduces a simple nomogram for the estimation of harmonic voltages. On the graph below select first the motor kilowatt, then the transformer kVA and then move horizontally to the diagonal line where you move upwards and stop at the curve valid for your application. Then turn left to the y-axis and read the total harmonic voltage distortion.

- Input data for calculations:
- Rated motor for the drive
 - Constant torque load
 - Voltage 415 V
 - Drive efficiency = 97%
 - Supply Impedance = 10% of transformer impedance



Example: A 45 kW Motor is connected to "a 200 kVA transformer."
THD = ca. 3% with a "Large Choke Drive" and ca. 11% with a "No Choke Drive"

Figure 4.5 Total harmonic distortion nomogram.

Results from laboratory tests with drive units from different manufacturers are shown in figure 4.6. Drive A with a large DC choke has the lowest harmonic current distortion, whereas drives with no choke installed have the highest distortion.

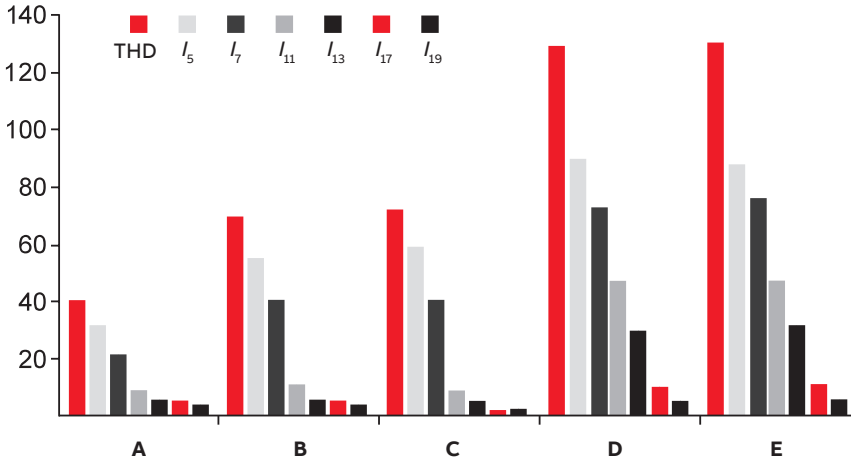

Figure 4.6 Harmonic current with different Dc-inductances. A = Large DC-inductance, B, C = Small DC-inductance, D, E = Without DC-inductance

Using 12-pulse or 24-pulse rectifiers instead of 6-pulse rectifiers

The connections for different rectifier solutions are shown in figure 4.7. The most common rectifier circuit in 3-phase AC drives is a 6-pulse diode bridge. It consists of six diodes and a choke, which together with a DC-capacitor form a low-pass filter for smoothing the DC-current. The choke can be on the DC- or AC-side or it can be left totally out. The 6-pulse rectifier is simple and cost effective but it generates a high amount of low order harmonics 5th, 7th and 11th especially with a small smoothing inductance.

The current waveform is shown in figure 4.7. If the major part of the load consists of converters with a 6-pulse rectifier, the supply transformer needs to be oversized and meeting the requirements in the standards may be difficult. Often some harmonics filtering is needed.

A 12-pulse rectifier is formed by connecting two 6-pulse rectifiers in parallel to feed a common DC-bus. The input to the rectifiers is provided by a three-winding transformer. The transformer secondaries are at a 30° phase shift. The benefit with this arrangement in the supply side is that some of the harmonics are in opposite phase and thus eliminated. In theory the harmonic component with the lowest frequency seen at the primary of the transformer is the 11th.

The major drawbacks are the need for special transformers and a higher cost than with the 6-pulse rectifier.

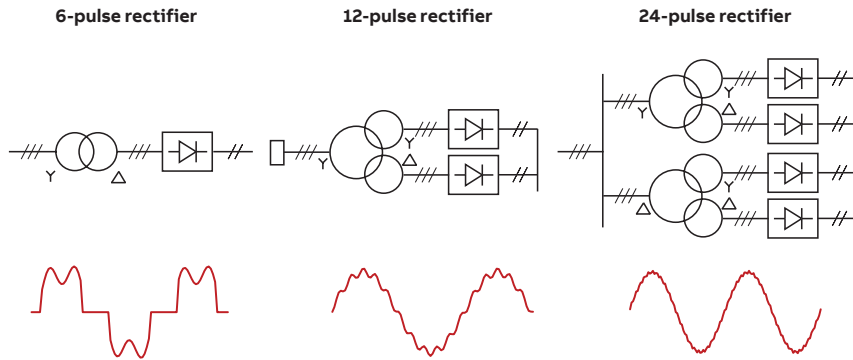

Figure 4.7 Line current waveforms with different rectifier constructions.

The principle of the 24-pulse rectifier is also shown in figure 4.7. It has two 12-pulse rectifiers in parallel with two three-winding transformers having a 15° phase shift. The benefit is that practically all low frequency harmonics are eliminated but the drawback is the high cost. In the case of a high power single drive or large multidrive installation a 24-pulse system may be the most economical solution with the lowest harmonic distortion.

A phase controlled rectifier is accomplished by replacing the diodes in a 6-pulse rectifier with thyristors. Since a thyristor needs a triggering pulse for the transition from a nonconducting to a conducting state, the phase angle at which the thyristor starts to conduct can be delayed. By delaying the firing angle over 90° , the DC-bus voltage turns negative. This allows a regenerative flow of power from the DC-bus back to the power supply.

Voltage source inverter configurations do not allow a polarity change of the DC-voltage and it is more common to connect another thyristor bridge anti-parallel with the first one in order to allow the current polarity reversal. In this configuration the first bridge conducts in rectifying mode and the other in regenerating mode.

The current waveforms of phase controlled rectifiers are similar to those of the corresponding 6, 12 and 24-pulse diode rectifiers, but the displacement power factor is lower when the firing angle is greater than zero. Thus the power factor in braking is lower than in normal operation.

In addition to these problems, a converter utilizing phase control causes larger commutation notches in the utility voltage waveform. The angular position of the notches varies along with the firing angle.

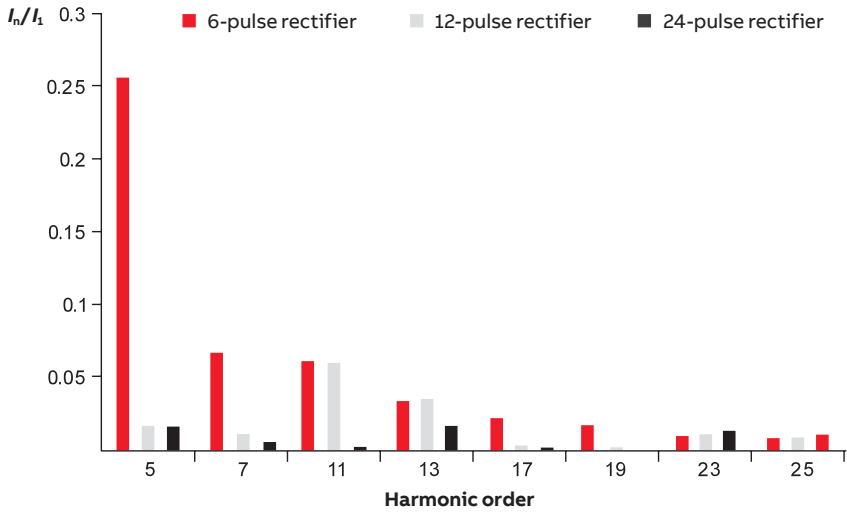

Figure 4.8 Harmonic components with different rectifiers.

Supply type	Current TDH (%)	Voltage TDH (%) $R_{sc}=20$	Voltage TDH (%) $R_{sc}=100$	Current waveform
6-pulse rectifier	40	10	2	
12-pulse rectifier	10	2.0	0.5	
IGBT supply unit	4	1.5	0.3	

Figure 4.9 Distortion of different supply unit types. Values may vary case by case. Distortion is in % of RMS values.

Using an IGBT supply unit (ISU), i.e. low harmonic drive

Introducing a rectifier bridge, made of self commutated components, brings several benefits and opportunities compared to phase commutated ones. Like a phase controlled rectifier, an active supply unit allows both rectification and regeneration, but it makes it possible to control the DC-voltage level and displacement power factor separately regardless of the power flow direction.

The main benefits are:

- Improved ride-through in case of mains supply disappearance.
- High dynamics of the drive control even in the field weakening range.
- Ability to generate reactive power.

- Nearly sinusoidal supply current with low harmonic content. Measured results for one drive are shown in figure 4.10. When comparing with figures from 4.7 to 4.9 we can see a clear difference. The active supply unit has very low harmonics at lower frequencies, but somewhat higher at higher frequencies.
- Voltage boost capability. In case of low supply voltage the DC voltage can be boosted to keep the motor voltage higher than the supply voltage.

One drawback is the high frequency common mode distortion of the phase to neutral and phase to ground voltages. Dedicated filtering to suppress high frequency content is needed to prevent interference.

Regenerative rectifier unit (RRU)

An alternative form of IGBT bridge is the Regenerative Rectifier Unit (RRU) where the IGBTs are controlled to conduct at the same intervals as diodes in a 6-pulse bridge. As the current can flow in either direction in the IGBT bridge it is possible to feed energy back to the AC grid during braking. The current harmonics are naturally similar to the 6-pulse diode bridge ones.

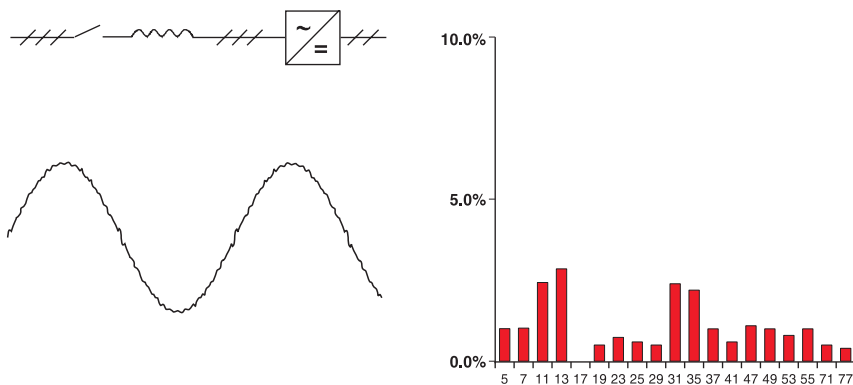

Figure 4.10 Harmonics in line current active supply unit.

List of the different factors and their effects for drive systems with diode rectifiers

The cause	The effect
The larger the motor...	the higher the current harmonics
The higher the motor load...	the higher the current harmonics
The larger the DC or AC inductance...	the lower the current harmonics
The higher the number of pulses in the rectifier...	the lower the current harmonics
The larger the transformer...	the lower the voltage harmonics ¹⁾
The lower the transformer impedance...	the lower the voltage harmonics ¹⁾
The higher the short circuit capacity of supply...	the lower the voltage harmonics

¹⁾ on the low voltage side of the transformer

Other methods for harmonics reduction

Filtering is one method to reduce harmonics in an industrial plant when the harmonic distortion has been gradually increased or as a total solution in a new plant. There are two basic methods: passive and active filters.

Tuned single arm passive filter

The principle of a tuned arm passive filter is shown in figure 5.1. A tuned arm passive filter should be applied at the single lowest harmonic component where there is significant harmonic generation in the system. For systems that mostly supply an industrial load this would probably be the fifth harmonic. Above the tuned frequency the harmonics are absorbed but below that frequency they may be amplified.

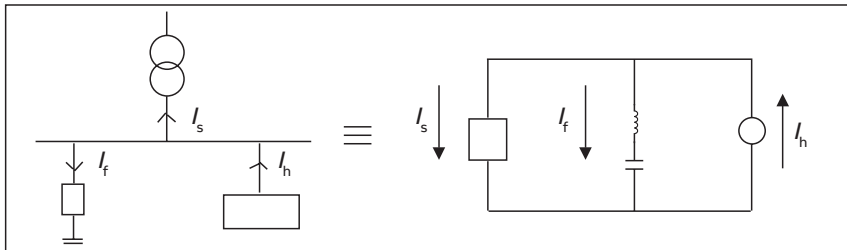

- Detuned - Single tuning frequency
- Above tuned frequency harmonics absorbed
- Below tuned frequency harmonics may be amplified
- Harmonic reduction limited by possible over compensation at the supply frequency and network itself

Figure 5.1 Tuned single arm passive filter.

This kind of filter consists of a choke in series with a capacitor and the best location for the passive filter is close to the harmonic generating loads. This solution is not normally used for new installations.

Tuned multiple arm passive filter

The principle of this filter is shown in figure 5.2. This filter has several arms tuned to two or more of the harmonic components which should be the lowest significant harmonic frequencies in the system. The multiple filter has better harmonic absorption than the one arm system.

The multiple arm passive filters are often used for large DC drive installations where a dedicated transformer supplies the whole installation.

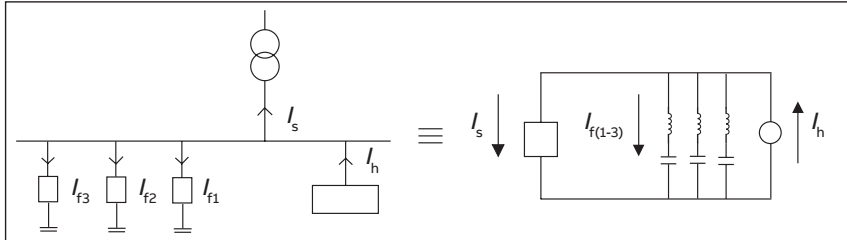

- Capacitive below the tuned frequency/Inductive above
- Better harmonic absorption
- Risk of amplification of harmonics due to filter resonance
- Limited by KVA_r and network

Figure 5.2 Tuned multiple arm passive filter.

There are some drawbacks related to using passive filters. On partial loads there is a risk of voltage rise due to excess filter capacitance causing a leading power factor. This may create an overvoltage situation and even an unwanted process interruption. Particular care should be taken if generator supplies are used as they have strictly defined tolerances for leading power factors.

External active filter

A passive tuned filter introduces new resonances that can cause additional harmonic problems. New power electronics technologies are resulting in products that can control harmonic distortion with active controls. These active filters, see figure 5.3, provide compensation for harmonic components in the utility system based on existing harmonic generation at any given moment in time.

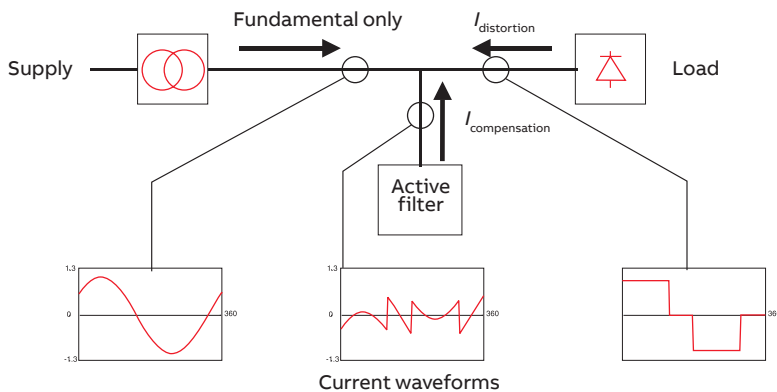

Figure 5.3 Diagram of the external active filter principle.

An active filter compensates for the harmonics generated by nonlinear loads by generating the same harmonic components in opposite phase as shown in figure 5.4. External active filters are most suited to multiple small drives. They are relatively expensive compared to other methods.

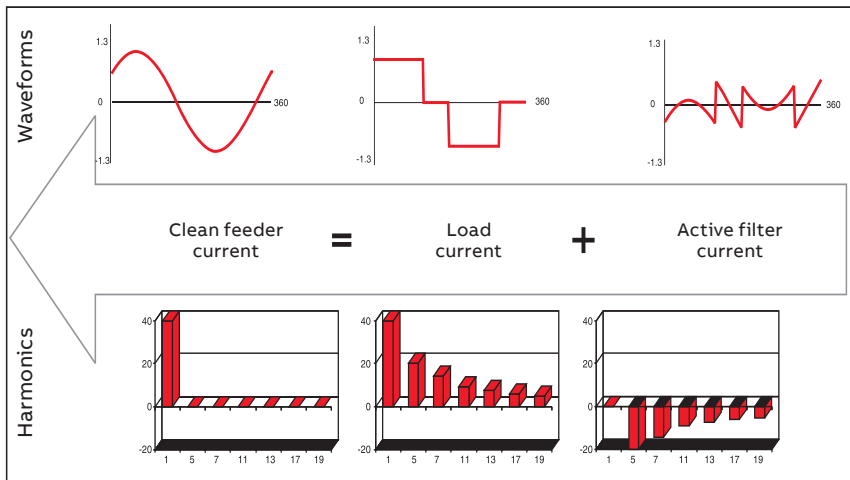

Figure 5.4 External active filter waveforms and harmonics.

Summary of harmonics reduction

There are many options to reduce harmonics either inside the drive system or externally. They all have advantages and disadvantages and all of them have cost implications. The best solution will depend on the total loading, the supply to the site and the standing distortion.

In the following table the harmonic content is given with a 100% load.

Typical harmonic current components						
6-pulse rectifier without choke						
Fundamental	5th	7th	11th	13th	17th	19th
100%	63%	54%	10%	6.1%	6.7%	4.8%
6-pulse rectifier with choke						
100%	30%	12%	8.9%	5.6%	4.4%	4.1%
6-pulse rectifier with passive filter						
100%	3%	3.3%	3.5%	2.3%	1%	1%
6-pulse rectifier with active filter						
100%	2.3%	2.5%	2.6%	1.7%	0.8%	0.7%
12-pulse rectifier with polycon transformer						
100%	11%	5.8%	6.2%	4.7%	1.7%	1.4%
12-pulse with double wound transformer						
100%	3.6%	2.6%	7.5%	5.2%	1.2%	1.3%
24-pulse rectifier with 2/3-winding transformers						
100%	4%	2.7%	1%	0.7%	1.4%	1.4%
IGBT supplied drive / low harmonic drive						
100%	0.7%	1.4%	1%	0.7%	1%	0.6%

Comparison of harmonics reduction solutions

	6-pulse rectifier without choke	6-pulse rectifier with large choke	6-pulse drive and passive filter	6-pulse drive and active filter	Multipulse drive	IGBT supplied drive / low harmonic drive
Typical THDI% at nominal load	>100%	40%	<10%	<5%	6 to 10% (12-pulse) <6% (18-pulse)	<5%
Drive system efficiency (excluding motor and supply), typical value at rated power	~98%	~97%	~96.5% ¹⁾	~96.5% ¹⁾	~96% ²⁾	~96.5% ³⁾
Motor voltage ⁴⁾	~0.96 x supply voltage	~0.95 x supply voltage	~0.95 x supply voltage	~0.95 x supply voltage	~0.95 x supply voltage	Full motor voltage
True power factor	~0.7 at nominal load only	~0.98 at nominal load only	~0.98 at nominal load only	~0.99 at nominal load only	~0.98 at nominal load only	1.0 at all load conditions
Simplicity of the installation	One single component	One single component or two separate components	Two separate components	Two separate components	Multiple separate components	One single component
Installation footprint ⁶⁾	100%	110%	250%	250%	300% ⁵⁾	120%
Equipment cost of all required components ⁶⁾	100%	120%	190%	230%	200% ⁵⁾	190%

Data is based on a 100 kW installation. Results may vary depending on equipment types and their dimensioning.

For IGBT supplied drive, evaluations are based on ABB ultra-low harmonic drives.

¹⁾ Both filter and drive efficiency must be considered: Filter efficiency is ~98.5% and standard 6-pulse drive efficiency is ~98%. The total combined efficiency is ~96.5%

²⁾ Transformer and drive efficiency must be considered: Typical total combined efficiency is ~96%

³⁾ Increased losses through inverter supply unit and filter. The total combined efficiency is ~96.5%

⁴⁾ To achieve the same mechanical power with lower motor voltage, higher current is needed which equates to higher losses in the motor.

⁵⁾ Cost and size comparison includes dedicated multiwinding transformer.

⁶⁾ Footprint and cost are compared to a single drive installation.

Appendix

Harmonic distortion calculation using DriveSize software

The DriveSize software is designed to speed up motor and drive selection based on motor load. The network harmonics analysis feature of the software is based on the DC-power required from the rectifying or regenerative supply units. By default DriveSize will calculate the DC power by adding motor losses and drive losses to the mechanical power on the motor shaft (base power) used to select the motor. However, calculations can be done with partial loads and reasonable overloads too. Other parameters for the network are the frequency, short-circuit power, as well as the primary and secondary voltages of the transformer, which are given as network and transformer data.

The analyzed system is limited to have transformers only with two or three windings. Another limitation is that only AC motor drives can be connected to the transformer secondary. When in real systems some linear loads are present or planned, users are encouraged to add those currents to the fundamental current of the produced Excel reports themselves.

Calculation example with DriveSize Web online version

Let's take an example of a 690 V system with three motor drives, which have base powers of 50 kW, 500 kW and 500 kW. The motor and drive selections are ready and also the transformer. Figure 7.1 shows how the project configuration is presented on screen. Please notice that the two drives are so called 6-pulse diode bridge fed drives (ACS880-01 and ACS880-07) and the third drive is a low harmonic drive (ACS880-37). It could be also a regenerative drive. The regenerative and low harmonic drives contain active supply units and LCL filtering and thus have low harmonic content in their AC current.

With DriveSize the harmonics can be computed at individual drive level, or at transformer level. If a single drive in the list is highlighted then the harmonics are computed just for that drive. In real life this would mean that the other drives should be turned off so they do not influence the harmonic levels. When the individual drive harmonics are calculated the drive cable parameters can be studied. Also if the drive has an AC choke the user might want to study whether extra external AC inductance would be beneficial.

At this level the user can also easily compare different types of drives: 6-pulse/12-pulse/active supply unit drives and regenerative rectifier unit drives.

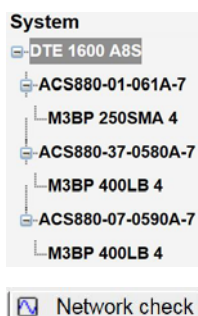

Figure 7.1 A project example that has three drives with their motors fed from a common transformer. To calculate harmonics of an individual drive, highlight it and press the Network Check button. To calculate the combined harmonics of all drives highlight the transformer and click the Network Check button.

For an individual drive the network check dialog window shown in Figure 7.2 opens. The network and transformer data is inherited from the selected transformer and the cable data has default parameter values. As explained earlier P_{dc} [kW] is the DC power the software has calculated based on the mechanical load.

The Supply data is inherited from the selected drive, which in this example for a 6-pulse diode bridge fed drive contains the inductance L_{ac} of the built-in AC-choke and the capacitance C_{dc} of the DC intermediate circuit smoothing capacitor. The higher the load the higher the harmonics in amperes, but the harmonic percentage values tend to become higher at partial loads.

All white fields are editable and calculations can be performed with preferred inputs.

Network and transformer data			
Primary voltage [V]	21000	Secondary voltage [V]	690
Frequency [Hz]	50		
Network Sk [MVA]	200	<input type="checkbox"/> unknown	
Transformer Sn [kVA]	1800		
Transformer Pk [kW]	16		
Transformer Zk [%]	6		
Supply cable type	<input checked="" type="radio"/> Cable <input type="radio"/> Busbar		
Cable quantity	1	Cable impedance [uOhm/m]	70
Cable length [m]	3		

Supply unit data	
Lac [uH]	70
Cdc [mF]	7.9
Pdc [kW]	526.3

Result	
Cos φ1	0.97
Tot. power factor	0.91
Udc [V]	895.60

Figure 7.2 Input part of the network check dialog for a 6-pulse diode bridge fed drive.

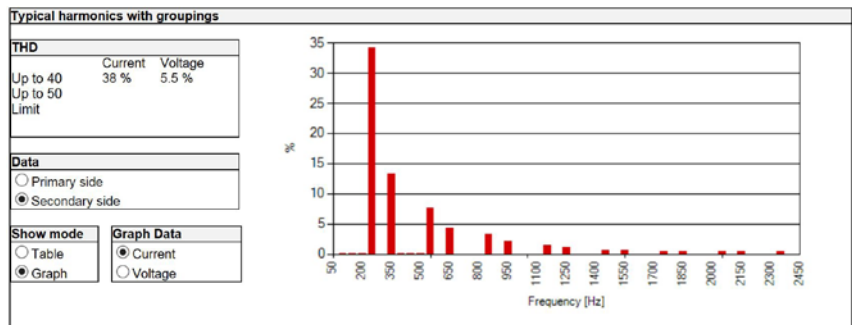

Figure 7.3 Example results for a 6-pulse diode bridge fed drive.

In Figure 7.4 the network check window for the low harmonic drive in our example is shown. With an active supply unit the harmonic currents are small and relatively independent on active P_{dc} power. Again the harmonic percentage values tend to become higher at partial loads.

Network and transformer data			
Primary voltage [V]	21000	Secondary voltage [V]	690
Frequency [Hz]	50		
Network Sk [MVA]	200	<input type="checkbox"/> unknown	
Transformer Sn [kVA]	1600		
Transformer Pk [kW]	16		
Transformer Zk [%]	6		
Supply cable type	<input checked="" type="radio"/> Cable <input type="radio"/> Busbar		
Cable quantity	1	Cable impedance [uOhm/m]	70
Cable length [m]	3		

Supply unit data	
Pdc [kW]	537.9

Result	
Cos φ1	1.00
Tot. power factor	1.00
Udc [V]	992.00

Figure 7.4 Input part of the network check dialog for an active supply unit.

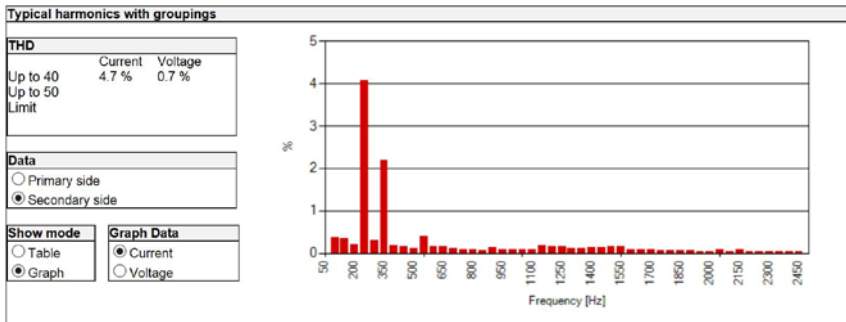

Figure 7.5 Example results from an active supply unit drive.

The check window in figure 7.6 is shown in our example for the combined drive harmonics. In this example the software will sum up harmonics of 6-pulse diode bridge fed drives with 59.7 kW + 526.3 kW DC power loads and active supply unit drives having 537.9 kW DC power loads. Please notice that including active supply unit drives in the network decreases the combined THD.

Network and transformer data			
Primary voltage [V]	21000	Secondary voltage [V]	690
Frequency [Hz]	50		
Network Sk [MVA]	200	<input type="checkbox"/> unknown	
Transformer Sn [kVA]	1600		
Transformer Pk [kW]	16		
Transformer Zk [%]	6		
Supply cable type	<input checked="" type="radio"/> Cable <input type="radio"/> Busbar		
Cable quantity	3	Cable impedance [uOhm/m]	70
Cable length [m]	3		

Supply unit data			
Filter type	DC filter	AC filter	ISU filter
Pdc[kW]	59.7	526.3	537.9
L[uH]	810	70	
Cdc[mF]	1	7.9	

Result	
Cos e1	0.99
Tot. power factor	0.98
Udc [V]	992.00

Figure 7.6 The input part of the network check dialog for combined harmonics containing 6-pulse diode bridge fed drives and active supply unit drive, which has a so called ISU filter. ISU stands for IGBT Supply Unit.

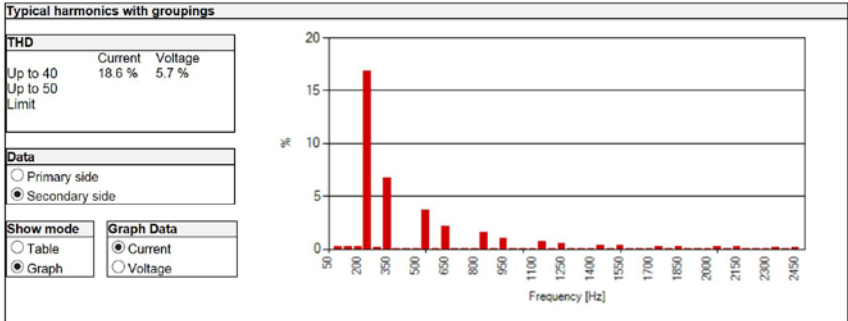

Figure 7.7 An example of combined results.

Definitions

- S : Apparent power
- P : Active power
- Q : Reactive power
- R_{sc} : The short circuit ratio is defined as the short circuit power of the supply at PCC to the nominal apparent power of the equipment under consideration. $R_{sc} = S_s / S_n$.
- ω_1 : Angular frequency of fundamental component $\omega_1 = 2\pi f_1$, where f_1 is fundamental frequency (eg. 50 Hz or 60 Hz).
- n : Integer $n = 2, 3, \dots \infty$. Harmonic frequencies are defined as $\omega_n = n\omega_1$.
- I_n : RMS-value of the n :th harmonic component of line current.
- Z_n : Impedance at frequency $n\omega_1$.
- $\%U_n$: Harmonic voltage component as a percentage of fundamental (line) voltage.
- THD: Total Harmonic Distortion in the input current is defined as:

$$THD = \frac{\sqrt{\sum_{n=2}^{\infty} I_n^2}}{I_1}$$

where I_1 is the rms value of the fundamental frequency current. The THD in voltage may be calculated in a similar way. Here is an example for the 25 lowest harmonic components with the theoretical values:

$$THD = \frac{\sqrt{20^2 + 14.3^2 + 9.1^2 + 7.7^2 + 5.9^2 + 5.3^2 + 4.4^2 + 4^2}}{100}$$

$$THD = 29\%$$

PWHD: Partial weighted harmonic distortion is defined as:

$$PWHD = \sqrt{\sum_{n=14}^{40} n \left(\frac{I_n}{I_1} \right)^2}$$

PCC: The Point of Common Coupling is defined in this text as a point of utility supply which may be common to the equipment in question and other equipment. There are several definitions of PCC in different standards and even more interpretations of these definitions in the literature. The definition chosen here is seen as technically most sound.

PF: Power Factor defined as $PF = P/S$ (power / volt-ampere) = I_1 / I_s * DPF (With sinusoidal current PF equals to DPF).

DPF: Displacement Power Factor defined as $\cos\phi_1$, where ϕ_1 is the phase angle between the fundamental frequency current drawn by the equipment and the supply voltage fundamental frequency component.

RRU: Regenerative rectifier unit. An IGBT bridge that is operated in diode mode.

PDS: Power drive system. Combination of an inverter and a motor.

ISU: IGBT supply unit. Same as an active supply unit. Often also called the active front end and active infeed converter.

—
For more information, please contact
your local ABB representative or visit

www.abb.com/drives
www.abb.com/drivespartners

