

ABL90 FLEX operator's manual

ABL90 FLEX
operator's
manual

Operator's manual

Note to the operators of the ABL90 FLEX analyzer

Introduction This note outlines the improvements in software version 2.8.

Instructions to operators Put the Note to the operators in the binder of your manual and replace the corresponding old front and date of issue pages with the new pages in this update kit.

Brief overview of the Improvements

Improvements/Description			
Storage temperature for the sensor cassette	In the manual, the storage temperature of the sensor cassette is incorrectly stated to be 2-10 °C. The correct storage temperature of the sensor cassette is 2-8 °C.		
Vocal reminder to close the inlet	If the inlet is not closed, a voice message reminds you to do so.		
Video instructions of the measuring workflow	Video instructions have replaced most of the animations that were previously shown on the screen.		
More maintenance instructions included in the guided troubleshooting of the analyzer	Videos and text instructions have been added to the tasks to maintain and replace the Inlet, the Inlet Probe, the Inlet Gasket Holder and the Inlet Connector Gasket. When the Troubleshooting needed screen is shown, follow the instructions on the screen. The analyzer will then guide you through the procedures.		
How values that lie outside the reportable ranges are shown	In software versions up to and including 2.7, results that are outside the reportable ranges of the analyzer are shown without values on the Patient result screen and in printed results and no values are transmitted to connected LIS/HIS systems. This is still the default setting, but in SW version 2.8 it is possible to get the exceeded range limit of the reportable range shown in the value field. If e.g. the result is below the value, which is the lower limit of the reportable range, the result is shown as "<range".		
Patents	Radiometer products may be covered by one or more patents and patent applications. See http://www.radiometer.com/en/legal/patents .		
The reportable ranges for pO_2 and cNa^+ are now:			
Parameter	Unit	Range of indication	Reportable range (default)
pO_2	mmHg; Torr	0-800	10-550
	kPa	0-107	1.33-73.3
cNa^+	mmol/L; meq/L	7-350	95-190

The contents of this document will be added to the manual the next time the manual is updated.



Radiometer Medical ApS
 Åkandevvej 21
 2700 Brønshøj
 Denmark
www.radiometer.com

Operator's manual

Note to the users of the ABL90 FLEX analyzer

Introduction

This note outlines the improvements in software version 2.7.

- Videos and text instructions will guide you through various troubleshooting procedures to solve fluid transport problems.
- Under **Consumables** in the **Analyzer status** screen, replacement data about the Inlet Gasket Holder is shown instead of replacement data about the printer paper.

Instructions to user

Put this document in the binder of your manual.

The Troubleshooting needed screen

When the **Troubleshooting needed** screen appears, follow the instructions on the screen.

The analyzer guides you through each troubleshooting procedure. After each procedure the analyzer checks to see if the problem has been solved.

If the troubleshooting procedures do not solve the problem, the analyzer enters the **Operator-intervention required** screen.

To replace the Inlet Gasket Holder

1. Log on.
2. Tap **Menu > Analyzer status > Consumables > Replace > Replace the inlet gasket**.
3. Follow the instructions on the screen.

To see details about the Inlet Gasket Holder

1. Log on.
2. Tap **Menu > Analyzer Status > Consumables > Status > Gasket status**.

Standardizing the terminology of the software

These terms have been changed in the software:

Term	Changed to...
User	Operator
Replacements	Consumables
Replace solutions	Replace Solution pack
Instrument	Analyzer

The terms will be added to the manual the next time the manual is updated.

The contents of this document will be added to the manual the next time the manual is updated.

Operator's manual

Note to the users of the ABL90 FLEX analyzer

Introduction From software version 2.6.2132.11, a clot detection and removal process has been added.

Instructions to user Please put this document in the binder of your manual.

Clot detection and removal process For preventive action, the analyzer checks for clots during blood sample measurements and, once a day, also during the system check started at midnight.

If there is a sign of a clot in the analyzer during checks, the following occurs:

1.	There is a clot-related error message in the Activity log.
2.	The analyzer aborts the current action.
3.	The analyzer goes into the Cleaning mode.
4.	The analyzer starts the clot removal process.
5.	The analyzer starts a system check if the clot was found during the system check at midnight.
6.	<ul style="list-style-type: none"> • If the analyzer has removed the clot, the analyzer goes into the Ready mode. • If the clot is still there, the analyzer goes into the Intervention Required mode. Follow the on-screen instructions to remedy the error or see the <i>ABL90 FLEX operator's manual</i> for further information about the Intervention Required mode.

Technical documentation Data in this document will be added to the manual the next time the manual is updated.

Operator's manual

Note to the users of the ABL90 FLEX analyzer

Introduction This note to users describes the battery feature of the ABL90 FLEX analyzer.

Instructions to user Please place this document in the binder of your manual.

Brief overview





1 Battery pack



The battery pack enables, for a limited period of time, the performance of measurements and the storage of data without the analyzer being connected to mains or during power failure.

2 Battery LED

3 The battery level indicator on the screen

The battery level indicator on the screen is only visible if the battery is installed. The battery charge level is indicated by a percentage.

Battery LED	Battery level indicator	Indication
Constantly green		The analyzer is connected to mains. The battery is fully charged (100 %).
Blinking green		The analyzer is connected to mains. The battery is charging.

Blinking yellow steadily		<p>The analyzer is running on battery.</p> <p>If battery charge level: $\leq 25\%$.</p> <ul style="list-style-type: none"> - A system message is shown in the Activity log. - The battery charge level in the icon of the battery level indicator is yellow. <p>Corrective action:</p> <ul style="list-style-type: none"> - Connect the analyzer to mains.
		
Blinking intense yellow		<p>The analyzer is running on battery.</p> <p>If battery charge level: $\leq 13\%$.</p> <ul style="list-style-type: none"> - A message is shown on the screen. - The battery charge level in the icon of the battery level indicator is red. <p>Corrective actions:</p> <ul style="list-style-type: none"> - Connect the analyzer to mains. - Close the dialogue box.

If battery charge level: $\leq 10\%$, the analyzer automatically performs a controlled shutdown.

Corrective actions:

- Connect the analyzer to mains.
- Turn on the analyzer.

Battery specifications:	
Battery operation	Approximately 1 hour of battery power when analyzer is in Ready mode, or approximately 25 samples.
Battery pack charge time	Approximately 90 minutes to fully charge a depleted battery pack.

Technical documentation

Data in this document will be added to the manual next time it is updated.



Radiometer Medical ApS
 Åkandevej 21
 2700 Brønshøj
 Denmark
www.radiometer.com

ABL90 FLEX

Operator's manual

From software version 2.8xx



RADIOMETER 

Table of contents

1. Introduction

2. What is what

3. Analyzer status

4. Sample measurements

5. Quality management

6. Calibration

7. Replacements

8. Disk functions

9. Data management

10. Analyzer shutdown

11. Troubleshooting

12. Sampling

13. Specifications

14. Ordering information

Index

Date of issue

System performance

The procedures described in this manual must be observed in order to ensure proper system performance, and to avoid hazards.

Radiometer cannot provide or verify system performance characteristics if the system is not installed, used and maintained in accordance with Radiometer procedures or if accessories not meeting the specifications provided by Radiometer are used.

Radiometer warrants that the data media on which the software included in the system is furnished is free from defects in material and workmanship under normal use for three (3) months from the date of delivery as evidenced by a copy of invoice or receipt.

Third-party software and trademarks

The ABL90 FLEX analyzer comprises the Microsoft® Windows® XP Embedded and Sybase® SQL Anywhere® software.

By using the system, you accept the terms of the Software License Agreement(s) of the provider(s) of the above software as shown in the End User License Agreement(s) included in this manual. If you cannot accept the terms of the Software License Agreement(s), you should not use the system, but immediately contact your provider for a return of the system and a refund of the purchase price.

Microsoft® and Windows® are trademarks of Microsoft Corporation. Sybase® SQL Anywhere® is a trademark of Sybase Incorporated.

Warranties and disclaimer

Radiometer makes no warranties, express or implied, other than expressly stated.

Any warranties expressly stated in this document are conditional upon the system being installed, used and maintained in accordance with Radiometer procedures, including that only accessories meeting the specifications provided by Radiometer are used.

Radiometer disclaims any liability for system performance if the system is not installed, used and maintained in accordance with Radiometer procedures or if accessories not meeting the specifications provided by Radiometer are used.

Further, Radiometer disclaims any liability for loss of data and direct, consequential or other damages, including loss of profit or loss of business, whether such claim for damages is based upon contract, negligence or tort (including strict liability), and even if Radiometer has knowledge of the possibility of the potential damage or loss.

Confidentiality

The contents of this document shall not be reproduced or communicated to any third party without the prior written consent of Radiometer.

Changes

This document is subject to change without notice and you are urged to contact Radiometer to verify whether the document has been changed.

While every effort is made to ensure the correctness of the information provided in this document as changed from time to time, Radiometer disclaims any liability for errors and omissions.

End-user license agreement for the ABL90 FLEX analyzer

You have acquired a device ("DEVICE") THAT INCLUDES SOFTWARE LICENSED BY Radiometer Medical ApS from Microsoft Licensing Inc. or its affiliates ("MS"). Those installed software products of MS origin, as well as associated media, printed materials, and "online" or electronic documentation ("SOFTWARE") are protected by international intellectual property laws and treaties. The SOFTWARE is licensed, not sold. All rights reserved.

IF YOU DO NOT AGREE TO THIS END USER LICENSE AGREEMENT ("EULA"), DO NOT USE THE DEVICE OR COPY THE SOFTWARE. INSTEAD, PROMPTLY CONTACT THE SUPPLIER OF THE INSTRUMENT FOR INSTRUCTIONS ON RETURN OF THE UNUSED DEVICE(S) FOR A REFUND. **ANY USE OF THE SOFTWARE, INCLUDING BUT NOT LIMITED TO USE ON THE DEVICE WILL CONSTITUTE YOUR AGREEMENT TO THIS EULA (OR RATIFICATION OF ANY PREVIOUS CONSENT).**

GRANT OF SOFTWARE LICENSE. This EULA grants you the following license:

- You may use the SOFTWARE only on the DEVICE.
- **NOT FAULT TOLERANT.** THE SOFTWARE IS NOT FAULT TOLERANT. RADIOMETER MEDICAL ApS HAS INDEPENDENTLY DETERMINED HOW TO USE THE SOFTWARE IN THE DEVICE, AND MS HAS RELIED UPON RADIOMETER MEDICAL ApS TO CONDUCT SUFFICIENT TESTING TO DETERMINE THAT THE SOFTWARE IS SUITABLE FOR SUCH USE.
- NO WARRANTIES FOR THE SOFTWARE. **THE SOFTWARE is provided "AS IS" and with all faults. THE ENTIRE RISK AS TO SATISFACTORY QUALITY, PERFORMANCE, ACCURACY, AND EFFORT (INCLUDING LACK OF NEGLIGENCE) IS WITH YOU. ALSO, THERE IS NO WARRANTY AGAINST INTERFERENCE WITH YOUR ENJOYMENT OF THE SOFTWARE OR AGAINST INFRINGEMENT.** IF YOU HAVE RECEIVED ANY WARRANTIES REGARDING THE DEVICE OR THE SOFTWARE, THOSE WARRANTIES DO NOT ORIGINATE FROM, AND ARE NOT BINDING ON, MS.
- **Note on Java Support.** The SOFTWARE may contain support for programs written in Java. Java technology is not fault tolerant and is not designed, manufactured, or intended for use or resale as online control equipment in hazardous environments requiring fail-safe performance, such as in the operation of nuclear facilities, aircraft, navigation or communication systems, air traffic control, direct life support machines, or weapons systems, in which the failure of Java could lead directly to death, personal injury, or severe physical or environmental damage. Sun Microsystems, Inc. has contractually obligated MS to make this disclaimer.
- No Liability for Certain Damages. **EXCEPT AS PROHIBITED BY LAW, MS SHALL HAVE NO LIABILITY FOR ANY INDIRECT, SPECIAL, CONSEQUENTIAL OR INCIDENTAL DAMAGES ARISING FROM OR IN CONNECTION WITH THE USE OR PERFORMANCE OF THE SOFTWARE. THIS LIMITATION SHALL APPLY EVEN IF ANY REMEDY FAILS OF ITS ESSENTIAL PURPOSE. IN NO EVENT SHALL MS BE LIABLE FOR ANY AMOUNT IN EXCESS OF U.S. TWO HUNDRED AND FIFTY DOLLARS (USD 250.00).**
- **Limitations on Reverse Engineering, Decompilation and Disassembly.** You may not reverse engineer, decompile, or disassemble the SOFTWARE, except and only to the extent that such activity is expressly permitted by applicable law notwithstanding this limitation.
- **SOFTWARE TRANSFER ALLOWED BUT WITH RESTRICTIONS.** You may permanently transfer rights under this EULA only as a part of a permanent sale or transfer of the DEVICE, and only if the recipient agrees to this EULA. If the SOFTWARE is an upgrade, any transfer must also include all prior versions of the SOFTWARE.
- **EXPORT RESTRICTIONS.** You acknowledge that SOFTWARE is of U.S.-origin. You agree to comply with all applicable international and national laws that apply to the SOFTWARE, including the U.S. Export Administration Regulations, as well as end-user, end-use and country destination restrictions issued by U.S. and other governments. For additional information on exporting the SOFTWARE, see <http://www.microsoft.com/exporting/>.

Contents

1. Introduction	1-1
ABL90 FLEX analyzer documentation.....	1-2
Names and intended use.....	1-3
Names.....	1-3
Intended use.....	1-3
Sensor cassette variants.....	1-4
Solution pack.....	1-4
Requirements to the operator.....	1-4
Measurements on animal blood.....	1-4
Limitations of use and known interfering substances.....	1-5
Limitations of use.....	1-5
<i>F</i> Hb <i>F</i> measurement.....	1-5
Known interfering substances.....	1-5
Symbols used on the analyzer and accessories.....	1-6
Symbols used in this manual.....	1-8
Definitions.....	1-8
2. What is what	2-1
Hardware.....	2-2
Front.....	2-2
Top.....	2-3
Rear.....	2-4
Detachable power supply cord.....	2-5
Inlet module.....	2-6
Built-in sample mixer.....	2-7
Barcode reader.....	2-8
Consumables.....	2-9
Sensor cassette pack with sensor cassette.....	2-9
Solution pack.....	2-10
Software.....	2-11
Screen elements.....	2-11
Main screen.....	2-11
Top section.....	2-11
Center section.....	2-12
Bottom section.....	2-15
Initial logon.....	2-17
Access rights.....	2-17
Entering standard password.....	2-17
Menu structure.....	2-18
3. Analyzer status	3-1
Analyzer status at a glance.....	3-2
Analyzer status elements.....	3-3
Calibration status.....	3-4
Quality control (QC).....	3-5
Replacements.....	3-6

Other activities	3-7
System messages	3-7
Battery level indicator.....	3-7
4. Sample measurement	4-1
General information.....	4-2
General information.....	4-2
Available modes and parameters	4-2
Immediately before analysis	4-3
Introducing a blood sample with a standard syringe	4-4
Introducing a blood sample with a <i>safe</i> PICO sampler with barcode	4-5
Introducing a blood sample with a <i>safe</i> PICO sampler with barcode and sample pre-registration.....	4-6
Introducing a blood sample with a capillary tube	4-8
Introducing a blood sample with a test tube.....	4-9
Entering patient identification	4-10
Entering information with barcode reader	4-10
Entering information manually	4-10
Patient lookup	4-11
Selecting a report layout	4-12
De-selecting parameters after a measurement	4-12
Determining <i>F</i> Shunt and $ctO_2(a-\bar{v})$	4-13
Patient result.....	4-14
Program	4-14
Parameter status	4-14
Recalling patient ID.....	4-15
Patient result approval.....	4-16
Acid-Base chart	4-17
Patient result audit trail	4-18
Patient result messages	4-19
Screen messages	4-19
5. Quality management	5-1
Automatic quality management system	5-2
General information.....	5-3
Purpose	5-3
Glossary list	5-3
Built-in quality control	5-4
Schedule	5-4
Acceptable ranges.....	5-4
Built-in QC measurement	5-4
View built-in QC results.....	5-4
Parameter status	5-5
Unscheduled built-in QC measurement	5-5
Reference	5-5
System checks	5-6
Description.....	5-6
Analysis check.....	5-7
Description.....	5-7
Manual quality control	5-8
Manual quality control	5-8
Required materials	5-8
Before measurement on a control solution	5-8

Introducing a QC solution.....	5-9
Entering information with barcode reader	5-9
Entering information manually	5-10
View manual QC results	5-10
Parameter status	5-10
Unknown solutions	5-11
Temperature corrections	5-11
Reference	5-11
Recalling quality control identification	5-11
Additional quality control.....	5-12
6. Calibration	6-1
General information.....	6-2
Purpose	6-2
Calibration programs	6-2
Calling an unscheduled calibration	6-2
Calibrations related to startups	6-2
Pending calibrations	6-3
Expired calibrations	6-3
tHb calibration.....	6-4
Purpose	6-4
Preparation	6-4
tHb calibration procedure	6-4
Calibration result	6-5
Viewing a calibration result.....	6-5
Calibration result	6-5
tHb calibration result	6-6
Calibration result messages	6-7
Calibration verification	6-8
Purpose	6-8
Preparatory steps.....	6-8
Verification procedure	6-10
7. Replacements.....	7-1
Screens during replacements	7-2
Replacements.....	7-3
Viewing replacement status	7-3
Solution pack	7-4
Replacing solution pack.....	7-4
Manual release of the solution pack	7-5
Sensor cassette	7-5
Replacing sensor cassette.....	7-5
Startup after sensor cassette replacement	7-8
Printer paper	7-9
Replacing printer paper	7-9
Inlet.....	7-10
Replacing the inlet	7-10
Replacing inlet probe/gasket.....	7-12
Replacing the inlet connector gasket	7-13
Cleaning the analyzer	7-16
Cleaning the inlet.....	7-16
Cleaning the sensor cassette seat.....	7-16
Cleaning the analyzer exterior	7-16
Cleaning the analyzer screen	7-17
Disinfection of outer surfaces.....	7-17

8. Disk functions	8-1
General information.....	8-2
Disk functions programs.....	8-2
9. Data management.....	9-1
General information.....	9-2
Access to data logs.....	9-2
Archived data logs.....	9-2
Patient results log	9-3
Purpose	9-3
Functions.....	9-4
Filter function.....	9-4
Trend function	9-5
Patient profiles log	9-6
About a patient profile	9-6
Patient profiles log	9-6
Editing a patient profile.....	9-7
Adding a new patient profile	9-7
Deleting a patient profile.....	9-7
Finding a patient profile	9-8
Quality control log.....	9-9
Purpose	9-9
Quality control plot.....	9-10
Filter/trend function	9-11
Viewing quality control statistics.....	9-12
Printing QC statistics	9-14
Calibration log.....	9-15
Purpose	9-15
Filter function.....	9-16
Trend function	9-17
Activity log.....	9-18
Purpose	9-18
Adding a message to the log.....	9-18
Filter function.....	9-19
Replacement log	9-20
Replacement log	9-20
Archived data logs.....	9-21
Purpose	9-21
Selecting an archive saved on the analyzer	9-21
Moving an archive to another media or from another media to the analyzer	9-22
Converting an archive into .csv format	9-22
RADIANCE browser (optional)	9-23
Purpose	9-23
Accessing RADIANCE	9-23
10. Analyzer shutdown	10-1
General information.....	10-2
Shutdown programs	10-2
Temporary shutdown.....	10-3
Purpose	10-3
Switching off the analyzer for a short time.....	10-3
Restarting the analyzer after temporary shutdown	10-4
Warm start	10-4
Long-term shutdown	10-5
Purpose	10-5

Storing an analyzer	10-6
Transporting the analyzer.....	10-6
Restarting the analyzer	10-6
11. Troubleshooting	11-1
General information.....	11-2
General information.....	11-2
Analyzer action in case of error	11-2
Operator actions in case of error	11-2
Logging system messages	11-3
User-Intervention-required causes.....	11-4
Intervention required.....	11-4
12. Sampling	12-1
Sampling devices and procedures.....	12-2
Introduction	12-2
Recommended arterial blood samplers	12-2
Recommended capillary blood samplers.....	12-2
Procedures.....	12-3
Special considerations for capillary specimens	12-3
Storage time and temperature recommendations.....	12-5
Radiometer storage recommenda-tions for whole-blood samples.....	12-5
Special considerations	12-5
Causes of error in the preanalytical phase	12-6
Introduction	12-6
Possible causes of error	12-6
References.....	12-9
List of references	12-9
Recommended literature	12-10
13. Specifications	13-1
Measured parameters	13-2
Blood	13-2
Barometer	13-3
Input parameters.....	13-4
List of parameters.....	13-4
Derived parameters.....	13-4
Sample handling.....	13-5
Analyzer requirements.....	13-6
Analyzer requirements.....	13-6
Analyzer specifications.....	13-7
Specifications	13-7
Approvals and patents	13-8
Approvals	13-8
CE-mark	13-8
EMC emission	13-8
EMC immunity	13-8
Patents.....	13-8
14. Ordering information	14-1
Analyzer accessories.....	14-2
Analyzer	14-2
Sensor cassette	14-2
Solution pack	14-2
Power cords	14-3
Other accessories.....	14-3
Documentation	14-3
Quality control.....	14-3

- Accessories 14-3
 - QUALICHECK5+ solution 14-4
 - Range+ QUALICHECK solution 14-4
 - Metabolite+ QUALICHECK solution 14-4
 - Documentation 14-4
- Sampling devices 14-4
 - Arterial blood gas samplers 14-4
 - Capillary samplers, glass 14-5
 - Capillary samplers, plastic 14-5
 - safePICO samplers 14-5

Index

Date of issue

1. Introduction

ABL90 FLEX analyzer documentation.....	1-2
Names and intended use	1-3
Limitations of use and known interfering substances	1-5
Symbols used on the analyzer and accessories	1-6
Symbols used in this manual	1-8

NOTICE: The screen shots shown in this manual do not necessarily reflect the screens you will see on your analyzer. The screen shots are based on a full parameter panel, and some of the screen shots may be from an analyzer setup different from yours.

ABL90 FLEX analyzer documentation

The documentation that accompanies the ABL90 FLEX analyzer includes practical and theoretical information regarding the function and use of the analyzer.

The table below describes documentation available for this analyzer.

Documentation	Description
Operator's manual	<ul style="list-style-type: none">• Contains the instructions of use for point-of-care information, i.e. all the information required for everyday operation of the analyzer• Describes the functions of the analyzer• Explains error messages and gives troubleshooting procedures
Reference manual	<ul style="list-style-type: none">• Provides detailed information about the operating principles of the analyzer and contains reference material not required for the everyday operation of the analyzer• Describes setup and the disk functions setup programs• Describes the measuring and calibrating principles• Lists all the parameters• Provides the equations from which the derived parameters are calculated• Provides information about how the performance of the analyzer is tested

Names and intended use

Names	Proprietary name:	ABL90 FLEX blood gas, oximetry, electrolyte and metabolite analyzer.
	Common name:	Blood gas, oximetry, electrolyte and metabolite measuring system.

Intended use The ABL90 FLEX analyzer is a portable, automated analyzer that measures pH, blood gases, electrolytes, glucose, lactate, bilirubin and oximetry in whole blood.

The ABL90 FLEX analyzer is intended for use by trained technologists, nurses, physicians and therapists.

It is intended for use in a laboratory environment, near patient or point-of-care setting.

The ABL90 FLEX analyzer can be connected to the RADIANCE system. The Radiance system enables communication between the RADIANCE server and the ABL90 FLEX analyzer to allow remote data entry and analyzer access.

These tests are only performed under a physician's order.

In the table below the measured parameters are shown:

Parameter group	Parameter
pH/blood gas:	pH (acidity)
	$p\text{CO}_2$ (carbon dioxide tension)
	$p\text{O}_2$ (oxygen tension)
Oximetry:	ctHb (total hemoglobin concentration)
	sO ₂ (oxygen saturation)
	FO ₂ Hb (fraction of oxyhemoglobin in total hemoglobin)
	FCO ₂ Hb (fraction of carboxyhemoglobin in total hemoglobin)
	FHHb (fraction of deoxyhemoglobin in total hemoglobin)
	FMetHb (fraction of methemoglobin in total hemoglobin)
	FHbF (fraction of fetal hemoglobin)
	ctBil (concentration of total bilirubin in plasma)
Electrolytes:	cK ⁺ (potassium ion concentration)
	cNa ⁺ (sodium ion concentration)
	cCa ²⁺ (calcium ion concentration)
	cCl ⁻ (chloride ion concentration)
Metabolites:	cGlu (D-glucose concentration)
	cLac (L(+)-lactate concentration)

For details on derived parameters, see section *Derived parameters* in chapter 8: *Parameters* in the ABL90 FLEX reference manual.

Sensor cassette variants

The ABL90 FLEX analyzer comes with different parameter panels, depending on the sensor cassette installed.

The sensor cassettes are available in the following parameter configurations:

Configuration	Parameters
BG/OXI + QC	pH, $p\text{CO}_2$, $p\text{O}_2$, ctBil, ctHb, $s\text{O}_2$, FO_2Hb , FMetHb , FCOHb , FHHb , FHbF
BG/LYT/OXI + QC	pH, $p\text{CO}_2$, $p\text{O}_2$, $c\text{Ca}^{2+}$, $c\text{Cl}^-$, $c\text{K}^+$, $c\text{Na}^+$, ctBil, ctHb, $s\text{O}_2$, FO_2Hb , FMetHb , FCOHb , FHHb , FHbF
BG/LYT/MET/OXI + QC	pH, $p\text{CO}_2$, $p\text{O}_2$, $c\text{Ca}^{2+}$, $c\text{Cl}^-$, $c\text{K}^+$, $c\text{Na}^+$, $c\text{Glu}$, $c\text{Lac}$, ctBil, ctHb, $s\text{O}_2$, FO_2Hb , FMetHb , FCOHb , FHHb , FHbF

For details on the different sensor cassette variants, see section *Analyzer accessories* in chapter 14: *Ordering information*.

Solution pack

All solutions necessary for the daily operation of the ABL90 FLEX analyzer are contained in the solution pack, e.g. calibration, rinse and quality control solutions. Apart from solution consumption in connection with a test, solution is consumed during a number of automatic activities (e.g. calibration and quality control) that runs at fixed intervals.

The solution pack contains solutions for 600 activities (tests and automatic activities) and has a max. lifetime of 30 days. The analyzer performs 12 auto activities per day. This means that the higher the daily sample volume is, the more tests can be performed per solution pack – and the shorter the lifetime.

Requirements to the operator

The analyzer should be used by personnel trained in using *in vitro* diagnostic medical devices.

NOTICE: Documentation must be consulted. Failure to follow the instructions in the manual may result in damage to the analyzer. Radiometer will not accept warranty claims or product liability claims if the recommended procedures are not followed.

Measurements on animal blood

Animal blood has not been tested on the ABL90 FLEX analyzer. Animal blood differs from human blood, and variations in the composition of blood from different animal species may also exist.

Limitations of use and known interfering substances

Limitations of use

The following limitations should be taken into consideration:



WARNING – Clinical decisions

The validity of the test results from this analyzer must be carefully examined by a clinician and related to the patient's clinical condition, before any clinical decisions are made on the basis of the test results.



CAUTION – Fulfillment of user-specific analytical needs

Review the analyzer's performance data to ensure that the performance fulfills the user-specific analytical needs.

FHbF measurement















The uncertainty in FHbF measurements exceeds the level required to measure normal HbF levels in the adult range (FHbF reference range is 0-1 %). FHbF is disabled as default.



The ABL90 FLEX analyzer measures only HbA and HbF hemoglobins.

Known interfering substances

For information on the interfering substances, see section *Interference tests* in chapter 7: *Performance characteristics* in the ABL90 FLEX reference manual.



Symbols used on the analyzer and accessories

Symbol	Explanation
	Product code no.
	Lot no.
	UL certification
	Biological risk
	Caution
	Consult accompanying documents
	<p>Waste electrical and electronic equipment</p> <ul style="list-style-type: none"> • Radiometer Medical ApS and its distributors within the European Union and associated states have taken the necessary steps to comply with the directive, 2002/96/EC on waste electrical end electronic equipment (WEEE) • The instrument, when reaching its end of life, must be collected and recycled separately from other waste according to national requirements. Please contact your local Radiometer distributor for instructions. <p>Environmental implications: WEEE contains materials that are potentially hazardous to the environment and to human health.</p>
	Network
	USB
	Keyboard
	Mouse
	VGA (monitor)
IOIOI	COM port (scanner/barcode reader)
	Mark of compliance with applicable EU Directives
	<i>In vitro</i> diagnostic use
	Manufactured by

Symbol	Explanation
 A black syringe with a red plunger and needle.	Syringe position of inlet
 A red horizontal bar with a black line through its center.	Capillary position of inlet
 A black dot with a red elliptical ring around it.	Sample mixer

Symbols used in this manual

Definitions The manual contains operational warnings and cautions, which are important and should be read carefully before performing the related procedures. The manual also contains important information and a number of helpful hints, signaled by the word **NOTICE**.

Symbol	Explanation
	<p>WARNING</p> <p>A warning alerts the reader about a situation, which, if not avoided, could result in death or serious injury. It may also describe potential serious adverse reactions and safety hazards. The designation of a hazard alert as a "warning" is reserved for the most significant problems. The term WARNING is generally used as signal word for this type of hazard alert.</p>
	<p>CAUTION</p> <p>The term precaution is used for the statement of a hazard alert that warns the reader of a potentially hazardous situation which, if not avoided, may result in minor or moderate injury to the user or the patient or damage to the equipment or other property. It may also be used to alert against unsafe practices. This includes the special care necessary for the safe and effective use of the device and the care necessary to avoid damage to a device that may occur as a result of use or misuse. The word CAUTION is generally used as signal word for a precaution statement.</p>
	<p>Manufactured by</p>

2. What is what

Hardware.....	2-2
Front.....	2-2
Top.....	2-3
Rear.....	2-4
Inlet module.....	2-6
Built-in sample mixer.....	2-7
Barcode reader.....	2-8
Consumables.....	2-9
Sensor cassette pack with sensor cassette.....	2-9
Solution pack.....	2-10
Software.....	2-11
Screen elements.....	2-11
Initial logon.....	2-17
Menu structure.....	2-18

Hardware

Front



- 1 **Adjustable color touch screen**
- 2 **Barcode reader**
- 3 **Built-in sample mixer**
- 4 Compartment with **sensor cassette**
- 5 **Inlet**
- 6 **Solution pack**
- 7 **Battery pack**

The battery pack enables, for a limited period of time, the performance of measurements and the storage of data without the analyzer being connected to mains or during power failure.

Top



- 1 **Handle**
- 2 **USB port**
- 3 **Thermal printer**

Rear

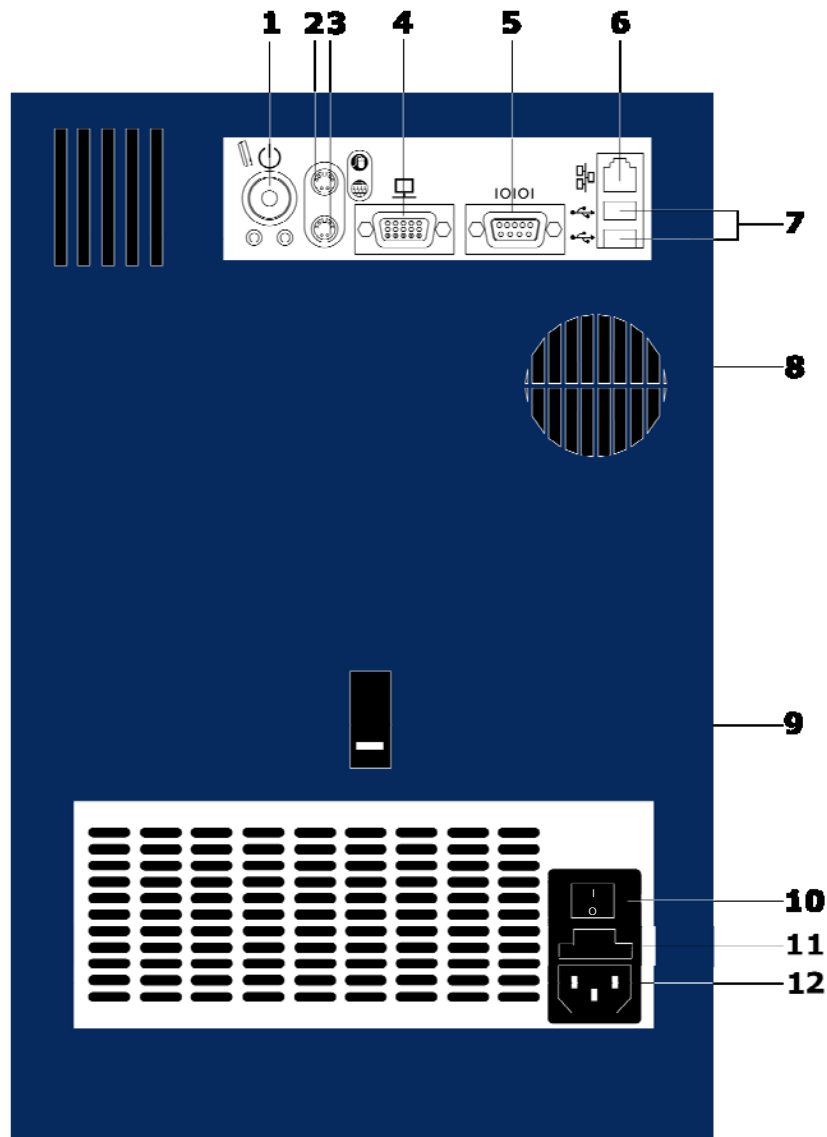

- 1 **Standby button**
- 2 **Mouse port**
- 3 **Keyboard port**
- 4 **External VGA monitor port** – for test purposes only.
- 5 **COM port**
- 6 **Ethernet port**
- 7 **USB ports**
- 8 **Ventilation**
- 9 **Latch for manual release of the solution pack**
- 10 **Mains power switch** – on some versions the mains power switch may show "ON" and "OFF" instead of "I" and "O".
- 11 **Fuses**
- 12 **Mains socket**

NOTICE: The analyzer should always be placed so that power can be easily switched off in emergency situations, and so that the ventilation is not covered.

Detachable power supply cord

<p>For US (125 VAC)</p>	<p>UL listed and KAM cord, min. type SV, 18 AWG, 3 conductors. Rated min. 60 °C.</p> <p>Provided with a molded grounding-type (NEMA 5-15P) attachment plug rated 125 VAC, min 2.5 A.</p> <p>Opposite end terminates in molded IEC 320-style connector rated 125 VAC, min. 2.5 A.</p>
<p>For Europe (265 VAC)</p>	<p>Cord type min. H05RR-F or min. H05VV-f or min. H05VVH2-F, rated min. 60 °C, 2 × 0.75 mm².</p> <p>Provided with a molded grounding-type attachment plug rated min. 250 VAC, min 2.5 A.</p> <p>Opposite end terminates in molded IEC 320-style connector rated min. 250 VAC, min. 2.5 A.</p>

- NOTICES:**
- External computing devices connected to the equipment must comply with the standard, UL 60950 for US and IEC 60950 for Europe. Failure to do so may result in equipment damage.
 - The mains supply cord and plug of the equipment must comply with any national regulation. Failure to do so may result in equipment damage.



CAUTION: Outside patient environment, place the ABL90 FLEX analyzer minimum 1.5 meters from patient bed.

Inlet module

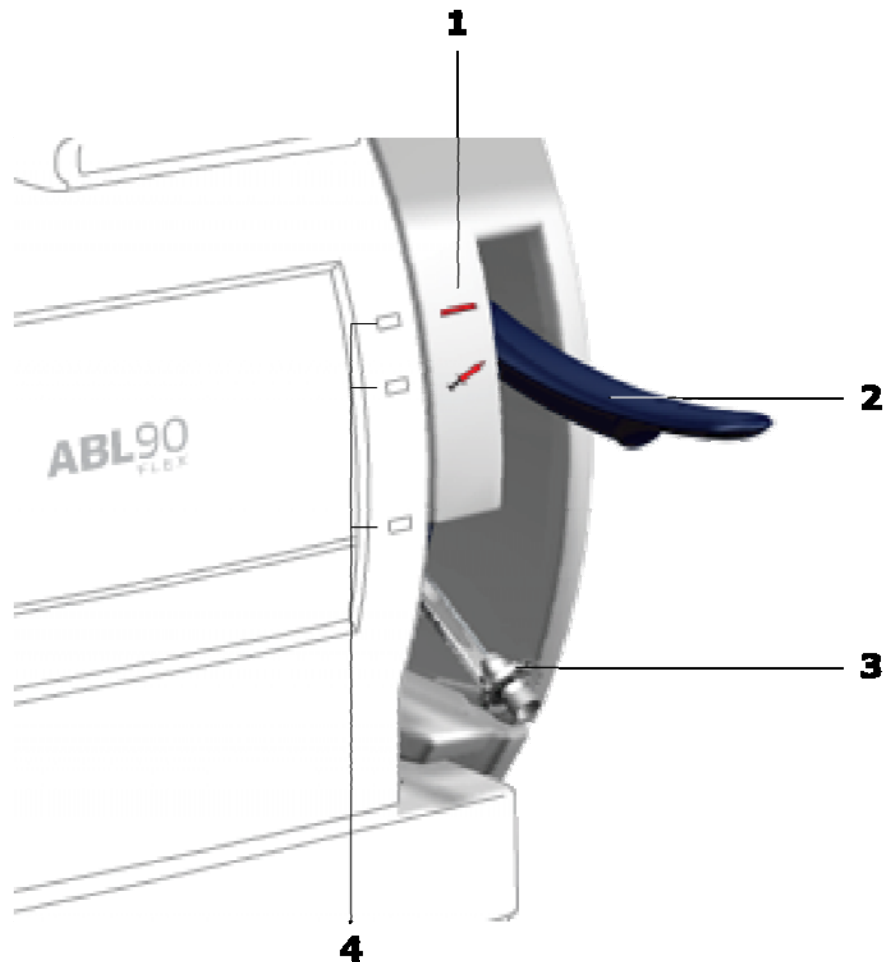

- 1 **Symbols** on the inlet cover that illustrate inlet handle positions.
- 2 **Handle** that is lifted into syringe or capillary position before measurement.
- 3 **Holder with inlet gasket for sample aspiration** (syringe, capillary, test tube or QUALICHECK adapter)
- 4 **Inlet handle position LEDs**

Built-in sample mixer



1

1

Built-in sample mixer

If a *safePICO* sampler is placed in the sample mixer, the ABL90 FLEX analyzer will automatically mix the blood sample.

Only *safePICO* samplers can be mixed in the sample mixer.

Barcode reader

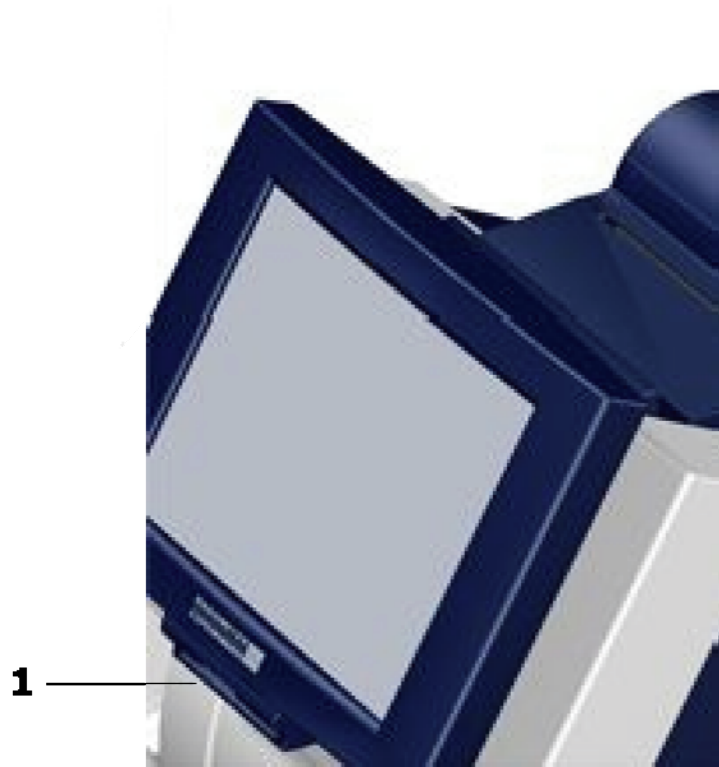

1

Barcode reader

Hold the barcode parallel to the barcode reader. A short beep indicates that the information has been read successfully.

Barcodes are found on the following ABL90 FLEX accessories:

Item	Barcode position
Sensor cassette	The label on the sensor cassette pack.
QC ampoules	The insert in the box with ampoules.
tHb calibration ampoules	The insert in the box with ampoules.
Sampler	On the syringe cylinder.

The barcode information may also be entered manually in the input fields on the **Patient profile**, **Patient ID**, **QC solutions** and **Replacement** screens – see section *Miscellaneous setup* in chapter 1: *Setup* in the ABL90 FLEX reference manual.

Consumables

Sensor cassette pack with sensor cassette



1 Sensor cassette pack

The sensor cassette is delivered in a sensor cassette pack. For further information about how to remove the sensor cassette from the sensor cassette pack, see *Sensor cassette* in section *Replacements* in chapter 7: *Replacements* in this manual.

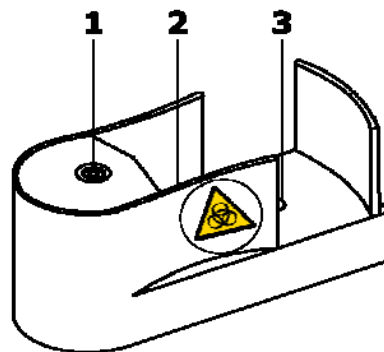

Sensor cassette:

-
- 1 Reference lid
 - 2 Electrical contact to sensors
 - 3 Oxygen sensor

Solution pack



1

Biohazard label

Before installation of the solution pack, remove the top cover of the label on top of the solution pack, so that the biohazard label appears, to remind you that the solution pack must be disposed of as infectious waste after use.

2

Safety pin

To activate a new solution pack, remove the safety pin and press the lid down (see *Solution pack* in section *Replacements* in chapter 7: *Replacements* in this manual for further information).

Software

Screen elements

Main screen

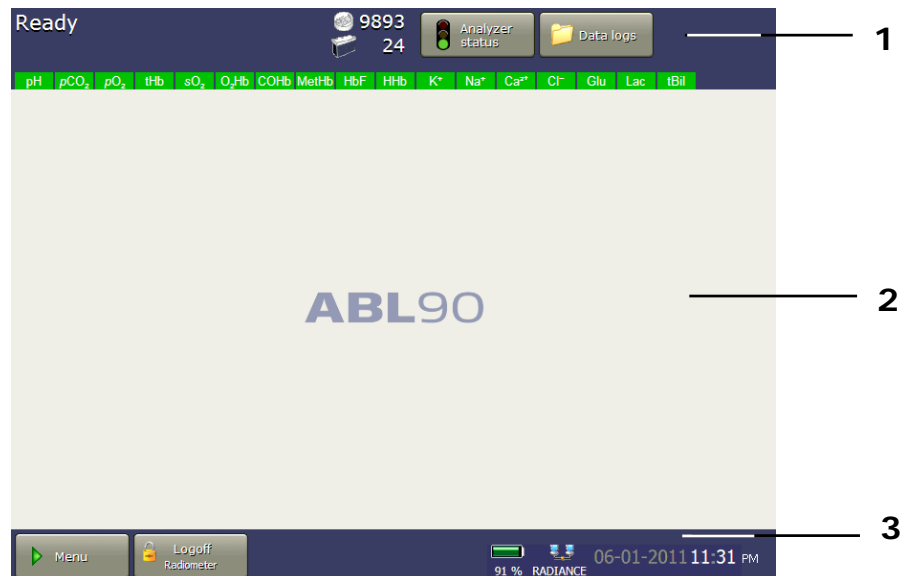

- 1 **Top section – see below**
- 2 **Center section – see later in this chapter**
- 3 **Bottom section – see later in this chapter**

The main screen appears automatically if the touch screen is idle for more than 3 minutes.

Top section

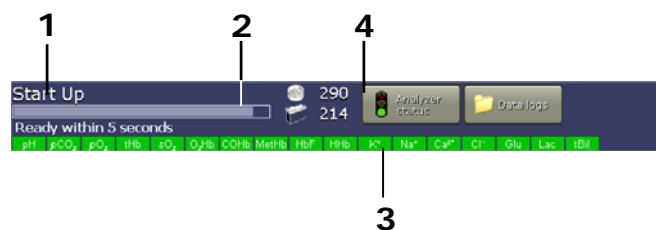



- 1 **Status bar** describing the current task of the analyzer (e.g. calibration, measurement) or its status (e.g. ready for use, locked).
- 2 **Time bar** seen only when the analyzer is performing an activity. The time bar follows the progress of the task.

If you are performing a sample or QC measurement, a calibration, or a cold or warm start, a text appears underneath the time bar, telling you when the analyzer approximately will be ready again (e.g. "Ready within 1 hour").

- 3 **Parameter bar** listing all measurement parameters available and activated on your analyzer. You may judge the parameter status at a glance before you perform a measurement.
- 4 Shows the number of remaining tests and activities.

Parameter status:

- Green  Parameter status is okay; no problem detected on the given measuring channel.
- Yellow  Error associated with the given parameter during the last calibration or quality control measurement. The parameter is unreliable and will have a "?" in front of the result (if requested in the Corrective actions program (see section *Corrective actions*, chapter 1: *Setup* in the ABL90 FLEX reference manual)).
- Red  Serious error associated with the given measuring channel. The parameter cannot be used at all and will be displayed as "....."; or a parameter was repressed in the Parameter setup program (see section *Parameters and input setup*, chapter 1: *Setup* in the ABL90 FLEX reference manual).

A parameter disabled in the Parameter setup program will be removed from the parameter bar – see *Disabled versus deselected parameter* in section *Analysis setup* in chapter 1: *Setup* in the ABL90 FLEX reference manual.

The buttons can be selected in the *Access profiles* setup programs together with the access profiles for each operator – for detailed information, see the description in *Access profiles* in section *Analyzer security* in chapter 1: *Setup* in the ABL90 FLEX reference manual.

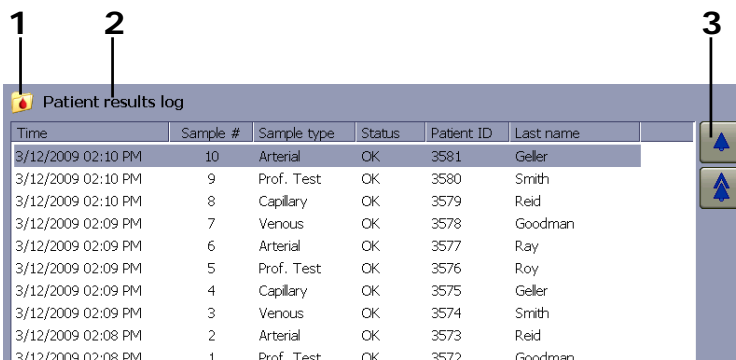
Center section

Time	Sample #	Sample type	Status	Patient ID	Last name
3/12/2009 02:10 PM	10	Arterial	OK	3581	Geler
3/12/2009 02:10 PM	9	Prof. Test	OK	3580	Smith
3/12/2009 02:10 PM	8	Capillary	OK	3579	Reid
3/12/2009 02:09 PM	7	Venous	OK	3578	Goodman
3/12/2009 02:09 PM	6	Arterial	OK	3577	Ray
3/12/2009 02:09 PM	5	Prof. Test	OK	3576	Roy
3/12/2009 02:09 PM	4	Capillary	OK	3575	Geler
3/12/2009 02:09 PM	3	Venous	OK	3574	Smith
3/12/2009 02:08 PM	2	Arterial	OK	3573	Reid
3/12/2009 02:08 PM	1	Prof. Test	OK	3572	Goodman

- 1 **Icon** that describes the screen; it is the same as the button that gives access to that screen.
- 2 **Screen header** (or name).
- 3 **Navigation buttons** – see below.

Navigation tools



The first line is highlighted on the screen. To highlight another line, touch it on the screen or use...



... Up/down single-arrow scroll buttons that highlight one item at a time upward or downward.



... Page up/down double-arrow scroll buttons that highlight an item at the top or the bottom of each screen.



...Left/right single-arrow scroll buttons that move a text box horizontally when the box extends beyond the area available on the screen.

Interaction tools – text boxes

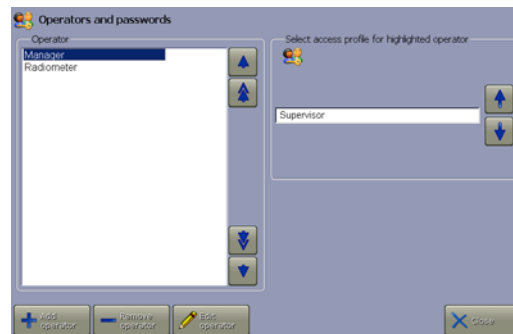

The first line is highlighted. To highlight another line, use the up/down arrows or touch the line in the box.

Enter the data using the screen keypad or screen keyboard.

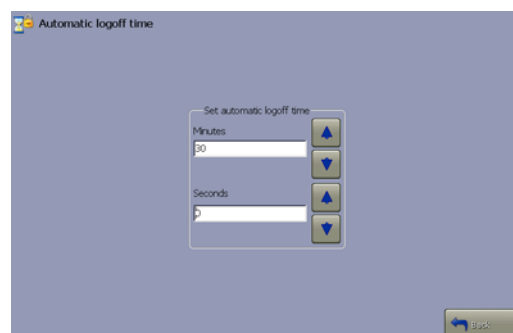

In this text box you can select one of the predefined options. Use the up/down arrows to select an item.

If the text box already contains an entry, it will be overwritten and cannot be retrieved.

In this manual, text boxes are written in inverted commas, e.g. "Operator". The same applies to the other elements in the center section of the screen: names of the columns (e.g. "Status"), input fields (e.g. "Draw time"), etc.

Interaction tools – check buttons

With the check buttons you can enable/disable or select/deselect an item on the screen. For example:



A function is selected (e.g. acoustic signal if the inlet remains open) or activated (e.g. communication with the RADIANCE system).



A function is deselected or deactivated.



A parameter is selected.



A parameter is deselected.

Interaction tools – screen keypad



Keypad with numerical buttons.

Depending on the screen, the decimal point may be absent, e.g. **Time/Date setup**.

Press the Backspace button to delete a character from right to left. The box is cleared as soon as the first character is typed.

Press **Enter** (or **Select** in some cases) to confirm a numerical entry and to highlight the next line in the text box.

To get access to an alphanumeric keyboard press the keyboard icon.

Interaction tools – screen keyboard



To enter alphanumerical text, key in the text and press **Enter** to confirm the entry and to return to the analyzer screen

To return to the previous screen, without making any entries/changes to already entered text, press **Esc**.

Bottom section Buttons

- Each button has an icon and a name placed on it. When pressed, it opens or closes a screen or a menu.
- The buttons are designated in bold italics in this manual, e.g. ***Menu***, ***Utilities***, etc.
- The buttons displayed in full color can be activated. A grayed-out button is currently inactive.
- The buttons can be selected in the Access Profiles setup program together with the access profiles for each operator – for detailed information, see the description in *Access profiles* in section *Analyzer security* in chapter 1: *Setup* in the ABL90 FLEX reference manual.

Note the functions of the following buttons:



Returns you to the previous screen in the same program; e.g. in the Patient Results log, it will return you from the **Patient identification** screen to the **Patient result** screen.

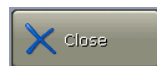

Returns you to the **Main** screen.

Information bar

The **information bar** is placed in the lower right corner of the screen.



- 1 **Clock** – shows the current time in the selected format.
- 2 **Date** – shows the current date.
- 3 **RADIANCE System icon** - shown in the information bar if connection has been established.
- 4 **Battery level indicator**

Initial logon

Access rights The following actions are allowed at analyzer startup:

- Performing a measurement
- Calling a calibration
- Viewing/Editing data in the data logs
- Performing a replacement

Entering standard password

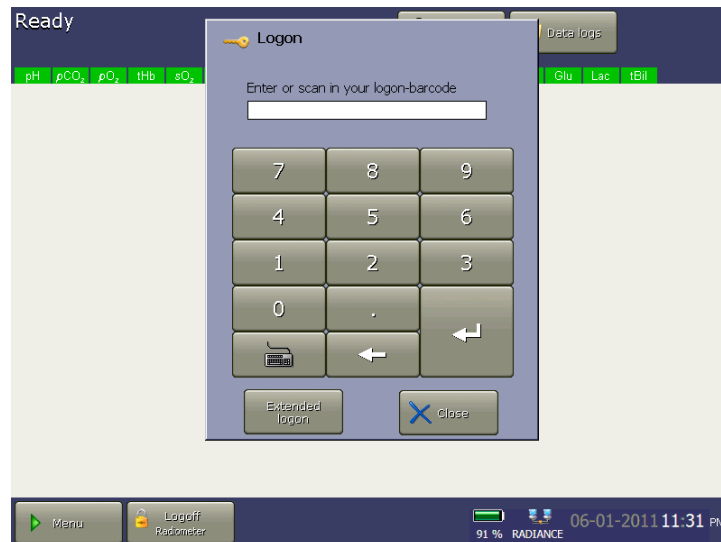

Step	Action
------	--------

- | | |
|----|--|
| 1. | Press Menu > Logon on the Main screen. |
| 2. | Type in the standard password: 123456 and confirm with Enter . |
| 3. | Press Menu to access the complete menu – see the previous page. |

See *General security* in section *Analyzer security* in chapter 1: *Setup* in the ABL90 FLEX reference manual for further information about the logon possibilities.

The access possibilities for each user and their passwords are entered in the Analyzer Security setup programs – see section *Analyzer security* in chapter 1: *Setup* in the ABL90 FLEX reference manual.

Menu structure

When the analyzer is taken into use, only the following limited menu is available.

Press **Menu**.

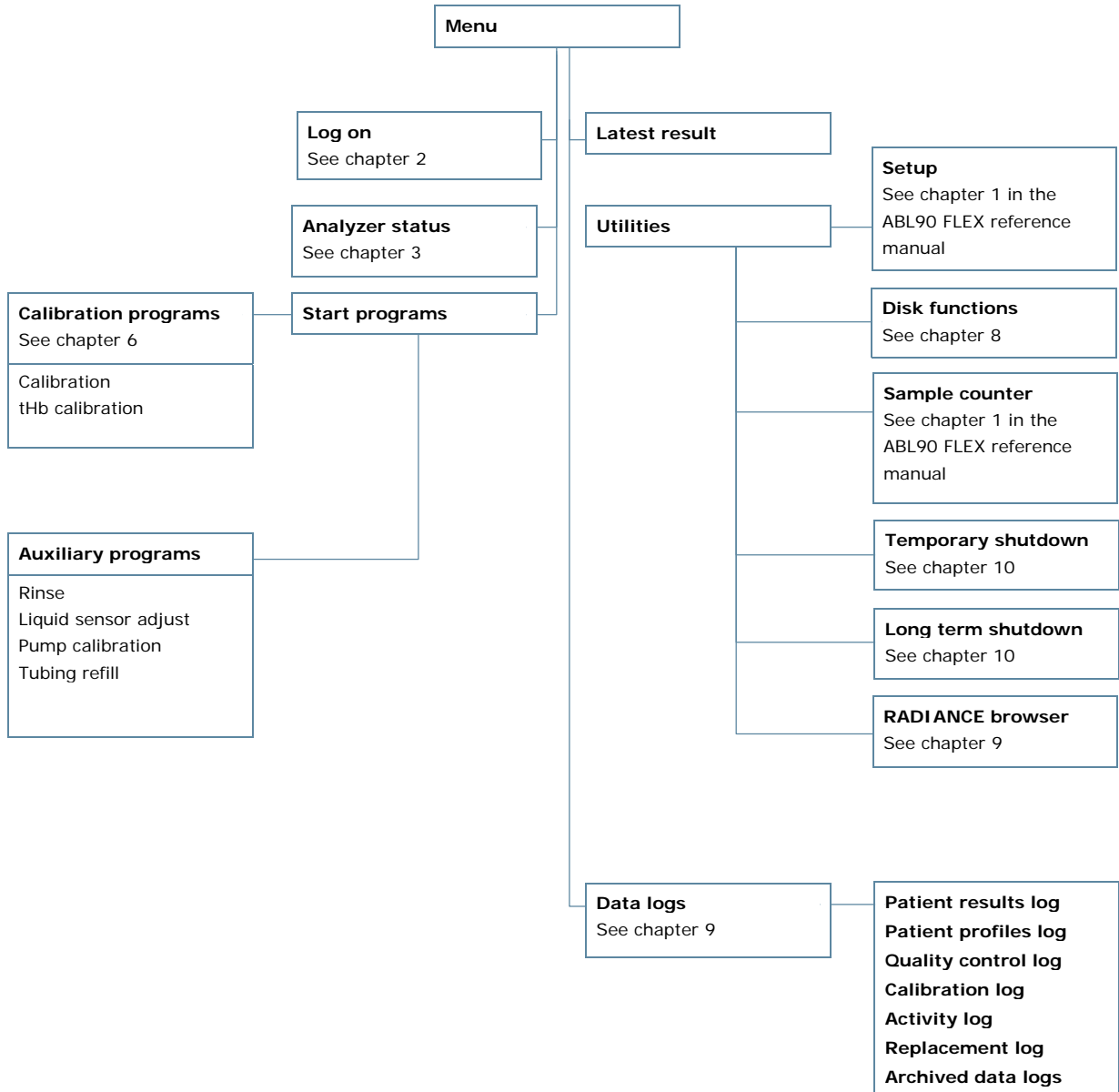

3. Analyzer status

Analyzer status at a glance.....	3-2
Analyzer status elements	3-3
Calibration status.....	3-4
Quality control (QC)	3-5
Replacements.....	3-6
Other activities	3-7
System messages	3-7

Analyzer status at a glance

The working condition of the analyzer is continuously monitored during its operation.

To evaluate the analyzer status at a glance before a measurement, use the following:

- Parameter bar
- Color of the traffic light on the **Analyzer status** button.

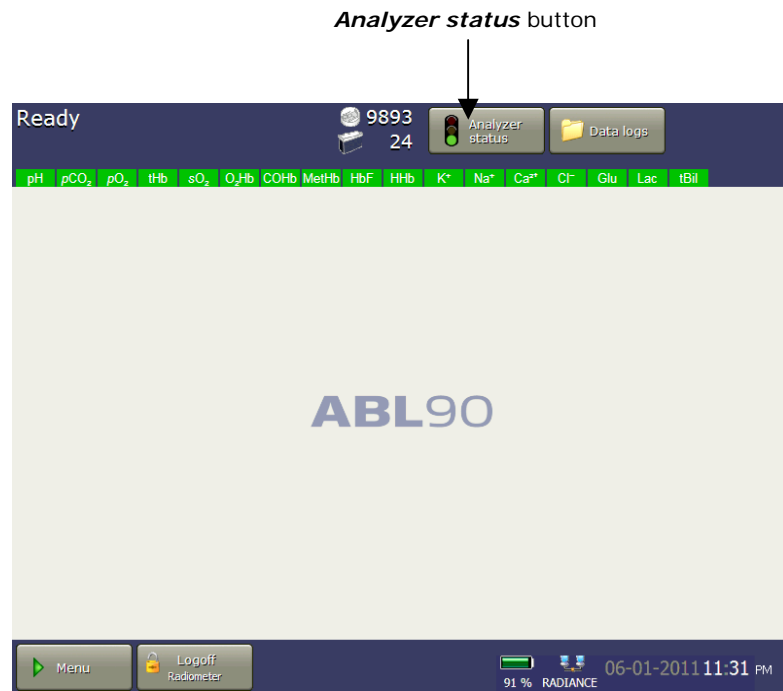

To enter the **Analyzer status** screen, press **Menu > Analyzer status** or press the **Analyzer status** button to access the analyzer status directly.

Analyzer status elements

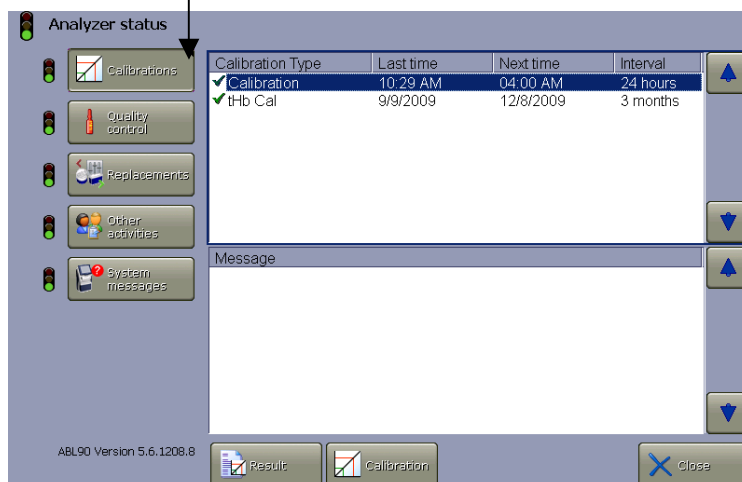

The black triangle indicates that this is active



The traffic light color of the **Analyzer status** button is determined by the traffic light colors of the following status elements:

Status element	Color	Indicates
Calibrations	GREEN	OK
	YELLOW	Error(s) in the last calibration and/or calibration schedule reminders.
Quality control	GREEN	OK
	YELLOW	Error(s) in the last QC measurement and/or QC schedule reminders.
Replacements	GREEN	No replacements due at the present time.
	YELLOW	A replacement is due.
Other activities	GREEN	No activities due at the present time.
	YELLOW	Activity overdue.
System messages	GREEN	No (critical) messages.
	YELLOW	Non-critical messages.
	RED	Critical messages. The analyzer cannot calibrate or measure.

Calibration status

Calibration Type	Lists the most recently performed calibration of each type and its status:	
		Calibration was accepted.
	?	Error(s) detected during calibration.
		Pending or overdue calibration. The last calibration was accepted.
	? 	Pending or overdue calibration. The last calibration was not accepted.
Last time	The date and time that the last calibration of the specified type was performed.	
Next time	The date and time that the next calibration of the specified type is due according to the calibration schedule – see section <i>Calibration schedule setup</i> chapter 1: <i>Setup</i> in the ABL90 FLEX reference manual.	
Interval	The time interval between calibrations as set up in the calibration schedule.	
Message	Messages (if present) referring to a highlighted calibration.	
Buttons	<ul style="list-style-type: none"> • Result: Press to see results • Calibration: Press to start a highlighted calibration. 	

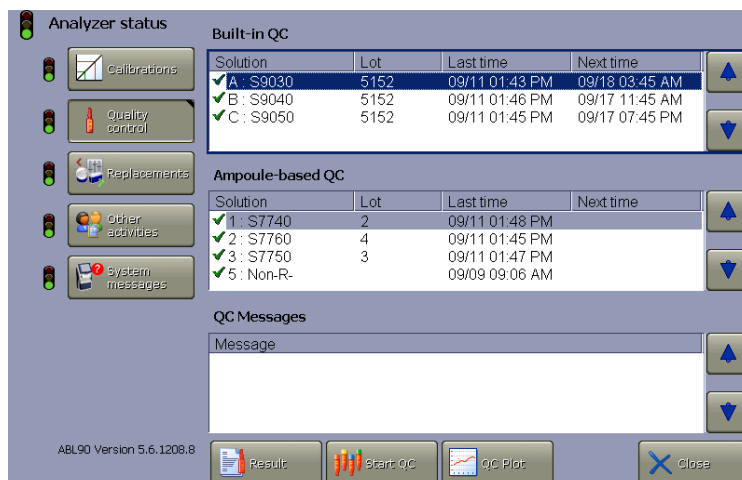

Quality control (QC)

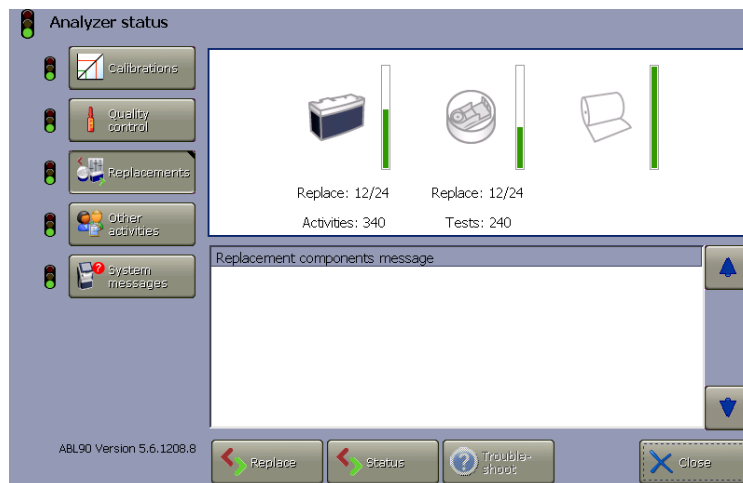

Solution (built-in or ampoule-based)	Lists the quality control slot and its solution type along with its status:	
	✓	The last measurement was accepted.
	?	One or more of the following occurred: Error in the last calibration Analyzer error during last QC measurement A parameter measurement is outside the defined ranges, or a Westgard Rule or RiLiBÅK range has been violated (if Westgard Rules or RiLiBÅK ranges have been selected)
	🕒	The next measurement is overdue, and the previous measurement, if any, was accepted.
	?	🕒 The last quality control measurement had errors, and the next measurement is overdue.
Lot	The solution lot number for the slot.	
Last time	The time that the last measurement was performed.	
Next time	The next scheduled time to perform the measurement on the slot – see <i>Quality control schedule setup</i> in section <i>Quality control setup</i> in chapter 1: <i>Setup</i> in the ABL90 FLEX reference manual.	
QC messages	Messages (if present) referring to a highlighted QC measurement.	
Buttons	<ul style="list-style-type: none"> • Result: Press to see results • Start QC: Press to start a QC measurement • QC Plot: Press to view the plot for the highlighted QC solution. 	

Replacements



 Replace: 12/24 Activities: 340	Solution pack status, replacement due date and the number of remaining activities.
 Replace: 12/24 Tests: 240	Sensor cassette status, replacement due date and the number of remaining tests.
	The printer paper is to be replaced as needed.
Replacement components message	Messages (if present) referring to an activity.

Buttons	<ul style="list-style-type: none"> • Replace: Press to select one of the replacements • Status: Press to see status and replacement reasons of the consumable selected • Troubleshoot: Press to get troubleshooting information for the message in question.
---------	--

Replacement procedures – see chapter 7: *Replacements*.





Other activities

Here it is possible to view the scheduled replacements and user activities (see *Replacement schedule setup* and *User activities* in section *Replacement setup* in chapter 1: *Setup* in the ABL90 FLEX reference manual) and to see, if any of the activities are overdue. To see only overdue replacements/user activities press **Reminders only**.

System messages

Here it is possible to view and remedy analyzer messages (see *Operator actions in case of error* in section *General information* in chapter 11: *Troubleshooting* in this manual and chapter 10: *Analyzer messages* in the ABL90 FLEX reference manual).

Battery level indicator

Icon	Indication
	<p>The analyzer is connected to mains.</p> <p>Battery charge level is indicated by a percentage.</p>
	<p>The analyzer is running on battery.</p> <p>Battery charge level is indicated by a percentage.</p>
	<p><u>If battery charge level:</u></p> <ul style="list-style-type: none"> • ≤25%, the battery charge level in the icon is yellow. A system message is shown in the Activity log. <p>Corrective action:</p> <ul style="list-style-type: none"> – Connect the analyzer to mains.
	<ul style="list-style-type: none"> • ≤13%, the battery charge level in the icon is red. A message is shown on the screen. <p>Corrective actions:</p> <ul style="list-style-type: none"> – Connect the analyzer to mains. – Close the dialogue box.
	<ul style="list-style-type: none"> • ≤10%, the analyzer shuts down. <p>Corrective actions:</p> <ul style="list-style-type: none"> – Connect the analyzer to mains. – Turn on the analyzer.

4. Sample measurement

General information.....	4-2
Immediately before analysis	4-3
Introducing a blood sample with a standard syringe	4-4
Introducing a blood sample with a <i>safe</i> PICO sampler with barcode	4-5
Introducing a blood sample with a <i>safe</i> PICO sampler with barcode and sample pre-registration	4-6
Introducing a blood sample with a capillary tube.....	4-8
Introducing a blood sample with a test tube.....	4-9
Entering patient identification	4-10
Patient result.....	4-14
Patient result messages	4-19

General information

Available modes and parameters

The modes and the measured parameters available on the ABL90 FLEX analyzer are listed below.

Modes	Parameters
Syringe – S 65µL, Capillary – C 65µL	pH, $p\text{CO}_2$, $p\text{O}_2$, ctHb, $s\text{O}_2$, FO_2Hb , FCOHb , FHHb , FMetHb , FHbF , $c\text{K}^+$, $c\text{Na}^+$, $c\text{Ca}^{2+}$, $c\text{Cl}^-$, $c\text{Glu}$, $c\text{Lac}$, $c\text{tBil}$
Ampoule - QC	All available

- NOTICES:**
- Not all of the above parameters may be available on your analyzer – it depends on your sensor cassette version
 - FHbF is by default disabled

Immediately before analysis

The blood sample must be mixed immediately before it is introduced into the analyzer to ensure its homogeneity. If a sample is transferred from a sampler to the analyzer without having been properly mixed, either the plasma phase or the packed red blood cells may be analyzed, making the oximetry results meaningless.

safePICO sampler: Place the syringe in the built-in sample mixer on the front of the analyzer. The mixer starts automatically and stops when the sample has been sufficiently mixed.

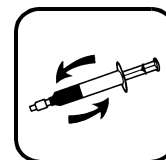

Alternatively, invert the syringe repeatedly, roll it between the palms of your hands and follow your standard operating procedure.

Capillary tube: Mix a capillary sample by gently moving the mixing wire repeatedly along the length of the capillary with a magnet. Then move the mixing wire to the end of the capillary opposite to that from which the blood is to be aspirated.

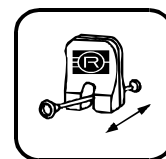

Remove both capillary caps.

Test tube: Invert the test tube repeatedly. Then remove the cap.

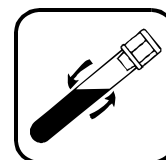



CAUTION – Relevant capillary tube volume

Too small capillary volume will give the "Insufficient sample" error.

See chapter 12: *Sampling* for guidelines on how to handle blood samples.

Before introducing the sample into the analyzer, check the availability and status of the desired parameters. For detailed information, see chapter 3: *Analyzer status* in this manual.

Introducing a blood sample with a standard syringe

Step	Action
1.	Check that the analyzer is in the Ready mode.
2.	Lift the inlet to the syringe position and follow the on-screen instructions.
3.	Place the syringe tip firmly against the inlet gasket and press it upwards while still holding on to the sampler cylinder. The inlet probe extends into the syringe and the blood is automatically aspirated. NOTICE: Be careful not to bend the probe. Hold on to the syringe barrel and do not press the plunger. NOTICE: Make sure that the plunger is not pushed back by the probe. NOTICE: When aspirating small blood volumes less than: PICO50 samplers: 1.1 mL PICO70/ <i>safe</i> PICO70 samplers: 0.7 mL, make sure that the heparin coated fiber disk does not block the probe during aspiration.  WARNING – Risk of infection To avoid the risk of infection take care not to scratch or stab yourself on the probe.  WARNING - Risk of erroneous results Press the inlet gasket totally up to make sure that the sample is aspirated correctly, i.e. from the whole sample and not just the tip of the syringe. Otherwise this may lead to erroneous tHb results.
4.	When prompted by the analyzer, remove the sampler and close the inlet.
5.	Enter the information needed on the Patient identification screen.

Introducing a blood sample with a *safePICO* sampler with barcode

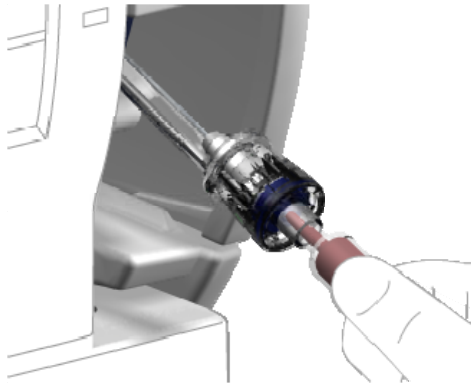
Step	Action
1.	Check that the analyzer is in the Ready mode and scan the sampler barcode (see <i>Barcode reader</i> in section <i>Hardware</i> , chapter 2: <i>What is what</i>). Do not remove the <i>safeTIPCAP</i> , the analyzer probe will pierce the <i>safeTIPCAP</i> .
2.	Lift the inlet to the syringe position and follow the on-screen instructions.
3.	Place the <i>safeTIPCAP</i> tip firmly against the inlet gasket and press it upwards while still holding on to the sampler cylinder. The inlet probe extends into the syringe and the blood is automatically aspirated. <div style="display: flex; align-items: center; margin-top: 10px;">  </div> <p>NOTICE: Be careful not to bend the probe. Hold on to the syringe barrel and do not press the plunger.</p> <p>NOTICE: Make sure that the plunger is not pushed back by the probe.</p> <p>NOTICE: When aspirating small blood volumes less than:</p> <p>PICO50 samplers: 1.1 mL</p> <p>PICO70/<i>safePICO</i>70 samplers: 0.7 mL,</p> <p>make sure that the heparin coated fiber disk does not block the probe during aspiration.</p> <p>WARNING – Risk of infection To avoid the risk of infection take care not to scratch or stab yourself on the probe.</p> <p>WARNING - Risk of erroneous results Press the inlet gasket totally up to make sure that the sample is aspirated correctly, i.e. from the whole sample and not just the tip of the syringe. Otherwise this may lead to erroneous tHb results.</p>
4.	When prompted by the analyzer, remove the sampler and close the inlet.
5.	Enter the information needed on the Patient identification screen.

Introducing a blood sample with a *safe*PICO sampler with barcode and sample pre-registration

- | Step | Action |
|------|---|
| 1. | Check that the analyzer is in the Ready mode and scan the sampler barcode (see <i>Barcode reader</i> in section <i>Hardware</i> , chapter 2: <i>What is what</i>). Do not remove the <i>safe</i> TIPCAP. |
| 2. | If Sample pre-registration has not been selected: Proceed to step 3 below. |

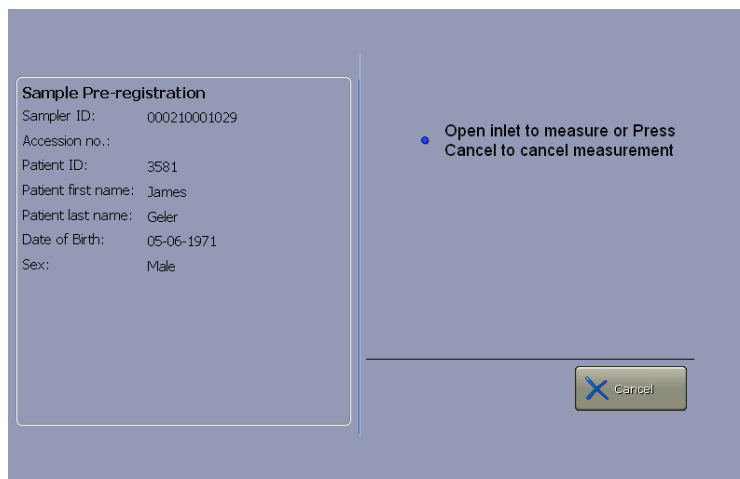

- If Sample pre-registration has been selected in the Sample pre-registration setup (see section *Sample pre-registration setup* in chapter 1: *Setup* in the ABL90 FLEX reference manual): Proceed to step **3** below to start the measurement or press **Cancel** to cancel the displayed patient data.
- 3.** Lift the inlet to the syringe position and follow the on-screen instructions.
- Do not remove the *safe*TIPCAP.

Step Action

4. Place the *safe*TIPCAP tip firmly against the inlet gasket and press it upwards while still holding on to the sampler cylinder. The inlet probe extends into the syringe and the blood is automatically aspirated.

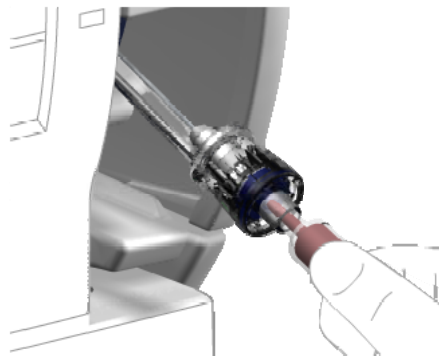

NOTICE: Be careful not to bend the probe. Hold on to the syringe barrel and do not press the plunger.

NOTICE: Make sure that the plunger is not pushed back by the probe.

NOTICE: When aspirating small blood volumes less than:

PICO50 samplers: 1.1 mL

PICO70/*safe*PICO70 samplers: 0.7 mL,

make sure that the heparin coated fiber disk does not block the probe during aspiration.



WARNING – Risk of infection

To avoid the risk of infection take care not to scratch or stab yourself on the probe.



WARNING - Risk of erroneous results

Press the inlet gasket totally up to make sure that the sample is aspirated correctly, i.e. from the whole sample and not just the tip of the syringe. Otherwise this may lead to erroneous tHb results.

5. When prompted by the analyzer, remove the sampler and close the inlet.
6. Enter the information needed on the **Patient identification** screen.

Introducing a blood sample with a capillary tube

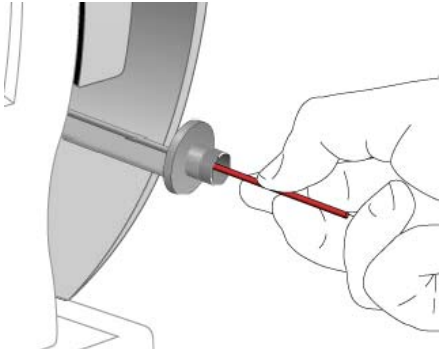
Step	Action
1.	Check that the analyzer is in the Ready mode.
2.	Mix the capillary sample by gently moving the mixing wire repeatedly along the length of the capillary with a magnet. Then move the mixing wire to the end of the capillary opposite to that from which the blood is to be aspirated.
3.	Lift the inlet to the capillary position and follow the on-screen instructions.
4.	Remove the capillary caps, if any, and press the capillary against the inlet gasket as shown. <div style="display: flex; align-items: center; margin-top: 10px;"> <div style="flex: 1;"> <p>NOTICE: To ensure the right positioning of the capillary tube, place it in the center of the inlet gasket conus. A slight turn of the capillary tube when positioning it might assist with the centering.</p> <p>The blood is automatically aspirated when the inlet gasket is pushed inwards.</p> <p>⚠ WARNING - Risk of erroneous results</p> <p>Gently press the inlet gasket totally in to make sure that the sample is aspirated correctly, i.e. from the whole sample and not just the tip of the capillary tube. Otherwise this may lead to erroneous tHb results.</p> </div> <div style="flex: 1; text-align: center;">  </div> </div>
5.	When prompted by the analyzer, remove the capillary and close the inlet.
6.	Enter the information needed on the Patient identification screen.

Introducing a blood sample with a test tube

Step	Action
1.	Check that the analyzer is in the Ready mode.
2.	Lift the inlet to the syringe position and follow the on-screen instructions.
3.	Place the test tube opening firmly against the inlet gasket holder and press it upwards while still holding on to the test tube. The inlet probe extends into the tube and the blood is automatically aspirated. NOTICE: Be careful not to bend the probe. NOTICE: If the inlet probe has difficulties in reaching the blood sample, we recommend that you transfer the blood sample to a smaller test tube, or, alternatively, try to tilt the test tube a little, so that the inlet probe can reach into the blood sample.
4.	When prompted by the analyzer, remove the test tube and close the inlet.
5.	Enter the information needed on the Patient identification screen.

Entering patient identification

Entering information with barcode reader

Step Action

1. Activate the "Enable general barcode support" function in the Miscellaneous setup, if not done already (see chapter 1: *Setup* in the ABL90 FLEX reference manual).
2. Scan all barcodes, if available (e.g., Accession no., Sampler ID, Patient department, Patient last name, etc.) (see *Barcode reader* in section *Hardware*, chapter 2: *What is what*) in the proper field.
3. Scan "Operator" or "Physician" from your ID card, if available.
 - If the name is included in the list of the analyzer's registered users, the barcode will identify the person and fill in the name automatically – depending on the selected input layout
 - If the name is not included in the list of the analyzer's registered users, only the barcode will be read from the ID card

Entering information manually

Step Action

1. Highlight the desired input field in the Patient identification list (the top box is already highlighted when the **Patient identification** screen appears).
2. Type in the patient information, using the screen keypad or keyboard, and confirm each entry with the **Enter** button.
 - If a patient ID has been used before or is included in the Patient profile log, the relevant input fields will be filled in automatically – see section *Patient profiles log*, chapter 9: *Data management* in this manual.
 - Press **Patient lookup** (if available) to obtain the latest information about your patient – see the Patient lookup function below.

Step	Action
------	--------

- | | |
|----|---|
| 3. | <p>The analyzer is connected to LIS/HIS and/or the RADIANCE system:</p> <ul style="list-style-type: none"> Type in the Patient ID or Accession number. If automatic data request has been selected in Communications setup (see <i>Automatic data request setup</i> in section <i>Communications setup</i> in chapter 1: <i>Setup</i> in the ABL90 FLEX reference manual), the relevant input fields will be automatically filled in with data received from LIS/HIS or the RADIANCE system. <p>Or</p> <ul style="list-style-type: none"> Press Request (if available) – after the patient ID or Accession number has been entered – to fill the relevant text boxes |
| 4. | Fill in all the mandatory (with a  next to it) text boxes to view the measurement results. |
| 5. | If desired, select another report layout (see next page, section <i>Selecting a report layout</i>). |

- NOTICES:**
- If the requested patient data (e.g. Patient last name) was received after the **Patient identification** screen was exited, the patient report will be transmitted without the requested data. To prevent this, select one of the patient ID items transferred from LIS/HIS as mandatory.
 - If the requested patient data (e.g. Patient last name) was received after the **Patient identification** screen was exited, the patient report will be stored without the requested data in the Patient report log. The data will be stored as a patient profile in the analyzer's database without, however, being attached to any patient report. The data can be reused the next time the same patient ID is used.

Patient lookup The Patient lookup function allows you to transfer the patient information from a department's specific list to the **Patient identification** screen if the following conditions are fulfilled:

Item	Conditions
Data source	<p>Should be selected in Patient lookup setup (see <i>Patient lookup setup</i> in section <i>Communications setup</i>, chapter 1: <i>Setup</i> in the ABL90 FLEX reference manual for details) for the specified data source:</p> <ul style="list-style-type: none"> LIS/HIS RADIANCE system Analyzer's local database
Exclude from patient list after ...	<p>Number of days that you want each patient to be kept in the list should be selected (see <i>Patient lookup setup</i> in section <i>Communications setup</i>, chapter 1: <i>Setup</i> in the ABL90 FLEX reference manual for details)</p>
Department (Pat.)	<p>Must be included and filled in on the Patient identification screen.</p>

Step	Action
1.	Highlight and fill in the "Department (Pat.)" field on the Patient identification screen.
2.	Press Patient lookup .
3.	Select your patient from the list by highlighting the corresponding line on the screen.
4.	Press Update to update the Patient list.
5.	<ul style="list-style-type: none"> Press Select to transfer the specific patient information to the Patient identification screen and return to the previous screen Or <ul style="list-style-type: none"> Press Back to return to the previous screen without updating the patient information

Selecting a report layout

Step	Action
1.	Highlight "Report layout" with the up/down arrows on the Patient identification screen.
2.	<ul style="list-style-type: none"> "Report layout" is included in the Patient ID: Select a layout from the list displayed on the right side of the screen, using the up/down arrows. (The list of report layouts has been made in the Patient report setup – see <i>Patient report setup</i> in section <i>Analysis setup</i> in chapter 1: <i>Setup</i> in the ABL90 FLEX reference manual). "Report layout" is not included in the Patient ID: Highlight the line on the Patient identification screen (the input field is separated from the rest of the items on the screen) and select the desired layout. The patient report will be saved in this layout. Data not shown in the layout selected will still be archived.

De-selecting parameters after a measurement

Step	Action
1.	Press Parameters on the Patient identification screen.
2.	Deactivate the relevant check button to exclude a parameter.
3.	<ul style="list-style-type: none"> Press Back to return to the Patient identification screen Press Result to display the changed result Press Print to print out the changed patient report

NOTICE: The **Selected parameters** screen displays all the parameters selected in the Parameter profile for a given measuring mode.

Determining $FShunt$ and $ctO_2(a-\bar{v})$

Calculation of $FShunt$ and $ctO_2(a-\bar{v})$

To obtain the calculated values of $FShunt$ and $ctO_2(a-\bar{v})$, it is necessary to analyze a mixed-venous and an arterial (or capillary) blood sample from the patient.

Step	Action
1.	<p>Make, if required, a new patient report layout (see <i>Patient report setup</i> in section <i>Analysis setup</i>, chapter 1: <i>Setup</i> in the ABL90 FLEX reference manual) with the following parameters included:</p> <ul style="list-style-type: none"> • $FShunt$ and/or $ctO_2(a-\bar{v})$ into the Patient result • $pO_2(\bar{v})$, $sO_2(\bar{v})$, $FO_2(I)$, RQ and T (patient temperature) into the Patient ID
2.	Analyze the mixed-venous sample and record the $pO_2(\bar{v})$ and $sO_2(\bar{v})$.
3.	Analyze the arterial sample.
4.	<p>On the Patient identification screen, select the sample type as "Arterial" or "Capillary" and key in the following values:</p> <ul style="list-style-type: none"> • $pO_2(\bar{v})$ and $sO_2(\bar{v})$ from the mixed-venous sample (step 2 above) • $FO_2(I)$ if it differs from the default value of 0.21 (for $FShunt$) • RQ if it differs from the default value of 0.86 (for $FShunt$) • T if it differs from the default value of 37 °C (for $FShunt$)

NOTICE: The $FShunt$ will be estimated if not all of the inputs ($sO_2(\bar{v})$, $pO_2(\bar{v})$, $FO_2(I)$, RQ) are given. A default value for $ctO_2(a-\bar{v})$ will be used if $pO_2(\bar{v})$ as well as $sO_2(\bar{v})$ are not input.

Patient result

Program

The **Patient result** screen will be displayed automatically when the measurement has been completed. However, if the patient identification information took longer to enter than the measurement, you can do one of the following:

- Press **Result** on the **Ready** screen
- Press **Menu > Latest result**
- Press **Menu > My results**
- Press **Menu > Data logs > Patient results log**, highlight the desired result and press **Result**

Patient result		Capillary - C 65uL	Sample # 10	3/12/2009 02:10 PM
Sensor cassette lot:	42		Patient ID:	3581
Solution pack lot:	WL-07			
Blood gas values		cCl ⁻	110 mmol/L	[-]
pH	7.412 [-]	Metabolite values		
pCO ₂	41.5 mmHg [-]	cGlu	8.0 mmol/L	[-]
pO ₂	86.3 mmHg [-]	cLac	0.6 mmol/L	[-]
Oximetry values		ctBil	567 μmol/L	[-]
ctHb	15.1 g/dL [-]			
sO ₂	97.3 % [-]			
F _O Hb	95.5 % [-]			
F _{CO} Hb	1.3 % [-]			
F _H Hb	2.7 % [-]			
F _{Met} Hb	0.5 % [-]			
F _{Hb} F	61 % [-]			
Electrolyte values				
ck ⁺	3.6 mmol/L [-]			
cNa ⁺	142 mmol/L [-]			
cCa ²⁺	1.21 mmol/L [-]			

Parameter status

No marking next to a parameter indicates that a parameter was measured without any fault.

The following markings may appear next to a parameter:

Marking	Explanation
"?"	<ul style="list-style-type: none"> • Error in the last quality control measurement or calibration, or because of sample problems • Sample age selected for the given parameter(s) in Sample logistics setup (see <i>Sample age evaluation setup</i> in section <i>Analysis setup</i> in chapter 1: <i>Setup</i> in the ABL90 FLEX reference manual) was exceeded
↑ ↓	<ul style="list-style-type: none"> • Parameter value is outside the reference range (the range within which the parameter value is considered normal, for the specific type of sample being measured), but inside the critical limits
↑↑ ↓↓	<ul style="list-style-type: none"> • Parameter value is outside the upper or lower critical limit (the limits outside of which a parameter value is dangerously high or low, for the specific type of sample being measured), but inside the reportable range.

Marking	Explanation
	<ul style="list-style-type: none"> Parameter value is outside the reportable range. The reportable range can be selected for all measured and derived parameters. The values of a parameter with these markings are blanked out and hence not shown in the result. The markings will, however, be printed together with the result.
"...." instead of the value	<ul style="list-style-type: none"> A parameter cannot be calculated or exceeds the numerical limit of the analyzer (range of indication)
"*" next to the value	<ul style="list-style-type: none"> Values with user-defined correction factors

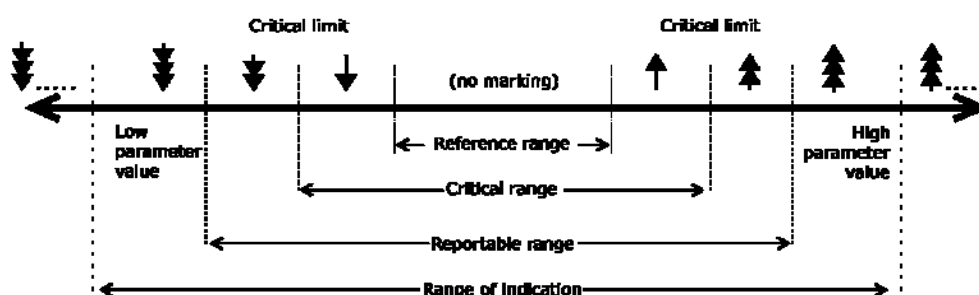

Recalling patient ID

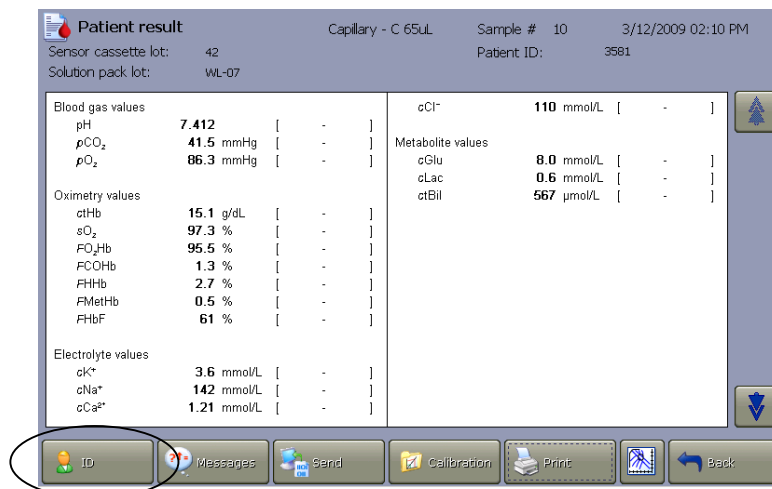

To recall the **Patient identification** screen, press **ID**.

For detailed information, refer to the section *Entering patient identification* in this chapter.

Patient result approval

Result approval is possible if the "Enable patient result approval" check button has been activated in the Miscellaneous setup, and only if the analyzer is set up to LIS/HIS and the RADIANCE system (see section *Miscellaneous setup* in chapter 1: *Setup* in the ABL90 FLEX reference manual).

Step	Action
1.	Press Approval on the Patient result screen to display the following functions:
2.	<ul style="list-style-type: none"> • Approve Press Accept to accept the result and to send it to the connected RADIANCE system or LIS/HIS. Press the Keyboard icon to write a note. Press Cancel to return to the previous screen. • Reject Press Accept to reject the result and to send it to the connected RADIANCE system or LIS/HIS. Press the Keyboard icon to write a note. Press Cancel to return to the previous screen. • Rerun Press Accept to mark that the measurement should be repeated, and to send it to the connected RADIANCE system or LIS/HIS. Press the Keyboard icon to write a note. Press Cancel to return to the previous screen. • Note Press the Keyboard icon to type in a note prior to the approval or to edit a highlighted note. To delete a highlighted note, press the Keyboard icon and delete the note.

- NOTICES:**
- Once the result has been approved/rejected/rerun, the ID data can only be viewed, not changed (grayed-out input boxes). The **Parameters**, **Patient lookup** and **Request** buttons will not be available either.
 - In the Patient report log you can filter patient reports according to the approval status
 - The button changes to **Send** after the approval of the patient result has been made (if selected in Communications setup – see chapter 1: *Setup* in the ABL90 FLEX reference manual).

Acid-Base chart

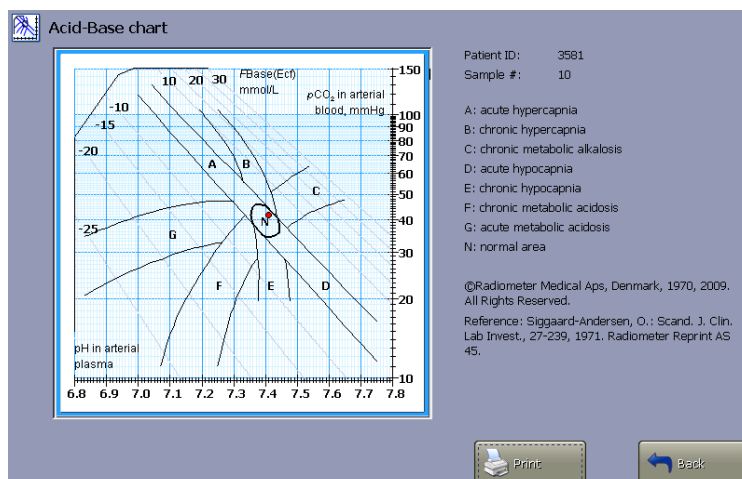

Press **Acid-Base chart**  on the **Patient result** screen to view the acid-base chart for the selected patient result (the button will not be available if pH and pCO_2 have been deselected in the Parameter setup).

The sample type should be either "Arterial" or "Capillary".

The chart illustrates the patient result according to the Siggaard-Andersen nomogram. The clinical conditions correspond to each of the eight zones listed to the right of the screen.

The point position is determined by the pH and pCO_2 values from the patient result. If the pH and pCO_2 values are outside the defined limits of the acid-base chart, the message "Measurement out of range" will appear on the chart in red and the **Print** button will disappear.

Available buttons	Press to...
Print	print out the displayed acid-base chart and the corresponding patient result, if available – see above. To print the acid-base chart automatically, activate the check button in the Patient reports setup, (see chapter 1: <i>Setup</i> in the ABL90 FLEX reference manual).
Back	to return to the patient result screen.

NOTICE: The information provided by the acid-base chart should only be used as a guideline for interpreting the patient's condition. Patient results must always be examined carefully by a clinician before a diagnosis is made.

**Patient result
audit trail**

Any changes made on the **Patient identification** screen will be registered in the audit trail function. The audit trail contains information about the operator who made the change, time of change and new/old values (changes made at the same time are indicated with "-" in the **Time** and **User** columns).

Messages on the screen is substituted with **Log** to indicate that changes were made.

Step	Action
-------------	---------------

-
- | | |
|-----------|---|
| 1. | Press Log on the Patient result screen to display the following buttons: Audit trail and Messages . |
| 2. | Press Audit trail . |
| 3. | Use the up/down arrows to scroll the list of changes. |
| 4. | Press Back to return to the Patient result screen. |

Patient result messages

Screen messages

Press **Messages** on the **Patient result messages** screen.

The **Patient result messages** screen gives the erroneous parameter(s) and the message(s) with number(s).

Messages can be seen on the following three levels:

User	Messages for the user familiar with the basic daily operation of the analyzer and primarily responsible for performing measurements. This level displays the fewest messages.
Manager	Messages for the user with a deeper knowledge of the analyzer functions and responsible for the analyzer's proper operation.
Service	Messages for the service technician with a thorough knowledge of the operation and construction of the analyzer. This level displays the greatest number of messages and in most detail.

The following buttons are available:

Result	Press to return to the Patient result screen.
Troubleshoot	Press to display the error description, operator actions and in some cases also a removal condition – see chapter 11: <i>Troubleshooting</i> in this manual and also chapter 10: <i>Analyzer messages</i> in the ABL90 FLEX reference manual for detailed information.
Print	Press to print out the screen message(s).
Back	Press to return to the previous screen.
Note	<p>Press to display the keyboard, type the note and confirm with Enter.</p> <p>If notes for patient result were entered in the User-defined notes program (see chapter 1: <i>Setup</i> in the ABL90 FLEX reference manual), select a note from the list with the up/down arrows.</p> <p>To edit a note, press Edit note and type the note on the keyboard.</p> <p>Remember to confirm it with Enter on the keyboard.</p> <p>To delete a note, press Delete note.</p>

5. Quality management

Automatic quality management system	5-2
General information.....	5-3
Built-in quality control	5-4
System checks	5-6
Analysis check	5-7
Manual quality control.....	5-8
Manual quality control.....	5-8
Additional quality control.....	5-12

Automatic quality management system

With the ABL90 FLEX quality management system, all necessary checks are done automatically and continuously by the analyzer.

If the result of the check is not acceptable, the analyzer automatically performs a corrective action, unless a user intervention/action is required.

Checks and corrective actions are logged in the activity log of the analyzer and can be obtained if documentation is needed.

The quality management system is based on the following checks:

- Built-in QC
- System checks
- Analysis check (performed before, under and after each activity)

Quality management is performed on six different solutions that are all built into the solution pack. Three solutions (CAL1, CAL2, CAL3) are used for calibration, analysis check and system check, and three solutions (QC1 (S9030), QC2 (S9040), and QC3 (S9050)) are used for quality controls.

General information

- Purpose** The purpose of quality control is to evaluate the performance of the analyzer to ensure the reliability, accuracy, and precision of patient sample results.
- Quality controls are run automatically on the built-in solutions in the solution pack.
- Furthermore, the ABL90 FLEX analyzer automatically performs periodic system checks and continuous analysis checks to provide further confidence in the fact that the analyzer is performing according to specifications (see descriptions later in this chapter).
- Built-in QC measurements are by default performed every 8 hours. Additional Quality controls should be run after all troubleshooting or preventive maintenance procedures that may alter the performance of the analyzer or whenever a service technician has doubts about the performance of the analyzer. It is also possible to run manual QC with glass ampoules and to start an unscheduled built-in QC measurement (see later in this chapter).
- QC should be performed according to:
- internal quality assessment procedures
 - local, state or federal regulation

Glossary list The following terms are used in the quality management:

Term	Explanation
Accepted result	A measurement value which falls within the statistics range.
Assigned value/ target value	The assigned value is the center value of the control range.
Control range	The range within which a measurement should fall. Typically the control range is set to be the mean \pm 2 SD (see section <i>Quality control setup</i> in chapter 1: <i>Setup</i> in the ABL90 FLEX reference manual). This range can be set by using the lot-to-date range (2 SD) calculated by the analyzer, or it may be user-defined.
Insert range	The upper and lower control ranges are established by Radiometer. On built-in QC they are given automatically when the solution pack is installed. On manual QC with glass ampoules they are found on the insert provided with each box of control solutions.
Lot-to-date range	A range calculated by the analyzer from measurements taken on a lot of a particular control solution. It is represented by mean \pm 2 SD.
Range of indication	The range for each parameter that the analyzer physically is capable of measuring. Refer to <i>Measured parameters</i> , chapter 13: <i>Specifications</i> for the analyzer range of indication for each parameter.
Statistics factor	The factor by which the control range is expanded (multiplied by) to determine the statistics range. The recommended statistics factor is 1.5.
Statistics range	The range within which a measurement must fall in order to be included in the quality control statistics. It is determined by multiplying the control range limits by the entered statistics factor. It is typical that the statistics range is set to the mean \pm 3 SD.

For detailed information on terminology and principles for the quality control systems, see *1 Appendix - Quality control* in the ABL90 FLEX reference manual.

Built-in quality control

Schedule Built-in QC measurements are by default performed every 8 hours (one on each level). The interval of these events can be defined by the user in the *Quality control schedule setup* program – see section *Quality control setup* in chapter 1: *Setup* in the ABL90 FLEX reference manual.

Built-in QC results are assigned to the slots A, B and C.

Acceptable ranges The assigned value and acceptance range for each parameter are entered automatically into the analyzer each time a new solution pack is installed.

Built-in QC measurement A scheduled QC measurement will start on time, provided that no calibrations are pending. A pending calibration will be performed before the scheduled QC measurement.

View built-in QC results Press **Result**:

- on the **Quality control identification** screen
- from **Menu > Analyzer status > Quality control**
- from the Quality control log

Quality control result		QC#	14	3/12/2009 02:10 PM
Sensor cassette lot:	42	Slot ID:	3 S7730	Lot # 99
Solution pack lot:	WL-07			
Blood gas values pH 7.085 [7.082 - 7.122] pCO ₂ 68.6 mmHg [60.6 - 70.6] pO ₂ 153 mmHg [135 - 155]		Electrolyte values cK ⁺ 1.9 mmol/L [1.6 - 2.2] cNa ⁺ 155 mmol/L [153 - 161] cCa ²⁺ 1.00 mmol/L [0.92 - 1.12] cCl ⁻ 120 mmol/L [113 - 125]		
Oximetry values ctHb 7.8 g/dL [7.2 - 8.2] sO ₂ 50.1 % [49.0 - 51.0] FO ₂ Hb 44.3 % [43.5 - 45.5] FCOHb 6.6 % [4.5 - 7.5] FMetHb 5.0 % [4.0 - 6.0]		Metabolite values cGlu 2.3 mmol/L [1.7 - 2.7] cLac 4.8 mmol/L [3.6 - 4.8]		
QC ID		Messages		Send
Calibration		Print		Back

The measured values are compared with the defined control range, statistics range and range of indication, and then given a status mark accordingly.

NOTICE: The user-defined corrections (slope and offset) do not influence the quality control results, unless the "Apply parameter corrections to QC" function has been activated in *Miscellaneous setup* – see chapter 1: *Setup* in the ABL90 FLEX reference manual.

Parameter status The absence of any markings next to a parameter indicates that a parameter was measured without fault.

Marking	Explanation
?	Error in the previous calibration, or analyzer malfunction.
W	A violated Westgard rule.
R	A violated RiLiBÄK rule.
↑ ↓	Parameter value is outside the control range, but inside the statistics range. Only the values within the statistics range are considered accepted and are included in the QC statistics.
↑ ↓	Parameter value is outside the statistics range and is not included in the statistics.
↑ ↓	Parameter value is outside the range of indication. Measurement is not included in the statistics.
*	Parameter values with user-defined corrections – see <i>Parameter setup</i> in section <i>Parameters and input setup</i> in chapter 1: <i>Setup</i> in the ABL90 FLEX reference manual for details.
.....	Parameter value could not be calculated, most likely due to a system error or malfunction. These values will for the most part be accompanied by a "?". To obtain a possible explanation, press Message .

To evaluate the analyzer quality control status at a glance, enter the **Analyzer status** screen. For further information about the analyzer quality control status see section *Quality control (QC)* in chapter 3: *Analyzer status*.

Unscheduled built-in QC measurement To start an unscheduled built-in QC measurement, do the following:

Step	Action
1.	Press Menu > Analyzer Status > Quality Control .
2.	Highlight the built-in QC solution to run an unscheduled measurement on.
3.	Press Start QC to start the measurement.

The Quality control result is shown after the measurement is completed.

Reference If the built-in QC results are outside the acceptable control ranges, follow the instructions on the **Troubleshooting** screen (the instructions are also given in Chapter 10: *Analyzer messages* in the ABL90 FLEX reference manual).

System checks

Description

The ABL90 FLEX analyzer performs system checks to verify that the individual components of the analyzer are functioning properly and according to specifications.

System checks are performed regularly and automatically. In this way the ready time is maximized and long-termed activities and frequent calibrations are avoided. It is not necessary for the user to make any additional checks if this is not requested by the analyzer.

If the system checks fail, they are in most cases retried, and, if possible, remedied automatically by the analyzer. If these system checks fail again, the analyzer enters the user-intervention-required or user-action-needed mode. This means that if any interventions/actions are required by the user, the **User Intervention Required** or the **User Action needed** screen appears with instructions on what to do to in the particular case.

The system checks consist of the following checks:

- Computer checks
- Software checks
- Mechanical checks
- Electronical checks
- Temperature checks
- Consumable integrity checks on time of installation

The system checks are performed at different times and with different intervals, depending on the checks that are to be performed. Some checks are performed once a day, some with every rinse, and others every 10 seconds.

For further information on the individual checks please refer to section *Quality management* in chapter 5: *Sensors and measuring technologies* in the ABL90 FLEX reference manual.

Analysis check

Description

During analysis – be it a patient sample analysis, a calibration or a QC measurement – the analyzer performs different checks automatically to verify that the analyzer is functioning properly before, under and after measuring activities.

If the analysis checks fail, they are in most cases retried, and, if possible, remedied automatically by the analyzer. If these analysis checks fail again, the analyzer enters the user-intervention-required or user-action-needed mode. This means that if any interventions/actions are required automatically or by the user, the **User Intervention Required** or the **User Action Needed** screen appears with instructions on what to do in the particular case.

The analysis checks consist of the following checks:

- Status calibrations/checks
- Sample integrity checks
- Temperature checks
- Mechanical checks
- Electronical checks
- Measurement preparation checks
- Consumable checks

The analysis checks are performed every second hour according to the default scheduled analysis activities (calibrations and QC measurements) and in connection with patient sample measurements.

For further information on the individual checks please refer to section *Quality management* in chapter 5: *Sensors and measuring technologies* in the ABL90 FLEX reference manual.

Manual quality control

As an alternative to built-in quality controls, you may analyze manual QC samples, if desired.

It is recommended to use QC material from Radiometer (the QUALICHECK5+ control system) to ensure an optimal performance of the analyzer and to take advantage of features such as temperature correction and automatic QC level detection. See *Appendix - Quality control* in the ABL90 FLEX reference manual.

It is possible to use non-Radiometer solutions although the accuracy and validity of the results cannot be guaranteed.

To assign a quality control solution to a specific slot or to change the quality control solution of a slot see *Manual quality control (QC) solutions* in section *Quality control setup* in chapter 1: *Setup* in the ABL90 FLEX reference manual.



NOTICE: Changing a control solution assigned to a slot will delete all current quality control statistics obtained on that slot. If you want a copy of the statistics for the last QC month, create a WDC Report – see chapter 2: *Disk Functions setup programs* in the ABL90 FLEX reference manual.

To schedule a QC measurement, see *Quality control schedule setup* in section *Quality control setup* in chapter 1: *Setup* in the ABL90 FLEX reference manual.

Required materials

QC system	Materials required
QUALICHECK5+	<ul style="list-style-type: none"> • Four levels of QC solutions (S7730, S7740, S7750, S7760) • QUALICHECK adapter • Rubber gloves • Ampoule opener

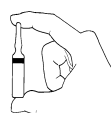
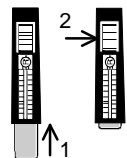
Before measurement on a control solution

Step	Action
1.	QC ampoules must be conditioned before measurement. Store the ampoules for 5 hours at a constant temperature between 18-32 °C. Control solutions are sensitive to light, so always keep the ampoule box closed.
2.	Hold the ampoule between two fingers as shown and shake it vigorously for at least 15 seconds. 
3.	Tap the top of the ampoule until all of the solution collects at the bottom.
4.	Place the ampoule in the ampoule opener and break off the ampoule neck. 
5.	Place the ampoule fully into the QUALICHECK adapter. 

6. Open-ampoule stability: To ensure the reliability of the measurement, each QC ampoule must be used immediately after opening, for **one** measurement on **one** analyzer.

Introducing a QC solution

Step	Action
------	--------

- | | |
|----|---|
| 1. | Check that the analyzer is in the Ready mode. |
| 2. | Lift the inlet to the syringe position. |
| 3. | Select Ampoule - QC . |
| 4. | Place the adapter tip against the inlet gasket and press it upwards. The probe extends into the ampoule and the QC solution is automatically aspirated. |

NOTICE: Be careful not to bend the probe.

Hold on to the adapter when removing the QC solution.

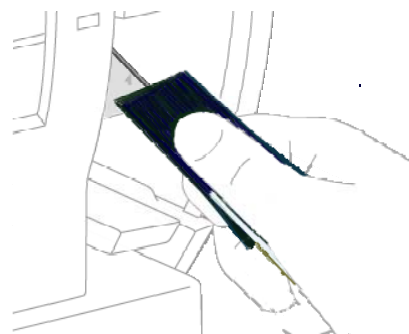

- | | |
|----|--|
| 5. | When prompted by the analyzer, remove the adapter and close the inlet. |
| 6. | Dispose of used ampoules as infectious waste*. |

* Clinical laboratory waste management. CLSI document GP5-A2.

Entering information with barcode reader

Step	Action
------	--------

- | | |
|----|---|
| 1. | Activate the "Enable general barcode support" check button in Miscellaneous setup, if not already done (Menu > Utilities > Setup > General setup > Miscellaneous setup). |
| 2. | Highlight the "Operator" field and scan "Operator" from your ID card (see <i>Barcode reader</i> in section <i>Hardware</i> in chapter 2: <i>What is what</i>). |

If the name is included in the list of the analyzer's registered users, the barcode automatically will identify the person and fill in the name.

Entering information manually

Step	Action
1.	<p>Highlight the item to be edited, using the up/down arrows.</p> <ul style="list-style-type: none"> • The solution is entered automatically. Choose the specific slot from the screen. • Lot is entered automatically if only one lot for each solution is used. Otherwise highlight the desired item on the screen and confirm with the Enter button.
2.	<p>Enter the ambient temperature (default: 25 °C) on the keypad and confirm with the Enter button.</p> <p>Mandatory entry is indicated by a .</p>
3.	<p>Enter "Department" on the keypad and confirm with the Enter button.</p>
4.	<p>Enter "Operator" on the keypad or keyboard and confirm with the Enter button (filled in automatically when operator is logged on).</p>

The measured values are compared with the defined control range, statistics range and range of indication, and then given a status mark accordingly.

NOTICE: The user-defined corrections (slope and offset) do not influence the quality control results, unless the "Apply parameter corrections to QC" function has been activated in *Miscellaneous setup* (see section *Miscellaneous setup* in chapter 1: *Setup* in the ABL90 FLEX reference manual).

View manual QC results

In most cases the **Quality control result** screen will be displayed automatically when the measurement has been completed. However, if the QC identification took longer time to enter than the measurement, you can press **Result**:

- on the **Quality control identification** screen
- from **Menu > Analyzer status > Quality control**
- from the Quality control log.

Parameter status

The absence of any markings next to a parameter indicates that a parameter was measured without fault.

For an explanation of possible parameter markings, please refer to *Parameter status* in section *Built-in quality control* earlier in this chapter.

Unknown solutions	Quality control on a solution, identified as unknown, are not compared with any previous measurements or statistics, and, therefore, do not receive any status marking. The parameter results for unknown levels cannot be plotted and are not included in any statistical data unless later changed to a defined slot.
Temperature corrections	<p>For QC solutions from Radiometer, temperature corrections are made automatically with the typed-in temperature.</p> <p>For non-Radiometer QC solutions, temperature corrections must be made manually. Refer to the manufacturer's literature for procedure.</p>
Reference	For a detailed explanation of the evaluation of results, refer to <i>Appendix - Quality control</i> in the ABL90 FLEX reference manual. If the results are outside the acceptable control ranges, please refer to Chapter 10: <i>Analyzer messages</i> in the ABL90 FLEX reference manual or follow the instructions on the Troubleshooting screen.
Recalling quality control identification	<p>To change data that can be edited (non-gray lettered) on the screen, press QC ID.</p> <p>NOTICES:</p> <ul style="list-style-type: none">• If leaving the Quality control identification screen without entering a temperature, the previous temperature will be recalled• Changing the temperature will initiate recalculation of the last result. It will be substituted by the recalculated result, and the statistics will also be recalculated. In case the temperature is mandatory, the result cannot be viewed until it is entered.

Additional quality control

If there is a need for more extreme QC values than those given in the built-in QC system or in the manual QUALICHECK5+ system, it is recommended to use the Metabolite+ QUALICHECK solution.

As the analyzer software will not recognize Metabolite+ QUALICHECK solution as a control solution, you have to select a blood mode before you introduce Metabolite+ QUALICHECK solution into the analyzer.

6. Calibration

General information.....	6-2
tHb calibration.....	6-4
Calibration result	6-5
Calibration verification	6-8

General information

- Purpose** The calibration process determines and checks the accuracy with which the analyzer measures its parameters. The process is therefore important in ensuring the reliability of results.
- Calibrations are performed with solutions and ambient air for each of the measured parameters.
- Calibration programs** All calibration results are automatically recorded in the Calibration log from which they can be viewed and printed. See section *Calibration log* in chapter 9: *Data management* for details.
- The calibration process and a detailed explanation of the terms are described in chapter 3: *Wet section* and chapter 5: *Sensors and measuring technologies* in the ABL90 FLEX reference manual.

Calling an unscheduled calibration

Step	Action
1.	Check that the analyzer is in the Ready mode.
2.	Press Menu > Start programs > Calibration programs and call a calibration.
	The following options are available:
	<ul style="list-style-type: none"> • calibration • tHb calibration
	If a button is grayed out, a calibration cannot be called.

Calibrations related to startups

Due to significant drift, the *cGlu*, *dLac*, *Oxi*, and *pCO₂* calibrations have a reduced validity time for the first 24 hours after cold starts and sensor cassette replacements.

The first 24 hours, the validity time of the *cGlu*, *dLac*, *Oxi*, and *pCO₂* calibrations gradually increases to 4 hours (the span between scheduled calibrations).

During the first 4 hours, no additional calibrations are scheduled, but a measurement takes up to 3 minutes because a calibration is performed with every measurement.

After 4 hours, calibrations are run in fixed intervals according to the table below and a measurement takes 35 seconds.

Time installed	Time between calibrations
0-4 hours	0 minutes (performed with every measurement)
4-6 hours	15 minutes
6-8 hours	30 minutes
8-12 hours	60 minutes
12-24 hours	240 minutes

If the analyzer is only turned off for a short period of time and certain preconditions are fulfilled, a warm start may be performed instead of a cold start. For further information about the warm start and the preconditions, see section *Warm start* in chapter 10: *Analyzer shutdown*.

Pending calibrations

A calibration is pending when a **scheduled** calibration cannot be performed at its scheduled time because the analyzer is occupied with another activity, e.g. measurement.

A pending calibration:

- is indicated by a clock symbol next to it on the ***Analyzer status > Calibrations*** screen as a warning
- will be performed 3 minutes after the analyzer has returned to the Ready mode and been without any activity. If more than one type of calibration are pending, the highest-priority calibration is performed. The calibrations are given in descending order of priority, the full calibration having the highest priority.

A scheduled QC measurement will be postponed until the calibration has been performed.

Expired calibrations

A calibration has expired and is considered invalid when:

- a sensor cassette is replaced
- If a calibration is 25 % overdue.

Under these conditions a "Cal expired (parameter)" message appears in the Activity and System messages logs, and the replaced item is also recorded in the Activity log. The analyzer status in the status bar is RED.

tHb calibration

Purpose This calibration is used to adjust the analyzer's optical system (cuvette factor and wavelength). It is recommended that a tHb calibration is performed every three months on S7770 ctHb Calibration Solution. The calibration can be included in the Calibration schedule.

Preparation

- Check that the analyzer is in the Ready mode
- Prepare an ampoule of S7770 ctHb Calibrating Solution, an QUALICHECK adapter and an ampoule opener

tHb calibration procedure

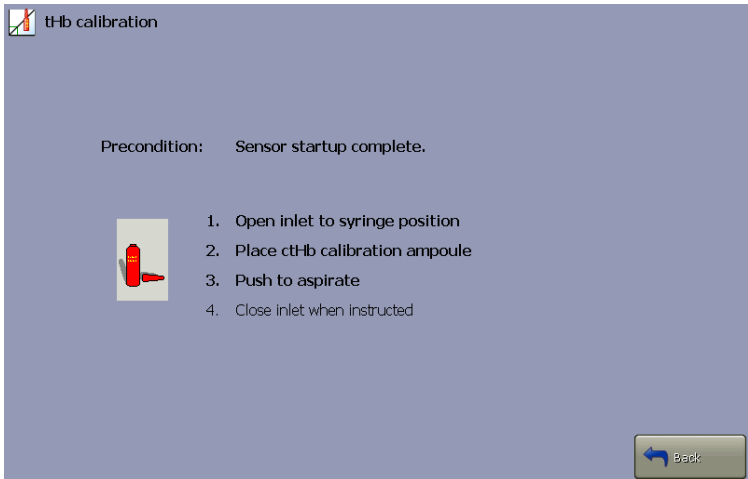
Step	Action
1.	Press Menu > Start programs > Calibration programs > Calibration to perform a calibration
2.	Press Menu > Start programs > Calibration programs > tHb calibration to perform the tHb calibration. Enter the barcode information from the S7770 insert, using the barcode reader (see <i>Barcode reader</i> in section <i>Hardware</i> , chapter 2: <i>What is what</i>) or the keyboard. To cancel the program, press Close .
3.	When the barcode has been accepted, the following screen appears. 
4.	Tap the top of the S7770 ampoule to collect the liquid at the bottom and break off the ampoule neck, using the ampoule opener.
5.	Place the ampoule fully in the QUALICHECK adapter.
6.	Place the adapter tip against the inlet gasket and press the adapter upwards. The probe extends into the ampoule and the S7770 ctHb Calibration Solution is automatically aspirated. NOTICE: Be careful not to bend the probe.
7.	When prompted by the analyzer, remove the adapter and close the inlet.
8.	If the calibration results are not accepted, remedy the error and perform a new tHb calibration.

Calibration result

Viewing a calibration result

The result can be viewed as soon as the calibration is completed. Results from the most recent calibration can be viewed via **Menu > Analyzer status > Calibration > Result** or via the Calibration log.

Calibration result

Calibration result			
Sensor cassette lot:	14	Cal #	264
Solution pack lot:	WL-07	Type:	BG, Elec, Met, Oxi, pH
pH	7.400 6.800	Status	10.0 mV
		Sens.	99.0 %
pCO ₂	39.8 mmHg 79.5 mmHg	Status	16.0 mV
		Sens.	91.9 %
pO ₂	146.3 mmHg 149.1 mmHg	Status	-5.2 mmHg
		Sens.	93 %
cK ⁺	4.0 mmol/L 10.0 mmol/L	Status	201.0 mV
		Sens.	98.0 %
cNa ⁺	140 mmol/L 70 mmol/L	Status	202.0 mV
		Sens.	97.0 %
cCa ²⁺	0.50 mmol/L 2.50 mmol/L	Status	203.0 mV
		Sens.	96.0 %

Button	Function
	Press to display the remainder of the calibration result.
Messages	Press to display the interpretation of any detected errors.
Print	Press to print out the result.
Send	Press to send the result to a connected RADIANCE or LIS/HIS system.

Calibration data are grouped together by parameter:

- Bold characters** Indicate data updated during this calibration.
- Gray characters** Black parameters origin from the last calibration and gray parameters may origin from multiple earlier calibrations.
- ?** Indicates an error or that the value is outside the recommended range, such as:
- Drift value outside the drift tolerances – shown as a message, not a value
 - Status outside the default limits
 - Sensitivity outside the default limits
-** Indicates that the value could not be calculated, most likely due to a system error or malfunction. These values will for the most part be accompanied by a "?". Press **Messages** for the explanation of the error.

tHb calibration result

Calibration result		Cal #	20	11/5/2009 11:39 AM
Sensor cassette run #:	3	Type:	tHb calibration	
Solution pack lot:	AP-04			
ctHb	Status	281.91 pA		
	Sens.	99.7 %		

Messages Send Print Back

Sens. (cuvette factor) is a factor that expresses the ratio of the effective light path of the analyzer cuvette to that of a reference cuvette determined by Radiometer.

The value should lie between 80% and 120% and have no errors, i.e. no "?" in it.

**Calibration
result
messages**

Press **Messages** on the **Calibration result** screen to display the **Calibration result messages** screen.

The message levels can be considered as a type of filter in which the messages displayed are based on the following:

Level	Explanation
User	Messages for the user familiar with the basic daily operation of the analyzer and primarily responsible for performing measurements. This level displays the fewest messages.
Manager	Messages for the user with a deeper knowledge of the analyzer functions and responsible for the analyzer's proper operation.
Service	Messages for the service technician with a thorough knowledge of the operation and construction of the analyzer. This level displays the greatest number of messages and in most detail.

Calibration verification

Purpose Regulations in some countries require verification of the reportable ranges selected for the measured parameters, and a special feature described below is provided to assist in the collection of this data.

Once the reportable ranges are established, the limits may be entered in the Reportable ranges program described in *Analysis setup*, chapter 1: *Setup* in the ABL90 FLEX reference manual.

Preparatory steps The following procedure is only a suggestion to easily identify your specific layout and measuring mode.

Step	Action
------	--------

1. Make a new report layout called, e.g. "Cal Verification", based on the Radiometer default layout – see *Patient report setup* in section *Analysis setup*, chapter 1: *Setup* in the ABL90 FLEX reference manual.

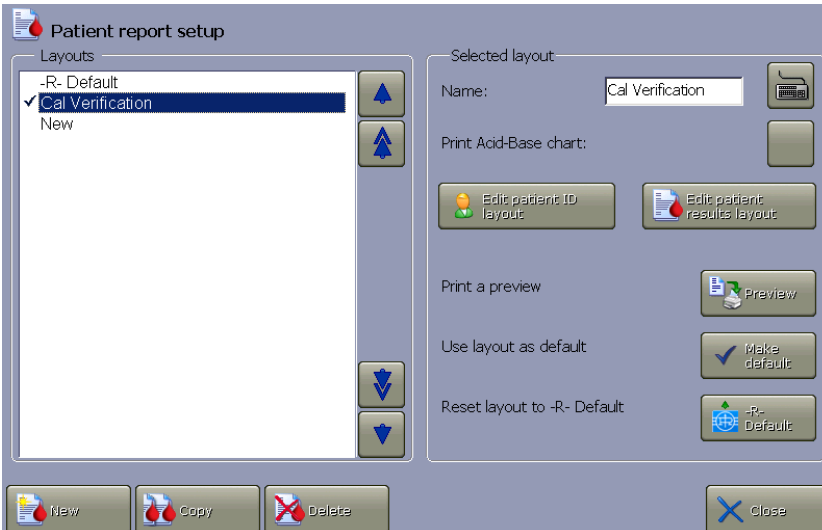
2. 

Press **Edit patient ID layout** and deselect all items except Patient ID and Sample type. Press Back to return to the **Patient report setup** screen.

3. Press **Edit patient results layout** and deselect all parameters except the measured parameters. Deselect the showing of ranges for all parameters.

Step Action

4.  Syringe modes setup

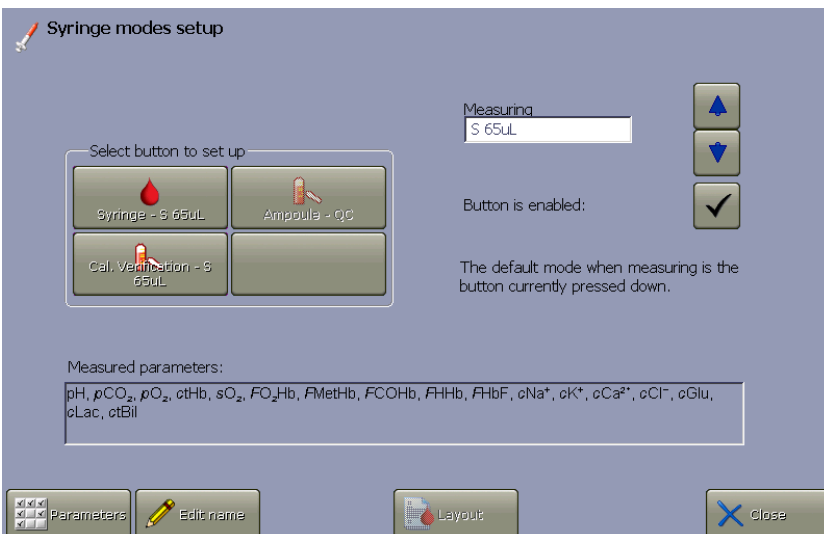

In **Menu > Setup > Analysis setup > Syringe modes** dedicate one unoccupied button to "Cal. Verification" by pressing an unoccupied button in the "Select button to set up" field and activating the "Button is enabled" check button.

Select the desired parameters (press **Parameters**) and layout (press **Layout**) that you have made in step 1 above.

5. Condition Radiometer QC solutions – see section *Manual quality control* in chapter 5: *Quality management* of this manual.
6. Immediately proceeding to the analysis, hold the ampoule between two fingers and shake it vigorously for at least 15 seconds.
7. Tap the top of the ampoule until all of the solution collects at the bottom.
8. Place the ampoule in the ampoule opener and break off the ampoule neck.
9. Place the ampoule fully into the QUALICHECK adapter.
10. Open-ampoule stability: To ensure the reliability of the measurement, each QC ampoule must be used immediately after opening, for **one** measurement on **one** analyzer.

Verification procedure

- | Step | Action |
|------|---|
| 1. | Check that the analyzer is in the Ready mode. |
| 2. | Lift the inlet to the syringe position. |
| 3. | Select the Cal. Verification mode on the screen. |
| 4. | Place the adapter tip against the inlet gasket and press it upwards. The probe extends into the ampoule and the QC solution is automatically aspirated. |
| | NOTICE: Be careful not to bend the probe.
Hold on to the adapter when removing the QC solution. |
| 5. | When prompted by the analyzer, remove the adapter and close the inlet. |

5.

The screenshot shows the 'Patient identification' screen. At the top, it displays 'Sample # 11' and '9/17/2009'. Below this is a table with two columns: 'Sample type' and 'Cal. Verification'. The 'Sample type' column lists 'Patient ID', '7', 'Operator', and 'Note'. The 'Cal. Verification' column lists '37.0 °C' and 'Radiometer'. To the right of the table is a numeric keypad with buttons for digits 0-9, a decimal point, and navigation arrows. A 'Result' button is located at the bottom right of the screen.

Enter the information on the **Patient identification** screen.

Use a dedicated identifier for each solution (e.g. Level 1) as Patient ID.

- After all measurements on the calibration verification solutions have been completed, review the data by filtering it in the Patient results log or transfer the data to a data analysis program – see *Exporting data logs* in chapter 2: *Disk functions setup programs* in the ABL90 FLEX reference manual.
- After the new reportable ranges have been determined, enter any changes in the *Analysis setup* program: *Reportable ranges* (see chapter 1: *Setup* in the ABL90 FLEX reference manual).

Once the first measurement in this mode has been performed, the mode is available for the next 7 days. During this time you can verify your reportable ranges according to the procedure used in your institution. After 7 days the mode will not be available for the next 14 days.



7. Replacements

Screens during replacements	7-2
Replacements.....	7-3
Solution pack	7-4
Sensor cassette	7-5
Printer paper	7-9
Inlet.....	7-10
Cleaning the analyzer	7-16

Screens during replacements

The screens during replacements have an animation on the left side of the screen and the activities/operator actions on the right side of the screen.

General remarks:

	An arrow indicates a procedure in progress.
	The triangle with an exclamation mark indicates a precaution where operator action should be taken.

Replacements



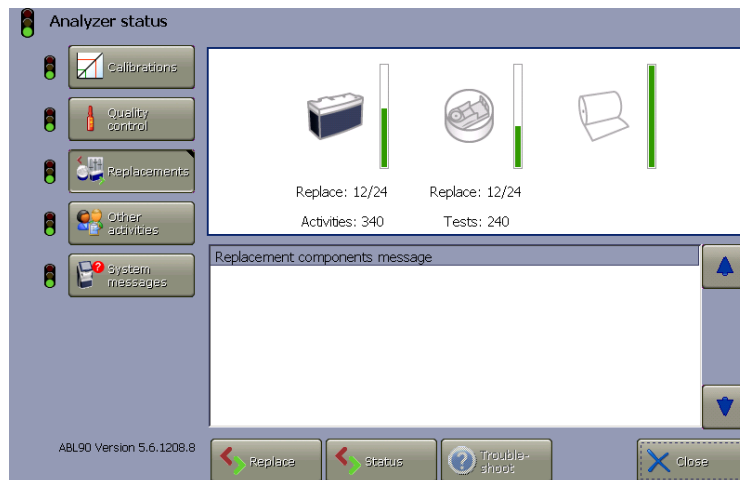

Viewing replacement status

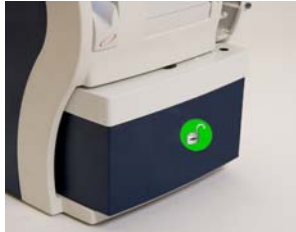

Step	Action
1.	Press Menu > Analyzer status > Replacements > Status .
2.	Choose one of the following options: <ul style="list-style-type: none"> • Send status to printer: For a printout of the consumables status, showing the replacement information of the solution pack and the sensor cassette, such as date of installation, scheduled replacement date, reason for the replacement, time for next replacement, expiration date, number of blood and QC measurements performed and number for samples remaining. • Sensor status: Shows replacement information, such as date of installation, scheduled replacement date, reason for the replacement, time for the next sensor cassette replacement, when a new sensor should be conditioned, how many tests have been performed and when the sensor cassette expires. • Solutions status: Shows replacement information, such as date of installation, scheduled replacement date, reason for the replacement, time for the next solution pack replacement, the lot number of the solution pack, how many activities have been performed and when the solution pack expires.
3.	Press Back to return to Analyzer Status screen.
4.	Press Close to return to the main screen.

Solution pack

Replacing solution pack

Step	Action	
1.	Press Menu > Analyzer status > Replacements > Replace > Replace solutions.	
2.	Lift the inlet to the capillary position and wait for the solution pack to unlock.	
3.	Remove the used solution pack and dispose of it as infectious waste according to the regulations in your institution.	
4.	Activate the new solution pack by pulling out the safety pin.	
5.	Press the lid firmly down by pressing the elevated side (where the safety pin was) totally down until the side taps click into the side tap holes.	 <p>Side taps holes</p> <p>Side taps</p>
6.	Remove the top layer of the label on top of the solution pack, so that the biohazard label appears to remind you that the solution pack after use must be disposed of as infectious waste.	
7.	Insert the new solution pack by pushing it fully into place in the analyzer until a click is heard.	
8.	When prompted by the analyzer, close the inlet.	
9.	Enter operator name and any notes, using the Keyboard or the Note button to display the keyboard and to enter the operator name/note. Confirm the entry with the Enter button on the keyboard.	

10. Press **OK** to restart the analyzer.

NOTICE: By default a QC will be performed after a solution pack replacement. However, if this function has been deactivated, it is recommended to perform a built-in QC after solution pack replacements to assure that the consumables have not been damaged.

Manual release of the solution pack In emergency situations, e.g. during a power failure or if for some reason the analyzer is down, it is possible to release the solution pack by pressing the latch on the rear of the analyzer. See *Rear* in section *Hardware*, chapter 2: *What is What*.

Sensor cassette

From the factory, the sensor cassette comes dry-stored in the sensor cassette pack to ensure a long shelf life. Therefore, a conditioning process where rinse solution is released to the sensors must occur before the sensor cassette can be used for measurements.

When conditioning the sensor cassette in the analyzer, it typically takes 2-4 hours (including a calibration) for the sensor cassette to be ready for measurement.

If the conditioning by the analyzer is interrupted by the user by pressing **Exit conditioning**, some of the parameters may subsequently have a "?" in front of them.

Replacing sensor cassette	Step	Action
	1.	Press Menu > Analyzer status > Replacements > Replace > Replace sensors .
	2.	Register the sensor cassette <ul style="list-style-type: none"> • by scanning the barcode of the sensor cassette pack (see <i>Barcode reader</i> in section <i>Hardware</i>, chapter 2: <i>What is what</i>). • by entering the barcode manually by pressing the keyboard button and entering the missing numbers of the barcode of the sensor cassette. Confirm with Enter and press Continue. If no barcode is available, press No Barcode in the "Registration" field. Thereafter, press the  button. <p>The sensor cassette compartment opens.</p>

3. Remove the old sensor cassette by pulling it upwards and out of the compartment with thumb and index finger. Dispose of the used sensor cassette as infectious waste according to the regulations in your institution.



4. Remove the foil on top of the sensor cassette pack by pulling the foil upwards and off.



5. Screw off the revealed lid of sensor cassette pack, by screwing it off counterclockwise.



6. Remove the new sensor cassette by pulling it out of the sensor cassette pack with thumb and index finger.

Place the biohazard label found in the sensor cassette pack on the sensor cassette to remind you that the sensor cassette must be disposed of as infectious waste after use.



7. Holding the new sensor cassette with the thumb and index finger, press the new sensor cassette firmly into the sensor cassette seat in the sensor compartment until resistance is met.



8. Press **Proceed**. The sensor cassette compartment closes and a new **Replacing sensor cassette** screen appears.
9. Enter operator name and any notes, using the **Keyboard** or the **Note** button to display the keyboard and to enter the operator name/note. Confirm the entry with the **Enter** button on the keyboard.
10. Press **OK** to finish or press **Replace solutions** to replace the solution pack too – see *Solution pack* earlier in this chapter.
11. Wait until the restart sequence has been finished.

- NOTICES:**
- By default, a QC will be performed after a sensor cassette replacement. However, if this function has been deactivated, it is recommended to perform a built-in QC after sensor cassette replacements to assure that the consumables have not been damaged.
 - It is only recommended to remove the sensor cassette from the sensor cassette compartment if you want to replace the old sensor cassette with a new one. If, however, it becomes necessary to remove it for a short period of time (e.g. during a troubleshooting procedure etc.), the sensor cassette must be placed back into the sensor cassette compartment within 2 hours. During removal it must be placed in an upright position and not on the side:

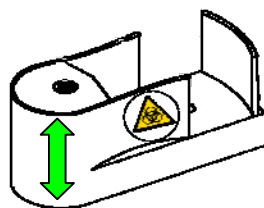

Startup after sensor cassette replacement

The calibration status is checked 1, 2 and 3 hours after sensor startup, e.g. after replacements or when the power is turned on.

If a parameter (except for the oximetry parameters) is marked with a "?", a re-calibration of the relevant parameter is performed if the analyzer is in the ready mode.

The internal QC status is checked 1, 2 and 3 hours after sensor startup, and once every 4 hours after any calibration performed. The calibrations are scheduled every 4 hours and the 4-hours checks continue up to 24 hours after sensor startup.

If a built-in QC level is marked with a "?" for a given parameter (except for the oximetry parameters) and the calibration status is OK, the relevant QC levels are re-scheduled and performed according to the schedule.

These checks accelerate the time for all parameters being ready after a sensor cassette replacement. The parameters are ready when there is a green traffic light in the analyzer status.

Printer paper

Replacing printer paper

NOTICE: Avoid contact of paper with direct sunlight, water, high temperature and humidity, alcoholic and organic solvents, PVC-containing materials, freshly developed diazo copy sheets, extensive pressure and scratching. For storage, use folders and cases made of polyethylene, polypropylene, polyester or similar material.

Step	Action
1.	Press Menu > Analyzer status > Replacements > Replace > Replace paper.
2.	Press the release button to unlock the lid. Open the lid by pressing it backwards and remove any leftover paper from the printer.
3.	Place the new roll in the printer so that the paper unreels from underneath the roll. Align the paper roll in the middle of the printer.
4.	Make sure that some of the paper will extend out of the printer, when the cover is closed. Then close the cover by pulling the cover forwards and pressing it down until a click is heard.
5.	Press Replaced to enter operator name and any notes, using the Keyboard or the Note button to display the keyboard. Confirm the entry with the Enter button on the keyboard.
6.	Press OK to exit to the main screen.

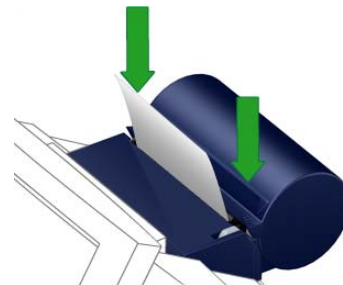
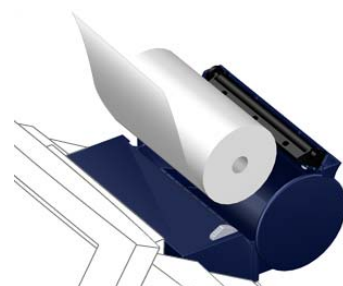
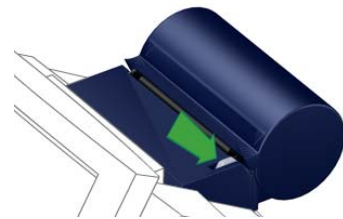

Inlet

Replacing the inlet

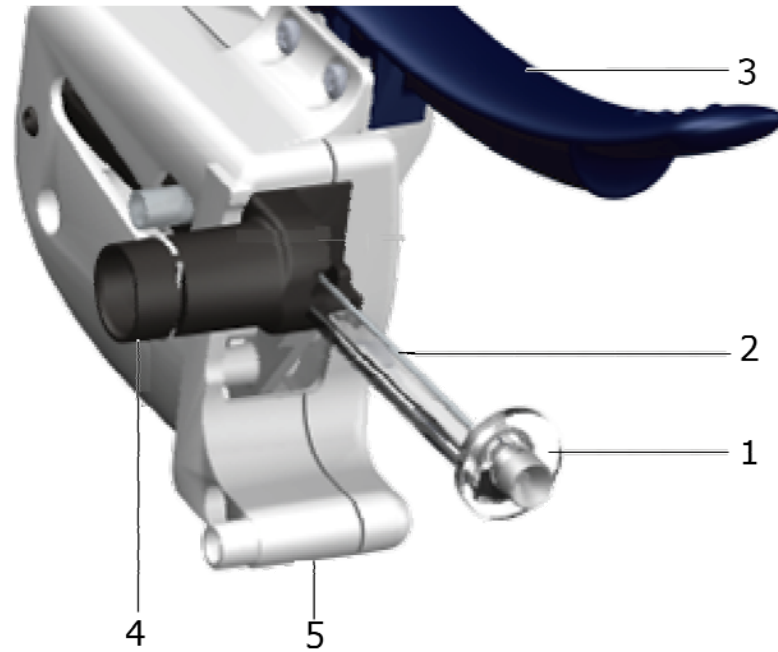

Part	Function
1	Holder with inlet gasket
2	Inlet probe
3	Inlet handle
4	Black inlet connector
5	Back piece of the inlet

Step Action

1. Pull off the inlet cover as shown.



2. Lift the inlet handle to syringe position (the middle LED lights up).

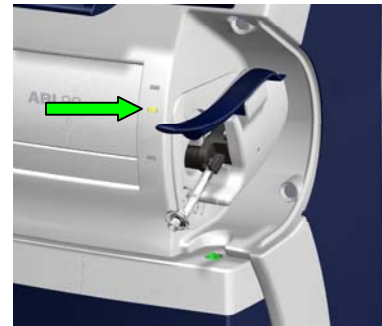

3. Pull off the inlet.
Dispose of the used inlet as infectious waste according to the regulations in your institution.



4. Take the new inlet.
Place your thumb and index finger as shown and press the two parts together.

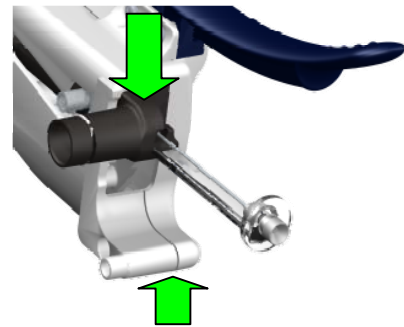

5. While pressing the two parts together, put the black inlet connector over the pin in the recess until a click is heard.



6. Put the inlet handle in the closed position and remount the cover.

Replacing inlet probe/gasket

Step Action

1. Pull off the inlet cover as shown.



2. Lift the inlet handle to syringe position (the middle LED lights up).

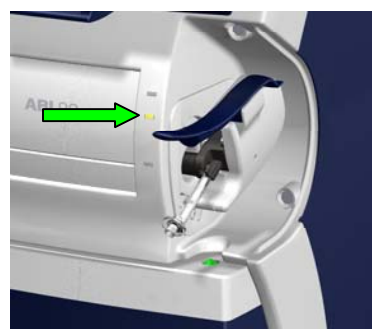

3. Pull off the inlet.



4. Pull out the holder.



CAUTION – Risk of infection

Be aware that the inlet gasket has been in contact with blood and should be handled as potentially infectious.

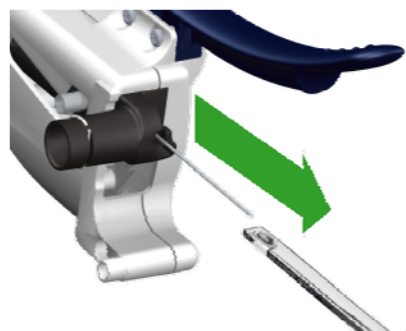

5. Lift the probe 90° upwards and remove it from its recess.



CAUTION – Risk of infection

Be aware that the probe has been in contact with blood and should be handled as potentially infectious.

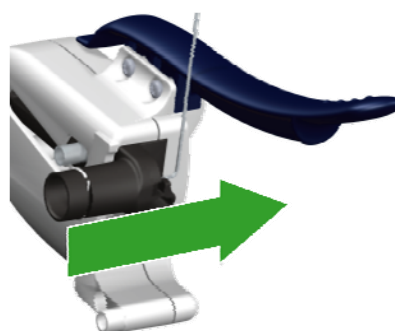

- 6. Insert the probe into its recess and place it back into normal position.

- 7. Remount the holder by inserting it into the inlet holder hole, just beneath the probe, and placing the probe in the inlet gasket, making sure that it can move freely through the gasket.

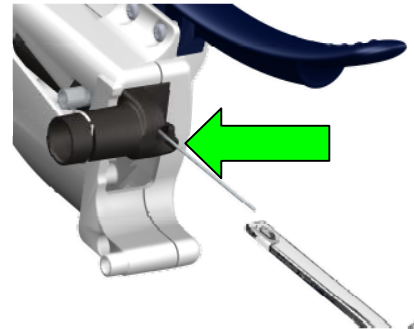

- 7. Place your thumb and index finger as shown and press the two parts together.

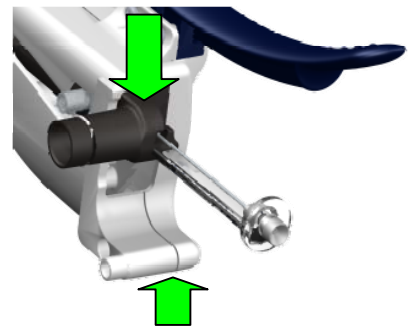

- 8. While pressing the two parts together, put the black inlet connector over the pin in the recess until a click is heard.



- 9. Put the inlet handle in the closed position and remount the cover.

Replacing the inlet connector gasket

Step

Action

- 1. Pull off the inlet cover as shown.



2. Lift the inlet handle to syringe position (the middle LED lights up).

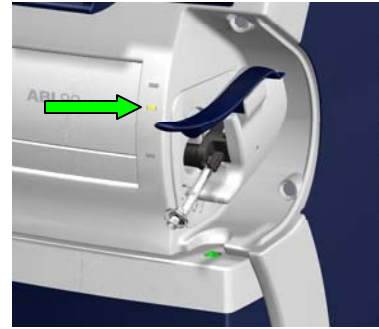

3. Pull off the inlet.



4. Remove the gray gasket by pulling it out.
Dispose of the used gasket as infectious waste according to the regulations in your institution.



5. Put a new gasket into the hole and press it firmly into position.
NOTICE: To reduce the friction you can apply demineralized water or alcohol to the gasket before putting it into the inlet connector hole.



6. Place your thumb and index finger as shown and press the two parts together.

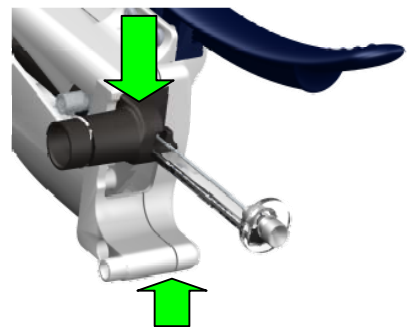

7. While pressing the two parts together, put the black inlet connector over the pin in the recess until a click is heard.



8. Put the inlet handle in the closed position and remount the cover.

Cleaning the analyzer

The analyzer surfaces should always be kept clean of blood and/or other liquids. Immediately clean all surfaces if they become contaminated with blood or other liquids.

Cleaning the inlet

Step	Action
1.	Press Menu > Analyzer status > Other activities > Inlet check .
2.	Clean the inlet gasket (see step 3 below), the inlet area and the handle as required.
3.	Remove the inlet gasket with holder and the probe from the inlet (see above). Soak the inlet gasket with holder and the inlet probe in a Deconex cleaning solution or a similar detergent. (Deconex cleaning solution is used in soaking baths and ultrasonic cleaning systems for cleaning laboratory utensils and precision components to remove moderate to most resilient contamination of an organic nature.) NOTICE: Do not inject Deconex cleaning solution into the analyzer as this will damage the sensors.
4.	Rinse thoroughly with demineralized water to remove all Deconex cleaning solution (or similar detergent).
5.	Remount the inlet gasket with holder and the inlet probe. Check that the inlet probe is in the correct position.
6.	Remount the inlet (see above) and close it.
7.	Press Done .

Cleaning the sensor cassette seat

When cleaning the sensor cassette seat in the sensor cassette compartment, use a bended dental soft pick to clean the connector holes in the sensor cassette seat.

NOTICE: Cotton swabs may leave cotton fibers in the connector holes, which again may lead to leakages between the sensor cassette and the sensor cassette seat.

Cleaning the analyzer exterior

When cleaning the analyzer covers and outer case, use soapy water or a mild detergent.

Do not use abrasive cleansers or pads, ethanol-based substances or aggressive detergents for cleaning.

Cleaning the analyzer screen**Step Action**

1. Put your thumb at an inactive place on the screen, e.g. on the Ready text in the upper left corner of the main screen and keep the thumb pressed against the screen.
2. Use a dry or lightly dampened soft lint-free cloth to clean the screen. Wipe the screen gently to remove fingerprints and/or dirt. To avoid streaking, an approved screen cleaner is recommended.
3. If you need to clean the place where you put your thumb, find another inactive place on the screen and put your thumb there.

Disinfection of outer surfaces

Disinfection of the outer surfaces is performed when appropriate. The frequency depends on local requirements and on the use of the analyzer.

Prior to disinfection, always ensure that that analyzer surfaces are clean and without residues from blood and/or liquids.

NOTICE: Follow legal and local rules for safe work practices with chemicals.

Wipe the outer surfaces of the analyzer and the touch screen, using a disinfectant on a paper towel or tissue.

Disinfectants to use:

70 % isopropyl alcohol

70 % ethanol

4 % Diversol BX

8. Disk functions

General information.....	8-2
--------------------------	-----

General information

Disk functions programs To access the Disk functions setup programs, press **Menu > Utilities > Disk functions**.

The following programs are available by pressing a corresponding button.

Button	Function
WDC report	To make a Worldwide DATACHECK report.
Backup all data	To make a backup of all data. Data is stored as a backup at a designated location.
Restore all data	To restore a backup of all data files to the analyzer's internal disk from a designated location.
Export data logs	To export selected records from selected data logs.
Import/ Export archives	To import externally archived data logs. To export or delete archived data logs.
Save setup	To save the current setup of your analyzer.
Load setup	To load a previously saved setup. NOTICE: Radiometer recommends that you only load a setup when the analyzer is in the Ready mode. Otherwise, this may result in a cold start. For further information about cold starts, see section <i>Calibrations related to startups</i> in chapter 6: <i>Calibration</i> .
Restore default setup	To restore all or only some Radiometer default settings.

For further information about the Disk functions setup programs see chapter 2: *Disk functions setup programs* in the ABL90 FLEX reference manual.

9. Data management

General information.....	9-2
Patient results log	9-3
Patient profiles log	9-6
Quality control log.....	9-9
Calibration log	9-15
Activity log.....	9-18
Replacement log	9-20
Archived data logs.....	9-21
RADIANCE browser (optional)	9-23

General information

Access to data logs To access data logs, press *Menu > Data logs*.

Data log	Contains...
Patient results log	Up to 2000 patient reports from which you can view patient reports, print and/or send patient reports, search for a patient report, and make a parameter trend for the selected patient reports.
Patient profiles log	A list of patient profiles, i.e. general information about patients, from which you can find and view patient profiles, add, edit or remove a patient profile.
Quality control log	Up to 2000 QC results from which you can view QC results, view statistics and plots of results, print and/or send results, search for a particular result, and make a parameter trend for the selected QC results.
Calibration log	Up to 1000 calibration results from which you can find and view results, make a parameter trend for the selected calibrations, print and/or send results.
Activity log	Up to 5000 records of all measurements, replacements, system messages and operator messages. From the log, you can search for an activity, add an operator message, print and/or send records.
Replacement log	Shows the replacement records of the activity log, which can be printed. For the record "Sensor cassette removed", you can for diagnostic use generate a printout with sensor cassette data, system messages, and data about the latest calibration and built-in QC before replacement.
Archived data logs	Old patient reports, QC results, calibration results and activities that have been archived when the above-mentioned log sizes have been reached. The archives are archived after date – 500 reports from each log and 2000 entries from the Activity log.

NOTICE: The total number of results and messages in a log can be changed to suit your needs. An increase in the total number will require more space and possibly additional disks when backing up data. Contact a qualified service technician for details.

Archived data logs To avoid loss of "old" data, it can be archived into respective archived data logs. Press *Menu > Data logs > Archived data logs* to access the archived Patient results log, Quality control log, Calibration log and Activity log.

Patient results log

Purpose The Patient results log is a historical file of patient reports automatically saved in the Patient report log after a measurement.

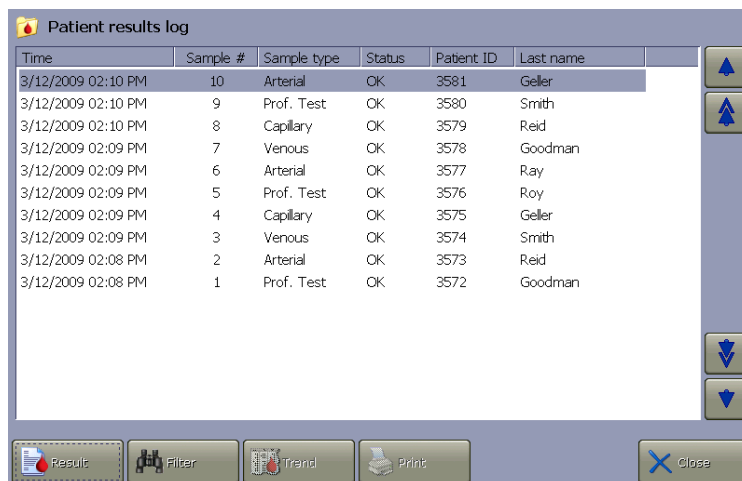

Each patient result is identified by:

Time	Date and time of the sample measurement.
Sample #	Sample number.
Sample type	Blood sample type specified in Patient ID.
Status	Status of the sample measurement: <ul style="list-style-type: none"> • "OK" = a successful measurement • "?" = an error detected or a parameter exceeded the reportable range • "Interrupted" = a measurement stopped by the operator "Aborted" = a measurement stopped by the analyzer, most likely due to insufficient sample
Patient ID	Patient identification number.
Last name	Patient's last name.

Functions The following functions are available by activating a button:

Result	Displays the highlighted patient report – see chapter 4: <i>Sample measurement</i> for detailed information.
Filter	See below.
Trend	Is inactive until the filter criteria are chosen and applied - see below.
Print	Is inactive until the filter criteria are chosen and applied. Starts printing the list.
Close	Returns to the main screen.

Filter function The function is used to set the filter criteria to find a patient report or to select a number of patient reports.

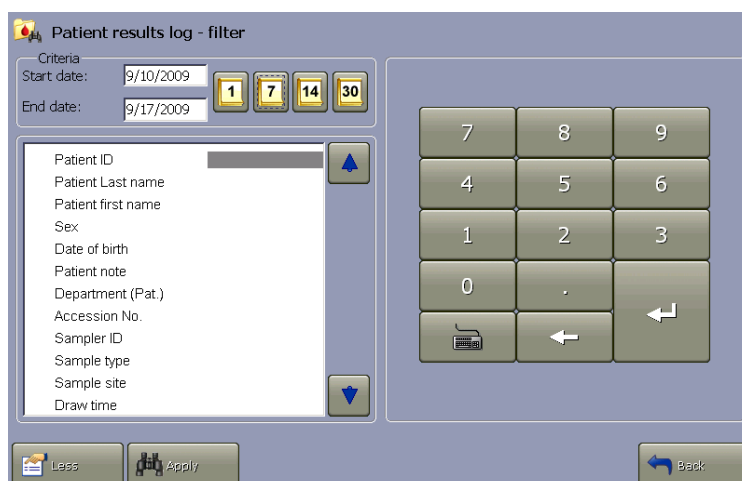

Step	Action
------	--------

- | | |
|----|--|
| 1. | Set the "Start date": Use the 1-day, 7-day, 14-day or 30-day icons in the "Criteria" box or type in the date, using the keypad and confirming the entry with Enter . |
| 2. | Change, if necessary, the "End date" by highlighting it and typing in a date other than the current date. Confirm with Enter . |
| 3. | Use the up/down arrows to highlight the desired filter criteria. Press More to display more filter criteria (note that the right side of the screen changes to show choices for the highlighted search criteria). |
| 4. | Select the desired criteria and confirm each entry with Enter . Or use the keyboard to enter the desired data and confirm each entry with Enter . |
| 5. | Press Apply to start the search (filter). |
| 6. | View the search results on the screen. |
| 7. | Press Back to return to the previous screen. |

Trend function This function is used to make a trend of the selected parameters for a patient (after filter criteria have been applied).

Step	Action
-------------	---------------

-
- | | |
|-----------|--|
| 1. | Set up search criteria as described under <i>Filter function</i> and apply them. The filtered patient results will be displayed and Trend and Print will now be active. |
| 2. | Press Trend to select the parameter(s). |
| 3. | Press View trend to display the trend of the selected parameter(s) for the selected patient reports. The Patient result log – trend screen is shown. |
| 4. | Press View filter to view the selected filter criteria (the criteria cannot be changed, only viewed).

To apply new criteria, repeat the Filter function and the Trend function procedures. |
| 5. | Press Back to return to the previous screen. |

Patient profiles log

About a patient profile A patient profile is a record containing general information about a particular patient. It is created automatically whenever a new patient ID is entered **during measurement** and recorded in the Patient profiles log. Alternatively, a patient profile can be added to the log. It is required to include patient data in the log before the patient pre-registration function can be used.

The patient data recorded in a patient profile will automatically be used as soon as the patient ID number is entered on the **Patient identification** screen during a measurement.

Patient profiles log The patient profiles are listed in the order they have been created.

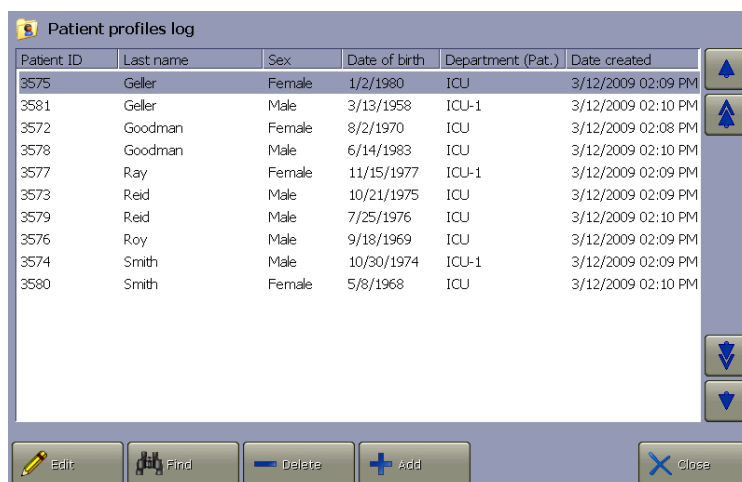

The screenshot shows a window titled "Patient profiles log" with a table containing the following data:

Patient ID	Last name	Sex	Date of birth	Department (Pat.)	Date created
3575	Geller	Female	1/2/1980	ICU	3/12/2009 02:09 PM
3581	Geller	Male	3/13/1958	ICU-1	3/12/2009 02:10 PM
3572	Goodman	Female	8/2/1970	ICU	3/12/2009 02:08 PM
3578	Goodman	Male	6/14/1983	ICU	3/12/2009 02:10 PM
3577	Ray	Female	11/15/1977	ICU-1	3/12/2009 02:09 PM
3573	Reid	Male	10/21/1975	ICU	3/12/2009 02:09 PM
3579	Reid	Male	7/25/1976	ICU	3/12/2009 02:10 PM
3576	Roy	Male	9/18/1969	ICU	3/12/2009 02:09 PM
3574	Smith	Male	10/30/1974	ICU-1	3/12/2009 02:09 PM
3580	Smith	Female	5/8/1968	ICU	3/12/2009 02:10 PM

At the bottom of the window, there are buttons for Edit, Find, Delete, Add, and Close. The table also has vertical scroll bars on the right side.

The following data can be entered in a patient profile (use the left/right scroll bar to see the items):

- Patient ID
- Last name
- First name
- Sex
- Date of birth
- Department (Pat.)
- Patient note
- Birth weight
- Gestational age

NOTICE: If the analyzer is set up to request data from LIS/HIS or the RADIANCE system, these data will always override those from the Patient profiles log.

Editing a patient profile



Step	Action
------	--------

- | | |
|----|---|
| 1. | Highlight the desired patient profile and press Edit on the Patient profiles log screen. |
| 2. | <ul style="list-style-type: none"> Use a barcode reader (see <i>Barcode reader</i> in section <i>Hardware</i>, chapter 2: <i>What is what</i> in this manual) to scan the patient data that are supported by the barcode (the "Enable general barcode support" should be activated in the Miscellaneous setup) – see the procedure in <i>Entering information with barcode reader</i>, chapter 4: <i>Sample measurement</i>, section <i>Entering patient identification</i> in this manual. <p>Or</p> <ul style="list-style-type: none"> Request (if connected) the data from the RADIANCE or LIS/HIS system by verifying the patient ID and pressing Request. |
| 3. | Highlight an item using the up/down arrows and type in the data, using the screen keyboard or keypad. Confirm each entry with Enter or Select . |
| 4. | When completed, press Back to return to the previous screen. |

Adding a new patient profile

Step	Action
------	--------

- | | |
|----|---|
| 1. | Press Add on the Patient profiles log screen. |
| 2. | Follow steps 2-4 in the <i>Editing a patient profile</i> procedure to add a new patient profile. |

Deleting a patient profile

Step	Action
------	--------

- | | |
|----|--|
| 1. | Highlight the desired patient profile on the Patient profiles log screen. |
| 2. | Press Delete . |

Finding a patient profile

Step	Action
1.	Press Find on the Patient profiles log screen.
2.	<ul style="list-style-type: none">• Highlight the search criterion and enter the data, using the screen keypad or keyboard. Confirm with the Enter button. Or – <ul style="list-style-type: none">• Use a barcode reader to scan the patient ID barcode (the "Enable general barcode support" should be activated in the Miscellaneous setup) (see <i>Barcode reader</i> in section <i>Hardware</i>, chapter 2: <i>What is what</i> in this manual).
3.	Press Find . <ul style="list-style-type: none">• If a patient profile is found, it will be highlighted on the Patient profile log screen• If a patient profile is not found, the "No item found that matches search criteria" message appears in analyzer status. Repeat step 2 - 3 or press Back to cancel.

NOTICE: The patient data entered in the Patient profiles log is also used for sample pre-registration during a measurement.

Quality control log

Purpose The Quality control log is a historical file of all QC results automatically saved in the Quality control log after a measurement.

Each QC result is listed in reverse chronological order as an individual record (with the most recent result at the top of the screen).

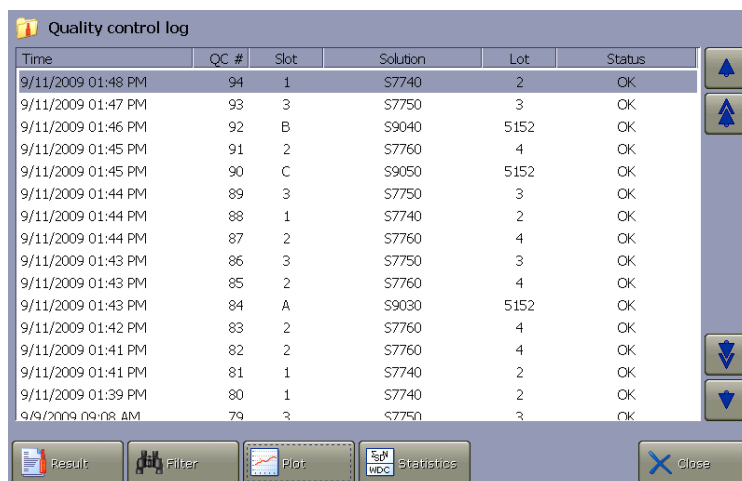

Each result is identified as follows:

Time	Date and time that the measurement was performed.
QC #	The ID number of a QC measurement.
Slot	QC solution slot as defined in the setup.
Solution	QC solution type as defined in the setup.
Lot	Lot number of the QC solution.
Status	Indicates the status of the QC measurement: <ul style="list-style-type: none"> • "OK" = a successful measurement • "?" = an error detected or a measured value exceeded a control or statistical range or range of indication. • "Interrupted" = a measurement stopped by the operator • "Aborted" = a measurement stopped by the analyzer, most likely due to insufficient sample

The following functions are available by activating a button:

Result	Displays the highlighted QC result – see chapter 4: <i>Sample measurement</i> for detailed information.
Filter	See below.
Plot	See below.
Statistics	See below.
Close	Returns to the main screen.

Quality control plot

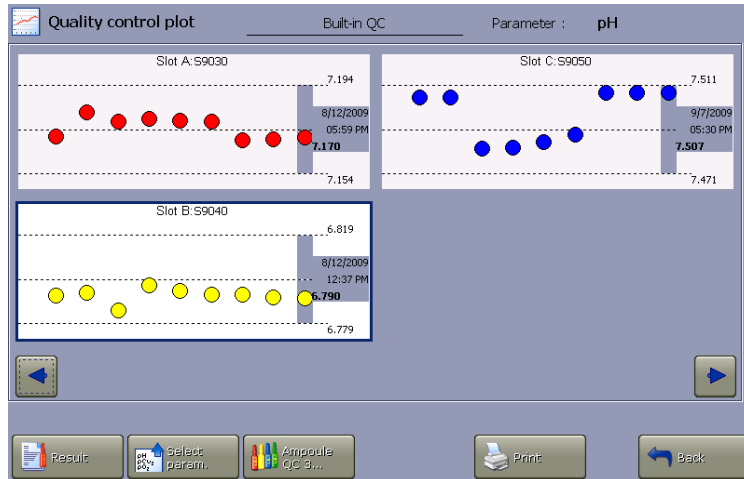

The details of a typical plot are as follows:

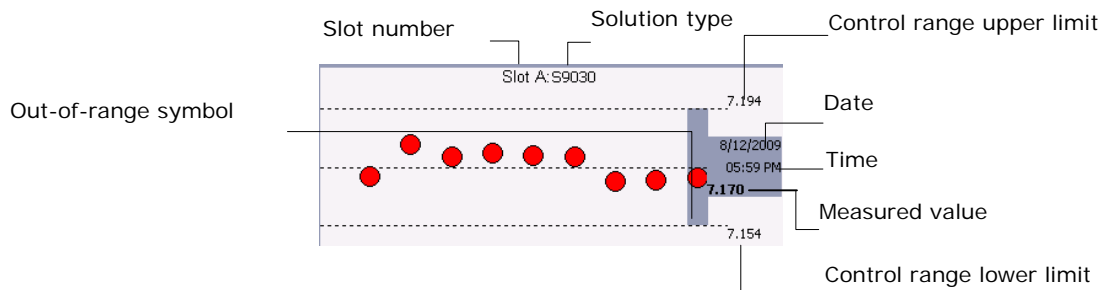

Explanation:

Shaded block	Shows date, time and measured value for the highlighted measurement. Use the up/down arrows to scroll the plot and view other measurements.	
Control range limits	Shows the upper and the lower limits of the control range for the highlighted measurement.	
Dots	Shows the number of measurements for the selected parameter. To view a measurement result, highlight a dot on the screen and press Result .	
Out-of-range symbols	↑ ↓	Measurement outside the control range and inside the statistical range.
	↑↑ ↓↓	Measurement outside both control and statistical ranges
Back	Return to the Quality control log screen.	

Use the buttons to do the following:

Result	View QC result for the highlighted measurement of the highlighted plot.
Select param.	View the plot for another parameter.
Print	Print out the plot.
Back	Return to the Quality control log screen.

Filter/trend function

The function is used to set the filter criteria to find a QC result or to select a number of results to make a trend.

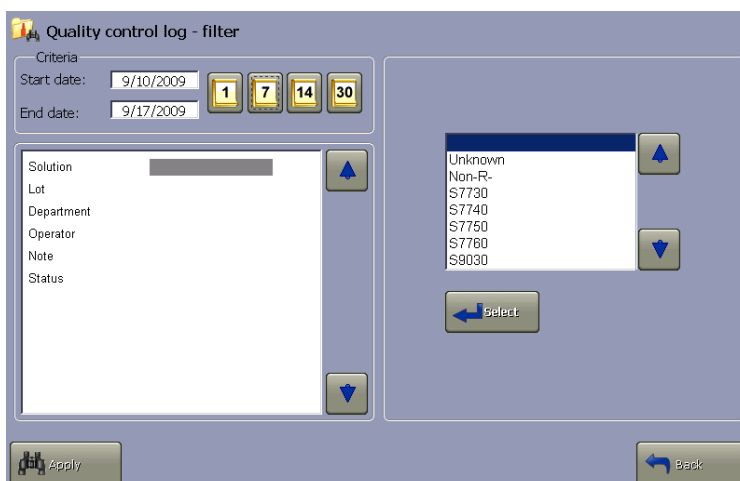

Step Action

1. Press **Filter** on the **Quality control log** screen.
2.
 - Set the "Start date" by using the 1-day, 7-day, 14-day or 30-day icons in the "Criteria" box

Or –

 - Type in the date, using the keypad and confirming the entry with **Enter**

Change, if necessary, the "End date" by highlighting it and typing a date other than the current date. Confirm with **Enter**.
3. Use the up/down arrows to highlight the desired filter criteria: Solution, Lot, Department, Operator, Note, and Status.
4. Confirm each entry with **Select** or **Enter**.
Or use the keyboard to enter the desired data and confirm each entry with **Enter**.
5. Press **Apply**.
6. Press **Trend** to select the parameters by activating the check buttons (e.g. pH, pCO₂, pO₂, etc.) and press **View trend**.
7.
 - Press **View filter** to view the filter criteria (the criteria cannot be changed, only viewed)
 - Press **Print** to print the displayed trend
 - Press **Back** to return to the **Quality control log** screen

Viewing quality control statistics

The screen is divided to show statistics for built-in QC and ampoule-based QC solutions (each identified by slot, type and lot number) for a single parameter.

Only those measurement values that fall within the statistical range are included in the statistical data. Parameters outside the range of indication or with a "?" are not included.

The screenshot shows a software interface titled "Quality control statistics" for the parameter "pH". It is divided into two main sections: "Built-in QC" and "Ampoule-based QC".

Built-in QC Data:

Slot	Solution	Lot	N	Mean	2 SD	CV	Control range	N	Mean	2 SD	CV
A	S9030	5152	13	7.178	0.023	0.159	7.154 7.194	13	0.005	0.023	0.159
B	S9040	5152	11	6.792	0.006	0.047	6.779 6.819	11	-0.007	0.006	0.047
C	S9050	5152	14	7.496	0.023	0.155	7.471 7.511	14	0.005	0.023	0.155

Ampoule-based QC Data:

Slot	Solution	Lot	N	Mean	2 SD	CV	N	Mean	2 SD	CV	Control range
1	S7740	2	12	7.376	0.005	0.036	12	7.376	0.005	0.036	7.377 7.417
2	S7760	4	4	6.809	0.046	0.341	4	6.809	0.046	0.341	6.794 6.834
3	S7750	3	3	7.587	0.000	0.001	3	7.587	0.000	0.001	7.551 7.601
4											
5	Non-R-		5	7.377	0.000	0.000	5	7.377	0.000	0.000	7.000 7.400
6											
7											
8											
9											
10											

At the bottom of the screen, there are several navigation buttons: "Next param.", "Prev. param.", "WDC report", "Print", "Delete", and "Back".

Built-in QC includes **Lot-to-date** and **Bias-to-date** statistics.

Ampoule-based QC includes **Month-to-date** and **Lot-to-date** statistics.

The statistics give the following information:

N	Number of measurements included in the statistics for the slot.
Mean	Calculated mean of the measurement values*.
2 SD	Calculated (2 × standard deviation) of measurement values*.
CV	Coefficient of variation*.
Control range	Current control range for the QC solution level.

* See *1 Appendix - Quality control* in the ABL90 FLEX reference manual for details.

The following functions are available by activating a button:

<i>Next param.</i> or <i>Prev param.</i>	Displays other parameters (starting with pH).
<i>WDC report</i>	Displays the WDC report screen – see <i>Creating a WDC report</i> in chapter 2: <i>Disk functions setup programs</i> in the ABL90 FLEX reference manual.
<i>Print</i>	Starts printing the screen data – see below.
 <i>Delete</i>	To delete the statistics of a slot/solution.
<i>Back</i>	Returns to the Quality control log screen.

Printing QC statistics

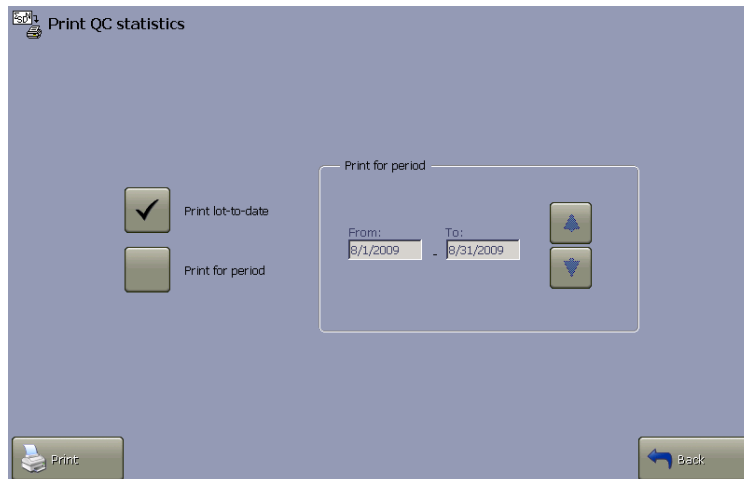

Step	Action
------	--------

1. Press **Print** on the **Quality control statistics** screen.
2.
 - Activate **Print lot-to-date** and press **Print** to print QC statistics for an entire lot
 - Activate **Print for period** to print monthly QC statistics: select the month and press **Print**
3. Press **Back** to return to the **Quality control statistics** screen.

Calibration log

Purpose The Calibration log is a historical file of calibrations automatically saved in the Calibration log after a calibration.

Each calibration report is listed as an individual record. The reports are listed chronologically, the latest report being at the top of the screen.

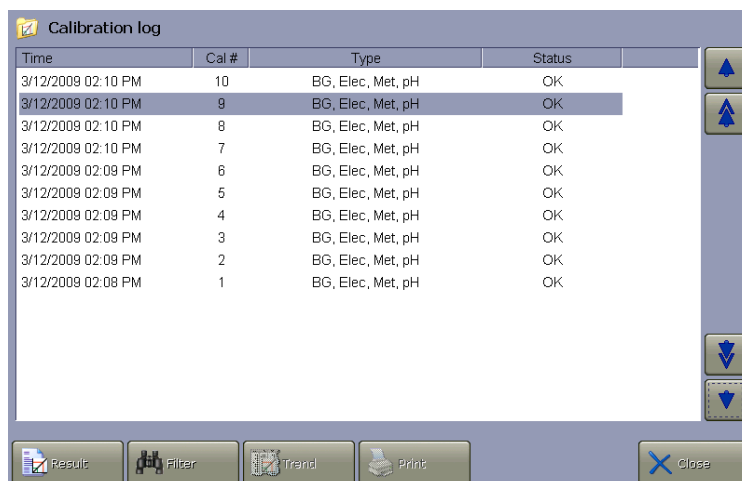

Each report is identified as follows (use the left/right scroll bar to see the items):

Time	Date and time that the calibration was performed.
Cal #	The ID number of a performed calibration.
Type	Indicates the calibration type. See chapter 6: <i>Calibration</i> .
Status	Indicates the calibration status: <ul style="list-style-type: none"> • "OK" = a successful calibration • "?" = an error detected or a measured value exceeded a range of indication • "Aborted" = a calibration stopped by the analyzer most likely due to missing calibration solution

The following functions are available by activating a button:

Result	Displays the highlighted patient report – see chapter 4: <i>Sample measurement</i> for detailed information.
Filter	See below.
Trend	Is inactive until the filter criteria are chosen and applied - see below.
Print	Starts printing the list; is active only after filter criteria have been applied.
Close	Returns to the main screen.

Filter function The function is used to set the filter criteria to find a calibration or to select a number of calibrations.

Step	Action
------	--------

- | | |
|----|---|
| 1. | Set the "Start date": use the 1-day, 7-day, 14-day or 30-day icons in the "Criteria" box or type in the date, using the keypad and confirming the entry with Enter . |
| 2. | Change, if necessary, the "End date" by highlighting it and typing in a date other than the current date. Confirm with Enter . |
| 3. | Select the desired calibration type and status using the relevant arrow buttons.
Confirm each entry with Enter or Select . |
| 4. | Press Apply to start the search (filter). |
| 5. | View the search results on the screen. |
| 6. | Press Back to return to the previous screen. |

Trend function This function is used to make the trend of the selected parameter for a calibration (after the filter criteria have been applied).

Time	Cal #	Type	Status
3/12/2009 02:10 PM	10	BG, Elec, Met, pH	OK
3/12/2009 02:10 PM	9	BG, Elec, Met, pH	OK
3/12/2009 02:10 PM	8	BG, Elec, Met, pH	OK
3/12/2009 02:10 PM	7	BG, Elec, Met, pH	OK
3/12/2009 02:09 PM	6	BG, Elec, Met, pH	OK
3/12/2009 02:09 PM	5	BG, Elec, Met, pH	OK
3/12/2009 02:09 PM	4	BG, Elec, Met, pH	OK
3/12/2009 02:09 PM	3	BG, Elec, Met, pH	OK
3/12/2009 02:09 PM	2	BG, Elec, Met, pH	OK
3/12/2009 02:08 PM	1	BG, Elec, Met, pH	OK

Step	Action
------	--------

1. Set up search criteria as described under *Filter function* and apply them. The filtered calibration results will be displayed and **Trend** and **Print** will now be active.
2. Press **Trend** to select the parameter.
3. Press **View trend** to display the trend of the selected parameter for the selected calibration type.
4. Press **View filter** to view the selected filter criteria (the criteria cannot be changed, only viewed).
To apply new criteria, repeat the Filter function and the Trend function procedures.
5. Press **Back** to return to the previous screen.

Activity log

Purpose The Activity log provides a historical record of all replacements, system messages and errors during operation. It also lists any operator messages and allows the entry of additional notes.

The records are listed chronologically and can be displayed at user, manager or service level.

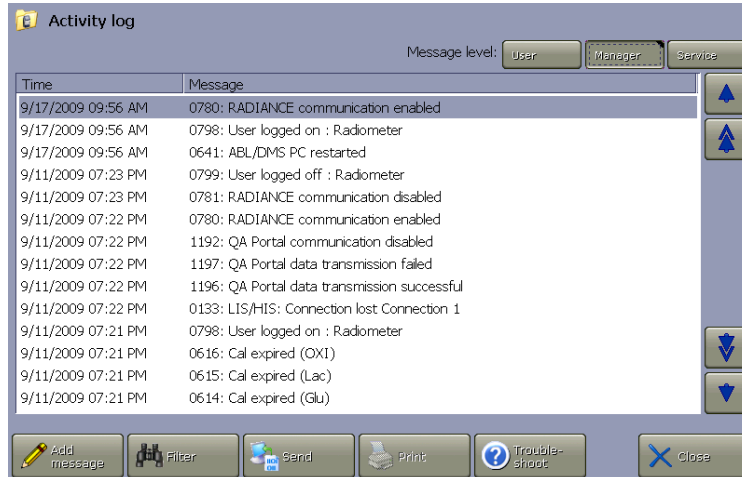

The record is identified as follows (use the left/right scroll bar to see the items):

Time	Date and time when the activity occurred.
Message	Gives a message number and an explanation of the activity. Operator note text appears as written.

Adding a message to the log

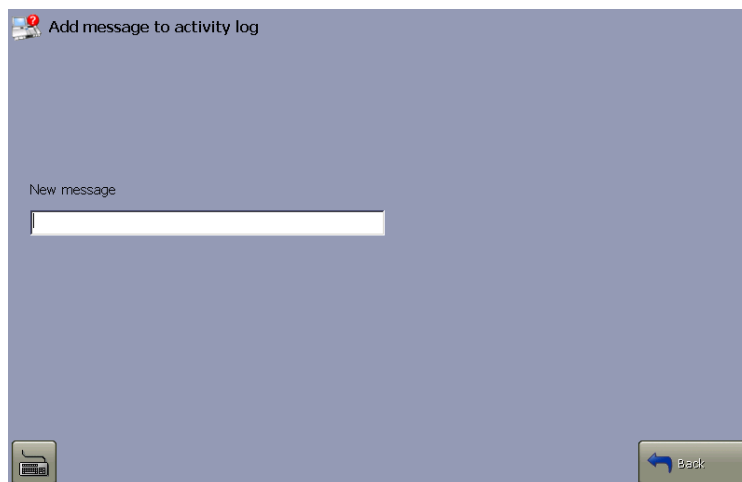

Step	Action
------	--------

- | | |
|----|---|
| 1. | Press Add message on the Activity log screen. |
|----|---|

2. If Notes were entered in the setup program User-defined notes (see *User-defined notes* in section *Parameters and input setup*, chapter 1: *Setup* in the ABL90 FLEX reference manual):
 - Edit a highlighted message by pressing **Edit msg.** to display the keyboard and make the changes
 - To delete a message, highlight it and press **Delete msg**

If Notes were not entered in User-defined notes:

 - Press the keyboard icon to display the keyboard
 - Type a message and press **Enter** to confirm and return to the **Activity log** screen
3. Press **Back** to return to the **Activity log** screen.

Filter function With this function you can set the filter criteria to find an activity or to select a number of activities.

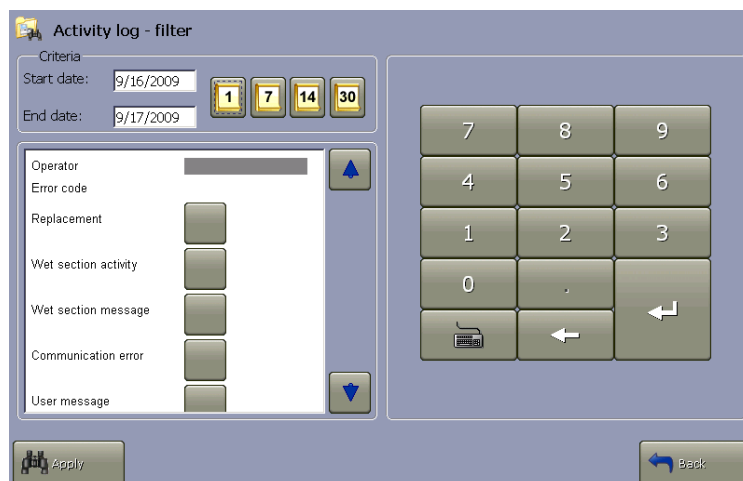

Step	Action
1.	Set the "Start date": Use the 1-day, 7-day, 14-day or 30-day icons in the "Criteria" box or type in the date, using the keypad and confirming the entry with Enter .
2.	Change, if necessary, the "End date" by highlighting it and typing in a date other than the current date. Confirm with Enter .
3.	Activate the check buttons to select filter criteria (use the up/down arrows in the box to display more criteria).
4.	Press Apply to start the filter.
5.	The Activity log screen displays the list of selected activities. Select the message level by pressing "User", "Manager" or "Service".
6.	<ul style="list-style-type: none"> • Press Filter to set other search criteria, if desired • Press Back to return to the main screen

Replacement log

Replacement log

The Replacement log shows the replacement records of the activity log.

The records are listed chronologically and can be displayed at user, manager or service level.

The following functions are available by activating a button:

<i>Print</i>	Press to print a list of all the replacement records.
<i>Troubleshoot</i>	Press to display the error description, operator actions and in some cases also a removal condition – see chapter 11: <i>Troubleshooting</i> in this manual and also chapter 10: <i>Analyzer messages</i> in the ABL90 FLEX reference manual for detailed information.
<i>Print items</i>	Only visible if "Sensor cassette removed" is selected. For the record "Sensor cassette removed", you can for diagnostic use generate a printout with sensor cassette data, system messages, and data about the latest calibration and built-in QC before replacement.
<i>Close</i>	Returns to the main screen.

Archived data logs

Purpose You can view the old patient reports, QC results, calibration results and activities that have been archived automatically when the maximum log size of 2000 patient reports, 2000 QC results, 1000 calibration results and 5000 activity log entries has been reached.

The archives are located on the analyzer's disk and can be exported to a CD-RW, removable disk, network, etc. – see *Exporting data logs*, chapter 2: *Disk functions setup programs* in the ABL90 FLEX reference manual.

The archives are archived after date:

- 500 reports from each log and
- 2000 entries from the Activity log

Press **Menu** > **Data logs** > **Archived data logs**.

Press the button on the screen to select the log archives. As the functions are similar for all archives, the Calibration archive is used as an example.

Selecting an archive saved on the analyzer

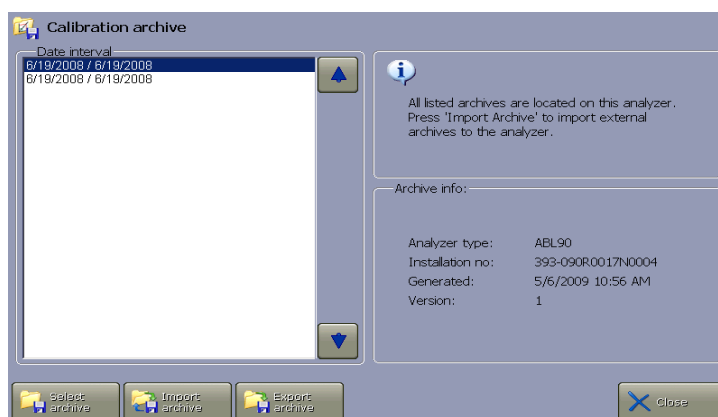

Step	Action
1.	Highlight the desired archive with the up/down arrows. Information about analyzer type and installation number along with the date this archive was generated is on the screen.
2.	Press Select archive to obtain it for viewing.
3.	Press, if desired, Filter to enter filter criteria and apply the filter.
4.	Highlight the desired report by touching it on the screen and press Result to display the result.
5.	Press Close to exit to the main screen.

Moving an archive to another media or from another media to the analyzer

Step	Action
1.	Press Import archive to move it. The Import/Export archives screen will be displayed.
2.	Proceed as described in <i>Importing/exporting archives</i> , chapter 2: <i>Disk functions setup programs</i> in the ABL90 FLEX reference manual.

Converting an archive into .csv format

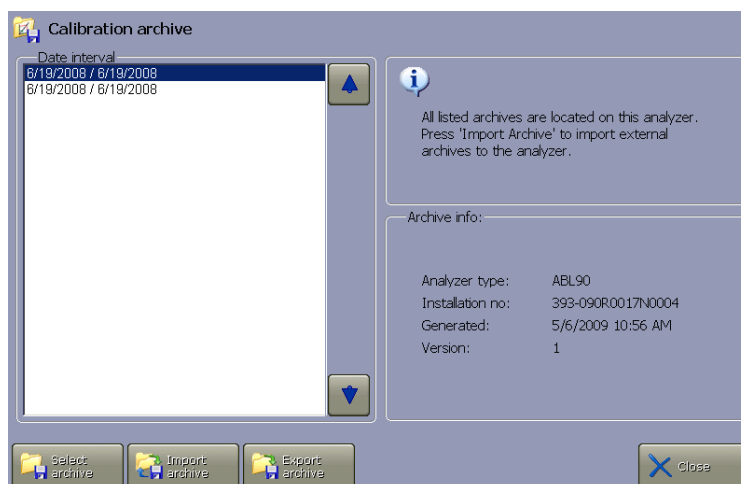

Step	Action
1.	Highlight an archive and press Export archive .
2.	The Destination screen appears. Choose directory and press Back . The Export archive screen appears.
2.	<ul style="list-style-type: none"> • Press Start to start conversion. • Press Back to cancel and return to the previous screen
3.	Export the converted archive to a disk as described in <i>Importing/exporting archives</i> , chapter 2: <i>Disk functions setup programs</i> in the ABL90 FLEX reference manual.

RADIANCE browser (optional)

Purpose With this option you can get in touch with the RADIANCE system to find information on patients, QC and calibrations from all analyzers connected to the RADIANCE STAT analyzer management system.

Accessing RADIANCE

Step	Action
1.	Make sure that a connection to the RADIANCE server is established in the RADIANCE connection setup – see <i>RADIANCE connection setup</i> in section <i>Communications setup</i> in chapter 1: <i>Setup</i> in the ABL90 FLEX reference manual.
2.	Press Menu > Utilities > RADIANCE browser . The analyzer will exchange information with the RADIANCE system about your access profile, and the contents of the RADIANCE main page will reflect the scope of your privileges.
3.	Refer to the <i>RADIANCE operator's manual</i> on how to navigate the RADIANCE functions.

10. Analyzer shutdown

General information.....	10-2
Temporary shutdown.....	10-3
Restarting the analyzer after temporary shutdown.....	10-4
Long-term shutdown	10-5

General information

Shutdown programs

To access the Shutdown programs, press **Menu > Utilities**. Then press the desired button to enter the desired program:

- **Temporary Shutdown**
- **Long term Shutdown**

Temporary shutdown

Purpose This program prepares the analyzer software for switching off power and is used for temporary (short-term) shutdown of the analyzer.

This program differs from the Long-term shutdown used for a long-term storage of an analyzer that requires removal of system components.

Switching off the analyzer for a short time



Step	Action
1.	Enter the program.
2.	<ul style="list-style-type: none">• Press Confirm shutdown to continue• Press Close to cancel
3.	Wait for the analyzer to automatically shut down.

Restarting the analyzer after temporary shutdown

Step	Action
1.	Verify that the system requirements are met and all components are installed.
2.	Place the power switch in the "ON" position.

The startup procedure begins. Startup includes:

- Loading of software
- Leak test
- Initialization
- Liquid sensor adjustment
- Pump calibration
- Rinse
- Startup (conditioning of the sensor cassette)
- Calibration

When completed, the main screen appears.

The analyzer can be used as soon as the analyzer is in the Ready mode and the traffic light of the **Analyzer status** is acceptable.

Warm start

If the analyzer is turned off for a short period of time only and certain preconditions are fulfilled (see below), a warm start may be performed instead of a cold start.

With the warm start:

- The analyzer will be ready for measurement within approximately 10 minutes if the preconditions below are fulfilled.
- No calibration will be added to the measurement after restart.
- You can swap sensor cassettes during troubleshooting, without calibrations being added to measurements.
- The user will be notified if the sensor cassette is not properly maintained (no rinse or flush has been performed within the two hours).

If a sensor cassette has not been properly maintained, it may take the sensors 24 hours to be ready for measurement or the sensor cassette may have to be replaced.

To initiate a warm start instead of a cold start, certain preconditions must, however, be fulfilled:

- The analyzer must only have been turned off for a short period of time (<120 minutes)
- The last cold start or sensor cassette replacement was not performed within the last 24 hours
- The temporary shutdown feature should have been used for the shutdown. The Standby button at the rear of the analyzer may also have been used.

If the temporary shutdown feature is not used for the short-time shutdown, the analyzer must be in the Ready mode to perform a warm start. Otherwise a cold start will be performed.

- The analyzer must have been in the Ready mode when it was temporary shut down.
- The sensor startup sequence with calibrations must have been completed.

- The sensor used is the same as before the restart.
- The sensor cassette has been maintained properly by the analyzer (no more than 2 hours since last rinse or flush)
- No QC measurement or calibration has meanwhile become overdue.

If these preconditions are not fulfilled, the startup time will be longer and perhaps result in a cold start. For further information about cold starts, see section *Calibrations related to startups* in chapter 6: *Calibration*.

Long-term shutdown

Purpose

This program is used to prepare the analyzer for a long-term storage if it will not be used for a period of time or if it has to be moved to another location so that it requires removal of system components and emptying the analyzer of solutions. The shutdown procedure takes approximately 15 minutes.

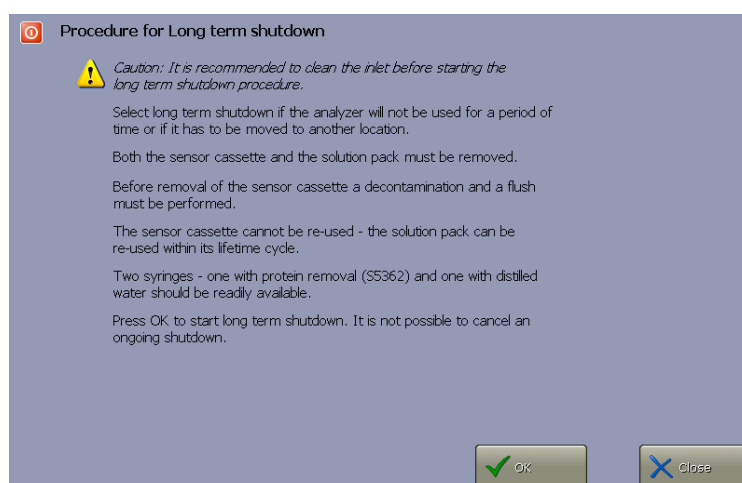

Step	Action
	NOTICE: It is recommended to clean the inlet before starting the long-term shutdown procedure.
1.	Enter the Long-term shutdown program.
2.	Read the instructions on the screen and press OK to start the long-term shutdown procedure.
3.	<p>Prepare sensor cassette removal:</p> <p>Before removal of the sensor cassette decontamination with hypochlorite solution and a cleaning with distilled water must be performed.</p> <p>A syringe with hypochlorite solution (S5362) and a syringe with distilled water should be readily available.</p> <p>Lift the inlet to syringe position.</p> <p>Place the tip of the syringe with hypochlorite solution firmly against the inlet and press it upwards while still holding on to the sampler cylinder. The inlet probe extends into the syringe and the hypochlorite solution is automatically aspirated.</p> <p>NOTICE: Be careful not to bend the probe. Hold on to the syringe barrel and do not press the plunger.</p>

4. When prompted by the analyzer, remove the syringe and close the inlet. Wait for the decontamination to end.
5. Lift the inlet to syringe position.
Place the tip of the syringe with distilled water firmly against the inlet and press it upwards while still holding on to the sampler cylinder. The inlet probe extends into the syringe and the distilled water is automatically aspirated.
NOTICE: Be careful not to bend the probe. Hold on to the syringe barrel and do not press the plunger.
6. When prompted by the analyzer, remove the syringe and close the inlet. Wait for the cleaning to end.
7. **Sensor cassette removal:**
The sensor cassette compartment opens.
Remove the sensor cassette by pulling it out of the sensor cassette compartment with the thumb and index finger and press **Confirm removal** after removal. The sensor cassette compartment closes.
NOTICE: The sensor cassette *cannot* be re-used.
8. **Solution pack removal:**
Lift the inlet to capillary position, press **Eject**. The solution pack is ejected.
9. Remove the solution pack and close the inlet.
The shutdown procedure is in progress, please wait for the analyzer to shut down.
NOTICE: The solution pack *can* be re-used within its lifetime cycle.

Storing an analyzer

Radiometer recommends placing the analyzer on a trolley in its normal position and protecting it from dust with a plastic cover.

Transporting the analyzer

To transport the analyzer over a longer distance from one location to another, put it back in its original packaging and seal.

To transport the analyzer without its original packaging, remove the solution pack and disconnect power and peripheral devices before lifting the analyzer.

Restarting the analyzer

Step	Action
1.	Turn on the analyzer and wait for the User-intervention-required mode to appear
2.	Perform a solution pack replacement (see chapter 7: <i>Replacements</i> in this manual).
3.	Perform a sensor cassette replacement (see chapter 7: <i>Replacements</i> in this manual).
4.	Press Test again .

For further information about calibrations in connection with startups, see section *Calibrations related to startups* in chapter 6: *Calibration*.

11. Troubleshooting

General information.....	11-2
User-Intervention-required causes.....	11-4

General information

Analyzer action in case of error Depending on the severity of the error the analyzer will do one of the following:

- continue its activity, but mark relevant parameter results with a "?"
- interrupt and abort its activity
- enter the user-intervention-required mode
- deny measurements and calibrations

Operator actions in case of error To locate and remedy analyzer messages, do the following:

- | Step | Action |
|------|--|
| 1. | Check which of the status button indicators is red or yellow on the Analyzer status screen. |
| 2. | Press the relevant button (example: Calibrations was pressed). |

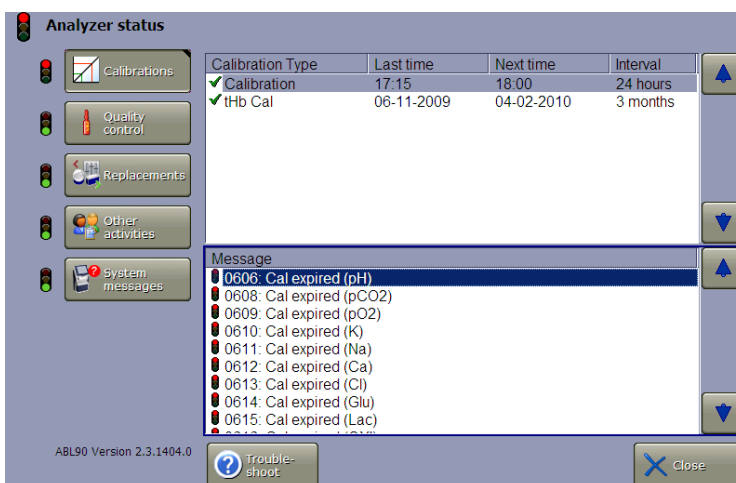

Highlight the desired error (the first line is automatically highlighted).

Step	Action
------	--------

3. Press **Troubleshoot** for error description and operator action.

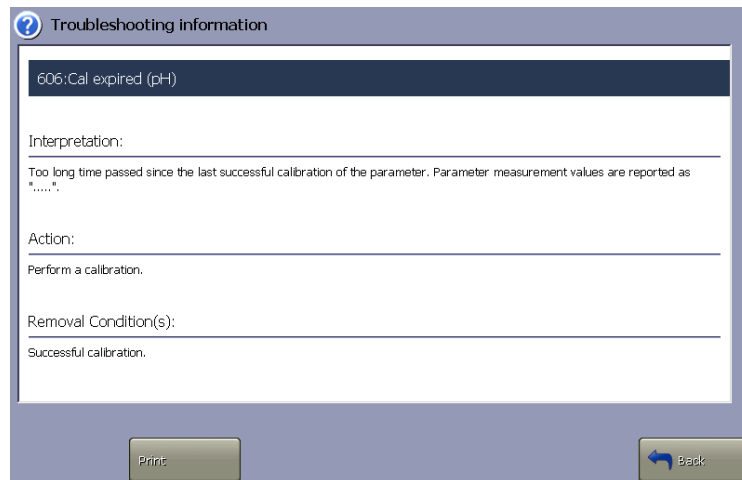

4. Remedy the error as described in the troubleshooting dialog on the screen.
5. Remedy other error(s) if present.
6. After all errors have been remedied, press **Back** and **Close** till you return to the main screen.

NOTICE: For a list of the analyzer messages, interpretations and operator actions that can be seen on user and manager levels, see chapter 10: *Analyzer messages* in the ABL90 FLEX reference manual.

Logging system messages

All system messages are automatically recorded in the Activity log at the time of their occurrence. The items in the Activity log are listed in chronological order and form a permanent record for the user of all system messages that have taken place.

Using the filter function (see the description in section *Activity log* in chapter 9: *Data management*), you can select the desired type of messages and view them on the user, manager and service levels.

User-Intervention-required causes

Intervention required

User-intervention-required mode is used to correct errors by suspending all wet-section activities in case the following analyzer conditions occur:

- Problems with the inlet leaking
 - Solution transport errors (e.g. leakage)
 - Problems with sensor cassette or solution pack
 - Thermostatting errors
 - HW/SW errors
 - Misc. calibration errors
 - Other unexpected situations
- Follow the on-screen instructions.
- It might require several actions to correct the condition. Until the condition has been corrected, the analyzer cannot be restarted.
- Press 'Test again' to leave the **User-intervention required** screen.

12. Sampling

Sampling devices and procedures.....	12-2
Storage time and temperature recommendations.....	12-5
Causes of error in the preanalytical phase.....	12-6
References.....	12-9

Sampling devices and procedures

Introduction Typically, whole-blood arterial or venous specimens are obtained by needle puncture or via an in-line catheter; whole-blood capillary samples are obtained from the earlobe, finger, heel, scalp, etc. For specific information on the clinical value of the blood samples from each of the sampling sites, for indications and contraindications on when to use them, etc., please consult other sources.



WARNING – Risk of infection

Blood sampling should be performed by authorized personnel only. To avoid the risk of infection, always handle blood and the collection devices with care and avoid direct contact with the sample by using gloves.



WARNING – Risk of erroneous results

Always meticulously follow the sampling procedures described in this chapter. Failure to follow these procedures may introduce clots or air bubbles in the sample and yield erroneous results

Recommended arterial blood samplers	<i>safe</i> PICO Self-fill	Self-filling arterial blood sampler for arterial puncture or A-line sampling. Prebarcoded, with a needle shield device, an integrated mixing device and a vented tip cap, helping to ensure the best sample quality, patient and operator safety.
	<i>safe</i> PICO Aspirator	Aspirating arterial blood sampler for A-line sampling. Prebarcoded and with an integrated mixing device and a vented tip cap, helping to ensure the best sample quality, patient and operator safety.
	<i>safe</i> PICO70	Self-filling arterial blood sampler for arterial puncture or A-line sampling with a needle shield device helping to ensure patient and operator safety
	PICO70	Self-filling arterial blood sampler for arterial puncture or A-line sampling.
	PICO50	Arterial blood sampler for the aspiration of arterial blood from A-lines.

Recommended capillary blood samplers CLINITUBES are available in both plastic (*safe*CLINITUBES) and glass (CLINITUBES), in a variety of volumes and with different types and concentrations of heparin.

Always make sure to use a capillary of sufficient volume. Please consult your local distributor for specific recommendations or chapter 14: *Ordering information*.



CAUTION – Risk of bias on pO_2 results

In general, results obtained from capillary samples, particularly pO_2 values, should be interpreted with caution, as pO_2 results may be biased due to aerobic sampling technique. Alternatively, draw an arterial blood sample.

Procedures For information on the use and handling of sampling devices, follow local procedures and manufacturers' recommendations as well as the general recommendations given in section *Causes of error in the preanalytical phase* later in this chapter.

Special considerations for capillary specimens

Besides adhering to the preanalytical issues addressed in section *Causes of error in the preanalytical phase* and to local procedures, also note the following about capillary specimens:

- When performing capillary blood sample measurements, use the mixing wire to ensure appropriate mixing of the sample with heparin (coated on the inside of Radiometer capillary tubes) and thereby prevent clots from being introduced into the analyzer. The sample should be mixed immediately after collection as well as immediately before analysis.

Adult samples

- Gently move a magnet back and forth along the length of the tube 10 times each way. Allow the mixing wire to move all the way from end to end with every single stroke with the magnet. This procedure should be repeated immediately before analyzing the sample.

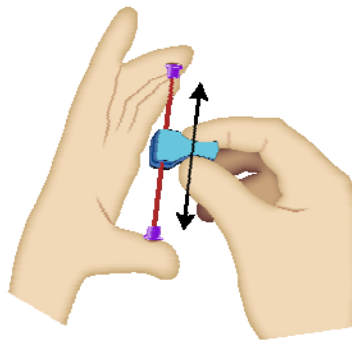

Neonatal and fragile samples

- Invert the capillary tube slowly 20 times. Allow the mixing wire to move all the way from end to end with every single inversion.

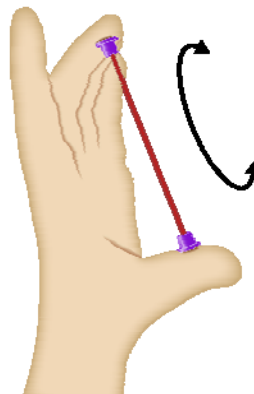

Fetal scalp samples

- When performing capillary blood sample measurements on fetal scalp blood, insert the mixing wire into the capillary tube after the sample has been collected
- When performing measurements on fetal scalp blood, introduce the capillary sample into the analyzer from the cap end free from Vaseline or similar
- Due to their inherent characteristics, fetal scalp blood samples are generally regarded as potentially difficult to work with. Important prerequisites for successfully analyzing fetal scalp blood samples are that the preanalytical precautions listed in section *Causes of error in the preanalytical phase* are followed very closely below.

Storage time and temperature recommendations

Radiometer storage recommendations for whole-blood samples

For all samples, storage should be avoided whenever possible or, at least, kept to a minimum.

Material	Storage recommendation
Plastic syringe	<ul style="list-style-type: none"> • If it is not possible to analyze the sample immediately, analyze it within 30 minutes [1,2,3,4,5,6,7] • Recommended sample storage temperature is room temperature [1,2,4] • Samples with expected high pO_2 values or for special studies like shunt studies should be analyzed immediately or within 5 minutes. The use of glass syringes can also be considered [1,3,4].
Glass syringe	<ul style="list-style-type: none"> • If it is not possible to analyze the sample immediately, analyze it within 30 minutes when stored at room temperature [1,8] • Alternatively, store the sample in ice water (0-4 °C). The storage time should not exceed 1 hour [9]. • Samples with expected high pO_2 values or for special studies like shunt studies should be analyzed immediately or within 5 minutes [9]
Plastic capillary tube	<ul style="list-style-type: none"> • If it is not possible to analyze the sample immediately, analyze the sample within 10 minutes. Keep the sample at room temperature. Note that for samples with $pO_2 > 80$ mmHg (10.7 kPa), a positive bias from 1 to 9 % is observed for <i>safeCLINITUBES</i>. The bias depends on pO_2, pH and time.
Glass capillary tube	<ul style="list-style-type: none"> • If it is not possible to analyze the sample immediately, either analyze the sample within 10 minutes when stored at room temperature or store the sample horizontally at 0-4 °C for maximum 30 minutes

Special considerations

- For some samples, the recommendations above do not apply and individual guidelines should be used or developed. Examples of these samples are samples with an increased leukocyte or platelet count, fetal scalp samples, samples with atypical metabolism, fast-clotting samples, etc. [5,10].
- Typical metabolic activity in blood samples causes an increase in the lactate concentration and a decrease in the glucose concentration. For samples within the typical reference range this corresponds to an average change in the lactate concentration of 0.25 mmol/L and of -0.2 mmol/L for glucose over 30 minutes at room temperature [11].

Causes of error in the preanalytical phase

Introduction The major source of error in blood sample analysis is the preanalytical phase. Some of the errors can be prevented by choosing proper devices and others should be addressed in training and procedures. In general, always adhere to local procedures.

Possible causes of error Some of the possible causes of error during the preanalytical phase and suggestions to preventive measures are described in the table below. For more information see also *Recommended literature* at the end of this chapter.

Cause of error	Possible problem	Suggestions to preventive measures
Missing or erroneous patient and/or sample ID	Patient result mix-up	<ul style="list-style-type: none"> Use two patient identifiers Ensure that the sampler has an ID label attached when you leave the patient Always enter patient ID into the analyzer Prebarcoded arterial blood gas samplers are available from Radiometer
Respiratory condition of patient	Bias on pH and blood gases	<ul style="list-style-type: none"> Inform the patient of the procedure in order to avoid hyperventilation Sample at least 20 minutes after ventilatory adjustment
Heparin: low concentration	Clots	<ul style="list-style-type: none"> Use heparin in sufficient concentration. The recommended concentration depends on the specific blood sample. Samplers with different heparin concentrations are available from Radiometer
Heparin: interference	Bias on electrolytes, especially cCa^{2+}	<ul style="list-style-type: none"> Use electrolyte-balanced heparin when electrolytes are to be reported Samplers preheparinized with electrolyte-balanced heparin are available from Radiometer
Heparin: dilution from liquid heparin	Biased results likely on all parameters	<ul style="list-style-type: none"> Use preheparinized devices with dry heparin; available from Radiometer
Insufficient amount of flush solution is discarded from catheter	Biased results likely on all parameters	<ul style="list-style-type: none"> Discard a sufficient volume from the catheter before taking a blood sample. CLSI recommends a flush volume of 6 times the dead space of the catheter [1].
Infusion solution given in same arm	Biased results likely on all parameters	<ul style="list-style-type: none"> Stop infusion for a period of time or use another sampling site

Cause of error	Possible problem	Suggestions to preventive measures
Capillary samples	Biased results likely on all parameters	<ul style="list-style-type: none"> • The need for heel warming is not universal in the literature and depends on puncturing device and technique. However, increasing capillary blood flow may be necessary to prevent hemolysis and/or contamination with tissue fluids [12]. • Make the puncture with a lancet or similar, so that blood flows freely. Do not squeeze the area. • Remove the first drop of blood, since it may be diluted with tissue fluid
Air bubbles in sample	All parameters affected by air bubbles in the measuring chamber	<ul style="list-style-type: none"> • Visually inspect the sample for air bubbles • Right after sampling and before mixing, tap the sampler to move any bubbles to the top of the sampler and gently press the plunger to expel any air from the sampler • Arterial blood gas samplers with vented tip caps that will allow you to expel air and seal the sampler with least possible contact with blood are available from Radiometer
Clots in sample	Biased results likely on all parameters	<ul style="list-style-type: none"> • Use heparin exclusively as this is the only anticoagulant suitable for blood gas testing • Use dry preheparinized sampling devices • Mix the sample immediately after sampling to dissolve the heparin • See also the text on heparin earlier in this table • Blood gas analyzers with automatic mixing prior to measurement, arterial blood gas samplers with a ball for mixing and capillaries with a mixing wire are available from Radiometer
Hemolysis	Bias on electrolytes, especially CK^+	<ul style="list-style-type: none"> • Do not store the sample directly on ice cubes • Do not mix vigorously • Avoid turbulence in the sample caused by a too narrow needle diameter, obstruction in sample pathway and too rapid manual aspiration • Avoid squeezing the tissue during sample collection into a capillary

Cause of error	Possible problem	Suggestions to preventive measures
Sample stored for too long before being analyzed	Bias on all parameters	<ul style="list-style-type: none"> • See <i>Storage time and temperature recommendations</i> in this chapter, and Bulletin No. 31 [14]
Sample exposed to artificial light or sunlight	Bias on ctBil	<ul style="list-style-type: none"> • For patients receiving phototherapy, lights should be extinguished prior to drawing the sample
Insufficiently mixed sample	Bias on ctHb	<ul style="list-style-type: none"> • Mix the sample in two dimensions by rolling it between your hands and inverting it vertically prior to transfer into the analyzer. If the sample is visibly sedimented, it needs mixing for several minutes. • Blood gas analyzers with automatic mixing prior to measurement (built-in sample mixer), arterial blood gas samplers with a ball for mixing and capillaries with a mixing wire.



WARNING – Risk of infection

Dispose of the used samples and blood remains as infectious waste to avoid exposing others to the risk of infection [13].

References

List of references

This section lists the references applicable to blood sampling and blood gas analysis associated with this chapter.

1. CLSI. Procedures for the collection of arterial blood specimens; approved standard – Fourth Edition. CLSI/NCCLS document H11-A4, Clinical Laboratory Standards Institute, 940 West Valley Road, Suite 1400, Wayne, Pennsylvania 19087-1898 USA, 2004.
2. Mahoney JJ, Van Kessel A. Arterial blood gas analysis. *Respir Care* 1997; 249-79.
3. Smeenk F, Janssen J, Arends B, Harff G, Bosch J, Schönberger J, Postmus P. Effects of four different methods of sampling arterial blood and storage time on gas tensions and shunt calculation in the 100% oxygen test. *Eur Respir J* 1996; 10: 910-13.
4. Mahoney JJ, Harvey JA, Wong RJ, Kessel VLA. Changes in oxygen measurements when whole blood is stored in iced plastic or glass syringes. *Clin Chem* 1991; 37: 1244-48.
5. Woolley A, Hickling K. Errors in measuring blood gases in the intensive care unit: Effect of delay in estimation. *J Crit Care* 2003; 18: 31-37.
6. Blonshine S. To ice or not to ice. *AARC Times* 2000: 37-39.
7. Liss P, Payne P. Stability of blood gases in ice and at room temperature. *Chest* 1993; 103: 1120-21.
8. CLSI. Blood gas preanalytical considerations: specimen collection, calibration and controls; Approved guideline. CLSI/NCCLS document C27-A, Clinical Laboratory Standards Institute, 940 West Valley Road, Suite 1400, Wayne, Pennsylvania 19087-1898 USA, 1993.
9. Burnett RW, Covington AK, Fogh-Andersen N *et al.* Approved IFCC recommendations on whole blood sampling, transport and storage for simultaneous determination of pH, blood gases and electrolytes. *Eur J Clin Chem Clin Biochem* 1995; 33: 247-53.
10. Nickelsen CN. Fetal capillary blood pH. www.bloodgas.org, 2002.
11. Wennecke G. Useful tips to avoid preanalytical errors in blood gas testing: metabolites. www.bloodgas.org, 2004.
12. CLSI. Procedures and devices for the collection of diagnostic capillary blood specimens; approved standard – Fifth Edition. CLSI/NCCLS document H4-A5, Clinical Laboratory Standards Institute, 940 West Valley Road, Suite 1400, Wayne, Pennsylvania 19087-1898 USA, 2004.
13. Clinical laboratory waste management. CLSI/NCCLS document GP5-A2, Clinical Laboratory Standards Institute, 940 West Valley Road, Suite 1400, Wayne, Pennsylvania 19087-1898 USA.
14. Skurup A. Storage recommendations for blood gas samples. Radiometer Publication bulletin no. 31-2006. Copenhagen: Radiometer Medical A/S. Code no. 918-686.

Recommended literature

1. Capillary sampling. In: The whole-blood sampling handbook. Copenhagen: Radiometer Medical ApS, 2003. Code 989-466.
2. Christiansen TF. Heparin and blood sampling for pH, blood gases and direct potentiometric electrolyte analysis. Radiometer Publication AS96. Copenhagen: Radiometer Medical A/S, 1986.
3. The blood gas handbook. Copenhagen: Radiometer Medical ApS, 2004. Code 989-318.
4. Bower LK, Barnhart SL, Betit P, Hendon B, Masi-Lynch J, Wilson BG. AARC Clinical practice guideline. Capillary blood gas sampling for neonatal and pediatric patients. *Respir Care* 1994; 39, 12: 1180-83.
5. Moran RF, Bergkuist C, Graham GA *et al*. Considerations in the simultaneous measurement of blood gases, electrolytes and related analytes in whole blood. Proposed Guideline. CLSI/NCCLS Publication C32-P, Clinical Laboratory Standards Institute, 940 West Valley Road, Suite 1400, Wayne, Pennsylvania 19087-1898 USA, 1993.
6. Christiansen TF. Measurement of potassium in whole blood. Radiometer Publication AS92. Copenhagen: Radiometer Medical A/S, 1983. Code 918-231.
7. Wandrup JH. Clinical and analytical requirements and needs of glucose measurements on whole blood. Radiometer Publication AS122. Copenhagen: Radiometer Medical A/S, 1996. Code 918-549.
8. Wandrup JH, Tvede K, Grinsted J, Jordening H. STAT measurements of L-lactate in whole blood and cerebrospinal fluid assessed. *Clin Chem* 1989; 35, 8: 1740-43.
9. Wu E, Barazangi K, Johnson R. Sources of error in A - aDo₂ calculated from blood stored in plastic and glass syringes. *J Appl Physiol* 1997; 82: 196-202.
10. Young DS. Preanalytical issues in neonatology. www.bloodgas.org, 2002.
11. Clark CG *et al*. Preanalytical errors in simultaneous blood gas, electrolyte, and metabolite analysis. www.bloodgas.org, 1998.
12. Narayanan S. Preanalytical issues related to blood gas sample mixing. www.bloodgas.org, 2005.
13. Wennecke G. Useful tips to avoid preanalytical errors in blood gas testing: neonatal total bilirubin. www.bloodgas.org, 2004.
14. Wennecke G. Useful tips to avoid preanalytical errors in blood gas testing: electrolytes. www.bloodgas.org, 2003.
15. Wennecke G. Useful tips to avoid preanalytical errors in blood gas testing: metabolites. www.bloodgas.org, 2004.
16. Blonshine SB. Arterial blood collection – part 1 of 2. www.bloodgas.org, 2005.
17. Blonshine SB. Arterial blood collection: sampling and storage – part 2 of 2. www.bloodgas.org, 2005.
18. Higgins C. Pneumatic tube transport of samples for blood gas analysis. www.bloodgas.org, 2005.
19. Biswas CK, Ramos JM, Agroyannis B, Kerr DNS. Blood gas analysis: effect of air bubbles in the syringe and delay estimation. *B Med J* 1982; 284: 923-27.
20. Mueller RG, Lang GE, Beam JM. Bubbles in samples for blood gas determinations – a potential source of error. *Am J Clin Pathol* 1976; 65: 242-49.

13. Specifications

Measured parameters	13-2
Input parameters	13-4
Sample handling	13-5
Analyzer requirements	13-6
Analyzer specifications	13-7
Approvals and patents	13-8

Measured parameters

Blood

For the numerical format (that depends on the individual ranges) see chapter 8: *Parameters* in the ABL90 FLEX reference manual.

Parameter	Unit	Range of indication	Reportable range (default)
pH	pH scale	6.3-8.0	6.750-7.850
$p\text{CO}_2$	mmHg; Torr kPa	5-250 0.67-33.3	12.0-110 1.60-14.7
$p\text{O}_2$	mmHg; Torr kPa	0-800 0-107	26.0-550 3.47-73.3
ctHb	g/dL g/L mmol/L	-0.48-27.7 -4.8-277 -0.30-17.2	0*)-27 0*)-270 0*)-16.8
$s\text{O}_2$	% fraction	-2-102 -0.02-1.02	0*)-100*) 0.00*)-1.00*)
$F\text{O}_2\text{Hb}$	% fraction	-2-103 -0.02-1.03	0*)-100*) 0.00*)-1.00
$F\text{COHb}$	% fraction	-2-103 -0.02-1.03	0*)-100*) 0.00*)-1.00*)
$F\text{MetHb}$	% fraction	-2-103 -0.02-1.03	0*)-100*) 0.00*)-1.00*)
$F\text{HHb}$	% fraction	-2-102 -0.02-1.02	0*)-100*) 0.00*)-1.00*)
$F\text{HbF}$	% fraction	-25-121 -0.25-1.21	0*)-100*) 0.0*)-1.00*)
$c\text{K}^+$	mmol/L; meq/L	0.5-25	1.5-10.5
$c\text{Na}^+$	mmol/L; meq/L	7-350	115-190
$c\text{Ca}^{2+}$	mmol/L meq/L mg/dL	0.2-9.99 0.4-19.98 0.8-40.04	0.40-2.70 0.80-5.40 1.60-10.82
$c\text{Cl}^-$	mmol/L; meq/L	7-350	70-160
$c\text{Glu}$	mmol/L mg/dL	0-60 0-1081	0-47 0-847
$c\text{Lac}$	mmol/L; meq/L mg/dL	-0.1-31 -1-279	-0.1-31 -1-279
ctBil	$\mu\text{mol/L}$ mg/dL mg/L	-20-1000 -1.2-58.5 -12-585	0*-690 0*-40.3 0*-403

*) The values are for the analyzer with the activated "Out-of-range suppression"

function. In case this function has not been activated, the default reportable range will be as follows:

Parameter	Unit	Reportable range
ctHb	g/dL	-0.2-27.0
	g/L	-2-270
	mmol/L	-0.12-16.8
FO ₂ Hb, FCOHb, FMetHb	%	-2.0-103.0 %
	fraction	-0.02-1.03
sO ₂ , FHHb	%	-2.0-102.0
	fraction	-0.02-1.02
FHbF	%	-25-121
	fraction	-0.25-1.21
ctBil	µmol/L	-20-690
	mg/dL	-1.2-40.3
	mg/L	-12-403

Barometer

Parameter	Unit	Range of indication
p(amb)	mmHg; Torr	450-800
	kPa	60-107

Input parameters

List of parameters The following input parameters are available, independent of analyzer configuration:

Parameter	Unit	Input range	Defaults
Patient temperature, T	°C	15.0-45.0	37
QUALICHECK5+ ampoule temperature, T	°C	18.0-32.0	25
Fraction of oxygen in dry inspired air, $FO_2(I)$	%	0.0-100.0	21.0
	fraction	0.000-1.000	0.210
Total hemoglobin concentration (if not measured), ctHb	g/dL	0.0-33.0	-
	g/L	0.0-330	-
	mmol/L	0.0-20.5	-
Respiratory quotient, RQ	-	0.00-2.00	0.86
Oxygen tension in mixed venous blood, $pO_2(\bar{v})$	mmHg	0.0-xxx.x*	-
	kPa	0.00-xx.xx*	-
Oxygen saturation in mixed venous blood, $sO_2(\bar{v})$	%	0.0-100.0	-
	fraction	0.000-1.000	-
Cardiac output, \dot{Q}_t	L/min	0.0-xxx.x*	-
Total oxygen consumption, $\dot{V}O_2$	mL/min	0-xxxx*	-
	mmol/min	0.0-xxx.x*	-
	min		
Volume of carbon monoxide, VCO	mL	0.0-xxx.x*	-
The fraction of COHb measured before the CO-injection, $FCO_{Hb}(1)$	%	0.0-100.0	-
	fraction	0.000-1.000	-
The fraction of COHb measured after the CO-injection, $FCO_{Hb}(2)$	%	0.0-100.0	-
	fraction	0.000-1.000	-

* = numerical format

Derived parameters

All parameters are calculated in SI units. If other units are selected, the results are obtained by converting the SI units into those selected. For detailed information, see the *ABL90 FLEX reference manual*, chapter 8: *Parameters*.

Sample handling

Mode	Measuring time (sec)*	Cycle time (sec)**	Samples per hour**
Syringe	35	60	≥44
Capillary – C65 (65 µL)	35	60	≥44
Ampoule – QC	35	60	≥44

* From the moment the inlet flap is lifted until the results are displayed.

** May vary during startup.

Analyzer requirements

Analyzer requirements

Power	Rated voltage: 100-240 V; 50/60 Hz Max. power: 90 W Maximum voltage fluctuations: $\pm 10\%$
Relative humidity	20-80 %
Fuses	Main fuse includes two protective fuses: 5 × 20 mm, 2.5A HRC (F) 250 VAC
Storage temperature	Analyzer: -20 °C to 60 °C Solution pack: 2-25 °C Sensor cassette: 2-10 °C Relative humidity: <95%
Altitude correction	Up to 3000 m above sea level
Barometric pressure and operating temperature	525-800 mmHg at 15-30 °C 70.0-106.7 kPa at 15-30 °C 0.700-1.067 bar at 15-30 °C 525-800 torr at 15-30 °C and 600-800 mmHg at 30-32 °C 80.0-106.7 kPa at 30-32 °C 0.800-1.067 bar at 30-32 °C 600-800 torr at 30-32 °C Operating temperature = 15-32 °C
Startup	Unconditioned sensor cassette: approx. 30 minutes, exclusive MET sensors; approx. 2 hours inclusive MET sensors. Conditioned sensor cassette: Not currently available
Pollution degree	2 (occasional/temporary conductivity caused by condensation)
Ventilation	The analyzer must be placed in a well-ventilated room to ensure proper calibration of pO_2 . The ventilation must be sufficient to ensure that the surrounding atmosphere corresponds to the normal outdoor atmosphere, so that the effect from devices that discharge gases to the atmosphere becomes negligible.

Analyzer specifications

Specifications	Thermostating	Solid state, 37.0 ± 0.15 °C (Oxi: ±0.3 °C)
	Spectrophotometer	Wavelength range: 467-672 nm
	Hemolyzer	Hemolyzation: at approximately 30 kHz Cuvette light path: approximately 0.01 cm
	External serial port	1 × RS-232 (9-pin) connector. Baud rate: 1200, 2400, 4800, 9600, 14400, 19200, 38400, 115200
	USB (Universal Serial Bus) ports	Three connectors for USB port
	Ethernet	1 × RJ45 connector, 100Base-Tx Fast Ethernet
	Keyboard/mouse	Keyboard/PS/2 mouse interface
	External VGA screen	Connector for VGA screen (disabled in BIOS setting)
	Printer	Built-in thermal; paper 112 mm wide
	Barcode reader	Built-in. Reading distance: 0 – 70 mm. Bar width: ≥127 μm (5 mil) Number of characters: <62 Code types: Code 128, code 39, I2 of 5
	Dimensions	Height: 45 cm (17.7 in.) with the vertical screen Width: 25 cm (9.8 in.) Depth: 29 cm (11.4 in.)
	Weight (kg)	11.1 (with accessories)

Approvals and patents

Approvals	UL, CSA. In compliance with <i>IEC 61010-1. Installation category II.</i>
CE-mark	Indicates compliance with the <i>In Vitro Diagnostic Directive 98/79/EC.</i>
EMC emission	The equipment complies with the emission requirements for Class B equipment in <i>EN 61326-1: Electrical equipment for measurement, control and laboratory use – EMC requirements part 1: General requirements.</i>
EMC immunity	The equipment complies with the immunity requirements in <i>EN 61326-2-6: Electrical equipment for measurement, control and laboratory use – EMC requirements - Part 2-6 Particular requirements - In vitro diagnostic (IVD) medical equipment</i>
Patents	One or more of the following patents and patent applications may apply: US Patent Nos.: US6551480, US6805781, US6980285, US7384523 European Patent Nos.: EP1084398, EP1086366, EP1269172, EP1644725 Japanese Patent Nos.: JP3369547, JP3635263, JP4503599 German Patent Nos.: DE69938550, DE60138694, DE69942250, DE602004025243 US Patent Application Nos.: US2008-0266545, US2008-0279487, US2009-0060789, US2010-0015691, US2010-0155239 European Patent Application Nos.: EP2142922, EP2147307, EP2150804 Japanese Patent Application Nos.: JP2010-525338, JP2010-525339, JP2010-525340 Chinese Patent Application Nos.: CN101688826, CN101688860, CN101715556 International Patent Application Nos.: WO2010/006603, WO2010/072223

14. Ordering information

Analyzer accessories.....	14-2
Quality control.....	14-3
Sampling devices.....	14-4

Analyzer accessories

Analyzer The following accessories are available on order for the ABL90 FLEX analyzer.

Sensor cassette Sensor cassettes are available in the following parameter configurations:

- BG: pH, $p\text{CO}_2$, $p\text{O}_2$
- LYT: $c\text{Ca}^{2+}$, $c\text{Cl}^-$, $c\text{K}^+$, $c\text{Na}^+$
- MET: $c\text{Glu}$, $d\text{Lac}$
- OXI: $ct\text{Hb}$, $s\text{O}_2$, $FO_2\text{Hb}$, $F\text{MetHb}$, $F\text{COHb}$, $F\text{HHb}$, $F\text{HbF}$, $ct\text{Bil}$

The sensor cassettes are valid for a specified number of tests and days.

Cassette	Number of tests over 30 days				
	50	100	300	600	900
SC90 BG, OXI + QC	946-021	946-020	946-019	946-018	946-017
SC90 BG, LYT, OXI + QC	946-016	946-015	946-014	946-013	946-012
SC90 BG, LYT, MET, OXI + QC	946-011	946-010	946-005	946-008	946-009

Germany only:

Cassette	Number of tests over 30 days				
	50	100	300	600	900
SC90 BG, LYT, OXI + QC	NA	NA	NA	NA	946-053
SC90 BG, LYT, MET, OXI + QC	NA	NA	946-051	946-052	946-009

NOTICE: Not all versions are available at the time of publication, and future variants may be introduced.

Solution pack

Item	Code no.	Type
ABL90 FLEX solution pack	944-157	-
ctHb Calibration Solution	944-021	S7770

Power cords

Item	Code No.
Line cord 120 V, USA and Japan	615-403
Line cord 230 V, UK	615-312
Line cord 230 V, ITA	615-313
Line cord 230 V, DK	615-314
Line cord 230 V, ISR	615-315
Line cord 230 V, CHE	615-316
Line cord 230 V, other 230 V countries	615-303
Line cord 230 V, AUS and NZA	615-317
Line cord 230 V, ZAF and IND	615-318

Other accessories

Item	Code No.	Type
Thermal paper (8 rolls)	984-070	-
Hypochlorite solution	943-906	S5362
Holder with inlet gasket	924-816	-
Inlet probe	924-455	-
Inlet connector gasket	834-662	-
Inlet	903-139	-
Tubing for valve	841-797	-
Disposable Clot Catcher for the ABL90 FLEX analyzer	906-026	-

Documentation

Item	Code No.
ABL90 FLEX operator's manual, English	994-526
ABL90 FLEX reference manual, English	994-527

Quality control**Accessories**

Item	Code No.
Ampoule opener	920-712
QUALICHECK adapter	924-646
QUALICHECK+ tray	887-860

**QUALICHECK5+
solution**

Item	Code No.	Type
Level 1 – RED	944-017	S7730
Level 2 – YELLOW	944-018	S7740
Level 3 – BLUE	944-019	S7750
Level 4 – GREEN	944-020	S7760

**Range+
QUALICHECK
solution**

Item	Code No.	Type
Level 1	944-151	S7930
Level 2	944-152	S7940
Level 3	944-153	S7950

**Metabolite+
QUALICHECK
solution**

Item	Code No.	Type
Level 1	944-249	S9570

Documentation

Item	Code No.
QUALICHECK short-form instructions	989-313

Sampling devices**Arterial blood
gas samplers**

Item	Code No.	Type
PICO50, 2 mL aspirator, 0.5-2.0 mL (100 units)	956-552	PICO50
PICO70 w/o needle, 0.3-1.5 mL (100 units)	956-518	PICO70
PICO70 w/o needle (w/o needle cube), 0.3-1.5 mL (100 units)	956-519	PICO70
PICO70 22G × 1", 0.3-1.5 mL (100 units)	956-522	PICO70
PICO70 22G × 1 1/4", 0.3-1.5 mL (100 units)	956-525	PICO70
PICO70 23G × 5/8", 0.3-1.5 mL (100 units)	956-529	PICO70
PICO70 23G × 1", 0.3-1.5 mL (100 units)	956-533	PICO70
PICO70 23G × 1 1/4", 0.3-1.5 mL (100 units)	956-534	PICO70
PICO70 23G × 5/8" (w/o needle cube), 0.3-1.5 mL (100 units)	956-546	PICO70
PICO70 25G × 5/8", 0.3-1.5 mL (100 units)	956-547	PICO70
PICO70 22G × 1" (w/o needle cube), 0.3-1.5 mL (100 units)	956-563	PICO70
<i>safe</i> PICO70 22G × 1 1/4" with needle shield device, 0.3-1.5 mL (100 units)	956-608	PICO70

<i>safe</i> PICO70 23G × 5/8" with needle shield device, 0.3-1.5 mL (100 units)	956-609	PICO70
<i>safe</i> PICO70 23G × 1" with needle shield device, 0.3-1.5 mL (100 units)	956-624	PICO70

Capillary samplers, glass

Item	Code No.	Type
CLINITUBES capillary tubes with balanced heparin, 100 µL including mixing wire and capillary caps (5 × 75 units)	942-878	D957G-70-100×5
CLINITUBES capillary tubes with balanced heparin, 100 µL including mixing wire and capillary caps (1 × 75 units)	905-663	D956G-70-100×1

Capillary samplers, plastic

Item	Code No.	Type
<i>safe</i> CLINITUBES with balanced heparin, 70 µL including mixing wire and capillary caps (1 × 250 units)	942-898	D957P-70-70×1

***safe*PICO samplers**

Item	Code No.	Type
<i>safe</i> PICO Self-fill without needle with <i>safe</i> TIPCAP, 0.7-1.5 mL (100 units)	956-610	-
^{*)} <i>safe</i> PICO Self-fill with <i>safe</i> TIPCAP, without needle shield device, 23G × 5/8", 0.7-1.5 mL (100 units)	956-612	-
^{*)} <i>safe</i> PICO Self-fill with <i>safe</i> TIPCAP, without needle shield device, 22G × 1", 0.7-1.5 mL (100 units)	956-613	-
<i>safe</i> PICO Self-fill with needle shield device and <i>safe</i> TIPCAP, 22G × 1 1/4", 0.7-1.5 mL (100 units)	956-614	-
<i>safe</i> PICO Self-fill with needle shield device and <i>safe</i> TIPCAP, 23G × 5/8", 0.7-1.5 mL (100 units)	956-615	-
<i>safe</i> PICO Self-fill with needle shield device and <i>safe</i> TIPCAP, 23G × 1", 0.7-1.5 mL (100 units)	956-616	-
<i>safe</i> PICO Self-fill with needle shield device and <i>safe</i> TIPCAP, 22G × 1", 0.7-1.5 mL (100 units)	956-620	-
<i>safe</i> PICO aspirator, 0.7-1.7 mL (100 units)	956-622	-

^{*)} With needle cube.

Index

A

ABL90 FLEX analyzer documentation 1-2
Access rights 2-17
Acid-base chart 4-17
Activity log 9-18
 adding message 9-18
 filter function 9-19
Adding a message to the log 9-18
Analysis check 5-7
Analyzer
 cleaning 7-16
 shutdown 10-1
Analyzer exterior
 cleaning 7-16
Analyzer requirements 13-6
Analyzer screen
 cleaning 7-17
Analyzer shutdown 10-1
 general information 10-2
 long-term shutdown 10-5
 programs 10-2
 restarting after temporary
 shutdown 10-4
 restarting the analyzer 10-6
 storing 10-6
 temporary shutdown 10-3
 transporting analyzer 10-6
Analyzer specifications 13-7
Analyzer startup 2-17
Analyzer status 3-1
 at a glance 3-2
 calibration 3-4
 other activities 3-7
 quality control 3-5
 replacement 3-6, 7-3
 system messages 3-7
Analyzer status elements 3-3
Analyzer, outer surfaces
 disinfection 7-17
Animal blood 1-4
Approval
 patient result 4-16
Approvals 13-8
Archived data logs 9-21
 converting archive 9-22
 moving archive 9-22
 selecting archive 9-21
Arterial blood samplers
 recommended 12-2
Audit trail, patient result 4-18
Automatic quality management
 system 5-2

B

Barcode reader 2-8
 entering patient information 4-10
 position of 2-8
 use 2-8
Barcode reader, built-in 2-8
Barometer 13-3
Blood
 animal blood measurements 1-4

Blood samplers
 recommended arterial blood
 samplers 12-2
 recommended capillary blood
 samplers 12-2
Built-in quality control 5-4
Built-in sample mixer 2-7

C

Calibration 6-1
 1- or 2-point result 6-5
 expired 6-3
 general information 6-2
 messages, result 6-7
 pending calibrations 6-3
 programs 6-2
 result 6-5
 tHb result 6-6
 unscheduled calibration 6-2
 verification 6-8
 viewing result 6-5
Calibration log 9-15
 filter function 9-16
 trend function 9-17
Calibration result 6-5
Calibration status 3-4
Calibration verification 6-8
 preparatory steps 6-8
 procedure 6-10
Capillary blood samplers
 recommended 12-2
Causes of error in the preanalytical
 phase 12-6
Check buttons 2-14
Cleaning
 analyzer 7-16
 analyzer exterior 7-16
 analyzer screen 7-17
 inlet 7-16
Common name 1-3
Sensor cassette pack with sensor
 cassette 2-9
Consumables 2-9
 Sensor cassette pack with sensor
 cassette 2-9
 solution pack 2-10

D

Data logs
 access 9-2
 archived 9-2
Data management 9-1
 access to data logs 9-2
 activity log 9-18
 archived data logs 9-21
 calibration log 9-15
 general information 9-2
 patient profiles log 9-6
 patient results log 9-3
 quality control log 9-9
 RADIANCE browser 9-23
 replacement log 9-20
Detachable power supply cord 2-5

Disinfection	7-17
outer analyzer surfaces	7-17
Disk functions	8-1
general information	8-2
programs	8-2

E

Expired calibrations	6-3
----------------------------	-----

F

Filter function	
Activity log	9-19
Calibration log	9-16
Patient results log	9-4
QC log	9-11
Front, analyzer	2-2
<i>F</i> Shunt and $ctO_2(a-\bar{v})$, determination	4-13

H

Hardware	2-2
barcode reader	2-8
built-in sample mixer	2-7
front	2-2
inlet module	2-6
rear	2-4
top	2-3

I

Initial logon	2-17
Inlet	
cleaning	7-16
Inlet connection gasket	
replacement	7-13
Inlet gasket	
replacement	7-10
Inlet module	2-6
Inlet probe	
replacement	7-12
Input parameters	13-4
Installation	7-1
Intended use	1-3
Interaction tools	
check buttons	2-14
screen keyboard	2-15
screen keypad	2-14
text box	2-13
Interfering substances	1-5
Introducing a blood sample with a capillary tube	4-8
Introducing a blood sample with a <i>safe</i> PICO sampler with barcode	4-5
Introducing a blood sample with a <i>safe</i> PICO sampler with barcode and sample pre-registration	4-6
Introducing a blood sample with a standard syringe	4-4
Introducing a blood sample with a test tube	4-9
Introduction	1-1

K

Keyboard, screen	2-15
Keypad, screen	2-14

L

Limitations of use	1-5
Logging system messages	11-3
Logs	
Activity log	9-18
archived data	9-21
Calibration log	9-15
Patient profiles log	9-6
Patient results log	9-3
Replacement log	9-20
Quality control log	9-9

M

Main screen	2-11
Manual QC measurement	
introducing QC solution	5-9
Manual QC results	
viewing	5-10
Manual quality control	5-8
Manual release of the solution pack ..	7-5
Measured parameters	1-3, 13-2
baro	13-3
Measurement	
<i>F</i> Hb <i>F</i>	1-5
sample	4-1
Menu	
structure	2-18
Messages	
patient results	4-19
Mixing a blood sample	
in a capillary	4-3, 4-8
in a syringe	4-3
in a test tube	4-3

N

Names	1-3
Common name	1-3
Proprietary name	1-3
Navigation tools	2-13

O

Operator requirements	1-4
Ordering information	14-1
accessories, analyzer	14-2
analyzer accessories	14-2
arterial blood gas samplers	14-4
capillary samplers, glass	14-5
capillary samplers, plastic	14-5
documentation	14-3
documentation, QC SFI	14-4
Metabolite+ QUALICHECK solution	14-4
other accessories	14-3
power cords	14-3
QUALICHECK5+ solution	14-4
Quality control accessories	14-3
Range+ QUALICHECK solution	14-4
<i>safe</i> PICO samplers	14-5
sampling devices	14-4
sensor cassette	14-2
solution pack	14-2
Other activities	
analyzer status	3-7

P

Parameter status	2-12
patient result	4-14

quality control.....	5-5, 5-10
Parameters	
derived parameters.....	13-4
input parameters.....	13-4
measured parameters.....	13-2
Password	
entering.....	2-17
Patents.....	13-8
Patient ID, recalling.....	4-15
Patient identification	
entering.....	4-10
Patient information	
entering information manually.....	4-10
entering information with barcode	
reader.....	4-10
patient lookup.....	4-11
selecting a report layout.....	4-12
selecting parameters after	
measurement.....	4-12
Patient profiles log.....	9-6
adding new profile.....	9-7
deleting profile.....	9-7
editing.....	9-7
finding profile.....	9-8
Patient result.....	4-14
acid-base chart.....	4-17
approval.....	4-16
audit trail.....	4-18
messages.....	4-19
parameter status.....	4-14
recalling patient ID.....	4-15
Patient results log.....	9-3
filter function.....	9-4
functions.....	9-4
trend function.....	9-5
Pending calibrations.....	6-3
Power supply cord.....	2-5
Preanalytical phase	
possible causes of errors.....	12-6
Preparations immediately before	
analysis.....	4-3
Printer paper	
replacement.....	7-9
Proprietary name.....	1-3

Q

QC statistics	
printing.....	9-14
viewing.....	9-12
Quality control.....	5-1
additional quality control.....	5-12
analysis check.....	5-7
automatic quality management	
system.....	5-2
built-in.....	5-4
general information.....	5-3
glossary list.....	5-3
identification.....	5-9
manual measurement.....	5-8
parameter status.....	5-5, 5-10
system check.....	5-6
temperature corrections.....	5-11
trend function.....	9-11
unknown solutions.....	5-11
unscheduled measurement.....	5-4
Quality control (QC) status.....	3-5
Quality control identification	
entering information manually.....	5-10
entering information with barcode	
reader.....	5-9

recalling.....	5-11
Quality control log.....	9-9
filter function.....	9-11
printing QC statistics.....	9-14
QC plot.....	9-10
viewing QC statistics.....	9-12
Quality control plot.....	9-10
Quality management.....	5-1

R

RADIANCE system	
accessing.....	9-23
browser.....	9-23
Rear, analyzer.....	2-4
Recalling quality control	
identification.....	5-11
Recommended capillary blood	
samplers.....	12-2
Replacement.....	7-1, 7-3
inlet connection gasket.....	7-13
inlet gasket.....	7-10
inlet probe.....	7-12
printer paper.....	7-9
screens during replacements.....	7-2
sensor cassette.....	7-5
solution pack.....	7-4, 7-8
viewing status.....	7-3
9-19, 9-20	
Replacement log.....	9-20
Replacement status.....	3-6, 7-3
Requirements	
analyzer.....	13-6
operator.....	1-4
Restarting the analyzer.....	10-6
Result	
patient.....	4-14

S

Sample handling.....	13-5
Sample measurement.....	4-1
available modes and parameters...4-2	
blood sample with a capillary tube.....	4-8
blood sample with a <i>safePICO</i>	
sampler with barcode.....	4-5
blood sample with a <i>safePICO</i>	
sampler with barcode and sample	
pre-registration.....	4-6
blood sample with a standard	
syringe.....	4-4
blood sample with a test tube.....	4-9
entering patient identification.....	4-10
immediately before analysis.....	4-3
patient result.....	4-14
test tube samples.....	4-9
Samplers	
recommended arterial blood	
samplers.....	12-2
recommended capillary blood	
samplers.....	12-2
Sampling.....	12-1
special considerations for capillary	
specimens.....	12-3
storage recommendations for	
whole-blood samples.....	12-5
storage time.....	12-5
temperature recommendations....	12-5
Sampling devices and procedures...12-2	
Sampling procedures.....	12-2
Screen	

main screen	2-11
Screen elements.....	2-11
button section	2-15
buttons	2-15
center section	2-12
information bar	2-16
interaction tools	2-13
navigation tools.....	2-13
parameter bar.....	2-12
status bar	2-11
time bar	2-11
top section.....	2-11
Screen keypad	2-14
Sensor cassette	7-5
configurations	1-4
parameters	1-4
replacement.....	7-5
variants.....	1-4
Software.....	2-11
screen	
elements	2-11
Solution pack	1-4, 2-10
manual release.....	7-5
replacement.....	7-4, 7-8
Special considerations for capillary	
specimens	12-3
Specifications	13-1
analyzer	13-7
analyzer requirements	13-6
approvals	13-8
derived parameters.....	13-4
input parameters.....	13-4
measured parameters	13-2
patents	13-8
sample handling	13-5
Startup	
analyzer	2-17
Storage recommendations	
special considerations	12-5
whole-blood samples	12-5
Substance	
interfering substances	1-5
Switching off the analyzer for a	
short time	10-3
Symbols	
accessories	1-6
analyzer	1-6
used in this manual	1-8

System check.....	5-6
System messages	
analyzer status.....	3-7

T

Temperature corrections.....	5-11
tHb calibration.....	6-4
procedure.....	6-4
purpose.....	6-4
Top, analyzer	2-3
Trend function	
Calibration log.....	9-17
Patient results log.....	9-5
QC log.....	9-11
Troubleshooting.....	11-1
analyzer action in case of error ...	11-2
general information	11-2
Logging system messages	11-3
operator actions in case of error ..	11-2
User-intervention-required causes	11-4

U

Unknown solutions (QC)	5-11
Unscheduled AutoCheck	
Measurement	5-5
Unscheduled calibration.....	6-2
Use	
intended.....	1-3
limitations	1-5
User-intervention-required causes ..	11-4

V

View manual QC results.....	5-10
-----------------------------	------

W

What is what.....	2-1
barcode reader.....	2-8
built-in sample mixer	2-7
front	2-2
Hardware	2-2
inlet module.....	2-6
rear	2-4
top	2-3

Date of issue

Radiometer representative:

Manufacturer:

RADIOMETER 

If you have any questions
or need assistance,
please contact your local
Radiometer representative.



Radiometer Medical ApS
Åkandevvej 21
2700 Brønshøj
Denmark
www.radiometer.com

ABL90 FLEX operator's manual
- from software version 2.8xx

Publication: 201207
Edition: A
Code number: 995-420



Date of issue

ABL90 FLEX operator's manual