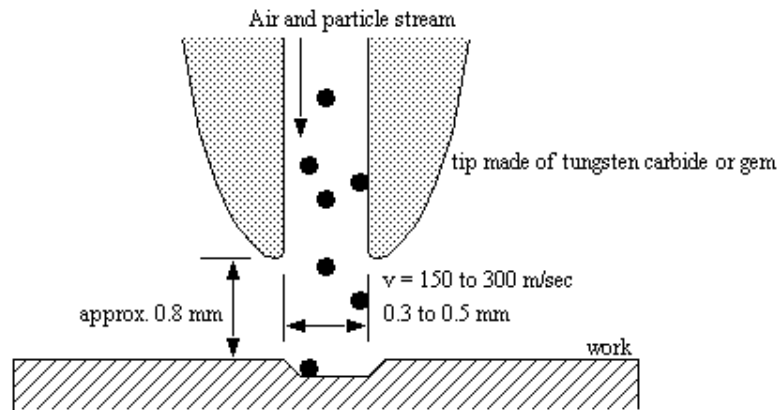

ABRASIVE JET MACHINING

Definition:

In abrasive jet machining, a focused stream of abrasive particles, carried by high pressure air or gas is made to impinge on the work surface through a nozzle and the work material is made to impinge on the work surface through a nozzle and work material is removed by erosion by high velocity abrasive particles.

Process:

In Abrasive jet machining abrasive particles are made to impinge on work material at high velocity. Jet of abrasive particles is carried by carrier gas or air. The high velocity stream of abrasives is generated by converting pressure energy of carrier gas or air to its Kinetic energy and hence high velocity jet. Nozzles directs abrasive jet in a controlled manner onto work material. The high velocity abrasive particles remove the material by micro-cutting action as well as brittle fracture of the work material.



This is a process of removal of material by impact erosion through the action of concentrated high velocity stream of grit abrasives entrained in high velocity gas stream. AJM is different from shot or sand blasting, as in AJM, finer abrasive grits are used and parameters can be controlled more effectively providing better control over product quality.

In AJM, generally, the abrasive particles of around 50 microns grit size would impinge on the work material at velocity of 200 m/s from a nozzle of ID 0.5mm with a stand off distance of around 2mm. The kinetic energy of the abrasive particles would sufficient to provide material removal due to brittle fracture of the work piece or even micro cutting by the abrasives.

Physics of the Process:

- Fine particles (0.025mm) are accelerated in a gas stream
- The particle are directed towards the focus of machining
- As the particles impact the surface, it causes a micro fracture, and gas carries fractured particles away
- Brittle and fragile work better

Equipment:

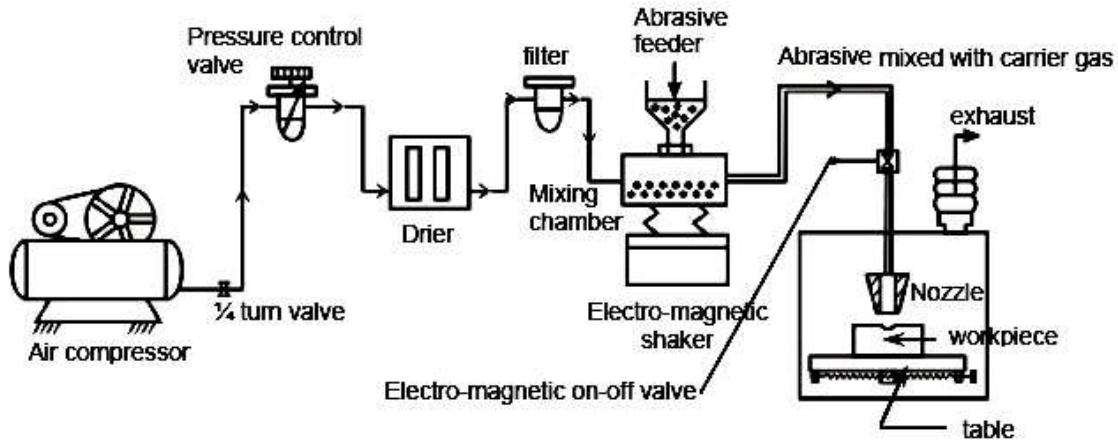

A schematic layout of AJM is shown above. The gas stream is then passed to the nozzle through a connecting hose. The velocity of the abrasive stream ejected through the nozzle is generally of the order of 330 m/sec.

Abrasive jet Machining consists of

1. Gas propulsion system
2. Abrasive feeder
3. Machining Chamber
4. AJM Nozzle
5. Abrasives

Gas Propulsion System

Supplies clean and dry air. Air, Nitrogen and carbon dioxide to propel the abrasive particles. Gas may be supplied either from a compressor or a cylinder. In case of a compressor, air filter cum drier should be used to avoid water or oil contamination of abrasive powder. Gas should be non-toxic, cheap, easily available. It should not excessively spread when discharged from nozzle into atmosphere. The propellant consumption is of order of 0.008 m³/min at a nozzle pressure of 5 bar and abrasive flow rate varies from 2 to 4 gm/min for fine machining and 10 to 20 gm/min for cutting operation.

Abrasive Feeder.

Required quantity of abrasive particles is supplied by abrasive feeder. The filtered propellant is fed into the mixing chamber where in abrasive particles are fed through a sieve. The sieve is made to vibrate at 50-60 Hz and mixing ratio is controlled by the amplitude of vibration of sieve. The particles are propelled by carrier gas to a mixing chamber. Air abrasive mixture moves further to nozzle. The nozzle imparts high velocity to mixture which is directed at work piece surface.

Machining chamber

It is well closed so that concentration of abrasive particles around the working chamber does not reach to the harmful limits. Machining chamber is equipped with vacuum dust collector. Special consideration should be given to dust collection system if the toxic material (like beryllium) are being machined.

AJM nozzle

AJM nozzle is usually made of tungsten carbide or sapphire (usually life – 300 hours for sapphire , 20 to 30 hours for WC) which has resistance to wear. The nozzle is made of either circular or rectangular cross section and head can be head can be straight, or at a right angle. It is so designed that loss of pressure due to the bends, friction etc is minimum possible. With increase in wear of a nozzle, the divergence of jet stream increases resulting in more stray cutting and high inaccuracy.

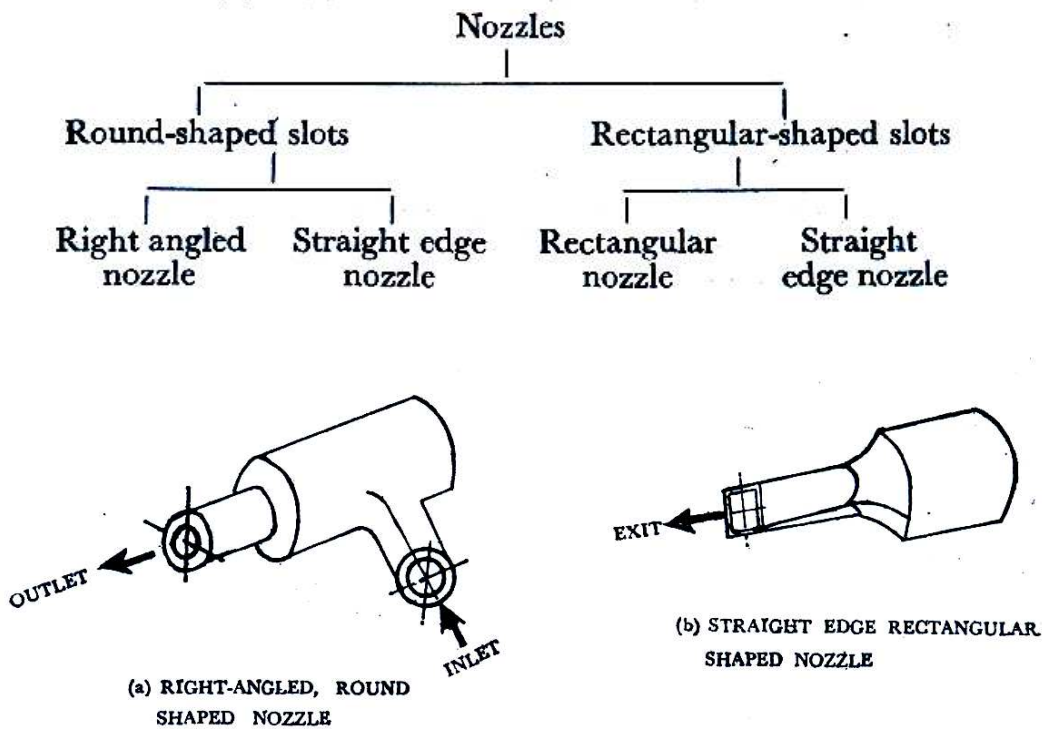

NOZZLE MATERIAL	ROUND SHAPE NOZZLE DIAMETER, MM	RECTANGULAR SHAPE SLOT, DIMENSION, MM	LIFE OF NOZZLE, HOURS
Tungsten Carbide (WC)	0.2 to 1.0	0.075 × 0.5 to 0.15 × 2.5	12 to 30
Sapphire	0.2 to 0.8	—	300

ABRASIVES

Aluminum oxide (Al₂O₃) Silicon carbide (SiC) Glass beads, crushed glass and sodium bicarbonate are some of abrasives used in AJM. Selection of abrasives depends on MRR , type of work material , machining accuracy.

Abrasives	Grain Sizes	Application
Aluminum oxide(Al ₂ O ₃)	12, 20, 50 microns	Good for cleaning, cutting and deburring
Silicon carbide (SiC)	25,40 micron	Used for similar application but for hard material
Glass beads	0.635 to 1.27mm	Gives matte finish
Dolomite	200 mesh	Etching and polishing
Sodium bi carbonate	27 micros	Cleaning, deburring and cutting of soft material Light finishing below 50 ⁰ C

Process parameters

For successful utilization of AJM process, it is necessary to analyze the following process criteria.

1. Material removal rate
2. Geometry and surface finish of work piece
3. wear rate of the nozzle

However, Process criteria are generally influenced by the process parameters as enumerated below:

- **Abrasives**
 - a) material – Al₂O₃ SiC Glass beads Crushed glass Sodium bi carbonate
 - b) shape – irregular/regular
 - c) Size – 10 to 50 microns
 - d) Mass flow – 2-20 gm/min

- **Carrier Gas**
 - a) Composition – Air, CO₂, N₂
 - b) Density – 1.3 kg/m³
 - c) Velocity – 500 to 700 m/s
 - d) Pressure – 2 to 10 bar
 - e) Flow rate – 5 to 30 microns

- **Abrasive Jet**
 - b) Velocity – 100 to 300 m/s
 - c) Mixing ratio – Volume flow rate of abrasives/Volume flow rate of gas
 - d) Stand off distance – SOD- 0.5 to 15mm.
 - e) Impingement angle – 60 to 90 deg.

- **Nozzle**
 - a) Material – WC/Sapphire
 - b) Diameter – 0.2 to 0.8 mm
 - c) Life – 300 hours for sapphire, 20 to 30 hours for WC

Process capability

1. Material removal rate – 0.015 cm³/min
2. Narrow slots – 0.12 to 0.25mm ± 0.12mm
- 3 Surface finish -0.25 micron to 1.25 micron
- 4 Sharp radius up to 0.2mm is possible
5. Steel up to 1.5mm ,Glass up to 6.3mm is possible to cut
6. Machining of thin sectioned hard and brittle materials is possible.

Applications

1. This is used for abrading and frosting glass more economically as compared to etching or grinding
2. Cleaning of metallic smears on ceramics, oxides on metals, resistive coating etc.
3. AJM is useful in manufacture of electronic devices , drilling of glass wafers, de burring of plastics, making of nylon and Teflon parts permanent marking on rubber stencils, cutting titanium foils
4. Deflashing small castings, engraving registration numbers on toughened glass used for car windows
5. Used for cutting thin fragile components like germanium, silicon etc.
6. Register treaming can be done very easily and micro module fabrication for electrical contact , semiconductor processing can also be done effectively.
7. Used for drilling , cutting , deburring etching and polishing of hard and brittle materials.
8. Most suitable for machining brittle and heat sensitive materials like glass, quartz, sapphire , mica , ceramics germanium , silicon and gallium.
9. It is also good method for deburring small hole like in hypodermic needles and for small milled slots in hard metallic components.

Advantages

1. High surface finish can be obtained depending upon the grain sizes

Particle size (in microns)	Surface roughness (in microns)
10	0.152 to 0.203
25 to 27	0.355 to 0.675
50	0.965 to 1.27

2. Depth of damage is low (around 2.5 microns)
3. It provides cool cutting action, so it can machine delicate and heat sensitive material
4. Process is free from chatter and vibration as there is no contact between the tool and work piece
5. Capital cost is low and it is easy to operate and maintain AJM.
6. Thin sections of hard brittle materials like germanium, mica, silicon, glass and ceramics can be machined.
7. It has the capability of cutting holes of intricate shape in hard materials.

Disadvantages /Limitations

1. Limited capacity due to low MRR. MRR for glass is 40 gm/minute
2. Abrasives may get embedded in the work surface, especially while machining soft material like elastomers or soft plastics.
3. The accuracy of cutting is hampered by tapering of hole due to unavoidable flaring of abrasive jet.
4. Stray cutting is difficult to avoid
5. A dust collection system is a basic requirement to prevent atmospheric pollution and health hazards.
6. Nozzle life is limited (300 hours)
7. Abrasive powders cannot be reused as the sharp edges are worn and smaller particles can clog the nozzle.
8. Short stand off distances when used for cutting , damages the nozzle.

Machining characteristics

Following are the AJM process criteria

1. Material removal rate
2. Geometry and surface finish of work piece
3. wear rate of the nozzle

Process criteria are generally influenced by the process parameters

The characteristics of above process parameters on process criteria are as follows

1. Effect of abrasive flow rate and grain size on MRR

It is clear from the figure that at a particular pressure MRR increase with increase of abrasive flow rate and is influenced by size of abrasive particles. But after reaching optimum value, MRR decreases with further increase of abrasive flow rate. This is owing to the fact that Mass flow rate of gas decreases with increase of abrasive flow rate and hence mixing ratio increases causing a decrease in material removal rate because of decreasing energy available for erosion.

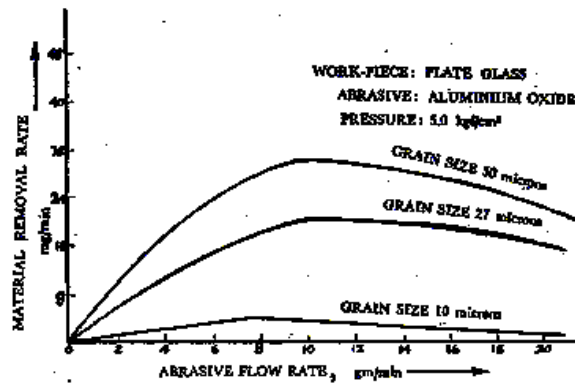

2. Effect of exit gas velocity and abrasive particle density

The velocity of carrier gas conveying the abrasive particles changes considerably with the change of abrasive particle density as indicated in figure.

The exit velocity of gas can be increased to critical velocity when the internal gas pressure is nearly twice the pressure at exit of nozzle for the abrasive particle density is zero. If the density of

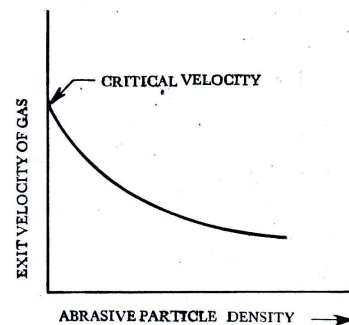

abrasive particles is gradually increased exit velocity will go on decreasing for the same pressure condition. It is due to fact that Kinetic energy of gas is utilized for transporting the abrasive particle

3.Effect of Mixing ratio on MRR

Increased mass flow rate of abrasive will result in a decreased velocity of fluid and will thereby decreases the available energy for erosion and ultimately the MRR. It is convenient to explain to this fact by term MIXING RATIO. Which is defined as

$$\text{Mixing ratio} = \frac{\text{Volume flow rate of carrier gas}}{\text{Volume flow rate of carrier gas}}$$

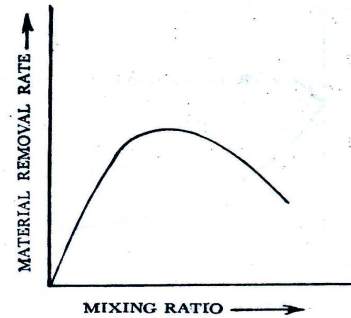

The effect of mixing ratio on the material removal rate is shown above.

The material removal rate can be improved by increasing the abrasive flow rate provided the mixing ratio can be kept constant. The mixing ratio is unchanged only by simultaneous increase of both gas and abrasive flow rate.

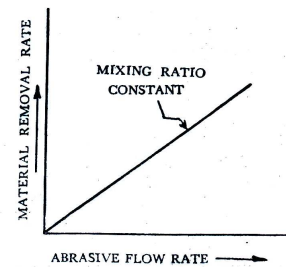

An optimum value of mixing ratio that gives maximum MRR is predicted by trial and error. In place of Mixing ratio, the mass ratio (α) may be easier to determine. Which is defined as

$$\alpha = \frac{\text{Mass flow rate of carrier gas}}{\text{Mass flow rate of carrier gas and abrasive}} = \frac{m_a}{m_{a+g}}$$

3.Effect of Nozzle pressure on MRR

The abrasive flow rate can be increased by increasing the flow rate of the carrier gas. This is only possible by increasing the internal gas pressure as shown in the figure. As the internal gas pressure increases abrasive mass flow rate increase and thus MRR increases.

As a matter of fact, the material removal rate will increase with the increase in gas pressure

Kinetic energy of the abrasive particles is responsible for the removal of material by erosion process. The abrasive must impinge on the work surface with minimum velocity for machining glass by SIC particle is found to be around 150m/s.

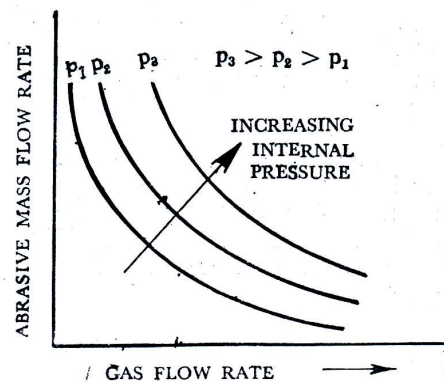

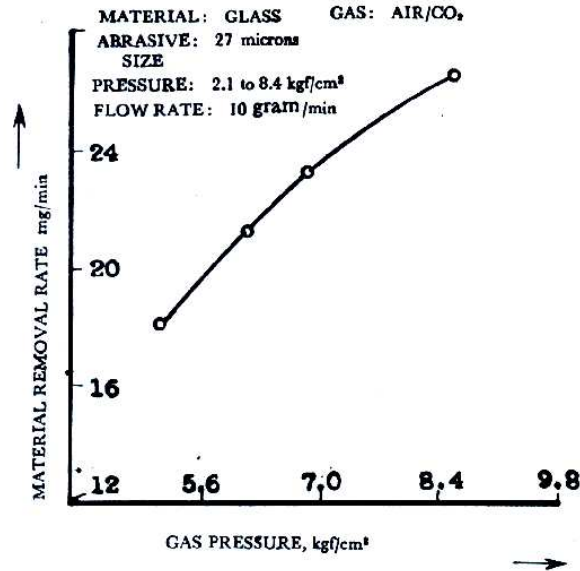

5. Stand off distance.

Stand off distance is defined as the distance between the face of the nozzle and the work surface of the work. SOD has been found to have considerable effect on the work material and accuracy. A large SOD results in flaring of jet which leads to poor accuracy.

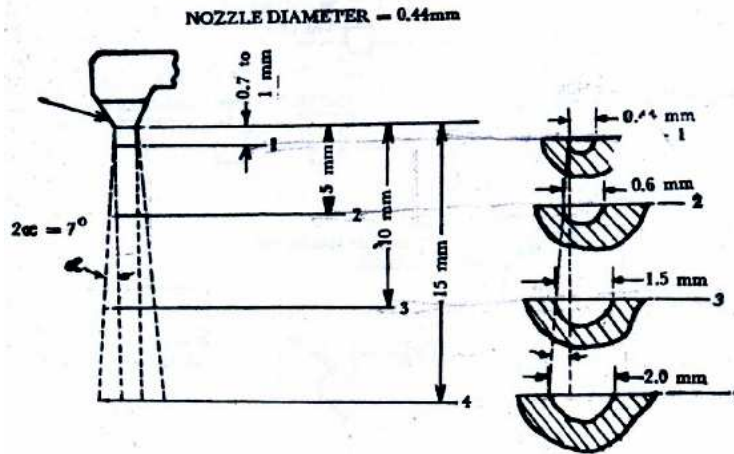

Fig 2.11 Effect of stand-off distance on width of cut

It is clear from figure that MRR increase with nozzle tip distance or Stand off distance up to certain distance and then decreases. Penetration rate also increases with SOD and then decreases. Decrease in SOD improves accuracy, decreases kerfwidth, and reduces taper in machined groove. However light operation like cleaning, frosting etc are conducted with large SOD.(say 12.5 to 75mm)

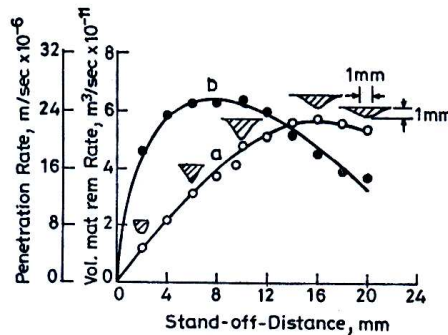

Fig. 2.2 Effects of stand-off-distance on material removal rate (• penetration rate, ○ volumetric material removal rate) [Verma and Lal, 1984].

Material removal models in AJM

Following assumptions are made in deriving the Material removal models for AJM.

1. Abrasive are spherical in shape and rigid
2. Kinetic energy of particle is completely used to cut the material
3. Brittle material are considered to fail due to brittle fracture and fracture of volume is considered to be hemispherical with diameter equal to chordal length of indentation
4. For Ductile material volume of material removal is assumed to be equal to indentation volume due to particulate impact.

Abrasive particles are assumed to be spherical in shape having diameter d_g .

From the geometry

$$AB^2 = AC^2 + BC^2$$

$$\left(\frac{d_g}{2}\right) = \left(\frac{d_g}{2} - \delta\right)^2 + r^2$$

$$\left(\frac{d_g}{2}\right) - \left(\frac{d_g}{2} - \delta\right)^2 = r^2$$

$r^2 = -\delta^2 + d_g \delta$ Neglecting δ^2 term we can write
 $r = \sqrt{d_g \delta}$

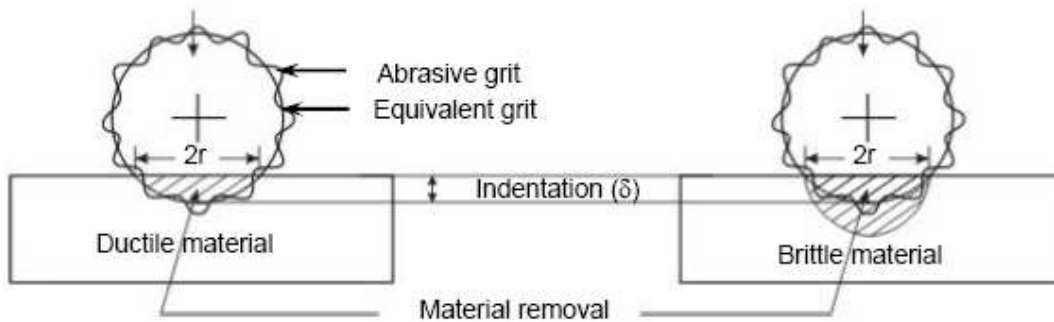
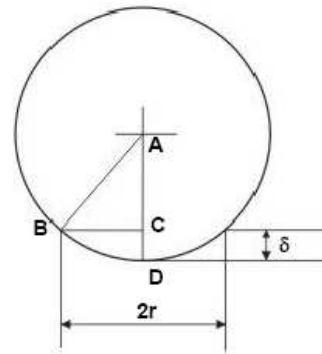

For Brittle material

Volume of the material removed is the volume of the hemispherical crater due the fracture is given by

Volume of the material removed

$$\Gamma_B = \frac{1}{2} \left[\frac{4}{3} \pi r^3 \right] = \frac{1}{2} \left[\frac{4}{3} \pi (r)^3 \right] = \left[\frac{2}{3} \pi (d_g \delta)^{\frac{3}{2}} \right] \text{-----(1)}$$

Let us assume that grits also move with velocity (V) then we can write

$$\text{Kinetic Energy} = \text{KE} = \left[\frac{1}{2} M (V)^2 \right] = \left[\frac{1}{2} \left(\frac{\pi}{6} d_g^3 \rho_g \right) (V)^2 \right] \text{-----(2)}$$

On impact , work material would be subjected to maximum force F, Which would leads to indentation of δ .

Work done during such indentation is

$$\text{W D by the grit} = \frac{1}{2} F \delta \text{-----(3)}$$

$$\text{Also we know the Flow strength of material} = \sigma_w = \frac{F}{\pi r^2} \text{ or } F = \sigma_w \pi r^2 \text{-----(4)}$$

$$F = \sigma_w \pi (d_g \delta)^2$$

Using equation (4) in (3) we get.

$$\text{W D by the grit} = \frac{1}{2} F \delta = \frac{\sigma_w \pi (d_g \delta)^2 \delta}{2}$$

It is assumed that Kinetic energy of the abrasives is fully used for material removal

Kinetic energy of the particle = W D by the particle

$$\left[\frac{1}{2} \left(\frac{\pi}{6} d_g^3 \rho_g \right) (V)^2 \right] = \frac{\sigma_w \pi (d_g \delta)^2 \delta}{2}$$

Simplifying we get

$$\delta = V d_g \sqrt{\frac{\rho_g}{6\sigma_w}} \text{-----(5)}$$

MRR in AJM material can be expressed as

$$\text{MRR} = \left\{ \begin{array}{l} \text{Volume of the material} \\ \text{removed} \\ \text{per grit per cycle.} \end{array} \right\} X \left\{ \begin{array}{l} \text{Number of} \\ \text{impacts made by} \\ \text{abrasives per second} \end{array} \right\}$$

$$\text{MRR} = \Gamma_B X \left[\frac{\text{Mass flow rate of abrasives}}{\text{Mass of the abrasive grit}} \right]$$

$$= \left[\frac{2}{3} \pi (d_g \delta)^3 \right] \times \frac{M_a}{\frac{\pi}{6} (d_g)^3 \rho_g}$$

Upon simplifying we get

$$\text{MRR} = \left[\frac{M_a}{(\rho_g)^{\frac{1}{4}} (\sigma_w)^{\frac{3}{4}}} \right]$$

For ductile material

$$\Gamma_D = \frac{1}{2} \left[\pi (d_g) (\delta)^2 \right]$$

$$\text{MRR} = \Gamma_D \times \left[\frac{\text{Mass flow rate of abrasives}}{\text{Mass of the abrasive grit}} \right]$$

Substituting and simplifying we get.

$$\text{MRR} = \left[\frac{M_a V^2}{2 \sigma_w} \right]$$

Problem 1 : Estimate the MRR in AJM of a brittle material with flow strength of 4 GPA. The abrasive flow rate is 2 gm/min, velocity is 200m/s, density of abrasive is 3 gm/sec.

Data Given:

Flow strength of work material = $\sigma_w = 4 \times 10^9 \text{ N/m}^2 = 4000 \text{ N/mm}^2$

Abrasive grain density = $3 \text{ gm/CC} = 3 \times 10^{-3} \times 10^{-3} = 3 \times 10^{-6} \text{ kg/mm}^3$

Mass flow rate of abrasives $\rho_g = 2 \text{ gm/min} = 2 \times 10^{-3} / 60 \text{ kg/sec}$

Velocity = $V = 200 \times 1000 \text{ mm/sec}$

Solution

Since the material is brittle. We need to use the MRR formula corresponding to The brittle material.

$$\text{MRR}_{\text{Brittle}} = \left[\frac{M_a v}{(\rho_g)^{\frac{1}{4}} (\sigma_w)^{\frac{3}{4}}} \right] = \left[\frac{2 \times 10^{-3} \times 200000^{\frac{3}{2}}}{(3 \times 10^{-6})^{\frac{1}{4}} (4 \times 10^9)^{\frac{3}{4}}} \right]$$

$$= 48 \text{ mm}^3 / \text{minutes}$$

Problem 2 : Material removal rate in AJM is 0.5 mm³/sec. calculate MRR/impact if the mass flow rate of abrasive is 3gm/min, density is 3 gm/CC and grit size is 60 microns . Also calculate the indentation radius.

Data Given:

Material removal rate = 0.5 mm³/sec.

Abrasive grain size = 60 microns = 6x10⁻³ mm

Mass flow rate of abrasives $\rho_g = 3\text{gm/min} = 3 \times 10^{-3}/60 \text{ kg/sec}$

$$\text{Mass of grit} = \left[\left(\frac{\pi}{6} d_g^3 \rho_g \right) \right]$$

$$\text{MRR} = \text{Volume of the material removed} \times \frac{\text{Mass flow rate of abrasives}}{\text{Mass of abrasive grit}}$$

$$0.5 \times 10^{-6} = \frac{2}{3} \pi (r)^3 \times \left[\frac{\frac{3}{1000 \times 60}}{\frac{\pi \left(\frac{60}{10000} \right)^3}{6} \frac{3}{1000 \times 10^{-6}}} \right] = 10 \text{ microns}$$

$$\text{MRR} = \left\{ \begin{array}{l} \text{Volume of the material} \\ \text{removed} \\ \text{per grit per cycle.} \end{array} \right\} \times \left\{ \begin{array}{l} \text{Number of} \\ \text{impacts made by} \\ \text{abrasives per second} \end{array} \right\}$$

$$\text{Number of impact/time} = \left[\frac{6 \times \frac{3 \times 10^{-3}}{60}}{\pi \times \left(50 \times 10^{-6} \right)^3 \times 3000} \right] = 254648$$

Problem 3: During AJM , Mixing ratio used is 0.2. calculate Mass ratio, if the ratio of density of abrasives and density of carrier gas is equal to 20.

Solution :

$$\text{Mixing ratio(MR)} = \frac{\text{Volume flow rate of abrasive particle}}{\text{Volume flow rate of carrier gas}}$$

$$\text{Mass ratio}(\alpha) = \frac{\text{Abrasive mass flow rate}}{\text{combined mass flow rate of abrasive and carier gas}}$$

$$\text{MR} = \frac{\dot{V}_a}{\dot{V}_g} \quad \text{also} \quad \alpha = \frac{M_a}{M_{a+g}} = \frac{\rho_a \dot{V}_a}{\rho_a \dot{V}_a + \rho_g \dot{V}_g}$$

$$\text{Or} \quad \frac{1}{\alpha} = \frac{\rho_a \dot{V}_a + \rho_g \dot{V}_g}{\rho_a \dot{V}_a} = 1 + \left[\frac{\rho_g}{\rho_a} \right] \left[\frac{\dot{V}_g}{\dot{V}_a} \right] = 1 + \frac{1}{20} \times \frac{1}{0.2}$$

$$\text{i.e} \quad \frac{1}{\alpha} = 1.25 \quad \text{or} \quad \alpha = 0.80$$

Problem 4: Diameter of nozzle is 1.0mm and jet velocity is 200m/s. Find the volumetric flow rate (cm^3/sec) of carrier gas and abrasive mixture.

$$\text{Cross sectional area of nozzle} = (\pi \times 0.5^2 \times 10^{-2}) = \pi \times 25 \times 10^{-4} \text{ cm}^2$$

$$\begin{aligned} \text{Volumetric flow rate of carrier gas and abrasive mixture is} &= \text{area} \times \text{velocity} \\ &= \pi \times 25 \times 2 \\ &= 50 \pi \text{ cm}^3 / \text{Sec} \end{aligned}$$

Practice Problem

1. Find out the condition for which AJM will produce equal MRR both for ductile and brittle materials. (Hint : equate MRR equations and find the condition for critical velocity)

2. Material removal rate in AJM is $0.3 \text{ mm}^3/\text{sec}$. calculate MRR/impact if the mass flow rate of abrasive is $4 \text{ gm}/\text{min}$, density is $1.5 \text{ gm}/\text{CC}$ and grit size is 23 microns Also calculate the indentation radius

3. During AJM , Mixing ratio used is 0.3. Calculate Mass ratio, if the ratio of density of abrasives and density of carrier gas is equal to 10

Give reasons for the following

1. Abrasive machining is not suitable for soft materials
2. Working temperature should be less than 50°C if we use Sodium bicarbonate abrasive particle
3. Abrasive particles in AJM cannot be reused.
4. Dust collection system is needed for Abrasive jet machining of beryllium
5. In AJM, MRR for ductile material is lower than Brittle materials.

Review Questions

1. With the help of neat diagram explain Abrasive jet machining system and label the parts.
2. What are the advantages and limitations of AJM?
3. Discuss the effect of following process parameters on MRR
 - SOD and MRR
 - Effect of abrasive grain size and flow on MRR
 - Effect of Nozzle pressure for various MR on MRR
 - Effect of Mixing ratio on MRR
6. Derive an expression for MRR in AJM for brittle material
7. Write at least five application of AJM in Industry
8. State clearly the process capability of AJM
9. Define AJM. What is the principle of Abrasive jet machining
10. Write the applications of different types of abrasives used in AJM.
11. Write five important variables of AJM process. Draw a sketch showing the effect of these variables on MRR
12. Explain the working principle of AJM process
13. With the help of sketches, show the effect of stand off distance on MRR.

