

ACCESSORIES

ACCESSORIES INTRODUCTION



OPTIMIZE PERFORMANCE AND SIMPLIFY INSTALLATION

Clog Prevention

- Liquid strainers
- Filtration assemblies
- Air line filters

Ensure Proper Flow Control and Regulation

- Solenoid valves, pressure relief valves and more
- Air pressure regulators
- Liquid pressure regulators

Simplify Nozzle Mounting and Positioning

- Split-eyelet connectors
- Swivels
- Fittings

SIMPLIFY INSTALLATION, OPERATION AND MAINTENANCE:



Prevent particles and debris from obstructing flow with nozzle and fluid line strainers. Choose from a wide range of inlet connections, materials, mesh size and more. **See page G4**



Regulate liquid pressure from 5 to 125 psi (0.3 to 8.5 bar) with our durable diaphragm-type non-relieving liquid regulators. Choose from a wide range of materials. **See page G12**



Connect nozzles to pipes in minutes with leak-proof split-eyelet connectors. Connectors clamp on 1/4" to 4" pipes. **See page G19**

ACCESSORIES

TABLE OF CONTENTS



LIQUID STRAINERS

	PAGE
TWD, 16106, 9830 and AA122 Strainers	G4
AA124/AA430 Strainers	G5

AIR LINE FILTERS

	PAGE
11438 Filters	G9

LIQUID PRESSURE GAUGES

	PAGE
26383 and 26385 Gauges	G11

LIQUID AND AIR PRESSURE REGULATORS

	PAGE
11438 Regulators	G12

SOLENOID VALVES

	PAGE
2-Way and 3-Way Valves	G14

BALL VALVES

	PAGE
AA(B)344M Valves	G16

PLUG VALVES

	PAGE
23220 Valves	G17

MOUNTING & POSITIONING ACCESSORIES

	PAGE
Extensions	G18
Split-Eyelet Connectors	G19
Mounting Kits	G21
Spray Pipe Assembly	G21
Pipe Hanger	G22
Wall Mount Adapters	G22

OTHER ACCESSORIES

	PAGE
Pressure Tanks	G23
Float Box and Valve	G23
Level Switches	G24
Ajustable Siphon Injector	G25

OVERVIEW: LIQUID STRAINERS

- Liquid strainers protect nozzles, valves and pumps from damaging debris and minimize clogging
- Wire mesh options ensure screening of particulate as small as 63 microns

T-Style Strainer

T-strainers feature a removable bottom cap or plug for complete withdrawal of the screen assembly during cleaning. On some models, the bottom pipe plug can be replaced with a drain cock for quick-flush cleaning. Models with a clear nylon bowl allow easy visual inspection of the internal screen. Self-clean designs allow filtered liquid to pass through, while liquid particles are returned back to the liquid supply through a return outlet.

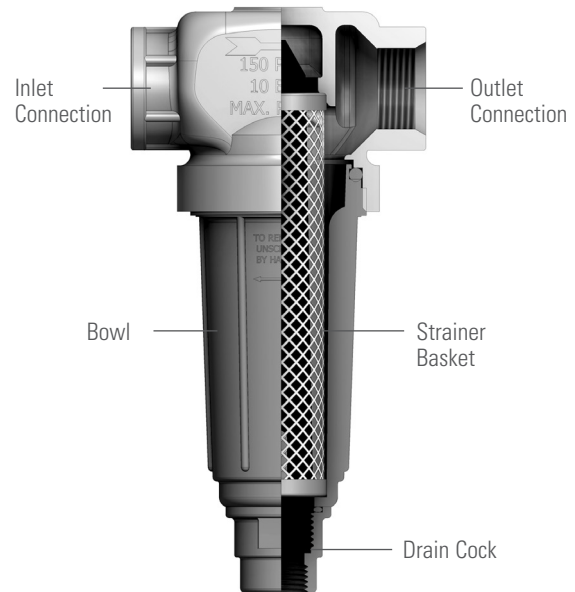
**STRAINER OPTIONS****TWD**

- 1/4", 3/8", 1/2", 3/4", 1", 1-1/4", 1-1/2", 2", 2-1/2" female conn.
- Removable bottom plug for easy screen cleaning
- Bottom plug can be replaced with drain cock for flush cleaning
- Max. pressure: 300 psi (20 bar)
- Materials: Aluminum, brass, stainless steel
- Mesh: 16, 30, 50, 80, 100, 40 x 200 Dutch weave

**16106**

- 1-1/2", 2", 2-1/2" female conn.
- Removable bottom plug for easy screen cleaning
- Bottom plug can be replaced with drain cock for flush cleaning
- Max. pressure: 200 psi (14 bar)
- Materials: Brass, stainless steel
- Mesh: 16, 50, 80, 100

**9830**

- 3/4", 1" female conn.
- Hand removable ribbed bottom cap for easy cleaning of screen
- Max. pressure: 300 psi (20 bar)
- Materials: Aluminum, brass, ductile iron
- Mesh: 16, 50, 100

**AA122**

- 1/2", 3/4" female conn.
- Hand removable outer bowl for easy screen cleaning
- Max. pressure: 150 psi at 100°F (10 bar at 38°C)
- Materials: Polypropylene, polypropylene head with clear nylon bowl
- Mesh: 15, 30, 50, 80, 100, 200, 40 x 200 Dutch weave



STRAINER OPTIONS

AA124/AA430

- 3/4", 1", 1-1/4", 1-1/2", 2", 2-1/2" female conn. (Inlet connections vary. See pages G7 and G8.)
- Larger size screen area requires less frequent cleaning
- Self-cleaning styles and versions with mounting lugs available
- AA124 and AA430 versions are the same except for materials and inlet connections



Strainer Type	Strainer Part No.	Material*	Max. Pressure	Mesh Sizes
124	AA124-AL	Aluminum head/nylon bowl	150 psi (10 bar)	16, 30, 50, 80, 100
124ML with mounting holes**	AA124ML-AL	Aluminum head/nylon bowl	150 psi (10 bar)	16, 30, 50, 80, 100
124A self-cleaning version	AA124ASC-NYB	Aluminum head/nylon bowl	110 psi (8 bar)	16, 30, 50, 80, 100
430ML with mounting holes**	AA430ML	Polypropylene head/nylon bowl	110 psi (8 bar)	16, 30, 50, 80, 100, 120, 200***
430 self-cleaning version	AA430SC	Polypropylene head/nylon bowl	75 psi (5 bar)	16, 30, 50, 80, 100, 120, 200***

* Max. temperature for plastic 100°F (38°C); max. temperature for metal 180°F (82°C).

** For mounting on machinery or angle iron.

*** 120 only for 1-1/4" and 1-1/2" sizes; 200 only for 3/4" and 1" sizes.

MESH SELECTION GUIDE

Mesh Size	Wire Dia. (in.)	Mesh Opening (in.)	Mesh Opening (microns)	Percentage Open Area	Orifice Dia. (in.)
16	0.016	0.045	1143	55.4	0.032 and larger
20	0.016	0.0340	864	46.2	0.032 and larger
30	0.012	0.0213	541	40.8	0.032 and larger
50	0.009	0.0110	279	30.3	0.032 and larger
60	0.0075	0.0092	234	30.5	0.019 through 0.031
80	0.0055	0.0070	177	31.4	0.019 through 0.031
100	0.0045	0.0055	140	30.3	0.019 through 0.031
120	0.0037	0.0046	118	30.1	0.019 through 0.031
200	0.0021	0.0029	74	33.6	Up through 0.018
40 x 200 Dutch Weave	0.007 x 0.005	0.003	63	—	Up through 0.018

MATERIAL OPTIONS

Material	Code
Aluminum	AL
Brass	B
Ductile Iron	No code
Nylon	NYB
Polypropylene	PP
Polypropylene head/clear nylon bowl	NYC
303 stainless steel	SS
316 stainless steel	316SS

PLACING YOUR ORDER

Call 1.800.95.SPRAY for application assistance or to place an order.



ORDERING INFORMATION

TWD STRAINER

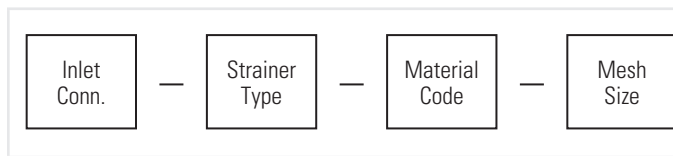

EXAMPLE



BSPT connections require the addition of a "B" prior to the inlet connection.

16106 STRAINER

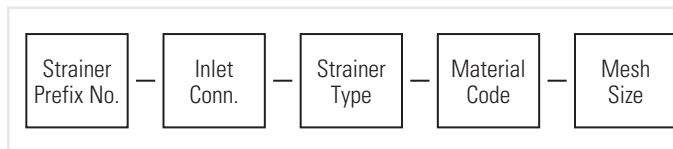

EXAMPLE



BSPT connections require the addition of a "B" prior to the inlet connection.

9830 STRAINER

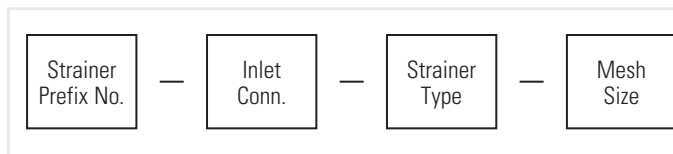

EXAMPLE



BSPT connections require the addition of a "B" prior to the inlet connection.

AA122 STRAINER

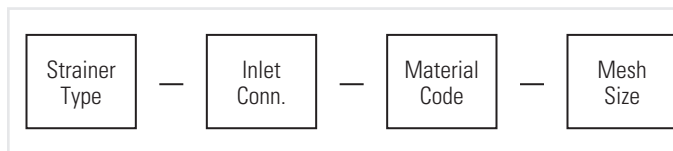

EXAMPLE



BSPT connections require the addition of a "B" prior to the inlet connection.

AA124/AA430 SELF-CLEANING STRAINER

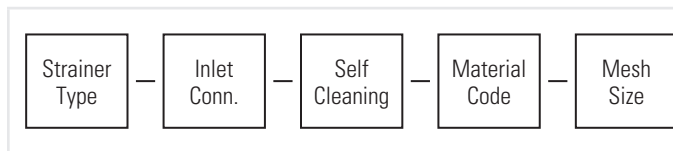

EXAMPLE



BSPT connections require the addition of a "B" prior to the inlet connection.

PLACING YOUR ORDER

Call 1.800.95.SPRAY for application assistance
or to place an order.



DIMENSIONS AND WEIGHTS

Strainer	Accessory Type	Inlet Conn. (in.)	L (in.)	W (in.)	A (in.)	B (in.)	C (in.)	Net Weight (oz.)
	TWD	1/4	3.922	2.500	–	3.235	–	24.9
		3/8	4.905	3.250	–	3.965	–	28.2
		1/2	4.905	3.250	–	3.965	–	28.2
		3/4	7.535	4.500	–	6.225	–	80.4
		1	7.535	4.500	–	6.225	–	76.7
		1-1/4	10.320	6.000	–	8.380	–	190.2
		1-1/2	10.320	6.000	–	8.380	–	183.5
		2	12.365	8.000	–	9.805	–	357.8
2-1/2	12.365	8.000	–	9.805	–	334.1		
	16106	1-1/2	9.0	7.250	–	7.240	–	188.9
		2	11.310	9.250	–	8.940	–	416.2
		2-1/2	11.310	9.250	–	8.940	–	392.9
	9830	3/4	8.180	5.250	–	7.187	–	140.6
		1	8.180	5.250	–	7.187	–	136.8
	AA122	1/2	4.014	3.063	–	3.625	–	3.4
		3/4	4.014	3.063	–	3.625	–	3.2
	AA124	1-1/4	9.400	5.344	–	8.020	–	77.2
		1-1/2	9.400	5.344	–	8.020	–	76.9
		2	12.000	7.438	–	10.000	–	215.2
		2-1/2	12.000	7.438	–	10.000	–	204.9

Based on the largest/heaviest version of each type.

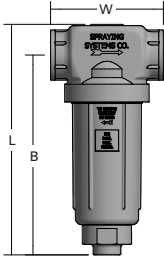
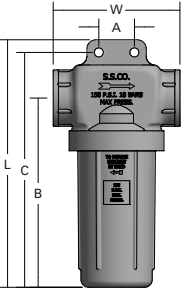
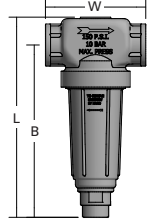
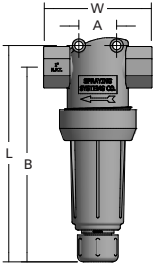
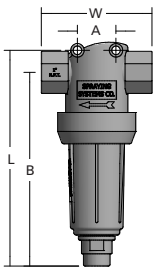

DIMENSIONS AND WEIGHTS

Strainer	Accessory Type	Inlet Conn. (in.)	L (in.)	W (in.)	A (in.)	B (in.)	C (in.)	Net Weight (oz.)
	AA124SC	1-1/4	8.750	5.343	–	7.355	–	53.3
		1-1/2	8.750	5.343	–	7.355	–	52.2
	AA124ML	3/4	7.953	4.188	1	5.891	7.453	31.0
		1	7.953	4.188	1	5.891	7.453	30.3
		1-1/4	9.688	5.344	1.5	7.234	9.156	41.6
		1-1/2	9.688	5.344	1.5	7.234	9.156	39.2
		2	14.480	7.438	2.375	11.234	13.855	107.9
		2-1/2	14.480	7.375	2.375	11.234	13.855	103.0
	AA124ASC	3/4	8.325	4.188	–	7.170	–	52.5
		1	8.325	4.188	–	7.170	–	50.4
	AA430ML	3/4	8.855	4.510	1.575	7.955	–	15.2
		1	8.855	4.510	1.575	7.955	–	14.1
		1-1/4	11.791	5.600	1.535	10.534	–	32.5
		1-1/2	11.791	5.600	1.535	10.534	–	33.2
	AA430MLSC	3/4	8.738	4.510	1.575	7.838	–	21.9
		1	8.738	4.510	1.575	7.838	–	21.2
		1-1/4	11.816	5.600	1.535	10.561	–	31.0
		1-1/2	11.816	5.600	1.535	10.561	–	31.7

Based on the largest/heaviest version of each type.



AIR LINE FILTERS

- Air line filters protect equipment from corrosion and excessive wear by removing liquid and contaminants from air lines
- Manual drain air line filter – simple petcock at the bottom of the bowl enables manual drainage; filter is easily accessible
- Automatic drain air line filter – for use in inaccessible locations; a float-operated mechanism automatically expels liquid when over a critical level
- 1/4", 3/8", 1/2", 3/4", 1" female conn.
- 50 micron filter element
- Max. pressure: 150 psi (10 bar)
- Max. temperature: 125°F (50°C)



11438 Air Line Filter

AIR LINE FILTER SELECTION GUIDE

Air Line Filter No.	Air Line Filter Type		Inlet Conn. (in.)	Approx. Flow at 100 psi*	
	Manual	Automatic		scfm	lpm
11438-1	•		1/4	50	1415
11438-2	•		3/8	50	1415
11438-3	•		1/2	150	4250
11438-4	•		3/4	345	9770
11438-5	•		1	445	12600
11438-16		•	1/4	50	1415
11438-17		•	1/2	150	4250
11438-19		•	1	445	12600

*With 5 psi pressure drop through filter.

11438-1, -2, -3, -16 and -17 have screw-on transparent polycarbonate bowls with bowl guards to prevent breakage. Not suitable for use in systems with air compressors lubricated with fire-resistant synthetics.

PLACING YOUR ORDER

Call 1.800.95.SPRAY for application assistance or to place an order.



ORDERING INFORMATION

11438 AIR LINE FILTER

<div style="border: 1px solid black; padding: 5px; display: inline-block;">Air Line Filter No.</div>	<p>EXAMPLE</p> <div style="border: 1px dashed black; padding: 5px; display: inline-block; margin: 10px auto;">11438-1</div>
--	---

BSPT connections require the addition of a "B" prior to the inlet connection.

DIMENSIONS AND WEIGHTS

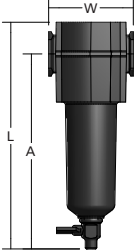
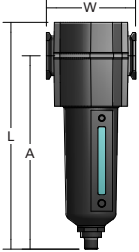
Air Line Filter	Accessory Type	Inlet Conn. (in.)	L (in.)	W (in.)	A (in.)	Net Weight (oz.)
	11438-1	1/4	6.625	2.750	5.938	21.1
	11438-2	3/8	6.625	2.750	5.938	17.7
	11438-3	1/2	7.375	3.906	6.688	28.8
	11438-4	3/4	11.500	4.750	10.438	18.4
	11438-5	1	11.500	4.750	10.438	73.8
	11438-6	1-1/2	17.563	8.220	15.700	24
	11438-16	1/4	7.000	3.625	6.313	21.1
	11438-17	1/2	7.000	3.453	6.313	29.4
	11438-19	1	11.125	4.750	10.063	73.3

Based on the largest/heaviest version of each type.

PLACING YOUR ORDER

Call 1.800.95.SPRAY for application assistance or to place an order.



LIQUID PRESSURE GAUGES

- Easy-to-read gauges with bottom inlet connection or center back connection
- Patented spring-suspended movement protected by a corrosion- and impact-resistant ABS housing with polycarbonate window
- Dual scales: psi and bar
- Grade B accuracy within $\pm 2\%$ in the middle 50% of the scale, with 3% accuracy in the high and low ends of the scale
- 0 psi to a maximum of 300 psi (0 bar to a maximum of 20 bar)
- Materials: All wetted parts are brass; combination brass/bronze connection and bourdon tube

GAUGE OPTIONS

26383

- 1/8", 1/4" center back male conn.
- 2" (51 mm) dia. housing



26385

- 1/4" bottom male conn.
- 2-1/2" (64 mm) dia. housing



ORDERING INFORMATION

PRESSURE GAUGE 26383

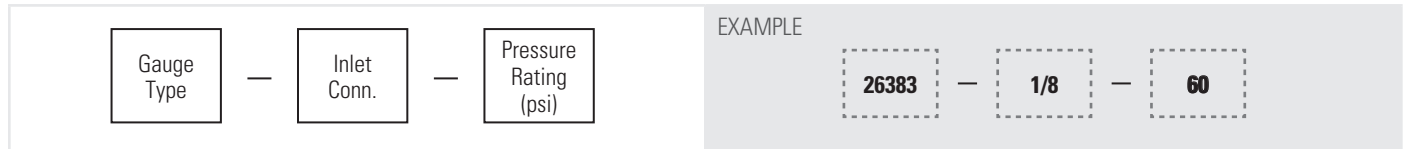

Pressure rating is ordered in psi.

PRESSURE GAUGE 26385

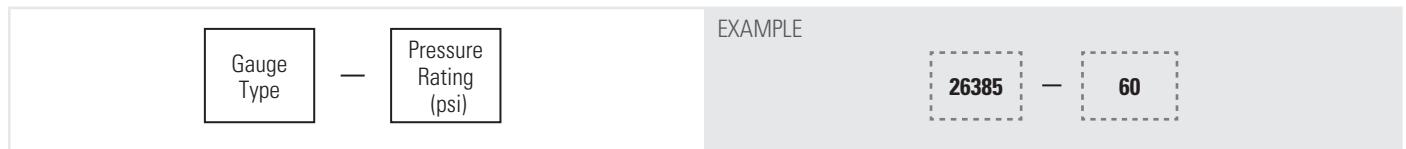

Pressure rating is ordered in psi.

SPECIFICATIONS

Gauge Type	Inlet. Conn. (in.) (M)	Pressure Rating psi (bar)	Pressure Range psi (bar)
26383	1/8, 1/4	60 (4)	0 – 60 (0 – 4)
	1/8, 1/4	100 (7)	0 – 100 (0 – 7)
	1/8, 1/4	160 (11)	0 – 160 (0 – 11)

Gauge Type	Inlet. Conn. (in.) (M)	Pressure Rating psi (bar)	Pressure Range psi (bar)
26385	1/4	60 (4)	15 – 45 (1.0 – 3.1)
	1/4	100 (7)	25 – 75 (1.7 – 5.2)
	1/4	160 (11)	40 – 120 (2.8 – 8.3)
	1/4	300 (21)	75 – 225 (5.2 – 15.5)



LIQUID AND AIR PRESSURE REGULATORS

- Diaphragm-type non-relieving liquid pressure regulators
 - Operating temperature range: 35° to 200°F (2° to 93°C)
 - Gauges supplied separately
- Diaphragm-type, relieving and non-relieving style air pressure regulators
 - Relieving style automatically relieves excessive air pressure in a regulated line; non-relieving types also available
 - Regulated line pressure can be reduced with adjusting knob even when line is dead ended
 - Operating temperature range: 0° to 175°F (-15° to +80°C) with dew point less than air temperatures below 35°F (2°C)
 - Gauges supplied separately

REGULATOR OPTIONS

11438 Air Pressure Regulator

- Diaphragm, relieving and non-relieving types
- Regulated pressures from 5 to 125 psi (0.3 to 8.5 bar) with supply line pressures up to 300 psi (20 bar)
- Materials: Die cast aluminum, stainless steel, zinc



11438 Liquid Pressure Regulator

- Non-relieving type
- Regulated pressures from 5 to 125 psi (0.3 to 8.5 bar) with primary supply line pressures
- Max. pressure: 400 psi (28 bar)
- Materials: Brass, brass-plated zinc or stainless steel



ORDERING INFORMATION

AIR PRESSURE REGULATOR

Regulator No.	EXAMPLE
	11438-45

LIQUID PRESSURE REGULATOR

Regulator No.	EXAMPLE
	11438-250

PLACING YOUR ORDER

Call **1.800.95.SPRAY** for application assistance
or to place an order.

SPECIFICATIONS

Regulator Type	Regulator Style	Regulator Number	Max. Pressure (psi)	Main Ports (in.)	Gauge Ports (in.)	Material
Air	Non-relieving	11438-35	300	1/4	1/4	Zinc
		11438-36	300	3/8	1/4	Zinc
		11438-37	300	1/2	1/4	Zinc
		11438-38	300	3/4	1/4	Aluminum
		11438-39	300	1	1/4	Aluminum
	Relieving	11438-45	300	1/4	1/4	Zinc
		11438-45S	300	1/4	1/8	316 stainless steel
		11438-46	300	3/8	1/4	Zinc
		11438-47	300	1/2	1/4	Zinc
		11438-47S	300	1/2	1/4	316 stainless steel
		11438-48	300	3/4	1/4	Aluminum
		11438-49	300	1	1/4	Aluminum
		Liquid	Diaphragm	11438-250	400	1/4
11438-251	400			3/8	1/4	Brass
11438-252	400			1/2	1/4	Brass
11438-253	400			3/4	1/8	Brass
11438-254	400			1	1/8	Brass

Stainless steel versions meet NACE standard MR-01-75 for corrosion resistance.

DIMENSIONS AND WEIGHTS

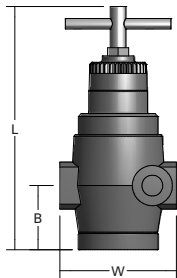
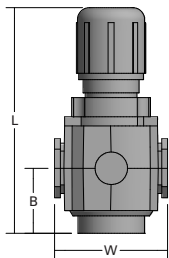
Regulator	Accessory Type 11438-	B (in.)	L (in.)	W (in.)	Net Weight (oz.)
	250, 251	1.500	5.750	2.750	42.7
	252	1.594	5.938	3.313	47.6
	253, 254	1.625	9.500	5.000	129.1
	35, 36, 45, 46	1.438	5.125	2.750	21.6
	37, 47	1.500	5.875	3.500	30.5
	38, 39, 48, 49	2.375	6.875	4.250	54.3
	45S	0.375	2.750	1.500	5.5
	47S	1.625	7.813	3.500	7.2

Based on the largest/heaviest version of each type.



SOLENOID VALVES

- On/off flow control in automatically operated systems
- Dependable performance in air and liquid lines with temperatures from 40° to 165°F (5° to 75°C)
- Ten watt, class "F" coils are for continuous duty; UL and CSA approved; suitable for international use
- Encapsulated coil resists high humidity and fungus growth
- 360° rotation available with durable electrostatically powder-coated enclosure
- Stainless steel pilot orifice helps eliminate premature leaking and increases service life in high flow velocity situations
- Floating plungers automatically compensate for vibration, shock, wear and deformation while providing a bubble-tight seal
- Versatile mounting in any position; direct pipe mounting

VALVE OPTIONS

2-Way

- 1/4", 3/8", 1/2", 3/4", 1" conn.
- Direct-acting poppet or pilot-operated diaphragm valve action
- Materials: Brass, stainless steel



3-Way

- 1/4", 3/8", 1/2" conn.
- Poppet or diaphragm valve action
- Materials: Brass, stainless steel



ORDERING INFORMATION

COMPLETE SOLENOID VALVE*

Model No.

EXAMPLE

11438-20

BSPT connections require the addition of a "B" prior to the inlet connection

*110 or 120 V, 50/60 Hz coil is standard. If other coil assemblies are desired, add the appropriate letter code to the end of the part number. For example: 11438-20A.

A = 220 or 240 V, 50/60 Hz B = 24 V, 60 Hz C = 12 VDC D = 24 VDC

PLACING YOUR ORDER

Call **1.800.95.SPRAY** for application assistance
or to place an order.

SPECIFICATIONS

Port Conn. (in.)	Valve Action	Valve Type	Model Number	Max. Pressure (psi)	Orifice Size (in.)	Cv Factor**	Body Material	Seal Material
1/4	Direct Acting Poppet	2-way	11438-20	60*	3/16	.50	Stainless steel	Viton®
1/4	Direct Acting Poppet	2-way	11438-21	205*	1/8	.28	Stainless steel	Kel-F®
3/8	Pilot-Operated Diaph.	2-way	11438-22	150*	7/16	2.5	Forged or cast brass	Buna-N
1/2	Pilot-Operated Diaph.	2-way	11438-23	150*	5/8	4.0	Forged or cast brass	Buna-N
3/4	Pilot-Operated Diaph.	2-way	11438-24	230	3/4	7.8	Forged or cast brass	Buna-N
1	Pilot-Operated Diaph.	2-way	11438-25	230	1	13.0	Forged or cast brass	Buna-N
1/4	Poppet	3-way	11438-30	100	3/32	.25/38	Forged or cast brass	Viton
1/2	Diaph.	3-way	11438-31	150	1/2	3.6	Forged or cast brass	Buna-N
3/8	Diaph.	3-way	11438-32	150	7/16	1.6/2.5	Aluminum	Buna-N

*For maximum pressures of coils "C" and "D", request Data Sheet 11438 – Solenoid (1).

See Trademark Registration and Ownership, page i1.

**For use of Cv Factor, request Data Sheet 11438 – Solenoid (2).

DIMENSIONS AND WEIGHTS

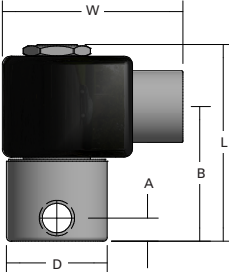
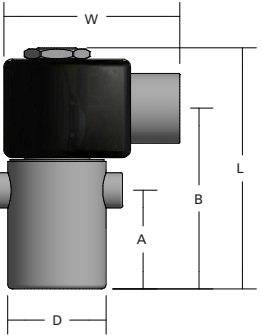
Solenoid Valve	Accessory Type	A (in.)	B (in.)	D (Dia.) (in.)	L (in.)	W (in.)	Net Weight (oz.)
	11438-20	0.344	1.938	1.625	2.906	2.76	20.3
	11438-21	0.344	1.938	1.625	2.906	2.76	20.3
	11438-22	0.594	2.594	1.969	3.563	2.76	19.9
	11438-23	0.531	3.406	2.656	4.406	2.76	35.9
	11438-24	0.875	3.719	3.938	4.750	2.76	61
	11438-25	0.875	3.719	3.938	4.750	2.76	34.4
	11438-30	1.125	2.750	1.563	3.750	2.76	21.3
	11438-31	1.063	3.156	3.094	5.625	2.76	25.3
	11438-32	1.500	3.750	1.375	4.375	2.76	12.4

Based on the largest/heaviest version of each type.

BALL VALVES

- 2-way versions provide on-off control with a simple quarter turn of the handle
- 3-way versions divert flow to either outlet; no shut-off
- Inlet connections range from 3/8" to 1-1/2" (NPT or BSPT)
- Maximum pressure up to 300 psi (20 bar)
- Constructed of nylon glass-reinforced polypropylene



AA(B)344M-PP
Ball valve

SPECIFICATIONS

Valve Number	Maximum Pressure (psi)	Number of Outlets	Connection Size (in.)	Materials of Wetted Parts	
AA(B)344M-2-3/4	300	1	3/4	Nylon, PTFE, polypropylene and Viton®	
AA(B)344M-2-1			1		
AA(B)343M-2-3/8-PP	150		3/8	Glass-reinforced polypropylene, PTFE and Viton	
AA(B)343M-2-1/2-PP			1/2		
AA(B)344M-2-3/4-PP			3/4		
AA(B)344M-2-1-PP			1		
AA(B)346M-2-1-1/4-PP	125		1-1/4		
AA(B)346M-2-1-1/2-PP			1-1/2		
AA(B)344M-3-3/4	300		2	3/4	Nylon, PTFE, polypropylene and Viton
AA(B)344M-3-1				1	
AA(B)343M-3-3/8-PP	150	3/8		Glass-reinforced polypropylene, PTFE and Viton	
AA(B)343M-3-1/2-PP		1/2			
AA(B)344M-3-3/4-PP		3/4			
AA(B)344M-3-1-PP		1			
AA(B)346M-3-1-1/4-PP	125	1-1/4			
AA(B)346M-3-1-1/2-PP		1-1/2			

ORDERING INFORMATION

<div style="border: 1px solid black; padding: 10px; display: inline-block;">Valve No.</div>	<p>EXAMPLE</p> <div style="border: 2px dashed black; padding: 5px; display: inline-block;">AA344M-2-3/4</div>
---	--



PLUG VALVES

- Easy in-line shut-off
- Manual operation
- Ball valve provides more robust operation than plug valves
- Max. pressure: 400 psi (27 bar)

23220 Plug Valve, Female x Male

- 1/4" female inlet and 1/4" male outlet conn.
- Materials: Brass body with Celcon plug handle

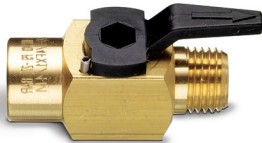

VALVE OPTIONS

23220 Plug Valve, Female x Female

- Available in:
 - 1/8" female inlet and 1/8" female outlet conn.
 - 1/4" female inlet and 1/8" female outlet conn.
 - 1/4" female inlet and 1/4" female outlet conn.
- Materials: Brass body with Celcon® plug handle

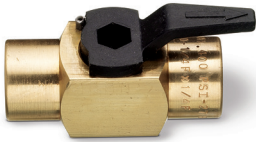

23220 Plug Valve, Male x Female

- 1/4" male inlet and 1/4" female outlet conn.
- Materials: Brass body with Celcon plug handle

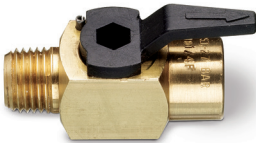

ORDERING INFORMATION



EXAMPLE

23220 — 1/4F — 1/4F

BSPT connections require the addition of "B" prior to the inlet connection.

DIMENSIONS AND WEIGHTS

Valve	Accessory Type	Inlet Conn. (in.)	Outlet Conn. (in.)	L (in.)	H (in.)	Net Weight (oz.)
	23220	1/4 (F)	1/8 (F)	1-3/4	1-5/32	2.08
		1/4 (F)	1/4 (F)	1-3/4	1-5/32	2.08
		1/8 (F)	1/8 (F)	1-3/4	1-5/32	2.43
	23220	1/4 (M)	1/4 (F)	1-3/4	1-5/32	2.08
	23220	1/4 (F)	1/4 (M)	1-3/4	1-5/32	1.98

Based on the largest/heaviest version of each type.

EXTENSIONS

Are available to help position the spray tip or set-up precisely where it needs to be.

EXTENSION OPTIONS

17180

- 3", 6", 9", 12" pipe sizes
- For use with 1/8JJ Series nozzles
- Materials: Brass or 303 stainless steel (SS)



18096

- 3", 6", 9", 12" pipe sizes
- For use with 1/4J Series nozzles
- Materials: Brass or 303 stainless steel (SS)



17185

- 3", 6", 9", 12" pipe sizes
- For use with 1/8JJAU Series automatic nozzles
- Materials: Brass or 303 stainless steel (SS)



6123

- 3", 6", 9", 12" pipe sizes
- For use with 1/4JAU Series automatic nozzles
- Materials: Brass or 303 stainless steel (SS)



ORDERING INFORMATION

EXTENSIONS 17180, 18096, 17185

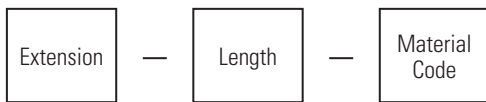

EXAMPLE



There is no material code for brass. Leave material code blank when ordering.

EXTENSION 6123



EXAMPLE



There is no material code for brass. Leave material code blank when ordering.

SPLIT-EYELET CONNECTORS

Split-eyelet connectors provide a quick and easy way to connect spray nozzles to piping systems

- Simply drill a hole in side of pipe
- Place inlet of split eyelet into the hole; seal eliminates leaking
- Assemble the clamp component to secure the assembly to the pipe

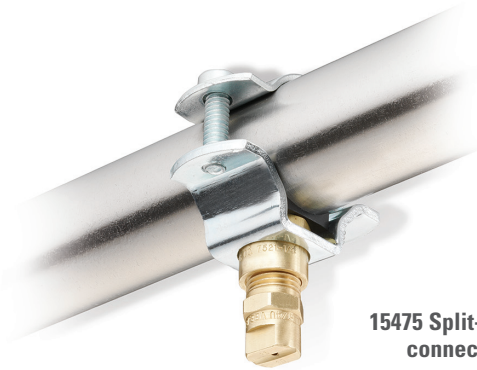

15475 Split-eyelet connector

CONNECTOR OPTIONS

8370

- 1-1/4", 1-1/2", 2" pipe size
- 1/8", 1/4", 3/8", 1/2" female outlet connection
- Materials: Zinc-plated steel clamps/bolts with brass body (A), all stainless steel (B) or zinc-plated steel clamps/bolts with stainless connector body (C)



15475

- 2-1/2", 3", 4" pipe size
- 1/4", 3/8", 1/2", 3/4", 1" female outlet connection
- Materials: Zinc-plated steel clamps/bolts with brass body (A), all stainless steel (B) or zinc-plated steel clamps/bolts with stainless connector body (C)



38180 Split Eyelet Swivel Union

- 1/2", 3/4", 1" pipe sizes
- 1/4" male outlet connection
- Swivel union allows easier product positioning
- Materials: Brass or 303 stainless steel (SS)



ORDERING INFORMATION

CONNECTORS 15475 AND 8370

Split-Eyelet Connector Type	Material Code	—	Pipe Size	X	Outlet Conn.
-----------------------------	---------------	---	-----------	---	--------------

EXAMPLE

8370	A	—	1-1/4	x	1/4
------	---	---	-------	---	-----

SWIVEL CONNECTOR 38180

Split-Eyelet Swivel Union	—	Pipe Size	—	Material Code
---------------------------	---	-----------	---	---------------

EXAMPLE

38180	—	1/2	—	SS
-------	---	-----	---	----

*There is no material code for brass 38180 connectors. Leave material code blank when ordering.

SPECIFICATIONS

Split-Eyelet	To Clamp On		Outlet Conn. (F) (in.)					Maximum Pressure psi	Capacity at Maximum Pressure gpm	Material Code	
	Pipe Size (in.)	Outside Dia. Tubing (in.)	1/8	1/4	3/8	1/2	3/4				1
8370	1-1/4	1-9/16, 1-11/16	•	•	•	•			125	5.5-20*	A, B, C
	1-1/2	1-3/4, 2	•	•	•	•					
	2	2-1/8, 2-3/8	•	•	•	•					
15475	2-1/2	2-1/2, 2-7/8		•	•	•	•	•	125	10-54*	A, B, C
	3	3, 3-1/2		•	•	•	•	•			
	4	4, 4-1/2		•	•	•	•	•			

Capacities of 8370 and 15475 Vary with Outlet Conn.	
Outlet Conn. (in.)	Capacity gpm
1/8	5.5
1/4	10
3/8	15
1/2	20
3/4	33
1	54

*Capacities of 8370 and 15475 vary with outlet connection.

Split-Eyelet	To Clamp On		Maximum Pressure psi	Materials
	Pipe Size (in.)	Outside Dia. Tubing (in.)		
38180	1/2	13/16, 7/8	250	Nickel-plated brass with zinc-plated pipe clamps, 303 stainless steel (SS)
	3/4	1, 1-1/6		
	1	1-1/8, 1-1/4, 1-3/8		

DIMENSIONS AND WEIGHTS

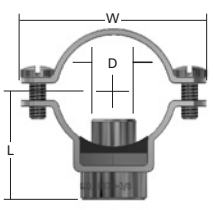
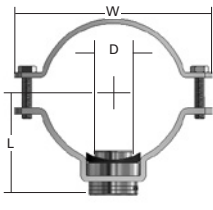
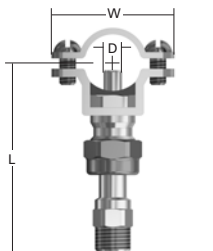
Split-Eyelet	Accessory Type	Pipe Size (in.)	W (in.)	D (Dia.) (in.)	L (in.)	Net Weight (oz.)
	8370	1-1/4	2.75	0.688	1.611	6.3
		1-1/2	3.19	0.688	1.731	7
		2	3.47	0.688	1.970	7.4
	15475	2-1/2	4.656	1.250	2.469	9.8
		3	5.375	1.250	2.781	28.9
		4	6.438	1.250	3.281	34.2
	38180	1/2	1-7/8	0.281	3.509	3.7
		3/4	2-1/8			
		1	2-1/4			

Based on the largest/heaviest version of each type.



MOUNTING KITS

28945-001-316SS

- Clamp mounting kit.
- Mounting bolt has 3/8-24 UNF thread for VAA, VAU and VMAU nozzles



28945-002-SS

- Mounting kit for 1/2" rod
- Mounting bolt has 3/8-24 UNF thread for VAA, VAU and VMAU nozzles



28945-003-316SS

- Mounting kit for 1/2" rod
- Mounting bolt has 1/8" NPT thread for JAU nozzle series



ORDERING INFORMATION

Mounting Kit Number

EXAMPLE

28945-001-316SS

2335-SE SPRAY PIPE ASSEMBLY

- 1/4" globe valve
- 1/4" piping (1-1/2" and 8" lengths)
- 1/4" copper tubing
- Union nut and connectors (2)
- Materials of construction: galvanized iron, brass (material code - B)



2335-SE Spray Pipe Assembly

ORDERING INFORMATION

Spray Pipe Assembly

—

Material Code

EXAMPLE

2335-SE

—

B

There is no material code for galvanized iron. Leave material code blank when ordering.

2202 PIPE HANGER

- Used for proper spacing between air and liquid lines. Sizes fit 1/2" piping
- Hanger is held by threaded rod and nuts (not included) for vertical adjustment
- Made of cast aluminum. 4" (10 cm) spacing
- Use with 2335-SE spray pipe assembly



2202 Pipe Hanger

ORDERING INFORMATION

Pipe Hanger	EXAMPLE
	2202-AL

WALL MOUNT ADAPTERS

1/8J and 1/4J Nozzles

- For thick walls adapter CP3376
- For thin walls adapter CP3376, gasket CP2804-3 and locknut CP6378
- Materials of construction:
 - Adapter and locknut, nickel-plated brass (NP), 303 stainless steel (SS) or 316 stainless steel (316SS)
 - Gasket, Buna-N (BU) or PTFE (TEF)

VAA, VAU, VMAU Nozzles

- Thick Wall Adapter - CP31158-003-SS
- Thin Wall Adapter - CP31158-002-SS

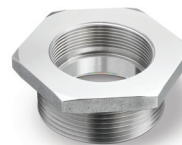

CP31158-003-SS

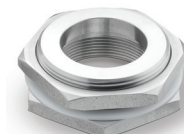

CP31158-002-SS

ORDERING INFORMATION

ADAPTER FOR 1/8J AND 1/4J NOZZLES

Adapter, Gasket or Locknut Number	—	Material Code	EXAMPLE
			CP3376 — SS

ADAPTER FOR VAA, VAU, VMAU NOZZLES

Wall Mount Adapter Number	EXAMPLE
	CP31158-003-SS



22140 PRESSURE TANK ASSEMBLY

- 22140 Pressure Tank Assembly
- Meets ASME® Boiler and Pressure Vessel Code requirements and OSHA safety regulations
- Constructed of 304 stainless steel (SS)
- Assembly includes a pressure regulator with gauge, ASME coded pressure relief valve, air bleed valve and plug valves for air inlet and liquid outlet
- Tanks are available in 1, 2, 5, 10 and 16 gallon (3.8, 7.6, 18.9, 38 and 61 liter) capacities
- The air inlet and liquid outlet have 1/4" NPT (F) connections
- The maximum working pressure is 140 psi at 100°F (9.5 bar at 38°C)
- The 22140 features brass fittings and an EPR lid seal



22140 Pressure Tank Assembly

ORDERING INFORMATION

Pressure Tank	—	Capacity Size (in gallons)	—	Material Code	EXAMPLE	22140	—	5	—	304SS
---------------	---	----------------------------	---	---------------	---------	-------	---	---	---	-------

FLOAT BOX AND VALVE

45600 Float Box

Stainless float box with a polypropylene float valve and float ball



45604 Float Valve

Brass float valve and polypropylene float ball

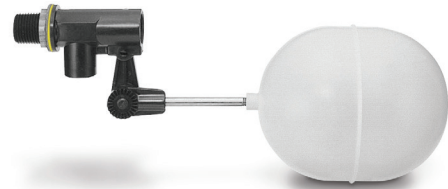

ORDERING INFORMATION

Float Box or Float Valve Number	EXAMPLE	45600
---------------------------------	---------	-------

39273 AND 39275 LEVEL SWITCHES

- Indicates a low liquid level condition inside the pressure tank
- Use with pressure tank assemblies with external 1/4" NPT (F) threads
- Features a U.L. listed float switch, quick disconnect and 12' (3.6 m) PVC jacketed cable
- Available in brass with Buna-N float or all stainless steel

**39275 Level Switch****SPECIFICATIONS**

Level Switch Part Number	Matching Tank Size	Minimum Specific Gravity	Materials	
			Tube & Fittings	Float
39275-1	1 gal (3.8 liter)	0.65	Brass	Buna-N
39275-1-SS		0.7	Stainless Steel	316 stainless steel
39275-2	2 gallon (7.6 liter)	0.65	Brass	Buna-N
39275-2-SS		0.7	Stainless Steel	316 stainless steel
39273	5, 10 gallon (18.9, 38 liter)	0.65	Brass	Buna-N
39273-SS		0.7	Stainless Steel	316 stainless steel
39273-1	16 gallon (61 liter)	0.65	Brass	Buna-N
39273-1-SS		0.7	Stainless Steel	316 stainless steel

ORDERING INFORMATION

<div style="border: 1px solid black; padding: 5px; display: inline-block;"> Level Switch Part Number </div>	EXAMPLE <div style="border: 1px dashed black; padding: 5px; display: inline-block; margin-top: 10px;"> 39275-1-SS </div>
---	--

50580 ADJUSTABLE SIPHON INJECTORS

- Provide a convenient method for adding chemicals to liquid flow before spraying
- Siphon rate is controlled with a metering screw
- Max pressure – 3000 psi (207 bar)
- Capacity sizes available up to 6.0 gpm (22.7 lpm)
- Liquid inlet and outlet connections 3/8" or 1/2" NPT or BSPT
- Standard hose barb connection injection inlet; optional 1/4" NPT or BSPT
- Materials: Brass or 303 stainless steel (SS)



50580 Adjustable Siphon Injector

SPECIFICATIONS

Model Number	Inlet & Outlet Thread Connection Size	Matching Capacity	Siphon Thread Connection Size
50580	3/8 or 1/2	05 (0.5 gpm ; 1.9 lpm)	1/4
		10 (1.0 gpm; 3.8 lpm)	
		15 (1.5 gpm; 5.7 lpm)	
		20 (2.0 gpm; 7.6 lpm)	
		30 (3.0 gpm; 11.4 lpm)	
		40 (4.0 gpm; 15.1 lpm)	
		50 (5.0 gpm; 18.9 lpm)	
		60 (6.0 gpm; 22.7 lpm)	

ORDERING INFORMATION

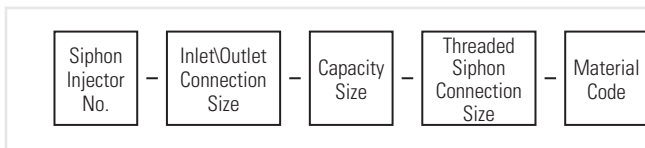

EXAMPLE



There is no material code for brass. Leave material code blank when ordering. Leave threaded siphon connection size blank for hose barb connection siphon inlet.

BSPT connections require the addition of a "B" prior to the model number.

PLACING YOUR ORDER

Call 1.800.95.SPRAY for application assistance or to place an order.