

ACH550

Installation, Operation and Maintenance Manual (I, O & M)

ACH550-UH HVAC Drives (1...550 HP)

ACH550-BCR/BDR/VCR/VDR E-Clipse Bypass Drives (1...400 HP)

ACH550-PCR/PDR Packaged Drives with Disconnect (1...550 HP)



Safety

Use of warnings and notes

There are two types of safety instructions throughout this manual:

- Notes draw attention to a particular condition or fact, or give information on a subject.
- Warnings caution you about conditions which can result in serious injury or death and/or damage to the equipment. They also tell you how to avoid the danger. The warning symbols are used as follows:



Electricity warning warns of hazards from electricity which can cause physical injury and/or damage to the equipment.

- **WARNING!** The ACH550 adjustable speed AC drive should ONLY be installed by a qualified electrician.
- **WARNING!** Even when the motor is stopped, dangerous voltage is present at the power circuit terminals U1, V1, W1 (L1, L2, L3) and U2, V2, W2 (T1, T2 T3) and, depending on the frame size, UDC+ and UDC-, or BRK+ and BRK-.
- **WARNING!** Dangerous voltage is present when input power is connected. After disconnecting the supply, wait at least 5 minutes (to let the intermediate circuit capacitors discharge) before removing the cover.
- **WARNING!** Even when power is switched off from the input terminals of the ACH550, there may be dangerous voltage (from external sources) on the terminals of the relay outputs.
- **WARNING!** When the control terminals of two or more drives are connected in parallel, the auxiliary voltage for these control connections must be taken from a single source which can either be one of the drives or an external supply.
- **WARNING!** Disconnect the internal EMC filter when installing the drive on an IT system (an ungrounded power system or a

high-resistance-grounded [over 30 ohm] power system).

- **WARNING!** Do not attempt to install or remove EM1, EM3, F1 or F2 screws while power is applied to the drive's input terminals.



General warning warns about conditions, other than those caused by electricity, which can result in physical injury and/or damage to the equipment.

- **WARNING!** Do not control the motor with the disconnecting device (disconnecting means); instead, use the control panel keys or commands via the I/O board of the drive. The maximum allowed number of charging cycles of the DC capacitors (i.e. power-ups by applying power) is five in ten minutes.
- **WARNING!** Never attempt to repair a malfunctioning ACH550; contact the factory or your local Authorized Service Center for repair or replacement.
- **WARNING!** The ACH550 will start up automatically after an input voltage interruption if the external run command is on.
- **WARNING!** The heat sink may reach a high temperature.



Note: For more technical information, contact the factory or your local ABB representative.

Contents

This manual is the Operation and Maintenance Manual for the ACH550 Drives. Complete technical details and programming information are available in the *ACH550 User's Manual*, publication number 3AUA0000081823.

1. To determine the type of your drive, refer to its construction code on either:

- Serial number label attached on upper part of the chokeplate between the mounting holes.
- Type code label attached on the heat sink – on the side of the enclosure.

Input Voltage (U1) Current (I1n)	3 PH 48...63 Hz 200...240 Vac 59.4 A	1 PH 4...63 Hz 200...240 Vac 59.4 A	ABB Inc. Made in USA of foreign parts  Mfg. Date: 01-December-2005 Org. Firmware: V.2.06B  S/N 2030700001
Output Voltage (U2) Current (I2n)	3 PH 0...500 Hz 0...U1 Vac 59.4 A	3 PH 0...500 Hz 0...U1 Vac 28 A	
Power (Pn)	20 HP	10 HP	

ACH550(UH)059A-2

ACH550-UH-059A-2

S/N 2030700001

Construction code

2. According to the construction code, proceed to your drive's installation, operation, diagnostics and maintenance information:

- UH – Below.
- VCR, VDR, BCR, BDR (E-Clipse Bypass) – page [39](#).
- PCR, PDR (Packaged Drives with Disconnect) – page [79](#).

ACH550-UH

Installation

Study these installation instructions carefully before proceeding. **Failure to observe the warnings and instructions may cause a malfunction or personal hazard.**



WARNING! Before you begin read [Safety](#) on page [2](#).

Note: Keep a minimum of 50 mm (2") of free space on each side and 200 mm (8") of free space above and below all units from non-heat producing sources. Double these distances from heat producing sources.

1. Prepare for installation

Lifting R1...R6

Lift the drive only by the metal chassis.

Lifting R7...R8



WARNING! Handle and ship floor mounted enclosures only in the upright position. These units are not designed to be laid on their backs.

1. Use a pallet truck to move the transport package/enclosure to the installation site.
 2. Remove the cabinet side panels for access to the cabinet/pallet mounting bolts. (6 torx screws hold each cabinet side panel in place. Leave the side panels off until later.)
 3. Remove the 4 bolts that secure the cabinet to the shipping pallet.
-



WARNING! Use the lifting lugs/bars at the top of the unit to lift R7/R8 drives.

4. Use a hoist to lift the drive. (Do not place drive in final position until mounting site is prepared.)

Unpack the drive

1. Unpack the drive.
2. Check for any damage and notify the shipper immediately if damaged components are found.
3. Check the contents against the order and the shipping label to verify that all parts have been received.

Tools required

To install the ACH550 you need the following:

- Screwdrivers (as appropriate for the mounting hardware used)
- Wire stripper
- Tape measure
- Drill
- Frame sizes R5...R8 with UL type 12 enclosure: Punch for conduit mounting holes
- Frame sizes R7/R8: pallet truck and hoist
- For installations involving frame size R6...R8: The appropriate crimping tool for power cable lugs.

- Mounting hardware: screws or nuts and bolts, four each. The type of hardware depends on the mounting surface and the frame size:

Frame Size	Mounting Hardware		Note
R1...R4	M5	#10	
R5	M6	1/4 in	
R6	M8	5/16 in	
R7...R8	M10	7/16	Secures free standing cabinets if required.

- For installations involving frame size R7...R8: Hoist.



WARNING! Before installing the ACH550, ensure the input power supply to the drive is off.



WARNING! Metal shavings or debris in the enclosure can damage electrical equipment and create a hazardous condition. Where parts, such as conduit plates require cutting or drilling, first remove the part. If that is not practical, cover nearby electrical components to protect them from all shavings or debris.

Flange Mounting Instructions

Frame size	IP21 / UL type 1		IP54 / UL type 12	
	Kit	Code (English)	Kit	Code (English)
R1	FMK-A-R1	100000982	FMK-B-R1	100000990
R2	FMK-A-R2	100000984	FMK-B-R2	100000992
R3	FMK-A-R3	100000986	FMK-B-R3	100000994
R4	FMK-A-R4	100000988	FMK-B-R4	100000996
R5	AC8-FLNGMT-R5	ACS800-PNTG01U-EN	-	-
R6	AC8-FLNGMT-R6		-	-

2. Prepare the mounting location

1. Mark the position of the mounting holes.

Note: Frame sizes R3 and R4 have four holes along the top. Use only two. If possible, use the two outside holes (to allow room to remove the fan for maintenance).

Note: ACH400 drives can be replaced using the original mounting holes. For R1 and R2 frame sizes, the mounting holes are identical. For R3 and R4 frame sizes, the inside mounting holes on the top of ACH550 drives match ACH400 mounts.

Note: Frame sizes R7 and R8 have mounting holes inside the enclosure base.

Where it is not possible to use either mounting hole at the back of the base, use an L-bracket at the top of the enclosure to secure the cabinet to a wall or to the back of another enclosure. Bolt the L-bracket to the enclosure using the lifting lug bolt hole on the top of the enclosure.

2. Drill holes of appropriate size in the mounting location.

3. Remove front cover

R1...R6, UL type 1

1. Remove the control panel, if attached.
2. Loosen the captive screw at the top.
3. Pull near the top to remove the cover.

R1...R6, UL type 12

1. If hood is present: Remove screws (2) holding the hood in place.
2. If hood is present: Slide hood up and off of the cover.
3. Loosen the captive screws around the edge of the cover.
4. Remove the cover.

R7...R8, Cabinet Door

1. To open the cabinet door, loosen the quarter-turn screws that hold the cabinet door closed.

R7...R8, Side Panels

The side panels were removed to take the cabinet off the pallet. Installation access is easier if these panels are kept off throughout the installation.

4. Mount the drive

R1...R6, UL type 1

1. Position the ACH550 onto the mounting screws or bolts and securely tighten in all four corners.

Note: Use mounting hardware that permits fan replacement without removal.

Note: Lift the ACH550 by its metal chassis.

2. Non-English speaking locations: Add a warning sticker in the appropriate language over the existing warning on the top of the module.

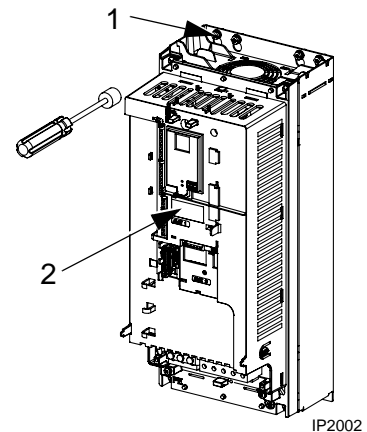

R1...R6, UL type 12

For the UL type 12 enclosures, rubber plugs are required in the holes provided for access to the drive mounting slots.

1. As required for access, remove the rubber plugs. Push plugs out from the back of the drive.
2. R5 & R6: Align the sheet metal hood (not shown) in front of the drive's top mounting holes. (Attach as part of next step.)
3. Position the ACH550 onto the mounting screws or bolts and securely tighten in all four corners.

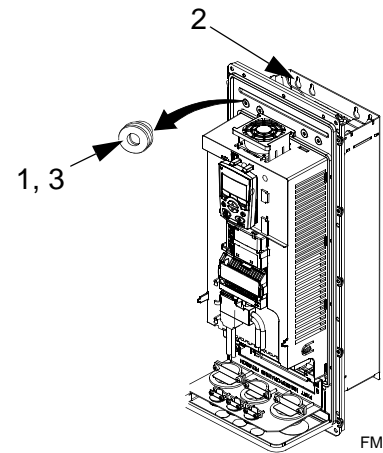

Note: Lift the ACH550 by its metal chassis (frame size R6 by the lifting holes on both sides at the top).

4. Re-install the rubber plugs.
5. Non-English speaking locations: Add a warning sticker in the appropriate language over the existing warning on the top of the module.

R7...R8

1. Use a hoist to move the cabinet into position.

Note: If the cabinet location does not provide access to the cabinet sides, be sure to re-mount side panels before positioning cabinet.

2. Install and tighten mounting bolts.

5. Install wiring

WARNING! Ensure the motor is compatible for use with the ACH550. The ACH550 must be installed by a competent person. If in doubt, contact your local ABB sales or service office.

Conduit kit

Wiring R1...R6 drives with the UL type 1 Enclosure requires a conduit kit with the following items:

- conduit box
- screws
- cover

The kit is included with UL type 1 Enclosures.

Connection diagrams

The following diagrams show:

- The terminal layout for frame size R3, which, in general, applies to frame sizes R1...R6, except for the R5/R6 power and ground terminals.
- The R5/R6 power and ground terminals.
- The terminal layout for R7/R8.

R1...R4 (Diagram shows the R3 frame.)

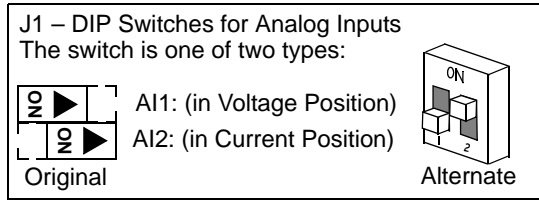
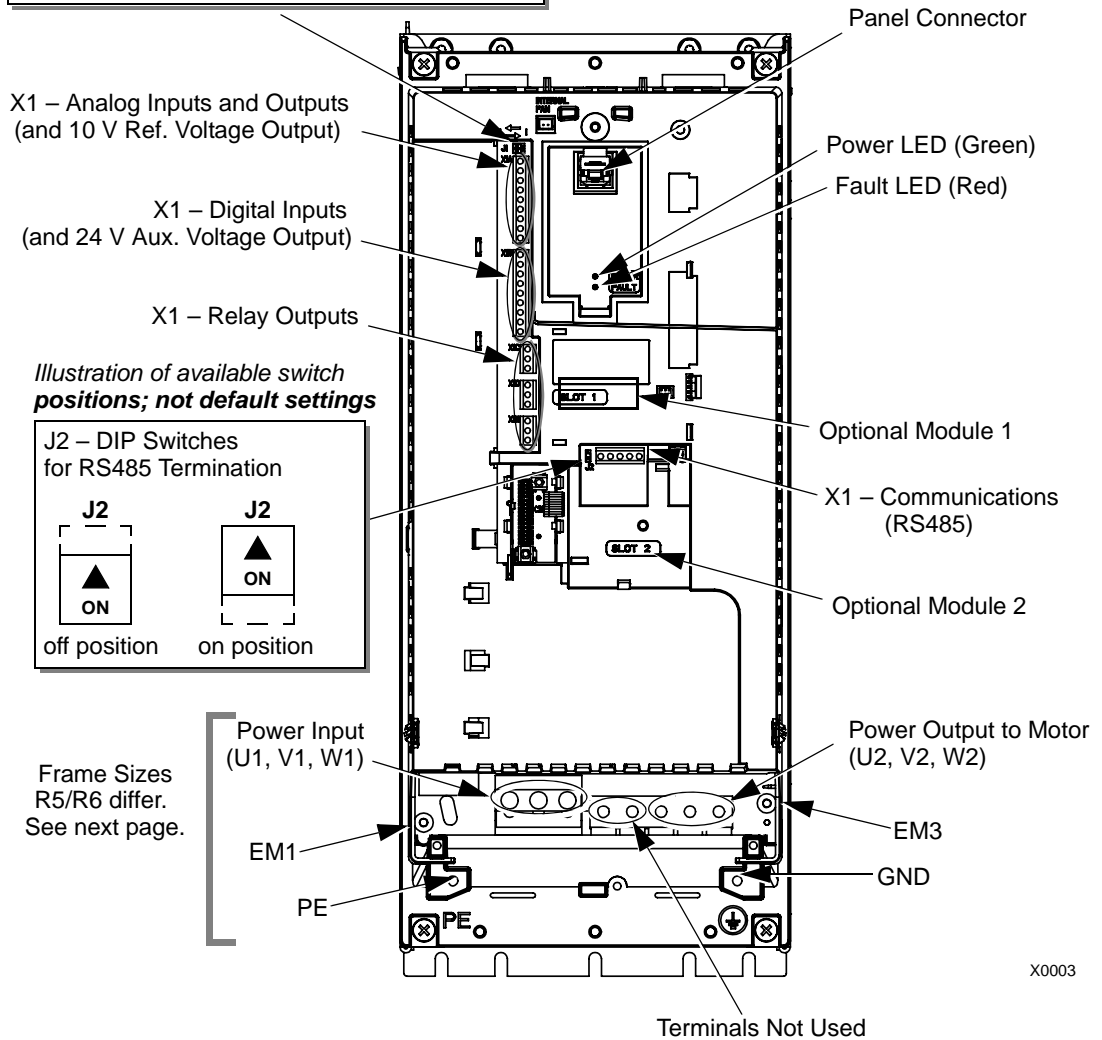

Illustration of available switch positions; not default settings



X0003



WARNING! To avoid danger, or damage to the drive, on IT systems and corner grounded TN systems, see section [Disconnecting the internal EMC filter](#) on page 10.

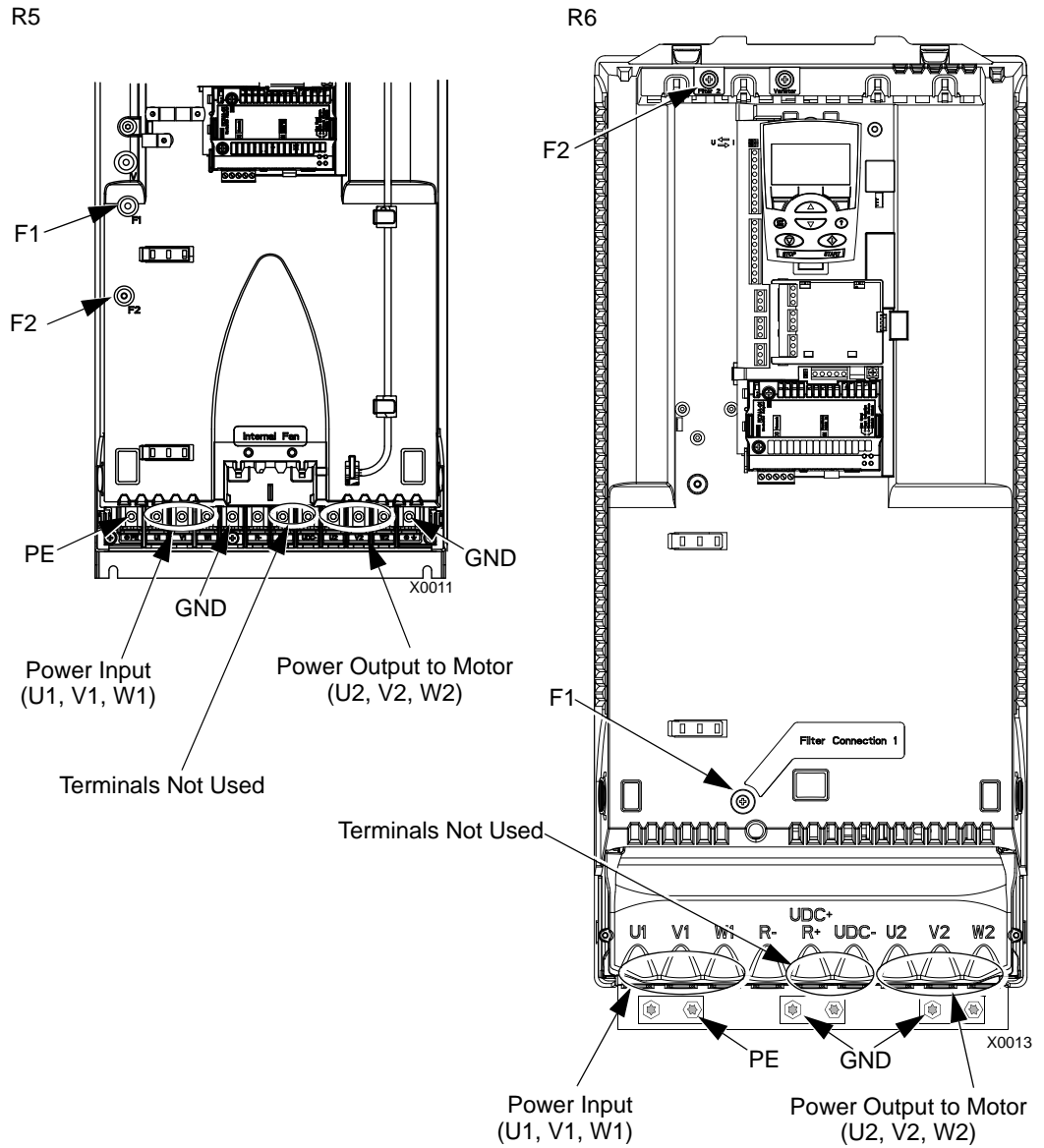

WARNING! To avoid danger, or damage to the drive, on IT systems and corner grounded TN systems, see section [Disconnecting the internal EMC filter](#) on page 10.

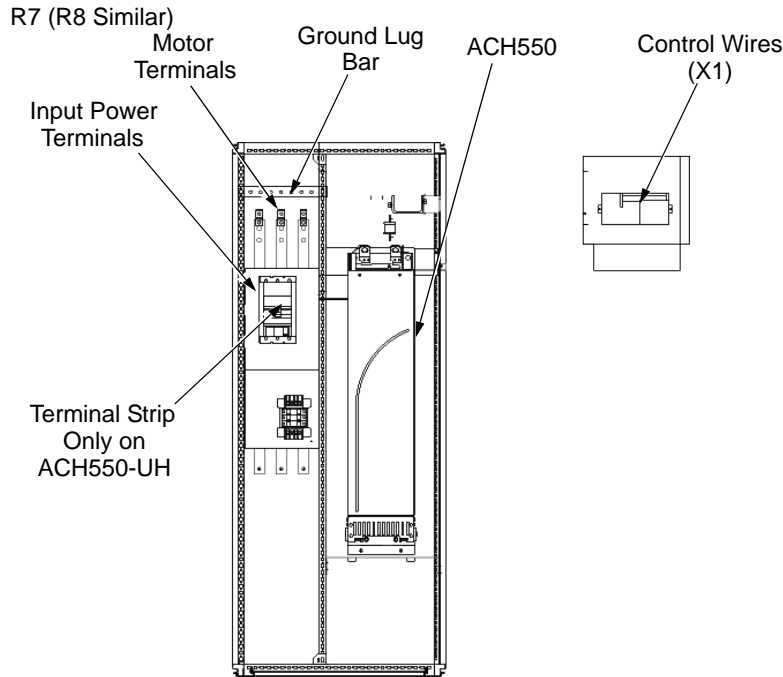

Disconnecting the internal EMC filter

On certain types of systems, you must disconnect the internal EMC filter, otherwise the system will be connected to ground potential through the EMC filter capacitors, which might cause danger, or damage the drive.

Note: When the internal EMC filter is disconnected, the drive is not EMC compatible.

The following table shows the installation rules for the EMC filter screws in order to connect or disconnect the filter, depending on the system type and the frame size. For more information on the different system types, see [Floating networks](#) on page 12 and [Unsymmetrically grounded networks](#) on page 11.

The locations of screws EM1 and EM3 are shown in the diagram on page 8. The locations of screws F1 and F2 are shown in the diagram on page 9.

Frame sizes	Screw	Symmetrically grounded TN systems (TN-S systems)	Corner grounded TN systems	IT systems (ungrounded or high-resistance-grounded [$> 30 \text{ ohm}$])
R1...R3	EM1	x	x	–
	EM3	x	•	•
R4	EM1	x	x	–
	EM3	x	•	•
R5...R6	F1	x	x	–
	F2	x	x	–

x = Use the provided metal screw which may already be installed. (EMC filter(s) will be connected.)

• = Use the installed polyamide screw. (EMC output filter will be disconnected.)

– = Remove the installed metal screw. (EMC filter(s) will be disconnected.)

EM1 and EM3 screws are M4 x 12

F1 and F2 screws are M4 x 16

Ground connections

For personnel safety, proper operation and to reduce electromagnetic emission/pick-up, the drive and the motor must be grounded at the installation site.

- Conductors must be adequately sized as required by safety regulations.
- Power cable shields must be connected to the drive PE terminal in order to meet safety regulations.
- Power cable shields are suitable for use as equipment grounding conductors only when the shield conductors are adequately sized as required by safety regulations.
- In multiple drive installations, do not connect drive terminals in series.

Unsymmetrically grounded networks



WARNING! Do not attempt to install or remove EM1 or EM3 screws while power is applied to the drive's input terminals.

Unsymmetrically grounded networks are defined in the following table. In such networks, the internal connection provided by the EM3 screw (on frame sizes R1...R4 only) must be disconnected by removing EM3. If the grounding configuration of the network is unknown, remove EM3.

Note: ACH550-UH drives are shipped with the screw removed (but included in the conduit box).

Unsymmetrically Grounded Networks – EM3 Must Be Out			
Grounded at the corner of the delta		Grounded at the mid point of a delta leg	
Single phase, grounded at an end point		Three phase "Variac" without solidly grounded neutral	

EM3 (an M4x16 screw) makes an internal ground connection that reduces electro-magnetic emission. Where EMC (electro-magnetic compatibility) is a concern, and the network is symmetrically grounded, EM3 may be installed. For reference, the diagram at right illustrates a symmetrically grounded network.

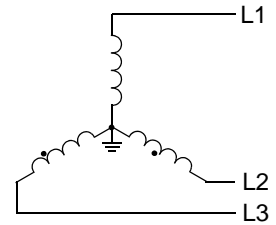

Floating networks



WARNING! Do not attempt to install or remove EM1, EM3, F1 or F2 screws while power is applied to the drive's input terminals.

For floating networks (also known as IT, ungrounded, or impedance/resistance grounded networks):

- Disconnect the ground connection to the internal RFI filters:
 - Frame sizes R1...R4: Remove the EM1 screw (unit is shipped with EM3 removed, see [Connection diagrams](#) on page 8).
 - Frame sizes R5...R6: Remove both the F1 and F2 screws (see page 9).
- Where EMC requirements exist, check for excessive emission propagated to neighboring low voltage networks. In some cases, the natural suppression in transformers and cables is sufficient. If in doubt, use a supply transformer with static screening between the primary and secondary windings.
- Do NOT install an external RFI/EMC filter. Using an RFI filter grounds the input power through the filter capacitors, which could be dangerous and could damage the unit.

Checking motor and motor cable insulation



WARNING! Check the motor and motor cable insulation before connecting the drive to input power. For this test, make sure that motor cables are NOT connected to the drive.

1. Complete motor cable connections to the motor, but NOT to the drive output terminals (U2, V2, W2).
2. At the drive end of the motor cable, measure the insulation resistance between each motor cable phase and Protective Earth (PE): Apply a voltage of 1 kV DC and verify that resistance is greater than 1 Mohm.

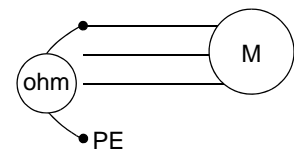

R1...R6, wiring UL type 1 enclosure

1. Open the appropriate knockouts in the conduit box. (See [Conduit kit](#) on page 7.)
2. Install thin-wall conduit clamps (not supplied).

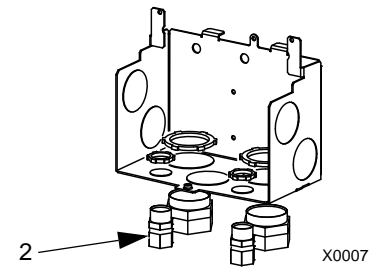

3. Install conduit box.
4. Connect conduit runs for input power, motor and control cables to the box.

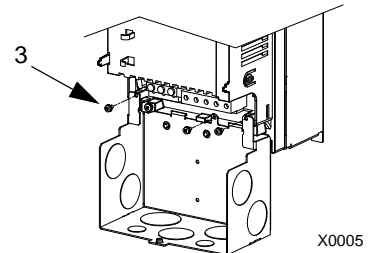

5. Route input power and motor wiring through separate conduits.
6. Strip wires.
7. Connect power, motor, and ground wires to the drive terminals.

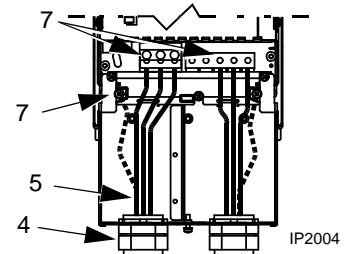

Note: For R5 frame size, the minimum power cable size is 25 mm² (4 AWG). For R6 frame size, refer to [Power terminal considerations – R6 Frame size](#) on page 16.

8. Route the control cables through the conduit (not the same conduit as either input power or motor wiring).
9. Use available secure points and tie strap landings to permanently secure control wiring at a minimum distance of 6 mm (1/4") from power wiring.
10. Strip the control cable sheathing and twist the copper screen into a pig-tail.
11. Connect the ground screen pig-tail for digital and analog I/O cables at X1-1. (Ground only at drive end.)
12. Connect the ground screen pig-tail for RS485 cables at X1-28 or X1-32. (Ground only at drive end.)
13. Strip and connect the individual control wires to the drive terminals.
14. Install the conduit box cover (1 screw).

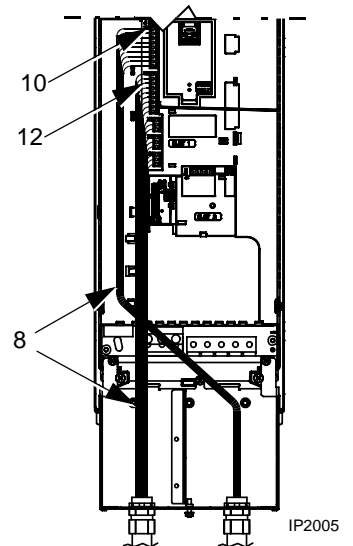

R1...R6, wiring UL type 12 enclosure

1. Step depends on Frame Size:
 - Frame Sizes R1...R4: Remove and discard the cable seals where conduit will be installed. (The cable seals are cone-shaped, rubber seals on the bottom of the drive.)
 - Frame Sizes R4 and R5: Use punch to create holes for conduit connections as needed.
2. For each conduit run (input power, motor and control wiring must be separate), install liquid tight conduit connectors (not supplied).
3. Route the power wiring through conduit.
4. Route the motor wiring through conduit (not the same conduit as input power wiring run). Use a separate, metal conduit run for each motor.
5. Strip the wires.
6. Connect the power, motor, and ground wires to the drive terminals.

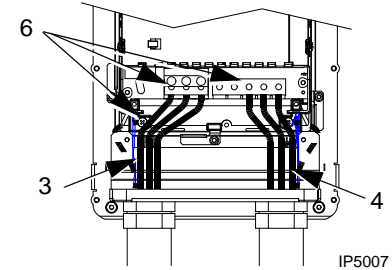
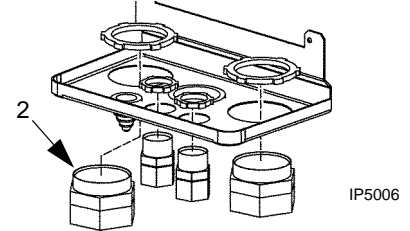
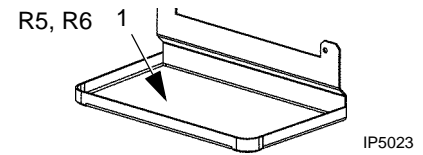
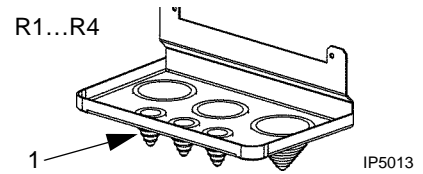

Note: For R5 frame size, the minimum power cable size is 25 mm² (4 AWG). For R6 frame size, refer to [Power terminal considerations – R6 Frame size](#) on page 16.

7. Route the control cables through the conduit (not the same conduit as either input power or motor wiring runs).
8. Use available secure points and tie strap landings to permanently secure control wiring at a minimum distance of 6 mm (1/4") from power wiring.
9. Strip the control cable sheathing and twist the copper screen into a pig-tail.
10. Connect the ground screen pig-tail for digital and analog I/O cables at X1-1. (Ground only at drive end.)
11. Connect the ground screen pig-tail for RS485 cables at X1-28 or X1-32. (Ground only at drive end.)
12. Strip and connect the individual control wires to the drive terminals.
13. Install the conduit box cover (1 screw).

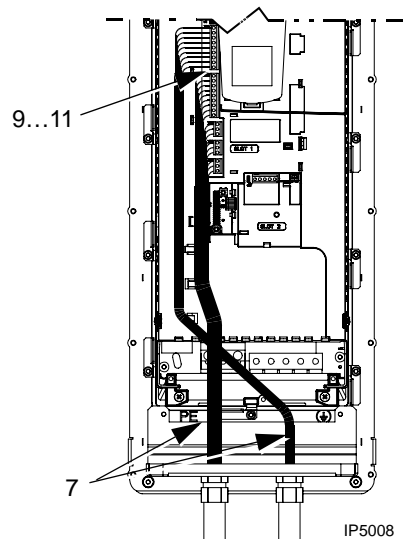

R7...R8, wiring (both enclosure types)

The figures show connections in the R7 cabinet, the R8 cabinet is similar.

1. Remove the conduit connection plate from the top of the left bay.
2. Route the input power, motor and control cables to the top of the cabinet. Each cable type (input power, motor, and control) must be in separate conduit. Use a separate, metal conduit run for each motor.
3. Use punch to create holes for conduit connections as needed.
4. UL type 12 Enclosure: For each conduit run (input power, motor and control wiring must be separate), install liquid tight conduit connectors (not supplied).
5. Connect input power and motor cables to the bus terminals.
6. Connect grounds to ground bar.
7. Use available secure points and tie strap landings to permanently secure control wiring at a minimum distance of 6 mm (1/4") from power wiring.
8. Strip the control cable sheathing and twist the copper screen into a pig-tail.
9. Connect the ground screen pig-tail for digital and analog I/O cables at X1-1. (Ground only at drive end.)
10. Connect the ground screen pig-tail for RS485 cables at X1-28 or X1-32. (Ground only at drive end.)
11. Strip and connect the individual control wires to the drive terminals.

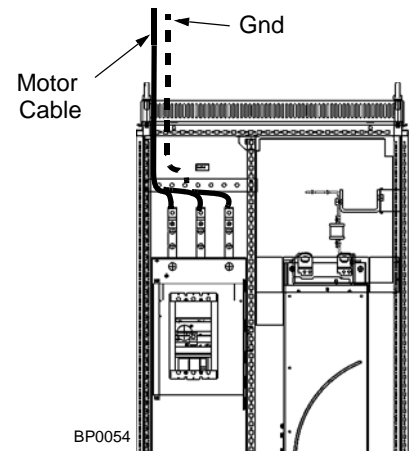
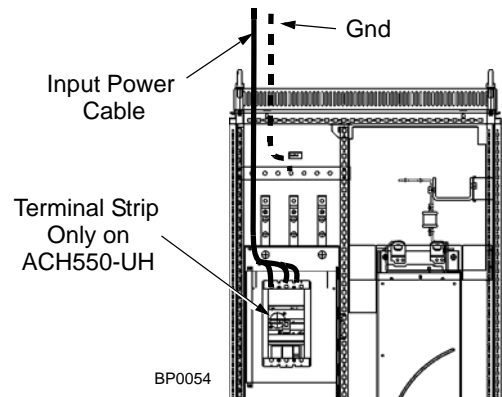

Drive's power connection terminals

The following table provides specifications for the drive's power connection terminals.

Frame Size	U1, V1, W1 U2, V2, W2 BRK±, UDC± Terminals						Earthing PE Terminal			
	Min. Wire Size		Max. Wire Size		Torque		Max. Wire Size		Torque	
	mm ²	AWG	mm ²	AWG	Nm	lb-ft	mm ²	AWG	Nm	lb-ft
R1 ^{Note 1}	0.75	18	10	8	1.4	1	10	8	1.4	1
R2 ^{Note 1}	0.75	18	10	8	1.4	1	10	8	1.4	1
R3 ^{Note 1}	2.5	14	25	3	2.5	1.8	16	6	1.8	1.3
R4 ^{Note 1}	6	10	50	1/0	5.6	4	25	3	2	1.5
R5	6	10	70	2/0	15	11	70	2/0	15	11
R6	95 ^{Note 2}	3/0	185	350 MCM	40	30	95	3/0	8	6
R7	16	6	185	350 MCM	40	30	Attach appropriate ring lugs to ground wires and mount with, up to five 13/32 bolts.			
R8	16	6	2x240	2x500 MCM	57	42				

1. Do not use aluminum cable with frame sizes R1...R4.
2. See the following section for smaller wire sizes on frame size R6.

Power terminal considerations – R6 Frame size



WARNING! For R6 power terminals, if compression lugs are supplied, they can only be used for wire sizes that are 95 mm² (3/0 AWG) or larger. Smaller wires will loosen and may damage the drive, and require ring lugs as described below.

On the R6 frame size, if the cable size used is less than 95 mm² (3/0 AWG) or if no compression lugs are supplied, use ring lugs.

Drive's control connection terminals

The following table provides specifications for the drive's control terminals







Frame Size	Control			
	Maximum Wire Size		Torque	
	mm ²	AWG	Nm	lb-ft
All	1.5	16	0.4	0.3

Control terminal descriptions

The following full-page diagram provides a general description of the control terminals on the drive.

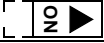
Note: Terminals 3, 6, and 9 are at the same potential.

Note: For safety reasons the fault relay signals a "fault" when the ACH550 is powered down.

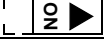
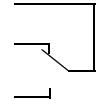
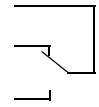
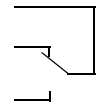
X1		Drive Control Terminal Description			
Analog I/O	1	SCR	Terminal for signal cable screen. (Connected internally to chassis ground.)		
	2	AI1	Analog input channel 1, programmable. Default ² = external reference. Resolution 0.1%, accuracy ±1%. J1:AI1 OFF: 0(2)...10 V (R _i = 312 kΩ)  or, for OFF  for ON 		
			J1:AI1 ON: 0(4)...20 mA (R _i = 100 Ω) 		
	3	AGND	Analog input circuit common (connected internally to chassis gnd. through 1 MΩ).		
	4	+10 V	Potentiometer reference source: 10 V ±2%, max. 10 mA (1kΩ ≤ R ≤ 10kΩ).		
	5	AI2	Analog input channel 2, programmable. Default ² = PID feedback. Resolution 0.1%, accuracy ±1%. J1:AI2 OFF: 0(2)...10 V (R _i = 312 kΩ)  or, for OFF  for ON 		
			J1:AI2 ON: 0(4)...20 mA (R _i = 100 Ω) 		
6	AGND	Analog input circuit common (connected internally to chassis gnd. through 1 MΩ).			
7	AO1	Analog output, programmable. Default ² = frequency. 0...20 mA (load < 500 Ω). Accuracy ±3% full scale.			
8	AO2	Analog output, programmable. Default ² = current. 0...20 mA (load < 500 Ω). Accuracy ±3% full scale.			
9	AGND	Analog output circuit common (connected internally to chassis gnd. through 1 MΩ).			
Digital Inputs ¹	10	+24V	Auxiliary voltage output 24 VDC / 250 mA (reference to GND), short circuit protected.		
	11	GND	Auxiliary voltage output common (connected internally as floating).		
	12	DCOM	Digital input common. To activate a digital input, there must be ≥+10 V (or ≤-10 V) between that input and DCOM. The 24 V may be provided by the ACH550 (X1-10) or by an external 12...24 V source of either polarity.		
	13	DI1	Digital input 1, programmable. Default ² = start/stop.		
	14	DI2	Digital input 2, programmable. Default ² = not configured.		
	15	DI3	Digital input 3, programmable. Default ² = constant (preset) speed.		
	16	DI4	Digital input 4, programmable. Default ² = safety interlock.		
Relay Outputs	19	RO1C		Relay output 1, programmable. Default ² = Ready Maximum: 250 VAC / 30 VDC, 2 A Minimum: 500 mW (12 V, 10 mA)	
		20			RO1A
		21			RO1B
	22	RO2C		Relay output 2, programmable. Default ² = Running Maximum: 250 VAC / 30 VDC, 2 A Minimum: 500 mW (12 V, 10 mA)	
		23			RO2A
		24			RO2B
	25	RO3C		Relay output 3, programmable. Default ² = Fault (-1) Maximum: 250 VAC / 30 VDC, 2 A Minimum: 500 mW (12 V, 10 mA)	
		26			RO3A
		27			RO3B

1 Digital input impedance 1.5 kΩ. Maximum voltage for digital inputs is 30 V.
 2 Default values depend on the macro used. Values specified are for the HVAC default macro.

You can wire the digital input terminals in either a PNP or NPN configuration.

PNP connection (source)

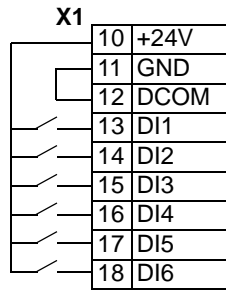

NPN connection (sink)

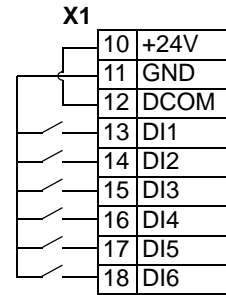

Serial communications

Terminals 28...32 provide RS485 serial communication connections used to control or monitor the drive from a fieldbus controller.

6. Check installation

Before applying power, perform the following checks.

✓	Check
	Installation environment conforms to the drive's specifications for ambient conditions.
	The drive is mounted securely.
	Space around the drive meets the drive's specifications for cooling.
	The motor and driven equipment are ready for start.
	For floating networks (R1...R6): The internal RFI filter is disconnected (screws EM1 & EM3 or F1 & F2).
	The drive is properly grounded.
	The input power voltage matches the drive nominal input voltage range.
	The input power connections at U1, V1, and W1 are connected and tightened as specified.
	The input power branch circuit protection is installed.
	The motor connections at U2, V2, and W2 are connected and tightened as specified.
	The input power, motor and control wiring are routed through separate conduit runs.
	NO power factor compensation capacitors are in the motor cable.
	The control connections are connected and tightened as specified.
	NO tools or foreign objects (such as drill shavings) are inside the drive.
	NO alternate power source for the motor (such as a bypass connection) is connected – no voltage is applied to the output of the drive.

7. Re-install cover

8. Apply power

Always re-install the covers before turning power on.



WARNING! The ACH550 will start up automatically at power up, if the external run command is on.

Apply input power. When power is applied to the ACH550, the green LED comes on.



WARNING! Even when the motor is stopped, dangerous voltage is present at the power circuit terminals U1, V1, W1 (L1, L2, L3) and U2, V2, W2 (T1, T2, T3) and, depending on the frame size, UDC+ and UDC-, or BRK+ and BRK-.

Note: Before increasing motor speed, check that the motor is running in the desired direction. To change rotation direction, switch motor leads as shown below. Power circuit terminal designation and location varies depending on the frame size and some terminals are not used (UDC+ and UDC-, or BRK+ and BRK-). Refer to pages [8](#) and [9](#) for specific terminal layouts

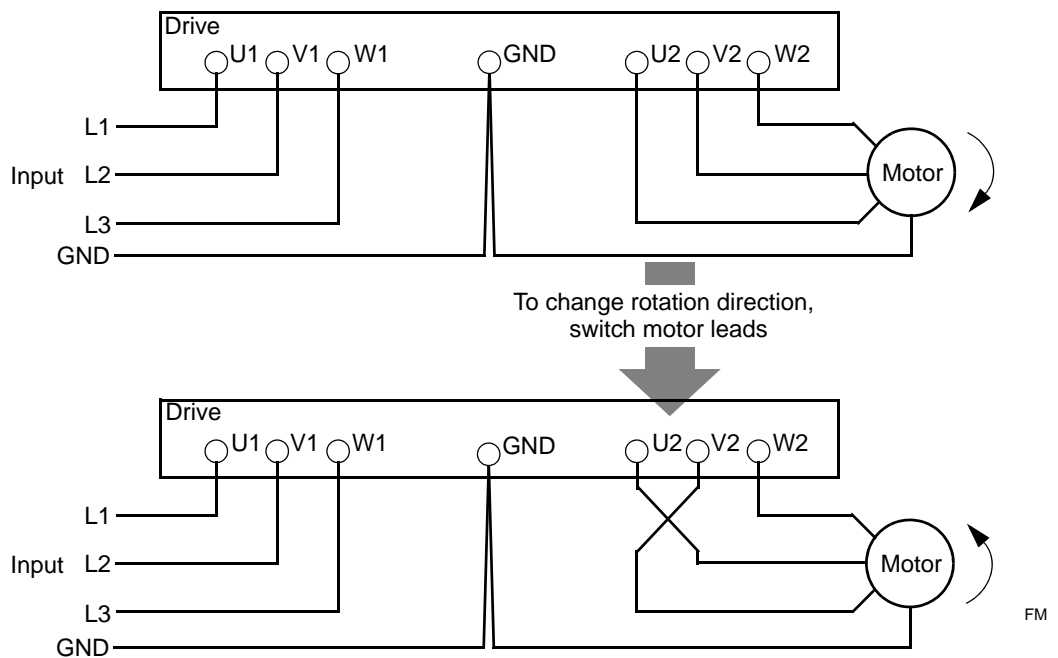

9. Before Start-up

The ACH550 has default parameter settings that are sufficient for many situations. However, review the following situations. Perform the associated procedures as appropriate.

Spin motor

When first installed and started the control panel displays a welcome screen with the following options.

- Press Exit to commission the drive as described in section [Start-up by changing the parameters individually](#) on page 23.
- Press Enter to move to the following options:
 - Select “Commission Drive” to commission the drive as described in section Start-Up by [Start-up by using the Start-Up Assistant](#) on page 23.
 - Select “Spin Motor” to operate the motor prior to commissioning. This option operates the motor without any commissioning, except entry of the motor data as described below. Spin Motor is useful, for example, to operate ventilation fans prior to commissioning.

Note: When using Spin Motor, the motor speed is limited to the range 1/3...2/3 of maximum speed. Also, no interlocks are activated. Finally, once the drive is commissioned, the welcome screen and this option no longer appear.

Motor data

The motor data on the ratings plate may differ from the defaults in the ACH550. The drive provides more precise control and better thermal protection if you enter the rating plate data.

1. Gather the following from the motor ratings plate:
 - Voltage
 - Nominal motor current
 - Nominal frequency
 - Nominal speed
 - Nominal power
2. Edit parameters 9905...9909 to the correct values.
 - Assistant Control Panel: The Start-Up Assistant walks you through this data entry.
 - Basic Control Panel: Refer to *ACH550 User's Manual*, for parameter editing instructions.

Fault and alarm adjustments

The ACH550 can detect a wide variety of potential system problems. For example, initial system operation may generate faults or alarms that indicate set-up problems.

1. Faults and alarms are reported on the control panel with a number. Note the number reported.
2. Review the description provided for the reported fault/alarm:
 - Use the fault and alarm listings on pages 24 and 29 respectively, or
 - Press the help key (Assistant Control Panel only) while fault or alarm is displayed.
3. Adjust the system or parameters as appropriate.

Operation

The ACH550 HVAC control panel (ACH-CP-B) features:

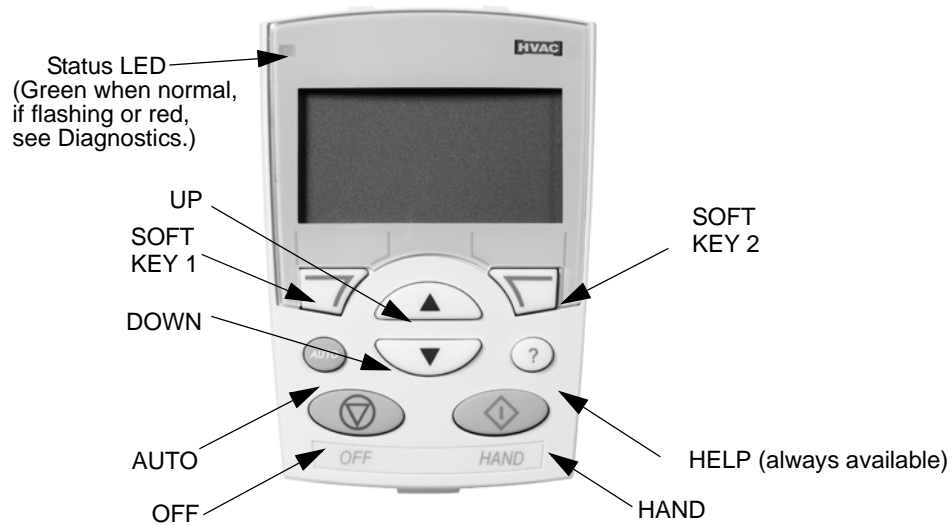



X0201

General display features

Soft key functions

The soft key functions are defined by text displayed just above each key.

Display contrast

To adjust display contrast, simultaneously press  and  or , as appropriate.



HVAC control panel modes

The HVAC control panel has several different modes for configuring, operating and diagnosing the drive. To reach the Standard Display Mode, press EXIT until the LCD display shows status information. Select MENU and use UP/DOWN buttons to select other modes. The modes are:

- **Standard Display Mode** – Shows drive status information and operates the drive.
- **Parameters Mode** – Edits parameter values individually.
- **Start-up Assistant Mode** – Guides the start-up and configuration.
- **Changed Parameters Mode** – Shows changed parameters.
- **Fault Logger Mode** – Shows the drive fault history.
- **Drive Parameter Backup Mode** – Stores or uploads the parameters.
- **Clock Set Mode** – Sets the time and date for the drive.
- **I/O Settings Mode** – Checks and edits the I/O settings.
- **Alarm Mode** – Reporting mode triggered by drive alarms.

Operating the drive

AUTO/HAND – The very first time the drive is powered up, it is in the auto control (AUTO) mode, and is controlled from the Control terminal block X1.

To switch to hand control (HAND) and control the drive using the control panel, press and hold the  or  button.

- Pressing the HAND button switches the drive to hand control while keeping the drive running.
- Pressing the OFF button switches to hand control and stops the drive.

To switch back to auto control (AUTO), press and hold the  button.

Hand/Auto/Off – To start the drive press the HAND or AUTO buttons, to stop the drive press the OFF button.









Reference – To modify the reference (only possible if the display in the upper right corner is in reverse video) press the UP or DOWN buttons (the reference changes immediately).

The reference can be modified in the local control mode (HAND/OFF), and can be parameterized (using Group 11 reference select) to also allow modification in the remote control mode.

Note: The Start/Stop, Shaft direction and Reference functions are only valid in local control (HAND/OFF) mode.

Start-up by using the Start-Up Assistant

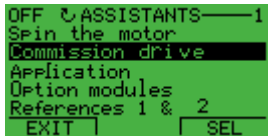









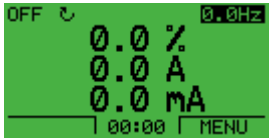

To start the Start-Up Assistant, follow these steps:

1	Select MENU to enter the main menu.		
2	Select ASSISTANTS with the Up/Down buttons and select ENTER.	 	
3	Scroll to COMMISSION DRIVE with the Up/Down buttons.		
4	Change the values suggested by the assistant to your preferences and then press SAVE after every change.		

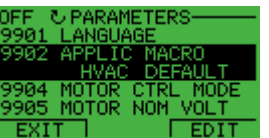
The Start-Up Assistant will guide you through the start-up.

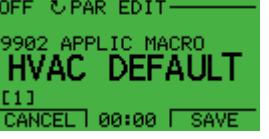
Start-up by changing the parameters individually

To change the parameters, follow these steps:

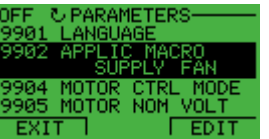
1	Select MENU to enter the main menu.		
2	Select the Parameters mode with the UP/DOWN buttons and select ENTER to select the Parameters mode.		
3	Select the appropriate parameter group with the UP/DOWN buttons and select SEL		
4	Select the appropriate parameter in a group with the UP/DOWN buttons. Select EDIT to change the parameter value.		
5	Press the UP/DOWN buttons to change the parameter value.		
6	Select SAVE to store the modified value or select CANCEL to leave the set mode. Any modifications not saved are cancelled.		
7	Select EXIT to return to the listing of parameter groups, and again to return to the main menu.	 	

Complete the control connections by manually entering the parameters.

Note: The current parameter value appears below the highlighted parameter. To view the default parameter value, press the UP/DOWN buttons simultaneously. To restore the default factory settings, select the application macro HVAC Default.

Diagnostics

Fault listing

Fault Code	Fault Name In Panel	Description and Recommended Corrective Action
1	OVERCURRENT	Output current is excessive. Check for and correct: <ul style="list-style-type: none"> Excessive motor load. Insufficient acceleration time (parameters 2202 ACCELER TIME 1 and 2205 ACCELER TIME 2). Faulty motor, motor cables or connections. Output disconnect device not interlocked. Interaction with external input filter.
2	DC OVERVOLT	Intermediate circuit DC voltage is excessive. Check for and correct: <ul style="list-style-type: none"> Static or transient overvoltages in the input power supply. Insufficient deceleration time (parameters 2203 DECELER TIME 1 and 2206 DECELER TIME 2). Verify that overvoltage controller is ON (using parameter 2005). Interaction with external input filter.
3	DEV OVERTEMP	Drive heatsink is overheated. Temperature is at or above limit. R1...R4 & R7/R8: 115 °C (239 °F) R5/R6: 125 °C (257 °F) Check for and correct: <ul style="list-style-type: none"> Fan failure. Obstructions in the air flow. Dirt or dust coating on the heat sink. Excessive ambient temperature. Excessive motor load.
4	SHORT CIRC	Fault current. Check for and correct: <ul style="list-style-type: none"> A short-circuit in the motor cable(s) or motor. Supply disturbances.
5	RESERVED	Not used.
6	DC UNDERVOLT	Intermediate circuit DC voltage is not sufficient. Check for and correct: <ul style="list-style-type: none"> Missing phase in the input power supply. Blown fuse. Undervoltage on mains.
7	AI1 LOSS	Analog input 1 loss. Analog input value is less than AI1FLT LIMIT (3021). Check for and correct: <ul style="list-style-type: none"> Source and connection for analog input. Parameter settings for AI1FLT LIMIT (3021) and 3001 AI<MIN FUNCTION.
8	AI2 LOSS	Analog input 2 loss. Analog input value is less than AI2FLT LIMIT (3022). Check for and correct: <ul style="list-style-type: none"> Source and connection for analog input. Parameter settings for AI2FLT LIMIT (3022) and 3001 AI<MIN FUNCTION.
9	MOT TEMP	Motor is too hot, based on either the drive's estimate or on temperature feedback. <ul style="list-style-type: none"> Check for overloaded motor. Adjust the parameters used for the estimate (3005...3009). Check the temperature sensors and Group 35 parameters.

Fault Code	Fault Name In Panel	Description and Recommended Corrective Action
10	PANEL LOSS	<p>Panel communication is lost and either:</p> <ul style="list-style-type: none"> • Drive is in local control mode (the control panel displays HAND or OFF), or • Drive is in remote control mode (AUTO) and is parameterized to accept start/stop, direction or reference from the control panel. <p>To correct check:</p> <ul style="list-style-type: none"> • Communication lines and connections • Parameter 3002 PANEL COMM ERROR. • Parameters in Group 10: START/STOP/DIR and Group 11: REFERENCE SELECT (if drive operation is AUTO).
11	ID RUN FAIL	<p>The motor ID run was not completed successfully. Check for and correct:</p> <ul style="list-style-type: none"> • Motor connections • Motor parameters 9905...9909 do not match motor nameplate.
12	MOTOR STALL	<p>Motor or process stall. Motor is operating in the stall region. Check for and correct:</p> <ul style="list-style-type: none"> • Excessive load. • Insufficient motor power. • Parameters 3010...3012.
14	EXTERNAL FLT 1	<p>Digital input defined to report first external fault is active. See parameter 3003 EXTERNAL FAULT 1.</p>
15	EXTERNAL FLT 2	<p>Digital input defined to report second external fault is active. See parameter 3004 EXTERNAL FAULT 2.</p>
16	EARTH FAULT	<p>Possible ground fault detected in the motor or motor cables. The drive monitors for ground faults while the drive is running and while the drive is not running. Detection is more sensitive when the drive is not running and can produce false positives.</p> <p>Possible corrections:</p> <ul style="list-style-type: none"> • Check for/correct faults in the input wiring. • Verify that motor cable does not exceed maximum specified length. • A delta grounded input power supply and motor cables with high capacitance may result in erroneous error reports during non-running tests. To disable response to fault monitoring when the drive is not running, use parameter 3023 WIRING FAULT. To disable response to all ground fault monitoring, use parameter 3017 EARTH FAULT.
17	UNDERLOAD	<p>Motor load is lower than expected. Check for and correct:</p> <ul style="list-style-type: none"> • Disconnected load. • Group 37: USER LOAD CURVE.
18	THERM FAIL	<p>Internal fault. The thermistor measuring the internal temperature of the drive is open or shorted. Contact your local ABB sales representative.</p>
19	OPEX LINK	<p>Internal fault. A communication-related problem has been detected on the fiber optic link between the OITF and OINT boards. Contact your local ABB sales representative.</p>
20	OPEX PWR	<p>Internal fault. Low voltage condition detected on OINT power supply. Contact your local ABB sales representative.</p>
21	CURR MEAS	<p>Internal fault. Current measurement is out of range. Contact your local ABB sales representative.</p>

Fault Code	Fault Name In Panel	Description and Recommended Corrective Action
22	SUPPLY PHASE	Ripple voltage in the DC link is too high. Check for and correct: <ul style="list-style-type: none"> • Missing mains phase. • Blown fuse. • Interaction with external input filter. Set parameter 2619 to "ON".
23	ENCODER ERR	Not used (Available only with encoder and parameter Group 50).
23	ENCODER ERR	The drive is not detecting a valid encoder signal. Check for and correct: <ul style="list-style-type: none"> • Encoder presence and proper connection (reverse wired, loose connection, or short circuit). • Voltage logic levels are outside of the specified range. • A working and properly connected Pulse Encoder Interface Module, OTAC-01. • Wrong value entered in parameter 5001 PULSE NR. A wrong value will only be detected if the error is such that the calculated slip is greater than 4 times the rated slip of the motor. • Encoder is not being used, but parameter 5002 ENCODER ENABLE = 1 (ENABLED).
24	OVERSPEED	Motor speed is greater than 120% of the larger (in magnitude) of 2001 MINIMUM SPEED or 2002 MAXIMUM SPEED. Check for and correct: <ul style="list-style-type: none"> • Parameter settings for 2001 and 2002. • Adequacy of motor braking torque. • Applicability of torque control. • Brake chopper and resistor.
25	RESERVED	Not used as of the publication of this manual.
26	DRIVE ID	Internal fault. Configuration Block Drive ID is not valid. Contact your local ABB sales representative.
27	CONFIG FILE	Internal configuration file has an error. Contact your local ABB sales representative.
28	SERIAL 1 ERR	Fieldbus communication has timed out. Check for and correct: <ul style="list-style-type: none"> • Fault setup (3018 COMM FAULT FUNC and 3019 COMM FAULT TIME). • Communication settings (Group 51 or 53 as appropriate). • Poor connections and/or noise on line.
29	EFB CONFIG FILE	Error in reading the configuration file for the embedded fieldbus.
30	FORCE TRIP	Fault trip forced by the fieldbus. See the fieldbus User's Manual.
31	EFB 1	Fault code reserved for the embedded fieldbus (EFB) protocol application. These codes are not used as of the publication of this manual.
32	EFB 2	
33	EFB 3	
34	MOTOR PHASE	Fault in the motor circuit. One of the motor phases is lost. Check for and correct: <ul style="list-style-type: none"> • Motor fault. • Motor cable fault. • Thermal relay fault (if used). • Internal fault.

Fault Code	Fault Name In Panel	Description and Recommended Corrective Action
35	OUTPUT WIRING	Possible power wiring error detected. When the drive is not running it monitors for an improper connection between the drive input power and the drive output. Check for and correct: <ul style="list-style-type: none"> • Proper input wiring – line voltage is NOT connected to drive output. • The fault can be erroneously declared if the input power is a delta grounded system and motor cable capacitance is large. This fault can be disabled using parameter 3023 WIRING FAULT.
36	INCOMP SWTYPE	The drive cannot use the software. <ul style="list-style-type: none"> • Internal Fault. • The loaded software is not compatible with the drive. • Call support representative.
37	CB OVERTEMP	Drive control board is overheated. Check for and correct: <ul style="list-style-type: none"> • Excessive ambient temperatures • Fan failure. • Obstructions in the air flow.
38	USER LOAD CURVE	Condition defined by parameter 3701 USER LOAD C MODE has been valid longer than the time defined by 3703 USER LOAD C TIME.
101	SERF CORRUPT	Error internal to the drive. Contact your local ABB sales representative and report the error number.
102	RESERVED	
103	SERF MACRO	
104	RESERVED	
105	RESERVED	
201	DSP T1 OVERLOAD	Error in the system. Contact your local ABB sales representative and report the error number.
202	DSP T2 OVERLOAD	
203	DSP T3 OVERLOAD	
204	DSP STACK ERROR	
205	RESERVED (obsolete)	
206	OMIO ID ERROR	
207	EFB LOAD ERR	
1000	PAR HZRPM LIMITS	Parameter values are inconsistent. Check for any of the following: <ul style="list-style-type: none"> • 2001 MINIMUM SPEED > 2002 MAXIMUM SPEED. • 2007 MINIMUM FREQ > 2008 MAXIMUM FREQ. • 2001 MINIMUM SPEED / 9908 MOTOR NOM SPEED is outside proper range (> 50) • 2002 MAXIMUM SPEED / 9908 MOTOR NOM SPEED is outside proper range (> 50) • 2007 MINIMUM FREQ / 9907 MOTOR NOM FREQ is outside proper range (> 50) • 2008 MAXIMUM FREQ / 9907 MOTOR NOM FREQ is outside proper range (> 50)
1001	PAR PFAREFNG	Parameter values are inconsistent. Check for the following: <ul style="list-style-type: none"> • 2007 MINIMUM FREQ is negative, when 8123 PFA ENABLE is active.

Fault Code	Fault Name In Panel	Description and Recommended Corrective Action
1002	RESERVED (Obsolete)	
1003	PAR AI SCALE	Parameter values are inconsistent. Check for any of the following: <ul style="list-style-type: none"> 1301 AI 1 MIN > 1302 AI 1 MAX. 1304 AI 2 MIN > 1305 AI 2 MAX.
1004	PAR AO SCALE	Parameter values are inconsistent. Check for any of the following: <ul style="list-style-type: none"> 1504 AO 1 MIN > 1505 AO 1 MAX. 1510 AO 2 MIN > 1511 AO 2 MAX.
1005	PAR PCU 2	Parameter values for power control are inconsistent: Improper motor nominal kVA or motor nominal power. Check for the following: <ul style="list-style-type: none"> $1.1 \leq (9906 \text{ MOTOR NOM CURR} * 9905 \text{ MOTOR NOM VOLT} * 1.73 / P_N) \leq 3.0$ Where: $P_N = 1000 * 9909 \text{ MOTOR NOM POWER}$ (if units are kW) or $P_N = 746 * 9909 \text{ MOTOR NOM POWER}$ (if units are HP, e.g. in US)
1006	EXT ROMISSING	Parameter values are inconsistent. Check for the following: <ul style="list-style-type: none"> Extension relay module not connected and 1410...1412 RELAY OUTPUTS 4...6 have non-zero values.
1007	PAR FBUSMISSING	Parameter values are inconsistent. Check for and correct: <ul style="list-style-type: none"> A parameter is set for fieldbus control (e.g. 1001 EXT1 COMMANDS = 10 (COMM)), but 9802 COMM PROT SEL = 0.
1008	PAR PFAWOSCALAR	Parameter values are inconsistent – 9904 MOTOR CTRL MODE must be = 3 (SCALAR: SPEED), when 8123 PFA ENABLE is activated.
1009	PAR PCU1	Parameter values for power control are inconsistent: Improper motor nominal frequency or speed. Check for both of the following: <ul style="list-style-type: none"> $1 \leq (60 * 9907 \text{ MOTOR NOM FREQ} / 9908 \text{ MOTOR NOM SPEED}) \leq 16$ $0.8 \leq 9908 \text{ MOTOR NOM SPEED} / (120 * 9907 \text{ MOTOR NOM FREQ} / \text{Motor Poles}) \leq 0.992$
1010	PAR PFA OVERRIDE	Both the override mode and PFA are activated at the same time. These modes are mutually incompatible, because PFA interlocks cannot be observed in the override mode.
1011	PAR OVERRIDE PARS	Override is enabled, but parameters are incompatible. Verify that 1701 is not zero, and (depending on 9904 value) 1702 or 1703 is not zero.
1012	PAR PFA IO 1	IO configuration is not complete – not enough relays are parameterized to PFA. Or, a conflict exists between Group 14, parameter 8117, NR OF AUX MOT, and parameter 8118, AUTOCHNG INTERV.
1013	PAR PFA IO 2	IO configuration is not complete – the actual number of PFA motors (parameter 8127, MOTORS) does not match the PFA motors in Group 14 and parameter 8118 AUTOCHNG INTERV.
1014	PAR PFA IO 3	IO configuration is not complete – the drive is unable to allocate a digital input (interlock) for each PFA motor (parameters 8120 INTERLOCKS and 8127 MOTORS).

Fault history

For reference, the last three fault codes are stored into parameters 0401, 0412, 0413. For the most recent fault (identified by parameter 0401), the drive stores additional data (in parameters 0402...0411) to aid in troubleshooting a problem. For example, parameter 0404 stores the motor speed at the time of the fault.

To clear the fault history (all of the Group 04, Fault History parameters):

1. Using the control panel in Parameters mode, select parameter 0401.
2. Press EDIT.
3. Press UP and Down simultaneously.
4. Press SAVE.

Alarm listing

The following table lists the alarms by code number and describes each.

Alarm Code	Display	Description
2001	OVERCURRENT	Current limiting controller is active. Check for and correct: <ul style="list-style-type: none"> • Excessive motor load. • Insufficient acceleration time (parameters 2202 ACCELER TIME 1 and 2205 ACCELER TIME 2). • Faulty motor, motor cables or connections. • Output disconnect device not interlocked. • Interaction with external input filter.
2002	OVERVOLTAGE	Over voltage controller is active. Check for and correct: <ul style="list-style-type: none"> • Static or transient overvoltages in the input power supply. • Insufficient deceleration time (parameters 2203 DECELER TIME 1 and 2206 DECELER TIME 2). • Interaction with external input filter.
2003	UNDERVOLTAGE	Under voltage controller is active. Check for and correct: <ul style="list-style-type: none"> • Undervoltage on mains.
2004	DIR LOCK	The change in direction being attempted is not allowed. Either: <ul style="list-style-type: none"> • Do not attempt to change the direction of motor rotation, or • Change parameter 1003 DIRECTION to allow direction change (if reverse operation is safe).
2005	I/O COMM	Fieldbus communication has timed out. Check for and correct: <ul style="list-style-type: none"> • Fault setup (3018 COMM FAULT FUNC and 3019 COMM FAULT TIME). • Communication settings (Group 51 or 53 as appropriate). • Poor connections and/or noise on line.
2006	AI1 LOSS	Analog input 1 is lost, or value is less than the minimum setting. Check: <ul style="list-style-type: none"> • Input source and connections • Parameter that sets the minimum (3021) • Parameter that sets the Alarm/Fault operation (3001)
2007	AI2 LOSS	Analog input 2 is lost, or value is less than the minimum setting. Check: <ul style="list-style-type: none"> • Input source and connections • Parameter that sets the minimum (3022) • Parameter that sets the Alarm/Fault operation (3001)

Alarm Code	Display	Description
2008	PANEL LOSS	<p>Panel communication is lost and either:</p> <ul style="list-style-type: none"> • Drive is in local control mode (the control panel displays HAND or OFF), or • Drive is in remote control mode (AUTO) and is parameterized to accept start/stop, direction or reference from the control panel. <p>To correct check:</p> <ul style="list-style-type: none"> • Communication lines and connections • Parameter 3002 PANEL LOSS. • Parameters in Groups 10 START/STOP/DIR and 11: REFERENCE SELECT (if drive operation is AUTO).
2009	DEVICE OVERTEMP	<p>Drive heatsink is hot. This alarm warns that a DEVICE OVERTEMP fault may be near.</p> <p>R1...R4 & R7/R8: 100 °C (212 °F) R5/R6: 110 °C (230 °F)</p> <p>Check for and correct:</p> <ul style="list-style-type: none"> • Fan failure. • Obstructions in the air flow. • Dirt or dust coating on the heat sink. • Excessive ambient temperature. • Excessive motor load.
2010	MOT OVERTEMP	<p>Motor is hot, based on either the drive's estimate or on temperature feedback. This alarm warns that a Motor Underload fault trip may be near. Check:</p> <ul style="list-style-type: none"> • Check for overloaded motor. • Adjust the parameters used for the estimate (3005...3009). • Check the temperature sensors and Group 35 parameters.
2011	UNDERLOAD	<p>Motor load is lower than expected. This alarm warns that a Motor Underload fault trip may be near. Check:</p> <ul style="list-style-type: none"> • Motor and drive ratings match (motor is NOT undersized for the drive) • Settings Group 37: USER LOAD CURVE
2012	MOTOR STALL	<p>Motor is operating in the stall region. This alarm warns that a Motor Stall fault trip may be near.</p>
2013 (note 1)	AUTORESET	<p>This alarm warns that the drive is about to perform an automatic fault reset, which may start the motor.</p> <ul style="list-style-type: none"> • To control automatic reset, use parameter Group 31: AUTOMATIC RESET.
2014 (note 1)	AUTOCHANGE	<p>This alarm warns that the PFA autochange function is active.</p> <ul style="list-style-type: none"> • To control PFA, use parameter Group 81: PFA CONTROL
2015	PFA INTERLOCK	<p>This alarm warns that the PFA interlocks are active, which means that the drive cannot start the following:</p> <ul style="list-style-type: none"> • Any motor (when Autochange is used), • The speed regulated motor (when Autochange is not used).
2016	Reserved	
2017 (note 1)	OFF BUTTON	<p>This alarm warns that parameter 1606 LOCAL LOCK is active and the drive is in the AUTO mode. When the OFF key is pressed, the drive remains in the AUTO mode but coasts to stop.</p>

Alarm Code	Display	Description
2018 (note 1)	PID SLEEP	This alarm warns that the PID sleep function is active, which means that the motor could accelerate when the PID sleep function ends. <ul style="list-style-type: none"> To control PID sleep, use parameters 4022...4026 or 4122...4126.
2019	ID RUN	Performing ID run.
2020	OVERRIDE	This alarm warns that the Override function is active, which may start the motor.
2021	START ENABLE 1 MISSING	This alarm warns that the Start Enable 1 signal is missing. <ul style="list-style-type: none"> To control Start Enable 1 function, use parameter 1608. To correct, check: <ul style="list-style-type: none"> Digital input configuration. Communication settings.
2022	START ENABLE 2 MISSING	This alarm warns that the Start Enable 2 signal is missing. <ul style="list-style-type: none"> To control Start Enable 2 function, use parameter 1609. To correct, check: <ul style="list-style-type: none"> Digital input configuration. Communication settings.
2023	EMERGENCY STOP	Emergency stop activated.
2024	ENCODER ERROR	The drive is not detecting a valid encoder signal. Check for and correct: <ul style="list-style-type: none"> Encoder presence and proper connection (reverse wired, loose connection, or short circuit). Voltage logic levels are outside of the specified range. A working and properly connected Pulse Encoder Interface Module, OTAC-01. Wrong value entered in parameter 5001 PULSE NR. A wrong value will only be detected if the error is such that the calculated slip is greater than 4 times the rated slip of the motor. Encoder is not being used, but parameter 5002 ENCODER ENABLE = 1 (ENABLED).
2025	FIRST START	Signals that a the drive is performing a First Start evaluation of motor characteristics. This is normal the first time the motor is run after motor parameters are entered or changed. See parameter 9910 (MOTOR ID RUN) for a description of motor models.
2026	RESERVED	Not used.
2027	USER LOAD CURVE	This alarm warns that the condition defined by parameter 3701 USER LOAD C MODE has been valid longer that half of the time difined by 3703 USER LOAD C TIME.
2028	START DELAY	Shown during the Start delay. See parameter 2113 START DELAY.

Note 1. Even when the relay output is configured to indicate alarm conditions (e.g. parameter 1401 RELAY OUTPUT 1 = 5 (ALARM) or 16 (FLT/ALARM)), this alarm is not indicated by a relay output.

Maintenance



Warning! Read [Safety](#) on page 2 before performing any maintenance on the equipment. Ignoring the safety instructions can cause injury or death.

Maintenance intervals

If installed in an appropriate environment, the drive requires very little maintenance. This table lists the routine maintenance intervals recommended by ABB.

Maintenance	Application	Interval	Instruction
Check/replace R7/R8 enclosure inlet air filter	R7/R8 UL type 12 enclosures	Check every 3 months. Replace as needed.	Frame Sizes R7/R8 – UL type 12 enclosure inlet air filter on page 35
Check/replace R7/R8 enclosure exhaust air filter.	R7/R8 UL type 12 enclosures	Check every 6 months. Replace as needed.	Frame Sizes R7/R8 – UL type 12 enclosure exhaust filters on page 37
Check and clean heatsink.	All	Depends on the dustiness of the environment (every 6...12 months)	See Heatsink below.
Check cable connections are secure and tighten as specified.	All	Every year.	See Power & Control Connections on page 16 .
Replace enclosure fan.	UL type 12 enclosures	Every three years.	See Enclosure fan replacement – UL Type 12 enclosures on page 34 .
Replace drive module fan.	All	Every six years.	See Drive module fan replacement on page 33 .
Change capacitor.	Frame sizes R5, R6 and R8	Every ten years.	See Capacitors on page 38 .
Replace battery in the Assistant control panel	All	Every ten years.	See Control panel on page 38 .

Heatsink

The heatsink fins accumulate dust from the cooling air. Since a dusty heatsink is less efficient at cooling the drive, overtemperature faults become more likely. In a “normal” environment (not dusty, not clean) check the heatsink annually, in a dusty environment check more often.

Clean the heatsink as follows (when necessary):

1. Remove power from drive.
2. Remove the cooling fan (see section [Drive module fan replacement](#) on page 33).
3. Blow clean compressed air (not humid) from bottom to top and simultaneously use a vacuum cleaner at the air outlet to trap the dust.

Note: If there is a risk of the dust entering adjoining equipment, perform the cleaning in another room.

4. Replace the cooling fan.
5. Restore power.

Drive module fan replacement

The drive module fan cools the heatsink. Fan failure can be predicted by the increasing noise from fan bearings and the gradual rise in the heatsink temperature in spite of heatsink cleaning. If the drive is operated in a critical part of a process, fan replacement is recommended once these symptoms start appearing. Replacement fans are available from ABB. Do not use other than ABB specified spare parts.

To monitor the running time of the cooling fan, see *Group 29: MAINTENANCE TRIG* instructions.

Frame Sizes R1...R4

To replace the fan:

1. Remove power from drive.
2. Remove drive cover.
3. For Frame Size:
 - R1, R2: Press together the retaining clips on the fan cover sides, and lift.
 - R3, R4: Press in on the lever located on the left side of the fan mount, and rotate the fan up and out.
4. Disconnect the fan cable.
5. Install the fan in reverse order.
6. Restore power.

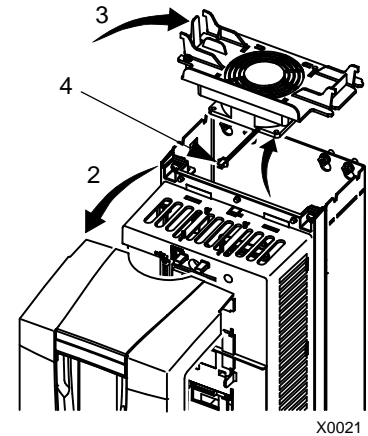

X0021

Frame Sizes R5 and R6

To replace the fan:

1. Remove power from drive.
2. Remove the screws attaching the fan.
3. Remove the fan:
 - R5: Swing the fan out on its hinges.
 - R6: Pull the fan out.
4. Disconnect the fan cable.
5. Install the fan in reverse order.
6. Restore power.

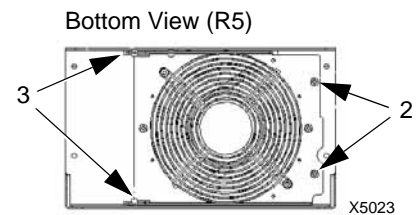

X5023

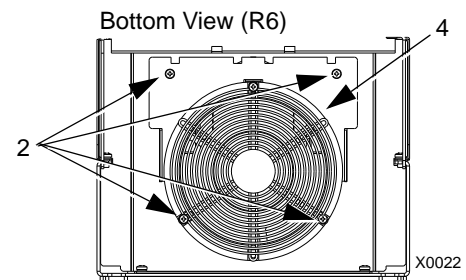

X0022

Frame Sizes R7 and R8

Refer to the installation instructions supplied with the fan kit.

Enclosure fan replacement – UL Type 12 enclosures

UL type 12 enclosures include an additional fan (or fans) to move air through the enclosure.

Frame Sizes R1 to R4

To replace the internal enclosure fan in frame sizes R1 to R4:

1. Remove power from drive.
2. Remove the front cover.
3. The housing that holds the fan in place has barbed retaining clips at each corner. Press all four clips toward the center to release the barbs.
4. When the clips/barbs are free, pull the housing up to remove from the drive.
5. Disconnect the fan cable.
6. Install the fan in reverse order, noting that:
 - The fan air flow is up (refer to arrow on fan).
 - The fan wire harness is toward the front.
 - The notched housing barb is located in the right-rear corner.
 - The fan cable connects just forward of the fan at the top of the drive.

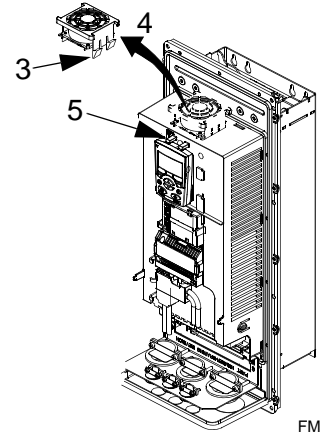

Frame Sizes R5 and R6

To replace the internal enclosure fan in frame sizes R5 or R6:

- Remove power from drive.
- Remove the front cover.
- Lift the fan out and disconnect the cable.
- Install the fan in reverse order.
- Restore power.

Frame Sizes R7/R8 – UL type 12 enclosures

The enclosure fan is located in the exhaust box on top of the UL type 12 enclosure.

1. Remove the left and right filter frames of the exhaust fan box by lifting them upwards.
2. Disconnect the fan's electrical connector from the cabinet roof (top right inside the cabinet).

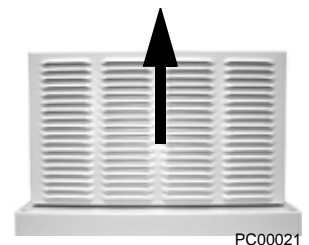

- Undo the four fastening screws at the corners of the fan frame. The screws are through bolts with nuts on the inside of the cabinet. (Do not drop the hardware into the drive).

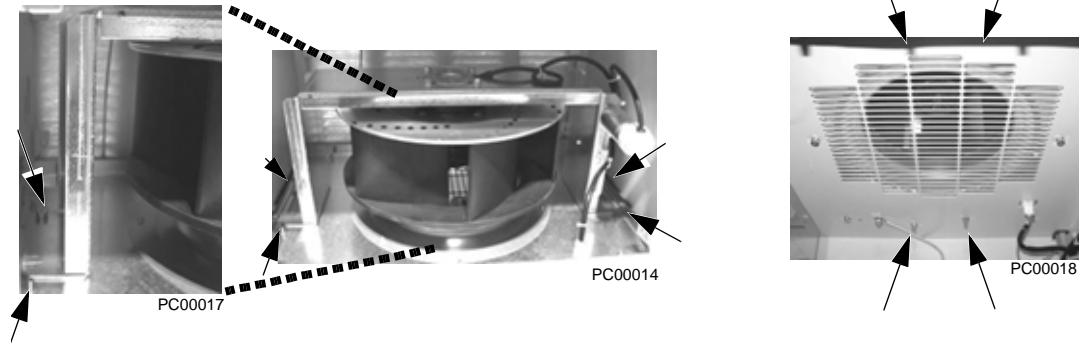

- Remove the fan and fan frame as one unit.

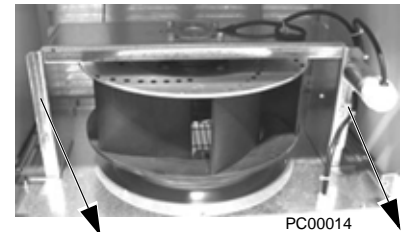

- Disconnect the fan wiring and capacitor from the fan frame. Then remove the four screws attaching the fan to the fan frame. Remove the old fan.

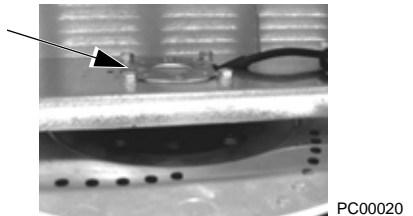

- Install the new fan and capacitor with the replacement part for ABB in the reverse order of the above. Ensure the fan is centered on the velocity stack and rotates freely.



Enclosure air filter replacement – UL Type 12 enclosures

Frame Sizes R7/R8 – UL type 12 enclosure inlet air filter

The inlet air filter for the R7/R8 UL type 12 enclosure is located in the enclosure front door.

- While holding the top of the filter frame, pull up on the bottom of the frame. The filter frame will slide up approximately 3/4 inch and can then safely removed by tilting away from the cabinet and lifting up.

2. Lay the filter frame on a flat work surface. Remove the 3 retaining brackets by squeezing the tabbed corners in towards the middle of each bracket until the bracket clears the filter frame. Save these brackets for replacement. Remove and inspect the filter.

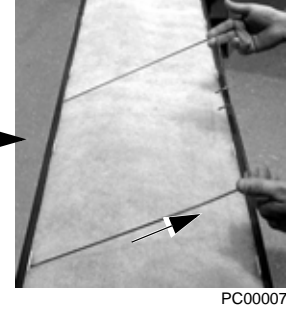
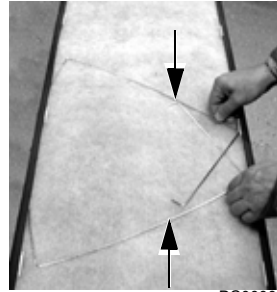

3. Install the replacement filter. Be sure to tuck the filter into the groove around the entire filter frame. This is very important for proper installation.



4. Reinstall the 3 filter restraining brackets. These will prevent the filter from being pulled out of the filter frame.

- Install the center bracket first.
- Install the 2nd bracket overlapping the center bracket by 1/2 to the left.
- Install the 3rd bracket overlapping the center bracket by 1/2 to the right.

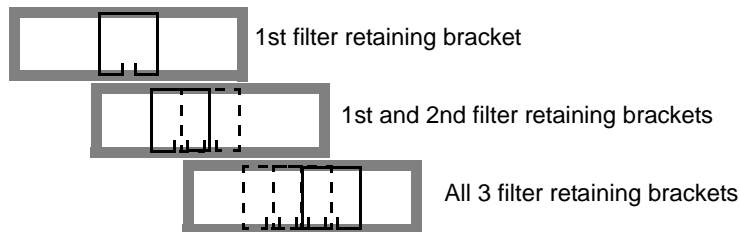
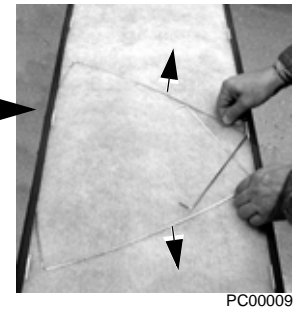
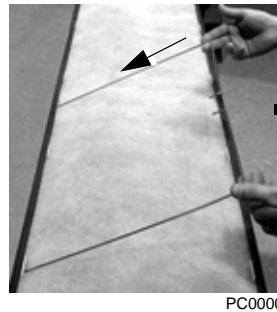

5. Install the filter frame back to the cabinet door. Carefully align the mounting hooks to the slots in the cabinet door. The hooks should be pointing down. Press in at the center of the filter frame with your knee and gently press down with your hands at the top of the frame. The filter frame will slide down approximately 3/4 inch and should be sealed securely to the door around the entire filter frame.

Frame Sizes R7/R8 – UL type 12 enclosure exhaust filters

The exhaust filters in the R7/R8 UL type 12 enclosure are located in the exhaust box at the top of the enclosure.

There are 2 filter frames attached to the exhaust box.

1. Remove power from drive.
2. Wait 5 minutes to ensure the fan has stopped.
3. Remove each filter frame:

- Lift up on the filter frame until it slides approximately 3/4 inch.
- Pull away from the exhaust box to remove.

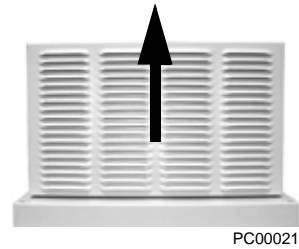

4. For each filter frame, remove the wire retainers that hold the filters in place:

- Lay the filter frames on a flat work surface.
- The wire retainers have a square “U” shape. Remove by squeezing the open end of the “U” towards the middle of the “square” until the retainer top (open end of “U”) clears the filter frame.
- Save the retainers for reinstallation.

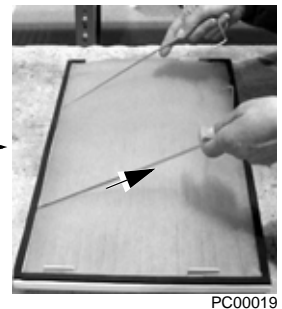
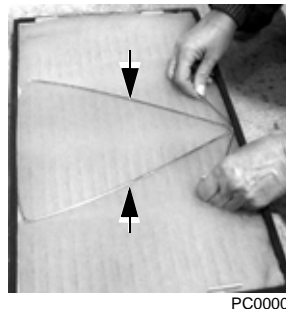

5. Remove and inspect the filter.
6. Install clean filters.

Note: When installing DUSTLOK® filter media, the white side must face to outside of the cabinet, and the orange side faces in.

Be sure to tuck the filter edges into the groove around the entire filter frame. This detail is very important for proper operation.



7. Reinstall the filter restrainers.

- Insert the base of a retainer (bottom of “U” shape) into a filter frame channel.
- Squeeze the open end of the “U” until it clears the filter frame.
- Seat the open end of the “U” in the filter frame channel.
- Release the retainer to its relaxed, square shape.

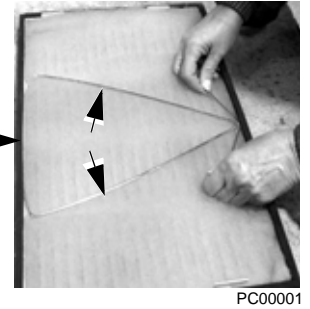
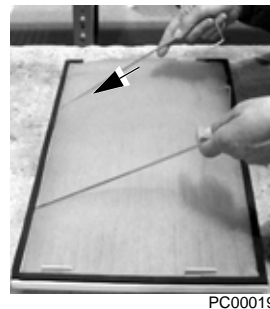

8. Install each filter frame to the bonnet on top of the cabinet.
 - Carefully align the frame's mounting hooks with the slots in the bonnet. (The hooks should be pointing down.)
 - Press down at the top of the filter frame. (The filter frame slides down approximately 3/4 inch).
 - Check all around the filter frame for a secure seal to the exhaust box.

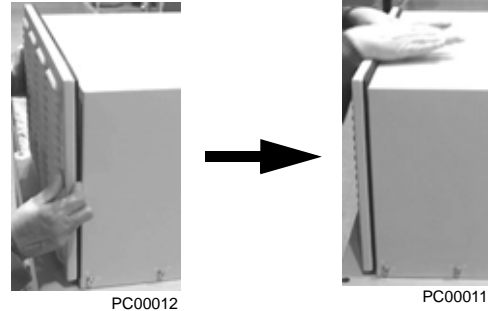

Capacitors

The drive intermediate circuit employs several electrolytic capacitors. Their life span is from 35,000...90,000 hours depending on drive loading and ambient temperature. Capacitor life can be prolonged by lowering the ambient temperature.

It is not possible to predict a capacitor failure. Capacitor failure is usually followed by a input power fuse failure or a fault trip. Contact ABB if capacitor failure is suspected. Replacements for frame size R5, R6 and R8 are available from ABB. Do not use other than ABB specified spare parts.

Control panel

Cleaning

Use a soft damp cloth to clean the control panel. Avoid harsh cleaners which could scratch the display window.

Battery

A battery is only used in Assistant control panels that have the clock function available and enabled. The battery keeps the clock operating in memory during power interruptions.

The expected life for the battery is greater than ten years. To remove the battery, use a coin to rotate the battery holder on the back of the control panel. Replace the battery with type CR2032.

Note: The battery is NOT required for any control panel or drive function, except the clock.

ACH550 E-Cclipse Bypass

Installation – drive

Follow the [Installation](#) instructions for the drive on page 3. **Failure to observe the warnings and instructions may cause a malfunction or personal hazard.**



WARNING! Before you begin read [Safety](#) on page 2.

Installation – bypass



WARNING! When the ACH550 with E-Cclipse Bypass is connected to the line power, the Motor Terminals T1, T2, and T3 are live even if the motor is not running. Do not make any connections when the ACH550 with E-Cclipse Bypass is connected to the line. Disconnect and lock out power to the drive before servicing the drive. Failure to disconnect power may cause serious injury or death.

1. Install wiring – bypass



WARNING!

- Do not connect or disconnect input or output power wiring, or control wires, when power is applied.
 - Never connect line voltage to drive output Terminals T1, T2, and T3.
 - Do not make any voltage tolerance tests (Hi Pot or Megger) on any part of the unit. Disconnect motor wires before taking any measurements in the motor or motor wires.
 - Make sure that power factor correction capacitors are not connected between the drive and the motor.
-

Enclosure Designation	Horsepower Range by Voltage Rating		
	208/240V	480V	600V
V1/V2	1 to 7.5 HP	1 to 15 HP	2 to 15 HP
V3/V4	10 to 25 HP	20 to 60 HP	20 to 60 HP
B1	1 to 7.5 HP	1 to 15 HP	2 to 15 HP
B2	10 to 25 HP	20 to 60 HP	20 to 60 HP
B3	30 to 100 HP	75 to 200 HP	75 to 150 HP
B4	N/A	250 to 550 HP	N/A

Connection diagrams – Vertical E-Clipse Bypass

ACH550 Vertical E-Clipse Bypass units are configured for wiring access from the bottom only. The following figure shows the Vertical E-Clipse Bypass wiring connection points.

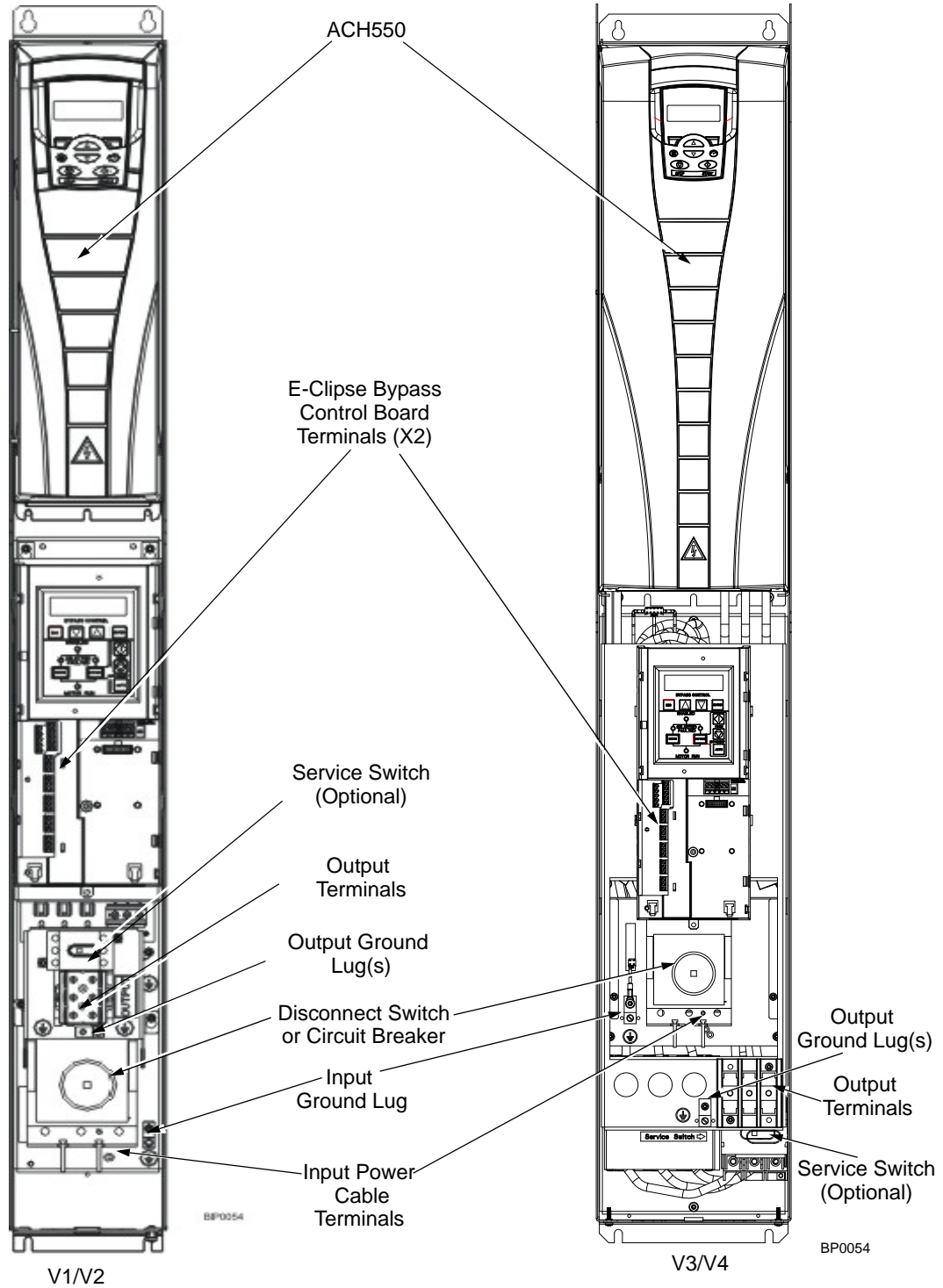

Connection diagrams – Standard E-Clipse Bypass (wall mounted)

ACH550 Standard E-Clipse Bypass units are configured for wiring access from the top. The following figure shows the Standard E-Clipse Bypass (wall mounted) wiring connection points.

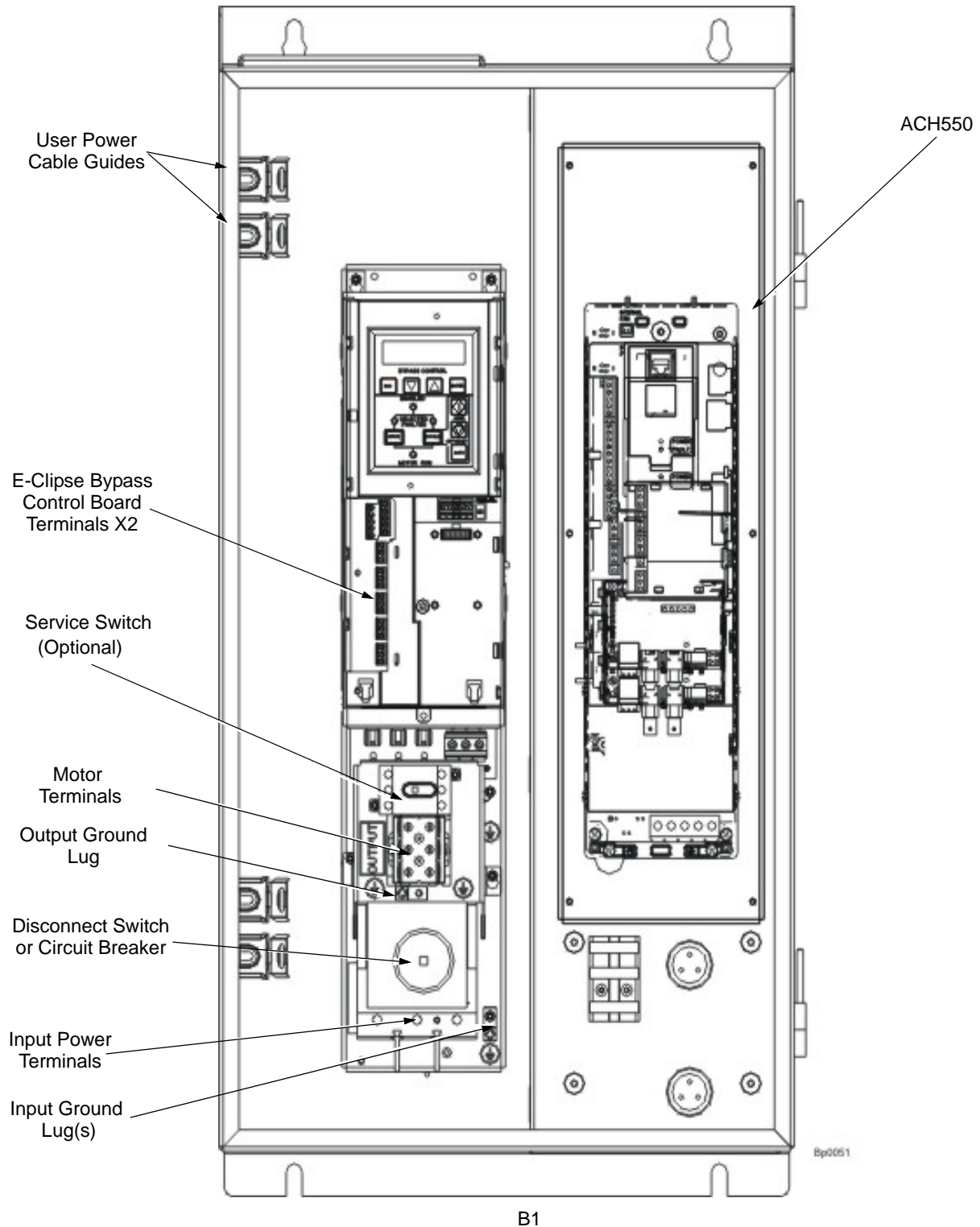

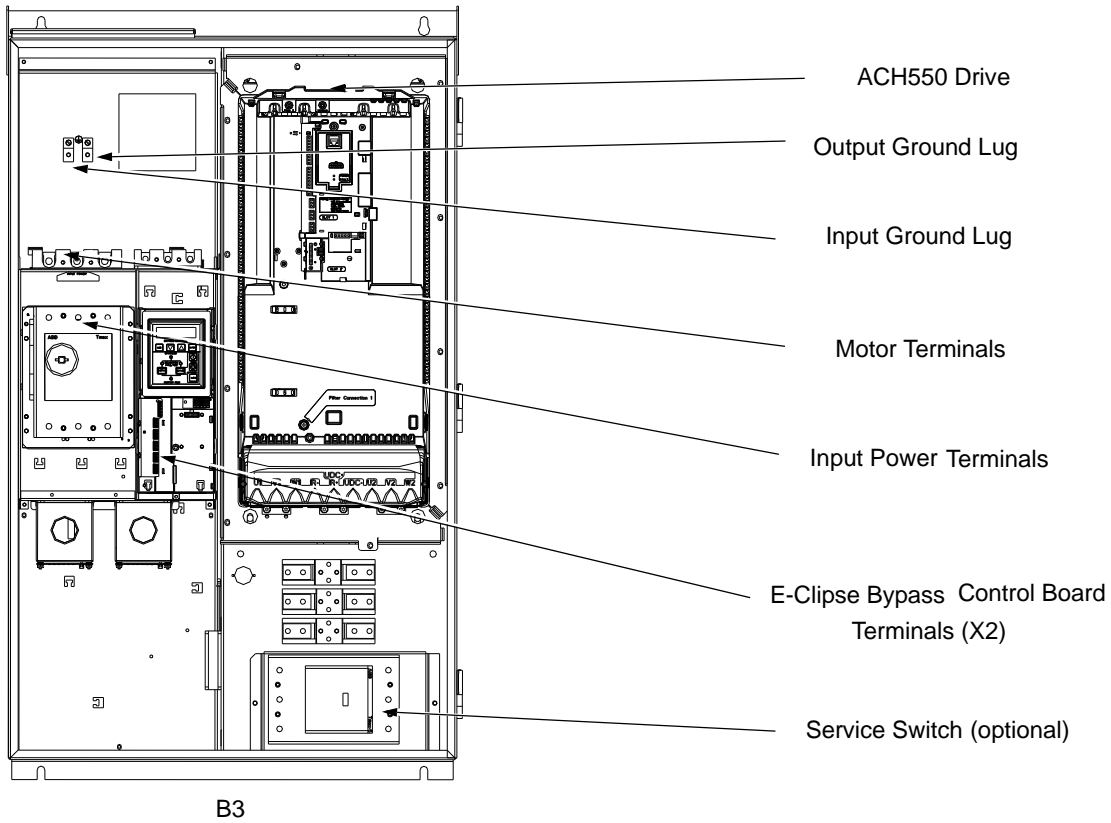
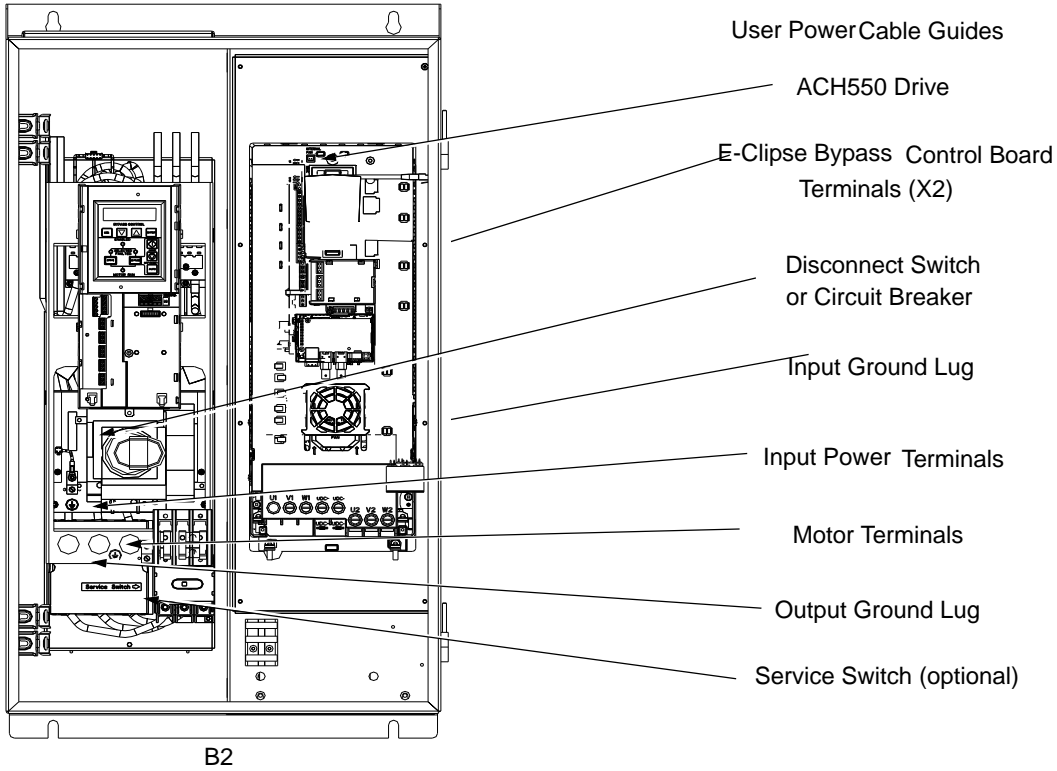

Connection diagrams – Standard E-Clipse Bypass (R8, floor mounted)

ACH550 Standard E-Clipse Bypass units are configured for wiring access from the top. The following figure shows the Standard E-Clipse Bypass (floor mounted) wiring connection points.

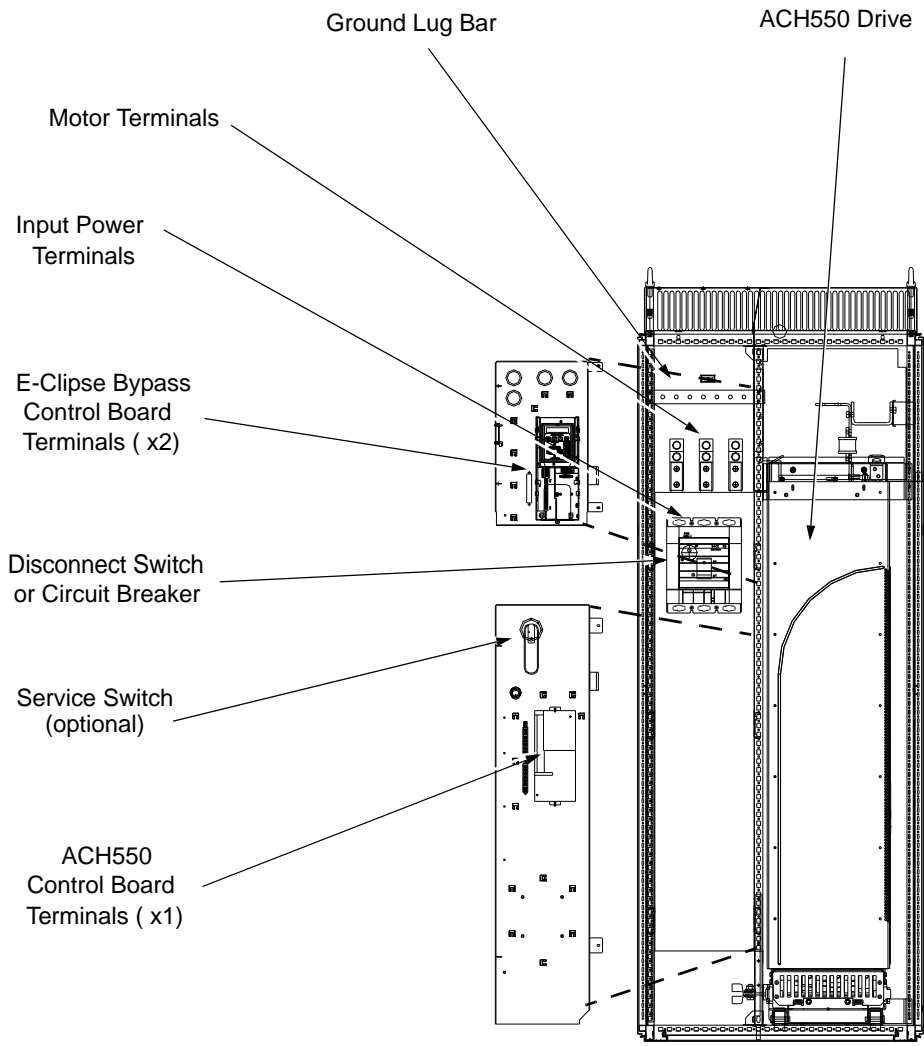

B4

Power connections – Vertical E-Clipse Bypass configurations

Line input connections

Connect the input power to the terminals at the bottom of the disconnect switch or circuit breaker as shown below. Also see [Connection diagrams – Vertical E-Clipse Bypass](#) on page 40. Connect the equipment grounding conductor to the ground lug near the input power connection point.

Motor connections

Connect the motor cables to the terminals at the bottom of the bypass section as shown in the figure. Also see [Connection diagrams – Vertical E-Clipse Bypass](#) on page 43. Connect the motor grounding conductor to the ground lug near the motor cable terminal block connection point.

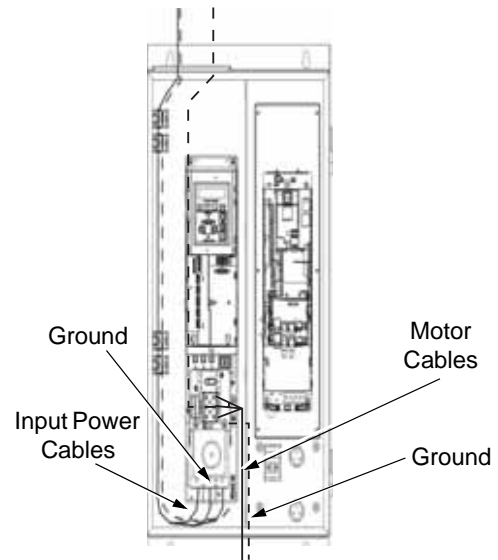

Power connections – Standard E-Clipse Bypass configurations (wall mounted)

Line input connections

Connect input power to the terminals of the disconnect switch or circuit breaker. Connect the equipment grounding conductor to the ground lug at the top of the enclosure. The figure below shows the connection points for Standard E-Clipse Bypass configurations. Also see [Connection diagrams – Standard E-Clipse Bypass \(wall mounted\)](#) on page 41 and [Connection diagrams – Standard E-Clipse Bypass \(R8, floor mounted\)](#) on page 43.

Motor connections

Connect the motor cables to the output terminal block as shown in the figure below. Also see [Connection diagrams – Standard E-Clipse Bypass \(wall mounted\)](#) on page 41 and [Connection diagrams – Standard E-Clipse Bypass \(R8, floor mounted\)](#) on page 43. The motor grounding conductor can be connected to the ground lug near the terminal block.

Note: Route cables through the cable guides on the left side of the enclosure. Use separate conduits for input power and motor cables. Follow the guides to separate the cables from each other.

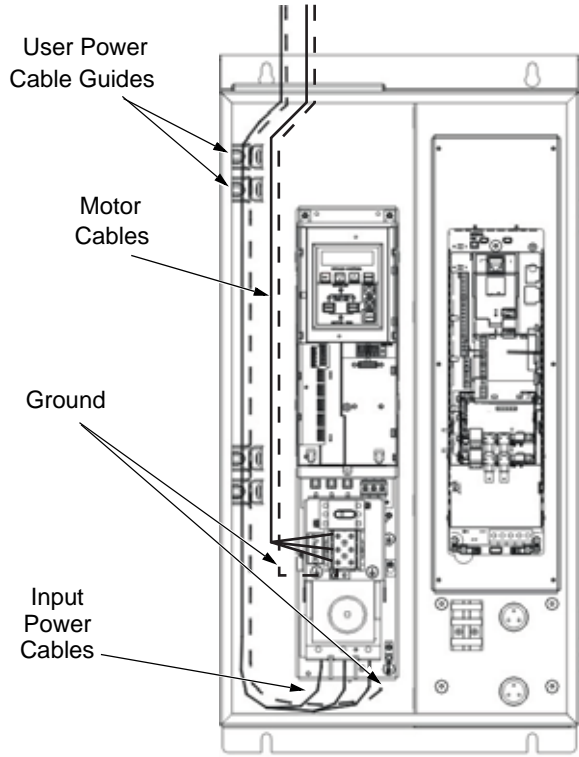

Standard Configuration (B1/B2)

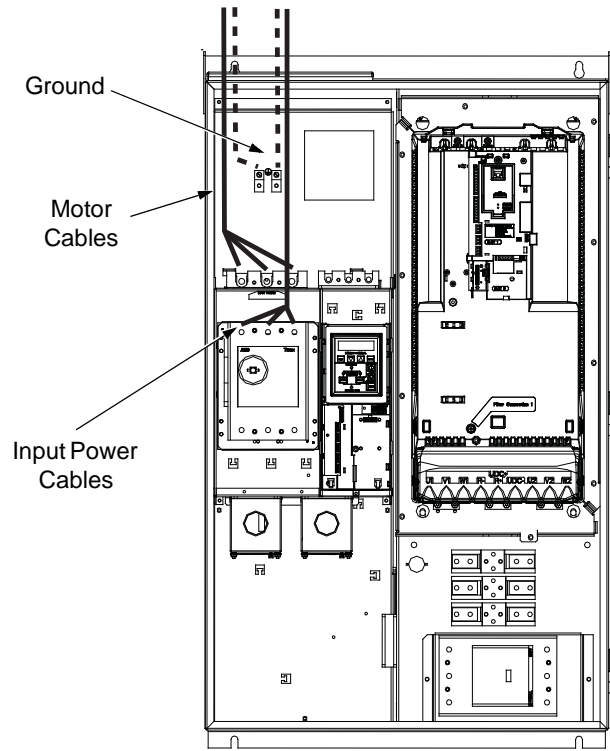

Standard Configuration (B3)

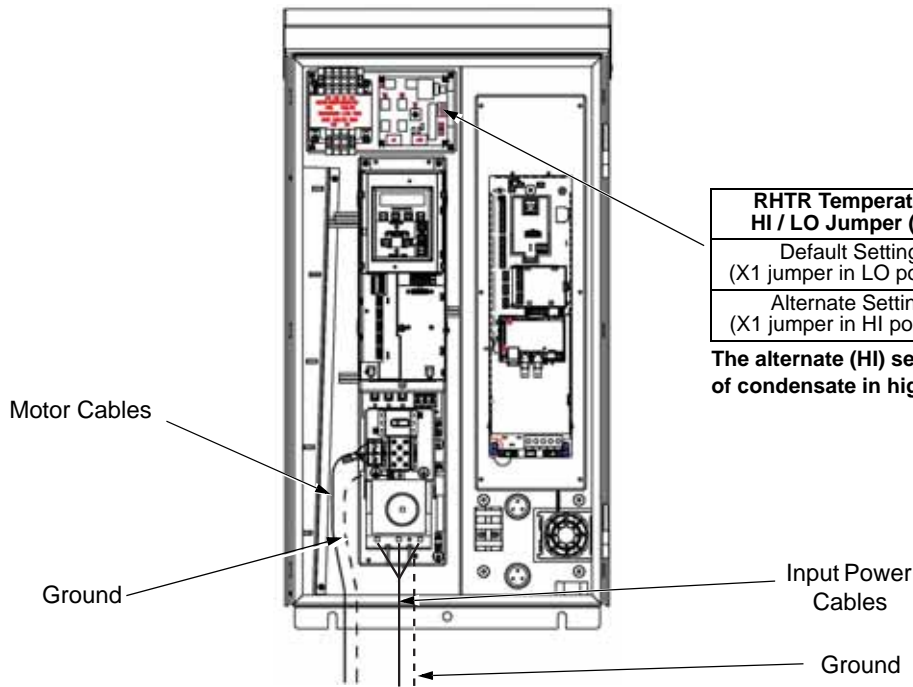

UL Type 3R Configuration (B1/B2)

RHTR Temperature HI / LO Jumper (X1)	Heater ON Temperature	Heater OFF Temperature
Default Setting (X1 jumper in LO position)	14.4 °C 58 °F	21.4 °C 70.5 °F
Alternate Setting (X1 jumper in HI position)	17.8 °C 64 °F	24.7 °C 76.5 °C

The alternate (HI) setting further reduces the likelihood of condensate in high humidity environments.

Note: UL Type 3R, B1/B2 enclosures are designed to be mounted on a wall. Mounting these 3R enclosures on an open rack system requires the use of the supplied 3R enclosure back plates to maintain 3R integrity.



WARNING! Check the motor and motor wiring insulation before connecting the ACH550 to line power. Follow the procedure on page 12. Before proceeding with the insulation resistance measurements, check that the ACH550 is disconnected from incoming line power. Failure to disconnect line power could result in death or serious injury.

Install the control wiring

Connect control wiring to terminal block X1 on the ACH550 control board and to terminal block X2 on the E-Clipse Bypass control board. For more information on these connections, refer to the following:

- X1 terminal block location and terminal data are defined in the *ACH550-UH User's Manual*.
- X2 terminal block location is illustrated in the figures starting with [Connection diagrams – Vertical E-Clipse Bypass](#) on page 40.
- X2 terminal data are provided in [Basic control connections for E-Clipse HVAC Default](#) on page 53.
- Basic connections are described in the following paragraphs. Alternate configurations using the E-Clipse Bypass macro are described in the *ACH550 User's Manual*.
- On Terminal Block X1 inside the ACH550, analog inputs and outputs and additional digital input and relay output connections (AI1, AI2, AO1, AO2, DI1...DI6 and RO1...RO6) are available for use.

Note: The E-Clipse Bypass control circuitry uses serial communications connections (X1:28...X1:32) inside the ACH550. These connections are not available for any other purpose and must not be reconfigured.

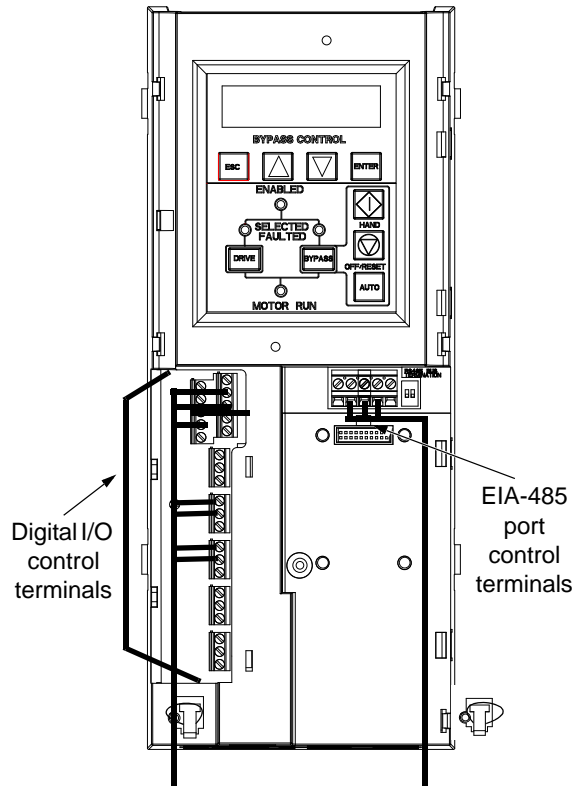

Basic connections

The figure on page 53 shows the basic control connections for use with the E-Clipse Bypass HVAC Default macro. These connections are described in the following paragraphs.

In typical installations, only analog input wires connect to the ACH550 terminal block, with other control connections made on the E-Clipse Bypass control board.

Use wire ties to permanently affix control/communications wiring to the hooked wire race tie points provided, maintaining a minimum 6 mm (1/4") spacing from power wiring.

Drive's power connection terminals

The following tables list power and motor cable terminal sizes for connections to an input circuit breaker or disconnect switch, a motor terminal block and ground lugs. The tables also list torque that should be applied when tightening the terminals.

Vertical enclosure terminals

HP	Identification	Frame Size	Maximum Wire Size Capacities of Power Terminals			
			Circuit Breaker	Disconnect Switch	Motor Termination	Ground Lugs
208...240 Volt						
1	ACH550-VxR-04A6-2	R1	#10 35 in-lbs	#10 7 in-lbs	#6 30 in-lbs	#4 35 in-lbs
1.5	ACH550-VxR-06A6-2	R1				
2	ACH550-VxR-07A5-2	R1				
3	ACH550-VxR-012A-2	R1				
5	ACH550-VxR-017A-2	R1				
7.5	ACH550-VxR-024A-2	R2	#8 40 in-lbs	#8 7 in-lbs	#2 50 in-lbs	#2 50 in-lbs
10	ACH550-VxR-031A-2	R2	#2 50 in-lbs			
15	ACH550-VxR-046A-2	R3		#4 18 in-lbs		
20	ACH550-VxR-059A-2	R3			#2/0 120 in-lbs	
25	ACH550-VxR-075A-2	R4	#1 50 in-lbs	#1 55 in-lbs		
380...480 Volt						
1/1.5	ACH550-VxR-03A3-4	R1	#10 35 in-lbs	#10 7 in-lbs	#6 30 in-lbs	#4 35 in-lbs
2	ACH550-VxR-04A1-4	R1				
3	ACH550-VxR-06A9-4	R1				
5	ACH550-VxR-08A8-4	R1				
7.5	ACH550-VxR-012A-4	R1				
10	ACH550-VxR-015A-4	R2	#8 40 in-lbs	#8 7 in-lbs	#2 50 in-lbs	#2 50 in-lbs
15	ACH550-VxR-023A-4	R2	#3 50 in-lbs			
20	ACH550-VxR-031A-4	R3		#4 18 in-lbs		
25	ACH550-VxR-038A-4	R3			#1 55 in-lbs	
30	ACH550-VxR-045A-4	R3	#1 50 in-lbs	#1 55 in-lbs		#2/0 120 in-lbs
40	ACH550-VxR-059A-4	R4				
50	ACH550-VxR-072A-4	R4			#1 70 in-lbs	
60	ACH550-VxR-078A-4	R4				

HP	Identification	Frame Size	Maximum Wire Size Capacities of Power Terminals			
			Circuit Breaker	Disconnect Switch	Motor Termination	Ground Lugs
500...600 Volt						
2	ACH550-VxR-02A7-6	R2	#8 62 in-lbs	#4 18 in-lbs	#6 30 in-lbs	#4 35 in-lbs
3	ACH550-VxR-03A9-6	R2				
5	ACH550-VxR-06A1-6	R2				
7.5	ACH550-VxR-09A0-6	R2				
10	ACH550-VxR-011A-6	R2				
15	ACH550-VxR-017A-6	R2	#4 62 in-lbs	#1 55 in-lbs	#2/0 120 in-lbs	#2 50 in-lbs
20	ACH550-VxR-022A-6	R3				
25	ACH550-VxR-027A-6	R3				
30	ACH550-VxR-032A-6	R4				
40	ACH550-VxR-041A-6	R4				
50	ACH550-VxR-052A-6	R4	#1 62 in-lbs	#1 70 in-lbs		
60	ACH550-VxR-062A-6	R4				

Standard enclosure terminals

HP	Type Code ¹	Base Drive Frame Size	Power Wiring Data ²							
			Circuit Breaker UL Type/ NEMA 1 & 12	Circuit Breaker UL Type/ NEMA 3R	Disconnect Switch UL Type/ NEMA 1 & 12	Disconnect Switch UL Type/ NEMA 3R	Motor Terminals UL Type/ NEMA 1 & 2	Motor Terminals UL Type/ NEMA 3R	Ground Lugs UL Type/ NEMA 1 & 2	Ground Lugs UL Type/ NEMA 3R
208...240 Volt										
1	ACH550-BxR-04A6-2	R1	#8 40 in-lbs	#8 40 in-lbs	#8 7 in-lbs	#8 7 in-lbs	#6 30 in-lbs	#6 30 in-lbs	#4 35 in-lbs	#4 35 in-lbs
1.5	ACH550-BxR-06A6-2	R1								
2	ACH550-BxR-07A5-2	R1								
3	ACH550-BxR-012A-2	R1								
5	ACH550-BxR-017A-2	R1								
7.5	ACH550-BxR-024A-2	R2	#1 50 in-lbs	#1 50 in-lbs	#4 18 in-lbs	#4 18 in-lbs	#3 50 in-lbs	#3 50 in-lbs	#2 50 in-lbs	#2 50 in-lbs
10	ACH550-BxR-031A-2	R2								
15	ACH550-BxR-046A-2	R3								
20	ACH550-BxR-059A-2	R3								
25	ACH550-BxR-075A-2	R4								
30	ACH550-BxR-088A-2	R4	350 MCM 274 in-lbs	350 MCM 274 in-lbs	#1/0 70 in-lbs	#1/0 70 in-lbs	#1 53 in-lbs	#1 53 in-lbs	2 x #3/0 250 in-lbs	#2/0 375 in-lbs
40	ACH550-BxR-114A-2	R4								
50	ACH550-BxR-143A-2	R6								
60	ACH550-BxR-178A-2	R6								
75	ACH550-BxR-221A-2	R6								
100	ACH550-BxR-248A-2	R6	2 x 500 MCM 274 in-lbs	2 x 500 MCM 274 in-lbs	2 x 500 MCM 274 in-lbs	2 x 500 MCM 274 in-lbs	2 x 500 MCM 375 in-lbs	2 x 500 MCM 375 in-lbs	350 MCM 100 in-lbs	

HP	Type Code ¹	Base Drive Frame Size	Power Wiring Data ²							
			Circuit Breaker UL Type/ NEMA 1 & 12	Circuit Breaker UL Type/ NEMA 3R	Disconnect Switch UL Type/ NEMA 1 & 12	Disconnect Switch UL Type/ NEMA 3R	Motor Terminals UL Type/ NEMA 1 & 2	Motor Terminals UL Type/ NEMA 3R	Ground Lugs UL Type/ NEMA 1 & 2	Ground Lugs UL Type/ NEMA 3R
480 Volt										
1/1.5	ACH550-BxR-03A3-4	R1	#8 40 in-lbs	#8 40 in-lbs	#8 7 in-lbs	#8 7 in-lbs	#6 30 in-lbs	#6 30 in-lbs	#4 35 in-lbs	#4 35 in-lbs
2	ACH550-BxR-04A1-4	R1								
3	ACH550-BxR-06A9-4	R1								
5	ACH550-BxR-08A8-4	R1								
7.5	ACH550-BxR-012A-4	R1								
10	ACH550-BxR-015A-4	R2								
15	ACH550-BxR-023A-4	R2								
20	ACH550-BxR-031A-4	R3	#1 50 in-lbs	#1 50 in-lbs	#4 18 in-lbs	#4 18 in-lbs	#2 50 in-lbs	#2 50 in-lbs	#2 50 in-lbs	#2 50 in-lbs
25	ACH550-BxR-038A-4	R3								
30	ACH550-BxR-045A-4	R3								
40	ACH550-BxR-059A-4	R4								
50	ACH550-BxR-072A-4	R4								
60	ACH550-BxR-078A-4	R4	#1/0 70 in-lbs	#1/0 70 in-lbs	#1/0 70 in-lbs	#1/0 70 in-lbs	#1 53 in-lbs	#1 53 in-lbs	2 x #3/0 250 in-lbs	#2/0 375 in-lbs
75	ACH550-BxR-097A-4	R4								
100	ACH550-BxR-125A-4	R5								
125	ACH550-BxR-157A-4	R6								
150	ACH550-BxR-180A-4	R6	2 x 500 MCM 274 in-lbs	2 x 500 MCM 274 in-lbs	2 x 500 MCM 274 in-lbs	2 x 500 MCM 274 in-lbs	2 x 500 MCM 375 in-lbs	2 x 500 MCM 375 in-lbs	2 x #3/0 250 in-lbs	350 MCM 100 in-lbs
200	ACH550-BxR-246A-4	R6								
250	ACH550-BxR-316A-4	R8								
300	ACH550-BxR-368A-4	R8								
350	ACH550-BxR-414A-4	R8								
400	ACH550-BxR-486A-4	R8	2 x 500 MCM 274 in-lbs	2 x 500 MCM 274 in-lbs	2 x 500 MCM 274 in-lbs	2 x 500 MCM 274 in-lbs	2 x 600 MCM 500 in-lbs	2 x 500 MCM 375 in-lbs	5 Bus bar holes (13/32" bolts)	

HP	Type Code ¹	Base Drive Frame Size	Power Wiring Data ²							
			Circuit Breaker UL Type/ NEMA 1 & 12	Circuit Breaker UL Type/ NEMA 3R	Disconnect Switch UL Type/ NEMA 1 & 12	Disconnect Switch UL Type/ NEMA 3R	Motor Terminals UL Type/ NEMA 1 & 2	Motor Terminals UL Type/ NEMA 3R	Ground Lugs UL Type/ NEMA 1 & 2	Ground Lugs UL Type/ NEMA 3R
600 Volt										
2	ACH550-BxR-02A7-6	R2	#8 62 in-lbs	#8 62 in-lbs	#4 18 in-lbs	#4 18 in-lbs	#6 30 in-lbs	#6 30 in-lbs	#4 35 in-lbs	#4 35 in-lbs
3	ACH550-BxR-03A9-6	R2								
5	ACH550-BxR-06A1-6	R2								
7.5	ACH550-BxR-09A0-6	R2								
10	ACH550-BxR-011A-6	R2								
15	ACH550-BxR-017A-6	R2								
20	ACH550-BxR-022A-6	R3	#1 62 in-lbs	#1 62 in-lbs	#1 55 in-lbs	#1 55 in-lbs	#2 50 in-lbs	#2 50 in-lbs	#2 50 in-lbs	#2 50 in-lbs
25	ACH550-BxR-027A-6	R3								
30	ACH550-BxR-032A-6	R4								
40	ACH550-BxR-041A-6	R4			#1 75 in-lbs	#1 75 in-lbs	#2/0 120 in-lbs	#2/0 120 in-lbs		
50	ACH550-BxR-052A-6	R4								
60	ACH550-BxR-062A-6	R4								
75	ACH550-BxR-077A-6	R6	300 MCM 274 in-lbs	300 MCM 274 in-lbs	#1/0 70 in-lbs	#1/0 70 in-lbs	#1 53 in-lbs	#1 53 in-lbs	3 x #3/0 250 in-lbs	#2/0 375 in-lbs
100	ACH550-BxR-099A-6	R6								
125	ACH550-BxR-125A-6	R6								
150	ACH550-BxR-144A-6	R6								

1. "BxR" represents both BCR and BDR.
2. Torque values shown relate to current production. Check component labels on previously installed units for required tightening torque.

Basic control connections for E-Clipse HVAC Default

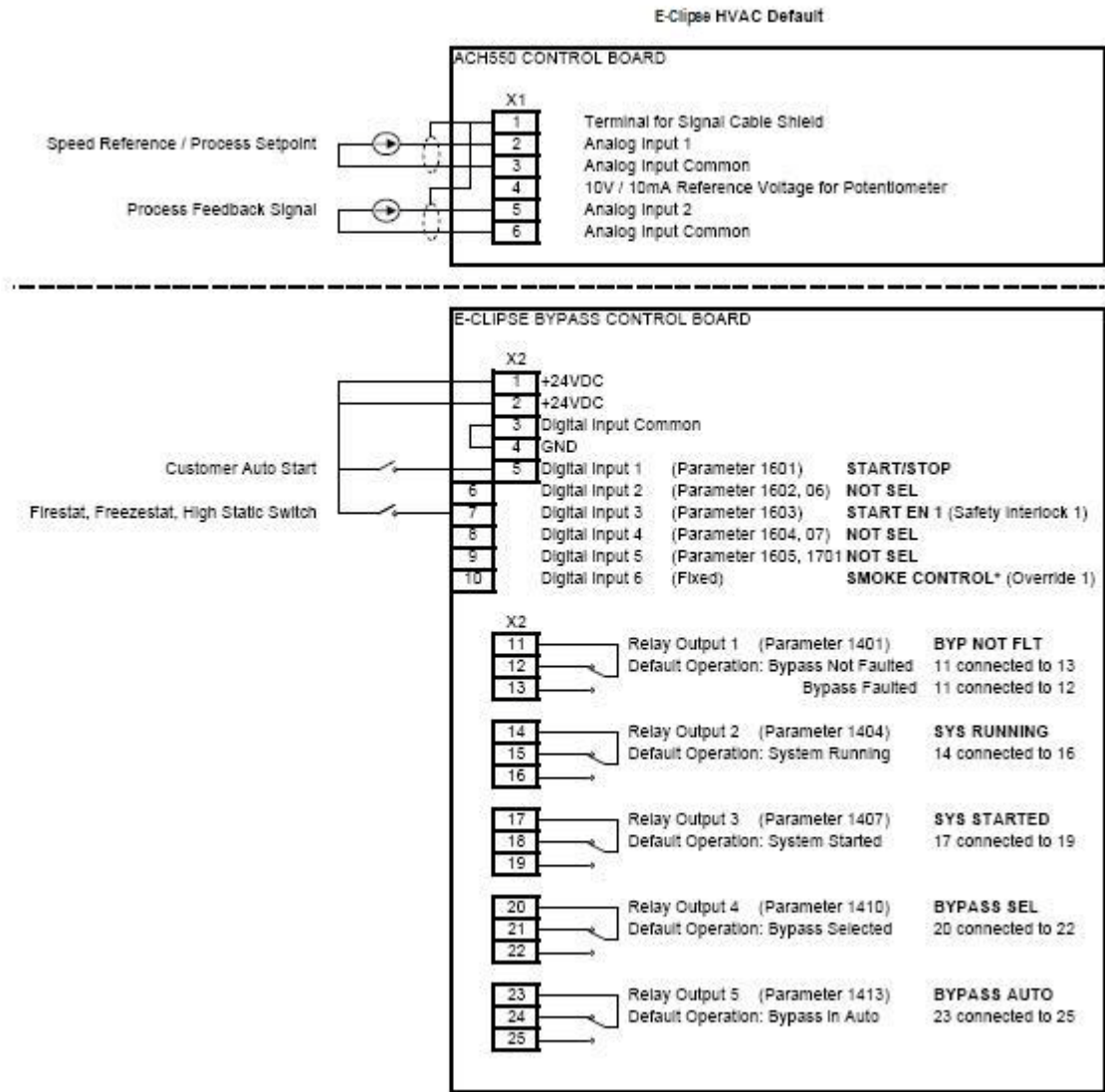

Parameters Changed Relative to E-Clipse HVAC Default

Parameter Number	Description	Setting

* Smoke Control (Override1) is a fixed input. Closing Digital Input 6 will place the E-Clipse Bypass in Smoke Control mode which may reassign the function of the other Digital Inputs. Refer to the Smoke Control (Override1) documentation.

2. Check installation – bypass

Control panel settings and checks

Apply power to the E-Clipse Bypass unit. The ACH550 Control Panel should show the operating status of the drive. If the E-Clipse Bypass Control Panel displays a PHASE SEQ (Phase Sequence) fault, remove power, wait at least 5 minutes and then swap any two input phase wires. If the motor is a standard 208 V, 60 Hz motor connected to a 208 V drive or a 460 V, 60 Hz motor connected to a 480 V drive, the default parameter settings should be suitable for the initial tests described below. If the motor's rating is not 208 V or 460 V, 60 Hz, the MOTOR NOM VOLT and MOTOR NOM FREQ parameters will need to be properly set before proceeding. Refer to the *ACH550-UH User's Manual* and set the parameters as required.

Note: The settings for ALL external serial communication between the ACH550 with E-Clipse Bypass and any Building Automation System are configured using the E-Clipse Bypass operator panel. DO NOT attempt to configure the external serial communication connection using the ACH550 operator panel!

The settings for internal communication between the ACH550 and the E-Clipse Bypass are configured at the factory and require no adjustment.

Drive Link recovery procedure

If the ACH550 Drive communication settings are unintentionally changed during setup a "Drive Link Fault", "Drive Link Error" or "Drive Setup" alarm may be displayed. Should this occur, accomplish the following steps in order.

Using the ACH550 Drive Keypad

1. Set Parameter 9802 to "STD MODBUS"
2. Set Parameter 9902 to "E-CLIPSE"
3. Cycle Power

Following the above steps, in order, should restore proper communications between the ACH550 Drive and the E-Clipse Bypass. Should the E-Clipse Keypad continue to display a "Drive Link Fault", "Drive Link Error" or "Drive Setup" alarm, check the following parameter settings to ensure they have been recovered. If necessary, individually set the correct parameter settings as indicated below and cycle power.

The only ACH550 Drive macro that provides the proper configuration settings by default is the E-Clipse Bypass macro. If any other ACH550 Drive macro is used, that macro should be selected after completing the initial tests. When using any other macro the following ACH550 Drive parameter values must be set and power cycled or the E-Clipse Bypass will not function properly:

- Parameter 9802 must be set to "STD MODBUS"
- Parameter 1001 must be set to "Comm"
- Parameter 1002 must be set to "Comm"
- Parameter 1601 must be set to "Comm"

- Parameter 1608 must be set to “Comm”
- Parameter 5303 must be set to “76.8 kb/s”
- Parameter 5304 must be set to “8 EVEN 1”
- Parameter 5305 must be set to “DCU PROFILE”
- Parameter 5310 must be set to “103”
- Parameter 5311 must be set to “104”
- Power must be cycled

Refer to the *ACH550-UH User’s Manual* for additional information.

Note: Run motor from drive before attempting bypass operation.

System check: motor connected to ACH550 with E-Clipse Bypass

After performing the control panel checks and setting the ACH550 Drive Start-up Data parameters, check the operation of the ACH550 Drive with E-Clipse Bypass with the motor connected as follows:

1. Disconnect and lock out power to the E-Clipse Bypass unit, wait at least five minutes before disconnecting power.
2. Connect the motor to the output terminals.



CAUTION: If the Advanced Override (Override 2) input contact is closed, the motor will start across the line as soon as power is applied.

If the Safety Interlock and Run Enable input contacts are closed and the Smoke Control (Override 1) input contact is closed, the motor will start across the line as soon as power is applied.

If the Start/Stop, Safety Interlock and Run Enable input contacts are closed and the system is in the Bypass mode and in either Hand or Auto, the motor will start across the line as soon as power is applied.

If the Start/Stop, Safety Interlock and Run Enable input contacts are closed and the system is in the Drive mode with the drive in either Hand or Auto mode, the motor will start on the drive as soon as power is applied.

In order to prevent the motor from starting, the system should be in the Drive mode and the drive should be OFF when the power is disconnected at the end of the previous series of control panel settings and checks.

In order to prevent the motor from running without disconnecting the motor, open the Run Enable and Safety Interlock contacts on bypass control board terminals X2:2, X2:3 and X2:4 before applying power. Set the bypass to Drive mode and the drive to OFF.

3. Apply power to the E-Clipse Bypass unit. The ACH550 Control Panel display should be illuminated. On the bypass control panel, both the display and Enabled LED should be illuminated. If the Enabled LED is not illuminated solid green, check to see that closed contacts or jumpers connect terminal X2:3 to X2:4 and X2:2 to X2:7 on the bypass control board.
4. The Drive Selected LED should be illuminated. If not, press the Drive Select key to switch to Drive mode. Leave the system in the Drive mode when proceeding to the next step.
5. Press the Hand key on the ACH550 Control Panel. Press and hold the UP key until the motor just starts rotating.

Note: If the ACH550 Control Panel displays an OVERCURRENT or EARTH FAULT, disconnect and lock out power to the E-Clipse Bypass unit. Wait at least 5 minutes. Disconnect the motor leads from the E-Clipse Bypass unit and Megger each motor lead to ground to determine if the motor is good. Check the power leads from the Drive / Bypass to the motor for damaged or improper wiring. If the ACH550 Control Panel displays any other drive faults, correct the fault condition before proceeding to the next step.



CAUTION: Check motor rotation direction as soon as the motor begins to move. If motor does not rotate in the correct direction, shut down the drive, disconnect and lock out power to the drive and wait five minutes. Swap any two motor output wires (T1, T2, and T3). Incorrect motor rotation direction may cause equipment damage.

6. Increase the speed to 60 Hz or the highest safe operating speed.
7. Press the OFF key on the drive control panel. The motor should stop.

If the drive does not operate according to these steps, refer to the ACH550-UH User's Manual.

If the drive operates according to these steps, your ACH550 with E-Clipse Bypass is ready to use with preset or modified macro settings.

Note: The settings for ALL external serial communication between the ACH550 with E-Clipse Bypass and any Building Automation System are configured using the E-Clipse Bypass operator panel. DO NOT attempt to configure the external serial communication connection using the ACH550 operator panel!

The settings for internal communication between the ACH550 and the E-Clipse Bypass are configured at the factory and require no adjustment.

Note: Both the ACH550 Drive and the E-Clipse Bypass include preset application macros. The only ACH550 Drive macro that provides the proper configuration settings by default is the *E-Clipse HVAC Default macro* (9902 = 15). If any other ACH550 drive macro or any modified setting of the *E-Clipse HVAC Default macro* is used the following ACH550 Drive parameter values must be set and power cycled or the E-Clipse Bypass will not function properly:

- Parameter 9802 must be set to “STD MODBUS”
- Parameter 1001 must be set to “Comm”
- Parameter 1002 must be set to “Comm”
- Parameter 1601 must be set to “Comm”
- Parameter 1608 must be set to “Comm”
- Parameter 5303 must be set to “76.8 kb/s”
- Parameter 5304 must be set to “8 EVEN 1”
- Parameter 5305 must be set to “DCU PROFILE”
- Parameter 5310 must be set to “103”
- Parameter 5311 must be set to “104”
- Power must be cycled

Refer to the *ACH550-UH User’s Manual* for programming instructions.

Note: Run motor from drive before attempting bypass operation.

System check: motor disconnected from the ACH550 with E-Clipse Bypass

If you are familiar with the E-Clipse Bypass operation, you may skip the following section. Otherwise, after performing the system checks and setting the ACH550 Drive Start-up Data parameters, become familiar with the operation of the ACH550 Drive with E-Clipse Bypass without the motor connected as follows:

1. Disconnect and lock out power to the E-Clipse Bypass unit, wait at least five minutes after disconnecting power.
2. Disconnect the motor from the E-Clipse Bypass unit.
3. Apply power to the E-Clipse Bypass unit by turning on the branch circuit disconnect device and the bypass disconnect switch or circuit breaker.
4. The ACH550 Control Panel display should be illuminated. On the E-Clipse Bypass control panel, both the display and *Enabled* LED should be illuminated. If the *Enabled* LED is not illuminated solid green, check to see that closed contacts or jumpers connect terminal X2:3 to X2:4 and X2:2 to X2:7 on the bypass control board.

5. On the E-Clipse Bypass control panel, either the *Drive Selected* or *Bypass Selected* LED should be illuminated. Pressing the *Drive Select* or *Bypass Select* key should switch the bypass back and forth between the *Drive* mode and the *Bypass* mode as indicated by the LEDs above each button. Check that the bypass control panel switches the system between modes. Leave the system in the *Bypass* mode when proceeding to the next step.
6. Check to see that pressing the:
 - *Auto* key on the bypass control panel causes the bottom line on the E-Clipse Bypass display to indicate "*Bypass in Auto*"
 - *Hand* key on the bypass control panel generates a Motor Phase Fault.
 - Under normal conditions (motor connected) pressing the *Hand* key on the bypass control panel causes the bottom line on the E-Clipse Bypass display to indicate "*Hand #A Run*"
 - *OFF* key on the bypass control panel causes the bottom line on the E-Clipse Bypass display to indicate "*Off Stop*"
7. For Steps 8 through 14, ACH550 Drive Parameter 9904 must be set to "Scalar: Freq". After successful completion of Step 13, Parameter 9904 may be set to "Vector: Speed" if very specific application requirements make it necessary to use this type of motor control. Operation using the "Vector: Speed" setting is unnecessary for control of almost all fan and pump applications. Refer to the *ACH550-UH User's Manual* for details on setting parameters.
8. Press the *Drive Select* key on the E-Clipse Bypass control panel. The *Drive Select* LED should be illuminated.
9. Check to see that pressing the:
 - *Auto* key on the bypass control panel causes the E-Clipse Bypass display to indicate "*Bypass in Auto*"
 - *Hand* key on the bypass control panel causes no change to the E-Clipse Bypass display
 - *OFF* key on the bypass control panel causes the E-Clipse Bypass display to indicate "*Bypass in Off*"
10. Press the *HAND* key on the drive control panel. Note that the top line of the control panel display indicates "HAND" and run as a clockwise rotating arrow. The *Drive Run* LED on the E-Clipse Bypass control panel should be illuminated.
11. Press the *UP* arrow on the drive control panel. Note that the speed reference indication in the top line of the drive control panel display increases from "0.0% SP."
12. In the middle line of the drive control panel display, the output current indication should indicate "0.0 A."
13. Press the *DOWN* arrow on the drive control panel until the speed and frequency indications return to "0.0."
14. Press the *OFF* key on the drive control panel. Note that the bottom line of the drive control panel display indicates "Off."

If the ACH550 Drive and E-Clipse Bypass operate according to these steps, and you have familiarized yourself with their operation, disconnect and lock out power to prepare for the next test.



WARNING! Wait at least five minutes after disconnecting power from the drive before you attempt to service the drive. Bus capacitors in the intermediate DC circuit must discharge before servicing the drive. Using a meter rated for 1000 VDC, check for zero volts at:

- Terminals BRK+ to GND and BRK- to GND (frame size R1/R2)
- Terminals UC+ and UC- (frame size R3...R8).

If the drive does not operate according to these steps, refer to the ACH550-UH User's Manual.

3. Check jumpers and switches

The settings described in this section are factory set and, for most situations, do not require adjustment. However, it is a good practice to review these settings to confirm that they are appropriate for the configuration installed.

Jumper and switch locations

The figure below shows the locations of the SW1 DIP switch on the E-Clipse Bypass control board. The function and setting of this switch is explained in the following paragraph.

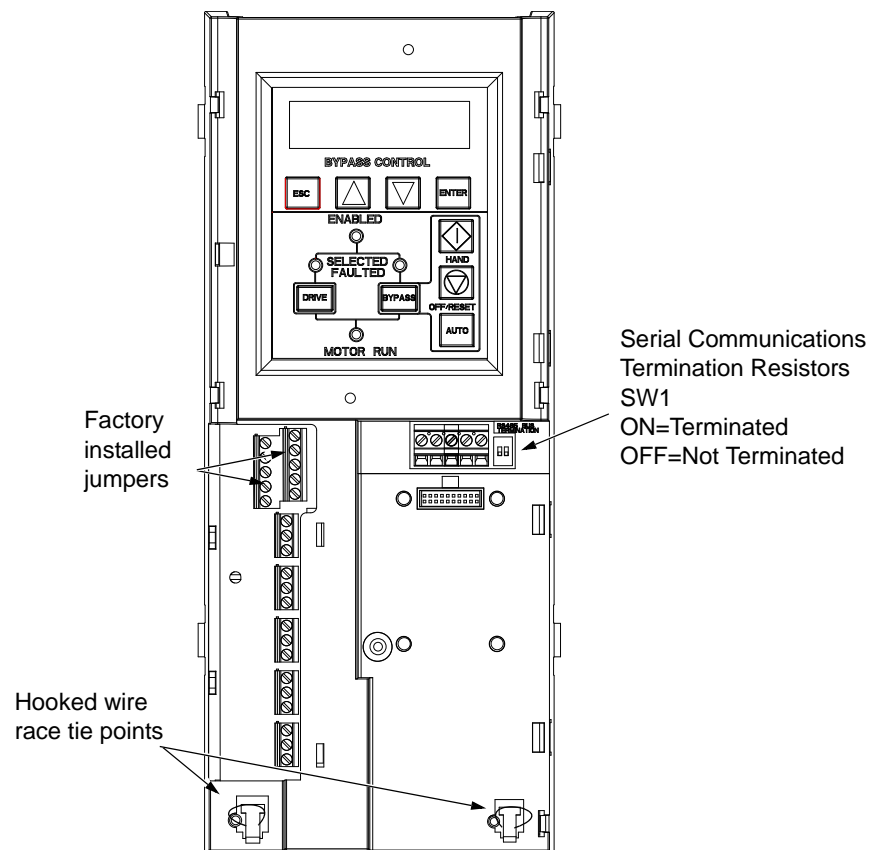

DIP switch settings

The DIP switch is used to configure the serial communications termination resistors.

To reduce noise on the serial communications network, terminate the EIA-485 network using 120 ohm resistors at both ends of the network. Use the DIP switches to connect or disconnect the on-board termination resistors. Both switches must be positioned in the ON or OFF position to correctly configure the termination resistors.

Note: When using embedded protocols, set SW1 in the OFF position.

Circuit breaker settings

On some ACH550 E-Clipse Bypasses, the circuit breaker has adjustable settings for instantaneous current protection. The factory default settings are practical for most applications. Refer to the “ABB SACE Instruction Sheet” (supplied with these units) for additional information on the adjustment of these settings.

Operation

E-Clipse bypass configurations

The ACH550 with E-Clipse Bypass is an ACH550 AC adjustable frequency drive in an integrated UL type 1, UL type 12 or UL type 3R package with a bypass motor starter. The ACH550 with E-Clipse Bypass provides:

- Disconnect switch or circuit breaker with door mounted control lever. The lever can be padlocked in the OFF position (padlock not supplied).
- Bypass starter.
- Motor overload protection.
- Local operator panel with indicating lights and multifunction display.
- Provisions for external control connections.
- Embedded communications for major BMS protocols including BACnet, Johnson Controls International N2, Siemens Building Technologies FLN, and Modbus
- Optional fieldbus adapters for connection to additional BMS protocols including LonWorks and Ethernet
- Optional drive service switch (drive input disconnect), the functional equivalent of a three-contactor bypass arrangement.

The following shows the front view of the ACH550 E-Clipse Bypass vertical configuration, and identifies the major components.

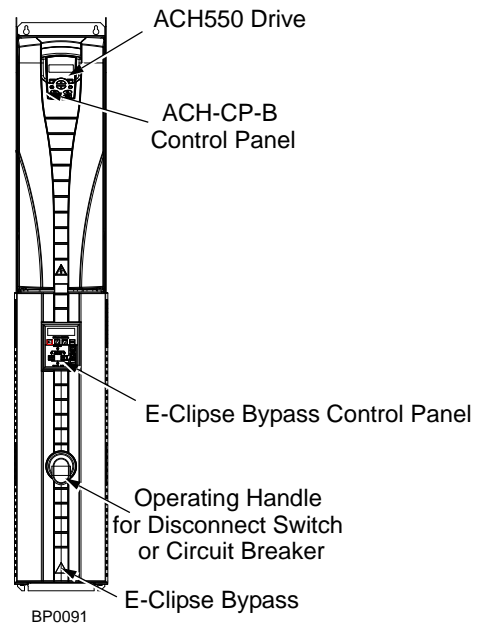

The following shows the front view of the ACH550 E-Clipse Bypass standard configurations, and identifies the major components.

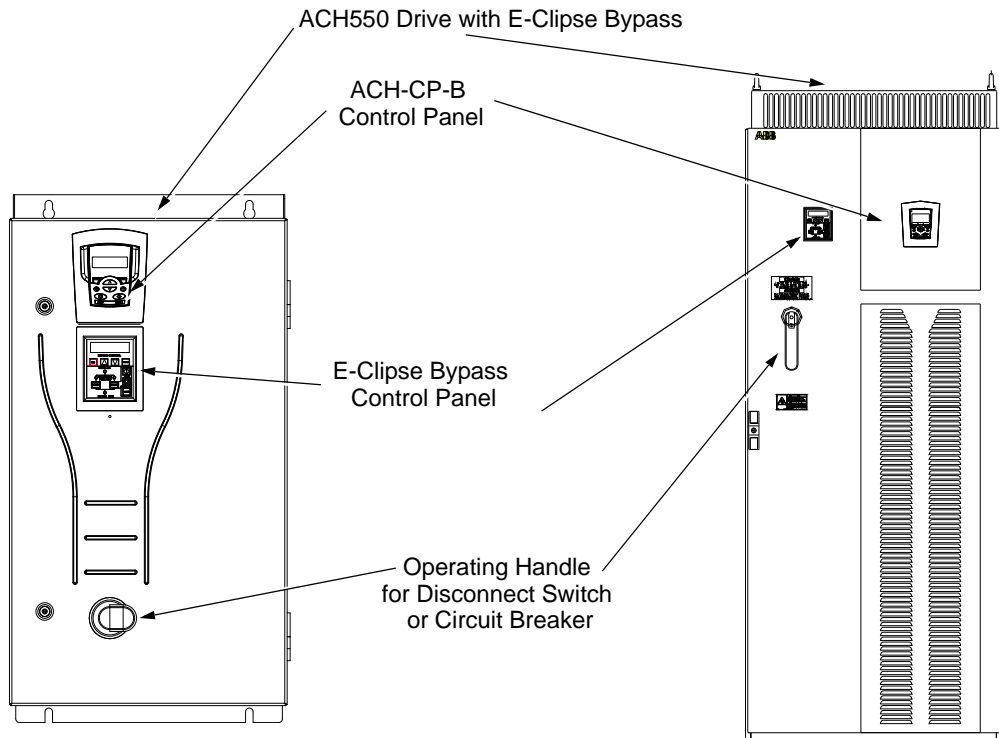

The following is a typical power diagram.

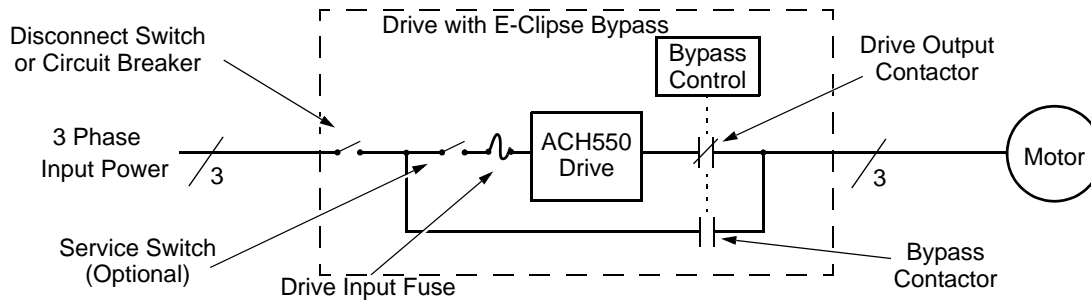

Bypass control

The bypass control panel features:

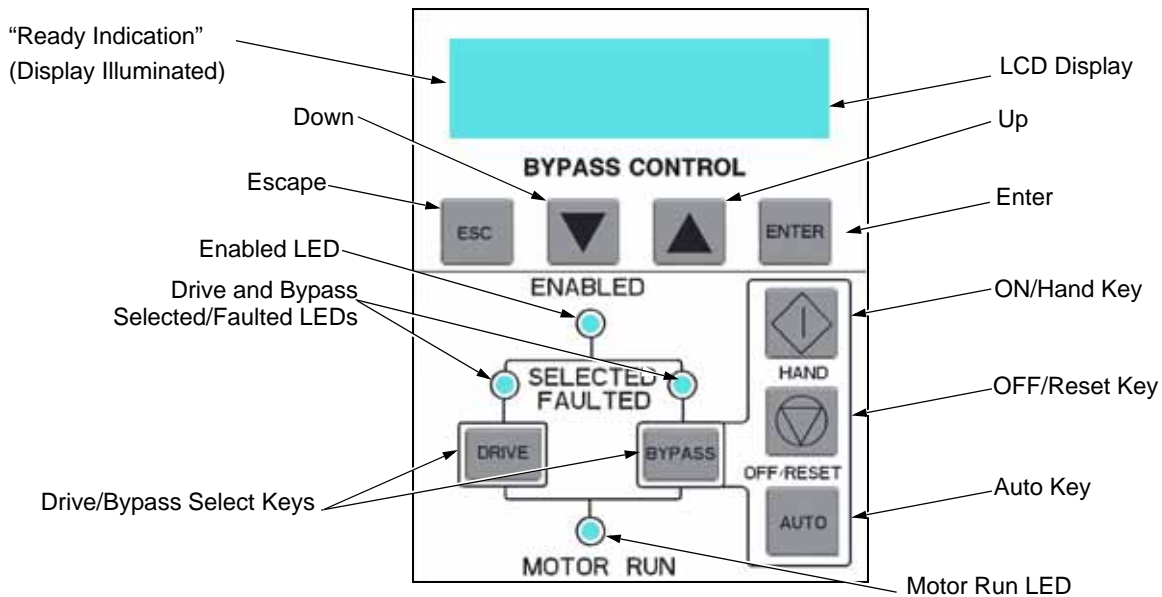

Ready (Power On) Indication

The *Ready (Power On) indication* is provided by the bypass control panel. The bypass control panel display will be illuminated and text will be displayed when the disconnect switch or circuit breaker is closed and control power is applied to the bypass.

Enabled LED

The *Enabled LED* is illuminated green under the following conditions:

- Both the Safety Interlock(s) and Run Enable contacts are closed.
- The Safety Interlock contact(s) are closed with no Start command present.

The Enabled LED flashes green if the Run Enable contact is open and when the Safety Interlock contact(s) are closed and a Start command is present.

The Enabled LED is illuminated red when the Safety Interlock contact(s) are open.

Motor Run LED

The *Motor Run LED* is illuminated green when the motor is running in either bypass mode or in drive mode. The Motor Run LED flashes green to indicate the system has been placed in an Override condition.

Bypass Faulted LED

The *Bypass Faulted LED* is illuminated or flashes red when the motor or bypass protection functions have shut down the bypass. The specific nature of the fault is indicated on the bypass control display. Refer to the [Diagnostics](#) section of this manual for more details.

Drive Selected LED

The *Drive Selected LED* is illuminated green when the drive has been selected as the power source for the motor and no drive fault is present.

Bypass Selected LED

The *Bypass Selected LED* is illuminated or flashes green when the bypass has been selected as the power source for the motor and no bypass fault is present.

Drive Faulted LED

The *Drive Faulted LED* is illuminated red when the bypass has lost its communications link with the drive or when the motor or drive protection functions have shut down the drive. The specific nature of the fault is indicated on the drive control panel display. Refer to the [Diagnostics](#) section on page 66 of the ACH550-UH User's Manual for more details.

Automatic Transfer

The *Automatic Transfer* indication is provided on the bypass control panel. The bypass control display will continuously flash an alarm to indicate the system has automatically transferred to Bypass after a Drive fault. The Bypass Selected LED flashes green when the system has automatically transferred to bypass operation. The bypass event log will also record this event.

Auto Indication

The *Auto Indication* is provided on the bypass control panel default display when the bypass control panel Auto key is pressed. Normally this indicates that the Auto Start contact or serial communications has been selected as the means for starting and stopping the motor in the bypass mode.

Off Indication

The *Off Indication* is provided on the bypass control panel default display when bypass control panel Off key is pressed.

Hand Indication

The *Hand Indication* is provided on the bypass control panel default display when the motor has been started manually in the bypass mode.

Drive Select Key

The *Drive Select Key* selects the drive as the power source for the motor.

Bypass Select Key

The *Bypass Select Key* selects the bypass as the power source for the motor.

Off/Reset Key

The *Off/Reset Key* may be used to manually stop the motor if the motor has been running on bypass power. The Off/Reset key also resets most bypass faults. It may take several minutes before the bypass can be reset after an overload trip. If a bypass fault condition is present the second press of this key places the bypass in the OFF mode.

Auto Key

The *Auto Key* selects the Auto Start contact or serial communications as the means for starting and stopping the motor in the bypass mode.

Hand Key

The *Hand Key* can be used to manually start the motor when the bypass has been selected as the power source for the motor.



Bypass control panel modes







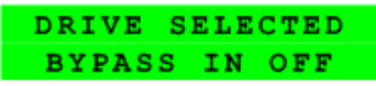

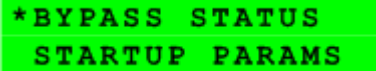

The HVAC Bypass Control Panel has several different modes for configuring, operating and diagnosing the bypass. Select MENU and use the UP/DOWN buttons to select modes. The modes are:

- Default Display mode – Provides (HAND/OFF/AUTO) indication of the bypass operating control mode.
- Bypass Status mode – Provides status indications of the current system operating conditions.
- Start-Up Parameter Mode – Provides a list of parameters or operating conditions that may be configured or viewed during startup.
- Parameter List mode – Used to edit parameter values individually.
- Changed Parameter mode – Displays changed parameters.
- Bypass Fault Display mode – If there is an active bypass fault, the control panel will flash the fault number and fault diagnostic indication in English.
- Bypass Alarm Display mode – If there is an active bypass alarm, the control panel will flash the alarm number and alarm diagnostic indication in English.

Start-up by changing the parameters from the start-up list

















To change the parameters, follow these steps:

1	The Default Display indicates the Bypass Control mode.		
2	Press ENTER to enter the Main Menu .		

3	Select the Startup Params with the Up/Down arrows and press ENTER .	  	BYPASS STATUS *STARTUP PARAMS
4	Select the appropriate Parameter with the Up/Down arrows and press ENTER .	  	*1601 START/STOP 1613 BP DISABLE
5	Press the Up/Down arrows to change the Parameter Value .	 	1601 START/STOP [1:DI1]
6	Press ENTER to store the modified value or press ESC to leave the Parameter Edit mode.	 or 	*1601 START/STOP 1613 BP DISABLE
7	Press ESC to return to the Main Menu , and again to return to the Default Display .		DRIVE SELECTED BYPASS IN OFF

Start-up by changing the parameters individually from the parameter list

To change the parameters, follow these steps:

1	The Default Display indicates the Bypass Control mode.		DRIVE SELECTED BYPASS IN OFF
2	Press ENTER to enter the Main Menu .		*BYPASS STATUS STARTUP PARAMS
3	Select the Parameter List with the Up/Down arrows and press ENTER .	  	STARTUP PARAMS *PARAMETER LIST
4	Select the appropriate Parameter Group with the Up/Down arrows and press ENTER .	  	14 RELAY OUT *16 SYSTEM CTRL
5	Select the appropriate Parameter in a group with the Up/Down arrows and press ENTER .	  	*1601 START/STOP 1602 RUN ENABLE
6	Press the Up/Down arrows to change the Parameter Value .	 	1601 START/STOP [1:DI1]
7	Press ENTER to store the modified value or press ESC to leave the Parameter Edit mode.	 or 	*1601 START/STOP 1602 RUN ENABLE
8	Press ESC to return to the listing of Parameter Groups , and again to return to the Main Menu .	 	*16 SYSTEM CTRL 17 OVERRIDE

9	Press ESC to return to the Default Display from the Main Menu .		
---	--	---	---

Note: In the Parameter Edit mode the current parameter value appears below the parameter name.

Note: To view the default parameter value, press the **Up/Down** arrows simultaneously. Press **Enter** to restore the default parameter value or press **ESC** to leave the **Parameter Edit** mode.

Diagnosics

Fault listing

Fault Code	Fault Name In Panel	Fault	Possible Cause	Corrective Action
3001	COIL CURR FBK	RBCU is sensing abnormal current feedback when neither contactor should be energized	Defective component on RBCU	Change RBCU
3002	BYP CONTACT STUCK	M2 contactor indicates it is not prepared to move on a power up check of the contactor or after contact is commanded to open	Defective Contactor Defective RBCU	Disconnect incoming power from unit Check if contactor armature moves freely. If armature moves freely, then change the RBCU. If armature does not move freely, then change individual contactor (M2) or the complete assembly (RCSA-0x)
3003	DRV CONTACT STUCK	M1 contactor indicates it is not prepared to move on a power up check of the contactor or after contact is commanded to open	Defective Contactor Defective RBCU	Disconnect incoming power from unit Check if contactor armature moves freely. If armature moves freely, then change the RBCU. If armature does not move freely, then change individual contactor (M1) or the complete assembly (RCSA-0x)

Fault Code	Fault Name In Panel	Fault	Possible Cause	Corrective Action
3004	BYPASS COIL OPEN	M2 contactor will not close when commanded to do so	Loose J8 connector on RBCU Loose wires on contactor terminals A1 and/or A2 Bad Output on RBCU Bad Contactor	Verify that J8 connector is firmly seated. With incoming power disconnected, check for tightness of A1 and A2 terminals Swap RBCU Change Contactor/ Assembly
3005	DRIVE COIL OPEN	M1 contactor will not close when commanded to do so	Loose J8 connector on RBCU Loose wires on contactor terminals A1 and/or A2 Bad Output on RBCU Bad Contactor	Verify that J8 connector is firmly seated. With incoming power disconnected, check for tightness of A1 and A2 terminals Swap RBCU Change Contactor/ Assembly
3006	UNDERVOLTAGE	Fault will be generated only if the drive is controlling the motor and the power to the bypass is removed before the drive shuts down. This fault is generated when the drive contactor opens while the drive is operating.	Loose J7 connector on RBCU unit Loose input wiring Incoming power problems	Check that J7 connector is firmly seated in RBCU Check tightness of incoming connections Check Parameter 0413 to view voltage level at time of trip Check upstream protection
3008	DRIVE AI2 LOSS	Only displayed when in Supervisory mode. Indicates that AI2 on the drive has failed.	Check ACH550 manual for AI2 loss	Check ACH550 manual for AI2 loss
3009	MTR OVERLOAD	Bypass opens on motor overload conditions defined in the drive	Drive Mode: Bad Motor Bad CT's Bad RBCU Bypass mode: Bad motor Bad CT's Bad RBCU Either mode: low input voltage	Check if overload condition exists Drive Mode: Refer to 550 manual for proper troubleshooting techniques Bypass Mode: Check that J2 connector is firmly seated in RBCU Use clamp meter to verify mtr current vs. display in parameter 0101 Check input voltage

Fault Code	Fault Name In Panel	Fault	Possible Cause	Corrective Action
3010	INP PHASE A LOSS	Fault will be generated when the bypass contactor is requested to be closed and the RBCU does not sense voltage on Phase A	Loose J7 connector Loose wiring on Contactor assembly. Blown upstream fuse	Check J7 connector Check yellow wire on input block Check incoming voltage, phase to ground
3011	INP PHASE B LOSS	Fault will be generated when the bypass contactor is requested to be closed and the RBCU does not sense voltage on Phase B	Loose J7 connector Loose wiring on Contactor assembly. Blown upstream fuse	Check J7 connector Check black wire on input block Check incoming voltage, phase to ground
3012	INP PHASE C LOSS	Fault will be generated when the bypass contactor is requested to be closed and the RBCU does not sense voltage on Phase C	Loose J7 connector Loose wiring on Contactor assembly. Blown upstream fuse	Check J7 connector Check red on input block Check incoming voltage, phase to ground
3013	DRIVE 1ST START	Fault generated if attempting to close the bypass contactor with out running the bypass in drive mode first.	NA	Run bypass unit in drive mode before attempting bypass mode
3014	COIL POW SUPPLY	Coil power supply has failed to reach rated voltage	Internal failure on RBCU unit Shorted contactor coil	Cycle power on bypass unit. If contactor coil is shorted, fault 3023 or 3024 will be generated. If 3023 or 3024 is generated, replace respective contactor If 3023 or 3024 is not generated on power up, replace RBCU unit.
3016	EARTH FAULT	Declared if attempting to close the bypass contactor when the drive has earth fault declared	Earth fault in motor	Refer to the fault code 16 on page 25 .
3017	MTR UNDERLOAD	If motor power(%) level falls below minimum power level establish in parameter 3003 for the time (s) set in parameter 3002 fault will be generated. Parameter 3003 is a percentage of motor power as defined in the drive via parameter 9909. Fault only applies to bypass mode	Broken belt	Check load Reset bypass keypad Check fault code 17 on page 25 , for further action

Fault Code	Fault Name In Panel	Fault	Possible Cause	Corrective Action
3018	MAX CYCLE FAULT	Supervisory Mode only. Declared if bypass contactor is closed by supervisory control 16 times within a 1 hour period.	High and low levels of hysteresis band are too tight	Check parameters 3202-3205. Increase time delays on parameters 3204 and 3205
3019	DRIVE LINK FAULT	Supervisory Mode Only. Fault generated if RS-485 link between drive and bypass stops communicating.	Bad cable/connection between drive and bypass. Communication improperly set in drive Parameter 9802. Application Macro improperly set in drive parameter 9902.	Proper seating of cable in drive and RBCU(connector J3) Check drive parameter 9802 (Modbus) and 9902 (E-Clipse) Check drive Group 53 Follow DriveLink recovery procedure
3020	PHASE SEQ	Sequence of 3 phase voltage input is such that bypass operation will result in motor rotation opposite of drive forward operation.	Phase sequence unknown at time of wiring	Swap any two of the three input wires to the bypass unit
3021	PH A CURR FBK	Fault is generated when current in Phase A is detected and the bypass contactor is open	Loose CT connection Bad RBCU Bad CT	Check J2 connector for proper seating Check connector on Current Assembly Replace RBCU Replace RCSA unit
3022	PH C CURR FBK	Fault is generated when current in Phase C is detected and the bypass contactor is open	Loose CT connection Bad RBCU Bad CT	Check J2 connector for proper seating Check connector on Current Assembly Replace RBCU Replace RCSA unit
3023	BYP COIL SHORTED	Coil characteristics are checked only on power up and coil current is greater than allowable values	Shorted contactor coil Shorted/damaged cable Bad RBCU	Replace RBCU Replace RCSA unit
3024	DRV COIL SHORTED	Coil characteristics are checked only on power up and coil current is greater than allowable values	Shorted contactor coil Shorted/damaged cable Bad RBCU	Replace RBCU Replace RCSA unit
3027	INVALID SUB ASM	Contactor assembly as recorded in the RBCU unit does not match drive information communicated via 485 link	RBCU unit from a different size bypass used to replace a defective RBCU. Parameters not matched after Firmware change.	Contact ABB at 1-800-HELP-365 Option 4

Fault Code	Fault Name In Panel	Fault	Possible Cause	Corrective Action
3028	EXT COMM LOSS	Time between fieldbus messages has exceeded timeout interval set with parameter 3005	Incorrect Communication settings in Group 51 & 53. Poor Connections Noise on Communication Line	Check Group 51 & 53 Tighten Connections Check Communication Cable Grounding
3029	EFB CONFIG FILE	Error reading configuration file for embedded fieldbus	Internal Startup error	Cycle Power Replace RBCU
3030	FORCE TRIP	Fault trip forced by external fieldbus	Overriding Control System tripped E-Clipse unit via fieldbus.	Check Overriding Control System
3031 ... 3033	EFB 1...EFB 3	Fault code reserved for embedded fieldbus.	For Bacnet: Device object instances for the drive and or bypass are set greater than 4194302 in paramters 5011 5017 and or 5311 5317 respectively	Check Parameters 5011, 5017 and/or 5311, 5317
3034	MTR PHASE	Detects open motor phase. Detection is done by current transformers in bypass unit.	Internal problem Cable problem Motor problem	Check wiring in E-Clipse Unit Check motor cabling Check Motor Check if 3006 is Disabled
3037	PCB TEMP	RBCU unit has reached 190 degrees Fahrenheit, 88 degrees Celsius	Cabinet cooling has failed Ambient conditions too high Bad RBCU unit	Stop drive and let cool down and restart Add additional cooling Replace RBCU
3038	NO DRIVE DATA	No drive data available (Group 112)	Bypass not able to extract drive data on initial power up due to: Bad cable/connection between drive and bypass. Communication improperly set in drive Parameter 9802. Application Macro improperly set in drive parameter 9902.	Proper seating of cable in drive and RBCU (connector J3) Check drive parameter 9802 (Modbus) and 9902 (E-Clipse) Check drive Group 53 Follow DriveLink recovery procedure then cycle power to bypass.
3039	FBA PAR CONF	Non embedded fieldbus has detected an error in Group 51 parameters	Incorrect settings in Group 51	Verify Group 51 parameters
3101	SFLASH CORRUPT	Internal checksum error	NA	Cycle power Replace RBCU Upgrade firmware

Fault Code	Fault Name In Panel	Fault	Possible Cause	Corrective Action
3102	PMP FILE	Parameter file is corrupt		Cycle Power Contact ABB with information that preceded fault
3201	T1 OVERLOAD	T1 program cycle is overloaded	NA	Contact ABB with information that preceded fault Cycle Power Replace RBCU
3202	T2 OVERLOAD	T2 program cycle is overloaded	NA	Contact ABB with information that preceded fault Cycle Power Replace RBCU
3203	T3 OVERLOAD	T3 program cycle is overloaded	NA	Contact ABB with information that preceded fault Cycle Power Replace RBCU
3204	STACK OVERFLOW	Program cycle is overloaded	NA	Contact ABB with information that preceded fault Cycle Power Replace RBCU
3205	UNKNOWN CB	Bypass control board type is unknown.	Firmware is not compatible with control board in RBCU.	Firmware 93F and greater compatible with all RCBU hardware. Firmware 93D and earlier can only be loaded in RBCU Rev D and earlier.
3206	UNKNOWN DRIVE	Drive reports rating not found in bypass software	Drive does not match drives configured in bypass RBCU	Replace RBCU or reload with most current firmware
3207	UNKNOWN BYPASS	NA	NA	Replace RBCU or load most current firmware Contact ABB at 1-800-HELP-365 option 4 Replace RBCU or load most current firmware

Fault History

See page [28](#).

Alarm listing

The following table lists the alarms by code number and describes each.

Alarm Code	Alarm Name In Panel	Alarm	Possible Cause	Corrective Action
4001	INP PHASE A LOSS	Alarm will occur in drive mode. In bypass, alarm will occur if bypass contactor has not closed. Unit will trip on Fault 3010 if the bypass contactor is closed	Loose J8 connector Loose wiring on Contactor assembly. Blown upstream fuse	Check J8 connector Check yellow wire on input block Check incoming voltage, phase to ground
4002	INP PHASE B LOSS	Alarm will occur in drive mode. In bypass, alarm will occur if bypass contactor has not closed. Unit will trip on Fault 3011 if the bypass contactor is closed	Loose J8 connector Loose wiring on Contactor assembly. Blown upstream fuse	Check J8 connector Check black wire on input block Check incoming voltage, phase to ground
4003	INP PHASE C LOSS	Alarm will occur in drive mode. In bypass, alarm will occur if bypass contactor has not closed. Unit will trip on Fault 3012 if the bypass contactor is closed	Loose J8 connector Loose wiring on Contactor assembly. Blown upstream fuse	Check J8 connector Check red wire on input block Check incoming voltage, phase to ground
4004	AUTO TRANSFER	Message is displayed when the drive faults and the bypass switches to bypass mode as configured in Parameter 1608	Drive fault	Check drive
4005	EXT COMM ERR	Time between fieldbus messages has exceeded timeout interval set with parameter 3005	Incorrect Communication settings in Group 51 & 53. Poor Connections Noise on Communication Line	Check Group 51 & 53 Tighten Connections Check Communication Cable Grounding
4006	Selected by PAR 1620: RUN ENABLE DAMPER END SWITCH VALVE OPENING PRE-LUBE CYCLE	Alarm will occur when start order is given and the "RUN Enable" is not present	Run Enable condition is not satisfied. Bad 24v supply Bad digital input	Check 24 Volts on RBCU unit Check for 24 volts on respective DI when condition is satisfied Check Parameter 0103 for status of digital input
4007	PCB TEMP	RBCU unit reached 181 degrees Fahrenheit, 83 degrees Celsius	Cabinet cooling has failed Ambient conditions too high Bad RBCU unit	Stop drive and let cool down and restart Add additional cooling Replace RBCU

Alarm Code	Alarm Name In Panel	Alarm	Possible Cause	Corrective Action
4008	DRIVE SETUP	Alarm generated when configuration of drive is such that bypass can not properly control the drive. Specifically, drive parameters 1001,1002,1601, 1608	Incorrect parameters settings	Set Parameter 1001 to "COMM" Set Parameter 1002 to "COMM" Set Parameter 1601 to "COMM" Set Parameter 1608 to "COMM"
4009	BYPASS RUN DELAY	Alarm is generated when a bypass start command is issued and there is non zero time value in bypass parameter 1614	NA	NA
4010	MTR OVERLOAD	Bypass warning if motor overload conditions exist as defined in the drive	Drive Mode: Bad Motor Bad Ct's Bad RBCU Bypass mode: Bad motor Bad CT's Bad RBCU Either mode: low input voltage	Drive Mode: Refer to 550 manual for proper troubleshooting techniques Bypass Mode: Check that J2 connector is firmly seated in RBCU Check input voltage Does overload condition exist?
4011	MTR UNDERLOAD	Alarm comes at half the time of a mtr underload fault. See fault 3017 for further text	NA	Parameter 3002 is the time Parameter 3003 is the level
4012	BYPASS DISABLED	Alarm will be generated if parameter 1613 is set to "Disable"	NA	NA
4013	DRIVE LINK ERROR	Same as Fault 3019 however will occur when not in supervisory mode	Bad cable between drive and bypass Communication improperly set in drive Parameter 98.02(Modbus) Application Macro in 99.02 set to 15 (text)	Proper seating of cable in drive and RBCU(connector J3) Check drive parameter 98.02 and 99.02 Check drive Group 53 Follow DriveLink recovery procedure
4014	DRIVE TEST	Alarm is generated when bypass parameter 1617 is set to "enable"	NA	NA
4015	START DRIVE 1ST	Message displayed on initial "out of box" power up sequence	NA	Run drive in Hand

Alarm Code	Alarm Name In Panel	Alarm	Possible Cause	Corrective Action
4016	INP VOLTAGE LOW	3-Phase input voltage has not reached a sufficient level to enable editing of parameters via the keypad. This message is generated within a few seconds of power up	NA	Loose J7 connector Low input voltage. Incoming voltage has not reached at least 155 VAC within a few seconds of powerup
4019	OVERRIDE 1	Alarm is generated when override 1 is active	NA	Check Parameter 0103 and 0104 for digital input status
4020	OVRD2 BYP	Alarm is generated when override 2 is active and the bypass is controlling the motor	NA	Check Parameter 0103 and 0104 for digital input status
4021	Selected by PAR 1621 START ENABLE 1 VIBRATION SWITCH FIRESTAT FREEZESTAT OVERPRESSURE VIBRATION TRIP SMOKE ALARM SAFETY OPEN LOW SUCTION PRES	Alarm will occur when start order is given and the "RUN Enable" is not present	Run Enable condition is not satisfied. Bad 24v supply Bad digital input 24 V common is not tied to Digital input common on bypass when using external 24 v supply	Check 24 Volts on RBCU unit Check for 24 volts on respective DI when condition is satisfied Check Parameter 0103 For status of digital input
4022	Selected by PAR 1622 START ENABLE 2 VIBRATION SWITCH ... LOW SUCTION PRES	Alarm will occur when start order is given and the "RUN Enable" is not present	Run Enable condition is not satisfied. Bad 24v supply Bad digital input 24 V common is not tied to Digital input common on bypass when using external 24 v supply	Check 24 Volts on RBCU unit Check for 24 volts on respective DI when condition is satisfied Check Parameter 0103 For status of digital input
4023	Selected by PAR 1623 START ENABLE 3 VIBRATION SWITCH ... LOW SUCTION PRES	Alarm will occur when start order is given and the "RUN Enable" is not present	Run Enable condition is not satisfied. Bad 24v supply Bad digital input 24 V common is not tied to Digital input common on bypass when using external 24 v supply	Check 24 Volts on RBCU unit Check for 24 volts on respective DI when condition is satisfied Check Parameter 0103 For status of digital input

Alarm Code	Alarm Name In Panel	Alarm	Possible Cause	Corrective Action
4024	Selected by PAR 1624 START ENABLE 4 VIBRATION SWITCH ... LOW SUCTION PRES	Alarm will occur when start order is given and the "RUN Enable" is not present	Run Enable condition is not satisfied. Bad 24v supply Bad digital input 24 V common is not tied to Digital input common on bypass when using external 24 v supply	Check 24 Volts on RBCU unit Check for 24 volts on respective DI when condition is satisfied Check Parameter 0103 For status of digital input
4025	LOCAL DISABLED	Alarm is displayed if MODE LOCK (16.29) is set to AUTO MODE and the Hand or Off key is pressed		
4026	AUTO DISABLED	This alarm is displayed if MODE LOCK (1629) is set to LOCAL MODE and the Auto key is pressed.		
4027	COMM CONFIG ERR	Alarm is displayed if the drive and bypass MAC addresses are equal or invalid.	E-Clipse parameters 5002(BP MAC ID) & 5302 (DV MAC ID) are set to the same value	Change MAC address to unique values
4028	FBA PAR CONF	Non embedded fieldbus has detected an error in Group 51 parameters		Verify Group 51 parameters
4029	DRIVE FAULTED	The drive is faulted.		Reset drive
4030	OVRD2 VFD	Alarm is generated when override 2 is active and the drive is controlling the motor	NA	Check Parameter 0103 and 0104 for digital input status
4031	OVRD2 STOP	Alarm is generated when override 2 is active and both the bypass and drive output contactors are deenergized	NA	Check Parameter 0103 and 0104 for digital input status

Bypass status listing

Bypass Status (16 Characters)	Condition	Description
DRIVE/BYPASS?	DRIVE SELECTED BYPASS SELECTED	Displays which one is selected, drive or bypass
SAFETIES?	OPEN CLOSED	Displays if safeties (=START ENABLE 1 and/or START ENABLE 2) have been applied, or if they are missing
RUN PERMISSIVES?	OPEN CLOSED	Displays if RUN ENABLE is present or not
START REQUEST?	NOT PRESENT PRESENT	Displays if start request has been applied to the system
AUTO TRANSFER?	NOT TRANSFERRED TRANSFERRED	Displays if the system is in Auto Transfer state or not. Does not reflect to PAR 16.08 AUTO XFER value itself
BYP OVERRIDE 1?	NOT ACTIVATED ACTIVATED	Status of Override 1
BYP OVERRIDE 2?	NOT ACTIVATED ACTIVATED	Status of Override 2
DRIVE FAULTED?	NO YES	Displays if drive is faulted or not
BYPASS FAULTED?	NO YES	Displays if bypass is faulted or not
SYSTEM STARTED?	NO YES	Displays if system is started or not
SYSTEM RUNNING?	NO YES	Displays if system is running or not
BYPASS ALARMS?	NO ALARMS ALARM ACTIVE	Displays if there is an active alarm(s) in bypass or not
HAND/OFF/AUTO?	OFF MODE HAND MODE AUTO MODE	Displays operating mode of the bypass - OFF, HAND or AUTO

Error messages

#	Error Message	Description
1	CAN'T EDIT PAR IS READ ONLY	Try to save value (=press the ENTER key in Parameter Edit State) of a read-only parameter. E.g. try to change value PAR 01.02 INPUT VOLT
2	CAN'T EDIT WHEN STARTED	Try to change value of a parameter, which is allowed to be changed only when system is not started. E.g. PAR 16.02 RUN ENABLE
3	CAN'T EDIT UP+DOWN ONLY	Try to change value of a "reset only" parameter other than zero. UP+DOWN buttons must be pressed simultaneously for requesting default value of the PAR on the display (value zero), and after that ENTER pressed for saving it (reset the parameter). E.g. PAR 04.01 LAST FAULT
4	CAN'T EDIT INP VOLTAGE LOW	Input voltage too low. Changing of parameters prohibited since system cannot save values to nv-mem w/ insufficient voltage.
5	CAN'T EDIT PAR IS HIDDEN	Try to save value (=press the ENTER key in Parameter Edit State) of a hidden parameter. Should not be possible. If hidden parameters are turned visible, this message is not given.
6	CAN'T EDIT UNDER LO-LIMIT	Try to save value which is over LO-LIMIT of the parameter. Should not be possible when changing parameters from control panel.
7	CAN'T EDIT UNDER HI-LIMIT	Try to save value which is over HI-LIMIT of the parameter. Should not be possible when changing parameters from control panel.
8	CAN'T EDIT ENUM VAL ONLY	Try to save value which is out of enumerated value list. Should not be possible when changing parameters from control panel.
9	CAN'T EDIT NO DEFAULT	Try to request default value (=press UP and DOWN buttons simultaneously) for a parameter which is defined not to have a default value. Should not be possible when changing parameters from control panel.
10	CAN'T EDIT TRY AGAIN.	Parameter system is busy, e.g. application macro change is in process at the same time when someone is trying to save a value for a parameter. Should not be possible when changing parameters from control panel.

Maintenance

See [Maintenance](#) for the ACH550-UH on page 31.

ACH550-PCR/PDR

Installation

This information is unique to ACH550 input disconnect configurations (PCR or PDR). The ACH550 with Input Disconnect is an ACH550 AC adjustable frequency drive packaged with an input disconnect switch or circuit breaker. Refer to the [Installation](#) instructions on page 3, for all other information. **Failure to observe the warnings and instructions may cause a malfunction or personal hazard.**



WARNING! Before you begin read [Safety](#) on page 2.



WARNING! When the ACH550 with Input Disconnect is connected to the line power, the Motor Terminals T1, T2, and T3 are live even if the motor is not running. Do not make any connections when the ACH550 with Input Disconnect is connected to the line. Disconnect and lock out power to the drive before servicing the drive. Failure to disconnect power may cause serious injury or death.

1. Install wiring



WARNING!

- Metal shavings or debris in the enclosure can damage electrical equipment and create a hazardous condition. Where parts, such as conduit plates require cutting or drilling, first remove the part. If that is not practical, cover nearby electrical components to protect them from all shavings or debris.
 - Do not connect or disconnect input or output power wiring, or control wires, when power is applied.
 - Never connect line voltage to drive output Terminals T1, T2, and T3.
 - Do not make any voltage tolerance tests (Hi Pot or Megger) on any part of the unit. Disconnect motor wires before taking any measurements in the motor or motor wires.
 - Make sure that power factor correction capacitors are not connected between the drive and the motor.
-

Connection diagrams – standard drive with input disconnect (wall mounted)

The following figure shows the Standard Drive with Input Disconnect (wall mounted) wiring connection points.

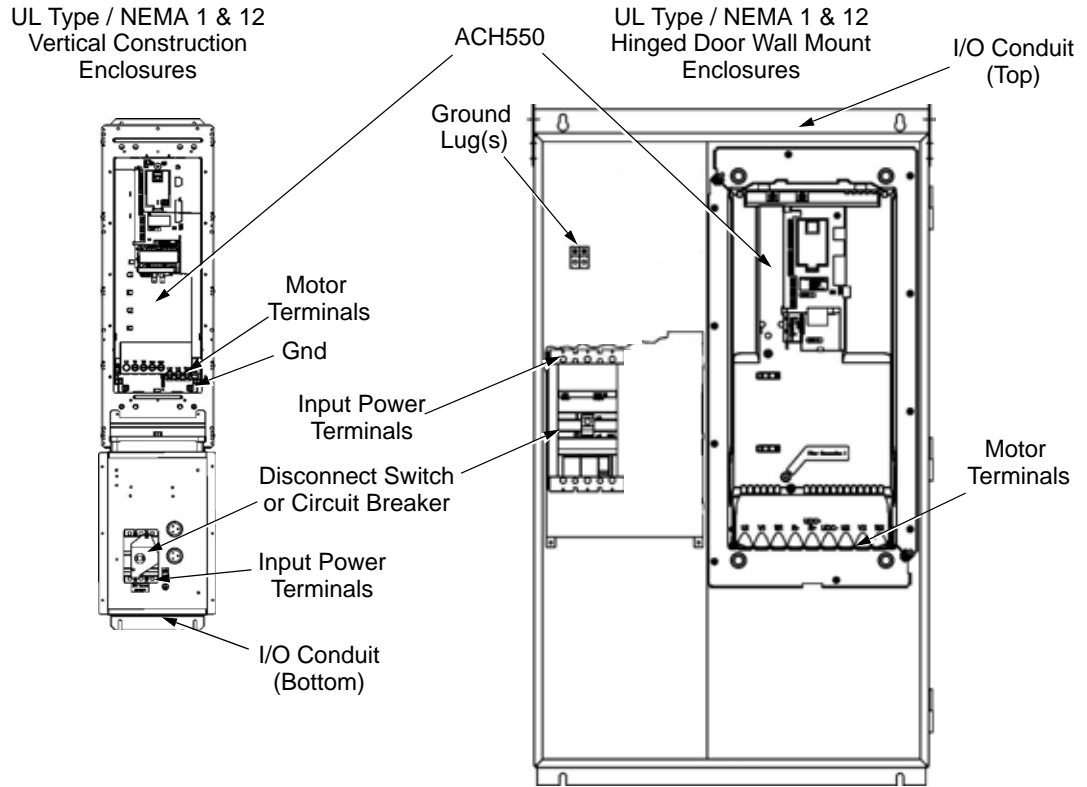

UL Type / NEMA 3R Enclosures

Fan/Space Heater Power Supply & Control Assembly

Disconnect Switch or Circuit Breaker

Input Power Terminals

I/O Conduit (Bottom)

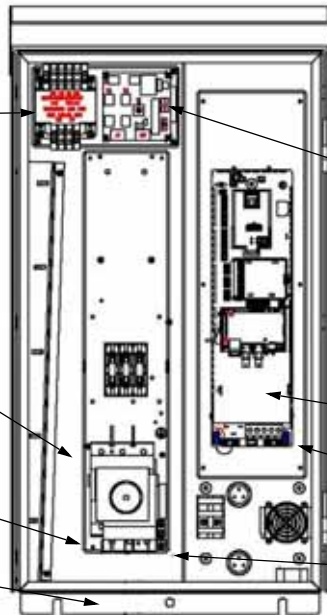

RHTR Temperature HI / LO Jumper (X1)	Heater ON Temperature	Heater OFF Temperature
Default Setting (X1 jumper in LO position)	14.4 °C 58 °F	21.4 °C 70.5 °F
Alternate Setting (X1 jumper in HI position)	17.8 °C 64 °F	24.7 °C 76.5 °C

The alternate (HI) setting further reduces the likelihood of condensate in high humidity environments.

Note: Some UL Type 3R enclosures are designed to be mounted on a wall. Mounting some of these 3R enclosures on an open rack system requires the use of the supplied 3R enclosure back plates to maintain 3R integrity.

Connection diagrams – standard drive with input disconnect (floor mounted)

Floor mounted UL Type / NEMA 1 & 12 Drive with Input Disconnect units are configured for wiring access from the top and include a removable conduit mounting plate. The following figure shows the wiring connection points.

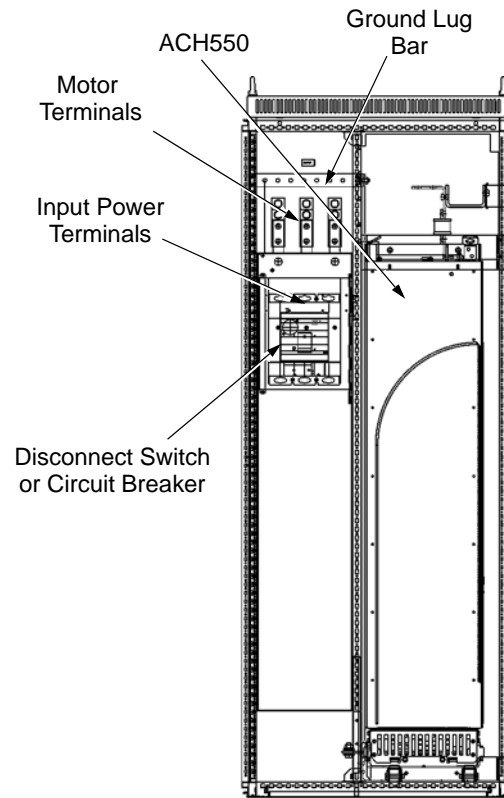

Line input connections – standard drive with input disconnect configurations

Connect input power to the terminals of the disconnect switch or circuit breaker. Connect the equipment grounding conductor to the ground lug at the top of the enclosure. The figure below shows the connection points for Standard Drive with Input Disconnect configurations.

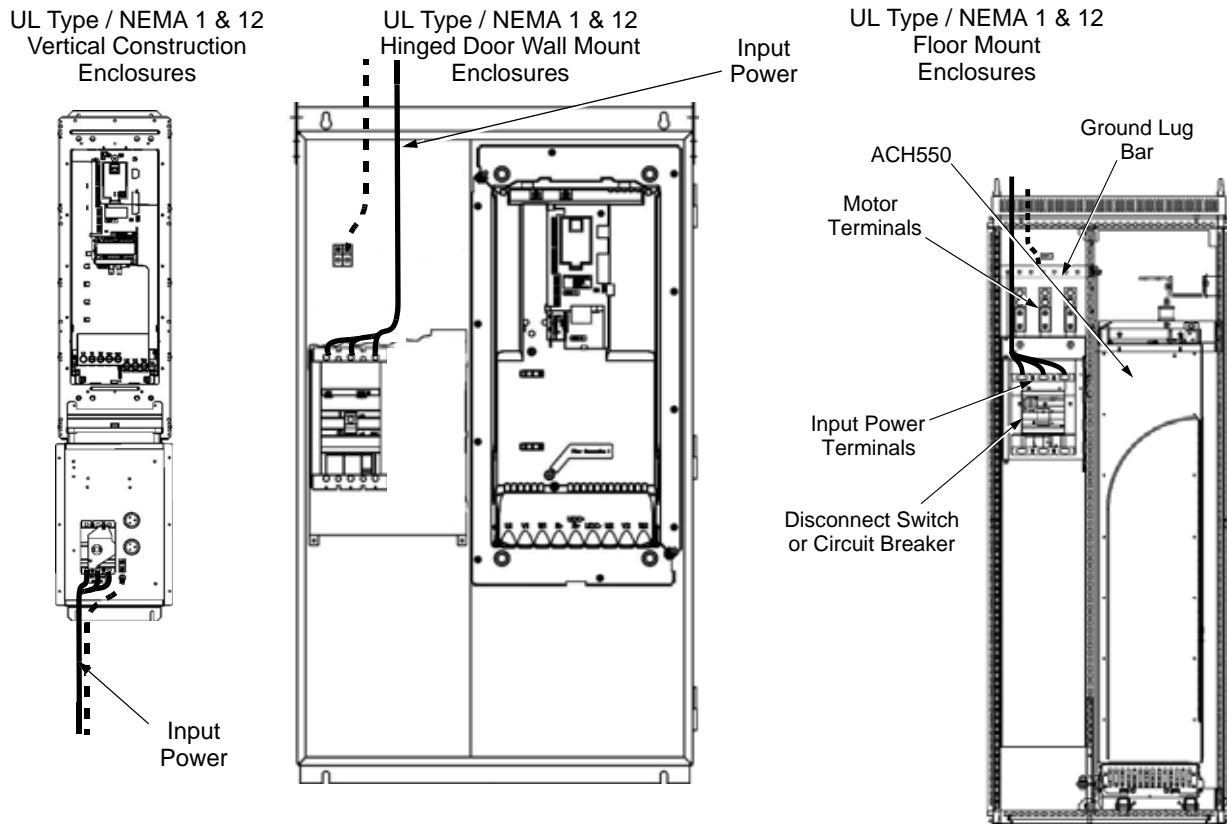

Dashed line is ground run.

Note: The terminals on disconnect switches for the following rated ACH550-PDR products is 7 in-lbs. Do not use a power driver or over tighten to prevent breaking screw heads or stripping the terminal.

230 VAC	460 VAC	600 VAC
-04A6-2	-03A3-4	-02A7-6
-06A6-2	-04A1-4	-03A9-6
-07A5-2	-06A9-4	-06A1-6
-012A-2	-08A8-4	-09A0-6
-017A-2	-012A-4	-011A-6
-024A-2	-015A-4	-017A-6
-031A-2	-023A-4	

UL Type / NEMA 3R Enclosures

RHTR Temperature HI / LO Jumper (X1)	Heater ON Temperature	Heater OFF Temperature
Default Setting (X1 jumper in LO position)	14.4 °C 58 °F	21.4 °C 70.5 °F
Alternate Setting (X1 jumper in HI position)	17.8 °C 64 °F	24.7 °C 76.5 °C

The alternate (HI) setting further reduces the likelihood of condensate in high humidity environments.

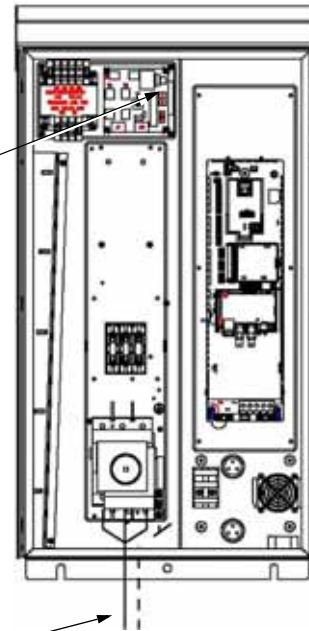

Input Power



WARNING! Check the motor and motor wiring insulation before connecting the ACH550 to line power. Follow the procedure on page 12. Before proceeding with the insulation resistance measurements, check that the ACH550 is disconnected from incoming line power. Failure to disconnect line power could result in death or serious injury.

Note: For the remainder of the wiring (motor and control wiring) refer to page 7.

Power connection terminals

The following tables show maximum wire size and required tightening torque for incoming power, grounding and motor terminals.

208/240 Volt		Base Drive Frame Size	Power Wiring Data ²						
HP	Type Code ¹		Circuit Breaker UL Type/ NEMA 1 &12	Circuit Breaker UL Type / NEMA 3R	Disconnect Switch UL Type/ NEMA 1&12	Disconnect Switch UL Type/ NEMA 3R	Motor Terminals	Ground Lugs UL Type/ NEMA 1&12	Ground Lugs UL Type / NEMA 3R
1	ACH550-PxR-04A6-2	R1	#10 35 in-lbs	#10 35 in-lbs	#10 7 in-lbs	#10 7 in-lbs	Refer to Drive's power connection terminals	#10 35 in-lbs	#10 35 in-lbs
1.5	ACH550-PxR-06A6-2	R1							
2	ACH550-PxR-07A5-2	R1							
3	ACH550-PxR-012A-2	R1							
5	ACH550-PxR-017A-2	R1							
7.5	ACH550-PxR-024A-2	R2	#6 45 in-lbs	#6 45 in-lbs	#8 7 in-lbs	#8 7 in-lbs		#6 35 in-lbs	#6 35 in-lbs
10	ACH550-PxR-031A-2	R2	#3 50 in-lbs	#3 50 in-lbs	#4 18 in-lbs	#4 18 in-lbs		#3 50 in-lbs	#3 50 in-lbs
15	ACH550-PxR-046A-2	R3							
20	ACH550-PxR-059A-2	R3							
25	ACH550-PxR-075A-2	R4	#1 50 in-lbs	#1 50 in-lbs	#1 55 in-lbs	#1 55 in-lbs		#2 50 in-lbs	#2 50 in-lbs
30	ACH550-PxR-088A-2	R4	350 MCM 274 in-lbs	300 MCM 200 in-lbs	#1/0 70 in-lbs	#1/0 70 in-lbs			
40	ACH550-PxR-114A-2	R4			300 MCM 275 in-lbs	300 MCM 200 in-lbs			
50	ACH550-PxR-143A-2	R6							
60	ACH550-PxR-178A-2	R6			2 x 500 MCM 274 in-lbs	2 x 500 MCM 274 in-lbs		2 x 500 MCM 274 in-lbs	2 x 500 MCM 274 in-lbs
75	ACH550-PxR-221A-2	R6							
100	ACH550-PxR-248A-2	R6	350 MCM 100 in-lbs						

1. "PxR" represents both PCR and PDR.

2. Torque values shown relate to current production. Check component labels on previously installed units for required tightening torque.

480 Volt		Base Drive Frame Size	Power Wiring Data ²						
HP	Type Code ¹		Circuit Breaker UL Type/ NEMA 1 & 12	Circuit Breaker UL Type/ NEMA 3R	Disconnect Switch UL Type/ NEMA 1&12	Disconnect Switch UL Type/ NEMA 3R	Motor Terminals	Ground Lugs UL Type/ NEMA 1&12	Ground Lugs UL Type/ NEMA 3R
1/1.5	ACH550-PxR-03A3-4	R1	#10 35 in-lbs	#10 35 in-lbs	#10 7 in-lbs	#10 7 in-lbs	Refer to Drive's power connection terminals	#10 35 in-lbs	#10 35 in-lbs
2	ACH550-PxR-04A1-4	R1							
3	ACH550-PxR-06A9-4	R1							
5	ACH550-PxR-08A8-4	R1							
7.5	ACH550-PxR-012A-4	R1							
10	ACH550-PxR-015A-4	R2	#6 45 in-lbs	#6 45 in-lbs	#8 7 in-lbs	#8 7 in-lbs		#6 35 in-lbs	#6 35 in-lbs
15	ACH550-PxR-023A-4	R2							
20	ACH550-PxR-031A-4	R3	#3 50 in-lbs	#3 50 in-lbs	#4 18 in-lbs	#4 18 in-lbs		#3 50 in-lbs	#3 50 in-lbs
25	ACH550-PxR-038A-4	R3							
30	ACH550-PxR-045A-4	R3							
40	ACH550-PxR-059A-4	R4	#1 50 in-lbs	#1 50 in-lbs	#1 55 in-lbs	#1 55 in-lbs		#1 50 in-lbs	#1 50 in-lbs
50	ACH550-PxR-072A-4	R4							
60	ACH550-PxR-078A-4	R4							
75	ACH550-PxR-097A-4	R4	350 MCM 274 in-lbs	300 MCM 200 in-lbs	#1/0 70 in-lbs	#1/0 70 in-lbs		3 x #3/0 250 in-lbs	#2 50 in-lbs
100	ACH550-PxR-125A-4	R5			300 MCM 275 in-lbs	300 MCM 200 in-lbs			
125	ACH550-PxR-157A-4	R6					300 MCM 275 in-lbs		300 MCM 200 in-lbs
150	ACH550-PxR-180A-4	R6							
200	ACH550-PxR-246A-4	R6	2 x 500 MCM 274 in-lbs	2 x 500 MCM 274 in-lbs	2 x 500 MCM 274 in-lbs	2 x 500 MCM 274 in-lbs	5 Bus Bar Holes (13/32")	350 MCM 100 in-lbs	
250	ACH550-PxR-316A-4	R8	2 x 500 MCM 274 in-lbs		2 x 500 MCM 274 in-lbs				
300	ACH550-PxR-368A-4	R8							
350	ACH550-PxR-414A-4	R8							
400	ACH550-PxR-486A-4	R8							
450	ACH550-PxR-526A-4	R8	3 x 400 MCM 375 in-lbs		3 x 400 MCM 375 in-lbs				
500	ACH550-PxR-602A-4	R8							
550	ACH550-PxR-645A-4	R8							

1. "PxR" represents both PCR and PDR.

2. Torque values shown relate to current production. Check component labels on previously installed units for required tightening torque.

600 Volt		Frame Size	Power Wiring Data ²							
HP	Type Code ¹		Circuit Breaker UL Type / NEMA 1 &12	Circuit Breaker UL Type / NEMA 3R	Disconnect Switch UL Type / NEMA 1&12	Disconnect Switch UL Type / NEMA 3R	Motor Terminals	Ground Lugs UL Type / NEMA 1&12	Ground Lugs UL Type / NEMA 3R	
2	ACH550-PxR-02A7-6	R2	#6 62 in-lbs	#6 62 in-lbs	#8 7 in-lbs	#8 7 in-lbs	Refer to Drive's power connection terminals	#6 35 in-lbs	#6 35 in-lbs	
3	ACH550-PxR-03A9-6	R2								
5	ACH550-PxR-06A1-6	R2								
7.5	ACH550-PxR-09A0-6	R2								
10	ACH550-PxR-011A-6	R2								
15	ACH550-PxR-017A-6	R2	#3 62 in-lbs	#3 62 in-lbs				#3 50 in-lbs	#3 50 in-lbs	
20	ACH550-PxR-022A-6	R3								
25	ACH550-PxR-027A-6	R3	#1 62 in-lbs	#1 62 in-lbs	#4 18 in-lbs	#4 18 in-lbs			#2 50 in-lbs	#2 50 in-lbs
30	ACH550-PxR-032A-6	R4								
40	ACH550-PxR-041A-6	R4								
50	ACH550-PxR-052A-6	R4			#1 62 in-lbs	#1 62 in-lbs	#1 55 in-lbs			
60	ACH550-PxR-062A-6	R4								
75	ACH550-PxR-077A-6	R6	350 MCM 274 in-lbs	300 MCM 275 in-lbs	#1/0 70 in-lbs	#1/0 70 in-lbs		3 x #3/0 250 in-lbs	#2/0 375 in-lbs	
100	ACH550-PxR-099A-6	R6								
125	ACH550-PxR-125A-6	R6								
150	ACH550-PxR-144A-6	R6								

1. "PxR" represents both PCR and PDR.

2. Torque values shown relate to current production. Check component labels on previously installed units for required tightening torque.

Operation

This information is unique to ACH550 input disconnect configurations (PCR or PDR). Refer to the [Operation](#) instructions on page 21 for all other information.

Input disconnect configuration

The ACH550 with Input Disconnect is an ACH550 AC adjustable frequency drive packaged with an input disconnect switch or circuit breaker, and with a door interlocked, external operating handle. The operating handle can be padlocked in the OFF position (padlock not supplied). Enclosure options are UL Type 1, UL Type 12, and UL Type 3R (NEMA 1, NEMA 12, and NEMA 3R).

The following is a typical power diagram.

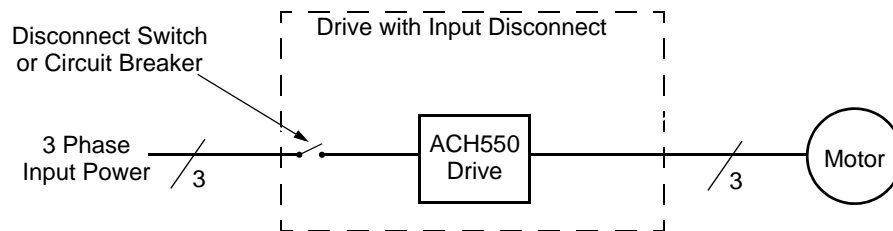

The following shows the front view of the ACH550 Drive with Input Disconnect standard configurations, and identifies the major components.

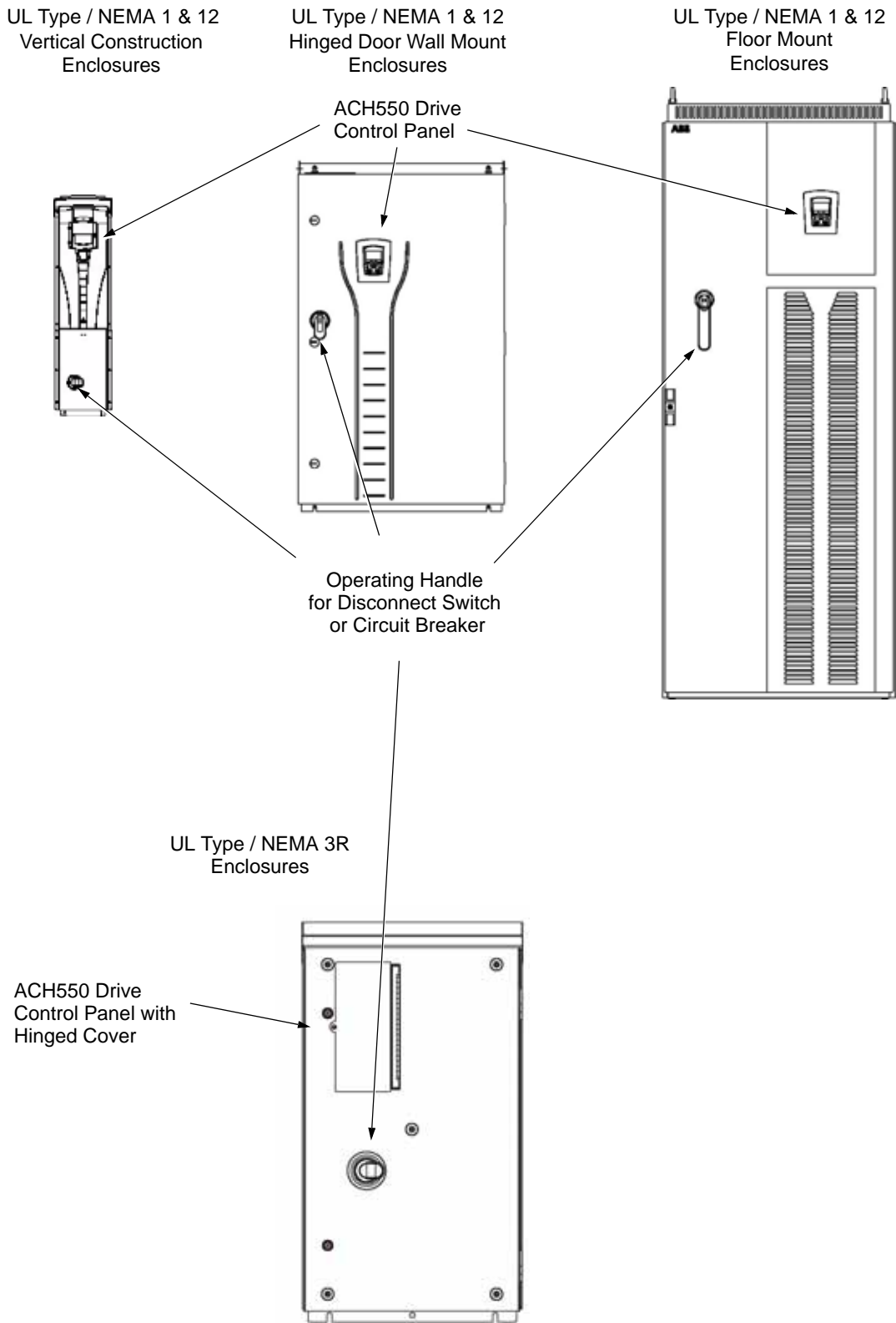

Maintenance

Maintenance intervals

If installed in an appropriate environment, the drive requires very little maintenance. This table lists the routine maintenance intervals recommended by ABB for ACH550 enclosures in addition to the intervals on page 31.

Maintenance	Configuration	Interval	Instruction
Check/replace hinged door wall mount enclosure inlet air filter	Hinged door wall mount UL Type / NEMA 12 enclosures	Check every 3 months. Replace as needed.	Enclosure air filter replacement – UL Type / NEMA 12 hinged door wall mount enclosures on page 89.
Check/replace floor mount enclosure inlet air filter	Floor mount UL Type / NEMA 12 enclosures	Check every 3 months. Replace as needed.	See Maintenance on page 34 and Enclosure air filter replacement – UL Type / NEMA 12 hinged door wall mount enclosures on page 89.
Check/replace NEMA 3R enclosure air filters	UL Type / NEMA 3R enclosures - PX3R-5 and higher	Check every 3 months. Replace as needed.	See PX3R dimensional information.
Check/replace floor mount enclosure exhaust air filter.	Floor mount UL Type / NEMA 12 enclosures	Check every 6 months. Replace as needed.	See Maintenance on page 35 and Enclosure air filter replacement – UL Type / NEMA 12 hinged door wall mount enclosures on page 89.

Enclosure air filter replacement – UL Type / NEMA 12 hinged door wall mount enclosures

Filter material

Material	Filter Type
American Air Filter (358-35-06A-12A)	Polykleon White 12.7 mm x 152.4 mm x 304.6 mm stk

This procedure applies to drive with input disconnect configurations in UL Type / NEMA 12 hinged door wall mount enclosures. This filter is located at the bottom of the enclosure. Use the following procedure to check and replace filters.

1. On the enclosure, remove the screw holding the filter bracket in place.
2. Slide the filter bracket forward until the hooks on the bracket clear the slots on the enclosure base. This step allows the filter and bracket to drop free from the enclosure.

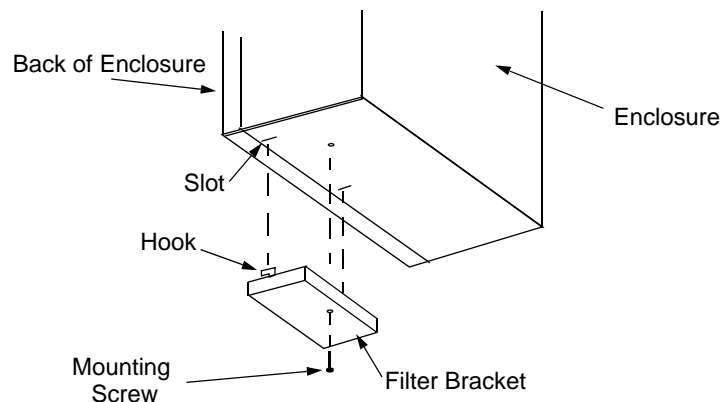

3. Lift the filter out of the filter bracket and replace as appropriate.
4. With the filter in the filter bracket, align the hooks on the bracket with the slots in the enclosure base, and press the hooks up into the slots.
5. Slide the filter bracket back, making sure that the hooks catch on the enclosure.
6. Replace the mounting screw. Tighten until the gasket on the bracket is about 50% compressed.

Enclosure air filter replacement – UL Type / NEMA 12 floor mount enclosures

Filter material

Enclosure Type	Inlet (door)	Outlet (roof)
UL Type / NEMA 12	3AUA0000006723 (qty 1)	3AUA0000006722 (qty 2)

Note: When installing the filter media, the white side must face the outside of the cabinet and the colored side must face the inside of the cabinet. Refer to page [34](#).

Diagnostics

Refer to the [Diagnostics](#) instructions on page [24](#).

Complete ACH550 Drive Parameter List

GROUP 01	
OPERATING DATA	
101	SPEED & DIR
102	SPEED
103	OUTPUT FREQ
104	CURRENT
105	TORQUE
106	POWER
107	DC BUS VOLTAGE
109	OUTPUT VOLTAGE
110	DRIVE TEMP
111	EXTERNAL REF 1
112	EXTERNAL REF 2
113	CTRL LOCATION
114	RUN TIME (R)
115	KWH COUNTER (R)
116	APPL BLK OUTPUT
118	DI 1-3 STATUS
119	DI 4-6 STATUS
120	AI 1
121	AI 2
122	RO 1-3 STATUS
123	RO 4-6 STATUS
124	AO 1
125	AO 2
126	PID 1 OUTPUT
127	PID 2 OUTPUT
128	PID 1 SETPNT
129	PID 2 SETPNT
130	PID 1 FBK
131	PID 2 FBK
132	PID 1 DEVIATION
133	PID 2 DEVIATION
134	COMM RO WORD
135	COMM VALUE 1
136	COMM VALUE 2
137	PROCESS VAR 1
138	PROCESS VAR 2
139	PROCESS VAR 3
140	RUN TIME
141	MWH COUNTER
142	REVOLUTION
143	CNTR
143	DRIVE ON TIME HI
144	DRIVE ON TIME LO
145	MOTOR TEMP
150	CB TEMP
153	MOT THERM STRESS
158	PID COMM VALUE 1
159	PID COMM VALUE 2
174	SAVED KWH
175	SAVED MWH
176	SAVED AMOUNT 1
177	SAVED AMOUNT 2
178	SAVED CO2
GROUP 03	
FB ACTUAL SIGNALS	
301	FB CMD WORD 1
302	FB CMD WORD 2
303	FB STS WORD 1
304	FB STS WORD 2
305	FAULT WORD 1
306	FAULT WORD 2
307	FAULT WORD 3
308	ALARM WORD 1
309	ALARM WORD 2
GROUP 04	
FAULT HISTORY	
401	LAST FAULT
402	FAULT TIME 1
403	FAULT TIME 2
404	SPEED AT FLT
405	FREQ AT FLT
406	VOLTAGE AT FLT
407	CURRENT AT FLT
408	TORQUE AT FLT
409	STATUS AT FLT
410	DI 1-3 AT FLT
411	DI 4-6 AT FLT
412	PREVIOUS FAULT 1
413	PREVIOUS FAULT 2
GROUP 10	
START/STOP/DIR	
1001	EXT1 COMMANDS
1002	EXT2 COMMANDS
1003	DIRECTION
GROUP 11	
REFERENCE SELECT	
1101	KEYPAD REF SEL
1102	EXT1/EXT2 SEL
1103	REF1 SELECT
1104	REF 1 MIN
1105	REF 1 MAX
1106	REF2 SELECT
1107	REF 2 MIN
1108	REF 2 MAX
GROUP 12	
CONSTANT SPEEDS	
1201	CONST SPEED SEL
1202	CONST SPEED 1
1203	CONST SPEED 2
1204	CONST SPEED 3
1205	CONST SPEED 4
1206	CONST SPEED 5
1207	CONST SPEED 6
1208	CONST SPEED 7
1209	TIMED MODE SEL
GROUP 13	
ANALOG INPUTS	
1301	MINIMUM AI1
1302	MAXIMUM AI1
1303	FILTER AI1
1304	MINIMUM AI2
1305	MAXIMUM AI2
1306	FILTER AI2
GROUP 14	
RELAY OUTPUTS	
1401	RELAY OUTPUT 1
1402	RELAY OUTPUT 2
1403	RELAY OUTPUT 3
1404	RO 1 ON DELAY
1405	RO 1 OFF DELAY
1406	RO 2 ON DELAY
1407	RO 2 OFF DELAY
1408	RO 3 ON DELAY
1409	RO 3 OFF DELAY
1410	RELAY OUTPUT 4
1411	RELAY OUTPUT 5
1412	RELAY OUTPUT 6
1413	RO 4 ON DELAY
1414	RO 4 OFF DELAY
1415	RO 5 ON DELAY
1416	RO 5 OFF DELAY
1417	RO 6 ON DELAY
1418	RO 6 OFF DELAY
GROUP 15	
ANALOG OUTPUTS	
1501	AO1 CONTENT
1502	AO1 CONTENT MIN
1503	AO1 CONTENT MAX
1504	MINIMUM AO1
1505	MAXIMUM AO1
1506	FILTER AO1
1507	AO2 CONTENT
1508	AO2 CONTENT MIN
1509	AO2 CONTENT MAX
1510	MINIMUM AO2
1511	MAXIMUM AO2
1512	FILTER AO2
GROUP 16	
SYSTEM CONTROLS	
1601	RUN ENABLE
1602	PARAMETER LOCK
1603	PASS CODE
1604	FAULT RESET SEL
1605	USER PAR SET CHG
1606	LOCAL LOCK
1607	PARAM SAVE
1608	START ENABLE 1
1609	START ENABLE 2
1610	DISPLAY ALARMS
1611	PARAMETER VIEW
1612	FAN CONTROL
1613	FAULT RESET
GROUP 17	
OVERRIDE	
1701	OVERRIDE SEL
1702	OVERRIDE FREQ
1703	OVERRIDE SPEED
1704	OVERR PASS CODE
1705	OVERRIDE
1706	OVERRIDE DIR
1707	OVERRIDE REF
GROUP 20	
LIMITS	
2001	MINIMUM SPEED
2002	MAXIMUM SPEED
2003	MAX CURRENT
2006	UNDERVOLT CTRL
2007	MINIMUM FREQ
2008	MAXIMUM FREQ
2013	MIN TORQUE SEL
2014	MAX TORQUE SEL
2015	MIN TORQUE 1
2016	MIN TORQUE 2
2017	MAX TORQUE 1
2018	MAX TORQUE 2
GROUP 21	
START/STOP	
2101	START FUNCTION
2102	STOP FUNCTION
2103	DC MAGN TIME
2104	DC HOLD CTL
2105	DC HOLD SPEED
2106	DC CURR REF
2107	DC BRAKE TIME
2108	START INHIBIT
2109	EM STOP SEL
2110	TORQ BOOST CURR
2113	START DELAY
GROUP 22	
ACCEL/DECCEL	
2201	ACC/DEC 1/2 SEL
2202	ACCELER TIME 1
2203	DECELER TIME 1
2204	RAMP SHAPE 1
2205	ACCELER TIME 2
2206	DECELER TIME 2
2207	RAMP SHAPE 2
2208	EM DEC TIME
2209	RAMP INPUT 0
GROUP 23	
SPEED CONTROL	
2301	PROP GAIN
2302	INTEGRATION TIME
2303	DERIVATION TIME
2304	ACC COMPENSATION
2305	AUTOTUNE RUN
GROUP 25	
CRITICAL SPEEDS	
2501	CRIT SPEED SEL
2502	CRIT SPEED 1 LO
2503	CRIT SPEED 1 HI
2504	CRIT SPEED 2 LO
2505	CRIT SPEED 2 HI
2506	CRIT SPEED 3 LO
2507	CRIT SPEED 3 HI
GROUP 26	
MOTOR CONTROL	
2601	FLUX OPT ENABLE
2602	FLUX BRAKING
2603	IR COMP VOLT
2604	IR COMP FREQ
2605	U/F RATIO
2606	SWITCHING FREQ
2607	SW FREQ CTRL
2608	SLIP COMP RATIO
2609	NOISE SMOOTHING
2619	DC STABILIZER
2625	OVERMODULATION
GROUP 29	
MAINTENANCE TRIG	
2901	COOLING FAN TRIG
2902	COOLING FAN ACT
2903	REVOLUTION TRIG
2904	REVOLUTION ACT
2905	RUN TIME TRIG
2906	RUN TIME ACT
2907	USER MWH TRIG
2908	USER MWH ACT
GROUP 30	
FAULT FUNCTIONS	
3001	AI<MIN FUNCTION
3002	PANEL COMM ERR
3003	EXTERNAL FAULT 1
3004	EXTERNAL FAULT 2
3005	MOT THERM PROT
3006	MOT THERM TIME
3007	MOT LOAD CURVE
3008	ZERO SPEED LOAD
3009	BREAK POINT FREQ
3010	STALL FUNCTION
3011	STALL FREQUENCY
3012	STALL TIME
3017	EARTH FAULT
3018	COMM FAULT FUNC
3019	COMM FAULT TIME
3021	AI1 FAULT LIMIT
3022	AI2 FAULT LIMIT
3023	WIRING FAULT
3024	CB TEMP FAULT
3028	EARTH FAULT LVL
GROUP 31	
AUTOMATIC RESET	
3101	NR OF TRIALS
3102	TRIAL TIME
3103	DELAY TIME
3104	AR OVERCURRENT
3105	AR OVERVOLTAGE
3106	AR UNDERVOLTAGE
3107	AR AI-MIN
3108	AR EXTERNAL FLT
GROUP 32	
SUPERVISION	
3201	SUPERV 1 PARAM
3202	SUPERV 1 LIM LO
3203	SUPERV 1 LIM HI
3204	SUPERV 2 PARAM
3205	SUPERV 2 LIM LO
3206	SUPERV 2 LIM HI
3207	SUPERV 3 PARAM
3208	SUPERV 3 LIM LO
3209	SUPERV 3 LIM HI
GROUP 33	
INFORMATION	
3301	FW VERSION
3302	LP VERSION
3303	TEST DATE
3304	DRIVE RATING
3305	PARTABLE VERSION
GROUP 34	
PANEL DISPLAY	
3401	SIGNAL 1 PARAM
3402	SIGNAL 1 MIN
3403	SIGNAL 1 MAX
3404	OUTPUT 1 DSP FORM
3405	OUTPUT 1 UNIT
3406	OUTPUT 1 MIN
3407	OUTPUT 1 MAX
3408	SIGNAL 2 PARAM
3409	SIGNAL 2 MIN
3410	SIGNAL 2 MAX
3411	OUTPUT 2 DSP FORM
3412	OUTPUT 2 UNIT
3413	OUTPUT 2 MIN
3414	OUTPUT 2 MAX
3415	SIGNAL 3 PARAM
3416	SIGNAL 3 MIN
3417	SIGNAL 3 MAX
3418	OUTPUT 3 DSP FORM
3419	OUTPUT 3 UNIT
3420	OUTPUT 3 MIN
3421	OUTPUT 3 MAX
GROUP 35	
MOTOR TEMP MEAS	
3501	SENSOR TYPE
3502	INPUT SELECTION
3503	ALARM LIMIT
3504	FAULT LIMIT
GROUP 36	
TIMED FUNCTIONS	
3601	TIMERS ENABLE
3602	START TIME 1
3603	STOP TIME 1
3604	START DAY 1
3605	STOP DAY 1
3606	START TIME 2
3607	STOP TIME 2
3608	START DAY 2
3609	STOP DAY 2
3610	START TIME 3
3611	STOP TIME 3
3612	START DAY 3
3613	STOP DAY 3
3614	START TIME 4
3615	STOP TIME 4
3616	START DAY 4
3617	STOP DAY 4
3622	BOOST SEL
3623	BOOST TIME
3626	TIMER 1 SRC
3627	TIMER 2 SRC
3628	TIMER 3 SRC
3629	TIMER 4 SRC
GROUP 37	
USER LOAD CURVE	
3701	USER LOAD C MODE
3702	USER LOAD C FUNC
3703	USER LOAD C TIME
3704	LOAD FREQ 1
3705	LOAD TORQ LOW 1
3706	LOAD TORQ HIGH 1
3707	LOAD FREQ 2
3708	LOAD TORQ LOW 2
3709	LOAD TORQ HIGH 2
3710	LOAD FREQ 3
3711	LOAD TORQ LOW 3
3712	LOAD TORQ HIGH 3
3713	LOAD FREQ 4
3714	LOAD TORQ LOW 4
3715	LOAD TORQ HIGH 4
3716	LOAD FREQ 5
3717	LOAD TORQ LOW 5
3718	LOAD TORQ HIGH 5
GROUP 40	
PROCESS PID SET 1	
4001	GAIN
4002	INTEGRATION TIME
4003	DERIVATION TIME
4004	PID DERIV FILTER
4005	ERROR VALUE INV UNITS
4006	DSP FORMAT
4007	0% VALUE
4008	100% VALUE
4010	SET POINT SEL
4011	INTERNAL SETPNT
4012	SETPOINT MIN
4013	SETPOINT MAX
4014	FBK SEL
4015	FBK MULTIPLIER
4016	ACT1 INPUT
4017	ACT2 INPUT
4018	ACT1 MINIMUM
4019	ACT1 MAXIMUM
4020	ACT2 MINIMUM
4021	ACT2 MAXIMUM
4022	SLEEP SELECTION
4023	PID SLEEP LEVEL
4024	PID SLEEP DELAY
4025	WAKE-UP DEV
4026	WAKE-UP DELAY
4027	PID 1 PARAM SET
GROUP 41	
PROCESS PID SET 2	
4101	GAIN
4102	INTEGRATION TIME
4103	DERIVATION TIME
4104	PID DERIV FILTER
4105	ERROR VALUE INV UNITS
4106	DSP FORMAT
4107	0% VALUE
4108	100% VALUE
4110	SET POINT SEL
4111	INTERNAL SETPNT
4112	SETPOINT MIN
4113	SETPOINT MAX
4114	FBK SEL
4115	FBK MULTIPLIER
4116	ACT1 INPUT

4117	ACT2 INPUT
4118	ACT1 MINIMUM
4119	ACT1 MAXIMUM
4120	ACT2 MINIMUM
4121	ACT2 MAXIMUM
4122	SLEEP SELECTION
4123	PID SLEEP LEVEL
4124	PID SLEEP DELAY
4125	WAKE-UP DEV
4126	WAKE-UP DELAY
GROUP 42	
EXT / TRIM PID	
4201	GAIN
4202	INTEGRATION TIME
4203	DERIVATION TIME
4204	PID DERIV FILTER
4205	ERROR VALUE INV
4206	UNITS
4207	DSP FORMAT
4208	0% VALUE
4209	100% VALUE
4210	SET POINT SEL
4211	INTERNAL SETPNT
4212	SETPOINT MIN
4213	SETPOINT MAX
4214	FBK SEL
4215	FBK MULTIPLIER
4216	ACT1 INPUT
4217	ACT2 INPUT
4218	ACT1 MINIMUM
4219	ACT1 MAXIMUM
4220	ACT2 MINIMUM
4221	ACT2 MAXIMUM
4228	ACTIVATE
4229	OFFSET
4230	TRIM MODE
4231	TRIM SCALE
4232	CORRECTION SRC
GROUP 45	
ENERGY SAVING	
4502	ENERGY PRICE
4507	CO2 CONV FACTOR
4508	PUMP POWER
4509	ENERGY RESET
GROUP 51	
EXT COMM MODULE	
5101	FBA TYPE
5102	FBA PAR 2...26
5127	FBA PAR REFRESH
5128	FILE CPI FW REV
5129	FILE CONFIG ID
2130	FILE CONFIG REV
5131	FBA STATUS
5132	FBA CPI FW REV
5133	FBA APPL FW REV
GROUP 52	
PANEL COMM	
5201	STATION ID
5202	BAUD RATE
5203	PARITY
5204	OK MESSAGES
5205	PARITY ERRORS
5206	FRAME ERRORS
5207	BUFFER
	OVERRUNS
5208	CRC ERRORS
GROUP 53	
EFB PROTOCOL	
5301	EFB PROTOCOL ID
5302	EFB STATION ID
5303	EFB BAUD RATE
5304	EFB PARITY
5305	EFB CTRL PROFILE
5306	EFB OK
	MESSAGES
5307	EFB CRC ERRORS
5308	EFB UART ERRORS
5309	EFB STATUS
5310	EFB PAR 10-18
5319	EFB PAR 19-20
GROUP 64	
LOAD ANALYZER	
6401	PVL SIGNAL
6402	PVL FILTER TIME
6403	LOGGERS RESET
6404	AL2 SIGNAL
6405	AL2 SIGNAL BASE
6406	PEAK VALUE
6407	PEAK TIME 1
6408	PEAK TIME 2
6409	CURRENT AT PEAK

6410	UDC AT PEAK
6411	FREQ AT PEAK
6412	TIME OF RESET 1
6413	TIME OF RESET 2
6414	AL1RANGE0TO10
6415	AL1RANGE10TO20
6416	AL1RANGE20TO30
6417	AL1RANGE30TO40
6418	AL1RANGE40TO50
6419	AL1RANGE50TO60
6420	AL1RANGE60TO70
6421	AL1RANGE70TO80
6422	AL1RANGE80TO90
6423	AL1RANGE90TO
6424	AL2RANGE0TO10
6425	AL2RANGE10TO20
6426	AL2RANGE20TO30
6427	AL2RANGE30TO40
6428	AL2RANGE40TO50
6429	AL2RANGE50TO60
6430	AL2RANGE60TO70
6431	AL2RANGE70TO80
6432	AL2RANGE80TO90
6433	AL2RANGE90TO
GROUP 81	
PFA CONTROL	
8103	REFERENCE STEP 1
8104	REFERENCE STEP 2
8105	REFERENCE STEP 3
8109	START FREQ 1
8110	START FREQ 2
8111	START FREQ 3
8112	LOW FREQ 1
8113	LOW FREQ 2
8114	LOW FREQ 3
8115	AUX MOT START D
8116	AUX MOT STOP D
8117	NR OF AUX MOT
8118	AUTOCHNG INTERV
8119	AUTOCHNG LEVEL
8120	INTERLOCKS
8121	REG BYPASS CTRL
8122	PFA START DELAY
8123	PFA ENABLE
8124	ACC IN AUX STOP
8125	DEC IN AUX START
8126	TIMED AUTOCHNG
8127	MOTORS
8128	AUX START ORDER
GROUP 98	
OPTIONS	
9802	COMM PROT SEL
GROUP 99	
START-UP DATA	
9901	LANGUAGE
9902	APPLIC MACRO
9904	MOTOR CTRL
	MODE
9905	MOTOR NOM VOLT
9906	MOTOR NOM CURR
9907	MOTOR NOM FREQ
9908	MOTOR NOM
	SPEED
9909	MOTOR NOM
	POWER
9915	MOTOR COSPHI

For E-Clipse Bypass Drive

GROUP 01	
ACTUAL DATA	
0101	MOTOR CURR
0102	INPUT VOLT
0103	DI STATUS
0104	RO STATUS
0105	PCB TEMP
0106	KW HOURS
0107	COMM RO
0108	RUN TIME
0109	ON TIME 1
0110	ON TIME 2

0111	A-B VOLT
0112	B-C VOLT
0113	C-A VOLT
0114	MWH SAVED
0115	COST SAVED
0116	CO2 SAVED
0117	KWH SAVE L
0118	KWH SAVE H
GROUP 03	
STATUS	
0301	FBUS CW 1
0303	FBUS SW 1
0305	FLT WORD 1
0306	FLT WORD 2
0307	FLT WORD 3
0308	ALR WORD 1
0309	ALR WORD 2
GROUP 04	
FAULT LOG	
0401	LAST FAULT
0402	F1 TIME 1
0403	F1 TIME 2
0404	F1 VOLTAGE
0405	F1 CURRENT
0406	F1 EVENT 1
0407	F1 E1 TIME
0408	F1 EVENT 2
0409	F1 E2 TIME
0410	FAULT 2
0411	F2 TIME 1
0412	F2 TIME 2
0413	F2 VOLTAGE
0414	F2 CURRENT
0415	F2 EVENT 1
0416	F2 E1 TIME
0417	F2 EVENT 2
0418	F2 E2 TIME
0419	FAULT 3
0420	FAULT 4
0421	FAULT 5
GROUP 05	
EVENT LOG	
0501	LAST EVENT
0502	E1 TIME 1
0503	E1 TIME 2
0504	EVENT 2
0505	E2 TIME 1
0506	E2 TIME 2
0507	EVENT 3
0508	E3 TIME 1
0509	E3 TIME 2
0510	EVENT 4
0511	E4 TIME 1
0512	E4 TIME 2
GROUP 14	
RELAY OUT	
1401	R01 SELECT
1402	R1 ON DLY
1403	R1 OFF DLY
1404	R02 SELECT
1405	R2 ON DLY
1406	R2 OFF DLY
1407	R03 SELECT
1408	R3 ON DLY
1409	R3 OFF DLY
1410	R04 SELECT
1411	R4 ON DLY
1412	R4 OFF DLY
1413	R05 SELECT
1414	R5 ON DLY
1415	R5 OFF DLY
GROUP 16	
SYSTEM CTRL	
1601	START/STOP
1602	RUN ENABLE
1603	START EN 1
1604	START EN 2
1605	START EN 3
1606	START EN 4
1607	RESET SRC
1608	AUTO XFR
1609	OC TRANSFR
1610	OV TRANSFR
1611	UV TRANSFR
1612	AI TRANSFR
1613	BP DISABLE
1614	BP RUN DLY
1615	SAVE PARAM
1616	DISP ALRMS
1617	DRIVE TEST
1618	PASS CODE
1619	PAR LOCK

1620	RUN EN TXT
1621	ST EN1 TXT
1622	ST EN2 TXT
1623	ST EN3 TXT
1624	ST EN4 TXT
1625	COMM CTRL
1626	MODE LOCK
1627	COST/KWH
1628	LEARN MODE
1629	LEARN TIME
1630	REVERSE REQ
1631	DRV/BYPASS
GROUP 17	
OVERRIDE 2	
1701	OVERRIDE 2
1702	RUN EN OVR
1703	ST EN1 OVR
1704	ST EN2 OVR
1706	ST EN4 OVR
1707	FAULTS OVR
1708	OVRD2 MODE
GROUP 30	
FLT FUNCTION	
3001	UL ACTION
3002	UL TIME
3003	UL TRIP %
3004	COMM LOSS
3005	COMM TIME
3006	PHASE LOSS
3007	PHASE SEQ
3008	BYPASS MOL
GROUP 32	
SUPERV CTRL	
3201	SUPER CTRL
3202	START LVL
3203	STOP LEVEL
3204	START DLY
3205	STOP DLY
3206	FBK LOSS
GROUP 33	
INFORMATION	
3301	FW VERSION
3302	PT VERSION
3303	LP VERSION
3304	CB VERSION
3305	TEST DATE
3306	DRIVE TYPE
3307	SUB ASMBLY
3308	PLANT CODE
3309	MFG DATE
3310	UNIT NUM
GROUP 50	
BYPASS EFB	
5001	BP PROT ID
5002	BP MAC ID
5003	BAUD RATE
5004	EFB PARITY
5005	PROFILE
5006	BP OK MSG
5007	BP CRC ERR
5008	UART ERROR
5009	BP STATUS
5010	BP PAR 10
5011	BP PAR 11
5012	BP PAR 12
5013	BP PAR 13
5014	BP PAR 14
5015	BP PAR 15
5016	BP PAR 16
5017	BP PAR 17
5018	BP PAR 18
5019	BP PAR 19
5020	BP PAR 20
GROUP 51	
EXT COMM MOD	
5101	FBA TYPE
5102	FBA PAR 2
5103	FBA PAR 3
5104	FBA PAR 4
5105	FBA PAR 5
5106	FBA PAR 6
5107	FBA PAR 7
5108	FBA PAR 8
5109	FBA PAR 9
5110	FBA PAR 10
5111	FBA PAR 11
5112	FBA PAR 12
5113	FBA PAR 13
5114	FBA PAR 14
5115	FBA PAR 15
5116	FBA PAR 16
5117	FBA PAR 17

5118	FBA PAR 18
5119	FBA PAR 19
5120	FBA PAR 20
5121	FBA PAR 21
5122	FBA PAR 22
5123	FBA PAR 23
5124	FBA PAR 24
5125	FBA PAR 25
5126	FBA PAR 26
5127	REFRESH
5128	FBA PAR 28
5129	FBA PAR 29
5130	FBA PAR 30
5131	FBA STATUS
5132	FBA PAR 32
5133	FBA PAR 33
GROUP 53	
DRIVE EFB	
5301	DV PROT ID
5302	DV MAC ID
5303	BAUD RATE
5304	EFB PARITY
5305	PROFILE
5306	DV OK MSG
5307	DV CRC ERR
5308	UART ERROR
5309	DV STATUS
5310	DV PAR 10
5311	DV PAR 11
5312	DV PAR 12
5313	DV PAR 13
5314	DV PAR 14
5315	DV PAR 15
5316	DV PAR 16
5317	DV PAR 17
5318	DV PAR 18
5319	DV PAR 19
5320	DV PAR 20
GROUP 54	
FBA DATA IN	
5401	DATA IN 1
5402	DATA IN 2
5403	DATA IN 3
5404	DATA IN 4
5405	DATA IN 5
5406	DATA IN 6
5407	DATA IN 7
5408	DATA IN 8
5409	DATA IN 9
GROUP 55	
FBA DATA OUT	
5501	DATA OUT 1
5502	DATA OUT 2
5503	DATA OUT 3
5504	DATA OUT 4
5505	DATA OUT 5
5506	DATA OUT 6
5507	DATA OUT 7
5508	DATA OUT 8
5509	DATA OUT 9
5510	DATA OUT 10
GROUP 98	
OPTIONS	
9802	COMM PROT SEL
GROUP 99	
STARTUP DATA	
9902	B.P. MACRO





3AJA0000081824 REV C
Effective: 12/01/2014
Supersedes: 04/15/2012

ABB Inc.

16250 West Glendale Drive

New Berlin, WI 53151

USA

Telephone +1 800 752-0696

Fax +1 262 785-0397

Internet www.abb.us/drives