



17440
(91501-SG0-003)
Nylon

Body Side Moulding Clip
Legend
1987-On

UNIT PACKAGE: 15



21557
(75316-S9A-004)
White Nylon

Door Trim
Moulding Clip
Head Size: 14mm x 16mm
Stem Length: 12mm
Fits Into 10mm Hole
Acura RDX and Honda CR-V
2002 - On

UNIT PACKAGE: 25



21639
(72431-S2X-003)
White Nylon

Moulding Clip
Top Head Size: 8mm x 10.5mm
Bottom Head Size: 11mm x 16mm
Overall Height: 14.6mm
Acura RSX and Honda Civic,
CR-Z & Insight
2006 - 01

UNIT PACKAGE: 25



21559
(91512-SJ6-J01)
Black Nylon

Rocker Panel, Tail Light &
License Plate Housing
Garnish Moulding Clip
With Sealer
Top Head Size: 9mm x 12mm
Bottom Head Diameter: 13mm
Stem Diameter: 7.5mm
Stem Length: 9mm
Acura TSX and
Honda Civic & CR-V
1997 - On

UNIT PACKAGE: 25



21308
(90602-SFA-004)
White Nylon

Cowl & Dash
Moulding Clip
Top Head Size: 13mm x 14mm
Bottom Head Diameter: 16mm
Stem Length: 13mm
Acura RL and Honda Civic,
Civic Hybrid & Odyssey
2005 - On

UNIT PACKAGE: 25



19225
(91501-SP1-003)
Nylon

Side Sill
Garnish Moulding Clip
Legend Coupe
1991-On

UNIT PACKAGE: 10



21555
(91512-S50-003)
White Nylon

License Plate Garnish &
Trim Moulding Clip
With Sealer
Top Head Size: 12mm x 17mm
Bottom Head Size: 16mm x 17mm
Stem Diameter: 13mm
Stem Length: 12mm
Acura TSX & ZDX and
Honda Accord,
Civic, Crosstour, Fit, Insight,
Odyssey & Pilot
2001 - On

UNIT PACKAGE: 25



21558
(91504-SP1-003)
White Nylon

Rocker Panel & Fender
Moulding Clip
With Sealer
Top Head Size: 16mm x 18mm
Bottom Head Size: 18mm x 20mm
Stem Length: 15mm
Fits Into 10mm Hole
Acura Legend, MDX, RL & ZDX
and Honda Civic, CR-V & Odyssey
1991 - On

UNIT PACKAGE: 25



21204
(75315-STK-A01)
White Nylon

Front & Rear Door
Exterior Trim
Moulding Clip
Top Head Size: 12mm x 15mm
Bottom Head Size: 14mm x 20mm
Stem Length: 9mm
RDX
2009 - 07

UNIT PACKAGE: 15

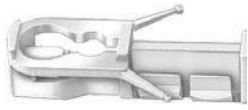
Sec. 22**ACURA CLIPS & FASTENERS****19740**(90666-SSO-003)
White NylonRoof Moulding Clip
Acura Integra & Legend
Honda Prelude
1992-On

UNIT PACKAGE: 10

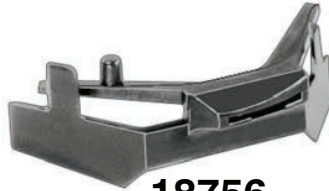
**18756**(90621-SK7-003)
White NylonWindshield Corner Moulding Clip
Integra
1993-90

UNIT PACKAGE: 5

**18759**(90601-SK7-003)
Green NylonWindshield Side Moulding Clip
Integra 3 & 4 Door
1993-90

UNIT PACKAGE: 15

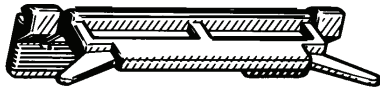
**17323**(91513-SP0-003)
Teal NylonWindshield Side Moulding Clip
4 Door Legend
1991-On

UNIT PACKAGE: 10

**18761**(91536-SP0-003)
Light Blue NylonWindshield Corner Moulding Clip
Legend 4 Door
1991-On

UNIT PACKAGE: 5

**18764**(91514-SP0-003)
Yellow NylonWindshield Side Moulding Clip
Legend 4 Door
1991-On

UNIT PACKAGE: 5

**17280**(91505-SG0-003)
Orange NylonWindshield Moulding Clip
Honda Prelude and
Acura Legend
1988-On

UNIT PACKAGE: 10

**18763**(90611-SK7-003)
White NylonWindshield Corner Moulding Clip
Integra
1993-90

UNIT PACKAGE: 5

18757(91527-SP1-003)
Green NylonWindshield Side Moulding Clip
Legend 2 Door
1991-On

UNIT PACKAGE: 5

**17282**(91534-SM4-003)
White NylonWindshield Moulding Clip
Honda Accord 1990-On
Acura Legend 1991-On

UNIT PACKAGE: 10

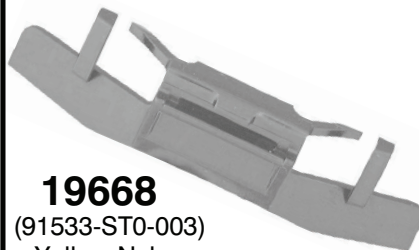
**19668**(91533-ST0-003)
Yellow NylonWindshield Moulding Clip
Integra
1994-On

UNIT PACKAGE: 10

ACURA CLIPS & FASTENERS

Sec. 22

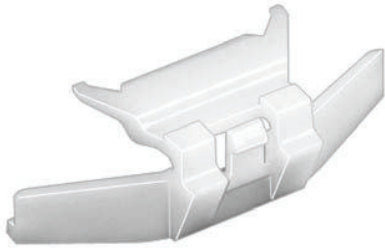

18765
(90612-SK7-003)
White Nylon

Windshield Side Moulding Clip
Integra
1993-90

UNIT PACKAGE: 10



19478
(91574-SV2-003)
Yellow Nylon

Windshield Moulding Clip
Acura 2.2CL, 2.3CL & 3.0CL
and Honda Accord
1994 - On

UNIT PACKAGE: 15



18760
(91514-SP1-003)
Red Nylon

Windshield Side Moulding Clip
Legend 2 Door
1991-On

UNIT PACKAGE: 5

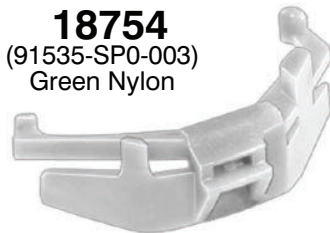

18754
(91535-SP0-003)
Green Nylon

Windshield Corner Moulding Clip
Legend 4 Door
1991-On

UNIT PACKAGE: 5



18768
(91526-SP0-003)
White Nylon

Windshield Side Moulding Clip
Legend 4 Door
1991-On

UNIT PACKAGE: 5



18767
(91526-SP1-003)
Blue Nylon

Windshield Side Moulding Clip
Legend 2 Door
1991-On

UNIT PACKAGE: 5



19476
(91577-SV4-003)
Red Nylon

Windshield Left-Hand Corner
Moulding Clip
Acura 2.2CL, 2.3CL & 3.0CL
and Honda Accord & Odyssey
1994 - On

UNIT PACKAGE: 10

18758
(91528-SP1-003)
Yellow Nylon

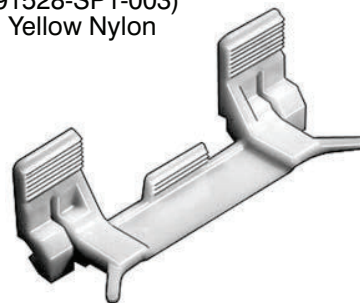

Windshield Side Moulding Clip
Legend 2 Door
1991-On

UNIT PACKAGE: 5



19477
(91576-SV4-003)
Green Nylon

Windshield Right-Hand Corner
Moulding Clip
Acura 2.2CL, 2.3CL & 3.0CL
and Honda Accord & Odyssey
1994 - On

UNIT PACKAGE: 10

Please Order In Unit
Package Quantities
Not Number Of
Pieces

Sec. 22

ACURA CLIPS & FASTENERS



18762

(91512-SP1-000)
Black Nylon

Windshield Upper Moulding Clip
Legend 2 Door
1991-On

UNIT PACKAGE: 5



18456

(90661-ST7-003)
Nylon

Bumper Clip
Integra
1994-On

UNIT PACKAGE: 5



17608

(91568-SL4-003)
Black Nylon

Windshield Side Moulding Clip
Vigor
1992-On

UNIT PACKAGE: 15



19479

(91561-SW5-003)
White Nylon

Windshield Moulding Clip
TL 2.5 & 3.2
1996 - On

UNIT PACKAGE: 15

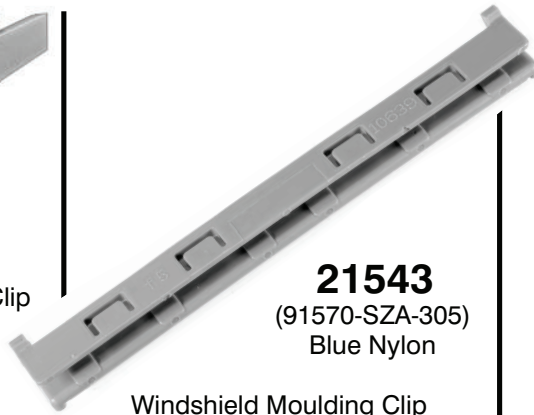

21543

(91570-SZA-305)
Blue Nylon

Windshield Moulding Clip
Width: 8mm
Length: 82mm
Acura ZDX and
Honda Odyssey & Pilot
2009 - On

UNIT PACKAGE: 5

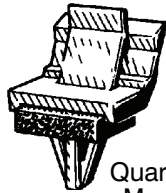

17268

(90676-SD2-003)
White Nylon

Quarter Window
Moulding Clip
Integra
1985-On

UNIT PACKAGE: 15



18236

(91537-SP0-013)
White Nylon

Windshield Clip
Legend
1991-On

UNIT PACKAGE: 10



19734

(90107-SX0-003)
Black Nylon

Bumper Grommet
#10 Screw Size
Head Size: 16mm x 18mm
Stem Length: 6mm
Acura 2.2CL, 2.3CL,
2.5TL, 3.2TL, 3.5RL
Honda Accord & Prelude
1996-On

UNIT PACKAGE: 15



21521

(90107-S0X-A01)
Black Nylon

Screw Grommet
M4.8 (#10) Screw Size
Head Size: 16mm x 16mm
Stem Length: 7mm
Acura CL, MDX, RL, 3.2 CL
& 3.5RI and Honda Accord,
Pilot, Ridgeline & S2000
1996 - On

UNIT PACKAGE: 25



19679

(91641-SH3-013)
Yellow Nylon
w/ Steel Insert

Garnish Moulding Grommet
Head Diameter: 14mm x 26mm
Acura Integra, Honda Civic
& Prelude
1988 - On

UNIT PACKAGE: 10



19465

(91652-SPO-003)
Natural Nylon

Center Pillar Garnish
Screw Grommet
#4 Screw Size
3.5 RL
1996 - On

UNIT PACKAGE: 15

Visit The Auveco
Web Site At
www.auveco.com For
The Latest Information
On New Items.



19463
(91651-SZ3-003)
Natural Nylon

Inner Front Door Lining
Sash Garnish Grommet
3.5RL
1996 - On

UNIT PACKAGE: 10



19723
(91503-SK7-013)
Saddle Tan Nylon

Center Pillar Moulding
Screw Grommet
#4 Screw Size
Head Size: 10mm x 14mm
Stem Length: 10mm
Integra
1994 - On

UNIT PACKAGE: 15



20954
(90682-SEA-003)
Black Nylon

Fender Apron Grommet
#8 (M4.2) Screw Size
Head Diameter: 20mm
Stem Length: 12mm
Fits Into 9mm Square Hole
Acura TSX and
Honda Civic & Odyssey
2004 - On

UNIT PACKAGE: 25



21209
(91601-STX-A00)
Gray Nylon

Rear Hatch
Screw Grommet
With Sealer
M3.5 (#6) Screw Size
Top Head Diameter: 12mm
Bottom Head Diameter: 14mm
Stem Length: 10mm
MDX
2009 - On

UNIT PACKAGE: 10



20472
(91512-SR3-004)
White Nylon

Tubular Nut
With Sealer & Sealed End
3mm Stud Size
Head Dia: 8.5mm
Fits Into 6mm Hole
Emblem Nut
Acura Integra and
Honda Accord, Civic,
CR-V & Prelude
1994 - On

UNIT PACKAGE: 10



18877
(91530-SP1-003)
Orange Nylon

Weatherstrip Retainer
Head Size: 5mm x 15mm
Stem Length: 10mm
Fits Into 6mm Hole
Acura 3.5 RL and
Accord, Civic & Odyssey
1992-On

UNIT PACKAGE: 25



18114
(91520-SM4-C010)
Black Nylon

Hood Insulation Retaining Clip
Head Diameter: 10mm
Stem Length: 10mm
Panel Thickness: 4mm
Fits Into 6mm Hole
Honda & Acura 1990-On

UNIT PACKAGE: 25



19506
(90666-SA7-003ZW)
Black Nylon

Trunk Lining Retainer
Head Diameter: 16mm
Stem Diameter: 5mm Square
Stem Length: 16mm
Acura 2.5TL, 3.2TL, 3.5,
Integra & Legend and
Honda Accord Wagon & Prelude
1987 - On

UNIT PACKAGE: 15



19467
(91501-SL4-003)
Black Nylon

Front Cowl Retaining Clip
Head Diameter: 13mm
Stem Diameter: 6mm
Stem Length: 10mm
3.5RL
1996 - On

UNIT PACKAGE: 25



19114
(91518-SM4-003)
Black Nylon

Hood & Trunk Moulding
Retaining Clip
Head Diameter: 12mm
Stem Length: 9mm
Fits Into 6mm Hole
Acura Integra & Honda Civic
1994-On

UNIT PACKAGE: 10



19483
(91515-SR3-000)
Black Nylon

Rear Hood Cowl
Weatherstrip Retaining Clip
Head Size: 8mm x 18mm
Stem Length: 15mm
Fits Into 7mm Hole
Acura Integra, Honda Civic, CR-V
And Del Sol
1992 - On

UNIT PACKAGE: 25



19746
(91652-SZ3-003)
White Nylon

Door Lining Retainer
Head Diameter: 10.5mm
Stem Length: 15mm
3.5RL
1996-On

UNIT PACKAGE: 10

Sec. 22**ACURA CLIPS & FASTENERS****18746**
(90700-SJ4-000)
Black Nylon

Hood Insulation Retainer
 Head Diameter: 30mm
 Stem Diameter: 15mm x 18mm
 Stem Length: 10mm
 Legend 1991-On
 Honda 1998-On
 UNIT PACKAGE: 15

**20609**
(91501-S1K-003)
Black Nylon

Hood Insulation Retainer
 Head Diameter: 30mm
 Stem Diameter: 15mm x 20mm
 Stem Length: 14mm
 Acura 3.5RL & RSX and
 Honda Civic & CR-V
 2000 - On
 UNIT PACKAGE: 25

**19464**
(90667-SD4-003)
Natural Nylon

Roof Lining Retainer
 Small Head Diameter: 13mm
 Large Head Diameter: 16mm
 Stem Diameter: 7mm
 Stem Length: 13mm
 NSX, 2.2CL & 2.3CL
 1991 - On
 UNIT PACKAGE: 15

**21107**
(90602-SX0-003)
White Nylon

Cowl Vent Retainer
 Top Head Diameter: 12mm
 Bottom Head Diameter: 16mm
 Stem Diameter: 4mm
 Stem Length: 13mm
 Acura MDX and Honda Civic,
 Insight, Odyssey & Prelude
 1995 - On
 UNIT PACKAGE: 10

**21417**
(90602-TA0-003)
Blue Nylon

Cowl Vent Retainer
 Top Head Size: 10mm x 14mm
 Bottom Head Diameter: 16mm
 Stem Diameter: 8mm
 Stem Length: 13mm
 Acura TSX & ZDX and
 Honda Accord & Fit
 2008 - On
 UNIT PACKAGE: 10

**19466**
(91560-SZ3-003)
White Nylon

Door Trim Panel Retainer
 Small Head Diameter: 13mm
 Large Head Diameter: 17mm
 Stem Diameter: 9.5mm
 Stem Length: 12mm
 3.5RL 1996 - On
 UNIT PACKAGE: 15

**19145**
(91560-SP0-003)
Gray Nylon

Front & Rear Door
 Trim Panel Retainer
 Small Head Dia: 13mm
 Large Head Dia: 17mm
 Stem Diameter: 9mm
 Stem Length: 12mm
 Acura Integra & Legend
 Honda Accord, Civic,
 Prelude, Odyssey & Del Sol
 1991-On
 UNIT PACKAGE: 25

**20411**
(91560-S84-A11)
Black Nylon

Windshield Garnish
 Pillar Retainer
 Top Head Dia: 13mm
 Middle Head Dia: 16mm
 Bottom Head Dia: 14.5mm
 Stem Diameter: 9.5mm
 Stem Length: 12mm
 Acura 3.2CL, Honda Accord,
 Insight & Odyssey
 1998 - On
 UNIT PACKAGE: 15

**20959**
(91560-S9A-A01)
Blue Nylon

Door Panel Retainer
 Top Head Diameter: 13mm
 Middle Head Diameter: 16mm
 Bottom Head Diameter: 15mm
 Stem Diameter: 9.5mm
 Stem Length: 13mm
 Acura TL & TSX and
 Honda Accord, Civic, CR-V
 & Odyssey
 2002 - On
 UNIT PACKAGE: 25

**21208**
(91560-SLJ-J01)
Gray Nylon

Door Trim Panel Retainer
 Top Head Diameter: 13mm
 Middle Head Diameter: 16mm
 Bottom Head Diameter: 18mm
 Stem Diameter: 9mm
 Stem Length: 12mm
 Acura RDX and
 Honda Civic, CR-V & Pilot
 2009 - On
 UNIT PACKAGE: 10

**21131**
(90602-SEP-A00)
Black Nylon

Trim Panel Retainer
 Top Head Diameter: 12mm
 Middle Head Diameter: 16mm
 Bottom Head Diameter: 18mm
 Stem Diameter: 9.5mm
 Stem Length: 13mm
 TL
 2007 - On
 UNIT PACKAGE: 15

ACURA CLIPS & FASTENERS

Sec. 22



21059
(90602-S5A-003)
Blue Nylon

Cowl Vent Retainer
Top Head Size: 12mm x 13mm
Middle Head Diameter: 16mm
Bottom Head Diameter: 18mm
Stem Diameter: 8.5mm x 8.5mm
Stem Length: 14mm
Acura RSX and
Honda Civic & CR-V
2001 - On
UNIT PACKAGE: 15



19233
(Acura: 91503-SZ3-003)
Black Nylon

Front Bumper Push-Type Retainer
Head Diameter: 20mm
Stem Length: 13mm
Fits Into 10mm Hole
Acura 3.5 RL Sedan & Honda
1996-On

UNIT PACKAGE: 15



20564
(91503-SZ5-003)
Black Nylon

Front & Rear Bumper
Push-Type Retainer
Head Diameter: 20mm
Stem Length: 18mm
Fits Into 10mm Hole
Acura 3.5RL and Honda Accord
& Odyssey
1996 - On

UNIT PACKAGE: 15



19186
(90657-SB0-003)
Black Nylon

Front Bumper Cover
Push-Type Retainer
Head Diameter: 11mm
Stem Length: 10mm
Fits Into 8mm Hole
Acura Legend, Honda Accord &
Odyssey
1991-On

UNIT PACKAGE: 10



19239
(Honda: 91512-SX0-003;
GM: 11519949; Mitsubishi:
MU000319)
Black Nylon

Front Fender Push-Type Retainer
Head Diameter: 20mm
Stem Length: 11mm
Fits Into 8mm Hole
Acura 3.5RL, Honda Accord,
Prelude & Odyssey 1994-On
GM 1997 - On
Mitsubishi Lancer 2002 - On

UNIT PACKAGE: 25

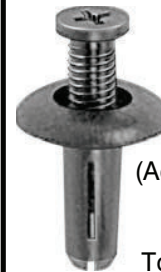

19140
(Acura: 90505-SL0-003;
GM: 94852368;
Mitsubishi: MB888869;
Toyota: 90467-08155)
Black Nylon

Push-Type Retainer
Head Diameter: 20mm
Stem Length: 21mm
Fits Into 8mm Hole
Acura, Dodge Avenger,
Eagle Talon, Geo Prizm,
Mitsubishi Eclipse & Galant
And Toyota
1993-On

UNIT PACKAGE: 5



19232
(91502-SZ5-003)
Black Nylon

Front Fender
Push-Type Retainer
Head Diameter: 17mm
Stem Length: 13mm
Fits Into 7mm Hole
3.5 RL Sedan
1996-On

UNIT PACKAGE: 10



21173
(91506-S9A-003)
Black Nylon

Bumper & Splash Shield
Push-Type Retainer
With Metal Insert
Head Diameter: 20mm
Stem Length: 16mm
Fits Into 10mm Hole
Acura MDX, RDX, TSX and
Honda Accord, Civic CR-V & Fit
2009 - 04

UNIT PACKAGE: 10



17267
(91503-SP0-003)
Black Nylon

Front & Rear Bumper
Push-Type Retainer
Head Diameter: 20mm
Stem Length: 15mm
Fits Into 10mm Hole
Legend
1991-On

UNIT PACKAGE: 15



19231
(91505-SL0-003)
Black Nylon

Push-Type Retainer
Head Diameter: 18mm
Stem Length: 16mm
Fits Into 8mm Hole
NSX
1991-On

UNIT PACKAGE: 15

ACURA & BMW CLIPS & FASTENERS



21170

(91591-SJ6-013)
Natural Nylon

Door Lock Rod Clip
Rod Size: 5mm
Fits Into 7mm Hole
Overall Height: 17mm
Acura TSX and Honda Accord,
Odyssey & Ridgeline
2003 – On

UNIT PACKAGE: 15



21388

(91558-SE3-003)
Black Nylon

Hood Release Cable,
Fuel Door Release Cable
and Sliding Door Lock
Cable Clip
Maximum Cable Diameter: 5mm
Overall Height In Closed
Position: 17mm
Fits Into 7mm Hole

Replaces Auveco #19672

Acura CL, Legend, NSX, RL,
TI, TL, TSX & Vigor and
Honda Accord, Civic, CR-V,
Insight, Odyssey, Pilot,
Prelude & Ridgeline
1991 – On

UNIT PACKAGE: 25



20380

(Not Supplied By O.E.M.)

Black Nylon
Cable Strap
Length: 200mm (8")
Max. Bundle Dia: 44mm (1-3/4")
Fits Into 6.3mm (1/4") Hole
Import Cars

UNIT PACKAGE: 25

BMW CLIPS & FASTENERS



13158

(5113-1-804-205)
Nylon

Moulding Clip
With Sealer

UNIT PACKAGE: 50



21423

(51321-938-884)
White Nylon

Window Regulator Guide
3 & 5 Series
1989 – On

UNIT PACKAGE: 2



13172

(5147-1-840-961)
Nylon

Plastic Plug

UNIT PACKAGE: 25



17279

(5131-1-938-494)
Nylon

Windshield Moulding Clip
7 Series
1987-On

UNIT PACKAGE: 15



20333

(51-71-8-108-613)
White Nylon

Cowl & Trunk Trim Clip
Head Size: 11mm x 14mm
Stem Length: 11mm
Fits Into 9mm Hole
Series 3, 5, 7, & 8
1989 - On

UNIT PACKAGE: 25



20255

(51-47-1-928-808)
White Nylon

Scuff Plate Retainer
Head Size: 11mm x 15mm
Overall Length: 29mm
Series 3, 5 & 7
1987 - On

UNIT PACKAGE: 25



21429

(51-13-1-960-054)
White Nylon With
Blue Rubber Boot

Moulding Clip
Width: 22mm
Length: 35mm
Stem Length: 11mm
BMW
1999 – 92

UNIT PACKAGE: 25



21430

(51-13-2-251-394)
White Nylon With
Blue Rubber Boot

Moulding Clip
Width: 18mm
Length: 30.5mm
Stem Length: 10mm
BMW
1999 – 92

UNIT PACKAGE: 25



21432

(51-13-8-166-675)
White Nylon With
Blue Rubber Boot

Moulding Clip
Width: 25.5mm
Length: 34mm
Stem Length: 11mm
BMW
2003 – 1995

UNIT PACKAGE: 25



17646

(51711-916-199)
Nylon

Headlight Cover Grommet
3, 5 & 7 Series
1984-On

UNIT PACKAGE: 25



13170

(5141-1-802-258)
Natural Nylon

Barrel Nut
For 7mm Stud
Fits Into 8mm Hole

UNIT PACKAGE: 50



20186

(51-14-1-807-495,
51-14-1-902-279)
Natural Nylon

Emblem Grommet
Head Diameter: 12mm
Stem Length: 8mm
Fits Into 6.8mm Hole
Series 3, 5, 6 & 7
2001 - 1986

UNIT PACKAGE: 15



20254

(51-13-8-124-389)
Black Plastic

Cowl Panel
Moulding Insert
Head Dia: 13mm
Stem Length: 11mm
Stem Diameter: 9mm
Use With Auveco 20388

Series 3 & 5
1989 - On

UNIT PACKAGE: 50



21499

(BMW: 51-44-7-780-135;
Mercedes-Benz: 108-988-00-27)
Natural Nylon

Tubular Nut
Stud Size: 7mm
Head Diameter: 16mm
Stem Length: 16mm
Fits Into 8.5mm Hole
BMW, Mercedes-Benz
& Universal

UNIT PACKAGE: 25



13167

(5121-6-442-159)
Nylon

Moulding Insert

UNIT PACKAGE: 25



13179

(BMW: 51-41-8-172-050;
VW: 481-867-197)
Black Nylon

Trim Panel Retainer
VW & BMW

UNIT PACKAGE: 50



20253

(51-41-1-973-500)
White Nylon

Trim Panel Retainer
Top Head Dia: 14mm
Middle Head Dia: 15mm
Bottom Head Dia: 18mm
Stem Dia: 9mm
Stem Length: 15mm
Series 3, 5 & 7
1987 - On

UNIT PACKAGE: 50

Sec. 22**BMW CLIPS & FASTENERS****21645**(Not Available
From O.E.M.)
Black NylonBumper & Wheel Opening
Push-Type Retainer
Head Diameter: 15mm
Stem Length: 15mm
Fits Into 6.3mm Hole
BMW
2004 - On

UNIT PACKAGE: 15

**20734**(51-11-1-944-537)
Black NylonBumper, Wheel Opening,
Scuff Plate & Interior Trim
Push-Type Retainer
Head Diameter: 20mm
Stem Length: 15mm
Fits Into 6.3mm Hole
Series 3, 5, 7 & X5
1989 - On

UNIT PACKAGE: 50



Not Actual Size

21305(Not Available From O.E.M.)
Natural NylonPush-Mount Cable Strap
Overall Length: 156mm (6-1/8")
Strap Width: 5mm (3/16")
Snaps Into 6.3mm (1/4") Hole
Maximum Bundle Diameter:
40mm (1-9/16")
European Makes & Universal

UNIT PACKAGE: 25

**20234**(51-11-1-908-077)
Black NylonScuff Plate
Push-Type Retainer
Head Diameter: 15mm
Stem Length: 15mm
Fits Into 6.3mm Hole
Series 3, 5, & 7
1984 - On

UNIT PACKAGE: 50

**20248**(51-11-8-174-185)
Black NylonBumper Trim
Push-Type Retainer
Head Diameter: 20mm
Stem Length: 17mm
Fits Into 6.3mm Hole
Series 3, 5 & 7
1995 - On

UNIT PACKAGE: 25

**21431**(BMW: 16-13-1-176-747;
Mercedes-Benz: 003-990-02-51)
Black NylonNylon Flange Nut
Stud Size: 5mm
10mm Hex
Flange Diameter: 16mm
Overall Height: 11mm
BMW & Mercedes-Benz
1997 - On

UNIT PACKAGE: 25

**20388**(51218-205-295)
Black NylonCowl Vent
Push-Type Retainer
Head Diameter: 20mm
Stem Length: 16mm
Use With Auveco 20254
Series 5
1997 - On

UNIT PACKAGE: 50

**16115**(5113-1-885-399)
Black NylonPush-Type Retainer
Head Size: 7mm x 15mm
Stem Length: 17mm
Fits Into 6mm x 6mm Hole

UNIT PACKAGE: 25

**13221**(0712-9-929-706)
Plated"U" Type Nut
2.9mm Screw Size
Panel Range: .5mm-1.5mm
Center of Hole To Edge: 6mm

UNIT PACKAGE: 50

**20270**(51-48-1-915-464,
51-48-1-938-725)

Black Nylon

Hood & Trunk Insulation
Push-Type Retainer
Head Dia: 20mm
Stem Length: 9mm
Fits Into 7mm Hole
Series 3, 5 & 7
2001 - 84

UNIT PACKAGE: 25

**20653**

Gray Nylon

Wire Routing Clip
Inside Diameter: 7mm x 10mm
Fits Into 6mm Hole
BMW & Mercedes

UNIT PACKAGE: 50

**13223**(BMW:0712-9-925-708;
Mercedes: 000-994-25-45)
Plated"U" Type Nut
4.2mm (#8) Screw Size
Panel Range: 3mm -4mm
Center of Hole to Edge: 7mm

UNIT PACKAGE: 50

BMW (Cont.)



13216
Zinc

“U” Type Nut
4.8mm (#10) Screw Size
Panel Range: .9mm -2mm
Center of Hole to Edge: 8mm
UNIT PACKAGE: 25



13218
(BMW: 0712-9-925-737;
Mercedes: 000-994-06-45)
Plated

“U” Type Nut
4.8mm (#10) Screw Size
Panel Range: .5mm-1.7mm
Center of Hole to Edge: 7mm
UNIT PACKAGE: 50



13215
(BMW: 0711-9-916-945;
Mercedes: 000-994-14-45)
Plated

“U” Type Nut
4.8mm (#10) Screw Size
Panel Range: .8mm -1.7mm
Center of Hole To Edge: 11mm
UNIT PACKAGE: 50



13162
(0712-9-925-720)
Plated
“U” Type Nut
5.6mm Screw Size
Panel Range: 1.2mm -2.0mm
Center of Hole To Edge: 10mm
UNIT PACKAGE: 50

FIAT



13198
(4-29-29-06)
Black Nylon

Interior Trim Retainer
Head Dia: 16mm (41/64")
Stem Dia: 9mm (11/32")
Stem Length: 18mm (11/16")

UNIT PACKAGE: 50

**GERMAN MADE
FORD CLIPS
& FASTENERS**

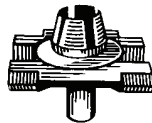

12639
Nylon
Body Side
Moulding Clip
w/Sealer

UNIT PACKAGE: 25

HONDA



17195
(Isuzu: 8942180270)
Black Nylon

Grille Clip
13mm Wide
22mm Long
Ford Escort, Honda,
Isuzu, Mitsubishi & Plymouth Laser

UNIT PACKAGE: 25

HONDA (Cont.)



18457
(91578-SV4-003)
Nylon

Radiator
Grille Clip
Accord
1994-On

UNIT PACKAGE: 5

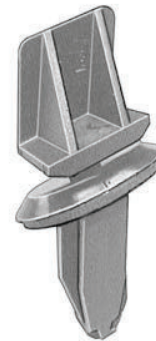

19439
(90116-S82-A01)
Nylon
Left Rear Bumper
Fascia Clip
Accord
1998-On

UNIT PACKAGE: 5

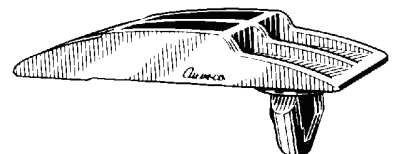

12576
(90665-SA0-9700)
Nylon

Side Protector Moulding Clip
20mm Wide
41mm Long
Snaps Into 8mm Hole

UNIT PACKAGE: 10

Sec. 22

HONDA CLIPS & FASTENERS



20603
(Honda:
71592-S5D-000)
White Nylon

Bumper Retainer
With Sealer
Head Size: 20mm x 23mm x 15mm
Stem Length: 22mm
2001 - On
UNIT PACKAGE: 15

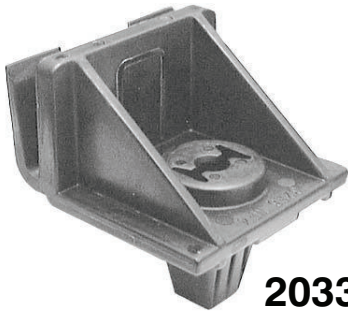

20331
(90108-SS0-003)
Black Nylon

Bumper Clip
35mm Wide, 38mm High
Use with #8 Screw
Accord
1998 - On
UNIT PACKAGE: 5



20677
(71598-S30-013)
Black Nylon

Rear Bumper Moulding Clip
With Sealer
Width: 34mm
Length: 30mm
Overall Height: 31mm
Accord
1998 - On
UNIT PACKAGE: 5

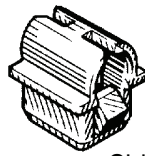

15997
(34355-SD2-003)
Nylon

Side Marker Clip
Accord
1986-On
UNIT PACKAGE: 25



21186
(75305-SHJ-003)
White Nylon

Front And Side Door
Exterior Trim
Moulding Clip
Width: 13mm
Length: 14mm
Height: 13mm
Odyssey
2005 - On
UNIT PACKAGE: 15



21207
(91513-SMG-E11)
White Nylon

Fender Moulding Clip
Top Head Size: 7mm x 7mm
Bottom Head Size: 10mm x 19mm
Stem Length: 6mm
CR-V
2009 - On
UNIT PACKAGE: 25



14306
(90675-692-0031)
Nylon

Body Side
Moulding Clip
18mm Wide 15mm Long
Snaps Into 10mm Hole
UNIT PACKAGE: 25



14308
(90679-692-0030)
Nylon

Body Side Moulding Clip
10mm Wide; 12mm Long
Snaps Into 10mm Hole
UNIT PACKAGE: 25



17443
(91534-SE0-000)
Nylon

Body Side Moulding Clip
Accord
1986-On
UNIT PACKAGE: 25



21470
(75306-SZA-A01)
White Nylon

Moulding Clip
Top Head Size: 7.5mm x 10mm
Bottom Head Size: 9.5mm
Overall Height: 16mm
Pilot
2009 - On
UNIT PACKAGE: 15



21557
(75316-S9A-004)
White Nylon

Door Trim Moulding Clip
Head Size: 14mm x 16mm
Stem Length: 12mm
Fits Into 10mm Hole
Acura RDX and Honda CR-V
2002 - On
UNIT PACKAGE: 25



21559
(91512-SJ6-J01)
Black Nylon

Rocker Panel, Tail Light &
License Plate Housing Garnish
Moulding Clip
With Sealer
Top Head Size: 9mm x 12mm
Bottom Head Diameter: 13mm
Stem Diameter: 7.5mm
Stem Length: 9mm
Acura TSX and
Honda Civic & CR-V
1997 - On
UNIT PACKAGE: 25

HONDA CLIPS & FASTENERS

Sec. 22



20602

(75306-SV1-A01)
White Nylon

Body Side Moulding Clip
Head Size: 14mm x 14mm
Stem Length: 14mm
Accord
1998 - On

UNIT PACKAGE: 25



20785

(75305-SH4-003)
Red Nylon

Body Side Moulding Clip
Head Size: 14mm x 15mm
Stem Length: 14mm
Civic
1996 - On

UNIT PACKAGE: 10



21555

(91512-S50-003)
White Nylon

License Plate Garnish & Trim
Moulding Clip
With Sealer
Top Head Size: 12mm x 17mm
Bottom Head Size: 16mm x 17mm
Stem Diameter: 13mm
Stem Length: 12mm
Acura TSX & ZDX and
Honda Accord, Civic, Crosstour,
Fit, Insight, Odyssey & Pilot
2001 - On

UNIT PACKAGE: 25



21556

(75305-SM4-A01)
White Nylon

Fender Trim
Moulding Clip
Head Size: 13mm x 15mm
Stem Length: 15mm
Accord & Civic
2000 - 1990

UNIT PACKAGE: 25



20784

(75305-SH2-003)
Blue Nylon

Body Side Moulding Clip
Head Size: 12mm x 15mm
Stem Length: 15mm
Civic & CR-V
1996 - On

UNIT PACKAGE: 10



21419

(91503-S3Y-003)
White Nylon

Rocker, Pillars, Floor
& Exterior Trim
Moulding Clip
With Sealer
Top Head Size: 11mm x 13mm
Bottom Head Size: 15.5mm x 19mm
Stem Diameter: 12mm
Stem Length: 19mm
Insight
2006 - On

UNIT PACKAGE: 10



21639

(72431-S2X-003)
White Nylon

Moulding Clip
Top Head Size: 8mm x 10.5mm
Bottom Head Size: 11mm x 16mm
Overall Height: 14.6mm
Acura RSX and
Honda Civic, CR-Z & Insight
2006 - 01

UNIT PACKAGE: 25



21109

(75329-SH4-013)
Red Nylon

Door Moulding Clip
Head Size: 10mm x 12mm
Stem Length: 13mm
Accord
1990 - On

UNIT PACKAGE: 15



20783

(75305-S0A-003)
White Nylon

Body Side Moulding Clip
Head Size: 6.5mm & 13mm x 18mm
Stem Length: 12mm
Civic, CR-V, Odyssey & Pilot
1999 - On

UNIT PACKAGE: 10



21308

(90602-SFA-004)
White Nylon

Cowl & Dash Moulding Clip
Top Head Size: 13mm x 14mm
Bottom Head Diameter: 16mm
Stem Length: 13mm
Acura RL and Honda Civic, Civic
Hybrid & Odyssey 2005 - On

UNIT PACKAGE: 25



21558

(91504-SP1-003)
White Nylon

Rocker Panel & Fender
Moulding Clip
With Sealer
Top Head Size: 16mm x 18mm
Bottom Head Size: 18mm x 20mm
Stem Length: 15mm
Fits Into 10mm Hole
Acura Legend, MDX, RL
& ZDX and Honda Civic,
CR-V & Odyssey
1991 - On

UNIT PACKAGE: 25

Sec. 22**HONDA CLIPS & FASTENERS****21636**
(71591-S5A-000)
White Nylon

Moulding Clip
With Sealer
Top Head Size: 13mm x 17mm
Bottom Head Size: 19mm x 22mm
Stem Length: 15mm
Civic
2005 – 2000

UNIT PACKAGE: 15

**21216**
(91502-S9A-003)
White Nylon

Front & Rear Bumper
Moulding Clip
With Sealer
Head Size: 14mm x 26mm
Stem Length: 15mm
Height: 28mm
CR-V
2002 – On

UNIT PACKAGE: 10

**17270**
(72413-SF1-0030)
Nylon

Moulding Clip
Prelude
1988-On

UNIT PACKAGE: 15

**19737**
(91515-SR4-003)
Red Nylon

Side Moulding Clip
Civic
1995 - 92

UNIT PACKAGE: 10

**17981**
(91510-SR3-003)
Nylon

Belt Moulding Clip
Civic
1992-On

UNIT PACKAGE: 10

**20272**
(91589-SV4-003)
Red Nylon

Belt Moulding Clip
Width: 20mm
Length: 24mm
Accord
1994 - On

UNIT PACKAGE: 25

**20737**
(91562-S84-A01)
Yellow Nylon

Belt Moulding Clip
Width: 20mm
Length: 27mm
Accord
1998 - On

UNIT PACKAGE: 10

**17442**
(90601-SH3-014)
Nylon

Door Belt Moulding Clip
Civic
1988-On

UNIT PACKAGE: 10

**21597**
(91519-SCV-A01)
Tan and Green
Nylon

Moulding Clip
Element
2003 – On

UNIT PACKAGE: 10

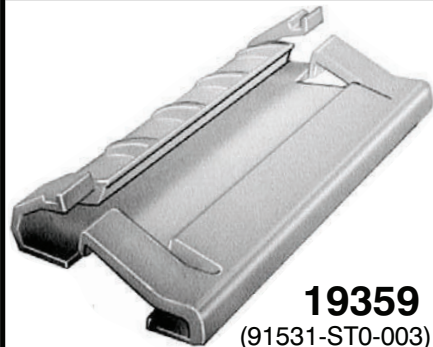
**19359**
(91531-ST0-003)
Nylon

Door Moulding Clip
Civic
2, 3 & 4 Door
1995-On

UNIT PACKAGE: 10

**19415**
(91527-SM4-003, 91527-SZ3-003,
91561-S84-A01)
White Nylon

Belt Moulding Clip
Accord & Odyssey
1990-On

UNIT PACKAGE: 10

HONDA CLIPS & FASTENERS

Sec. 22

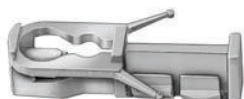

19740
(90666-SSO-003)
White Nylon

Roof Moulding Clip
Acura Integra & Legend
Prelude
1992 - On

UNIT PACKAGE: 10

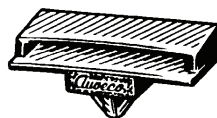

17082
(90610-SF1-003)
Nylon

Rear Pillar
Garnish Clip
11mm Wide x 25mm Long
Fits Into 6mm Hole
Prelude 1988-On

UNIT PACKAGE: 15



19477
(91576-SV4-003)
Green Nylon

Windshield Right-Hand Corner
Moulding Clip
Acura 2.2CL, 2.3CL & 3.0CL;
Honda Accord & Odyssey
1994-On

UNIT PACKAGE: 10



19680
(91501-SM5-A00)
Gray Nylon

Roof Moulding Clip
Odyssey
1995 - On

UNIT PACKAGE: 10



17089
(90605-SF1-003)
Nylon

Rear Pillar Garnish
Moulding Clip
11mm Wide, 25mm long
Prelude 1988-On

UNIT PACKAGE: 10



19513
(91519-SR3-003)
Green Nylon

Windshield Side Moulding Clip
Civic
1995 - 92

UNIT PACKAGE: 10



17096
(91513-SM4-000)
Nylon

Rocker Panel
Moulding Clip
20mm Wide
20mm Long
Fits Into 12mm Hole
Accord
1991-On

UNIT PACKAGE: 10



20782
(75306-SDA-A01)
White Nylon

Moulding Clip
Head Size: 21mm x 27mm
Stem Length: 11mm
Accord
2003 - On

UNIT PACKAGE: 10

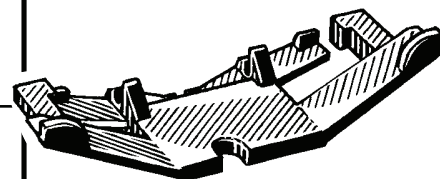

18405
(91562-SV4-003)
Yellow Nylon

Windshield Side Moulding Clip
Accord
1994-On

UNIT PACKAGE: 5

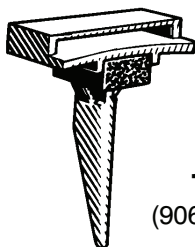

17320
(90612-AF1-003)
Nylon

Window Reveal
Moulding Clip
Upper Quarter Glass
Prelude
1988-On

UNIT PACKAGE: 15



19476
(91577-SV4-003)
Red Nylon

Windshield Left-Hand Corner
Moulding Clip
Acura 2.2CL, 2.3CL & 3.0CL;
Honda Accord & Odyssey
1994-On

UNIT PACKAGE: 10

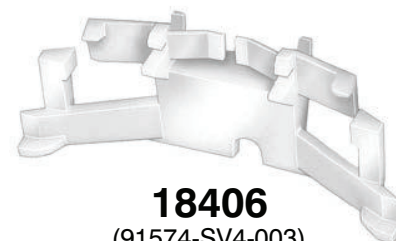

18406
(91574-SV4-003)
White Nylon

Windshield Side Moulding Clip
Accord
1994-On

UNIT PACKAGE: 5



18865

(91529-SS0-003)
Gray Nylon

Windshield Moulding Clip
Prelude
1992-On

UNIT PACKAGE: 15



12580

(90674-692-0030)
Black Nylon

Windshield Moulding Clip
34mm Long, 16mm Wide
Includes Adhesive
Mounting Pads

UNIT PACKAGE: 10

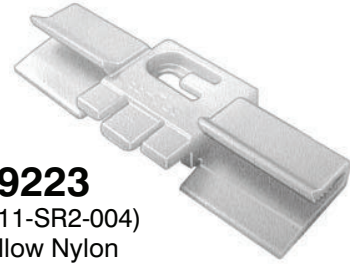

19223

(91511-SR2-004)
Yellow Nylon

Windshield
Side Moulding Clip
Del Sol
1993-On

UNIT PACKAGE: 10

Please Order
In Unit Package
Quantities Not
Number Of
Pieces

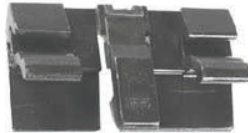

14701

(90658-SB0-0030)
Black Nylon

Windshield Moulding Clip
34mm Long, 17mm Wide
Includes Adhesive
Mounting Pads

UNIT PACKAGE: 10

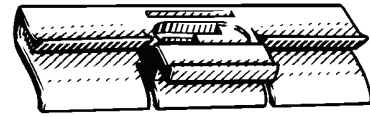

17285

(91525-SM4-003)
Pink Nylon

Windshield Side Moulding Clip
Accord 1990-On

UNIT PACKAGE: 15

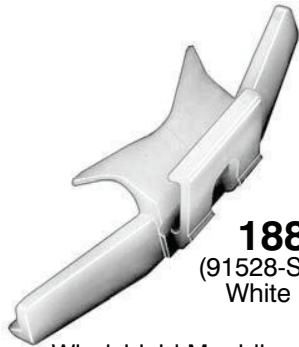

18866

(91528-SS0-003)
White Nylon

Windshield Moulding Clip
Prelude
1992-On

UNIT PACKAGE: 15



21095

(91570-SDA-A01)
Blue Nylon

Windshield Moulding Clip
Width: 15mm
Length: 76mm
Accord
2003 - On

UNIT PACKAGE: 10

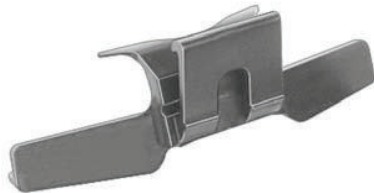

18864

(91530-SS0-003)
Black Nylon

Windshield Moulding Clip
Prelude
1992-On

UNIT PACKAGE: 15

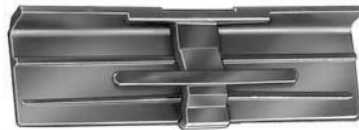

Not Actual Size

14685

(90683-SC6-0030;
90683-SA6-0030)
Gray Nylon

Windshield Moulding Clip
60mm Long, 14mm Wide
Includes Adhesive
Mounting Pads

UNIT PACKAGE: 10

FasTrack® Web
Auveco's Cost
Recovery System
For Repair Fasteners...
Never Lose Money On
Fasteners Again!

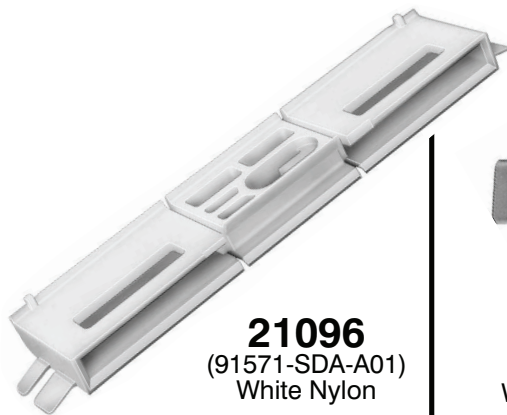

21096
(91571-SDA-A01)
White Nylon

Windshield Moulding Clip
Width: 16mm
Length: 75mm
Accord 2003 - On

UNIT PACKAGE: 10



20387
(91519-S5A-003)
Black Nylon

Windshield Moulding Clip
17mm Wide, 50mm Long
Upper Area Of Windshield
Civic Coupe
2001 - On

UNIT PACKAGE: 10



19670
(91541-SM4-003,
91542-SP0-003)
Aqua Nylon

Rear Window
Adjustable Moulding Clip
Accord
1990 - On

UNIT PACKAGE: 10

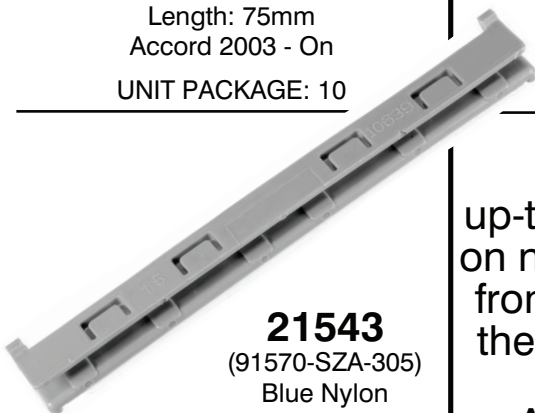

21543
(91570-SZA-305)
Blue Nylon

Windshield Moulding Clip
Width: 8mm
Length: 82mm
Acura ZDX and
Honda Odyssey & Pilot
2009 - On

UNIT PACKAGE: 5

For the most up-to-date information on new items available from Auveco, refer to the "Hot New Items" section fo the Auveco web site (www.auveco.com)

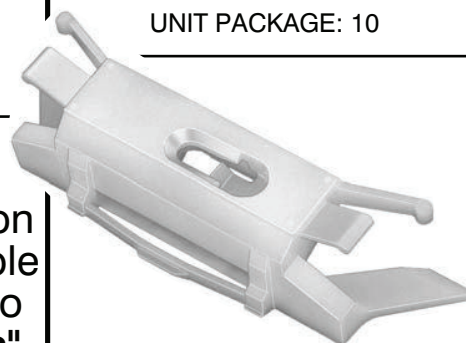

21094
(91572-SDA-A01)
White Nylon

Windshield Moulding Clip
Width: 14mm
Length: 62mm
Accord 2003 - On
Civic 2006 - On

UNIT PACKAGE: 10



20385
(91519-S5P-A01)
Blue Nylon

Windshield Moulding Clip
17mm Wide, 65mm Long
Upper Area Of Windshield
Civic Coupe
2001 - On

UNIT PACKAGE: 10



20386
(91520-S5A-003)
White Nylon

Windshield Moulding Clip
23mm Wide, 63mm Long
Lower Area Of Windshield
Civic Sedan
2001 - On

UNIT PACKAGE: 10

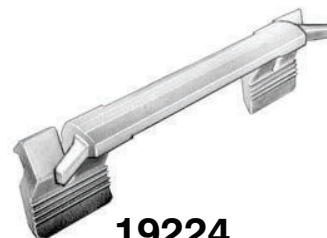

19224
(91572-SV2-003)
Natural Nylon

Windshield
Side Moulding Clip
Accord
1997-94

UNIT PACKAGE: 10



17475

(91520-SR3-003)
Red Nylon

Windshield Side Moulding Clip
Civic 1992-On

UNIT PACKAGE: 15

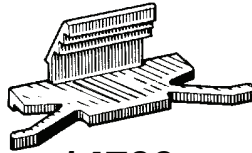

14700

(90672-SA6-0030)
Black Nylon

Windshield Moulding Clip
35mm Long
14mm Wide

UNIT PACKAGE: 25

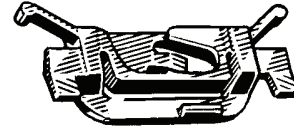

15474

(90674-SC6-003)
Black Nylon

Back Glass Moulding Clip
15mm Wide, 38mm Long
Accord
1984-On

UNIT PACKAGE: 15



18404

(91572-SV4-003)
Pink Nylon

Windshield Side Moulding Clip
Accord
1994-On

UNIT PACKAGE: 10

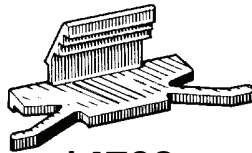

14703

(90673-SC6-0030)
White Nylon

Windshield Moulding Clip
35mm Long
14mm Wide

UNIT PACKAGE: 25



17280

(91505-SG0-003)
Orange Nylon

Windshield Moulding Clip
Honda Prelude and
Acura Legend 1988-On

UNIT PACKAGE: 10



15472

(90664-SB0-004)
Black Nylon

Windshield Moulding Clip
11mm Wide, 35mm Long
Honda
1983-On

UNIT PACKAGE: 15

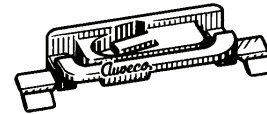

17281

(90694-SB0-003)
Black Nylon

Windshield Moulding Clip
Prelude
1983-On

UNIT PACKAGE: 15

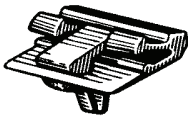

14705

(90713-SB0-003)
Black Nylon

Quarter Window
Moulding Clip
18mm Long
18mm Wide
Snaps Into 5mm Hole

UNIT PACKAGE: 25



17454

(74807-SB0-004)
Black Nylon

Rear Window Moulding Clip
1983-On

UNIT PACKAGE: 25



17282

(91534-SM4-003)
White Nylon

Windshield Moulding Clip
Accord 1990-On
Acura Legend 1991-On

UNIT PACKAGE: 10

All Items Are
Available In Bulk.
Call For A Quotation.



19115

(91528-S01-A01)
Blue Nylon

Drip Moulding Clip
4 Door Civic
1995-On

UNIT PACKAGE: 15

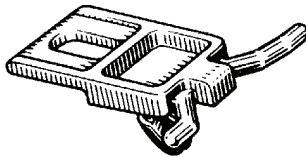

16825

(74806-SB6-003)
White Nylon

Back Glass Moulding Clip
33mm Wide, 30mm Long
Snaps Into 6mm Hole
Civic, Hatchback
1984-On

UNIT PACKAGE: 25



16861

(90664-692-0300)
Black Nylon

Windshield Reveal Moulding Clip
40mm Wide, 40mm Long
Prelude
1979-On

UNIT PACKAGE: 25

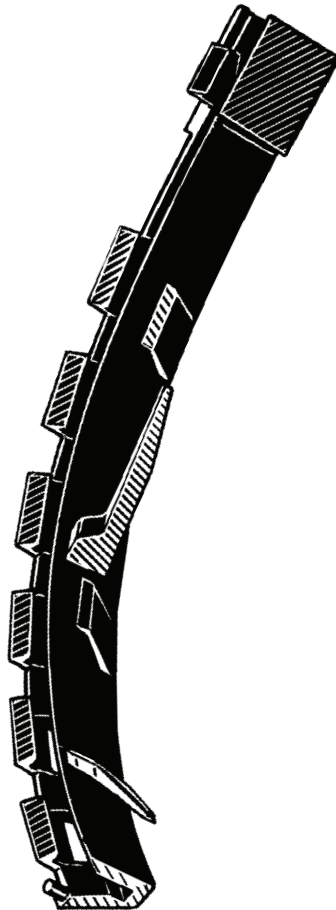

17488

(73156-SS0-004)

Window Moulding Clip
Left-Hand Corner
Prelude
1992-On

UNIT PACKAGE: 5



14288

(90655-SAO-0030)
Natural Nylon

#6 Screw Size
9.5mm Wide; 9.5mm Long
Snaps Into 6mm x 6mm Hole

UNIT PACKAGE: 50



14317

(34301-692A-0000)
White Nylon

#8 Screw Size
9.5mm Wide; 9.5mm Long
Snaps Into 6mm x 6mm Hole

UNIT PACKAGE: 50



14255

(Honda: 75522-611-0000;
Mazda: 9991-00-412;
Mitsubishi: MS-480001)
Black Nylon

#8 Screw Size
9.5mm Wide, 9.5mm Long
Snaps Into 7mm x 7mm Hole

UNIT PACKAGE: 50



20350

(90866-SAO-000)
Natural Nylon

Door Trim
Nylon Nut
#4 Screw Size
Head Size: 13mm x 13mm
Stem Length: 7mm
Civic
1998 - On

UNIT PACKAGE: 25



20351

(90666-SD9-000)
Natural Nylon

Nylon Nut
#14 (M6.3) Screw Size
Head Size: 16mm x 16mm
Stem Length: 8mm
CR-V
1997 - On

UNIT PACKAGE: 25

Sec. 22**HONDA CLIPS & FASTENERS****17058**(90676-SA7-003)
Natural NylonHeadlight Adjusting
Screw Nut
M5-.8 Screw Size
Prelude & Accord
1986-On

UNIT PACKAGE: 25

**14274**(Honda: 75521-611-0000;
Mazda: 9991-00-601;
Nissan: 96706-P0105
Toyota: 90189-06010)
Natural Nylon#10 Screw Size
13mm Wide, 13mm Long
Snaps Into 8.5mm x
8.5mm Hole

UNIT PACKAGE: 25

**17609**(91635-SM4-003)
Black NylonHeadlight To Grille
Spacer Bracket Grommet
#10 Screw Size
Accord
1990-On

UNIT PACKAGE: 10

**14287**(90656-671-6310M1)
Natural Nylon#14 (1/4") Screw Size
13mm Wide, 15mm Long
Snaps Into 8.5mm x 10.5mm Hole

UNIT PACKAGE: 50

**19117**(91619-SM4-003,
91619-SM4-0030)
Natural NylonCenter Pillar Garnish
Moulding (Oval) Screw Grommet
#4 Screw Size
Odyssey & Accord Wagon
1991-On

UNIT PACKAGE: 25

**20612**(90603-S7S-003)
Blue Nylon
With SealerCowl Vent Grommet
Flange Size: 10mm x 24mm
Stem Length: 6mm
Use With Auveco 20611
Accord
2003 - On

UNIT PACKAGE: 15

**14294**(90675-SA6-0030)
Natural NylonScrew Grommet
With Sealer
#6 Screw Size
15mm Wide, 15mm Long
Stem Length: 12mm
Snaps Into 7mm x 7mm Hole

UNIT PACKAGE: 15

**14313**(Honda: 90662-671-0030;
Mazda: 9991-00-503;
Nissan: 62698-V7000,
68425-H5000)
Natural Nylon#10 Screw Size
17mm Wide
17mm Long
Snaps Into 8mm x 8.5mm Hole
Also For Mazda & Nissan

UNIT PACKAGE: 25

**14280**(90681-693-0000)
Natural NylonScrew Grommet
#6 Screw Size
10mm Wide 17mm Long
Stem Length: 15mm
Fits Into 7mm x 13mm Hole

UNIT PACKAGE: 25

**14296**(90668-688-0030)
Natural NylonScrew Grommet
With Sealer
#6 Screw Size
11mm Wide, 14mm Long
Stem Length: 10mm
Snaps Into 7mm x 10mm Hole

UNIT PACKAGE: 25

**21635**(91603-SL0-000)
Natural NylonM4.8 (#10) Screw Size
Head Diameter: 16mm
Stem Length: 7mm
Fits Into 8mm x 8mm Hole
Insight
2006 - 2000

UNIT PACKAGE: 25

**14690**(Honda: 90683-693-0000;
Nissan: 78856-R4301)
White NylonScrew Grommet
#10 Screw Size
12mm Wide
19mm Long
Stem Length: 17mm
Fits Into 8mm x 15mm Hole

UNIT PACKAGE: 25

HONDA CLIPS & FASTENERS

Sec. 22



19679
(91641-SH3-013)
Yellow Nylon
w/ Steel Insert

Garnish Moulding Grommet
Head Diameter: 14mm x 26mm
Acura Integra, Honda Civic
& Prelude
1988 - On

UNIT PACKAGE: 10



19307
(91620-SR2-003)
Natural Nylon

Center Pillar
Screw Grommet
#4 Screw Size
Del Sol
1993-On

UNIT PACKAGE: 10



19646
(90665-SM4-000)
Yellow Nylon

Front Door
Screw Grommet
#6 Screw Size
Head Diameter: 14mm
Stem Length: 10mm
Fits Into 7mm x 7mm Hole
Prelude
1997 - On

UNIT PACKAGE: 15



14268
(Honda: 90672-671-8110M1;
Toyota: 90189-04013)
White Nylon

Screw Grommet
#6 Screw Size
Head Diameter: 14mm
Stem Length: 15mm
Fits Into 7mm x 7mm Hole

UNIT PACKAGE: 25



14281
(Honda: 90662-693-0030;
Toyota: 90189-04066)
White Nylon

Screw Grommet
#6 Screw Size
Head Diameter: 14mm
Stem Length: 10mm
Fits Into 7mm x 7mm Hole

UNIT PACKAGE: 25



19741
(90670-SG0-003,
91626-SH3-003)
Natural Nylon

Door Panel Screw Grommet
#8 (M4.2) Screw Size
Head Diameter: 12mm
Stem Length: 16mm
Fits Into 7mm x 7mm Hole
Civic & CR-V
1993-On

UNIT PACKAGE: 15



14695
(Honda: 90661-SC7-0030;
Mazda: H001-50-841;
Mitsubishi: MS-480012;
Nissan: 01651-00481, 74798-S9000;
Toyota: 90189-06042)
White Nylon

Screw Grommet
#8 (M4.2) Screw Size
Head Diameter: 16mm
Stem Length: 17mm
Fits Into 8mm x 8mm Hole

UNIT PACKAGE: 25



20303
(90664-SB3-003)
Natural Nylon

Trim Panel
Screw Grommet
#8 (M4.2) Screw Size
Head Diameter: 15mm
Stem Length: 15mm
Fits Into 8mm x 8mm Hole
Accord
1998 - On

UNIT PACKAGE: 10



20954
(90682-SEA-003)
Black Nylon

Fender Apron Screw Grommet
#8 (M4.2) Screw Size
Head Diameter: 20mm
Stem Length: 12mm
Fits Into 9mm Square Hole
Acura TSX and
Honda Civic & Odyssey
2004 - On

UNIT PACKAGE: 25



21205
(90682-SDA-A01)
Black Nylon

Rear Bumper
Screw Grommet
M4.8 (No. 10) Screw Size
Head Size: 14mm x 14mm
Stem Length: 14mm
Civic
2009 - On

UNIT PACKAGE: 15



19650
(90106-SW3-003)
White Nylon

Bumper Grommet
Head Size: 18mm x 20mm
Stem Length 19mm
Fits Into 8mm x 11mm Hole
Use With 19470
Accord, Odyssey
& Prelude
1995 - On

UNIT PACKAGE: 10



19143
(91623-SM2-0030)
Natural Nylon

Door Glass
Guide Grommet
#6 Screw Size
Prelude &
2 Door Accord
1990-On

UNIT PACKAGE: 10



19454
(90651-SL9-0130)
Gray Nylon

Rear Bumper Fascia
Grommet
#8 (M4.2) Screw Size
Accord
1996 - 94

UNIT PACKAGE: 15



19734
(90107-SX0-003)
Black Nylon

Bumper Grommet
#10 Screw Size
Acura 2.2CL, 2.3CL, 2.5TL,
3.2TL, & 3.5RL;
Honda Accord & Prelude
1996 - On

UNIT PACKAGE: 15



21521
(90107-S0X-A01)
Black Nylon

Screw Grommet
M4.8 (#10) Screw Size
Head Size: 16mm x 16mm
Stem Length: 7mm
Acura CL, MDX, RL,
3.2 CL & 3.5RI and
Honda Accord, Pilot,
Ridgeline & S2000
1996 - On

UNIT PACKAGE: 25



18415
(71144-SR3-A00)
Natural Nylon

Bumper Grommet
M4.2 (#8) Screw Size
Civic
1993-On

UNIT PACKAGE: 25



19533
(90107-S10-003)
Black Nylon

Wheel Well Moulding
Screw Grommet
#10 Screw Size
CR-V
1997 - On

UNIT PACKAGE: 25



20472
(91512-SR3-004)
White Nylon

Tubular Nut
With Sealer & Sealed End
3mm Stud Size
Head Dia: 8.5mm
Fits Into 6mm Hole
Emblem Nut
Acura Integra,
Honda Accord, Civic, CR-V
& Prelude
1994 - On

UNIT PACKAGE: 10



18115
(90676-SR4-003)
Nylon

Reveal Moulding
Pin Retainer
Civic
1993-On

UNIT PACKAGE: 15



14291
(66435-648-0000)
Black Nylon

Retaining Clip
Head Diameter: 11mm
Stem Length: 13mm
Snaps Into 5mm Hole
Panel Thickness: 5mm

UNIT PACKAGE: 50



14282
(90687-SA5-0030)
Black Nylon

Retaining Clip
Head Diameter: 13mm
Stem Length: 15mm
Snaps Into 5mm Hole
Panel Thickness: 4mm

UNIT PACKAGE: 50



18157
(90672-671-003)
Gray Nylon

Headliner & Cowl Grille
Retaining Clip
Head Diameter: 13mm
Stem Length: 16mm
Panel Thickness: 5mm
Fits Into 5mm Hole
Accord 1986-On

UNIT PACKAGE: 25

HONDA CLIPS & FASTENERS

Sec. 22



20381

(Honda: 90667-671-013ZA;
Mitsubishi: MC440901;
Nissan: 62660-48600-1)
Black Nylon

Trim Panel Retaining Clip
Head Diameter: 16mm
Stem Diameter: 7mm
Stem Length: 16mm
Honda, Mitsubishi & Nissan

UNIT PACKAGE: 25



20334

(90667-SOD-003ZC)
Black Nylon

Trunk Garnish Retainer
Head Dia: 18mm
Stem Dia: 7.5mm Sq.
Stem Length: 20mm
Civic
1998 - On

UNIT PACKAGE: 15



19506

(90666-SA7-003ZW)
Black Nylon

Trunk Lining Retainer
Head Diameter: 16mm
Stem Diameter: 5mm Square
Stem Length: 16mm
Acura 2.5TL, 3.2TL, 3.5,
Integra & Legend,
Honda Accord Wagon
& Prelude
1987 - On

UNIT PACKAGE: 15



20882

(91501-SEA-003)
Black Nylon

Cowl & Garnish Retainer
Head Diameter: 20mm
Stem Diameter: 7mm
Stem Length: 15mm
Civic
2006 - On

UNIT PACKAGE: 10



16781

(Honda: 90670-692-0030;
Toyota: 90467-09065)
Black Nylon

Retaining Clip
Head Dia: 15mm
Stem Length: 20mm
Panel Thickness: 11mm
Fits Into 7mm Hole

UNIT PACKAGE: 25



19744

(90669-SP0-003ZA)
Black Nylon

Trunk Trim Retainer
Head Diameter: 16mm
Stem Diameter: 6mm
Stem Length: 27mm
Civic
1998 - On

UNIT PACKAGE: 10



21303

(90671-SOD-003ZK)
Black Nylon

Trunk Lid &
Interior Trim Retainer
Head Diameter: 18mm
Stem Diameter: 7mm x 7mm
Stem Length: 13mm
Accord
2010 - On

UNIT PACKAGE: 25



14289

(90666-SAO-0030)
Black Nylon

Retainer
Head Diameter: 13mm
Stem Length: 16mm
Snaps Into 5mm Hole

UNIT PACKAGE: 25



16775

(Honda: 90667-SA7-0030;
Nissan: 89427-98070)
Black Nylon

Trim Panel Retainer
Head Dia: 20mm
Stem Length: 15mm
Fits Into 5mm Hole

UNIT PACKAGE: 25



19470

(90108-SW3-003)
Black Nylon

Bumper Retainer
Head Diameter: 16mm
Stem Diameter: 4mm
Stem Length: 21mm
Use With 19650
Accord, Odyssey & Prelude
1995-On

UNIT PACKAGE: 15



16776

(Honda: 90667-SAO-0030;
Nissan: 76996-01P02)
Black Nylon

Trim Panel Retainer
Head Dia: 18mm
Stem Length: 20mm
Fits Into 6mm Hole

UNIT PACKAGE: 25

Please E-Mail
Your New Item
Suggestions
To mail@auveco.com

Sec. 22**HONDA CLIPS & FASTENERS****15998**(90700-SB2-003)
Black NylonHood Insulation Retainer
Head Dia: 30mm
Stem Length: 9mm
Fits Into 6mm Hole
Honda Prelude 1985-On

UNIT PACKAGE: 15

**18114**(91520-SM4-C010)
Black NylonHood Insulation Retaining Clip
Head Diameter: 10mm
Stem Length: 10mm
Panel Thickness: 4mm
Fits Into 6mm Hole
Honda & Acura
1990-On

UNIT PACKAGE: 25

**14323**(38529-689A-6300)
Black NylonRetaining Clip
Head Diameter: 18mm
Stem Length: 15mm
Snaps Into 7mm Hole
Panel Thickness: 4mm

UNIT PACKAGE: 25

**18746**(90700-SJ4-000)
Black NylonHood Insulation Retainer
Head Diameter: 30mm
Stem Diameter: 15mm x 18mm
Stem Length: 10mm
Acura Legend 1991 - On
Honda 1998 - On

UNIT PACKAGE: 15

**19682**(91518-S10-003)
Black NylonHood Seal Retaining Clip
Head Diameter: 11mm
Stem Length: 8mm
Fits Into 6mm Hole
Odyssey
1999 - On

UNIT PACKAGE: 25

**16779**(Honda: 74842-659-0030;
Toyota: 90467-12078)
Black NylonRetaining Clip
Head Dia: 18mm
Stem Length: 15mm
Panel Thickness: 6mm
Fits Into 8mm Hole

UNIT PACKAGE: 25

**20609**(91501-S1K-003,
91501-STK-003)
Black NylonHood Insulation Retainer
Head Diameter: 30mm
Stem Diameter: 15mm x 20mm
Stem Length: 14mm
Acura 3.5RL & RSX And
Honda Civic & CR-V
2000 - On

UNIT PACKAGE: 25

**19114**(91518-SM4-003)
Black NylonHood & Trunk Moulding
Retaining Clip
Head Diameter: 12mm
Stem Length: 9mm
Fits Into 6mm Hole
Acura Integra & Honda Civic
1994 - On

UNIT PACKAGE: 10

**14319**(90687-671-0030)
Black NylonRetaining Clip
Head Diameter: 20mm
Stem Length: 20mm
Snaps Into 10mm Hole
Panel Thickness: 6mm

UNIT PACKAGE: 25

**21652**(91501-SWA-003)
Black NylonHood Insulation Retainer
Head Diameter: 30mm
Stem Diameter: 21mm
Stem Length: 14mm
Civic
2012 - On

UNIT PACKAGE: 25

**17205**(91501-SM4-003)
Black NylonCowl Top Retaining Clip
Head Dia: 14mm
Stem Length: 15mm
Fits Into 6mm Hole
Accord
1990-On

UNIT PACKAGE: 15

**20611**(90602-S7S-003)
Blue NylonCowl Vent Retainer
Top Head Diameter: 12mm
Bottom Head Diameter: 16mm
Stem Diameter: 3mm
Stem Length: 7mm
Use With Auveco 20612
Accord
2003 - On

UNIT PACKAGE: 25



21107
(90602-SX0-003)
White Nylon

Cowl Vent Retainer
Top Head Diameter: 12mm
Bottom Head Diameter: 16mm
Stem Diameter: 4mm
Stem Length: 13mm
Acura MDX, Honda Civic,
Insight, Odyssey & Prelude
1995 - On

UNIT PACKAGE: 10



21417
(90602-TA0-003)
Blue Nylon

Cowl Vent Retainer
Top Head Size: 10mm x 14mm
Bottom Head Diameter: 16mm
Stem Diameter: 8mm
Acura TSX & ZDX and Honda
Accord & Fit 2008 - On

UNIT PACKAGE: 10



19145
(91560-SP0-003)
Gray Nylon

Door Trim Panel Retainer
Small Head Dia: 13mm
Large Head Dia: 17mm
Stem Diameter: 9mm
Stem Length: 12mm
Acura & Honda Accord, Civic,
Prelude, Odyssey & Del Sol
1991-On

UNIT PACKAGE: 25



20411
(91560-S84-A11)
Black Nylon

Windshield Garnish
Pillar Retainer
Top Head Dia: 13mm
Middle Head Dia: 16mm
Bottom Head Dia: 14.5mm
Stem Diameter: 9.5mm
Stem Length: 12mm
Acura 3.2CL, Honda Accord,
Insight & Odyssey
1998 - On

UNIT PACKAGE: 15



21554
(91560-S7A-003)
Black Nylon

Trim Panel Retainer
With Sealer
Top Head Diameter: 13mm
Middle Head Diameter: 16mm
Bottom Head Diameter: 15mm
Stem Diameter: 9.5mm
Stem Length: 11mm
Crosstour, Fit & Odyssey
2010 - 05

UNIT PACKAGE: 25



21149
(91560-S84-A01)
White Nylon

Trim Panel Retainer
Top Head Diameter: 13mm
Middle Head Diameter: 16.5mm
Bottom Head Diameter: 15mm
Stem Diameter: 9.5mm
Stem Length: 11mm
Accord & Element
2003 - On

UNIT PACKAGE: 25



21638
(91560-S0X-A01)
White Nylon

Trim Panel Retainer
With Sealer
Top Head Diameter: 13mm
Middle Head Diameter: 16.5mm
Bottom Head Diameter: 15mm
Stem Diameter: 9.5mm
Stem Length: 11mm
Accord, CR-V, Fit & Odyssey
1999 - On

UNIT PACKAGE: 15



21208
(91560-SLJ-J01)
Gray Nylon

Door Trim Panel Retainer
Top Head Diameter: 13mm
Middle Head Diameter: 16mm
Bottom Head Diameter: 18mm
Stem Length: 12mm
Fits Into 8.5mm Hole
Acura RDX and Honda Civic,
CR-V & Pilot
2009 - On

UNIT PACKAGE: 10



21676
(91560-SZW-J01)
Dull Yellow Nylon

Windshield Moulding &
Interior Trim Retainer
Top Head Diameter: 13mm
Middle Head Diameter: 16mm
Bottom Head Diameter: 18mm
Stem Diameter: 9.5mm
Stem Length: 12mm
Civic
2012 - On

UNIT PACKAGE: 25



21675
(91560-SZW-003)
Green Nylon

Door Panel &
Interior Trim Retainer
Top Head Diameter: 13mm
Middle Head Diameter: 16mm
Bottom Head Diameter: 18mm
Stem Diameter: 9.5mm
Stem Length: 11mm
Civic
2012 - On

UNIT PACKAGE: 25



20959
(91560-S9A-A01)
Blue Nylon

Door Panel Retainer
Top Head Diameter: 13mm
Middle Head Diameter: 16mm
Bottom Head Diameter: 15mm
Stem Diameter: 9.5mm
Stem Length: 13mm
Acura TL & TSX and
Honda Accord, Civic, CR-V
& Odyssey
2002 - On

UNIT PACKAGE: 25



21087
(90602-SAA-003)
Orange Nylon

Cowl Vent &
Radiator Support Retainer
Top Head Diameter: 12mm
Middle Head Diameter: 16mm
Bottom Head Diameter: 18mm
Stem Diameter: 9.7mm
Stem Length: 14mm
Fit & CR-V
2003 - On

UNIT PACKAGE: 15



21206
(91560-S6A-003)
Orange Nylon

Rear Liftgate Retainer
Top Head Diameter: 13mm
Middle Head Diameter: 16mm
Bottom Head Diameter: 18mm
Stem Length: 14mm
Fits Into 8.5mm Hole
Fit
2009 - On

UNIT PACKAGE: 15



20610
(Honda:
91560-SM4-003)
White Nylon

Door Trim Panel Retainer
Top Head Diameter: 13mm
Middle Head Diameter: 18mm
Bottom Head Diameter: 16mm
Stem Diameter: 9mm
Stem Length: 15mm
Accord
1990 - On

UNIT PACKAGE: 25



18294
(91566-SP0-003)
White Nylon

Trim Panel Retainer
Small Head Dia: 13mm
Large Head Dia: 18mm
Stem Length: 14mm
Fits Into 9mm Hole
Honda 1990-On

UNIT PACKAGE: 15



21059
(90602-S5A-003)
Blue Nylon

Cowl Vent Retainer
Top Head: 12mm x 13mm
Middle Head Diameter: 16mm
Bottom Head Diameter: 18mm
Stem Diameter: 8.5mm x 8.5mm
Stem Length: 14mm
Acura RSX and
Honda Civic & CR-V
2001 - On

UNIT PACKAGE: 15

**Please Order
In Unit Package
Quantities Not
Pieces**



21141
(91561-SJD-003)
Black & White Nylon

Pillar, Rocker Panel &
Floor Retainer
Top Head Diameter: 15mm
Middle Head Diameter: 16mm
Bottom Head Diameter: 18mm
Stem Diameter: 8mm
Stem Length: 13mm
Civic & Pilot
2004 - On

UNIT PACKAGE: 10



21458
(91567-S3M-000)
Black Nylon

Weatherstrip Retainer
Head Diameter: 10mm
Stem Diameter: 5.5mm
Stem Length: 7mm
Accord, Civic & Odyssey
2003 - On

UNIT PACKAGE: 25



14299
(73862-672-0030)
White Nylon

Weatherstrip Retainer
7mm Wide
16mm Long
Stem Length: 5mm
Fits Into 5mm Hole
UNIT PACKAGE: 50



14328
(90664-671-0030)
White Nylon

Weatherstrip Retainer
7mm Wide
16mm Long
Stem Length: 10mm
Fits Into 5mm Hole
UNIT PACKAGE: 50

HONDA CLIPS & FASTENERS

Sec. 22



19673
(72311-S10-003)
Black Nylon

Weatherstrip Retainer
Head Size: 10mm x 15mm
Stem Diameter: 5mm
Stem Length: 10mm
CR-V
1997 - On

UNIT PACKAGE: 15



19171
(91568-SR2-003)
Green Nylon

Weatherstrip Retainer
Head Size: 5mm x 15mm
Stem Length: 10mm
Fits Into 5mm Hole
Odyssey
1995 - On

UNIT PACKAGE: 100



14290
(90692-SA5-0030)
Black Nylon

Niflock Rivet
Diameter: 5mm
Head Diameter: 12mm
Stem Length: 17mm

UNIT PACKAGE: 25



18818
(91513-SE0-003)
Natural Nylon

Hood Seal Retainer
Head Size: 7mm x 16mm
Stem Length: 12mm
Fits Into 5mm Hole
Accord & Prelude
1983-On

UNIT PACKAGE: 25



19683
(91502-S84-A11)
Black Nylon

Cowl Vent
Retaining Clip
Head Diameter: 6mm x 16mm
Stem Length: 14mm
Fits Into 6mm Hole
Odyssey
1999 - On

UNIT PACKAGE: 15



14293
(90674-SA5-0030)
Black Nylon

Niflock Rivet
Diameter: 6mm
Head Diameter: 11mm
Stem Length: 23mm

UNIT PACKAGE: 25



18877
(91530-SP1-003)
Red Nylon

Weatherstrip Retainer
Head Size: 5mm x 15mm
Stem Length: 10mm
Fits Into 6mm Hole
Acura 3.5 RL & Honda
Accord, Civic & Odyssey
1992-On

UNIT PACKAGE: 25



19483
(91515-SR3-000)
Black Nylon

Rear Hood Cowl
Weatherstrip Retaining Clip
Head Size: 8mm x 18mm
Stem Length: 15mm
Fits Into 7mm Hole
Acura Integra, Honda Civic,
CR-V & Del Sol
1992 - On

UNIT PACKAGE: 25



19186
(90657-SB0-003)
Black Nylon

Front Bumper Cover
Push-Type Retainer
Head Diameter: 11mm
Stem Length: 10mm
Fits Into 8mm Hole
Acura Legend, Honda Accord &
Odyssey
1991-On

UNIT PACKAGE: 10



19116
(91530-ST5-003)
Natural Nylon

Weatherstrip Retainer
Head Size: 5mm x 15mm
Stem Length: 10mm
Fits Into 6mm Hole
Front & Rear Doors
Civic
1995 - On

UNIT PACKAGE: 10

**Body Hardware
&
Specialty Fasteners
= Auveco**



19547
(91508-S50-003)
Black Nylon

Cowl Top Retainer
Head Diameter: 17mm
Stem Length: 13mm (Exc. Pin)
Fits Into 9mm Hole
Accord & Odyssey
1998 - On

UNIT PACKAGE: 5

Sec. 22**HONDA CLIPS & FASTENERS****18165**(91508-SR3-000)
Black NylonCowl Panel
Push-Type Retainer
Head Diameter: 17mm
Stem Length: 9mm
Fits Into 8mm Hole
Honda 1990-On

UNIT PACKAGE: 10

**19118**(91501-S04-003)
Black NylonFront Fender
Push-Type Retainer
Head Diameter: 20mm
Stem Length: 10mm
Fits Into 8mm Hole
Civic & Del Sol 1993-On

UNIT PACKAGE: 15

**20986**(91505-S9A-003)
Black NylonFront Bumper
Push-Type Retainer
With Internal Metal Insert
Head Diameter: 20mm
Stem Length: 13mm
Fits Into 10mm Hole
Civic 2006 - On

UNIT PACKAGE: 10

**20247**(Mitsubishi: MR200300)
Black NylonFender & Bumper
Push-Type Retainer
Head Diameter: 18mm
Stem Length: 12mm
Fits Into 9mm Hole
Honda & Mitsubishi
1998 - On

UNIT PACKAGE: 15

**21651**(91501-TR0-003)
Black NylonFender Push-Type Retainer
Head Diameter: 20mm
Stem Length: 10mm
Fits Into 8mm Hole
Civic
2012 - On

UNIT PACKAGE: 25

**19239**(Honda:
91512-SX0-003;
GM: 11519949
Mitsubishi: MU000319)
Black NylonFront Fender & Bumper Support
Push-Type Retainer
Head Diameter: 20mm
Stem Length: 11mm
Fits Into 8mm Hole
Acura, GM, Mitsubishi and
Honda Accord, Prelude & Odyssey
1994 - On

UNIT PACKAGE: 25

**17192**(91508-SM4-003)
Black NylonCowl Panel Push-Type Retainer
Head Dia: 18mm
Stem Length: 14mm
Fits Into 8mm Hole
Accord 1990-On

UNIT PACKAGE: 10

**21297**(91503-S7A-003)
Black NylonFront Bumper
Push-Type Retainer
Head Diameter: 20mm
Stem Length: 11mm
Fits Into 10mm Hole
Civic
2010 - On

UNIT PACKAGE: 15

**20608**(91503-S0K-A01)
Black NylonGrille Mounting
Push-Type Retainer
Head Diameter: 20mm
Stem Length: 14mm
Fits Into 10mm Hole
Element
2003 - On

UNIT PACKAGE: 15

**19453**(90505-SX0-003)
Black NylonGarnish Side Protector
Push-Type Retainer
Head Diameter: 18mm
Stem Length: 15mm
(Not Including The Pin)
Fits Into 8mm Hole
Odyssey
1995 - On

UNIT PACKAGE: 15

**19233**(Honda: 91503-SZ3-003;
Black NylonFront Bumper Push-Type Retainer
Head Diameter: 20mm
Stem Length: 13mm
Fits Into 10mm Hole
Acura 3.5 RL Sedan & Honda
1996-On

UNIT PACKAGE: 15

**21173**(91506-S9A-003)
Black NylonBumper & Splash Shield
Push-Type Retainer
With Metal Insert
Head Diameter: 20mm
Stem Length: 16mm
Fits Into 10mm Hole
Acura and Honda Accord, Civic,
CR-V & Fit 2009-04

UNIT PACKAGE: 10

HONDA CLIPS & FASTENERS

Sec. 22



20564

(91503-SZ5-003)
Black Nylon

Front & Rear Bumper
Push-Type Retainer
Head Diameter: 20mm
Stem Length: 18mm
Fits Into 10mm Hole
Acura 3.5RL And
Honda Accord & Odyssey
1996 - On

UNIT PACKAGE: 15



21190

(91550-S50-000ZL)
Black Nylon

Interior Trim
Push-Type Retainer
Head Diameter: 16mm
Stem Length: 14mm
Fits Into 7mm Hole
Civic, CR-V, Element & Insight
2006 - 2000

UNIT PACKAGE: 15



21477

(91550-S50-000ZK)
Gray Nylon

Push-Type Retainer
Head Diameter: 16mm
Stem Length: 14mm
Fits Into 7mm Hole
Civic, CR-V, Element & Insight
2006 - 2000

UNIT PACKAGE: 15



20910

(91505-ST7-003ZA)
Black Nylon

Door Panel
Push-Type Retainer
Head Diameter: 17mm
Stem Length: 12mm
Fits Into 8mm Hole
CR-V and S2000
2000 - On

UNIT PACKAGE: 10



19416

(Toyota: 90467-09139)
Black Nylon

Bumper Cover & Wheel Housing
Push-Type Retainer
Head Diameter: 18mm
Stem Length: 15mm
Fits Into 9mm Hole
Honda, Mazda 626 & Toyota Corolla
1992-On

UNIT PACKAGE: 15



16782

(Honda:
91545-SE0-0030-W1;
Nissan: 63848-01G00)
Black Nylon

Push-Type Retainer
Head Dia: 20mm
Stem Length: 14mm
Fits Into 8mm Hole

UNIT PACKAGE: 25



21454

(91503-SHJ-A01)
Black Nylon

Front Bumper
Push-Type Retainer
Head Diameter: 20mm
Stem Length: 13mm
Fits Into 10mm Hole
Odyssey
2005 - On

UNIT PACKAGE: 10



14286

(90673-692-0030)
Black Nylon

Push-Type Retainer
15mm Wide
20mm Long
Stem Length: 9mm
Fits Into 8mm x 11.5mm Hole

UNIT PACKAGE: 25



17287

(90687-SB0-003,
90687-SB0-013)
Black Nylon

Cowl Vent Panel Retainer
Head Dia: 13mm
Stem Length: 11mm
Fits Into 6mm Hole
Prelude 1983-On

UNIT PACKAGE: 25



14697

(GM: 94198687;
Honda: 90657-SA6-0030;
Mazda: N304-13-356-A)
Black Nylon

Push-Type Retainer
Head Dia: 14mm
Stem Length: 11mm
Fits Into 7mm Hole

UNIT PACKAGE: 25



14696

(Honda: 90684-SA5-003;
Isuzu: 8942981190;
Nissan: 10998-30880)
Black Nylon

Push-Type Retainer
Head Dia: 15mm
Stem Length: 11mm
Fits Into 6mm Hole

UNIT PACKAGE: 25

**Please Order In Unit
Package Quantities
Not Number Of Pieces**

Sec. 22**HONDA CLIPS & FASTENERS****19311**
(90683-SA5-003)
Black NylonFront Fender Skirt
Push-Type Retainer
Head Diameter: 15mm
Stem Length: 13mm
Fits Into 6mm Hole
Prelude
1996-92

UNIT PACKAGE: 15

**17081**
(91524-SE0-003)
Black NylonCowl Push-Type Retainer
Head Dia: 18mm
Stem Length: 12mm
Fits Into 6mm Hole
Accord 1986-On

UNIT PACKAGE: 25

**17379**
(91512-SM4-003)
Black NylonFender Splash Shield
Push-Type Retainer
Head Diameter: 20mm
Stem Length: 9mm
Fits Into 8mm Hole
Accord
1990-On

UNIT PACKAGE: 10

**19142**
(91550-SH3-003)
Black NylonPillar Garnish, Side And
Trunk Lining
Push-Type Retainer
Head Diameter: 15mm
Stem Length: 13mm
Fits Into 7mm Square Hole
Civic, Accord Wagon
& Del Sol
1993-On

UNIT PACKAGE: 5

**14698**
(90688-SB0-003)
Black NylonPush-Type
Retainer
Head Dia: 18mm
Stem Length: 11mm
Fits Into 6mm Hole

UNIT PACKAGE: 25

**17350**
(91516-SK7-013)
Black NylonSplash Shield
Push-Type Retainer
Phillips Drive
Head Dia: 20mm
Stem Length: 15mm
Fits Into 8mm Hole
10mm Hex
Civic
1992-On

UNIT PACKAGE: 10

**20352**
(91561-S84-A00-M1)
Black NylonRear Panel Assembly
Push-Type Retainer
Head Diameter: 16mm
Stem Length: 21mm
Fits Into 8mm Hole

UNIT PACKAGE: 10

**17057**
(90505-SM4-003)
Black NylonPush-Type Retainer
Head Dia: 18mm
Stem Length: 21mm
Fits Into 8mm Hole
Accord
1990-On

UNIT PACKAGE: 10

**17144**
(91504-SM4-000)
Black NylonPush-Type Retainer
Head Diameter: 20mm
Stem Length: 24mm
Fits Into 10mm Hole
Bumper Fascia
Accord
1990-On

UNIT PACKAGE: 10

**19546**
(91570-SK7-003ZF)
Black NylonTailgate Lining Retainer
Head Dia.: 17mm
Stem Length: 16mm
Fits Into 7mm Square Hole
Prelude
1997 - On

UNIT PACKAGE: 10

**16000**
(Honda: 90675-SB3-003;
Mazda: FB01-56-964;
Nissan: 63876-95596)
Black NylonPush-Type Retainer
Head Dia: 20mm
Stem Length: 9mm
Fits Into 8mm Hole

UNIT PACKAGE: 25

19408Same As 17144
Except for packing

UNIT PACKAGE: 50

HONDA CLIPS & FASTENERS

Sec. 22



18119
(91502-SP0-003)
Black Nylon

Front & Rear Bumper
Push-Type Retainer
Head Diameter: 20mm
Stem Length: 25mm
Fits Into 10mm Hole
Honda
1990-On

UNIT PACKAGE: 10



17143
(91502-SM4-000)
Black Nylon

Push-Type Retainer
Head Diameter: 20mm
Stem Length: 27mm
Fits Into 10mm Hole
Bumper Fascia
Accord
1990-On

UNIT PACKAGE: 10

19407

Same as 17143
Except for packing

UNIT PACKAGE: 50

Not Actual Size



20432
(91504-SR3-003)
Black Nylon

Windshield Washer Hose Clip
15mm Wide, 66mm Long
Holds 6.3mm (1/4") Hose
Accord, Civic,
CR-V & Del Sol
1993 - On

UNIT PACKAGE: 10

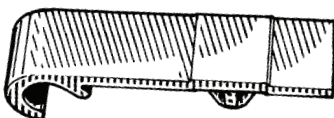

18512
(91512-SE0-003)
Gray Nylon

Windshield Washer Hose Clip
11mm Wide, 42mm Long
Holds 6.3mm (1/4") Hose
Accord
1986-On

UNIT PACKAGE: 15



16949
(90652-SB2-023)
Nylon

Windshield Washer
Hose Retainer
For 3mm (7/64") I.D.,
5mm (13/64") O.D. Hose
Fits Into 7mm (9/32")
Square Hole
Honda
1986-On

UNIT PACKAGE: 15



18454
(91604-SD2-013)
Nylon

Hood Prop Rod Grommet
Civic
1989-On

UNIT PACKAGE: 5



14688
(91547-SE0-0030)
Nylon

Hood Prop Rod Clip
Holds 6mm Prop Rod
Snaps Into 7mm Hole

UNIT PACKAGE: 25

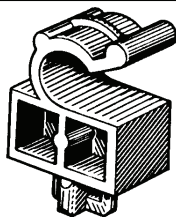

14687
(90677-671-0031)
Nylon

Hood Prop Rod Clip
Holds 8mm Prop Rod
Snaps Into 9mm x 9mm Hole

UNIT PACKAGE: 25

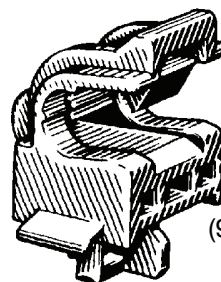

16950
(90677-SE0-003)
Nylon

Hood Prop Rod Clip
Holds 8mm Prop Rod
Accord
1986-On

UNIT PACKAGE: 5



19730
(90654-SA4-003)
Natural Nylon

Wire Routing Clip
Holds 6mm Diameter Wire
Fits Into 7mm Hole
Civic
1998 - On

UNIT PACKAGE: 15



21170
(91591-SJ6-013)
Natural Nylon

Door Lock Rod Clip
Rod Size: 5mm
Fits Into 7mm Hole
Overall Height: 17mm
Acura TSX and Honda Accord,
Odyssey & Ridgeline
2003 - On

UNIT PACKAGE: 15



21388
(91558-SE3-003)
Black Nylon

Sliding Door Lock and
Hood & Fuel Door Release
Cable Clip
Maximum Cable Diameter: 5mm
Closed Height Position: 17mm
Acura and Honda Accord, Civic,
CR-V, Insight, Odyssey, Pilot,
Prelude & Ridgeline
1991 - On

UNIT PACKAGE: 25

Not Actual Size



14284

(Honda: 90669-671-0000,
90669-671-0030;
Toyota: 90463-10337)
Nylon

Cable Strap
Length: 110mm (5-5/16")
Max. Bundle Dia.: 23mm
Fits Into 6mm Hole

UNIT PACKAGE: 15



Not Actual Size

20380

(Not Supplied
By O.E.M.)
Black Nylon

Cable Strap
Length: 200mm (8")
5mm (3/16") Wide
Max. Bundle Dia: 44mm (1-3/4")
Fits Into 6.3mm (1/4") Hole
Import Cars

UNIT PACKAGE: 25



20570

(Honda: 75307-SN7-000;
Mini-Cooper: 07-13-0-702-715)
Black Nylon

Nylon Moulding Nut
With Brass Insert
M4-0.7 Thread
12mm Flange O.D.
10mm Hex
Height: 11mm
1994 - On

UNIT PACKAGE: 15



Not Actual Size

14298

(Honda: 90672-SA0-0030;
Mazda: 9928-91-053)
Nylon

Releasable Cable Strap
Overall Length: 140mm (5-1/2")
Max. Bundle Dia: 30mm
Fits Into 7mm Hole

UNIT PACKAGE: 25



17289

(60658-SB3-000)
Nylon

Cowl Screen Screw Cover
Head Dia: 17mm
Fits Into 12mm Hole
Civic
1984-On

UNIT PACKAGE: 25



16470

(90212-SA5-003)
Zinc

M10-1.25
Hex Flange Nut
With Serrations
20mm Flange O.D.
14mm Hex
Class 10
Used On Honda
Exhaust Systems

UNIT PACKAGE: 25



13225

Plated

"U" Type Nut
4.2mm (#8) Screw Size
11mm Wide
16.5mm Long
Panel Range: .5mm-2.5mm
Center of Hole To Edge: 8mm

UNIT PACKAGE: 50

HYUNDAI



21038

(87719-3D000)
Natural Nylon

Body Side Moulding Clip
Small Head: 6mm x 14mm
Base Diameter: 14mm
Overall Height: 6mm
Elantra & Sonata
2004 - On

UNIT PACKAGE: 15



20566

(87756-3D000)
White Nylon

Body Side Moulding Clip
With Sealer
Head Size: 14mm x 14mm
Stem Length: 10mm
M4.2 (#8) Screw Size
Elantra & Sonata
2002 - On

UNIT PACKAGE: 15

When The World Thinks Of
Body Hardware &
Specialty Fasteners,
Only One Name Comes To
Mind... 



20567
(87756-38000)
Black Nylon

Body Side Moulding Clip
With Sealer
Small Head Size: 8mm x 9mm
Large Head Size: 14mm x 18mm
Stem Length: 10mm
Elantra & Sonata
2002 - On
Kia Rio
2010 - On

UNIT PACKAGE: 15



21312
(87756-2G000)
Black Nylon

Body Side
Moulding Clip
With Sealer
Head Size: 8mm x 22mm
Stem Length: 10mm
Hyundai Sonata and
Kia Magentis & Optima
2006 - On

UNIT PACKAGE: 15



21064
(87758-35000)
Yellow Nylon

Rocker Moulding Clip
With Sealer
Top Head Size: 10mm x 11mm
Bottom Head Size: 14mm x 19mm
Stem Length: 10mm
Accent, Santa Fe & Tiburon
1995 - On

UNIT PACKAGE: 15



20568
(87758-3D000)
Yellow Nylon

Rocker Panel Clip
With Sealer
Top Head Size: 16mm x 20mm
Bottom Head Size: 14mm x 18mm
Stem Length: 10mm
Elantra & Sonata
2002 - On

UNIT PACKAGE: 15



21244
(87702-H1000)
White Nylon

Rocker Moulding Clip
With Sealer
Top Head Size: 11mm x 15.5mm
Bottom Head Diameter: 16mm
Stem Length: 12mm
Hyundai Genesis & Sonata
and Kia Sorrento
2009 - On

UNIT PACKAGE: 15



21136
(87756-2E000)
White Nylon

Moulding Clip
With Sealer
Top Head Size: 10mm x 12mm
Bottom Head Diameter:
14mm x 20mm
Stem Length: 10mm
Hyundai Entourage, Tucson &
Veracruz and Kia Optima,
Sedona, Spectra & Sportage
2005 - On

UNIT PACKAGE: 15



21321
(87758-3L000)
Blue Nylon

Moulding Clip
With Sealer
Top Head Size: 16mm x 18mm
Bottom Head Diameter:
18mm x 20mm
Stem Length: 15mm
Hyundai Azera & Genesis
2009 - On

UNIT PACKAGE: 15



21150
(14913-05010)
White Nylon

Front & Rear Bumper
and Fender
Nylon Nut
M4.8 (#10) Screw Size
Head Size: 12mm x 12mm
Stem Length: 11mm
Hyundai Elantra, Sonata,
XG300 & XG350 and
Kia Magentis & Optima
1992 - On

UNIT PACKAGE: 25



21069
(92351-37000)
Natural Nylon

Headlight Assembly Grommet
Head Diameter: 15mm
Stem Length: 8mm
Fits Into 10mm Hole
XG300/350
2001 - On
Kia
2000 - On

UNIT PACKAGE: 25



21356
(Hyundai: 87714-FD200;
Kia: 87756-1C000)
White Nylon

Body Side Moulding
Nylon Nut
M4.2 (#8) Screw Size
Head Size: 13mm x 13mm
Stem Length: 10mm
Hyundai Veracruz and Kia Rio
2009 - On

UNIT PACKAGE: 15



21068

(86848-22000)
Black Nylon

Fender Apron Nylon Nut
M4.8 (#10) Screw Size
Head Diameter: 16mm
Stem Length: 11mm
Fits Into 8.5mm Square Hole
Accent, Elantra,
Sonata & Tiburon
1995 - On

UNIT PACKAGE: 25



21232

(86910-21010)
Natural Nylon

Bumper Screw Grommet
With Sealer
M4.8 (#10) Screw Size
Head Diameter: 18mm
Stem Length: 21mm
Azera
2009 - On

UNIT PACKAGE: 15



20543

(81126-37010)
Black Nylon

Hood Insulation Retainer
Head Diameter: 26mm
Stem Diameter: 12mm
Stem Length: 14mm
Hyundai Elantra & Sonata
And Kia Optima
1995 - On

UNIT PACKAGE: 15



21066

(87758-37000)
White Nylon

Fender & Rocker Moulding
Nylon Nut With Sealer
M4.2 (#8) Screw Size
Head Size: 17mm x 17mm
Stem Length: 14mm
Hyundai Accent & Sonata
1999 - On
Kia
2001 - On

UNIT PACKAGE: 25



21381

(86438-4A100)
Black Nylon

Hood Seal Retainer
Head Size: 5mm x 13mm
Stem Diameter: 8mm
Stem Length: 11mm
Hyundai Elantra & Tucson
and Kia Forte & Sportage
2009 - On

UNIT PACKAGE: 50



21070

(Hyundai: 82315-38000
GM: 94530565)
White Nylon

Trim Panel Retainer;
Top Head Diameter: 13mm
Middle Head Diameter: 16mm
Bottom Head Diameter: 16mm
Stem Diameter: 9.5mm
Stem Length: 10mm
Chevrolet 2004 - On
Hyundai Accent, Santa Fe, Sonata
Tiburon & XG300/350 1999 - On
and Kia 2001 - On

UNIT PACKAGE: 25



21292

(87759-27000)
Yellow Nylon

Rocker Moulding Grommet
With Sealer
M4.2 (#8) Screw Size
Head Size: 17mm x 25mm
Stem Length: 16mm
Accent, Genesis, Santa Fe,
Sonata, Tiburon & Veracruz
1995 - On

UNIT PACKAGE: 15



21382

(86434-4A000)
Black Nylon

Hood Seal Retainer
Head Size: 6mm x 16mm
Stem Diameter: 8mm
Stem Length: 14mm
Hyundai Elantra, Sonata &
Tucson and Kia Sportage
2009 - On

UNIT PACKAGE: 50



21360

(85849-3B000)
White Nylon

Headliner & Trim Panel Retainer
Top Head Diameter: 13mm
Middle Head Diameter: 16mm
Bottom Head Diameter: 16mm
Stem Diameter: 10mm
Stem Length: 12mm
Hyundai
2001 - On

UNIT PACKAGE: 25



21188
(82315-27000)
Pink Nylon

Trim Panel Retainer
Top Head Diameter: 15mm
Middle Head Diameter: 16mm
Bottom Head Diameter: 18mm
Stem Diameter: 10mm
Stem Length: 12mm
Hyundai and Ki
2003 – On
UNIT PACKAGE: 15



21233
(86157-37000)
Black Nylon

Hood Mounting
Push-Type Retainer
Head Diameter: 10mm
Stem Length: 13mm
Fits Into 5mm Hole
Azera
2009 – On
UNIT PACKAGE: 15



21328
(86155-2H100)
Black Nylon

Cowl & Bumper
Push-Type Retainer
Head Diameter: 15mm
Stem Length: 10mm
Fits Into 7mm Hole
Hyundai Genesis & Veracruz
and Kia Rio
2009 – On
UNIT PACKAGE: 15



17632
(Mazda: B092-51-833;
Ford: MB-455-56143,
W705845-S300;
Hyundai: 86590-28000)
Black Nylon

Push-Type Retainer
Head Diameter: 18mm
Stem Length: 12mm
Fits Into 8mm Hole
Hyundai, Mazda & Ford Aspire
UNIT PACKAGE: 10



Not Actual Size

21355
(Not Available From O.E.M.)
Black Nylon

Cable Strap
Overall Length: 160mm (6-3/8")
Strap Width: 5mm (3/16")
Maximum Bundle Diameter:
36mm (1-13/32")
Fits Into 7mm Hole
Hyundai & Universal
UNIT PACKAGE: 25

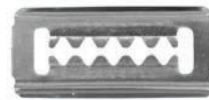

21067
(86593-24000)
Stainless Steel

Bumper & Grille Retainer
Width: 13mm
Length: 30mm
Accent, Santa Fe & Sonata
1995 - On
UNIT PACKAGE: 25



21378
(86825-28000)
Black Nylon

Nylon "U" Nut
M6 (#14) Screw Size
Panel Size: Up To 1.5mm
Center Of Hole To Edge: 8mm
Hyundai Accent & Elantra
and Kia
1995 – On
UNIT PACKAGE: 25

INFINITI



20961
(Not Available From O.E.M.)
White Nylon

Drip Moulding Clip
With Sealer
Top Width: 25mm
Overall Height: 16mm
Fits Into 5mm Hole
Infiniti M45, I30 & G35
2005 - On
Nissan Altima, Maxima
& 350Z
2002 - On
UNIT PACKAGE: 15



20886
(76882-6P000)
White Nylon

Moulding Clip
Top Head Size: 8mm x 15mm
Bottom Head Dia: 15mm
Stem Length: 9mm
Infiniti
2005 - On
UNIT PACKAGE: 25



21243
(Not Available From O.E.M.)
White Nylon

Moulding Clip
Head Diameter: 15mm
Stem Length: 14mm
Fits Into 9mm Hole
Infiniti
2006 – On
UNIT PACKAGE: 15

Sec. 22**INFINITI CLIPS & FASTENERS****21330**

(Not Available From
O.E.M.)
White Nylon

Body Side
Moulding Clip
Head Size: 18mm x 25mm
Overall Length: 29mm
Infiniti
2008 – On

UNIT PACKAGE: 15

**21147**

(85284-AD000)
White Nylon

Rear Bumper Clip
Height: 29mm
Width: 20mm
Length: 35mm
Infiniti G20, I30, I35, Q45 &
QX56 and Nissan 350Z, Altima,
Maxima & Murano
1999 – On

UNIT PACKAGE: 10

**21160**

(85284-7S610)
Black Nylon

Rear Bumper Retainer
With Sealer
Head Diameter: 12mm
Stem Length: 21mm
Overall Length: 35mm
Infiniti QX56 and Nissan
Armada & Pathfinder
2004 – On

UNIT PACKAGE: 15

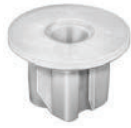
**20764**

(01281-00831)
Natural Nylon

Bumper, Fender & Light
Screw Grommet
M4.2 (#8) Screw Size
Head Diameter: 16mm
Stem Length: 10mm
Fits Into 9mm x 9mm Hole
Infiniti and Nissan 240SX,
Altima, Frontier, Maxima, Pathfinder,
Quest & Xterra
1989 - On

UNIT PACKAGE: 25

**20673**

(80874-0P000)
White Nylon

Cowl Vent Grommet
With Sealer
Head Size: 13mm x 13mm
Stem Length: 13mm
Use With Auveco 17633
Nissan & Infiniti
1997 - On

UNIT PACKAGE: 15

**21425**

(01281-01321)
Natural Nylon

Bumper Screw Grommet
M5.5 (#12) Screw Size
Overall Length: 22mm
Infiniti I30, I35 & Q45 and
Nissan Altima, Maxima & Quest
2009 – 1996

UNIT PACKAGE: 25

**21324**

(01281-00691)
Natural Nylon

Screw Grommet
With Sealer
M4.2 (#8) Screw Size
Head Diameter: 16mm
Stem Length: 20mm
Nissan 240SX, Altima, Frontier,
Maxima, Pathfinder & Titan and
Infiniti I30, I35 & Q45
1989 – On

UNIT PACKAGE: 15

**20604**

(01281-00711)
Natural Nylon

Rocker Moulding
Screw Grommet
M4.2 (#8) & #10 (M4.8) Screw Size
Head Diameter: 20mm
Stem Length: 15mm
Nissan & Infiniti
1995 - On

UNIT PACKAGE: 10

**21111**

(01281-00331)
Natural Nylon

Bumper, Rocker Panel
& Light Mounting
Screw Grommet
With Sealer
M6.3 (#14) Screw Size
Head Diameter: 20mm
Stem Length: 16mm
Fits Into 10mm Square Hole
Infiniti
1997 - On
Nissan
1996 - On

UNIT PACKAGE: 25

INFINITI CLIPS & FASTENERS

Sec. 22



20736
(01281-01081)
Natural Nylon

Front Bumper Nylon Nut
M4.8 (#10) Screw Size
Flange Diameter: 16mm
Overall Length: 22mm
Infiniti & Nissan
1997 - On

UNIT PACKAGE: 15



21229
(65810-K2000)
Black Nylon

Hood Sealer
Retaining Clip
Head Size: 6.4mm x 16mm
Stem Diameter: 3.5mm x 6mm
Stem Length: 10mm
Infiniti I30, I35, Q45 & QX4
and Nissan Maxima & Pathfinder
2004 - 1996

UNIT PACKAGE: 25



21519
(01553-01A50)
Black Nylon

Bumper & Trim Retainer
Head Diameter: 12mm
Stem Diameter: 6mm
Stem Length: 15mm
Infiniti FX35, G35, G37, M35,
M45 & Q45 and Nissan 350Z
& 370Z
1997 - On

UNIT PACKAGE: 25



19468
(65846-40F00)
Black Nylon

Hood Insulation Retainer
Head Diameter: 28mm
Stem Diameter: 6mm
Stem Length: 10mm
J30, M30 & Q45
1989-On

UNIT PACKAGE: 15



21414
(80999-VE000)
White Nylon

Trim Panel Retainer
With Sealer
Top Head Diameter: 13mm
Middle Head Diameter: 16mm
Bottom Head Diameter: 18mm
Stem Diameter: 9mm
Stem Length: 13mm
Infiniti and Nissan
1993 - On

UNIT PACKAGE: 25



20668
(01553-09791)
White Nylon

Trim Panel Retainer
Top Head Diameter: 13mm
Middle Head Diameter: 16mm
Bottom Head Diameter: 18mm
Stem Diameter: 9mm
Stem Length: 14mm
Nissan & Infiniti
1999 - On

UNIT PACKAGE: 15



21640
(84953-AU100)
Black Nylon

Door Trim Panel Retainer
With Sealer
Top Head Diameter: 13mm
Middle Head Diameter: 16mm
Bottom Head Diameter: 18mm
Stem Diameter: 9mm
Stem Length: 14mm
FX35, FX45, G35 & G37
2008 - 03

UNIT PACKAGE: 15



20669
(01553-07111)
Black Nylon

Trim Panel Retainer
Top Head Diameter: 13mm
Middle Head Diameter: 15mm
Bottom Head Diameter: 18mm
Stem Diameter: 9mm
Stem Length: 15mm
Nissan Altima and Infiniti
G35 & Q45
1997 - On

UNIT PACKAGE: 25



21633
(80850-89900)
White Nylon

Weather Retainer
Head Size: 6mm x 16mm
Stem Diameter: 6.5mm
Stem Length: 12mm
Infiniti I30, I35 & M45
and Nissan Maxima
2004 - 2000

UNIT PACKAGE: 25



21192
(01553-05323)
Black Nylon

Cowl, Bumper & Fender Liner
Push-Type Retainer
Head Diameter: 20mm
Stem Length: 12mm
Fits Into 8mm Hole
Infiniti FX35, FX45, G35
and Nissan
2003 - On

UNIT PACKAGE: 10

Sec. 22**INFINITI & ISUZU CLIPS & FASTENERS****INFINITI (Cont.)****20953**
(11296-AG000)
Black Nylon

Front Bumper And
Radiator Support
Push-Type Retainer
Head Diameter: 20mm
Stem Length: 13mm
Fits Into 8mm Hole
Infiniti FX 35/45 and
Nissan Altima, Maxima
& Quest
2002 - On

UNIT PACKAGE: 25

**21545**
(01553-08231)
Black Nylon

Front & Rear Bumper
and Grille
Push-Type Retainer
Head Diameter: 20mm
Stem Length: 15mm
Fits Into 8mm Hole
Infiniti FX35, FX45 & Q45
and Nissan Murano, 240SX
& 350Z
1995 - On

UNIT PACKAGE: 25

**21646**
(80874-AX000)
Black Nylon

Hole Plug
Head Diameter: 25mm
Fits Into 18mm Hole
Infiniti EX35 and Nissan Juke
& Murano
2003 - On

UNIT PACKAGE: 25

INFINITI (Cont.)**21637**
(01553-05131)
Black Nylon

Wheel Liner, Cowl Insulator
& Trim Flange Clip
Flange Diameter: 20mm
Hex: 10.5mm
Overall Height: 12.5mm
Infiniti EX35, FX35, FX50, G25,
G35, G37, J30, M35, M45 & Q45
and Nissan 370Z, Altima, Cube,
Frontier, GT-R, Juke, Leaf, Maxima,
Murano, NV, Pathfinder, Quest,
Rogue, Versa & Xterra
1993 - On

UNIT PACKAGE: 15

**21664**
(63848-9Y000)
Black Nylon

Fender Apron Clip
Width: 20mm
Width At Wings: 30mm
Overall Length: 30mm
Infiniti EX35, FX35, FX50, G35,
G37, M35, M37, M45 & M56
and Nissan Altima, Maxima,
Murano, Pathfinder, Quest & 370Z
2005 - On

UNIT PACKAGE: 10

**21017**
(76882-0M000)
White

Nylon "U" Nut
M4.8 (#10) Screw Size
Panel Range: Up To 1.5mm
Center of Hole To Edge: 8mm
Nissan & Infiniti
1995 - On

UNIT PACKAGE: 15

INFINITI (Cont.)**21459**
(01241-00881)
Black Nylon

Nylon "U" Nut
With Captive Metal Hex Nut
M6 - 1.0 Thread
Center Of Hole To Edge: 14mm
Panel Range: Up To 4mm
Nissan Altima, Maxima & 240SX
and Infiniti I30
2001 - 1993

UNIT PACKAGE: 10

ISUZU**17195**
(Isuzu: 8942180270)
Black Nylon

Grille Clip
13mm Wide 22mm Long
Ford Escort, Honda,
Isuzu, Mitsubishi & Plymouth Laser

UNIT PACKAGE: 25

**17355**
(GM: 94467458;
Isuzu: 8944674584)
Nylon

Windshield Reveal Moulding Clip
Isuzu and Geo Storm
1992-On

UNIT PACKAGE: 10

ISUZU (Cont.)	ISUZU (Cont.)	KIA (Cont.)
 <p>14739 (Isuzu: 8941340270; Toyota: 90189-05012) Natural Nylon</p> <p>#6 Screw Size 16mm Wide 12mm Long Snaps Into 6mm x 10mm Hole UNIT PACKAGE: 50</p>	 <p>17076 (GM: 94145515; Isuzu: 89414-55150)</p> <p>Inner Fender Shield & Bumper Fascia Retainer Head Dia: 18mm Stem Length: 23mm Stem Dia: 7mm Geo Storm & Isuzu 1990-On UNIT PACKAGE: 25</p>	 <p>21457 (86359-33500) White Nylon</p> <p>Front Bumper Moulding Clip Top Head Size: 10mm x 15mm Bottom Head Size: 16mm x 18mm Stem Length: 9mm Spectra 2009 - 04 UNIT PACKAGE: 25</p>
 <p>14269 (Isuzu: 8942264920; Mazda: 9927-40-825; Toyota: 67771-01010, 67771-12010) White Nylon</p> <p>Door Panel Retainer Top Head Diameter: 13mm Middle Head Diameter: 15.5mm Bottom Head Diameter: 18mm Stem Length: 14mm Overall Length: 20.5mm Stem Diameter: 9.5mm UNIT PACKAGE: 25</p>	 <p>20312 (GM: 15021761; Chry: 5027550AB) Yellow Nylon</p> <p>Hood Prop Rod Clip 7mm Rod Diameter Snaps Into 10mm Hole GM Cars & Trucks Chrysler PT Cruiser Isuzu Hombre 1990 - On UNIT PACKAGE: 10</p>	 <p>21363 (86591-25000) Black Nylon</p> <p>Bumper Cover Clip With Sealer Head Size: 25mm x 30mm Stem Length: 15mm Overall Length: 35mm Rio 2010 - On UNIT PACKAGE: 5</p>
 <p>14696 (Isuzu: 8942981190; Honda: 90684-SA5-003; Nissan: 10998-30880) Black Nylon</p> <p>Push-Type Retainer Head Diameter: 15mm Stem Length: 11mm Fits Into 6mm Hole UNIT PACKAGE: 25</p>	<h2>KIA</h2>	
 <p>14727 (Isuzu: 8942211500; GM: 94221150; Nissan: 63844-00100) Black Nylon</p> <p>Push-Type Retainer Head Size: 14mm x 22mm Stem Length: 9mm Fits Into 7mm Hole UNIT PACKAGE: 25</p>	 <p>21484 (87756-3E500) Red Nylon</p> <p>Wheel Flare & Body Side Moulding Clip With Sealer Top Head Size: 11mm x 13mm Bottom Head Size: 12mm x 20mm Stem Length: 10mm Forte Koup & Sorrento 2009 - On UNIT PACKAGE: 15</p>	 <p>21069 (92351-37000) Natural Nylon</p> <p>Headlight Assembly Grommet Head Diameter: 15mm Stem Length: 8mm Fits Into 10mm Hole Hyundai 2001 - On Kia Rio & Spectra 2000 - On UNIT PACKAGE: 25</p>



21371

(86699-2D000)
White Nylon

Front & Rear Bumper Cover
Nylon Nut
Head Size: 11mm x 11mm
Stem Length: 9mm
Overall Length: 13.5mm
Forte Koup
2010 - On

UNIT PACKAGE: 25



21066

(87758-37000)
White Nylon

Fender & Rocker Moulding
Nylon Nut With Sealer
M4.2 (#8) Screw Size
Head Size: 17mm x 17mm
Stem Length: 14mm
Hyundai 1999 - On
Kia Optima & Sorrento
2001 - On

UNIT PACKAGE: 25



20567

(87756-38000)
Black Nylon

Body Side Moulding Clip
With Sealer
Small Head Size: 8mm x 9mm
Large Head Size: 14mm x 18mm
Stem Length: 10mm
Elantra & Sonata
2002 - On
Kia Rio
2010 - On

UNIT PACKAGE: 15



21381

(86438-4A100)
Black Nylon

Hood Seal Retainer
Head Size: 5mm x 13mm
Stem Diameter: 8mm
Stem Length: 11mm
Hyundai Elantra & Tucson
and Kia Forte & Sportage
2009 - On

UNIT PACKAGE: 50



21382

(86434-4A000)
Black Nylon

Hood Sealer Retainer
Head Size: 6mm x 16mm
Stem Diameter: 8mm
Stem Length: 14mm
Hyundai Elantra, Sonata & Tucson
and Kia Sportage
2009 - On

UNIT PACKAGE: 50



21349

(85746-06000LX)
Gray Nylon

Headliner Retainer
Head Diameter: 18mm
Stem Diameter: 8mm
Stem Length: 16mm
Rio
2010 - On

UNIT PACKAGE: 25



21350

(85746-06000RU)
Tan Nylon

Headliner Retainer
Head Diameter: 18mm
Stem Diameter: 8mm
Stem Length: 16mm
Rio
2010 - On

UNIT PACKAGE: 25



20543

(81126-37010)
Black Nylon

Hood Insulation Retainer
Head Diameter: 26mm
Stem Diameter: 12mm
Stem Length: 14mm
Hyundai Elantra & Sonata
And Kia Optima
1995 - On

UNIT PACKAGE: 15



21070

(Hyundai: 82315-38000)
GM: 94530565)
White Nylon

Trim Panel Retainer
Top Head Diameter: 13mm
Middle Head Diameter: 16mm
Bottom Head Diameter: 16mm
Stem Diameter: 9.5mm
Stem Length: 10mm
Chevrolet 2004 - On
Hyundai 1999 - On
and Kia Optima, Rio &
Sorento 2001 - On

UNIT PACKAGE: 25



21188

(82315-27000)
Pink Nylon

Trim Panel Retainer
Top Head Diameter: 15mm
Middle Head Diameter: 16mm
Bottom Head Diameter: 18mm
Stem Diameter: 10mm
Stem Length: 12mm
Hyundai & Kia
2003 - On

UNIT PACKAGE: 15



21146
(OG032-50037-A)
Black Nylon

Bumper, Render, Grille, Interior & Exterior Trim and Pillar
Push-Type Retainer
Head Diameter: 18mm
Stem Length: 12mm
Fits Into 8mm Hole
Amanti, Magentis, Optima, Rio, Sedona, Sephia, Sorrento, Spectra & Sportage
2000 – On

UNIT PACKAGE: 15



16858
(Kia: MNA01-56-145;
Mazda: NA01-56-145;
Nissan: 63844-01A00;
Ford: MNA01-56145,
NA01-56145)
Black Nylon

Inner Fender Push-Type Retainer
Head Dia: 20mm (25/32")
Stem Length: 18mm (23/32")
Fits Into 8mm (5/16") Hole
Kia, Ford, Mazda & Nissan

UNIT PACKAGE: 25



21372
(OK95A-68615)
Black Nylon

Cowl Trim Retainer
Flange Diameter: 25mm
Hex Size: 14mm
Overall Height: 10mm
Forte Koup
2010 – On

UNIT PACKAGE: 25



21378
(86825-28000)
Black Nylon

Nylon "U" Nut
M6 (#14) Screw Size
Panel Range: Up To 1.5mm
Center Of Hole To Edge: 8mm
Hyundai Accent & Elantra
and Kia
1995 – On

UNIT PACKAGE: 25

LAND ROVER



21657
(DYC101420)
White & Yellow Nylon

Moulding Clip
Top Head Diameter: 12.5mm
Middle Head Diameter: 15mm
Bottom Head Diameter: 15mm
Stem Diameter: 10.2mm
Stem Length: 8mm
Land Rover, Freelander
& Range Rover
2002 – On

UNIT PACKAGE: 25

LEXUS



21546
(90467-09204)
White Nylon

Rear Hatch Door Side Garnish
and Front Body Pillar Garnish
Moulding Clip
Overall Height: 14mm
Lexus GS 300, GS 400, GS 430,
GX 470, RX 330, RX 350, RX 400
& RX 450 and Toyota Camry,
Highlander, Prius & Sienna
1998 – On

UNIT PACKAGE: 25



21549
(90467-12080)
Pink Nylon

Door Trim, Instrument Panel,
Rear Deck Trim & Roof Garnish Trim
Moulding Clip
Overall Height: 21mm
Lexus ES 350, GX 460, RX 330 &
RX 450h and Toyota Avalon, Camry,
Corolla, Echo, FJ Cruiser,
Highlander, Matrix, Prius, RAV 4,
Sequoia, Sienna, Tacoma, Tundra,
Venza, Yaris & 4-Runner
2000 – On

UNIT PACKAGE: 25



19492
(75039-33040)

Front Fender
Moulding Clip
ES300
1991 - On

UNIT PACKAGE: 5

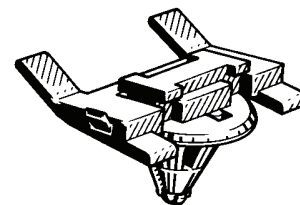

17989
(75049-33010)
Black Nylon

Side Moulding Retainer
Lexus
1990-On

UNIT PACKAGE: 5



19899
(75397-48010)
Red Nylon

Moulding Clip
ES300 & RX300
1999 - On

UNIT PACKAGE: 15



20877
(75392-60030,
75392-60031)
Gray Nylon

Rocker Panel Moulding Clip
Head Diameter: 18mm
Overall Length: 19mm
Lexus
2000 - On

UNIT PACKAGE: 15



21537
(90467-10190)
Black Nylon

Grille Clip
Top Head Size: 10mm x 10mm
Bottom Head Diameter: 15mm
Stem Diameter: 10mm
Stem Length: 10mm
RX 330, RX 350 & RX 400
1999 - On

UNIT PACKAGE: 25



20661
(75397-33010)
White Nylon

Body Side Moulding Clip
With Sealer
Head Size: 16mm x 20mm
Stem Length: 9mm
Lexus ES300
1997 - On

UNIT PACKAGE: 10



21314
(75393-60030)
Black Nylon

Moulding Clip
Head Diameter: 18mm
Overall Length: 24.5mm
Lexus
2000 - On

UNIT PACKAGE: 15



19120
(75039-33060)
Brown & White
Nylon

Door Lower Moulding Clip
ES300
1991-On

UNIT PACKAGE: 10



20605
(75397-48030)
Orange Nylon

Moulding Clip
With Sealer
Head Size: 15mm x 20mm
Stem Length: 15mm
Lexus
1999 - On

UNIT PACKAGE: 10



20875
(75394-60060)
Yellow Nylon

Fender Moulding Clip
With Sealer
Head Diameter: 18mm
Stem Length: 20mm
Lexus
2000 - On

UNIT PACKAGE: 10



19482
(75039-33010)
Brown & White Nylon

Front Door
Outside Moulding Clip
ES300
1991-On

UNIT PACKAGE: 5



19900
(75395-33030)
Pink Nylon

Moulding Clip
ES300 & RX300
1999 - On

UNIT PACKAGE: 15



20876
(75492-60030)
Gray Nylon

Fender Moulding Clip
With Sealer
Head Diameter: 18mm
Stem Length: 20mm
Lexus
2000 - On

UNIT PACKAGE: 10



19776
(75545-24030)
White Nylon

Windshield Moulding Clip
SC300 & SC400
1992 - On

UNIT PACKAGE: 10

LEXUS CLIPS & FASTENERS

Sec. 22



21505
(75545-53011)
Blue Nylon

Windshield Moulding Clip
Width: 15mm
Length: 55mm
GX 460, IS250/350, IS F
2006 – On

UNIT PACKAGE: 5



21255
(75545-53010)
Blue Nylon

Windshield Clip
Width: 15mm
Length: 55mm
ES250 & IS250
2008 – On

UNIT PACKAGE: 10



20738
(53271-44010)
Black Nylon

Headlight Bracket Clip
25mm Wide, 40.5mm Long
Lexus IS-300 and Toyota
Camry & RAV 4
2001 - On

UNIT PACKAGE: 4



19783
(Ford: N811169-S,
W705550-S300;
Toyota: 90075-10801,
90189-06111)
White Nylon

Head Diameter: 13mm
Stem Length: 9mm
Fits Into 11mm Hole
Ford, Lexus & Toyota

UNIT PACKAGE: 50



19742
(90189-06104)
Natural Nylon

Fender Lining
Screw Grommet
#12 (M5.5) Screw Size
Head Diameter: 18mm
Stem Length: 15mm
Fits Into A 9mm Square Hole
Lexus IS300 And Toyota
Avalon, Camry & Sienna
1997 - On

UNIT PACKAGE: 15



21151
(90189-04059)
White Nylon

Rocker, Pillar, Floor &
Exterior Trim
Screw Grommet
M3.5 (#6) Screw Size
Head Size: 12mm x 18mm
Stem Length: 7mm
Lexus ES300, ES330, RX330,
RX400, SC300, SC400 and
Toyota Scion, Avalon & FJ Cruiser
1992 – On

UNIT PACKAGE: 25



21625
(90189-06145)
Black Nylon

Fender Lining
Screw Grommet
M5.5 (#12) Screw Size
Head Diameter: 16mm
Stem Length: 16mm
Fits Into 9mm x 9mm Hole
Lexus CT 200h and
Toyota Prius, Sequoia & T-100
1993 – On

UNIT PACKAGE: 15



21544
(90189-04102)
White Nylon

Screw Grommet
With Sealer
M3.2 (#6) Screw Size
Head Size: 10mm x 10mm
Stem Length: 15mm
Fits Into 7mm Square Hole
Lexus IS 250, IS 350 & IS F
and Toyota Highlander
2006 – On

UNIT PACKAGE: 25



21605
(90189-A0002)
Black Nylon

Screw Grommet
M5.5 (#12) Screw Size
Head Diameter: 20mm
Stem Length: 17mm
Fits Into 9mm x 9mm Hole
Lexus GX460, GX470 & LX570
and Toyota Avalon, Corolla,
FJ Cruiser, RAV4, Sienna,
Tacoma & 4-Runner
1995 - On

UNIT PACKAGE: 25

Sec. 22**LEXUS CLIPS & FASTENERS****14273**(90189-06005)
White NylonScrew Grommet
#14 (1/4") or M6.3-1.81 Screw Size
Head Diameter: 18mm
Stem Length: 16mm
Fits Into 8mm x 8mm Hole
Lexus & Toyota

UNIT PACKAGE: 50

**14267**(90189-06013)
Black NylonScrew Grommet
#14 (1/4") or M6.3-1.81 Screw Size
Head Diameter: 20mm
Stem Length: 17mm
Fits Into 8mm x 8mm Hole
Lexus & Toyota

UNIT PACKAGE: 25

**21084**(52599-0E010)
Black NylonRear Bumper Grommet
With Sealer
Head Diameter: 21mm
Shoulder Diameter: 13mm
Stem Length: 27mm
RX 330, RX 350
& RX 400h
2004 - On

UNIT PACKAGE: 10

**20660**(90901-89004)
Yellow NylonBumper Screw Grommet
With Sealer
M6.3 (#14) Screw Size
Head Size: 16.5mm x 18mm
Stem Length: 25mm
Lexus GS300 & GS400
1998 - On

UNIT PACKAGE: 10

**21015**(52535-50060,
52535-0E010)
Black NylonFront Bumper
Screw Grommet
M5.5 - M6 (#12) Screw Size
Head Size: 17mm x 30mm
Stem Length: 9mm
Lexus IS250, IS350,
RX330 & RX350 and
Toyota Camry, Highlander
& Tacoma
2001 - On

UNIT PACKAGE: 5

**21583**(52535-30150)
White NylonFront & Rear Bumper
Screw Grommet
M5.5 (#12) Screw Size
Head Size: 17.5mm x 30mm
Stem Length: 10mm
Lexus ES300, 330, 350, LS430
& RX300 and Toyota Avalon,
Sequoia & Tundra
1999 - On

UNIT PACKAGE: 25

**19534**(90467-10152)
Natural NylonCowl Vent Grommet
Flange Diameter: 18mm
Stem Length: 16mm
Fits Into 9mm Hole
Use With Auveco 19535
Lexus ES300, Toyota Camry
& Tercel
1995 - On

UNIT PACKAGE: 10

**19535**(90467-07126)
Black NylonCowl Vent Pin Retainer
Head Diameter: 16mm
Stem Length: 17mm
Use With Auveco 19534
Lexus ES300, Toyota Camry
& Tercel
1995 - On

UNIT PACKAGE: 10

**20758**(53879-58010)
Black NylonFront Fender & Bumper
Cover Clip
Width: 25mm
Length: 34mm
Use With Auveco 20757
Lexus and Toyota 4 Runner,
Highlander, Sienna & Solara
2000 - On

UNIT PACKAGE: 5

**21358**(53879-50020)
Black NylonBumper Cover Clip
Width: 35mm
Length: 25mm
Use With Auveco 21357
GS, IS & LS
2007 - On

UNIT PACKAGE: 10

LEXUS CLIPS & FASTENERS

Sec. 22



20757

(47749-58010)
Black Nylon

Front Fender & Bumper
Cover Pin Retainer
Head Diameter: 15mm
Stem Length: 25mm
Use With Auveco 20758
Lexus and Toyota 4 Runner,
Highlander, Sienna & Solara
2000 - On

UNIT PACKAGE: 10



21357

(47749-50090)
Black Nylon

Bumper Cover Pin Retainer
Head Diameter: 10mm
Stem Length: 24mm
Use With Auveco 21358
GS, IS & LS
2007 - On

UNIT PACKAGE: 15



20878

(90467-A0008)
Black Nylon

Bumper Cover Retainer
Head Diameter: 19mm
Stem Diameter: 7.5mm
Stem Length: 16mm
Lexus, Toyota & Scion
1995 - On

UNIT PACKAGE: 50



20874

(90467-07049-CO)
Black Nylon

Trim Panel Retainer
Head Diameter: 25mm
Stem Diameter: 7mm
Stem Length: 23mm
Lexus
2000 - On

UNIT PACKAGE: 25



18297

(Toyota: 90467-08004,
90467-08011)
(GM: 94842841, 94849113)
Black Nylon

Hood Seal Retaining Clip
Head Diameter: 13mm
Stem Length: 11mm
Fits Into 6mm Hole
Lexus, Toyota, Geo Prizm & Nova
1985 - On

UNIT PACKAGE: 50



21643

(90467-08101)
Black Nylon

Hood To Cowl Top Seal
Retaining Clip
Head Size: 7mm x 13mm
Stem Diameter: 7.5mm
Stem Length: 13mm
Lexus ES 300 and Toyota Camry,
Sequoia, Solara & Tundra
2006 - 1997

UNIT PACKAGE: 25



17990

(90467-09138)
Black Nylon

Retaining Clip
Head Size: 14mm x 15mm
Stem Length: 19mm
Fits Into 7mm Hole
Lexus 1990-On

UNIT PACKAGE: 5



21634

(90467-10186)
Black Nylon

Dash & Fender Apron
Seal Retainer
Head Diameter: 16.5mm
Stem Diameter: 9mm
Stem Length: 13mm
Lexus GX 460, GX 470 & LX 470
and Toyota 4 Runner, FJ Cruiser,
Land Cruiser, RAV4, Sequoia &
Tundra
1996 - On

UNIT PACKAGE: 25



19113

(90467-08124)
Black Nylon

Hood Insulation Retainer
Head Diameter: 25mm
Stem Diameter: 8mm
Stem Length: 12mm
Toyota Supra 1993-On
Lexus 1994-89

UNIT PACKAGE: 15



19729

(90467-09050)
Black Nylon

Hood Insulation Retainer
Head Diameter: 25mm
Stem Length: 10mm
Fits Into 7mm Hole
Lexus, Toyota Camry & Solara
1998-On

UNIT PACKAGE: 15



21627

(67868-30030)
Black Nylon

Door & Roof Rail Retainer
Head Diameter: 9mm
Stem Diameter: 5.3mm
Stem Length: 8mm
Lexus HS 250h, IS 250, IS 350,
RX 350 & 450h
2006 - On
Toyota Camry, Corolla, Corona
& Land Cruiser
1999 - 74

UNIT PACKAGE: 25



21548

(67869-20030)
Black Nylon

Weatherstrip Retainer
Head Diameter: 10mm
Stem Diameter: 6mm
Stem Length: 10mm
Lexus IS 300 & SC 430 and Toyota
Camry, Celica, Corolla, Highlander,
Matrix, MR-2, Prius, RAV-4, Scion,
Solara & Supra
1990 - On

UNIT PACKAGE: 25



21552

(90467-04034)
White Nylon

Weatherstrip Retainer
Top Head Size: 5mm x 15mm
Bottom Head Diameter: 9mm
Stem Diameter: 6.5mm
Stem Length: 4mm
Lexus CT 200h, HS 250h, IS F,
IS 250, IS 350, LS 460, LS 600h,
RX 350, RX 400h & RX 450h and
Toyota Avalon, Corolla, Highlander,
Matrix, Prius, RAV-4, Scion & Venza
2003 - On

UNIT PACKAGE: 25



20473

(67771-12070)
White Nylon

Door Panel &
Rocker Moulding Retainer
With Sealer
Top Head Diameter: 13mm
Bottom Head Diameter: 18mm
Stem Diameter: 11mm
Stem Length: 14mm
Lexus SC300/400
Toyota Avalon & Corolla
1992 - On

UNIT PACKAGE: 15



20559

(GM: 88970345;
Toyota: 90467-10167)
Blue Nylon

Garnish Moulding Retainer
Top Head Diameter: 13mm
Middle Head Diameter: 16mm
Bottom Head Diameter: 18mm
Stem Diameter: 9mm x 9mm
Stem Length: 11mm
Pontiac Vibe, Lexus and Toyota
2000 - On

UNIT PACKAGE: 25



17991

(90467-06092)
White Nylon

Retaining Clip
Head Size: 8mm x 17mm
Stem Length: 14mm
Fits Into 8mm Hole
Lexus
1990-On

UNIT PACKAGE: 10



20558

(62217-13010)
White Nylon

Garnish Moulding Retainer
Top Head Diameter: 13mm
Middle Head Diameter: 16mm
Bottom Head Diameter: 15mm
Stem Diameter: 10mm
Stem Length: 11mm
Lexus and Toyota Corolla,
Matrix & 4 Runner
2003 - On

UNIT PACKAGE: 25



21102

(90467-A0005)
White Nylon

Door Trim Panel Retainer
With Sealer
Top Head Diameter: 13mm
Middle Head Diameter: 16mm
Bottom Head Diameter: 18mm
Stem Diameter: 8.5mm
Stem Length: 14mm
Lexus ES 350, GX 470, IS 250, IS
350, IS F, LS 460 & LS 600HL and
Toyota Camry, FJ Cruiser,
Highlander, RAV4 & 4-Runner
2001 - On

UNIT PACKAGE: 15



21012

(75867-AA010)
Black Nylon

Rocker Panel &
Scuff Plate Retainer
Top Head Diameter: 13mm
Bottom Head Diameter: 18mm
Stem Diameter: 9.5mm
Stem Length: 14mm
Lexus ES300 & ES330
2002 - On
Toyota Avalon, Camry,
Scion & Solara
2004 - On

UNIT PACKAGE: 25



20575

(67771-12080)

Yellow & White Nylon
Door Panel & Rocker
Moulding Retainer
Top Head Diameter: 13mm
Middle Head Diameter: 16mm
Bottom Head Diameter: 18mm
Stem Diameter: 10mm
Stem Length: 13mm
Overall Length: 20mm
Toyota & Lexus
1998 - On

UNIT PACKAGE: 15



19257

(67771-12050)
Maroon Nylon

Front & Rear Door
Trim Board Retainer
Small Head Diameter: 13mm
Large Head Diameter: 18mm
Stem Diameter: 9mm
Stem Length: 14mm
Lexus and Toyota Celica,
Corolla & Previa
1990-On

UNIT PACKAGE: 15

LEXUS CLIPS & FASTENERS

Sec. 22



17439

(90467-09093)
Black Nylon

Bumper Cover
Push-Type Retainer
Head Diameter: 15mm
Stem Length: 27mm
Fits Into 9mm Hole
LS-400

UNIT PACKAGE: 10



17988

(90467-09143)
Black Nylon

Push-Type Retainer
Head Diameter: 19mm
Stem Length: 26mm
Fits Into 9mm Hole
Lexus
1990-On

UNIT PACKAGE: 10



18270

(90467-07117)
Black Nylon

Push-Type Retainer
Head Dia: 17mm
Stem Length: 9mm
Fits Into 7mm Hole
Lexus
1990-On

UNIT PACKAGE: 10



21624

(90467-10206)
Black Nylon

Cowl Push-Type Retainer
Head Diameter: 16mm
Stem Length: 10mm
Fits Into 8mm Hole
Lexus ES 350, RX 350 &
RX 450h and Toyota Camry,
Sequoia, Tundra & Yaris
2006 - On

UNIT PACKAGE: 15



20577

(GM: 88970494;
Toyota: 90467-07168)
Black Nylon

Rocker Panel & Garnish Moulding
Push-Type Retainer
Head Diameter: 20mm
Stem Length: 8mm
Fits Into 7mm Hole
Pontiac Vibe 2004 - 2003
Lexus & Toyota
2000 - On

UNIT PACKAGE: 15



20869

(GM: 88970767;
Toyota: 90467-10183)
Black Nylon

Front Fender Liner
Push-Type Retainer
Head Diameter: 18mm
Stem Length: 7.5mm
Fits Into 7mm Hole
Lexus, Pontiac Vibe, and Toyota
Celica, Corolla,
Matrix & Solara
1999 - On

UNIT PACKAGE: 10



17992

(90467-07138)
Black Nylon

Push-Type Retainer
Head Diameter: 20mm
Stem Length: 12mm
Fits Into 7mm Hole
Lexus
1990-On

UNIT PACKAGE: 10



18939

(90467-09101)
Black Nylon

Bumper Cover
Push-Type Retainer
Head Diameter: 18mm
Stem Length: 23mm
Fits Into 9mm Hole
ES300
1993-On

UNIT PACKAGE: 25



19219

(90467-09096)
Black Nylon

Front Bumper
Push-Type Retainer
Head Diameter: 15mm
Stem Length: 27mm
Fits Into 9mm Hole
LS400 1993-On
Toyota Celica & Supra
1989-On

UNIT PACKAGE: 10



20349

(Toyota: 90467-08185;
Nissan: 01553-09611)
Black Nylon

Push-Type Retainer
Head Diameter: 18mm
Stem Length: 10mm
(Not Including The Pin)
Fits Into 8mm Hole
Lexus & Toyota
2002 - On
Nissan 1994 - On

UNIT PACKAGE: 15

Sec. 22**LEXUS CLIPS & FASTENERS****21547**(90467-09185)
Black Nylon

Front Spoiler & Grille
Push-Type Retainer
Head Diameter: 18mm
Stem Length: 10mm
Fits Into 9mm Hole
Lexus HS 250h and Toyota Celica,
Sequoia, Sienna & 4-Runner
1994 - On

UNIT PACKAGE: 25

**20955**(90467-07201)
Black Nylon

Engine Under Cover
Push-Type Retainer
Head Diameter: 20mm
Stem Length: 10mm
Fits Into 7mm Hole
Lexus ES300/330 and
Toyota Avalon, Camry & Solara
2002 - On

UNIT PACKAGE: 10

**20470**(69293-12040)
Yellow Nylon

Door Lock Rod Clip
Rod Size: 5mm
Left (Driver) Side
Lexus ES 300 2001 - 97
Toyota Camry, Celica, Corolla,
Echo, Highlander, MR2, RAV4,
Tundra and 4-Runner
1994 - On

UNIT PACKAGE: 10

**21201**(90467-07211)
Black Nylon

Bumper, Radiator Cover & Grille
Push-Type Retainer
Head Diameter: 19mm
Stem Length: 8mm
Fits Into 7mm Hole
Lexus IS & LS, Scion and Toyota
Avalon, Camry & Highlander
2005 - On

UNIT PACKAGE: 10

**21596**(75867-06030)
Black Nylon

Rocker Panel
Push-Type Retainer
Head Diameter: 20mm
Stem Length: 16mm
Fits Into 8mm Hole
Toyota & Lexus
2007 - On

UNIT PACKAGE: 25

**20534**(69293-12050)
Natural Nylon

Door Lock Rod Clip
Rod Size: 5mm
Fits Into 8.5mm Hole
Right (Passenger) Side
Lexus ES250, 300 & RX300
And Toyota Tacoma
1990 - On

UNIT PACKAGE: 10

**21525**(53259-0E010)
Black Nylon

Front Inner Structure
Push-Type Retainer
Head Diameter: 19mm
Stem Length: 9mm
Fits Into 7mm Hole
Lexus EX 350, IS 250, IS 350,
RX 330 RX350 & RX 400h
2004 - On

UNIT PACKAGE: 15

**20469**(69293-12030)
Natural Nylon

Door Lock Rod Clip
Rod Size: 5mm
Right (Passenger) Side
Lexus ES 300 2001 - 97
Toyota Camry, Celica, Corolla,
Echo, Highlander, MR2, RAV4,
Tundra and 4-Runner
1994 - On

UNIT PACKAGE: 10

**20535**(69293-12060)
Yellow Nylon

Door Lock Rod Clip
Rod Size: 5mm
Fits Into 8.5mm Hole
Left (Driver) Side
Lexus ES250, 300 & RX300
And Toyota Tacoma
1990 - On

UNIT PACKAGE: 10

Lexus (Cont.)



21336

(69293-30030)
Natural Nylon

Door Lock Rod Clip
Rod Size: 5mm
Fits Into 8mm Hole
Overall Height: 20mm
Toyota & Lexus
1993 – On

UNIT PACKAGE: 10

Not Actual Size



20380

(Not Supplied By O.E.M.)
Black Nylon

Cable Strap
Length: 200mm (8")
Max. Bundle Dia: 44mm (1-3/4")
Fits Into 6.3mm (1/4") Hole
Import Cars

UNIT PACKAGE: 25



21615

(90467-A0018,
90467-05081)
Maroon Nylon

Left & Right Front Bumper
& Bumper Stay
Nylon "U" Nut
M6 (#14) Screw Size
Panel Range: Up To 2mm
Center Of Hole To Edge: 12mm
Lexus and Toyota Avalon,
Camry & Solara
2000 – On

UNIT PACKAGE: 15

Lexus (Cont.)



17993

(90179-05060)
Black Nylon

Nylon "U" Nut
#10 Screw Size
18mm Wide, 27mm Long
Panel Range: Up To 3mm
Center Of Hole To Edge: 14mm
Lexus 1990-On

UNIT PACKAGE: 10



21359

(53879-17020)
Black Nylon

Bumper & Fender Apron
Nylon "U" Nut
M4.8 (#10) Screw Size
Panel Range: Up To 2mm
Center Of Hole To Edge: 10mm
Lexus GS, IS, LS & SC and
Toyota Celica
2000 – On

UNIT PACKAGE: 10



20956

(90467-05114)
Black Nylon

Bumper & Fender Apron
Nylon "U" Nut
Screw Size: M5.5 (#12)
Width: 20mm, Length: 36mm
Panel Range: Up To 1mm
Center Of Hole To Edge: 14mm
Lexus & Toyota
2000 - On

UNIT PACKAGE: 10

MAZDA



16555

(GJ21-51-036)

Headlight Adjusting Spring

UNIT PACKAGE: 10



19469

(G219-51-081)
White Nylon

Front Combination
Headlight
Pivot Holder
MX-6, MPV &
Protege
1995-On

UNIT PACKAGE: 10



20936

(Mazda:
9XG0-73-88X0;
Ford: W707388-S300)
Black Nylon

Front Bumper Cover
Moulding Clip
Bottom Head Size: 18mm x 20mm
Stem Length: 10mm
Fits Into 8mm x 12mm Hole
Mazda Tribute
2006 – 2001
Ford Escape
2001 – On

UNIT PACKAGE: 10



19228

(NA01-50-101A)
Nylon

Bumper Clip
Miata
1992-On

UNIT PACKAGE: 10



21561
(E11451W24)
White Nylon

Moulding Clip
Top Head Size: 10mm x 15mm
Bottom Head Diameter: 17mm
Stem Diameter: 13mm
Stem Length: 9mm
CX-7
2007 - ON

UNIT PACKAGE: 25



18882
(Ford: KA80-51-PR6;
Mazda: EA01-50-048)
Black Nylon

Body Side Lower
Wide Moulding Grommet
Ford Probe & Mazda MX6
1993-On

UNIT PACKAGE: 10



19450
(T001-50-M48B)
Natural Nylon

Rear Door Garnish Clip
Millenia
1995 - On

UNIT PACKAGE: 25



19451
(B173-50-852A)
Black Nylon

Cowl Panel Clip
Millenia
1995 - On

UNIT PACKAGE: 15

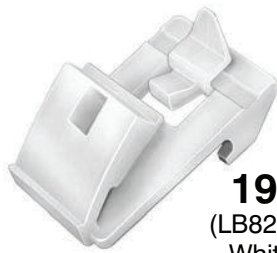

19755
(LB82-50-669A)
White Nylon

Door Belt
Moulding Clip
Width: 25mm
Length: 32mm
MPV
1998 - On

UNIT PACKAGE: 10

Bottom
View



Top
View



21171
(BP4L-51-SJ3)
Gray Nylon

Moulding Clip
With Sealer
Top Head Size: 14mm x 20mm
Bottom Head Diameter: 36.5mm
Stem Length: 10mm
3, 5, 6, CX-7, CX-9 & RX-8
2004 - On

UNIT PACKAGE: 10

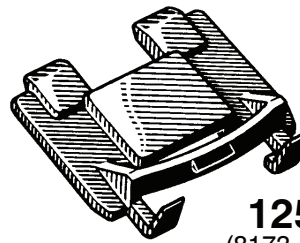

12589
(8173-50-931)
Nylon

Windshield Moulding Clip
28mm Wide; 26mm Long

UNIT PACKAGE: 15

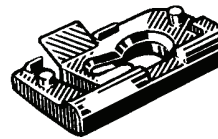

15469
Nylon

Windshield Reveal Moulding Clip
15mm Wide, 25.5mm Long
Nissan & Mazda

UNIT PACKAGE: 25



14719
(H001-50-609)
Nylon

Windshield Moulding Clip
25mm Wide
10mm Long

UNIT PACKAGE: 25



17290
(B092-50-609)
Nylon

Rear Window Moulding Clip
MX6 1988-On
Ford Probe 1988-On
Mercury Tracer 1987-On

UNIT PACKAGE: 15

MAZDA CLIPS & FASTENERS

Sec. 22

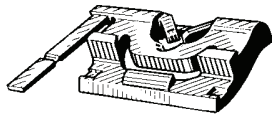

12591
(1243-50-609)
Nylon

Windshield Moulding Clip
28.5mm Wide
Clip Length: 14.5mm
Arm Length: 22.5mm
UNIT PACKAGE: 25



19648
(HG30-50-6B9A)
Brown Nylon

Windshield Clip
Width: 13mm
Length: 49mm
Height: 11mm
929 & Millenia
1992 - On

UNIT PACKAGE: 10



19452
(JOY1-50-619C)
White Nylon

Rear Window
Moulding Clip
With Adhesive Backing
Millenia
1995 - On

UNIT PACKAGE: 10

For The Most Up-To-Date
Information
On New Items Available
From Auveco,
refer to the
"Hot New Items" Section of the
Auveco Web Site
(www.auveco.com)



20958
(GJ6A-68-162)
White Nylon

Windshield Garnish
Moulding Retainer
Top Head Size:
10mm x 13mm
Bottom Head
Diameter: 16mm
Stem Length: 33mm
Fits Into 10mm Hole
3,5 & RX8
2004 - On

UNIT PACKAGE: 10



20984
(BC1M-50-0Z5)
Natural Nylon

Front Bumper
Screw Grommet
M4.2 (#8) Screw Size
Head Size:
24mm x 28mm
Stem Length: 14mm
323, 626, Miata
MPV & Protégé
1995 - On

UNIT PACKAGE: 10



20960
(GM9E-63-938A)
White Nylon

Windshield Moulding Clip
Head Size:
17mm x 20mm
Stem Length: 21mm
Fits Into 8mm Hole
Mazda 6
2003 - On

UNIT PACKAGE: 10



19831
(LA01-50-6A8A)
White Nylon

Window Screw Grommet
With Sealer Gasket
#6 Screw Size
MPV
1998 - On

UNIT PACKAGE: 10



13930
(Nissan: 96706-B0700;
Mazda: 9991-00-412)
Natural Nylon

#8 Screw Size
9.5mm Wide
9.5mm Long
Snaps Into 7mm x 7mm Hole

UNIT PACKAGE: 50



20957
(G6JA-50-0Z5)
Natural Nylon

Front Bumper
Screw Grommet
Screw Size: M4.2 (#8)
Head Size:
23mm x 24mm
Stem Length: 14mm
Miata, MPV, RX8
3, 5 & 6
2000 - On

UNIT PACKAGE: 15



14255
(Mitsubishi: MS-480001;
Honda: 75522-611-0000;
Mazda: 9991-00-412)
Black Nylon

#8 Screw Size
9.5mm Wide
9.5mm Long
Snaps Into 7mm x 7mm Hole

UNIT PACKAGE: 50



14274

(Mazda: 9991-00-601;
Honda: 75521-611-0000;
Nissan: 96706-P0105;
Toyota: 90189-06010)
Natural Nylon

#10 Screw Size
13mm Wide; 13mm Long
Snaps Into 8.5mm x 8.5mm Hole

UNIT PACKAGE: 25



14357

(9991-00-501)
Natural Nylon

#10 Screw Size
12mm Wide
12mm Long
Snaps Into 8mm x 8mm Hole

UNIT PACKAGE: 25



14313

(Mazda: 9991-00-503)
Honda: 90662-671-0030;
Nissan: 62698-V7000,
68425-H5000)
Natural Nylon

#10 Screw Size
17mm Wide
17mm Long
Snaps Into 8mm x 8.5mm Hole

UNIT PACKAGE: 25



14364

(9991-00-403)
Natural Nylon

#8 Screw Size
Head Diameter: 13mm
Fits Into 7mm x 7mm Hole

UNIT PACKAGE: 25



14366

(9991-00-402)
Natural Nylon

Screw Grommet
#6 Screw Size
9.5mm Wide, 9.5mm Long
Stem Length: 16mm
Fits Into 7mm x 7mm Hole
Also for Nissan/Datsun

UNIT PACKAGE: 50



14695

(Mazda: H001-50-841;
Honda: 90661-SC7-0030;
Mitsubishi: MS-480012;
Nissan: 01651-00481,
74798-S9000;
Toyota: 90189-06042)
White Nylon

Screw Grommet
#8 Screw Size
Head Diameter: 16mm
Stem Length: 17mm
Fits Into 8mm x 8mm Hole

UNIT PACKAGE: 25



19832

(LB84-68-AD5)
White Nylon

Door Trim
Screw Grommet
With Sealer Gasket
#6 Screw Size
Head Size: 10mm x 10mm
Stem Length: 15mm
MPV
1998 - On

UNIT PACKAGE: 10



21413

(GS3L-68-615)
Black Nylon

Cowl Trim Grommet
Head Diameter: 25mm
Stem Length: 22mm
6 GT
2010 - On

UNIT PACKAGE: 10



20579

(FD02-50-798)
Black Nylon

Cowl Vent Grommet
With Sealer
M4.2 (#8) Screw Size
Head Size: 12mm x 22mm
Stem Length: 13mm
323, 626, Millenia & MX6
1995 - On

UNIT PACKAGE: 10



19748

(KA78-50-AF4)
Black Nylon

Splash Shield
Screw Grommet
#12 (M5.5) Screw Size
Head Diameter: 18mm x 20mm
Stem Length: 15mm
626
1998 - On

UNIT PACKAGE: 10



19833

(H260-50-6K8)
White Nylon

Cowl Screw Grommet
With Sealer Gasket
#8 (M4.2 - 1.41) Screw Size
Head Size: 16mm x 22mm
Stem Length: 20mm
MPV
1998 - On

UNIT PACKAGE: 10



19743

(GJ21-58-502A)
Natural Nylon

Window Moulding
Screw Grommet
#12 (M5.5) Screw Size
18mm Wide, 22mm Long
Snaps Into 11mm Hole
626
1998-On

UNIT PACKAGE: 15

When The World Thinks Of
Body Hardware &
Specialty Fasteners,
Only One Name Comes To
Mind... 

MAZDA CLIPS & FASTENERS

Sec. 22



20463
(S084-58-502)
Natural Nylon

Door Glass
Screw Grommet
#12 Screw Size
18mm Wide, 32mm Long
Stem Length: 10mm
626
2000 - ON

UNIT PACKAGE: 10



19138
(Ford: F1CZ-5802316A;
Mazda: BW0A-50-792)
Gray Nylon

Cowl Top Vent Grille Retainer
Ford Escort & Tracer
and Mazda
1991 - On

UNIT PACKAGE: 15



14367
(9924-90-512B)
Black Nylon

Retainer
Head Diameter: 12mm
Stem Length: 10mm
Snaps Into 4mm Hole
Panel Thickness: 2mm

UNIT PACKAGE: 50



21307
(BP4K-58-762)
Black Nylon

Weatherstrip Retaining Clip
Head Diameter: 9mm
Stem Diameter: 5.5mm
Stem Length: 7mm
Mazda
2007 - On

UNIT PACKAGE: 25



19753
(GA2A-56-399A)
Black Nylon

Front Fender
Plate Seal Clip
Head Diameter: 18mm
Stem Length: 26mm
626
1998 - On

UNIT PACKAGE: 10



17551
(GJ21-50-H81)
Natural Nylon

Cowl Screen Grommet
Ford Probe and
Mazda 626 & MX6
1988-On

UNIT PACKAGE: 25



17552
(GJ21-50-H82)
Natural Nylon

Cowl Screen Grommet
Ford Probe and
Mazda 626 & MX6
1988-On

UNIT PACKAGE: 25



21520
(J001-56-741)
Black Nylon

Weatherstrip Retaining Clip
Head Diameter: 14mm
Stem Diameter: 6.5mm
Stem Length: 10mm
CX-7, Millenia, MPV, 3, 6 & 626
1995 - On

UNIT PACKAGE: 25



17553
(KA01-50-H16)
Green Nylon

Rear Hatch Grommet
Ford Probe and
Mazda MX 6 1988-On
Use With 17554

UNIT PACKAGE: 25



18458
(Ford: F1CZ-16774-A;
Mazda: B455-56-741)
Black Nylon

Hood Insulation Retaining Clip
Head Diameter: 14mm
Stem Length: 10mm
Fits Into 6mm Hole
Ford Probe & Mazda MX6
1992-88

UNIT PACKAGE: 25



17451
(H001-68-719B)
Natural Nylon

Rocker Scuff Plate Retainer
Ford Probe and
Mazda MX6
1988-On

UNIT PACKAGE: 25



17554
(KA01-50-H15A)
Black Nylon

Rear Hatch Retainer
Ford Probe and
Mazda MX6 1988-On
Use With 17553

UNIT PACKAGE: 25



14349

(Mazda: 9926-40-543A;
Nissan: 01553-00291)
Black Nylon

Retaining Clip
Head Dia: 11mm
Stem Length: 15mm
Fits Into 5.5mm Hole
Panel Thickness: 5mm

UNIT PACKAGE: 50



18271

(9926-40-531B)
Black Nylon

Hood Insulation Retainer
Head Diameter: 14mm
Stem Diameter: 6mm
Stem Length: 15mm

UNIT PACKAGE: 25



17453

(B003-68-865-96)
Gray Nylon

Rear Compartment
Interior Trim Retainer
Head Diameter: 15mm
Stem Length: 14mm
Stem Diameter: 6.5mm
Ford Probe and
Mazda MX6
1988-On

UNIT PACKAGE: 50



16777

(Mazda: B001-68-302-00;
Toyota: 90950-01248)
Black Nylon

Retaining Clip
Head Dia: 15mm
Stem Length: 15mm
Panel Thickness: 2mm
Fits Into 8mm Hole

UNIT PACKAGE: 25



14380

(8133-50-022)
Black Nylon

Retaining Clip
Head Diameter: 18mm
Stem Length: 18mm
Snaps Into 8mm Hole
Panel Thickness: 7mm

UNIT PACKAGE: 25



14709

(Mazda:
G030-68-885-B-38;
Ford: F22Z-16774-A,
GA2A-56694)
Black Nylon

Hood Insulation Retainer
Head Diameter: 20mm
Stem Length: 9mm
Fits Into 6mm Hole

UNIT PACKAGE: 25



21661

(TD11-56-694)
Black Nylon

Hood Insulation Retainer
Head Diameter: 20mm
Stem Diameter: 7mm
Stem Length: 10mm
3, 5, 6, CX7, CX9,
MX-5 Miata & RX8
2004 - On

UNIT PACKAGE: 25



21560

(G032-68-865A-00)
Black Nylon

Trunk & Carpet Retainer
Head Diameter: 20mm
Stem Diameter: 7mm
Stem Length: 15mm
B2000, B2600, CX-7, CX-9,
Miata, Millenia, MX-3, MX-5,
MX-6, Protege, RX-7, RX-8,
3, 5, 6, 626 & 929
1987 - On

UNIT PACKAGE: 25



18692

(Mazda: G031-58-762;
Toyota: 67867-89103,
97868-89101)
Natural Nylon

Weatherstrip Retainer
Head Size: 5mm x 15mm
Stem Length: 10mm
Fits Into 5mm Hole
Toyota 4-Runner 1989-83
Mazda 1996-On

UNIT PACKAGE: 50



20460

(G043-50-742)
Black Nylon

Cowl Panel Retainer
With Sealer
Top Head Dia.: 14mm
Bottom Head Dia.: 18mm
Stem Dia.: 9mm
Stem Length: 13mm
626
2000 - On

UNIT PACKAGE: 10



20932

(G18K-51-SJ3)
White Nylon

Door Trim Panel Retainer
With Sealer
Top Head Diameter: 14mm
Bottom Head Diameter: 18mm
Stem Diameter: 12mm
Stem Length: 14mm
3, 5, 6, CX-7
Miata & Protégé
2001 - On

UNIT PACKAGE: 10

MAZDA CLIPS & FASTENERS

Sec. 22



20983
(GJ6R-68-ABX)
White Nylon

Trim Panel Retainer
With Sealer
Top Head Diameter: 13mm
Middle Head Diameter: 16mm
Bottom Head Diameter: 18mm
Stem Diameter: 9mm
Stem Length: 13mm
3, 5, 6, Miata & RX-8
2003 - On

UNIT PACKAGE: 15



14269
(Mazda: 9927-40-825;
Isuzu: 8942264920;
Toyota: 67771-01010,
67771-12010)
White Nylon

Door Panel Retainer
Top Head Diameter: 13mm
Middle Head Dia.: 15.5mm
Bottom Head Diameter: 18mm
Stem Diameter: 9.5mm
Stem Length: 14mm
Overall Length: 20.5mm

UNIT PACKAGE: 25



18824
(G350-68-AB1)
White Nylon

Trim Panel Retainer
Top Head Diameter: 13mm
Bottom Head Diameter: 15mm
Stem Length: 9.5mm
Fits Into 9mm Hole
626, MX6, Millenia, MX3,
929, Protege & MPV
and Ford Probe
1992-On

UNIT PACKAGE: 50



21412
(TD12-51-SJ3A)
Gray Nylon

Rocker Moulding Retainer
With Sealer
Top Head Diameter: 14mm
Bottom Head Diameter: 18.5mm
Stem Diameter: 12mm
Stem Length: 13mm
6 GT
2010 - On

UNIT PACKAGE: 15



19481
(GA2A-58-762)
Blue Nylon

Weatherstrip Retainer
Head Size: 5mm x 15mm
Stem Length: 8mm
Fits Into 6mm Hole
Front & Rear Door
and Hood Weatherstrip
626 & Millenia
1995 - On

UNIT PACKAGE: 50



20459
(GA2A-68-AB1A)
Black Nylon

Trim Panel Retainer
Top Head Dia.: 15mm
Bottom Head Dia.: 16mm
Stem Dia.: 9mm
Stem Length: 10mm
626
2000 - On

UNIT PACKAGE: 10



21663
(EA01-50-037)
Black Nylon

Push-Type Retainer
Head Diameter: 10mm
Stem Length: 9mm
Fits Into 5mm Hole
2, 3, CX7, CX9, MX-3,
MX-5 Miata & RX8
1992 - On

UNIT PACKAGE: 15



14363
(9927-40-821)
Nylon

Door Panel
Retainer
Bottom Head Diameter: 17mm
Stem Length: 14mm
Overall Length: 20mm
Fits Into 8mm Hole

UNIT PACKAGE: 25



21662
(S51S-51-833)
Black Nylon

Push-Type Retainer
Head Diameter: 11mm
Stem Length: 11mm
Fits Into 7mm Hole
3, MX-5 Miata & RX8
2004 - On

UNIT PACKAGE: 15



16778
(Mazda: 9927-40-822;
Toyota: 62581-14020)
Natural Nylon

Trim Panel Retainer
Small Head Dia: 14mm
Large Head Dia: 18mm
Stem Length: 14mm
Fits Into 8mm Hole

UNIT PACKAGE: 25



14697
(Mazda: N304-13-356-A;
GM: 94198687;
Honda: 90657-SA6-0030)
Black Nylon

Push-Type Retainer
Head Diameter: 14mm
Stem Length: 11mm
Fits Into 7mm Hole

UNIT PACKAGE: 25



17478

(B101-68-252-00)
Black Nylon

Interior Trim
Push-Type Retainer
Head Diameter: 14mm
Stem Length: 16mm
Fits Into 6mm Hole
Ford Probe and
Mazda MX6
1988-On

UNIT PACKAGE: 25



20465

(UB39-45-919)
Black Nylon

Front & Rear Fender
Push-Type Retainer
Head Diameter: 18mm
Stem Length: 9mm
Fits Into 8mm Hole
626
2000 - On

UNIT PACKAGE: 10



17632

(Mazda: B092-51-833;
Ford: MB-455-56143,
W705845-S300;
Hyundai: 86590-28000)
Black Nylon

Push-Type Retainer
Head Diameter: 18mm
Stem Length: 12mm
Fits Into 8mm Hole
Mazda, Hyundai & Ford Aspire

UNIT PACKAGE: 10



20923

(Ford: 3M8Z-1502316-A;
Mazda: GJ6E-50-715A)
Black Nylon

Cowl Vent
Push-Type Retainer
Head Size: 8.5mm x 12mm
Stem Length: 9mm
Fits Into 5mm Hole
Ford Fusion, Milan & Zephyr
2006 - On
Mazda 5 & 6
2003 - On

UNIT PACKAGE: 15



21024

(Ford: 5R3Z-54310D12-AAA,
6E5Z-7850980-AAA; Mazda:
GJ21-68-885B-02)
Black Nylon

Trim Panel
Push-Type Retainer
Head Diameter: 18mm
Stem Length: 10mm
Fits Into 6mm Hole
Ford Fusion & Mustang
2005 - On
Mazda 1992 - On

UNIT PACKAGE: 15



18206

(GJ21-68885-B69)
Gray Nylon

Push-Type Retainer
Head Diameter: 18mm
Stem Length: 12mm
Fits Into 6mm Hole
Ford Probe &
Mazda MX6
1989-On

UNIT PACKAGE: 25



14260

(Mazda: 9926-50-625;
Toyota: 90467-06017)
Black Nylon

Push-Type
Retainer
Head Diameter: 15mm
Stem Length: 12mm
Fits Into 7mm Hole
UNIT PACKAGE: 15



21110

(B100-68-8550)
Black Nylon

Rear Light Access Door
Push-Type Retainer
Head Diameter: 18mm
Stem Length: 12mm
Fits Into 8.5mm Hole
323
1986 - On

UNIT PACKAGE: 15



19306

(GA5R-56-392)
Black Nylon

Shroud Seal Board
Push-Type Retainer
Head Diameter: 16mm
Stem Length: 12mm
Fits Into 6mm Hole
626
1994-On

UNIT PACKAGE: 10



19747

(UB39-50-795)
Black Nylon

Stone Guard
Push-Type Retainer
Head Diameter: 18mm
Stem Length: 10mm
Fits Into 8mm Hole
MPV
1998-On

UNIT PACKAGE: 10

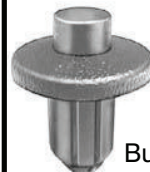

19416

(Toyota: 90467-09139)
Black Nylon

Bumper Cover &
Wheel Housing
Push-Type Retainer
Head Diameter: 18mm
Stem Length: 15mm
Fits Into 9mm Hole
Honda, Mazda 626 &
Toyota Corolla
1992-On

UNIT PACKAGE: 15

MAZDA CLIPS & FASTENERS

Sec. 22



20755
(GD7A-50-EA1)
Black Nylon

Bumper Cover & Grille
Push-Type Retainer
Head Diameter: 19.5mm
Stem Length: 15mm
Fits Into 10mm Hole
Mazda
1999 - On

UNIT PACKAGE: 10



14369
(1395-68-676,
9926-50-635)
Black Nylon

Push-Type Retainer
Head Diameter: 20mm
Stem Length: 9mm
Fits Into 6mm Hole

UNIT PACKAGE: 15



16000
(Honda:
90675-SB3-003;
Mazda: FB01-56-964;
Nissan:
63876-95596)
Black Nylon

Push-Type Retainer
Head Dia: 20mm
Stem Length: 9mm
Fits Into 8mm Hole

UNIT PACKAGE: 25



19315
(BC1D-56-145)
Black Nylon

Mud Guard Push-Type Retainer
Head Diameter: 20mm
Stem Length: (Exc. Pin): 9mm
Fits Into 8mm Hole
Protege
1996-On

UNIT PACKAGE: 15



16858
(Mazda: NA01-56-145;
Kia: MNA01-56-145;
Nissan: 63844-01A00;
Ford: MNA01-56145,
NA01-56145)
Black Nylon

Inner Fender Push-Type Retainer
Head Dia: 20mm (25/32")
Stem Length: 18mm (23/32")
Fits Into 8mm (5/16") Hole
Mazda, Kia, Ford & Nissan

UNIT PACKAGE: 25

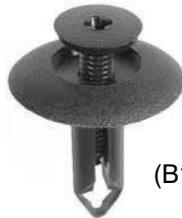

21119
(B100-68-675-69)
Black Nylon

Push-Type Retainer
Head Diameter: 20mm
Stem Length: 19mm
Fits Into 6mm Hole
Mazda MX6 and
Ford Probe
1988 - On

UNIT PACKAGE: 15



17450
(Ford: E8B2-17C756C;
Mazda: BF67-50-235)
Black Nylon

Bumper Cover Retainer
Head Size: 20mm x 30mm
Stem Length: 11mm
Fits Into 10mm Hole
Ford Festiva 1988-On
Mazda 323 1986-On

UNIT PACKAGE: 10



15366
(Ford: E7GZ-17A904-B;
Mazda: BF67-50-033)
Gray Nylon

Bumper Retainer
Head Size: 20mm x 30mm
Stem Length: 11mm
Fits Into 10mm Hole
Mazda and
Mercury Tracer 1987-On

UNIT PACKAGE: 10



16843
(Mazda: BF82-50-233;
Nissan: 01553-01393)
Black Nylon

Bumper Cover Retainer
Head Size: 20mm x 30mm
Stem Length: 18mm
Fits Into 10mm Hole

UNIT PACKAGE: 10



17060
(Ford: E92Z-17C756C;
Mazda: GJ21-50-034)
Black Nylon

Bumper Cover Retainer
Head Size: 20mm x 30mm
Stem Length: 20mm
Fits Into 10mm Hole
Ford Probe & Mazda MX6
1989-On

UNIT PACKAGE: 10



14378
(9927-70-901)
Nylon
Tube/Cable
Routing Clip
For Holding Multiple
Cables or Tubes
Diameter: 8mm
Fits Into 6mm Hole
UNIT PACKAGE: 25



20195
Pink Door Lock Pawl
Left-Hand Side
Ford Continental, Contour,
Explorer, Mountaineer, Mystique,
Ranger, Sable
& Taurus And Mazda Truck
1996 - On
UNIT PACKAGE: 1



Not Actual Size

21305
(Not Available From O.E.M.)
Natural Nylon

Push-Mount Cable Strap
Overall Length: 156mm (6-1/8")
Strap Width: 5mm (3/16")
Snaps Into 6.3mm (1/4") Hole
Maximum Bundle Diameter:
40mm (1-9/16")
European Makes & Universal
UNIT PACKAGE: 25



14359
(9927-80-405)
Nylon
Rod End Clip
Holds 4mm Rods
Snaps Into 6mm Hole
UNIT PACKAGE: 25



14376
(9928-90-753)
Nylon
Releasable
Cable Strap
Length: 110mm (4-3/8")
Max. Bundle
Diameter: 25mm
Fits Into 7mm Hole
UNIT PACKAGE: 15



14365
(9927-80-404)
Nylon
Rod End Clip
Holds 4mm Rods
Snaps Into 6mm
Hole
UNIT PACKAGE: 25



20380
(Not Supplied By O.E.M.)
Black Nylon

Cable Strap
Length: 200mm (8")
5mm (3/16") Wide
Max. Bundle Dia: 44mm (1-3/4")
Fits Into 6.3mm (1/4") Hole
Import Cars
UNIT PACKAGE: 25



20153
White Door Lock Pawl
Right-Hand Side
Mazda Truck and Ford
Continental, Contour,
Explorer, Mountaineer, Mystique,
Ranger, Sable & Taurus
1996 - On
UNIT PACKAGE: 1



Not Actual Size

14298
(Mazda: 9928-91-053;
Honda: 90672-SA0-0030)
Nylon
Releasable Cable Strap
Overall Length: 140mm (5-1/2")
Max. Bundle
Diameter: 30mm
Fits Into 7mm Hole
UNIT PACKAGE: 25

MAZDA & MERCEDES-BENZ CLIPS & FASTENERS **Sec. 22**

MAZDA (Cont.)

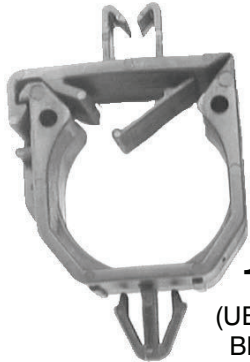

19754
(UB42-67-013)
Black Nylon

Wiring Harness
Routing Clip
MPV
1998 - On

UNIT PACKAGE: 15

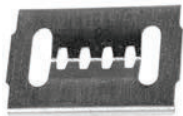

17003

(Mazda: GJ21-50-049;
Ford: F32Z-17C756-S)

Bumper Cover Retainer
Front & Rear Bumpers
Mazda & Ford 1988 - On

UNIT PACKAGE: 50



14750

(Toyota: 53879-14010-A,
53879-14020, 53879-22030;
GM: 94841226;
Mazda: LA01-56-135)
Black Nylon

Nylon "U" Nut
Fender/Wheel
Housing Applications
#10 Screw Size

20mm Wide
31mm Long
Panel Range: Up to 1mm
Center of Hole To Edge: 11mm
Toyota, Geo Prizm & Nova and
Mazda

UNIT PACKAGE: 15

19669

Same As 14750 Except For Packing

UNIT PACKAGE: 25

MERCEDES-BENZ



20201
(006-988-30-78)
Natural Nylon

Body Side
Moulding Clip
Body Style 124
1995 - 86

UNIT PACKAGE: 10



20657
(004-988-76-78,
004-988-77-78)
Black Nylon

Moulding Clip
11mm Wide
20mm Long

UNIT PACKAGE: 15



20197
(201-988-07-78)
Black Nylon

Body Side
Moulding Clip
Body Style 201
1993 - 84

UNIT PACKAGE: 10

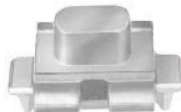

20202
(201-988-04-78)
Natural Nylon

Body Side Quarter Panel
Moulding Clip
Body Style 201
1995 - 84

UNIT PACKAGE: 10



20897
(002-988-51-81)
Black Nylon

Grille Moulding Clip
Fits Into 7mm Hole
CLK320,
CLK500 & ML350
2003 - On

UNIT PACKAGE: 10

MERCEDES-BENZ



21464
(001-988-44-81)
White Nylon

Front Fender Moulding Clip
Head Size: 12mm x 16mm
Stem Length: 7mm
Overall Height: 16mm
Mercedes-Benz
2000 - 1994

UNIT PACKAGE: 25



21468
(001-988-60-81)
Yellow Nylon

Front Fender
Moulding Clip
Head Size: 12.5mm x 15.5mm
Stem Length: 7mm
Overall Height: 15.5mm
Mercedes-Benz
2000 - 1994

UNIT PACKAGE: 25



21433
(001-988-49-81)
White Nylon

Moulding Clip
Head Size: 16mm x 16mm
Overall Length: 21.5mm
Mercedes-Benz 124 & 201
1995 - 84

UNIT PACKAGE: 25



21466
(001-988-46-81)
White Nylon

Front & Rear Door
Moulding Clip
Width: 18.5mm
Length: 25mm
Overall Height: 21.5mm
Mercedes-Benz
1995 - 1987

UNIT PACKAGE: 25

Sec. 22 MERCEDES-BENZ CLIPS & FASTENERS



21435

(124-988-04-78)
White Nylon

Moulding Clip
Width: 19mm
Length: 20mm
Overall Height: 20mm
Mercedes-Benz
1990 - 85

UNIT PACKAGE: 25



21441

(001-988-50-81)
White Nylon

Moulding Clip
Width: 22.5mm
Length: 23mm
Mercedes-Benz

UNIT PACKAGE: 25



21469

(001-988-63-81)
White Nylon

Quarter Panel
Moulding Clip
Width: 19mm
Length: 32mm
Overall Height: 25.5mm
Mercedes-Benz
1995 - 1987

UNIT PACKAGE: 25



21434

(006-988-89-78)
White Nylon

Moulding Clip
Width: 11mm
Length: 45mm
Overall Height: 16mm
Mercedes-Benz
1999 - 92

UNIT PACKAGE: 25



21465

(001-988-80-81)
White Nylon
With Rubber Boot

Moulding Clip
Width: 23mm
Length: 32.5mm
Stem Length: 16mm
Mercedes-Benz
2006 - 1994

UNIT PACKAGE: 15

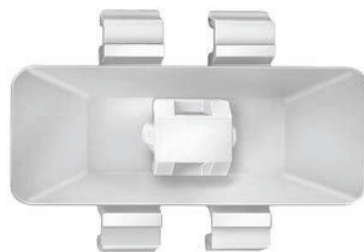

21467

(007-988-71-78)
White Nylon

Front & Rear Door
Moulding Clip
Width: 32.5mm
Length: 48mm
Overall Height: 15mm
Mercedes-Benz
2009 - 1994

UNIT PACKAGE: 25



20199

(006-988-35-78)
White Nylon

Body Side Moulding Clip
Body Style 201
1993 - 87

UNIT PACKAGE: 10

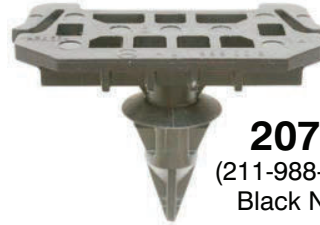

20773

(211-988-00-81)
Black Nylon

Cowl Cover Retainer
Head Size: 20mm x 43mm
Stem Length: 25mm
Fits Into 8mm Hole
E, CL & S Class
2000 - On

UNIT PACKAGE: 10



20656

(140-698-00-82)
White Nylon

Rocker Moulding Clip
Head Diameter: 12mm x 16mm
Stem Length: 28mm
Overall Length: 36mm

UNIT PACKAGE: 10



20205

(001-988-76-81)
White Nylon

Moulding Insert
Head Dia: 11.5mm
Stem Length: 12mm
Fits Into 9mm Hole
Body Styles
170, 202, 203, 208, 210 & 220
1994 - On

UNIT PACKAGE: 25

MERCEDES-BENZ CLIPS & FASTENERS **Sec. 22**



20659
(201-997-22-81)
White Nylon

Hood & Trunk
Moulding Insert
Head Diameter: 7mm
Stem Length: 6mm
Fits Into 5.5mm Hole
C, CL, CLK, E, SLK & S Class
1996 - On

UNIT PACKAGE: 15



20200
(001-988-77-81)
Natural Nylon

Moulding Insert
Head Dia: 8mm
Stem Length: 5mm
Fits Into 7mm Hole
Body Styles
202 & 210
1994 - On

UNIT PACKAGE: 25



13141
(000-988-15-81)
Red Nylon

Moulding Insert

UNIT PACKAGE: 50



13144
(000-988-55-81)
Blue Nylon

Moulding Insert

UNIT PACKAGE: 50



13157
(000-987-10-81)
White Nylon

Moulding Insert

UNIT PACKAGE: 50



16124
(001-988-20-81)
Red Nylon

Tubular Nut
I.D.: 4.5mm, Length: 14mm
Fits Into 9mm Hole

UNIT PACKAGE: 50



Twice Actual Size
13150
(123-997-03-81)
Nylon

Barrel Nut
For 2mm Stud
Fits Into 4mm Hole

UNIT PACKAGE: 50



21499
(BMW: 51-44-7-780-135;
Mercedes-Benz: 108-988-00-27)
Natural Nylon

Tubular Nut
Stud Size: 7mm
Head Diameter: 16mm
Stem Length: 16mm
Fits Into 8.5mm Hole
BMW, Mercedes-Benz & Universal

UNIT PACKAGE: 25



20647
(000-988-16-25)
White Nylon

Cowl Vent Nylon Nut
M3.5 (#6) Screw Size
Head Size: 9.5mm x 9.5mm
Stem Length: 14mm
Fits Into 6.5mm x 7mm Hole

UNIT PACKAGE: 25



20646
(001-988-12-25)
Natural Nylon

M3.5 (#6) Screw Size
Head Diameter: 12mm
Stem Length: 20mm
Fits Into 5.5mm Hole

UNIT PACKAGE: 10



20404
(000-988-86-25)
Natural Nylon

Rocker Panel Moulding
Screw Grommet
Use With M4.2 (#8) Screw
Class CL, E & S
1996 - On

UNIT PACKAGE: 25



20315
(673-988-00-25)
Black Nylon

Screw Grommet
#8 (M4.2) Screw Size
Head Diameter: 25mm
Stem Length: 17mm
Body Styles
124, 126, 170, 201,
202, 208 & 210
1991 - On

UNIT PACKAGE: 15



20643
(000-997-91-86)
Black Nylon

Retainer
Head Diameter: 13mm
Stem Diameter: 6.5mm
Stem Length: 11mm

UNIT PACKAGE: 10



21105
(001-988-03-25)
Black Nylon

Hood Insulation Retainer
Head Diameter: 20mm
Stem Diameter: 14mm
Stem Length: 10mm
Mercedes - Benz
2002 - On

UNIT PACKAGE: 15

Sec. 22**MERCEDES-BENZ CLIPS & FASTENERS****20188**(003-988-41-78)
White NylonTrim Panel Retainer
Small Head Dia: 13mm
Large Head Dia: 18mm
Stem Diameter: 8.5mm
Stem Length: 11mm
Body Styles 107, 108,
109, 114, 115, 123 & 124
1995 - 68

UNIT PACKAGE: 10

**13230**(Mercedes
000-990-03-92;
Volvo: 947-098)
Black NylonPush-Type Retainer
Head Dia. 10mm
Stem Length: 7mm
Fits Into 5mm Hole

UNIT PACKAGE: 50

**20640**(000-990-40-92,
124-990-05-92-9051)
Black NylonPush-Type Retainer
Head Diameter: 12mm
Stem Length: 11mm
Fits Into 5mm Hole

UNIT PACKAGE: 25

**20735**(463-933-02-78)
Black NylonDoor Panel Retainer
Top Head Diameter; 11.5mm
Bottom Head Diameter: 18mm
Stem Diameter; 9mm
Stem Length: 14mm
G55 & G500
2002 - On

UNIT PACKAGE: 25

**20187**(000-990-34-92)
Black NylonRadiator Housing
Push-Type Retainer
Head Diameter: 10mm
Stem Length: 10mm
Fits Into 6mm Hole
Body Styles 116, 123, 124, 126,
129, 140, 170, 201, 208 & 210
1974 - On

UNIT PACKAGE: 15

**20639**(000-990-44-92)
Black NylonPush-Type Retainer
Head Diameter: 12mm
Stem Length: 11mm
Fits Into 5mm x 5mm Hole

UNIT PACKAGE: 25

**20642**(000-990-57-92)
Gray NylonDoor Panel
Retaining Clip
Top Head Diameter: 13mm
Bottom Head Diameter: 16mm
Stem Diameter: 9mm
Stem Length: 13mm

UNIT PACKAGE: 10

**21037**(000-990-84-92)
Black NylonPush-Type Retainer
Head Diameter: 10mm
Stem Length: 10mm
Fits Into 6mm Hole
Mercedes - Benz
2005 - On

UNIT PACKAGE: 25

**21044**(123-990-05-92,
126-990-03-92)
Black NylonCowl Screen Cover
Push-Type Retainer
Head Diameter: 16mm
Stem Length: 11mm
Fits Into 6.3mm Hole
E, CL & S Class
2000 - On

UNIT PACKAGE: 15

**20879**(007-988-99-78,
007-988-34-78)
Green NylonDoor Trim Panel Retainer
Top Head Diameter: 13mm
Bottom Head Diameter: 17mm
Stem Diameter: 9mm
Stem Length: 14mm
Mercedes-Benz
1996 - On

UNIT PACKAGE: 10

**20314**(000-990-37-92)
Black NylonTrunk Trim &
General Purpose
Push-Type Retainer
Head Diameter: 13mm
Stem Length: 14mm
Fits Into 8mm Hole
SL500 & SL600 Convertible
1999 - On

UNIT PACKAGE: 15

**20641**(000-990-46-92)
Black NylonPush-Type Retainer
Head Diameter: 17mm
Stem Length: 15mm
Fits Into 6mm Hole

UNIT PACKAGE: 10

MERCEDES-BENZ CLIPS & FASTENERS **Sec. 22**



20636

(123-990-00-92)
Dark Gray Nylon

Push-Type Retainer
Head Diameter: 12mm
Stem Length: 10mm
Fits Into 8.5mm Hole
UNIT PACKAGE: 15



21086

(Mercedes-Benz:
230-990-01-92;
Chrys: 6104900-A)
Black Nylon

Hood Insulation & Cowl Grille
Push-Type Retainer
Head Diameter: 20mm
Stem Length: 10mm
Fits Into 8mm Hole
Mercedes GL, M, R,
SL & SLK
2005 - On
Chrysler 2010 - On
UNIT PACKAGE: 15



21431

(BMW: 16-13-1-176-747;
Mercedes-Benz: 003-990-02-51)
Black Nylon

Nylon Flange Nut
Stud Size: 5mm
10mm Hex
Flange Diameter: 16mm
Overall Height: 11mm
BMW & Mercedes-Benz
1997 - On
UNIT PACKAGE: 25



20772

(001-990-13-92)
Black Nylon

Back Glass Moulding
Push-Type Retainer
Head Diameter: 15mm
Stem Length: 11mm
Fits Into 5mm Hole
C & SL Class
2001 - On
UNIT PACKAGE: 15



20638

(201-990-02-92)
Black Nylon

Push-Type Retainer
Head Diameter: 20mm
Stem Length: 14mm
Fits Into 8.5mm Hole
UNIT PACKAGE: 25



20653

Gray Nylon

Wire Routing Clip
Inside Diameter: 7mm x 10mm
Fits Into 6mm Hole
BMW & Mercedes
UNIT PACKAGE: 50



20909

(124-990-04-92)
Black Nylon

Push-Type Retainer
Head Diameter: 16mm
Stem Length: 18mm
Fits Into 7mm Hole
Mercedes-Benz
2003 - On
UNIT PACKAGE: 15



20203

(124-990-07-92)
Black Nylon

Push-Type Retainer
Head Size: 11mm x 14mm
Stem Length: 8mm
Fits Into 7mm x 8mm Hole
Body Styles
124, 129, 140, 170, 202,
203, 208, 210, 215, & 220
1986 - On
UNIT PACKAGE: 25



Not Actual Size

20654

(001-997-42-90)
Black Nylon

Cable Strap
Overall Length: 120mm (4-3/4")
Fits Into 8mm Hole
UNIT PACKAGE: 10



20637

(123-990-02-92)
Black Nylon

Push-Type Retainer
Head Diameter: 20mm
Stem Length: 9mm
Fits Into 8mm Hole
UNIT PACKAGE: 10



20645

(201-990-00-50)
Black Nylon

Rear Compartment
Carpet Retainer
Fits Onto 5mm Stud
Head Diameter: 24mm
10mm Hex
UNIT PACKAGE: 25



Not Actual Size

21305

(Not Available From O.E.M.)
Natural Nylon

Push-Mount Cable Strap
Overall Length: 156mm (6-1/8")
Strap Width: 5mm (3/16")
Snaps Into 6.3mm (1/4") Hole
Maximum Bundle Diameter:
40mm (1-9/16")
European Makes & Universal

UNIT PACKAGE: 25

Sec. 22**MERCEDES-BENZ CLIPS & FASTENERS**

Not Actual Size

**20655**(114-997-02-90)
Black Nylon

Cable Strap

Overall Length: 160mm (6-3/8")
Fits Into 8mm Hole

UNIT PACKAGE: 10

**20648**(123-994-01-45)
Zinc & Yellow

M2.9 (#4) Screw Size

Panel Range: .7mm - 1.5mm
Center of Hole to Edge: 4mm

UNIT PACKAGE: 50

**20649**

Zinc & Yellow

M3.5 (#6) Screw Size

Panel Range: .5mm - 1.5mm
Center of Hole to Edge: 8mm

UNIT PACKAGE: 50

**13223**(BMW: 0712-9-925-708;
Mercedes: 000-994-25-45)
Plated

"U" Type Nut

4.2mm (#8) Screw Size

Panel Range: 3mm-4mm
Center of Hole To Edge: 7mm

UNIT PACKAGE: 50

**13224**(000-994-04-45)
Plated

"U" Type Nut

4.2mm (#8) Screw Size

Panel Range: .5mm-1.7mm
Center of Hole To Edge: 8mm

UNIT PACKAGE: 50

**20650**(123-994-08-45)
Zinc & Yellow

M4.2 (#8) Screw Size

Panel Range: .5mm - 2.5mm
Center of Hole to Edge: 14mm

UNIT PACKAGE: 25

**13218**(BMW: 0712-9-925-737;
Mercedes 000-994-06-45)
Plated

"U" Type Nut

4.8mm Screw Size

Panel Range: .5mm-1.7mm
Center of Hole To Edge: 7mm

UNIT PACKAGE: 50

**13215**(BMW: 0711-9-916-945,
Mercedes 000-994-14-45)
Plated

"U" Type Nut

4.8mm Screw Size

Panel Range: .8mm-1.7mm
Center Of Hole To Edge: 11mm

UNIT PACKAGE: 50

**13216**

Zinc

"U" Type Nut

4.8mm Screw Size

Panel Range: .9mm-2.0mm
Center of Hole to Edge: 8mm

UNIT PACKAGE: 25

**13220**(Mercedes:
000-994-09-45;
Volvo: 946-418;
Opel: 20-72-175)
Plated

"U" Type Nut

6.3mm Screw Size

Panel Range: .7mm-1.5mm
Center of Hole To Edge: 13mm

UNIT PACKAGE: 50

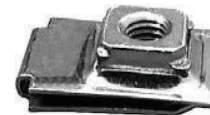
**20651**(001-990-00-91)
Zinc

M6 - 1.0 Screw Size

Panel Range: .5mm - 1.7mm
Center of Hole To Edge: 15mm

UNIT PACKAGE: 10

MINI-COOPER



21659
(07-13-2-757-821)
Gray Nylon

Moulding Clip
Top Head Size: 11mm x 19mm
Bottom Head Diameter: 21mm
Stem Length: 11mm
Mini-Cooper
2002 – On

UNIT PACKAGE: 15



21527
(07-13-7-073-915)
White Nylon

Trim Panel & Fender Flare
Moulding Clip
Top Head Size: 11.5mm x 19mm
Bottom Head Diameter: 21mm
Stem Length: 13mm
Fits Into 8mm Hole
Mini Cooper S
2002 – On

UNIT PACKAGE: 15



21143
(51-71-1-496-621)
Black Nylon

Rocker Moulding Retainer
Head Size: 8.5mm x 14mm
Stem Size: 5mm x 7.5mm
Stem Length: 14mm
Mini Cooper
2002 – On

UNIT PACKAGE: 25



21137
(07-13-0-702-516)
Black Nylon

Rear Quarter Wheel Opening
Moulding Retaining Clip
Top Head Diameter: 13mm
Middle Head Diameter: 15mm
Bottom Head Diameter: 15mm
Stem Diameter: 10mm
Stem Length: 8mm
Fits Into 8mm Hole
Mini Cooper
2002 – On

UNIT PACKAGE: 25



21139
(07-14-7-145-753)
White Nylon

Body Side Moulding Retainer
With Sealer
Top Head Diameter: 12mm
Middle Head Diameter: 15mm
Bottom Head Diameter: 18mm
Stem Diameter: 9.5mm
Stem Length: 11mm
Mini Cooper
2002 – On

UNIT PACKAGE: 25



21138
(51-43-7-001-491-2)
White Nylon

Headliner Retainer
Top Head Diameter: 14mm
Middle Head Diameter: 15mm
Bottom Head Diameter: 18mm
Stem Diameter: 9mm
Stem Length: 14mm
Mini Cooper
2005 – On

UNIT PACKAGE: 25



20570
(Mini-Cooper: 07-13-0-702-715;
Honda: 75307-SN7-000)

Wheel Opening
Nylon Moulding Nut
With Brass Insert
M4-0.7 Thread
12mm Flange O.D.
10mm Hex
Height: 11mm

UNIT PACKAGE: 15



(Not Actual Size)

21305
(Not Available From O.E.M.)
Natural Nylon

Push-Mount Cable Strap
Overall Length: 156mm (6-1/8")
Strap Width: 5mm (3/16")
Snaps Into 6.3mm (1/4") Hole
Maximum Bundle Diameter:
40mm (1-9/16")
European Makes & Universal

UNIT PACKAGE: 25

MITSUBISHI



19343
(MB608137)
Natural Nylon

Windshield Moulding Clip
Diamante
1995-91

UNIT PACKAGE: 15



19474
(MR154128)
Natural Nylon
Windshield Moulding Clip
Diamante
1997-On
UNIT PACKAGE: 15



19475
(MB608156)
Natural Nylon
Windshield Moulding Clip
With Adhesive Backing
Diamante
1996-91
UNIT PACKAGE: 10



19745
(MB880455)
Yellow Nylon
Windshield Moulding Clip
Montero
1992-On
UNIT PACKAGE: 10

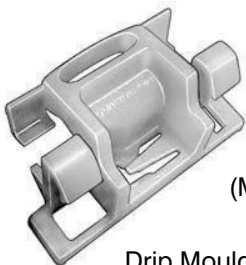

19314
(MB814419)
Nylon
Drip Moulding
& Garnish
Moulding Clip
Galant
1993-On
UNIT PACKAGE: 25



17195
Black Nylon
Grille Clip
13mm Wide
22mm Long
Ford Escort, Honda,
Isuzu, Mitsubishi & Plymouth Laser
UNIT PACKAGE: 25



21623
(Mitsubishi: MR221507;
Toyota: 90467-13075)
Gray Nylon
Radiator Grille Clip
Width: 14mm
Length: 24mm
Mitsubishi Diamante, Endeavor
& Galant
1997 - On
Toyota 4 Runner, Highlander
& Land Cruiser
1998 - On
UNIT PACKAGE: 25



20572
(MB846992)
White Nylon
Rocker Panel Retainer
Top Head Diameter: 12mm
Bottom Head Diameter: 16mm
Stem Length: 14mm
Fits Into 7mm Hole
Montero
2001 - On
UNIT PACKAGE: 10



19330
(MB608140)
White Nylon
Trunk Air Dam
Side Moulding Clip
Diamante
1991-On
UNIT PACKAGE: 10



21632
(MU480001)
Natural Nylon
M3.5(#6) Screw Size
Head Size: 10mm x 10mm
Stem Length: 7mm
Fits Into 6mm x 6mm Hole
Mitsubishi Eclipse and Chrysler
Avenger, Colt, Jeep Eagle Talon,
Laser & Sebring
2000 - 1984
UNIT PACKAGE: 50



14255
(Mitsubishi: MS-480001;
Honda: 75522-611-0000;
Mazda: 9991-00-412)
Black Nylon
#8 Screw Size
9.5mm Wide
9.5mm Long
Snaps Into 7mm x 7mm Hole
UNIT PACKAGE: 50



19487
(MB419858)
Natural Nylon
Scuff Plate Screw Grommet
#6 Screw Size
Diamante
1995-91
UNIT PACKAGE: 15



13932
(Mitsubishi: MS-480002;
Toyota: 90189-05013)
Natural Nylon
#10 Screw Size
12mm Wide
12mm Long
Fits Into 8mm x 9mm Hole
UNIT PACKAGE: 50



19485

Natural Nylon

#14 (M6.3) Screw Size
Fits Into 3/8" x 3/8" Hole
Eclipse

UNIT PACKAGE: 10



20573

(MB817060)

White Nylon

Headliner Nylon Nut
Head Diameter: 15mm
Inside Diameter: 6mm
Stem Length: 11mm
Fits Into 9mm Hole
Montero
1997 - On

UNIT PACKAGE: 15



14335

(Mitsubishi: MB-106212;
Nissan: 96706-H9400,
-K1300,-K1351)
Natural Nylon

Screw Grommet
#8 Screw Size
Head Diameter: 13.5mm
Stem Length: 16mm
Fits Into 6mm x 6mm Hole

UNIT PACKAGE: 50



14695

(Mitsubishi: MS-480012;
Honda: 90661-SC7-0030;
Mazda: H001-50-841;
Nissan: 01651-00481, 74798-S9000;
Toyota: 90189-06042)
White Nylon

Screw Grommet
#8 Screw Size
Head Diameter: 16mm
Stem Length: 17mm
Fits Into 8mm x 8mm Hole

UNIT PACKAGE: 25



19322

(MU480034)

Natural Nylon

Rear Side & Trunk Trim
Screw Grommet
#8 Screw Size
Eclipse
1994-On

UNIT PACKAGE: 15



14275

(Mitsubishi: MB-098145;
Nissan: 01281-00023, 01281-00231;
Toyota: 90189-06001)
White Nylon

Screw Grommet
#10 Screw Size
Head Diameter: 18mm
Stem Length: 17mm
Fits Into 8.5mm x 8.5mm Hole

UNIT PACKAGE: 25



20581

(MR478263)

Black Rubber

Bumper Cover &
Garnish Moulding Grommet
With Sealer
Head Diameter: 16mm
Stem Length: 20mm
Fits Into 9mm Hole
Use With Auveco 20580
Chrysler Sebring & Stratus
And Mitsubishi Eclipse
2000 - On

UNIT PACKAGE: 15



20565

(MB271999)

Black Nylon

Bumper Cover Grommet
Head Diameter: 24mm
Stem Length: 21mm
Fits into 13mm Hole
Chrysler Colt, Eagle, Sebring
& Stratus 1989 - On
Mitsubishi Eclipse, Galant
& Mirage 1993 - On

UNIT PACKAGE: 10



19324

(MB888561)

Natural Nylon

Drip Moulding Screw Grommet
#8 Screw Size
Eclipse
1994-On

UNIT PACKAGE: 25



21025

(MB645307)

Black Nylon

Back Glass Lower Moulding,
Quarter Glass Moulding &
Spoiler Grommet With Sealer
Head Size: 12mm x 16mm
Stem Length: 14mm
Dodge Avenger & Stealth and
Chrysler Sebring
1991 - On
Mitsubishi
1991 - On

UNIT PACKAGE: 15



19331

(MB869072)

Black Nylon

Headliner & Trunk Trim
Retaining Clip
Head Diameter: 14mm
Stem Length: 11mm
Fits Into 7mm Hole
Diamante
1995-91

UNIT PACKAGE: 15



20381

(Honda: 90667-671-013ZA;
Mitsubishi: MC440901;
Nissan: 62660-48600-1)
Black Nylon

Trim Panel Retaining Clip
Head Diameter: 16mm
Stem Diameter: 7mm
Stem Length: 16mm
Honda, Mitsubishi &
Nissan
UNIT PACKAGE: 25



19334

(MB566720)
Natural Nylon

Rear Pillar Trim &
Air Inlet Grille Retainer
Small Head Diameter: 12mm
Large Head Diameter: 16mm
Stem Diameter: 9mm
Stem Length: 15
Eclipse
1994-On
UNIT PACKAGE: 15



21118

(MB374270, MB374271)
White Nylon

Trim Panel Retainer
Top Head Diameter: 13mm
Middle Head Diameter: 16mm
Bottom Head Diameter: 18mm
Stem Diameter: 10mm
Stem Length: 14mm
Chrysler Laser, Dodge Stealth,
Jeep Eagle & Talon and
Mitsubishi Eclipse & Montero
1989 - On
UNIT PACKAGE: 15



14720

(HB-121467)
Black Nylon

Retaining Clip
Head Diameter: 18mm
Shank Length: 15mm
Snaps Into 8mm Hole
Panel Thickness: 5mm
UNIT PACKAGE: 25



19320

(MB696120)
White Nylon

Side Garnish &
Moulding Trim Retainer
Small Head Diameter: 12mm
Large Head Diameter: 16mm
Stem Diameter: 9mm
Stem Length: 11mm
Eclipse
1994-On
UNIT PACKAGE: 15



19325

(MU481027)
Brown Nylon

Hood Weatherstrip
Retainer
Head Size: 5mm x 13mm
Stem Diameter: 7mm
Stem Length: 6mm
Eclipse & Diamante
1991-On
UNIT PACKAGE: 25



19323

(MU481187)
Black Nylon

Hood Insulation Retainer
Head Diameter: 26mm
Stem Diameter: 10mm
Stem Length: 8mm
Diamante
1993-On
UNIT PACKAGE: 15



20571

(MR435918)
White Nylon

Rocker Panel Retainer
Top Head Diameter: 13mm
Bottom Head Diameter: 18mm
Stem Diameter: 9mm
Stem Length: 9mm
Montero
2001 - On
UNIT PACKAGE: 15



21658

(MR288150)
Black Nylon

Push-Type Retainer
Head Diameter: 15mm
Stem Length: 11mm
Fits Into 6mm Hole
Endeavor, Galant, Lancer,
Mirage, Montero & Outlander
1997 - On
UNIT PACKAGE: 10



19385

(MB020923)
Gray Nylon

Hood Insulation Retainer
Head Diameter: 26mm
Stem Diameter: 10mm
Stem Length: 8mm
Jeep Eagle &
Mitsubishi Eclipse
1992-On
UNIT PACKAGE: 10



21140
(MB619582)
Black Nylon

Interior Trim, Bumper & Grille
Push-Type Retainer
Head Diameter: 15mm
Stem Length: 12mm
Fits Into 6.3mm Hole
Eclipse, Endeavor, Lancer &
Outlander
2002 - On

UNIT PACKAGE: 25



20580
(MR478262)
Black Nylon

Bumper Cover &
Garnish Moulding
Push-Type Retainer
Top Head Diameter: 15mm
Bottom Head Diameter: 14mm
Stem Length: 12mm
Fits Into 7mm Hole
Use With Auveco 20581
Chrysler Sebring & Stratus
And Mitsubishi Eclipse
2000 - On

UNIT PACKAGE: 15



19239
(Honda: 91512-SX0-003;
Mitsubishi: MU000319;
GM: 11519949)
Black Nylon

Front Fender &
Bumper Support
Push-Type Retainer
Head Diameter: 20mm
Stem Length: 11mm
Fits Into 8mm Hole
Acura 3.5RL, Honda Accord,
Prelude & Odyssey
1994-On
Mitsubishi Lancer
2002-On
GM 1997 - On

UNIT PACKAGE: 25



20247
(MR200300)
Black Nylon

Fender & Bumper
Push-Type Retainer
Head Diameter: 18mm
Stem Length: 12mm
Fits Into 9mm Hole
Honda & Mitsubishi
1998 - On

UNIT PACKAGE; 15



17351
(MB-253964)
Black Nylon

Front & Rear Bumper
Push-Type Retainer
Head Diameter: 17mm
Stem Length: 10mm
Fits Into 7mm Hole
Tredia
1988-83

UNIT PACKAGE: 10



17472
(Mitsubishi: MB547806;
Nissan: 63854-01A00)
Black Nylon

Front Bumper Fascia
Push-Type Retainer
Head Diameter: 20mm
Stem Length: 20mm
Fits Into 8mm Hole

UNIT PACKAGE: 15

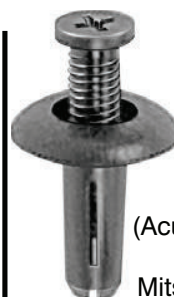

19140
(Acura: 90505-SL0-003;
GM: 94852638;
Mitsubishi: MB888869;
Toyota: 90467-08155)
Black Nylon

Push-Type Retainer
Head Diameter: 20mm
Stem Length: 21mm
Fits Into 8mm Hole
Acura, Dodge Avenger,
Eagle Talon, Geo Prizm, Mitsubishi
Eclipse & Galant
and Toyota
1993-On

UNIT PACKAGE: 5

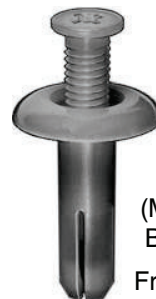

18951
(MR-138807)
Black Nylon

Front Bumper
& Support
Push-Type Retainer
Head Diameter: 20mm
Stem Length: 26mm
Fits Into 8mm Hole
Eclipse
1994-On

UNIT PACKAGE: 5



19328
(MR201466)
White Nylon

Trunk Trim Cap
Eclipse
1994-On

UNIT PACKAGE: 15



20380

(Not Supplied By O.E.M.)
Black Nylon

Cable Strap
Length: 200mm (8")
5mm (3/16") Wide
Max. Bundle Dia: 44mm (1-3/4")
Fits Into 6.3mm (1/4") Hole
Import Cars

UNIT PACKAGE: 25



13225

Plated

"U" Type Nut
4.2mm (#8) Screw Size
11mm Wide 16.5mm Long
Panel Range: .5mm-2.5mm
Center of Hole to Edge: 8mm

UNIT PACKAGE: 50

HELPFUL HINTS FOR USING THE AUVECO CATALOG

1. **The color-coded pages** signify various sections which are as follows:
 BLUE-Metric Items
 BEIGE-Electrical Accessories
 GREEN-Assortments, Cabinets, Bins & Racks
 GRAY-Key Blanks & Accessories
 PINK-Import Car Body Hardware
2. Most pictures and illustrations are actual size.
3. We have **Specification Charts** for:
Body Bolts (pages 20 & 49-50)
Special Tapping Screws (pages 23-26 & 54-57)
License Plate Screws (pages 33-34)
"Xmas Tree" Retainers (pages 404-413)
Push-Type Retainers (pages 450-460)
4. We have **three different types of indexes** in the front of the catalog to assist you.
 PICTORIAL QUICK INDEX
 ALPHABETICAL INDEX
 NUMERICAL INDEX
5. There are two OEM Part Cross References at the back of the catalog.



19738
(80897-10Y00)
Natural Nylon

Door Panel Clip
Width: 12mm
Length: 25mm
Stem Length: 16mm
Fits Into 6mm Hole
Altima, Infiniti & Sentra
1997 - On

UNIT PACKAGE: 15



21085
(Not Available
From O.E.M.)
Light Blue Nylon

Rocker Panel
Moulding Clip
Overall Height: 15mm
Stem Length: 9mm
Murano
2003 - On

UNIT PACKAGE: 15



21618
(01553-08911)
White Nylon

Scuff Plate
Moulding Clip
Top Head Size: 12mm x 15mm
Bottom Head Diameter: 16mm
Stem Length: 12mm
Fits into 8.5mm Hole
Maxima
1999 - On

UNIT PACKAGE: 15



16860
(62318-01W00)
Dark Gray Nylon

Grille Clip
Overall Height:
21.5mm (27/32")

UNIT PACKAGE: 25



21291
(76988-4N000)
White Nylon

Moulding Clip
Top Head Size: 8mm x 15mm
Bottom Head Diameter: 15mm
Stem Diameter: 5.3mm
Stem Length: 9mm
Quest & 370Z
2004 - On

UNIT PACKAGE: 25



20873
(73858-8J000)
Black Nylon

Drip Rail Moulding Clip
Width: 13.5mm
Length: 31mm
Nissan
2000 - On

UNIT PACKAGE: 10



21121
(01553-03831)
Black Nylon

Grille Clip
Overall Height: 22mm (7/8")
Maxima & Stanza
1982 - On

UNIT PACKAGE: 25



21285
(76882-EG01A)
Black Nylon

Rocker Panel
Moulding Clip
With Sealer
Top Head Size: 10mm x 15mm
Bottom Head Size: 18mm
Stem Length: 12mm
Fits Into 8mm Hole
Altima and Maxima
2010 - On

UNIT PACKAGE: 15



20961
(Not Available From O.E.M.)
White Nylon

Drip Moulding Clip
With Sealer
Top Width: 25mm
Overall Height: 16mm
Fits Into 5mm Hole
Infiniti M45, I30 & G35
2005 - On
Nissan Altima, Maxima
& 350Z
2002 - On

UNIT PACKAGE: 15



21619
(76882-0M060)
Black Nylon

Grille Clip
Overall Height: 25mm (1")
Frontier, Krom & SL
2006 - On

UNIT PACKAGE: 15

Sec. 22**NISSAN CLIPS & FASTENERS****20614**
(66820-3S510)
White NylonCowl Vent Retainer
Head Size: 10mm x 18mm
Stem Diameter: 6mm
Stem Length: 13mm
Frontier & Xterra
1998 - On

UNIT PACKAGE: 25

**21117**
(85284-CD000)
White NylonBumper Retainer
With Sealer
Head Diameter: 22mm
Stem Length: 21mm
Overall Length: 39mm
Nissan
2004 - On

UNIT PACKAGE: 10

**15469**
NylonWindshield Reveal Moulding Clip
15mm Wide, 25.5mm Long
Nissan & Mazda

UNIT PACKAGE: 25

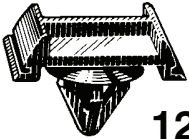
**12583**
(76884-90100)
NylonStep Moulding Clip
24mm Wide
14mm Long
Snaps Into 8mm Hole

UNIT PACKAGE: 15

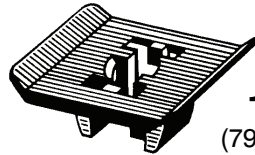
**14333**
(79896-P7100)
NylonMoulding Clip
27mm Wide; 25mm Long
Fits Into 14mm x 16mm Hole

UNIT PACKAGE: 10

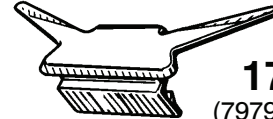
**17349**
(79796-71E00)
NylonWindow Reveal Moulding Clip
Back Glass
Maxima
1990-On

UNIT PACKAGE: 25

**12585**
(255 Y 3616-10)
NylonSide Window Moulding Clip
12mm Wide
12mm Long
Snaps Into 5mm Hole

UNIT PACKAGE: 15

**15468**
(72826-01P00)
NylonWindshield Moulding Clip
11mm Wide, 40mm Long
300ZX
1984-On

UNIT PACKAGE: 15

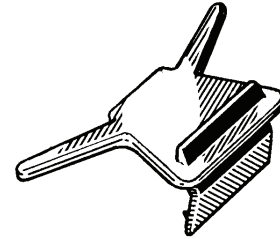
**15470**
(72727-W1000)
White NylonWindshield Reveal Moulding Clip
21mm Wide, 40mm Long

UNIT PACKAGE: 15

**21617**
(76882-0E700)
White NylonRocker Moulding Clip
Top Head Size: 14mm x 14mm
Bottom Head Diameter: 16mm
Stem Length: 10mm
Altima
1996 - On

UNIT PACKAGE: 15

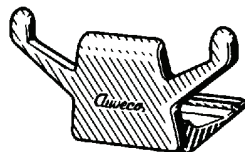
**17348**
(73856-51E00)
NylonRoof Side Moulding Clip
Stanza
1990-On

UNIT PACKAGE: 25

**21097**
(Not Available From O.E.M.)
Black NylonWindshield Moulding Clip
Width: 22mm
Length: 46mm
Altima
2004 - On

UNIT PACKAGE: 25

NISSAN CLIPS & FASTENERS

Sec. 22

Not Actual Size



18113

(69951-12180)

Nylon With
Steel Threaded Insert

Glass Mount
M6-1.0 Thread
Nissan, Ford & Imports

UNIT PACKAGE: 5

Not Actual Size

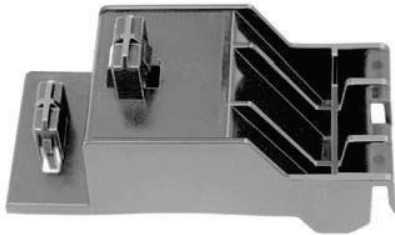

21108

(62228-7Y000)

Black Nylon

Front Bumper Cover
Width: 40mm
Length: 93mm
Maxima & Quest
2004 - On

UNIT PACKAGE: 5



13931

(26023-H1000)

White Nylon

Screw Grommet
For Headlight Adjusting Screws
Use With 5mm Screws
14mm Wide
14mm Long

UNIT PACKAGE: 50



13930

(Nissan: 96706-B0700;
Mazda: 9991-00-412)
White Nylon

#8 Screw Size
9.5mm Wide 9.5mm Long
Snaps Into 7mm x 7mm Hole

UNIT PACKAGE: 50



14274

(Mazda: 9991-00-601;
Honda: 75521-611-0000;
Nissan: 96706-P0105;
Toyota: 90189-06010)
Natural Nylon

#10 Screw Size
13mm Wide; 13mm Long
Snaps Into 8.5mm x 8.5mm Hole

UNIT PACKAGE: 25



19897

(76881-9E000)
Green Nylon

Door Panel Sash
Screw Grommet
M4.2 (#8) Screw Size
Head Size: 10mm Sq.
Stem Length: 8mm
Maxima
1999 - On

UNIT PACKAGE: 25



14334

(96706-N8000)
Natural Nylon

#8 Screw Size
12mm Wide; 15mm Long
Fits Into 8mm x 12mm Hole

UNIT PACKAGE: 25



14313

(Nissan: 62698-V7000,
68425-H5000;
Honda: 90662-671-0030;
Mazda: 9991-00-503)
Natural Nylon

#10 Screw Size
17mm Wide; 17mm Long
Snaps Into 8mm x 8.5mm Hole

UNIT PACKAGE: 25

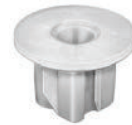

20764

(01281-00831)
Natural Nylon

Bumper, Fender & Light
Screw Grommet
M4.2 (#8) Screw Size
Head Diameter: 16mm
Stem Length: 10mm
Fits Into 9mm x 9mm Hole
Nissan 240SX, Altima,
Frontier, Maxima, Pathfinder,
Quest & Xterra And Infiniti
1989 - On

UNIT PACKAGE: 25



14331

(01281-00022)
Natural Nylon

#10 Screw Size
Head Diameter: 13mm
Fits Into 8mm x 8mm Hole

UNIT PACKAGE: 50



17342

(01281-00441)
Black Nylon

Front Bumper Apron
Nylon Nut
#10 Screw Size
15mm Head Diameter
Snaps Into 8mm x 8mm Hole
Stanza
1990-On

UNIT PACKAGE: 25



20266

(62319-0W000)
Natural Nylon

Front Bumper
Nylon Nut
M5.5 (#12) Screw Size
Head Dia: 16mm
Stem Length: 11mm
Frontier Truck
1997 - On

UNIT PACKAGE: 10



20257
(76848-50Y00)
Blue Nylon

Windshield Moulding
Screw Grommet
Head Size: 12mm x 16mm
Stem Length: 12mm
M3.5 (#6) Screw Size
Maxima
1999 - On

UNIT PACKAGE: 10



14724
(96706-H2500)
Natural Nylon

Screw Grommet
#6 Screw Size
Head Diameter: 11.5mm
Stem Diameter: 9.5mm
Fits Into 7mm x 7mm Hole

UNIT PACKAGE: 25



14366
(Nissan: 96706-89901;
Mazda: 9991-00-402)
Natural Nylon

Screw Grommet
#6 Screw Size
9.5mm Wide; 9.5mm Long
Stem Length: 16mm
Fits Into 7mm x 7mm Hole

UNIT PACKAGE: 50



21367
(01281-00501)
White Nylon

Body Side Moulding
Screw Grommet
With Sealer
M3.5 (#6) Screw Size
Head Size: 9.5mm x 9.5mm
Stem Length: 16mm

UNIT PACKAGE: 15



14335
(Nissan: 96706-H9400;
-K1300, -K1351;
Mitsubishi: MB-106212)
Natural Nylon

Screw Grommet
#4 Screw Size
Head Diameter: 13.5mm
Stem Length: 16mm
Fits Into 6mm x 6mm Hole

UNIT PACKAGE: 50



14695
(Nissan: 01651-00481
74798-S9000;
Honda: 90661-SC7-0030;
Mazda: H001-50-841;
Mitsubishi: MS-480012;
Toyota: 90189-06042)
White Nylon

Screw Grommet
#8 Screw Size
Head Diameter: 16mm
Stem Length: 17mm
Fits Into 8mm x 8mm Hole

UNIT PACKAGE: 25



21324
(01281-00691)
Natural Nylon

Screw Grommet
With Sealer
4.2 (#8) Screw Size
Head Diameter: 16mm
Stem Length: 20mm
Nissan 240SX, Altima, Frontier,
Maxima, Pathfinder & Titan
and Infiniti I30, I35 & Q45
1989 - On

UNIT PACKAGE: 15



20604
(01281-00711)
Natural Nylon

Rocker Moulding
Screw Grommet
M4.2 (#8) & M4.8 (#10) Screw Size
Head Diameter: 20mm
Stem Length: 15mm
Nissan & Infiniti
1995 - On

UNIT PACKAGE: 10



14275
(Nissan: 01281-00023,
01281-00231;
Mitsubishi: MB-098145;
Toyota: 90189-06001)
White Nylon

Screw Grommet
#10 Screw Size
Head Diameter: 18mm
Stem Length: 17mm
Fits Into 8.5mm x 8.5mm Hole

UNIT PACKAGE: 25



21621
(01553-02913)
White Nylon

Moulding Grommet
With Sealer
M4.2 (#8) Screw Size
Head Diameter: 14mm
Stem Length: 8mm
Fits Into 8mm Hole
Nissan Frontier, Pathfinder &
Titan and Infiniti QX4 & QX56
1996 - On

UNIT PACKAGE: 15



19293
(01281-00601)
Natural Nylon

Body Side Moulding
Floor & Trunk
Screw Grommet
M4.8 (#10) Screw Size
Maxima, Sentra,
240SX & 300ZX
1986-On

UNIT PACKAGE: 15

E-mail Your New
Item Suggestions
For Individual Products
And
Assortments To
mail@auveco.com



21111

(01281-00331)
Natural Nylon

Bumper, Rocker Panel
& Light Mounting
Screw Grommet
With Sealer
M6.3 (#14) Screw Size
Head Diameter: 20mm
Stem Length: 16mm
Fits Into 10mm Square Hole
Infiniti
1997 - On
Nissan
1996 - On

UNIT PACKAGE: 25



20736

(01281-01081)
Natural Nylon

Front Bumper Nylon Nut
M4.8 (#10) Screw Size
Flange Diameter: 16mm
Overall Length: 22mm
Nissan & Infiniti
1997 - On

UNIT PACKAGE: 15



14690

(Nissan: 78856-R4301,
Honda: 90683-693-0000)
White Nylon

Screw Grommet
#10 Screw Size
12mm Wide; 19mm Long
Stem Length: 17mm
Fits Into 8mm x 15mm Hole

UNIT PACKAGE: 25



21622

(76848-71S00)
Yellow Nylon

Pillar Moulding Grommet
With Sealer
M5.5 (#12) Screw Size
Head Size: 15.4mm x 19mm
Stem Length: 15mm
Nissan 370Z & Quest and
Infiniti G37 & Q45
2002 - On

UNIT PACKAGE: 15



20166

(76881-0P000)
Natural Nylon

Window Moulding
Screw Grommet
#8 Screw Size
Head Size: 16mm x 22mm
Stem Length: 16mm
Sentra & Stanza
1994 - On

UNIT PACKAGE: 15



20786

(76848-8J010)
Black Nylon

Headlight Assembly Grommet
Head Size: 17mm x 23mm
Stem Length: 10mm
Altima
2002 - On

UNIT PACKAGE: 10



17196

(62380-U7400)
Black Nylon

Grille Grommet
22mm Wide, 26mm Long
Nissan 1987-On

UNIT PACKAGE: 10



21318

(01281-0005U)
Black Nylon

Grille Grommet
Head Diameter: 20mm
Stem Length: 13mm
Fits Into 11mm Hole
Frontier & Titan
2005 - On

UNIT PACKAGE: 25



19736

(76988-3J000)
White Nylon

Kick Plate Retainer Grommet
Head Size: 14mm x 34mm
Stem Length: 14mm
Altima
1997-On

UNIT PACKAGE: 15



20790

(85222-0M000)
Black Nylon

Rear Bumper
Fascia Clip
With Sealer
Overall Height: 35mm
Stem Length: 16mm
Pathfinder
2004 - On

UNIT PACKAGE: 5

Sec. 22**NISSAN CLIPS & FASTENERS****20813**(63846-9E000)
Natural NylonRear Bumper
Moulding Grommet
With Sealer
Head Size: 18mm x 18mm
Stem Length: 15mm
Altima
2001 - 1998

UNIT PACKAGE: 15

**21229**(65810-K2000)
Black NylonHood Seal
Retaining Clip
Head Size: 6.4mm x 16mm
Stem Diameter: 3.5mm x 6mm
Stem Length: 10mm
Nissan Maxima & Pathfinder and
Infiniti I30, I35, Q45 & QX4
2004 - 1996

UNIT PACKAGE: 25

**14352**(76876-W5000)
Black NylonRetaining Clip
Head Diameter: 13mm
Stem Length: 13mm
Fits Into 5mm Hole
Panel Thickness: 4mm
UNIT PACKAGE: 50**17633**(66820-88E00)
NylonCowl Screen Pin Retainer
Maxima
1990-On

UNIT PACKAGE: 25

**17634**(01553-01781)
Black NylonCowl Grille Retainer
Head Dia: 12mm
Stem Length: 16mm
Stem Dia: 6mm
240SX
1990-On

UNIT PACKAGE: 25

**17452**(01553-00545)
Black NylonBumper Fascia Retainer
Head Diameter: 13mm
Stem Length: 15mm
Fits Into 5mm Hole
Sentra
1990-On

UNIT PACKAGE: 25

**21588**(80850-CA003)
Black NylonWeatherstrip Retainer
Head Diameter: 8mm
Stem Diameter: 5.3mm
Stem Length: 7mm
Murano & Rouge
2003 - On

UNIT PACKAGE: 25

**14355**(01553-00401)
Black NylonRetaining Clip
Head Diameter: 11mm
Stem Length: 13mm
Snaps Into 5mm Hole
Panel Range: 4mm

UNIT PACKAGE: 50

**14737**(Nissan: 01553-00172;
Toyota: 90467-07050)
Black NylonRetaining Clip
Head Diameter: 13mm
Stem Length: 15mm
Fits Into 5mm Hole
Panel Thickness: 3mm

UNIT PACKAGE: 25

**21295**(01553-08961)
Black NylonWeatherstrip Retaining Clip
Head Diameter: 10mm
Stem Diameter: 6mm
Stem Length: 8mm
Altima
2009 - On

UNIT PACKAGE: 25

**14349**(Mazda: 9926-40-543A;
Nissan: 01553-00291)
Black NylonRetaining Clip
Head Diameter: 11mm
Stem Length: 15mm
Fits Into 5.5mm Hole
Panel Thickness: 5mm

UNIT PACKAGE: 50

**14723**(62869-N4700)
Black NylonRetaining Clip
Head Diameter: 14mm
Stem Length: 11mm
Fits Into 6mm Hole
Panel Thickness: 4mm

UNIT PACKAGE: 25

NISSAN CLIPS & FASTENERS

Sec. 22



14353
(76906-T3000)
Black Nylon
Retaining Clip
Head Diameter: 14mm
Stem Length: 16mm
Snaps Into 6mm Hole
Panel Thickness: 5mm
UNIT PACKAGE: 50



20671
(01553-0052U)
Black Nylon
Trim Panel
Retaining Clip
Head Diameter: 20mm
Stem Diameter: 9.5mm
Stem Length: 15mm
Frontier Xterra
2000 - On
UNIT PACKAGE: 25



20256
(01553-01182)
Black Nylon
Splash Shield Retainer
Head Dia: 15mm
Stem Dia: 4.5mm
Stem Length: 14mm
Frontier Truck
1997 - On
UNIT PACKAGE: 50



14348
(27948-M7002)
Black Nylon
Retaining Clip
Head Diameter: 16mm
Stem Length: 15mm
Snaps Into 5mm Hole
Panel Thickness: 4mm
UNIT PACKAGE: 25



14356
(01553-00051)
Black Nylon
Retaining Clip
Head Diameter: 20mm
Stem Length: 16mm
Snaps Into 7mm Hole
Panel Thickness: 7mm
UNIT PACKAGE: 50

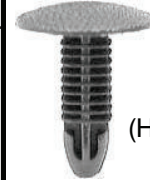

16776
(Honda: 90667-SAO-0030;
Nissan: 76996-01P02)
Black Nylon
Trim Panel Retainer
Head Dia: 18mm
Stem Length: 20mm
Fits Into 6mm Hole
UNIT PACKAGE: 25



20381
(Honda: 90667-671-013ZA;
Mitsubishi: MC440901;
Nissan: 62660-48600-1)
Black Nylon
Trim Panel Retaining Clip
Head Diameter: 16mm
Stem Diameter: 7mm
Stem Length: 16mm
Honda, Mitsubishi & Nissan
UNIT PACKAGE: 25



18948
(Nissan: 01553-0075U;
GM: 1644290)
Black Nylon
Hood Insulation Retainer
Head Diameter: 11mm
Stem Diameter: 5.5mm
Stem Length: 17.5mm
Altima & Maxima
2002 - On
UNIT PACKAGE: 25



16775
(Honda: 90667-SA7-0030;
Nissan: 89427-98070)
Black Nylon
Trim Panel Retainer
Head Dia: 20mm
Stem Length: 15mm
Fits Into 5mm Hole
UNIT PACKAGE: 25



14347
(Nissan: 01553-00202;
Toyota: 90467-10018)
Black Nylon
Retaining Clip
Head Diameter: 18mm
Stem Length: 12mm
Snaps Into 7mm Hole
Panel Thickness: 4mm
Nissan & Toyota
UNIT PACKAGE: 50



21519
(01553-01A50)
Black Nylon
Bumper & Trim Retainer
Head Diameter: 12mm
Stem Diameter: 6mm
Stem Length: 15mm
Infiniti FX35, G35, G37, M35,
M45 & Q45 and Nissan 350Z
& 370Z
1997 - On
UNIT PACKAGE: 25

Remember....
All Items In This
Catalog
Are Available In Bulk.
Call For A Quote

Sec. 22**NISSAN CLIPS & FASTENERS****21288**(65846-4Z000)
Black NylonHood Insulation Retainer
Head Diameter: 28mm
Stem Diameter: 6mm
Stem Length: 10mm
Altima
2010 - On

UNIT PACKAGE: 15

**20669**(01553-07111)
Black NylonTrim Panel Retainer
Top Head Diameter: 13mm
Middle Head Diameter: 15mm
Bottom Head Diameter: 18mm
Stem Diameter: 9mm
Stem Length: 15mm
Nissan Altima and Infiniti G35 & Q45
1997 - On

UNIT PACKAGE: 25

**20670**(01553-02821)
Gray NylonTrim Panel Retainer
Top Head Diameter: 13mm
Middle Head Diameter: 16mm
Bottom Head Diameter: 18mm
Stem Diameter: 8.5mm
Stem Length: 12mm
Maxima
1988 - On

UNIT PACKAGE: 15

**17237**(65832-F5000,
65846-30F00)
Black NylonHood Insulation Retainer
O.D.: 38mm
Stem Dia: 7mm
Stem Length: 9mm
Nissan
1981-On

UNIT PACKAGE: 15

**21414**(80999-VE000)
White NylonTrim Panel Retainer
With Sealer
Top Head Diameter: 13mm
Middle Head Diameter: 16mm
Bottom Head Diameter: 18mm
Stem Diameter: 9mm
Stem Length: 13mm
Infiniti & Nissan
1993 - On

UNIT PACKAGE: 25

**13945**(01553-S3500)
White NylonDoor Trim
Panel Retainer
Trucks

UNIT PACKAGE: 50

**20672**(66820-3S500-C1)
White NylonCowl Vent Retainer
Top Head Diameter: 13mm
Bottom Head Diameter: 16mm
Stem Diameter: 4mm
Stem Length: 13mm
Frontier & Xterra
1998 - On

UNIT PACKAGE: 25

**19731**(84915-0W000)
White NylonTrim Panel Retainer
Top Head Diameter: 13mm
Middle Head Diameter: 16mm
Bottom Head Diameter: 17mm
Stem Diameter: 9.5mm
Stem Length: 13mm
Pathfinder
1995 - On

UNIT PACKAGE: 15

**18166**(80875-85E00)
Black NylonTrim Panel Retainer
Head Diameter: 10mm
Stem Length: 10mm
Stem Diameter: 4mm
Maxima
1989-On

UNIT PACKAGE: 25

**21289**(84953-JA00A)
Yellow NylonTrim Panel Retainer
Top Head Diameter: 12.5mm
Middle Head Diameter: 16mm
Bottom Head Diameter: 18mm
Stem Diameter: 9.5mm
Stem Length: 14mm
Altima
2010 - On

UNIT PACKAGE: 25

**20668**(01553-09791)
White NylonTrim Panel Retainer
Top Head Diameter: 13mm
Middle Head Diameter: 16mm
Bottom Head Diameter: 18mm
Stem Diameter: 9mm
Stem Length: 14mm
Nissan & Infiniti
1999 - On

UNIT PACKAGE: 15

**21633**(80850-89900)
White NylonWeatherstrip Retainer
Head Size: 6mm x 16mm
Stem Diameter: 6.5mm
Stem Length: 12mm
Nissan Maxima and
Infiniti I30, I35 & M45
2004 - 2000

UNIT PACKAGE: 25

NISSAN CLIPS & FASTENERS

Sec. 22



19724
(65810-K2009)
White Nylon

Hood To Cowl Seal Retainer
Head Size: 6mm x 16mm
Stem Length: 15mm
Fits Into 5mm Hole
Infiniti & Pathfinder
1992 - On

UNIT PACKAGE: 25



16859
(Nissan: 66860-01W01;
GM: 94051993)
Black Nylon

Cowl Panel To
Reinforcement Plate &
Engine Splash Shield Ret.
Head Dia: 14mm (9/16")
Stem Length: 16mm (5/8")
Fits Into 6mm (1/4") Hole
Nissan 1980-On
Geo Storm 1990-On

UNIT PACKAGE: 25



14726
(63844-01A99)
Black Nylon

Push-Type
Retainer
Head Diameter: 17mm
Stem Length: 18mm
Fits Into 8mm Hole

UNIT PACKAGE: 25



19684
(01553-09311)
Blue Nylon

Weatherstrip Retainer
Head Size: 7mm x 16mm
Stem Length: 12mm
Fits Into 6mm Hole
Altima &
Sentra
1994-On

UNIT PACKAGE: 25



14696
(Nissan: 10998-30880;
Honda: 90684-SA5-003;
Isuzu: 8942981190)
Black Nylon

Push-Type Retainer
Head Dia: 15mm
Stem Length: 11mm
Fits Into 6mm Hole

UNIT PACKAGE: 25



16784
(Nissan: 80999-05N07;
Toyota: 90467-07043)
Black Nylon

Push-Type Retainer
Head Dia: 18mm
Stem Length: 11mm
(Not Including The Pin)
Fits Into 7mm Hole

UNIT PACKAGE: 25



16783
(66824-01G00)
Black Nylon

Push-Type Retainer
Head Dia.: 12mm
Stem Length: 8mm
(Not Including The Pin)
Fits Into 6mm Hole

UNIT PACKAGE: 25



21620
(01553-06071)
Black Nylon

Rear Duct Finishing Panel
Push-Type Retainer
Head Diameter: 15mm
Stem Length: 14mm
Fits Into 5mm Hole
Cube S, SL, Krom & Leaf
2012 - On

UNIT PACKAGE: 15



20349
(Nissan: 01553-09611;
Toyota: 90467-08185)
Black Nylon

Bumper Clip
Push-Type Retainer
Head Diameter: 18mm
Stem Length: 10mm
(Not Including The Pin)
Fits Into 8mm Hole

Maxima
1994 - On
Toyota & Lexus
2002 - On

UNIT PACKAGE: 15



21159
(66820-AX020)
Black Nylon

Cowl Vent & Outside Mirror
Push-Type Retainer
Head Diameter: 14mm
Stem Length: 10mm
Fits Into 6mm Hole
Pathfinder & Versa
2005 - On

UNIT PACKAGE: 15



18265
(76882-57A00)
Black Nylon

Body Side Moulding
Push-Type Retainer
Head Diameter: 16mm
Stem Length: 20mm
Fits Into 8mm Hole
Sentra
1986-On

UNIT PACKAGE: 25

Sec. 22**NISSAN CLIPS & FASTENERS****21311**
(01553-0038U)
Gray Nylon

Bumper
Push-Type Retainer
Head Diameter: 18mm
Stem Length: 12mm
Fits Into 8mm Hole
Frontier, Pathfinder & Xterra
2005 - On

UNIT PACKAGE: 10

**16782**
(Honda:
91545-SE0-0030-W;
Nissan:
63848-01G00)
Black Nylon

Push-Type Retainer
Head Dia: 20mm
Stem Length: 8mm
(Not Including The Pin)
Fits Into 8mm Hole

UNIT PACKAGE: 25

**21545**
(01553-08231)
Black Nylon

Front & Rear Bumper
and Grille
Push-Type Retainer
Head Diameter: 20mm
Stem Length: 15mm
Fits Into 8mm Hole
Nissan Murano, 240 SX & 350Z
and Infiniti FX35, FX45 & Q45
1995 - On

UNIT PACKAGE: 25

**19246**
(01553-09241)
Black Nylon

Bumper
Push-Type Retainer
Head Diameter: 18mm
Stem Length: 15mm
Fits Into 10mm Hole
240SX & Maxima
1994-On

UNIT PACKAGE: 15

**21631**
(84995-3J101)
Black Nylon

Push-Type Retainer
Head Diameter: 20mm
Stem Length: 8mm
(Not Including The Pin)
Fits Into 8mm Hole
Sentra
2007 - On

UNIT PACKAGE: 15

**16858**
(Nissan: 63844-01A00;
Kia: MNA01-56-145;
Mazda: NA01-56-145;
Ford: MNA01-56145,
NA01-56145)
Black Nylon

Inner Fender Push-Type Retainer
Head Dia: 20mm (25/32")
Stem Length: 18mm (23/32")
Fits Into 8mm (5/16") Hole
Nissan 1980-On
Mazda, Kia & Ford

UNIT PACKAGE: 25

**20613**
(63848-40Y00)
Black Nylon

Front Bumper
Push-Type Retainer
Head Diameter: 18mm
Stem Length: 20mm
Fits Into 9mm Hole
Frontier & Xterra
1998 - On

UNIT PACKAGE: 15

**16000**
(Honda:
90675-SB3-003;
Mazda: FB01-56-964;
Nissan: 63876-95596)
Black Nylon

Push-Type Retainer
Head Dia: 20mm
Stem Length: 9mm
Fits Into 8mm Hole

UNIT PACKAGE: 25

**20327**
(63848-9E001)
Black Nylon

Bumper Fascia
Push-Type Retainer
Head Diameter: 18mm
Stem Length: 19mm
(Not Including The Pin)
Fits Into 9mm Hole
Altima
1997 - On

UNIT PACKAGE: 10

**21134**
(01553-09431)
Black Nylon

Front Bumper
Push-Type Retainer
Head Diameter: 20mm
Stem Length: 11mm
(Not Including The Pin)
Fits Into 8mm Hole
Maxima
2004 - On

UNIT PACKAGE: 15

**20348**
(63878-01E10)
Black Nylon

Push-Type Retainer
Head Diameter: 20mm
Stem Length: 22mm
Fits Into 8mm Hole
Maxima
1994 - On

UNIT PACKAGE: 15

NISSAN CLIPS & FASTENERS

Sec. 22



19905
(01553-10051)
Black Nylon
Push-Type Retainer
Head Diameter: 20mm
Stem Length: 8mm
(Not Including The Pin)
Fits Into 8mm Hole
Maxima
1999 - On

UNIT PACKAGE: 15



19274
(01553-09321)
Black Nylon
Push-Type Retainer
Head Diameter: 20mm
Stem Length: 9mm
(Not Including The Pin)
Fits Into 8mm Hole
Maxima & 300ZX
1994-On

UNIT PACKAGE: 15



20953
(11296-AG000)
Black Nylon
Front Bumper And
Radiator Support
Push-Type Retainer
Head Diameter: 20mm
Stem Length: 13mm
(Not Including The Pin)
Fits Into 8mm Hole
Infiniti FX 35/45 and
Nissan Altima, Maxima
& Quest
2002 - On

UNIT PACKAGE: 25



17472
(Mitsubishi: MB547806;
Nissan: 63854-01A00)
Black Nylon
Front Bumper Fascia
Push-Type Retainer
Head Diameter: 20mm
Stem Length: 20mm
Fits Into 8mm Hole
300ZX
1990-On

UNIT PACKAGE: 15



17378
(01553-03101)
Black Nylon
Bumper & Fascia
Push-Type Retainer
Head Diameter: 22mm
Stem Length: 14mm
Fits Into 11mm Hole
Nissan
1986-On

UNIT PACKAGE: 15



20753
(01553-03201)
Black Nylon
Front & Rear Bumper
Push-Type Retainer
Head Diameter: 22mm
Stem Length: 21mm
Fits Into 8mm Hole
Nissan
1982 - On

UNIT PACKAGE: 10



17347
(01553-06721)
Black Nylon
Front & Rear Bumper Cover
Push-Type Retainer
Head Diameter: 20mm
Stem Length: 11mm
(Not Including The Pin)
Fits Into 8mm Hole
Maxima & Infiniti
1990-On

UNIT PACKAGE: 15



21361
(GM: 11561874;
Nissan: 622A2-9E000A)
Black Nylon
Bumper Cover
Push-Type Retainer
Head Diameter: 25mm
Stem Length: 29mm
Fits Into 7mm Hole
Chevrolet Malibu
2008 - On
Saturn Aura
2007 - On
Pontiac G6
2010 - On
Nissan Altima
1997 - On

UNIT PACKAGE: 15



16725
(66814-01G00)
Black Nylon
Cowl Grille Retainer
Head Size: 8mm x 12mm
Stem Length: 8mm
Fits Into 6mm Square Hole
Nissan Pick-Up
1986-On

UNIT PACKAGE: 25



14725
(66824-W1000)
Black Nylon
Push-Type Retainer
Head Width: 12mm
Head Length: 18mm
Stem Length: 10mm
Fits Into 6mm Hole

UNIT PACKAGE: 15



14727

(Nissan: 63844-D0100;
GM: 94221150; Isuzu: 8942211500)
Black Nylon

Push-Type Retainer
5mm x 14mm Screw
Head Size: 14mm x 22mm
Stem Length: 9mm
Fits Into 7mm Hole
UNIT PACKAGE: 25



16843

(Mazda: BF82-50-233;
Nissan: 01553-01393)
Black Nylon

Bumper Cover Retainer
Head Size: 20mm x 30mm
Stem Length: 18mm
Fits Into 10mm Hole
UNIT PACKAGE: 10

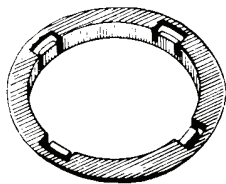

14346

(24274-M3000)
Black Nylon

Trim Ring
O.D.: 46mm
I.D.: 36mm
Fits Into 40mm Hole
UNIT PACKAGE: 25

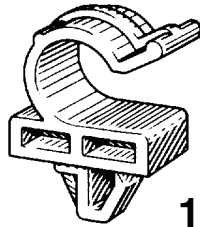

16780

(Nissan: 99604-H1400;
Toyota: 58788-13010)
Natural Nylon

Hood Prop Rod Clip
Holds 11mm Dia. Rod
Fits Into 10mm x 12mm Hole
UNIT PACKAGE: 10



14337

(84653-N7400)
Black Nylon

Tube/Cable Routing Clip
Holds 5mm Tube or Cable
Snaps Into 5mm Hole

UNIT PACKAGE: 25



14345

(24220-89986)
White Nylon

Hood Prop Rod Clip
Holds 10mm Rod
Snaps Into 8mm Hole
UNIT PACKAGE: 10



21309

(65722-EA000)
Black Nylon

Hood Prop Rod Clip
Rod Size: 8mm
Overall Length: 33mm
Frontier, Pathfinder & Xterra
2005 - On

UNIT PACKAGE: 10



21646

(80874-AX000)
Black Nylon

Hole Plug
Head Diameter: 25mm
Fits Into 18mm Hole
Nissan Juke & Murano
and Infiniti EX35
2003 - On

UNIT PACKAGE: 25



21637

(01553-05131)
Black Nylon

Wheel Liner, Cowl Insulator
& Trim Flange Clip
Flange Diameter: 25mm
Hex: 10.5mm
Overall Height: 12.5mm
Nissan 370Z, Altima, Cube, Frontier,
GT-R, Juke, Leaf, Maxima, Murano,
NV, Pathfinder, Quest, Rouge, Versa
& Xterra and Infiniti EX35, FX35,
FX50, G25, G35, G37,
J30, M35, M45 & Q45
1993 - On

UNIT PACKAGE: 15

Not Actual Size



20380

(Not Supplied By O.E.M.)
Black Nylon

Cable Strap
Length: 200mm (8")
5mm (3/16") Wide
Max. Bundle Dia: 44mm (1-3/4")
Fits Into 6.3mm (1/4") Hole
Import Cars

UNIT PACKAGE: 25



21259

(24225-89960)
Black Nylon

Cable Strap
Overall Length: 200mm (8")
Width: 8mm (5/16")
Maximum Bundle Diameter:
55mm (2-3/16")
Snaps Into 8mm (5/16") Hole
Nissan
2005 - On

UNIT PACKAGE: 25



16340

(54229-0201P)
Cadmium & Yellow

Window Crank Handle
Retaining Clip

UNIT PACKAGE: 100



19147

(62228-51S00)

Front Bumper Retainer
300ZX
1992-On

UNIT PACKAGE: 10



21664

(63848-9Y000)
Black Nylon

Fender Apron Clip
Width: 20mm
Width At Wings: 30mm
Overall Length: 30mm
Nissan Altima, Maxima, Murano,
Pathfinder, Quest & 370Z and
Infiniti EX35, FX35, FX50, G35,
G37, M35, M37, M45 & M56
2005 - On

UNIT PACKAGE: 10



21017

(76882-0M000)
White Nylon

Nylon "U" Nut
M4.8 (#10) Screw Size
Panel Range: Up To 1.5mm
Center Of Hole To Edge: 8mm
Nissan & Infiniti
1995 - On

UNIT PACKAGE: 15



17193

(63848-D0100)
Black Nylon

Nylon "U" Nut
Fender/Wheel Housing
M5.5 (#12) Screw Size
20mm Wide, 20mm Long
Panel Range: Up to 1mm
Center Of Hole To Edge: 9mm

UNIT PACKAGE: 15



19735

(63848-35F00)
Black Nylon

Fender Clip "U" Nut
M4.8 (#10) Screw Size
20mm Wide
32mm Long
Panel Range: Up To 2mm
Center Of Hole To Edge: 8mm
Maxima & 240SX
1994 - On

UNIT PACKAGE: 15



17385

(63848-D4000)
Black Nylon

Nylon "U" Nut
Fender/Wheel Housing
M5.5 (#12) Screw Size
31mm Wide; 22mm Long
Panel Range: Up To 2mm
Center Of Hole To Edge: 9mm
Sentra

UNIT PACKAGE: 10



21459

(01241-00881)
Black Nylon

Nylon "U" Nut
With Captive Metal Hex Nut
M6 - 1.0 Thread
Center Of Hole To Edge: 14mm
Panel Range: Up To 4mm
Nissan Altima, Maxima &
240SX and Infiniti I30
2001 - 1993

UNIT PACKAGE: 10



13225

Plated

"U" Type Nut
4.2mm (#8) Screw Size
11mm Wide
16.5mm Long
Panel Range: .5mm-2.5mm
Center Of Hole To Edge: 8mm

UNIT PACKAGE: 50

Sec. 22 OPEL & RENAULT CLIPS & FASTENERS

OPEL



12642

(1-74-713)
Nylon

Moulding Clip

UNIT PACKAGE: 10



13207

(Opel 1-76-651;
Renault 08-54-699-800)
Nylon w/Metal Washer

Body Retainer

UNIT PACKAGE: 50



19153

(1-74-820, 03467-531)
Nylon

Moulding Clip

UNIT PACKAGE: 25



13216

Zinc

"U" Type Nut
4.8mm Screw Size
Panel Range: .9mm-2.0mm
Center of Hole To Edge: 8mm

UNIT PACKAGE: 25

OPEL (Cont.)



13220

(Mercedes:
000-994-09-45;
Volvo: 946-418;
Opel: 20-72-175)
Plated

"U" Type Nut
6.3mm Screw Size
Panel Range: .7mm-1.5mm
Center of Hole To Edge: 13mm

UNIT PACKAGE: 50

RENAULT



13207

(Opel: 1-76-651;
Renault: 08-54-699-800)
Nylon w/Metal Washer

Body Retainer

UNIT PACKAGE: 50



9377

(Renault: 8934-201-263;
Chrysler: 6000943)
White Nylon

Radiator Grille Nut
#8 Screw Size

UNIT PACKAGE: 100



11855

(Renault: 8934-201-262;
GM: 9669486)
Natural Nylon

#8 Screw Size
Rear License Plate Bracket Nut
AMC-Renault
Side Marker Nut
GM 1980-On

UNIT PACKAGE: 25

RENAULT (Cont.)



12713

(GM: 10032838;
1264963;
Chrysler: 6031869;
Renault: 8934-201-602)
Natural Nylon

High Torque
Screw Grommet

UNIT PACKAGE: 25



13464

(8934-201-235)
Natural Nylon

Grille Retainer
Screw Grommet
4.2mm #8 Screw Size

UNIT PACKAGE: 25



13966

(8934-201-767)
Black Nylon

Tubular Barrel Nut
For 3/16" Stud
Barrel Length 17/64"
Head Dia. 5/16"
Head Thick 1/32"
For Hole Dia. 17/64"

UNIT PACKAGE: 100



12993

(7703-077-066)
Natural Nylon

Rear Window Moulding Retainer
Alliance 1983-On

UNIT PACKAGE: 25



21495

(VW: 7L5-853-994)
Blue Nylon

Trim Panel Retainer
Top Head Diameter: 13mm
Bottom Head Diameter: 18mm
Stem Diameter: 9mm
Stem Length: 14mm
Renault, VW & Audi

UNIT PACKAGE: 25

RENAULT (Cont.)



13475

(VW: 175-867-299;
Renault:
8934-201-681)
White Nylon

Trim Panel Retainer
Head Dia: 19mm
Stem Length: 18mm
Stem Dia: 9mm
AMC Renault 1984-On
VW 1982-On

UNIT PACKAGE: 50



13216

Zinc

"U" Type Nut
4.8mm Screw Size
Panel Range: .9mm-2mm
Center of Hole
To Edge: 8mm

UNIT PACKAGE: 25

**FasTrack Web
Auveco's Cost
Recovery System For
Repair Fasteners.....**

**Never Lose Money
On Fasteners
Again!**

SAAB



21540

(GM: 24449408)
Orange Nylon

Bumper, Grille,
Wheel Apron & Lights
Nylon Extruded "U" Nut
M5.5 (#12) Screw Size
Panel Range: Up To 2mm
Center Of Hole To Edge: 12mm

Use With Auveco 21541

Buick Lacrosse & Regal
2011 - On
Saab 9-3 & 9-5
2003 - On
Saturn Astra
2009 - 08

UNIT PACKAGE: 25

SUBARU



21581

(91059-FC030)
White Nylon

Front & Rear Door Fender,
Quarter Panel and Lift Gate
Moulding Clip
With Sealer
Top Head Size: 11mm x 14mm
Bottom Head Diameter: 17mm
Stem Length: 12mm
Fits Into 9mm Hole
B9 Tribeca, Forester, Impreza
& Outback
1998 - On

UNIT PACKAGE: 25

SUBARU (Cont.)



21564

(91059-FC110)
White Nylon

Moulding Clip
With Sealer
Head Size: 21.5mm x 24mm
Stem Diameter: 14.5mm
Stem Length: 17mm
Forester
2002 - 01

UNIT PACKAGE: 25



21572

(91059-FC090)
Black Nylon

Grille Clip
Top Head Size: 15.5mm x 11mm
Bottom Head Size: 19.5mm x 14mm
Stem Length: 11mm
Forester & Legacy
2008 - 1991

UNIT PACKAGE: 25



21562

(91017-FA080)
Gray Nylon

Grille Clip
Overall Height: 27mm
Forester Impreza & SVX
2008 - 1993

UNIT PACKAGE: 25

Sec. 22**SUBARU CLIPS & FASTENERS****21579**(91167-AA000)
Black NylonCowl Top, Quarter Glass,
Exterior Trim, Belt Moulding,
Trunk Lid & Rear Light
Grommet With Sealer
Head Diameter: 17.5mm
Stem Length: 15mm
Fits Into 8mm Hole
Baja, Forester, Impreza, Legacy,
Outback & SVX
2006 – 1991

UNIT PACKAGE: 25

**21575**(94081-FA010)
White NylonScrew Grommet
M4.8 (#10) Screw Size
Head Diameter: 13mm
Stem Length: 8mm
Fits Into 8mm Square Hole
Subaru
1992 – On

UNIT PACKAGE: 25

**21590**(91486-KJ000)
White NylonCowl & Dash Grommet
Use With Auveco 21531
Head Diameter: 14mm
Stem Length: 7mm
Fits Into 7mm Hole
Forester, Impreza, Legacy &
Outback
2008 – On

UNIT PACKAGE: 25

**21587**(62731-FA010)
Blue NylonM3.5 (#6) Screw Size
Head Size: 11mm x 11mm
Stem Length: 10mm
Fits Into 8mm x 8mm Square Hole
Subaru
1993 – On

UNIT PACKAGE: 25

**21569**(909300015)
White NylonRear Bumper
Screw Grommet
M4.8 (#10) Screw Size
Head Diameter: 12mm
Stem Length: 15mm
Fits Into 7mm Square Hole
Impreza, Legacy, Outback & SVX
2009 – 1995

UNIT PACKAGE: 25

**21531**(91486-KJ010)
Black NylonCowl Panel Vent Cap
Top Head Size: 16mm x 18mm
Bottom Head Diameter: 14mm
Stem Length: 12mm
Forester, Impreza, Legacy, Outback
& WRX
2008 – On

UNIT PACKAGE: 15

**21629**(62731-FA000)
White NylonM3.5 (#6) Screw Size
Head Size: 10mm x 10mm
Stem Length: 5mm
Fits Into 7mm x 7mm Hole
Forester, Impreza, Legacy &
Outback
2009 – 05

UNIT PACKAGE: 25

**21577**(57750-FC010)
White NylonRear Bumper Reinforcement Beam
Screw Grommet
With Sealer
M4.8 (#10) Screw Size
Head Size: 16mm x 16mm
Stem Length: 19mm
Forester
2008 – 1998

UNIT PACKAGE: 25

**21573**(90331-GA090)
Black NylonWeatherstrip Retaining Clip
Head Diameter: 9mm
Stem Diameter: 6.5mm
Stem Length: 13mm
Forester & Legacy
2008 – 1990

UNIT PACKAGE: 25

SUBARU CLIPS & FASTENERS

Sec. 22



21589

(99045-AE03AMA)
Black Nylon

Trim Panel Retainer
Head Diameter: 18mm
Stem Diameter: 7.7mm
Stem Length: 15mm
B9 Tribeca, Impreza, Legacy
& Outback
2005 - On

UNIT PACKAGE: 25



21421

(90913-0074)
Black Nylon

Hood Insulation Retainer
Head Diameter: 30mm
Stem Diameter: 7.7mm
Stem Length: 13mm
Baja, Forester, Impreza,
Legacy, Outback & Tribeca
1998 - On

UNIT PACKAGE: 15



21574

(90913-0034)
White Nylon

Door, Pillar, Rocker, Floor &
Interior Trim Retainer
Top Head Diameter: 13mm
Middle Head Diameter: 16mm
Bottom Head Diameter: 15mm
Stem Diameter: 9.5mm
Stem Length: 11mm
Baja, Forester, Legacy & Outback
2008 - 03

UNIT PACKAGE: 25



21630

(95022-AC040ML)
Black Nylon

Headliner & Trim
Space Retainer
Head Diameter: 20mm
Stem Diameter: 6mm
Stem Length: 22mm
Forester, Impreza, Legacy
& Outback
1998 - On

UNIT PACKAGE: 25



21591

(90913-0109)
Black Nylon

Front & Rear Door, Fender,
Quarter Panel and Rocker Panel
Moulding Clip
Top Head Size: 11mm x 14mm
Bottom Head Diameter: 17mm
Stem Diameter: 9.7mm
Stem Length: 12mm
B9 Tribeca, Forester, Impreza,
Legacy & Outback
2003 - On

UNIT PACKAGE: 25



21502

(90913-0213)
White Nylon

Door Trim Panel Retainer
With Sealer
Top Head Diameter: 13mm
Middle Head Diameter: 16mm
Bottom Head Diameter: 15mm
Stem Diameter: 9.5mm
Stem Length: 14mm
Legacy & Outback
2010 - On

UNIT PACKAGE: 10



21322

(90814-FC001)
Black Nylon

Retainer
Head Diameter: 30mm
Stem Diameter: 6.5mm
Stem Length: 13mm
Subaru
1998 - On

UNIT PACKAGE: 10



21567

(90913-0007)
Gray Nylon

Pillar & Door Moulding Trim
and Rear Light Retainer
With Sealer
Top Head Size: 11mm x 15mm
Bottom Head Diameter: 18mm
Stem Diameter: 9.7mm
Stem Length: 12mm
B9 Tribeca, Forester, Impreza,
Legacy & Outback
2005 - On

UNIT PACKAGE: 25



21584

(69300-5370)
White Nylon

Front Door & Lift Gate
Trim Panel Retainer
Top Head Diameter: 13mm
Middle Head Diameter: 16mm
Bottom Head Diameter: 18mm
Stem Diameter: 9.3mm
Stem Length: 10mm
Impreza, Justy, Legacy & Outback
2007 - 1987

UNIT PACKAGE: 25



21565
(90331-AA050)
White Nylon

Weatherstrip Retaining Clip
Head Size: 5mm x 14mm
Stem Diameter: 7mm
Stem Length: 8.5mm
Forester
2008 – 03

UNIT PACKAGE: 25



21570
(90914-0012)
Black Nylon

Rear Light Reflector &
Roof Spoiler
Push-Type Retainer
Head Diameter: 16mm
Stem Length: 11mm
Fits Into 6mm Hole
B9 Tribeca, Impreza, Legacy
& Outback
2005 – On

UNIT PACKAGE: 25



21422
(90914-0051)
Black Nylon

Front Bumper & Quarter Panel
Push-Type Retainer
Head Diameter: 20mm
Stem Length: 9mm
Fits Into 7mm Hole
B9 Tribeca, Impreza,
Legacy & Outback
2005 – On

UNIT PACKAGE: 15



21585
(90913-0003)
Black Nylon

Upper Grille
Push-Type Retainer
Head Diameter: 9mm
Stem Length: 7mm
Fits Into 4mm Hole
Baja, Legacy & Outback
2006 – 2000

UNIT PACKAGE: 25



21566
(91085-TA030)
Black Nylon

Push-Type Retainer
Head Diameter: 16mm
Stem Length: 13mm
Fits Into 7mm Hole
Baja, Impreza, Legacy
& Outback
2000 – On

UNIT PACKAGE: 25



21571
(59122-FA010)
Black Nylon

Front Bumper, Fender,
Windshield Washer &
Rocker Moulding
Push-Type Retainer
Head Diameter: 20mm
Stem Length: 10mm
Fits Into 8mm Hole
B9 Tribeca, Baja, Forester,
Impreza, Legacy & Outback
1998 – On

UNIT PACKAGE: 25



21593
(46064-AE000)
Black Nylon

Front Fender Bumper
& Quarter Panel
Push-Type Retainer
Head Diameter: 15mm
Stem Length: 8mm
Fits Into 7mm Hole
Baja, Forester, Impreza,
Legacy & Outback
2003 – On

UNIT PACKAGE: 10



21530
(90913-0067)
Black Nylon

Engine Cover and Fender Liner
Push-Type Retainer
Head Diameter: 18mm
Stem Length: 10mm
Fits Into 8mm Hole
B9 Tribeca, Forester,
Legacy & Outback
& Tribeca
2005 – On

UNIT PACKAGE: 15



21592
(90914-0052)
Black Nylon

Push-Type Retainer
Head Diameter: 20mm
Stem Length: 11mm
Fits Into 7mm Hole
B9 Tribeca, Impreza, Legacy
& Outback
2005 – On

UNIT PACKAGE: 15

SUBARU CLIPS & FASTENERS

Sec. 22



21594

(90913-0051)

Black Nylon

Fender Liner, Duct &
Lower Moulding
Push-Type Retainer
Head Diameter: 20mm
Stem Length: 11mm
Fits Into 7mm Hole
B9 Tribeca, Forester, Impreza,
Legacy & Outback
2005 – On

UNIT PACKAGE: 15



21563

(90913-0059)

Black Nylon

Front Bumper & Fender
Push-Type Retainer
Head Diameter: 20mm
Stem Length: 15mm
Fits Into 10mm Hole
Forester, Impreza, & Outback
2006 – 02

UNIT PACKAGE: 25



21501

(90914-0055)

Black Nylon

Push-Type Retainer
With Sealer
Head Diameter: 25mm
Shoulder Length: 3mm
Shoulder Diameter: 16.5mm
Stem Length: 12mm
Fits Into 11mm Hole
Subaru
2006 – On

UNIT PACKAGE: 5



21580

(59122-AC030)

Black Nylon

Front Fender
Push-Type Retainer
Head Diameter: 20mm
Stem Length: 12mm
Fits Into 7mm Hole
B9 Tribeca, Baja, Forester,
Legacy & Outback
1995 – On

UNIT PACKAGE: 25



21420

(90914-0007)

Black Nylon

Bumper, Engine Cover,
Fender & Grille
Push-Type Retainer
Head Diameter: 21mm
Stem Length: 15mm
Fits Into 10mm
B9 Tribeca, Baja, Forester, Impreza,
Legacy & Outback
2000 – On

UNIT PACKAGE: 15



21576

(90914-0002)

Black Nylon

Rocker, Pillar, Floor &
Exterior Trim
Push-Type Retainer
With Sealer
Head Diameter: 25mm
Shoulder Diameter: 17mm
Shoulder Length: 3mm
Stem Length: 14mm
Fits Into 11mm Hole
B9 Tribeca, Baja, Legacy
& Outback
2000 – On

UNIT PACKAGE: 25



21500

(90914-0063)

Black Nylon

Cowl Vent
Push-Type Retainer
Head Diameter: 20mm
Stem Length: 12mm
Fits Into 7mm Hole
Legacy & Outback
2010 - On

UNIT PACKAGE: 10



21578

(57750-AA090)

Black Nylon

Front & Rear Bumper
Push-Type Retainer
Head Diameter: 22mm
Stem Length: 28mm
Fits Into 10mm Hole
Impreza & Legacy
2001 – 1993

UNIT PACKAGE: 25



21568

(57160-FC000)

Black Nylon

Front Fender
Push-Type Retainer
Top Head Length: 19.5mm
Bottom Head Diameter: 14mm
Stem Length: 15mm
Fits Into 10mm Hole
Forester
2008 – 1998

UNIT PACKAGE: 25

SUZUKI



20743
 (77553-65D00)
 White Nylon

Moulding Clip
 Head Diameter: 18mm
 Stem Length: 9mm
 Overall Length: 18mm
 Suzuki

UNIT PACKAGE: 10



20744
 (77259-71B00)
 White Nylon

Moulding Clip
 With Sealer
 Top Head Diameter: 13mm
 Bottom Head Diameter: 16mm
 Stem Length: 13mm
 Suzuki

UNIT PACKAGE: 10



17383
 (GM: 94847334, 96057847;
 Toyota: 90467-07066;
 Suzuki: 09409-07313)
 Black Nylon

Radiator Grille
 & Trim Panel
 Push-Type Retainer
 Head Diameter: 11mm
 Stem Length: 14mm
 (Excluding The Pin)
 Fits Into 7mm Hole
 Suzuki and Geo Tracker & Prizm
 1992 - 89

UNIT PACKAGE: 10



20908
 (Suzuki: 09409-07332;
 Toyota: 90467-07164)
 Black Nylon

Push-Type Retainer
 Head Diameter: 20mm
 Stem Length: 10mm
 Fits Into 7mm Hole
 Suzuki
 1999 - On
 Toyota
 1997 - On

UNIT PACKAGE: 10

TOYOTA

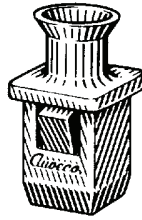

16691
 Natural Nylon

Headlight Adjusting
 Screw Nut

Pick-Up Truck
 1984-On

UNIT PACKAGE: 25

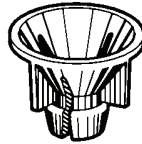

18747
 (90189-06162)
 Natural Nylon

Front Clearance Lamp Nut
 Camry 1994-91
 Headlight Adjusting Nut
 Lexus

UNIT PACKAGE: 10

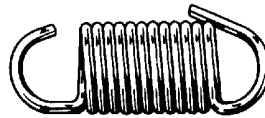

16558
 (81121-14670)

Headlight Adjusting Spring

UNIT PACKAGE: 5

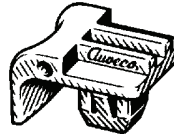

16951
 (81124-89101)
 Nylon

Headlight Spacer
 15mm Wide x 18mm Long
 Fits Into 7mm Square Hole
 Pick-Up Truck
 1984-On

UNIT PACKAGE: 25



20738
 (53271-44010)
 Black Nylon

Headlight Bracket Clip
 25mm Wide, 40.5mm Long
 Toyota Camry & RAV 4
 And Lexus IS-300
 2001 - On

UNIT PACKAGE: 4

TOYOTA CLIPS & FASTENERS

Sec. 22



21369
(67771-58010)
White Nylon

Door & Garnish
Moulding Clip
Overall Height: 12.4mm (1/2")
Tundra
2007 – On

UNIT PACKAGE: 25



21546
(90467-09204)
White Nylon

Rear Hatch Door Side Garnish
and Front Body Pillar Garnish
Moulding Clip
Overall Height: 14mm
Toyota Camry, Highlander, Prius
& Sienna and Lexus GS 300,
GS 400, GS 430, GX 470, RX 330,
RX 350, RX 400 & RX 450
1998 – On

UNIT PACKAGE: 25



21549
(90467-12080)
Pink Nylon

Door Trim, Instrument Panel,
Rear Deck Trim &
Roof Garnish Trim
Moulding Clip
Overall Height: 21mm
Toyota Avalon, Camry, Corolla,
Echo, FJ Cruiser, Highlander,
Matrix, Prius,
RAV 4, Sequoia, Sienna, Tacoma,
Tundra, Venza, Yaris & 4-Runner and
Lexus ES 350, GX 460, RX 330
& RX 450h
2000 – On

UNIT PACKAGE: 25



17194
(90467-13005)
Black Nylon

Grille Clip
13mm Wide
23mm Long

UNIT PACKAGE: 25



21623
(Mitsubishi: MR221507;
Toyota: 90467-13075)
Gray Nylon

Radiator Grille Clip
Width: 14mm
Length: 24mm
Mitsubishi Diamante,
Endeavor & Galant
1997 – On
Toyota 4 Runner, Highlander
& Land Cruiser
1998 – On

UNIT PACKAGE: 25



17438
(90467-17004)
Black Nylon

Radiator
Grille Clip
21mm Wide
22mm Long
Cressida
1987-84

UNIT PACKAGE: 10



19430
(90904-67021)
Black Nylon

Radiator Grille Retainer
T-100 Truck
1992-On

UNIT PACKAGE: 15



21194
(61118-35010)
Black Nylon

Front Fender Upper Seal
Moulding Clip
Head Size: 18mm x 18mm
Stem Length: 13mm
Fits Into 9mm Hole
FJ Cruiser
2007 – On

UNIT PACKAGE: 15



15695
(Toyota: 62955-20020;
GM: 94848834)
White Nylon

Moulding Clip With Sealer
Head Dia: 15mm
Stem Length: 9mm
Fits Into 8mm Hole
Toyota Pick-Up Truck
Pontiac Vibe

UNIT PACKAGE: 25



21453
(75395-0T010)
White Nylon

Moulding Clip
With Sealer
Top Head Size: 5mm x 10mm
Bottom Head Diameter: 18mm
Stem Diameter: 10mm
Stem Length: 13mm
Corolla & Venza
2008 – On

UNIT PACKAGE: 25

Sec. 22**TOYOTA CLIPS & FASTENERS**

19647
(90467-11111)
Red Nylon

Scuff Plate Retainer
Head Diameter: 18mm
Stem Diameter: 10mm
Stem Length: 10mm
Sienna
1997-On

UNIT PACKAGE: 10



21550
(90467-11099)
White Nylon

Hood and Front & Rear Side
Moulding Clip
Head Diameter: 17mm
Stem Length: 8.5mm
Fits Into 9mm Square Hole
Tundra & 4-Runner
2006 - 1996

UNIT PACKAGE: 25



20391
(90904-67037)
Red Nylon

Fender Moulding Clip
Head Diameter: 17mm
Stem Length: 13mm
Highlander, Land Cruiser,
Tacoma & Tundra
2001 - On

UNIT PACKAGE: 10



21653
(75867-AC020)
White Nylon

Moulding Clip
With Sealer
Head Diameter: 18mm
Stem Length: 13mm
Fits Into 8mm Hole
Avalon
2005 - On

UNIT PACKAGE: 15



20687
(75396-35020,
75495-35010)
Blue Nylon

Rocker Moulding Clip
With Sealer
Head Diameter: 17mm
Stem Length: 10mm
4-Runner
2003 - On

UNIT PACKAGE: 10



20688
(75397-35010)
Orange Nylon

Wheel Flare Moulding Clip
With Sealer
Head Diameter: 17mm
Stem Length: 17mm
4-Runner
2003 - On

UNIT PACKAGE: 10



17481
(90467-11063)
White Nylon

Rocker Panel
Moulding Clip
With Sealer
Head Dia: 18mm
Stem Length: 9mm
Previa
1990-On

UNIT PACKAGE: 15



20429
(90467-11100)
Yellow Nylon

Fender & Wheel Flare
Moulding Clip
Head Dia: 17mm
Stem Length: 17mm
Highlander, Land Cruiser,
Tacoma & Tundra
2000 - On

UNIT PACKAGE: 10



19797
(90467-10077)
Butterscotch Nylon

Door Moulding Clip
With Sealer
Head Diameter: 15mm
Stem Length: 9mm
Fits Into 8mm Hole
Avalon & Corolla
1998 - On

UNIT PACKAGE: 15



20390
(90904-67036)
Blue Nylon

Fender Moulding Clip
Head Diameter: 17mm
Stem Length: 17mm
Highlander, Land Cruiser,
Tacoma & Tundra
2001 - On

UNIT PACKAGE: 10



19843
(75498-42010)
White Nylon

Garnish Clip
Head Diameter: 20mm
Stem Length: 20mm
RAV 4
1996 - On

UNIT PACKAGE: 10

TOYOTA CLIPS & FASTENERS

Sec. 22



21612
(76817-12060)
White Nylon

Rear Door, Hatch Garnish and
Luggage Compartment
Moulding Clip
With Sealer
Large Head Diameter: 24mm
Overall Length: 24mm
Camry, Corolla & Matrix
2003 - On

UNIT PACKAGE: 15



20578
(GM: 88970495, 88973654;
Toyota: 76924-52021)
Black Nylon

Rocker Moulding Retainer
Head Diameter: 32mm
Stem Length: 10mm
Fits Into 22mm Hole
Pontiac Vibe & Toyota Corolla
2003 - On

UNIT PACKAGE: 25



14264
(75395-14020-A)
Nylon

Moulding Clip
28mm Wide, 14mm Long
Snaps Into 7mm Hole

UNIT PACKAGE: 25



21008
(75791-33020)
Black Nylon

Front & Rear Belt Moulding Clip
Width: 14mm
Overall Height: 10mm
Camry
2000 - 1997

UNIT PACKAGE: 15



21071
(90084-46020)
White Nylon

Bumper Cover Clip
Head Size: 21mm x 30mm
Stem Length: 12mm
Camry
2005 - On

UNIT PACKAGE: 10



21641
(90467-12073)
White Nylon

Rocker Moulding Clip
Head Size: 23mm x 28mm
Stem Length: 14mm
Fits Into 10mm x 10mm Hole
Land Cruiser
2007 - 1998

UNIT PACKAGE: 15



19531
(68211-06020)
Natural Nylon

Door Belt Moulding Clip
Solara
1998-On

UNIT PACKAGE: 25

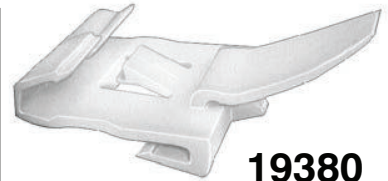

19380
(68211-07010)
Natural Nylon

Door Belt Moulding Clip
Avalon
1994-On

UNIT PACKAGE: 25



19198
(68211-32040)
Yellow Nylon

Door Belt Moulding
& Door Weatherstrip Clip
Camry
1991-On

UNIT PACKAGE: 50

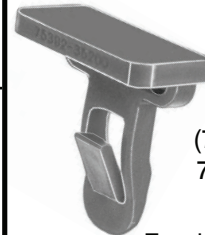

21016
(75392-35200,
75392-04010)
Blue Nylon

Fender Flare &
Bumper Clip
Head Size: 13mm x 26mm
Stem Length: 24mm
Toyota Camry, FJ,
RAV 4 & Tacoma
2005 - On

UNIT PACKAGE: 15



21586
(76853-10010)
White Nylon

Front & Rear Bumper Clip
Head Size: 13mm x 26mm
Stem Length: 25mm
Matrix
2008 - 03

UNIT PACKAGE: 25

Sec. 22**TOYOTA CLIPS & FASTENERS****21642**
(90467-12075)
Yellow Nylon

Rocker Moulding Clip
 Top Head Size: 11mm x 13mm
 Bottom Head Size: 15mm x 25mm
 Stem Length: 14mm
 Fits Into 10mm x 10mm Hole
 Land Cruiser
 2007 – 1998

UNIT PACKAGE: 15

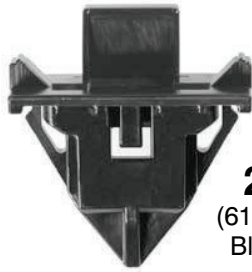
**21235**
(61992-35010)
Black Nylon

Front Fender/Sheet Metal
 Upper Seal
 Moulding Clip
 Top Head Size: 13mm x 31mm
 Overall Height: 34mm
 FJ Cruiser
 2007 – On

UNIT PACKAGE: 10

**21221**
(52115-0C090)
Black Nylon

Front Bumper
 Moulding Clip
 Head Size: 25mm x 74mm
 Overall Height: 17mm
 Stem Length: 15mm
 Tundra
 2009 – On

UNIT PACKAGE: 10

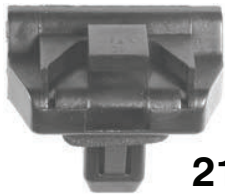
**21133**
(52197-52010)
Black Nylon

Front Bumper
 Moulding Clip
 With Sealer
 Overall Width: 30mm
 Overall Height: 25mm
 Stem Length: 13mm
 Highlander
 2001 – On

UNIT PACKAGE: 10

**21132**
(52115-48040)
Gray Nylon

Front Bumper
 Moulding Clip
 Overall Length: 47mm
 Stem Length: 8mm
 Highlander
 2001 – On

UNIT PACKAGE: 10

**21162**
(53935-35020)
Black Nylon

Bumper Filler Clip
 Overall Length: 30mm
 Overall Height: 17mm
 4 Runner
 2003 – On

UNIT PACKAGE: 10

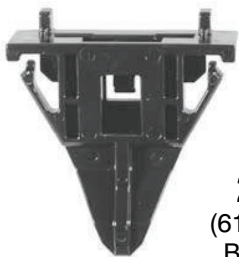
**21234**
(61991-35010)
Black Nylon

Front Fender/Sheet Metal
 Upper Seal
 Moulding Clip
 Top Head Size: 9mm x 31mm
 Overall Height: 30mm
 FJ Cruiser
 2007 – On

UNIT PACKAGE: 10

**21217**
(76924-47010)
Black Nylon

Rocker Panel
 Moulding Clip
 Head Size: 43mm x 54mm
 Overall Height: 26mm
 Prius
 2009 – On

UNIT PACKAGE: 5

**16800**

M6-1.0 x 20mm
 License Plate Hardware
 Includes Nylon Screw,
 Washer & Spacer And Brass Nut

UNIT PACKAGE: 25 Sets



17636
Nylon

License Plate
Bracket Spacer
1/4" (6mm) I.D.
3/4" (19mm) O.D.
1/4" (6mm) Thick

UNIT PACKAGE: 50

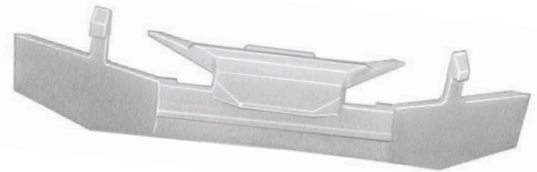

19204
(75546-12060)
Natural Nylon

Windshield Moulding Clip
Corolla Sedan Wagon
1992-88

UNIT PACKAGE: 25



19722
(68211-95D00)
White Nylon

Door Glass Clip
Previa Van
1990 - On

UNIT PACKAGE: 15

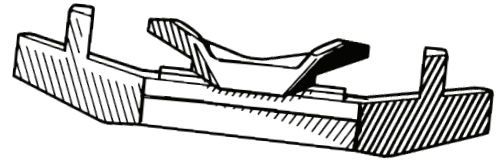

17302
(75545-89103)
Natural Nylon

Windshield Side Moulding Clip
Without Center Tab
Truck
1988-On

UNIT PACKAGE: 15

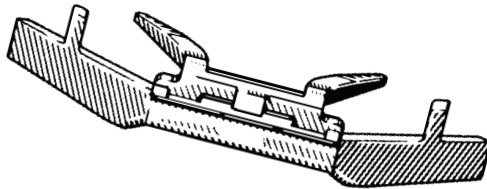

16833
(75545-32020)
Nylon

Windshield Moulding Clip
12mm Wide, 66mm Long
Camry
1987-On

UNIT PACKAGE: 10

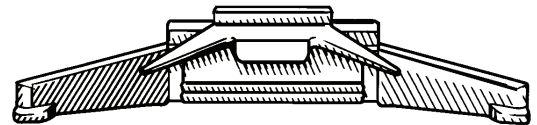

17334
(75546-22060)
Natural Nylon

Windshield Side Moulding Clip
Cressida
1988-On

UNIT PACKAGE: 15

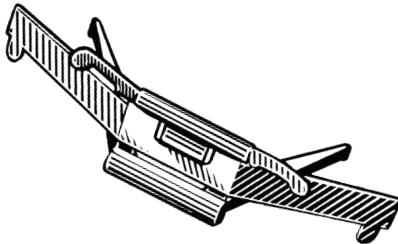

15475
(75545-12050)
White Nylon

Windshield Moulding Clip
22mm Wide, 56mm Long
19mm High
Corolla (RWD)
1984-On

UNIT PACKAGE: 10



17485
(75545-32030)
Natural Nylon

Windshield Moulding Clip
Camry
1992-On

UNIT PACKAGE: 15



14746
(75546-12050)
Nylon

Windshield Moulding Clip
20mm Wide
41mm Long
Fits Into 8mm Hole
UNIT PACKAGE: 15



17330
(75548-16010)
Nylon

Windshield Moulding Clip
With Adhesive Backing
14.5mm Wide, 71mm Long
Corolla
1988-83
UNIT PACKAGE: 15



17298
(75547-22010)
Black Nylon

Windshield Moulding Clip
20mm Wide, 47mm Long
1981-On
UNIT PACKAGE: 25

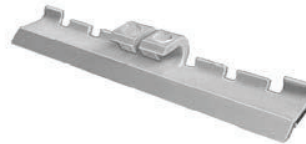

19484
(75548-22150)
Blue Nylon

Windshield Moulding Clip
With Adhesive Backing
9mm Wide, 40mm Long
Cressida
1988-On
UNIT PACKAGE: 10

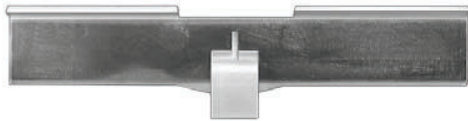

14278
(75548-24020)
Nylon

Windshield Clip
With Adhesive Backing
14.5mm Wide
60mm Long
UNIT PACKAGE: 10

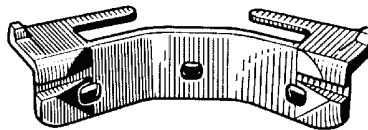

14745
(75546-22050)
Nylon

Windshield Moulding Clip
14mm Wide
47mm Long
12mm High
UNIT PACKAGE: 25

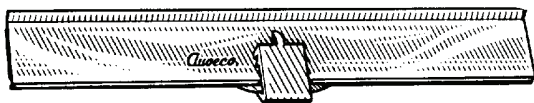

14731
(75548-32010)
Nylon

Windshield Clip
With Adhesive Backing
14.5mm Wide
70mm Long
UNIT PACKAGE: 25

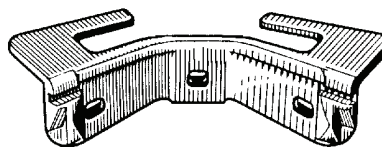

14751
(75545-16020)
Nylon

Windshield Moulding Clip
18mm Wide
49mm Long
13mm High
UNIT PACKAGE: 25

Note: If an adhesion problem occurs with the adhesive backed clips, warm the back with a heat gun.

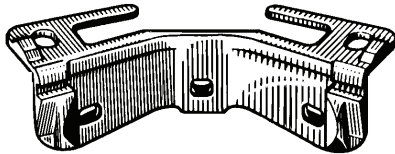

14749

(75545-88080;
75545-28010-B)
Nylon

Windshield Moulding Clip
18mm Wide
49mm Long
16mm High

UNIT PACKAGE: 25

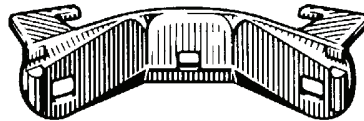

16942

(75545-89101)
Nylon

Windshield Moulding Clip
15mm Wide, 47mm Long
13mm High
Pick-Up Truck
1984-On

UNIT PACKAGE: 15



14271

(90189-04011)
Natural Nylon

#6 Screw Size
12mm Wide, 12mm Long
Snaps Into 7mm x 7.5mm Hole

UNIT PACKAGE: 25



19504

(90189-04211)
White Nylon

Front Door Moulding
Nylon Nut
#6 Screw Size
T100 Truck
1992-On

UNIT PACKAGE: 20

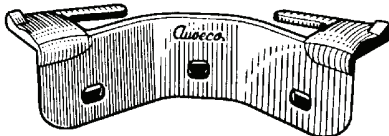

14747

(75545-14081)
Nylon

Windshield Moulding Clip
18mm Wide
50mm Long
15mm High

UNIT PACKAGE: 25



17224

(90189-04022,
95900-04036)
Nylon

#6 Screw Size
10mm Wide, 10mm Long
Snaps Into 7mm x 7mm Hole

UNIT PACKAGE: 50



21628

(81137-22530,
81150-1A750,
90075-10004)
White Nylon

M3.5 (#6) Screw Size
Head Size: 10mm x 10mm
Stem Length: 7mm
Fits Into 7mm x 7mm Hole
Avalon, Camry, Land Cruiser,
Tacoma & Tundra
2007 - 1992

UNIT PACKAGE: 25

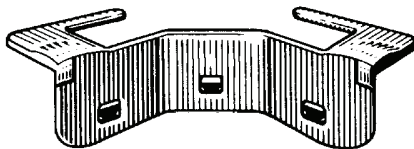

16821

(75546-12030)
Nylon

Windshield Moulding Clip
21mm Wide, 54mm Long
15mm High
Corolla
1984-On

UNIT PACKAGE: 25

Please E-Mail
Your New Item
Suggestions
To
mail@auveco.com



14256

(90189-04014)
Natural Nylon

#8 Screw Size
10mm Wide, 10mm Long
Snaps Into 7mm x 7mm Hole

UNIT PACKAGE: 50



13932

(Toyota: 90189-05013;
Mitsubishi: MS-480002)
Natural Nylon

#10 Screw Size
12mm Wide, 12mm Long
Fits Into 8mm x 9mm Hole

UNIT PACKAGE: 50



14274

(Toyota: 90189-06010;
Honda: 75521-611-0000;
Mazda: 9991-00-601;
Nissan: 96706-P0105)
Natural Nylon

#10 Screw Size
13mm Wide, 13mm Long
Snaps Into 8.5mm x 8.5mm Hole

UNIT PACKAGE: 25



14258

(90189-06018)
Black Nylon

#10 Screw Size
14mm Wide
14mm Long
Snaps Into 9mm x 9mm Hole

UNIT PACKAGE: 25



20895

(90189-06193)
Natural Nylon

Front Bumper Nylon Nut
Use With M5.5 (#12) Screw
Head Size: 14mm x 16mm
Stem Length: 10mm
Avalon & Camry
2002 - On

UNIT PACKAGE: 25



14739

(Toyota: 90189-05012;
Isuzu: 8941340270)
Natural Nylon

#6 Screw Size
16mm Wide
12mm Long
Snaps Into 6mm x 10mm Hole

UNIT PACKAGE: 50

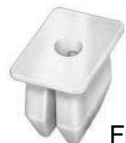

20431

(90189-05105)
Natural Nylon

Front Fender Flare
Screw Grommet
Use With M4.2 (#8) Screw
Head Size: 10mm x 15mm
Stem Length: 12mm
RAV 4
1996 - On

UNIT PACKAGE: 15



21151

(90189-04059)
White Nylon

Rocker, Pillar, Floor &
Exterior Trim
Screw Grommet
M3.5 (#6) Screw Size
Head Size: 12mm x 18mm
Stem Length: 7mm
Toyota Scion, Avalon & FJ Cruiser
and Lexus ES300, ES330, RX330,
RX400, SC300, SC400
1992 - On

UNIT PACKAGE: 25



20442

(90189-04127)
Natural Nylon

Door Panel Nylon Nut
M3.5 (#6) Screw Size
Head Size: 14mm x 14mm
Stem Length: 15mm
Toyota Tundra
1999 - On

UNIT PACKAGE: 25



19840

(90189-04176)
Natural Nylon

Mudguard Screw Grommet
#8 (M4.2 - 1.41) Screw Size
Head Size: 10mm x 10mm
Stem Length: 15mm
Corolla
1997 - On

UNIT PACKAGE: 15



19265

(90189-04150)
White Nylon

Windshield Moulding
Screw Grommet
#4 Screw Size
T100
1992-On

UNIT PACKAGE: 15



21544

(90189-04102)
White Nylon

Screw Grommet
With Sealer
M3.2 (#6) Screw Size
Head Size: 10mm x 10mm
Stem Length: 15mm
Fits Into 7mm Square Hole
Toyota Highlander and
Lexus IS 250, IS 350, & IS F
2006 - On

UNIT PACKAGE: 25



19783

(Ford: N811169-S,
W705550-S300;
Toyota: 90075-10801,
90189-06111)
White Nylon

Head Diameter: 13mm
Stem Length: 9mm
Fits Into 11mm Hole
Ford, Lexus & Toyota

UNIT PACKAGE: 50



14277

(90189-04008,
90467-12096)
Black Nylon

Screw Grommet
#8 Screw Size
15mm High
12mm Wide
16mm Long
Fits Into 10mm x 10mm Hole

UNIT PACKAGE: 15



18843

(90189-04031)
Natural Nylon

Grille & Rear Filler Nut
#8 Screw Size
Camry & RAV4
2000 - 1991

UNIT PACKAGE: 25



18846
(53145-16020)
Black Nylon
Radiator Grille
Garnish Grommet
Tercel
1990-On

UNIT PACKAGE: 10



14263
(90189-04019)
Natural Nylon
#8 Screw Size
12mm Wide, 14mm Long
Fits Into 6.5mm x 8.5mm Hole

UNIT PACKAGE: 25



19841
(55799-12010)
Blue Nylon
Cowl Screw Grommet
#10 (M4.8) Screw Size
Fits Into 10mm x 15mm Hole
Toyota Celica & Corolla
1997 - On

UNIT PACKAGE: 10



21015
(52535-50060,
52535-0E010)
Black Nylon
Front Bumper
Screw Grommet
M5.5 - M6 (#12) Screw Size
Head Size: 17mm x 30mm
Stem Length: 9mm
Lexus IS250, IS350,
RX330 & RX350 and
Toyota Camry, Highlander
& Tacoma
2001 - On

UNIT PACKAGE: 5



21583
(52535-30150)
White Nylon
Front & Rear Bumper
Screw Grommet
M5.5 (#12) Screw Size
Head Size: 17.5mm x 30mm
Stem Length: 10mm
Toyota Avalon, Sequoia &
Tundra and Lexus ES300, 330,
350, LS430 & RX300
1999 - On

UNIT PACKAGE: 25



14265
(90189-06006)
Natural Nylon
M4.8 (#10) Screw Size
Head Diameter: 17mm
Fits Into 9mm x 9mm Hole

UNIT PACKAGE: 25



21331
(90189-06211)
Black Nylon
Pillar, Rocker and Floor
Screw Grommet
M5.5 (#12) Screw Size
Head Diameter: 17mm
Stem Length: 10mm
Fits Into 9mm Square Hole
Camry
2010 - On

UNIT PACKAGE: 25



21191
(90189-05142)
Natural Nylon
Headlight Mounting
Nylon Nut
M4.2 (#8) Screw Size
Head Diameter: 17mm
Stem Length: 8mm
Fits Into 9mm Square Hole
Toyota & Scion
2001 - On

UNIT PACKAGE: 25



19187
(90189-05082)
Natural Nylon
Hood Seal To Cowl Top
Screw Grommet
#6 Screw Size
Head Diameter: 13mm
Stem Length: 13mm
Fits Into 7mm x 7mm Hole
2WD & 4WD Truck
1988-On

UNIT PACKAGE: 15



14268
(Toyota: 90189-04013;
Honda:
90672-671-8110M1)
Natural Nylon

#6 Screw Size
Head Diameter: 14mm
Stem Length: 15mm
Fits Into 7mm x 7mm Hole

UNIT PACKAGE: 25



14695
(Toyota: 90189-06042;
Honda: 90661-SC7-0030;
Mazda: H001-50-841;
Mitsubishi: MS-480012;
Nissan: 01651-00481,
74798-S9000)
White Nylon

Screw Grommet
#8 Screw Size
Head Diameter: 16mm
Stem Length: 17mm
Fits Into 8mm x 8mm Hole

UNIT PACKAGE: 25



14275
(Toyota: 90189-06001;
Mitsubishi: MB-098145;
Nissan: 01281-00023,
01281-00231)
White Nylon

Screw Grommet
M4.8 (#10) Screw Size
Head Diameter: 18mm
Stem Length: 17mm
Fits into 8.5mm x 8.5mm Hole

UNIT PACKAGE: 25



14281

(Honda: 90662-693-0030;
Toyota: 90189-04066)
White Nylon

Screw Grommet
#6 Screw Size
Head Diameter: 14mm
Stem Length: 10mm
Fits Into 7mm x 7mm Hole

UNIT PACKAGE: 25



19505

(90189-06029,
90189-06084,
90189-06116)
Natural Nylon

Rear Door Panel
Screw Grommet
#12 Screw Size
Head Diameter: 18mm
Stem Length: 17mm
Fits Into 9mm x 9mm Hole
Camry & Previa
1988 - On

UNIT PACKAGE: 20



19742

(90189-06104)
Natural Nylon

Fender Lining
Screw Grommet
#12 (M5.5) Screw Size
Head Diameter: 18mm
Stem Length: 15mm
Fits Into a 9mm Square Hole
Lexus IS300 & Toyota Avalon,
Camry & Sienna
1997-On

UNIT PACKAGE: 15



21625

(90189-06145)
Black Nylon

Fender Lining
Screw Grommet
M5.5 (#12) Screw Size
Head Diameter: 16mm
Stem Length: 16mm
Fits Into 9mm x 9mm Hole
Toyota Prius, Sequoia & T-100
and Lexus CT 200h
1993 - On

UNIT PACKAGE: 15



19194

(Toyota: 90189-06028;
GM: 94854203)
Black Nylon

Front & Rear Wheel
Fender Liner Screw Grommet
#12 Screw Size
Head Diameter: 16mm
Stem Length: 19mm
Fits Into 9mm x 9mm Hole
Tacoma, T100 & 4 Runner
1992-On
Chevrolet Nova & Prizm
And Pontiac Vibe
1985-On

UNIT PACKAGE: 15



19756

(90189-06214)
Black Nylon

Fender Lining
Screw Grommet
#12 (M5.5) Screw Size
Head Diameter: 16mm
Stem Length: 18mm
Sienna, Tacoma & Tundra Pick-Up
1999 - On

UNIT PACKAGE: 15



21605

(90189-A0002)
Black Nylon

Screw Grommet
M5.5 (#12) Screw Size
Head Diameter: 20mm
Stem Length: 17mm
Fits Into 9mm x 9mm Hole
Toyota Avalon, Corolla,
FJ Cruiser, RAV4, Sienna,
Tacoma & 4Runner and Lexus
GX460, GX470 & LX570
1995 - On

UNIT PACKAGE: 25



20440

(90189-06065)
Black Nylon

Hood & Fender
Screw Grommet
M5.5 (#12) Screw Size
Head Diameter: 20mm
Stem Length: 18mm
Fits Into 9mm x 9mm Hole
Camry & RAV 4
1999 - 95

UNIT PACKAGE: 15



19721

(90189-06157)
Black Nylon

Fender Lining
Screw Grommet
M5.5 (#12) Screw Size
Head Diameter: 20mm
Stem Length: 22mm
Fits Into 8mm x 8mm Hole
Avalon, Camry, RAV4, Solara
& Tacoma
1995-On

UNIT PACKAGE: 15

TOYOTA CLIPS & FASTENERS

Sec. 22



21411
(90189-06177)
Black Nylon

Rocker Moulding
Screw Grommet
M5.5. (#12) Screw Size
Head Diameter: 20mm
Stem Length: 22mm
Fits Into 9mm x 9mm Hole
Camry
2010 - On

UNIT PACKAGE: 15



20412
(90189-06114)
White Nylon

Front Fender Liner
Screw Grommet
M5.5 (#12) Screw Size
Head Dia: 18mm
Stem Length: 15mm
Fits Into 9mm Sq. Hole
RAV4
1996 - On

UNIT PACKAGE: 15



14266
(90189-06003)
Nylon

Screw Grommet
#14 (1/4") Or
M6.3-1.81 Screw Size
Head Diameter: 18mm
Stem Length: 21mm
Fits Into 8mm x 8mm Hole

UNIT PACKAGE: 15



14273
(90189-06005)
White Nylon

Screw Grommet
#14 (1/4") Or M6.3-1.81 Screw Size
Head Diameter: 18mm
Stem Length: 16mm
Fits Into 8mm x 8mm Hole
Lexus & Toyota

UNIT PACKAGE: 50



14267
(90189-06013)
Black Nylon

Screw Grommet
#14 (1/4") Or M6.3-1.81 Screw Size
Head Diameter: 20mm
Stem Length: 17mm
Fits Into 8mm x 8mm Hole
Lexus & Toyota

UNIT PACKAGE: 25



21237
(53867-47020)
Dark & Light Gray Nylon

Front Fender Retainer
With Sealer
Overall Height: 18mm
Fits Into 10mm x 16mm Hole
Prius
2004 - On

UNIT PACKAGE: 10



19534
(90467-10152)
Natural Nylon

Cowl Vent Grommet
Flange Diameter: 18mm
Stem Length: 16mm
Fits Into 9mm Hole
Use With Auveco 19535
Lexus ES300, Toyota Camry
& Tercel
1995-On

UNIT PACKAGE: 10



19535
(90467-07126)
Black Nylon

Cowl Vent Pin Retainer
Head Diameter: 16mm
Stem Length: 17mm
Use With Auveco 19534
Lexus ES300, Toyota Camry
& Tercel
1995 - On

UNIT PACKAGE: 10



20758
(53879-58010)
Black Nylon

Front Fender & Bumper
Cover Clip
Width: 25mm
Length: 34mm

Use With Auveco 20757
Lexus and Toyota 4 Runner,
Highlander, Sienna & Solara
2000 - On

UNIT PACKAGE: 5



20757
(47749-58010)
Black Nylon

Front Fender & Bumper
Cover Pin Retainer
Head Diameter: 15mm
Stem Length: 25mm
Use With Auveco 20758
Lexus and Toyota 4 Runner
Highlander, Sienna & Solara
2000 - On

UNIT PACKAGE: 10



19583
(90950-01911)
Black Nylon

Rocker Panel Retainer
Diameter: 25mm
Solara
1998-On

UNIT PACKAGE: 10



19014
(90467-10123)
Natural Nylon

Trim Panel Retainer
Head Size: 11mm x 12mm
Stem Length: 16mm
Fits Into 8mm Hole
Celica
1993-On

UNIT PACKAGE: 10

Sec. 22**TOYOTA CLIPS & FASTENERS**

19686
(90467-05045-22)
Black Nylon

Weatherstrip Retainer
Head Diameter: 12mm
Stem Diameter: 5mm Sq.
Stem Length: 6mm
Solara
1998-On

UNIT PACKAGE: 25



20878
(90467-A0008)
Black Nylon

Bumper Cover Retainer
Head Diameter: 19mm
Stem Diameter: 7.5mm
Stem Length: 16mm
Toyota, Lexus & Scion
1995 - On

UNIT PACKAGE: 50



21626
(90467-06128)
Black Nylon

Weatherstrip Retaining Clip
Head Diameter: 12mm
Stem Diameter: 6.5mm
Stem Length: 11mm
Camry & RAV4
1992 - On

UNIT PACKAGE: 15



19312
(90467-05096-22)
Black Nylon

Luggage Compartment
Trim Panel Retainer
Head Diameter: 16mm
Stem Diameter: 5mm
Stem Length: 13mm
Tercel & Paseo
1994-On

UNIT PACKAGE: 25



21253
(90467-05164-B6)
Gray Nylon

Headliner Retainer
Head Diameter: 20mm
Stem Diameter: 6mm
Stem Length: 15mm
Yaris
2009 - On

UNIT PACKAGE: 25



21296
(90080-46010)
Black Nylon

Hood Seal
Retaining Clip
Head Diameter: 13mm
Stem Diameter: 7mm
Stem Length: 10mm
Camry
2010 - On

UNIT PACKAGE: 50



19643
(90467-06175)
Black Nylon

Luggage Compartment
Retainer
Head Diameter: 16mm
Stem Diameter: 6mm
Stem Length: 16mm
Solara
1998-On

UNIT PACKAGE: 15

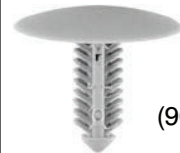

21332
(90467-05164-E2)
Tan Nylon

Headliner Retainer
Head Diameter: 20mm
Stem Diameter: 6mm
Stem Length: 15mm
Corolla & Yaris
2009 - On

UNIT PACKAGE: 25



18297
(Toyota: 90467-08004,
90467-08011; GM:
94842841, 94849113)
Black Nylon

Hood Seal Retaining Clip
Head Diameter: 13mm
Stem Length: 11mm
Fits Into 6mm Hole
Lexus, Toyota, Geo Prizm & Nova
1985-On

UNIT PACKAGE: 50



20184
(90467-08186)
Black Nylon

Luggage Compartment
Trim Retainer
Head Diameter: 16mm
Stem Diameter: 8mm
Stem Length: 16mm
Camry
1999 - On

UNIT PACKAGE: 25



19121
(90467-08104)
Gray Nylon

Roof Headliner Retainer
Head Diameter: 20mm
Stem Diameter: 8mm
Stem Length: 20mm
MR2
1990-On

UNIT PACKAGE: 15



14737
(Toyota: 90467-07050,
90467-08008;
Nissan: 01553-00172)
Black Nylon

Retaining Clip
Head Diameter: 13mm
Stem Length: 15mm
Fits Into 5mm Hole
Panel Thickness: 3mm

UNIT PACKAGE: 25

TOYOTA CLIPS & FASTENERS

Sec. 22



21643
(90467-08101)
Black Nylon

Hood To Cowl Top Seal
Retaining Clip
Head Size: 7mm x 13mm
Stem Diameter: 7.5mm
Stem Length: 13mm
Toyota Camry, Sequoia, Solara
& Tundra and Lexus ES 300
2006 - 1997

UNIT PACKAGE: 25



21634
(90467-10186)
Black Nylon

Dash & Fender Apron
Seal Retainer
Head Diameter: 16.5mm
Stem Diameter: 9mm
Stem Length: 13mm
Toyota 4 Runner, FJ Cruiser,
Land Cruiser, RAV4, Sequoia,
Tundra and Lexus GX 460,
GX 470 & LX 470
1996 - On

UNIT PACKAGE: 25



16779
(Honda: 74842-659-0030; Toyota: 90467-12078)
Black Nylon

Retaining Clip
Head Dia: 18mm
Stem Length: 15mm
Panel Thickness: 6mm
Fits Into 8mm Hole

UNIT PACKAGE: 25



14736
(90467-06161-01)
Black Nylon

Retaining Clip
Head Diameter: 14mm
Stem Length: 10mm
Fits Into 5mm Hole
Panel Thickness: 3mm

UNIT PACKAGE: 25



19124
(90467-07096)
Black Nylon

Side Trim Panel
Retaining Clip
Head Diameter: 16mm
Stem Length: 10mm
Fits Into 6mm Hole
4WD Truck 1989-On

UNIT PACKAGE: 10



19842
(75867-30110)
Black Nylon

Rocker Panel Clip
Head Diameter: 18mm
Stem Length: 22mm
Fits Into 9mm Hole
Corolla
1997 - On

UNIT PACKAGE: 15



16781
(Honda: 90670-692-0030; Toyota: 90467-09065)
Black Nylon

Retaining Clip
Head Dia: 15mm
Stem Length: 20mm
Panel Thickness: 11mm
Fits Into 7mm Hole

UNIT PACKAGE: 25



16777
(Mazda: B001-68-302-00; Toyota: 90950-01248)
Black Nylon

Retaining Clip
Head Dia: 15mm
Stem Length: 15mm
Panel Thickness: 2mm
Fits Into 8mm Hole

UNIT PACKAGE: 25



21254
(90467-08136)
Black Nylon

Fender Seal
Retaining Clip
Head Diameter: 20mm
Stem Diameter: 8mm
Stem Length: 8mm
Snaps Into 7mm Hole
Yaris

2009 - On

UNIT PACKAGE: 25



19122
(90467-08122)
Natural Nylon

Headliner Retaining Clip
Head Diameter: 15mm
Stem Diameter: 8mm
Stem Length: 12mm
Tacoma & T100
1992-On

UNIT PACKAGE: 15



14347
(Toyota: 90467-10018; Nissan: 01553-00202)
Black Nylon

Retaining Clip
Head Diameter: 18mm
Stem Length: 12mm
Snaps Into 7mm Hole
Panel Thickness: 4mm
Toyota and Nissan

UNIT PACKAGE: 50



21211
(53326-08010)
Black Nylon

Hood Insulation
Retaining Clip
Head Diameter: 24mm
Stem Length: 12mm
Fits Into 7mm Hole
Sienna

2009 - On

UNIT PACKAGE: 25

Sec. 22**TOYOTA CLIPS & FASTENERS****19113**
(90467-08124)
Black Nylon

Hood Insulation Retainer
 Head Diameter: 25mm
 Stem Diameter: 8mm
 Stem Length: 12mm
 Supra 1993-On
 Lexus 1994-89

UNIT PACKAGE: 15

**18842**
(90467-09006)
Black Nylon

Hood Insulation Retainer
 Head Diameter: 30mm
 Stem Length: 17mm
 Fits Into 7mm Hole
 Avalon, Camry, Lexus
 1988-On

UNIT PACKAGE: 15

**21548**
(67869-20030)
Black Nylon

Weatherstrip Retainer
 Head Diameter: 10mm
 Stem Diameter: 6mm
 Stem Length: 10mm
 Toyota Camry, Celica, Corolla,
 Highlander, Matrix, MR-2,
 Prius, RAV4, Scion, Solara & Supra
 and Lexus IS 300 & SC 430
 1990 - On

UNIT PACKAGE: 25

**19729**
(90467-09050)
Black Nylon

Hood Insulation Retainer
 Head Diameter: 25mm
 Stem Length: 10mm
 Fits Into 7mm Hole
 Lexus, Camry & Solara
 1998-On

UNIT PACKAGE: 15

**14738**
(90467-09008)
Black Nylon

Retaining Clip
 Head Diameter: 30mm
 Stem Length: 17mm
 Fits Into 7mm Hole
 Panel Thickness: 6mm

UNIT PACKAGE: 25

**21552**
(90467-04034)
White Nylon

Weatherstrip Retainer
 Top Head Size: 5mm x 15mm
 Bottom Head Diameter: 9mm
 Stem Diameter: 6.5mm
 Stem Length: 4mm
 Toyota Avalon, Corolla, Highlander,
 Matrix, Prius, RAV4, Scion & Venza
 and Lexus CT 200h, HS 250h, IS F,
 IS 250, IS 350, LS 460, LS 600h,
 RX 350, RX 400h & RX 450h
 2003 - On

UNIT PACKAGE: 25

**18878**
(90467-08081)
Black Nylon

Hood Insulation Retainer
 Head Diameter: 30mm
 Stem Length: 16mm
 Fits Into 6mm Hole
 Celica
 1993-89

UNIT PACKAGE: 15

**19123**
(90467-10107)
Black Nylon

Fender Apron Seal Clip
 Head Diameter: 17mm
 2WD & 4WD Truck
 1988-On

UNIT PACKAGE: 10

**21627**
(67868-30030)
Black Nylon

Door & Roof Rail Retainer
 Head Diameter: 9mm
 Stem Diameter: 5.3mm
 Stem Length: 8mm
 Toyota Camry, Corolla, Corona
 & Land Cruiser
 1999 - 74
 Lexus HS 250h, IS 250, IS 350,
 RX 350 & 450h
 2006 - On

UNIT PACKAGE: 25

**19749**
(67867-12150)
White Nylon

Weatherstrip Retainer
 Head Size: 5mm x 15mm
 Stem Length: 10mm
 Fits Into 6mm Hole
 Avalon
 1995 - On

UNIT PACKAGE: 15

**19112**
(90467-09004)
Black Nylon

Hood Insulation Retainer
 Head Diameter: 30mm
 Stem Diameter: 8mm
 Stem Length: 16mm
 Tacoma
 1995-On

UNIT PACKAGE: 15

TOYOTA CLIPS & FASTENERS

Sec. 22



18692

(Mazda: G031-58-762;
Toyota: 67868-89101,
67867-28030,
67867-89103; Ford:
E7GZ-6120586-B)
Natural Nylon

Weatherstrip Retainer
Head Size: 5mm x 15mm
Stem Length: 10mm
Fits Into 5mm Hole
4-Runner
1989-83
Mazda 1996-On
Ford

UNIT PACKAGE: 50



20443

(67867-0C010)
Black Nylon

Weatherstrip Retainer
Head Size: 5mm x 15mm
Stem Length: 10mm
Fits Into 6mm Hole
Tundra
1999 - On

UNIT PACKAGE: 25



19728

(90467-10146)
Black Nylon

Cowl Panel Retainer
Head Size: 8mm x 17mm
Stem Length: 14mm
Fits Into 7mm Hole
Sienna Van
1997 - On

UNIT PACKAGE: 25



19720

(90467-06138)
Black & White Nylon

Hood To Cowl Seal Retainer
Head Size: 8mm x 17mm
Stem Length: 16mm
Fits Into 7mm Hole
Avalon & Camry
1994 - On

UNIT PACKAGE: 10



21551

(67869-12050)
Black Nylon

Weatherstrip Retainer
Top Head Diameter: 9mm
Bottom Head Diameter: 12mm
Stem Diameter: 7mm
Stem Length: 13mm
Corolla & Prius
2007 - 01

UNIT PACKAGE: 25



16778

(Mazda: 9927-40-822;
Toyota: 62581-14020)
Natural Nylon

Trim Panel Retainer
Top Head Dia: 14mm
Bottom Head Dia: 18.5mm
Stem Dia: 11.5mm
Stem Length: 14mm
Overall Length: 20mm

UNIT PACKAGE: 25



20576

(GM: 88969790;
Toyota: 75867-21010)
Yellow Nylon

Fender Flare Retainer
Top Head Size: 10mm x 13mm
Bottom Head Size: 14mm x 18mm
Stem Diameter: 8.5mm x 8.5mm
Stem Length: 9mm
Overall Length: 13.5mm
Pontiac Vibe &
Toyota Echo
2002 - On

UNIT PACKAGE: 25



21226

(75867-02010)
Black Nylon

Rocker Moulding Retainer
Top Head Diameter: 13mm
Bottom Head Diameter: 18mm
Stem Diameter: 9mm
Stem Length: 10mm
Overall Length: 15.5mm
Corolla
2009 - On

UNIT PACKAGE: 25



18861

(90467-10162)
White Nylon

Scuff Plate Retainer
Top Head Dia: 13mm
Bottom Head Dia: 18mm
Stem Dia: 8.5mm x 8.5mm
Stem Length: 12mm
Overall Length: 17mm
Celica
1993-On

UNIT PACKAGE: 15



19719

(67921-32010)
White Nylon

Scuff Plate Retainer
Top Head Diameter: 13mm
Bottom Head Diameter: 18mm
Stem Dia: 10mm
Stem Length: 11mm
Overall Length: 17.5mm
Avalon, Camry & Corolla
1997 - On

UNIT PACKAGE: 15

Sec. 22**TOYOTA CLIPS & FASTENERS****21538**(75867-33030)
Charcoal NylonRocker Moulding Retainer
Top Head Diameter: 13mm
Bottom Head Diameter: 18mm
Stem Diameter: 9.5mm
Stem Length: 13mm
Overall Length: 18.5mm
Avalon, Camry, Prius, Scion,
Sienna, Solara & Venza
2000 - On

UNIT PACKAGE: 25

**20473**(67771-12070)
White NylonDoor Panel &
Rocker Moulding Retainer
With Sealer
Top Head Diameter: 13mm
Bottom Head Diameter: 18mm
Stem Diameter: 11mm
Stem Length: 14mm
Overall Length: 20mm
Lexus SC300/400
Toyota Avalon & Corolla
1992 - On

UNIT PACKAGE: 15

**19109**(67771-30070)
Natural NylonDoor Trim Panel
& Garnish Retainer
Top Head Dia: 13mm
Middle Head Dia: 16mm
Bottom Head Dia: 15mm
Stem Diameter: 9.5mm
Stem Length: 11mm
Overall Length: 18mm
Corolla Wagon, Tercel,
T-100 & Tacoma 2WD
1992-On

UNIT PACKAGE: 25

**21012**(75867-AA010)
Black NylonRocker Panel &
Scuff Plate Retainer
Top Head Diameter: 13mm
Bottom Head Diameter: 18mm
Stem Diameter: 9.5mm
Stem Length: 14mm
Overall Length: 18.5mm
Lexus ES300 & ES330
2002 - On
Toyota Avalon, Camry,
Scion & Solara
2004 - On

UNIT PACKAGE: 15

**21410**(90467-09212)
White NylonCowl Trim Retainer
Top Head Size: 13mm x 18mm
Middle Head Diameter: 16mm
Bottom Head Diameter: 18mm
Stem Diameter: 10.7mm
Stem Length: 12mm
Overall Length: 16mm
Camry
2010 - On

UNIT PACKAGE: 25

**20559**(GM: 88970345;
Toyota: 90467-10167)
Blue NylonGarnish Moulding Retainer
Top Head Diameter: 13mm
Middle Head Diameter: 16mm
Bottom Head Diameter: 18mm
Stem Diameter: 9mm x 9mm
Stem Length: 11mm
Overall Length: 18mm
Pontiac Vibe, Lexus and Toyota
2000 - On

UNIT PACKAGE: 25

**18875**(67771-16170)
White NylonDoor Trim
Panel Retainer
Top Head Dia: 13mm
Bottom Head Dia: 18mm
Stem Dia: 11mm
Stem Length: 15mm
Overall Length: 19.5mm
Tercel
1991-On

UNIT PACKAGE: 25

**20558**(62217-13010)
White NylonGarnish Moulding Retainer
Top Head Diameter: 13mm
Middle Head Diameter: 16mm
Bottom Head Diameter: 15mm
Stem Diameter: 9mm x 9mm
Stem Length: 11mm
Overall Length: 17mm
Lexus and Toyota Corolla,
Matrix & 4 Runner
2003 - On

UNIT PACKAGE: 25

**19203**(67771-89104)
Natural NylonQuarter Board
Inside Trim Panel Retainer
Top Head Dia: 13mm
Middle Head Dia: 16mm
Bottom Head Dia: 18mm
Stem Diameter: 11mm
Stem Length: 11mm
Overall Length: 18.5mm
Truck 2WD
1997-91

UNIT PACKAGE: 15



14728

(67771-22020)

Natural & Yellow Nylon

Door Panel Retainer
 Top Head Diameter: 12.5mm
 Middle Head Diameter: 16mm
 Bottom Head Diameter: 13mm
 Stem Diameter: 8.5mm
 Stem Length: 11mm
 Overall Length: 20mm

UNIT PACKAGE: 25



20575

(Toyota: 67771-12080;
 GM: 88970656)

Yellow & White Nylon

Door Panel & Rocker
 Moulding Retainer
 Top Head Dia: 13mm
 Middle Head Dia: 16mm
 Bottom Head Dia: 18mm
 Stem Diameter: 10mm
 Stem Length: 13mm
 Overall Length: 20mm
 Toyota & Lexus
 1998 - On

Pontiac Vibe 2003 - On

UNIT PACKAGE: 15



20437

(90467-09206)

White Nylon

Trim Panel Retainer
 Top Head Dia: 13mm
 Middle Head Dia: 16mm
 Bottom Head Dia: 18mm
 Stem Dia: 8.5mm x 8.5mm
 Stem Length: 15mm
 Overall Length: 20mm
 RAV 4 & Tundra
 2000 - On

UNIT PACKAGE: 15



18844

(67771-06010, 67771-32090)

White Nylon

Trim Panel Retainer
 Top Head Diameter: 13mm
 Middle Head Diameter: 16mm
 Bottom Head Diameter: 18mm
 Stem Diameter: 10mm
 Stem Length: 13mm
 Overall Length: 20mm
 Cowl Side & Garnish
 Center Pillar Retainer
 Camry
 1991-On

UNIT PACKAGE: 10



18876

(Toyota: 90467-10161;
 GM: 94858299)

White Nylon

Trim Board Retainer
 Top Head Dia: 13mm
 Middle Head Dia: 16mm
 Bottom Head Dia: 18mm
 Stem Dia: 9mm x 9mm
 Stem Length: 14mm
 Overall Length: 20mm
 Toyota Sienna, Solara & Tercel
 1990-On

Geo Prizm & Pontiac Vibe
 1998-On

UNIT PACKAGE: 25



20633

(90467-10188)

Turquoise Nylon

Trim Panel Retainer
 Top Head Diameter: 13mm
 Middle Head Diameter: 16mm
 Bottom Head Diameter: 18mm
 Stem Diameter: 8.5mm x 9mm
 Stem Length: 14mm
 Overall Length: 20mm
 Sienna
 2004 - On

UNIT PACKAGE: 25



18950

(90467-10168)

Black & White Nylon

Garnish Retainer
 Top Head Dia: 13mm
 Middle Head Dia: 16mm
 Bottom Head Dia: 18mm
 Stem Diameter: 10mm
 Stem Length: 13mm
 Overall Length: 20mm
 Avalon & Camry
 1991-On

UNIT PACKAGE: 5



19910

(90467-08179)

Yellow Nylon

Garnish Retainer
 Top Head Diameter: 13mm
 Middle Head Diameter: 16mm
 Bottom Head Diameter: 18mm
 Stem Diameter: 9mm x 9mm
 Stem Length: 14mm
 Overall Length: 20mm
 Tundra
 1999 - On

UNIT PACKAGE: 25



21102

(90467-A0005)

White Nylon

Door Trim Panel Retainer
 With Sealer
 Top Head Diameter: 13mm
 Middle Head Diameter: 16mm
 Bottom Head Diameter: 18mm
 Stem Diameter: 8.5mm
 Stem Length: 14mm
 Overall Length: 20mm
 Lexus ES 350, GX470, IS250, IS 350,
 IS F, LS 460 & LS 600HL
 and Toyota Camry, FJ Cruiser,
 Highlander, RAV4 & 4-Runner
 2001 - On

UNIT PACKAGE: 15



19257

(GM: 30006620;
Toyota: 67771-12050)
Maroon Nylon

Front & Rear Door
Trim Board Retainer
Top Head Diameter: 13mm
Middle Head Diameter: 16mm
Bottom Head Diameter: 18mm
Stem Diameter: 9.5mm
Stem Length: 14mm
Overall Length: 20.5mm
Chevrolet Geo, Metro & Tracker
1989 - On
Lexus and Celica,
Corolla & Previa
1990-On

UNIT PACKAGE: 15



14144

(67771-01010)
Black Nylon

Trim Panel Retainer
Top Head Diameter: 13mm
Middle Head Diameter: 15.5mm
Bottom Head Diameter: 18mm
Stem Diameter: 9.5mm
Stem Length: 14mm
Overall Length: 20.5mm

UNIT PACKAGE: 25



14269

(Toyota: 67771-01010,
67771-12010;
Isuzu: 8942264920;
Mazda: 9927-40-825)
White Nylon

Door Panel Retainer
Top Head Diameter: 13mm
Middle Head Diameter: 15.5mm
Bottom Head Diameter: 18mm
Stem Diameter: 9.5mm
Stem Length: 14mm
Overall Length: 20.5

UNIT PACKAGE: 25



14270

(67771-22010)
Blue & Natural Nylon

Door Panel Retainer
Top Head Diameter: 13mm
Middle Head Diameter: 15.5mm
Bottom Head Diameter: 18mm
Stem Diameter: 9.5mm
Stem Length: 14mm
Overall Length: 20.5mm

UNIT PACKAGE: 25



15709

(67771-02030)
Natural Nylon

Door Trim Retainer
Top Head Dia: 13mm
Middle Head Dia: 16mm
Bottom Head Dia: 17.5mm
Stem Diameter: 9.5mm
Stem Length: 13mm
Overall Length: 21mm
Corolla
1990 - On

UNIT PACKAGE: 50



19898

(67771-02030)
Yellow Nylon

Trim Panel Retainer
Top Head Dia.: 13mm
Middle Head Dia.: 16mm
Bottom Head Dia.: 18mm
Stem Diameter: 9.5mm
Stem Length: 13mm
Overall Length: 21mm
Corolla
1990 - On

UNIT PACKAGE: 50



15707

(67771-03030)
Gray Nylon

Door Trim Retainer
Top Head Dia: 13mm
Middle Head Dia: 16mm
Bottom Head: 17.5mm
Stem Length: 14mm
Stem Diameter: 10mm
Overall Length: 21mm
Camry
1988 - On

UNIT PACKAGE: 50



19108

(67771-16080)
Natural Nylon

Door Trim Panel
& Back Panel
Upper Garnish Retainer
Top Head Dia: 13mm
Middle Head Dia: 16mm
Bottom Head Dia: 18mm
Stem Diameter: 9.5mm
Stem Length: 14mm
Overall Length: 21mm
Truck
1988-On

UNIT PACKAGE: 10



18874

(67771-16120)
Gray Nylon

Front & Rear Door
Trim Panel Retainer
Top Head Dia: 13mm
Middle Head Dia: 16mm
Bottom Head Dia: 18mm
Stem Diameter: 9.5mm
Stem Length: 15mm
Overall Length: 21mm
Terrel
1994 - On

UNIT PACKAGE: 15



19016
(67771-12040)
Dark Gray Nylon

Door Trim Panel Retainer
Top Head Dia: 13mm
Middle Head Dia: 16mm
Bottom Head Dia: 18mm
Stem Diameter: 9.5mm
Stem Length: 15mm
Overall Length: 21mm
Cressida
1992 - 88

UNIT PACKAGE: 15



21103
(90467-05090-B1)
Black Nylon

Front Bumper Fascia
Push-Type Retainer
Head Diameter: 10mm
Stem Length: 12mm
Fits Into 5mm Hole
Corolla, Matrix
& Scion
2008 - On

UNIT PACKAGE: 10



21249
(90467-07071-22)
Black Nylon

Bumper Cover
Push-Type Retainer
Head Diameter: 11mm
Stem Length: 9mm
(Not Including The Pin)
Fits Into 7mm Hole
Yaris
2009 - On

UNIT PACKAGE: 25



19210
(67771-04040)
Natural Nylon

Front Door
Trim Panel Retainer
Top Head Dia: 13mm
Middle Head Dia: 16mm
Bottom Head Dia: 18mm
Stem Diameter: 10mm
Stem Length: 14mm
Overall Length: 22mm
Tacoma
1995 - On

UNIT PACKAGE: 50



17383
(GM: 94847334, 96057847;
Toyota: 90467-07066;
Suzuki: 09409-07313)
Black Nylon

Radiator Grille
& Trim Panel
Push-Type Retainer
Head Diameter: 11mm
Stem Length: 14mm
(Not Including The Pin)
Fits Into 7mm Hole
Toyota, Suzuki and
Geo Tracker & Prizm
1992 - 89

UNIT PACKAGE: 10



20196
(90467-06133-CO)
Black Nylon

Rocker Panel
Push-Type Retainer
Head Diameter: 14mm
Stem Length: 8mm
Fits Into 6mm Hole
4-Runner
1998 - On

UNIT PACKAGE: 15



19129
(Toyota: 67771-30090;
GM: 95008221)
Yellow Nylon

Door Trim Panel & Back Panel
Lower Garnish Retainer
Top Head Dia: 13mm
Middle Head Dia: 16mm
Bottom Head Dia: 18mm
Stem Diameter: 9.5mm
Stem Length: 17mm
Overall Length: 23mm
Land Cruiser & 2WD Truck
1991 - On

UNIT PACKAGE: 15



21218
(90467-05063-C0)
Black Nylon

Front Bumper
Push-Type Retainer
Head Diameter: 11mm
Stem Length: 8mm
Fits Into 5mm Hole
Corolla
2009 - On

UNIT PACKAGE: 15



21104
(90467-07190-B2)
Black Nylon

Interior Trim
Push-Type Retainer
Head Diameter: 14mm
Stem Length: 14mm
Fits Into 7mm Hole
Echo & Scion
2004 - On

UNIT PACKAGE: 10

Sec. 22**TOYOTA CLIPS & FASTENERS****17162**(GM: 96057846;
Toyota: 90467-07041)
Black NylonPush-Type Retainer
Head Diameter: 15mm
Stem Length: 8mm
(Not Including The Pin)
Fits Into 6.3mm Hole
Geo Metro & Tracker
And Toyota
1989 - On

UNIT PACKAGE: 10

**17206**(90467-09145)
Black NylonBumper Cover
Push-Type Retainer
Head Diameter: 15mm
Stem Length: 12mm
Fits Into 9mm Hole
Camry
1992-On

UNIT PACKAGE: 15

**21325**(90080-46294)
Black NylonTurn Signal Light &
General Purpose
Push-Type Retainer
Head Diameter: 16mm
Stem Length: 14mm
Fits Into 7mm Hole
Tundra
2003 - On

UNIT PACKAGE: 10

**21120**(90467-07192)
Black NylonCowl Vent
Push-Type Retainer
Head Diameter: 15mm
Stem Length: 9mm
(Not Including The Pin)
Fits Into 7mm Hole
RAV 4
2002 - On

UNIT PACKAGE: 15

**21011**(90467-07188)
Black NylonPush-Type Retainer
Head Diameter: 15mm
Stem Length: 17mm
Fits Into 7mm Hole
Camry, Tundra
& 4-Runner
2002 - On

UNIT PACKAGE: 15

**20335**(53879-60010)
Black NylonFender Liner
Push-Type Retainer
Head Diameter: 18mm
Stem Length: 7mm
Fits Into 7mm Hole
Land Cruiser & RAV 4
1998 - On

UNIT PACKAGE: 15

**14260**(Toyota: 90467-06017;
Mazda: 9926-50-625;
GM: 20426301)
Black NylonPush-Type Retainer
Head Diameter: 15mm
Stem Length: 12mm
Fits Into 7mm Hole

UNIT PACKAGE: 15

**19552**(90467-07146)
Black NylonCowl Panel & Luggage
Compartment Retainer
Head Dia.: 16mm
Stem Length: 9mm
Fits Into 7mm Hole
Avalon, Camry, Celica & Solara
1993 - On

UNIT PACKAGE: 15

**20869**(GM: 88970767;
Toyota: 90467-10183)
Black NylonFront Fender Liner
Push-Type Retainer
Head Diameter: 18mm
Stem Length: 7.5mm
Fits Into 7mm Hole
Celica, Corolla,
Matrix & Solara, Lexus And
Pontiac Vibe
1999 - On

UNIT PACKAGE: 10

**19013**(90467-07059-22)
Black NylonRear Door Trim &
Luggage Compartment Door
Push-Type Retainer
Head Diameter: 15mm
Stem Length: 10mm
Fits Into 7mm Hole
Camry & Celica
1990-On

UNIT PACKAGE: 15

**21624**(90467-10206)
Black NylonCowl
Push-Type Retainer
Head Diameter: 16mm
Stem Length: 10mm
Fits Into 8mm Hole
Toyota Camry, Sequoia,
Tundra & Yaris and
Lexus ES 350, RX350 & RX 450h
2006 - On

UNIT PACKAGE: 15

**19490**(90467-06150)
Black NylonBack Garnish Trim Panel
Push-Type Retainer
Head Diameter: 18mm
Stem Length: 8mm
Fits Into 6mm Hole
Tacoma
1995 - On

UNIT PACKAGE: 10



20349

(Toyota: 90467-08185;
Nissan: 01553-09611)
Black Nylon

Push-Type Retainer
Head Diameter: 18mm
Stem Length: 10mm
(Not Including The Pin)
Fits Into 8mm Hole
Lexus & Toyota
2002 - On
Nissan
1994 - On

UNIT PACKAGE: 15



21547

(90467-09185)
Black Nylon

Front Spoiler & Grille
Push-Type Retainer
Head Diameter: 18mm
Stem Length: 10mm
Fits Into 9mm Hole
Toyota Celica, Sequoia,
Sienna & 4 Runner and
Lexus HS 250h
1994 - On

UNIT PACKAGE: 25



21123

(75867-30120)
Black Nylon

Rocker Moulding
Push-Type Retainer
Head Diameter: 18mm
Stem Length: 12mm
(Not Including The Pin)
Fits Into 8mm Hole
Toyota Camry and Lexus GS350,
GS430, GS460 & LS460
2007 - On

UNIT PACKAGE: 15



16784

(Nissan: 80999-05N07;
Toyota: 90467-07043)
Black Nylon

Push-Type Retainer
Head Diameter: 18mm
Stem Length: 11mm
(Not Including The Pin)
Fits Into 7mm Hole

UNIT PACKAGE: 25



19416

(Toyota: 90467-09139)
Black Nylon

Bumper Cover &
Wheel Housing
Push-Type Retainer
Head Diameter: 18mm
Stem Length: 12mm
(Not Including The Pin)
Fits Into 9mm Hole
Honda, Mazda 626 &
Toyota Corolla
1992-On

UNIT PACKAGE: 15



21225

(53888-48010)
Black Nylon

Wheel Opening
Push-Type Retainer
Head Diameter: 18mm
Stem Length: 14mm
Fits Into 7mm Hole
Highlander
2001 - On

UNIT PACKAGE: 5



18873

(52161-16010,
52161-02020)
Black Nylon

Rear Bumper Cover
Push-Type Retainer
Head Diameter: 18mm
Stem Length: 28mm
Fits Into 9mm Hole
Tercel
1988-On

UNIT PACKAGE: 6



20931

(52161-20010)
Black Nylon

Bumper Cover & Grille
Push-Type Retainer
Head Diameter: 18mm
Stem Length: 31mm
Fits Into 9mm Hole
Toyota
2000 - On

UNIT PACKAGE: 15



19908

(90467-07121)
Black Nylon

Door Trim Panel
Push-Type Retainer
Head Diameter: 20mm
Stem Length: 8mm
(Not Including The Pin)
Fits Into 7mm Hole
RAV4
1997 - On

UNIT PACKAGE: 10



19907

(90467-07121-B2)
Gray Nylon

Door Trim Panel
Push-Type Retainer
Head Diameter: 20mm
Stem Length: 8mm
(Not Including The Pin)
Fits Into 7mm Hole
RAV4
1997 - On

UNIT PACKAGE: 10



20577

(GM: 88970494, 88973676
Toyota: 90467-07168)
Black Nylon

Rocker Panel & Garnish Moulding
Push-Type Retainer
Head Diameter: 20mm
Stem Length: 8mm
Fits Into 7mm Hole
Pontiac Vibe 2003 - On
Lexus & Toyota
2000 - On

UNIT PACKAGE: 15



18888
(90467-07166)
Black Nylon

Front Fender Liner
Push-Type Retainer
Head Diameter: 20mm
Stem Length: 8mm
(Not Including The Pin)
Fits Into 7mm Hole
Tercel
1994-On

UNIT PACKAGE: 15



19128
(90467-07044)
Black Nylon

Quarter Panel
Wheel Opening Moulding
Push-Type Retainer
Head Diameter: 20mm
Stem Length: 9mm
Fits Into 7mm Hole
T-100
1992-On

UNIT PACKAGE: 10



21294
(90467-07214)
Black Nylon

Radiator Splash Shield
Push-Type Retainer
Head Diameter: 20mm
Stem Length: 9mm
Fits Into 7mm Hole
Camry
2007 - On

UNIT PACKAGE: 25



21010
(90467-09166)
Black Nylon

Push-Type Retainer
Head Diameter: 20mm
Stem Length: 9mm
Fits Into 9mm Square Hole
Camry
2006 - On

UNIT PACKAGE: 15



20908
(Toyota: 90467-07164;
Suzuki: 09409-07332)
Black Nylon

Fender Splash Shield
Push-Type Retainer
Head Diameter: 20mm
Stem Length: 10mm
Fits Into 7mm Hole
Camry, Echo,
MR2 & Sienna
1997 - On
Suzuki 1999 - On

UNIT PACKAGE: 10



20955
(90467-07201)
Black Nylon

Engine Under Cover
Push-Type Retainer
Head Diameter: 20mm
Stem Length: 10mm
Fits Into 7mm Hole
Lexus ES300/330 and
Toyota Avalon, Camry & Solara
2002 - On

UNIT PACKAGE: 10



21596
(Toyota: 75867-06030)
Black Nylon

Rocker Panel
Push-Type Retainer
Head Diameter: 20mm
Stem Length: 16mm
Fits Into 8mm Hole
Toyota & Lexus
2007 - On

UNIT PACKAGE: 25



19140
(Acura: 90505-SL0-003;
GM: 94852368;
Mitsubishi:
MB888869; Toyota:
90467-08155)
Black Nylon

Push-Type Retainer
Head Dia: 20mm
Stem Length: 21mm
Fits Into 8mm Hole
Acura, Dodge Avenger, Eagle Talon,
Geo Prizm, Mitsubishi Eclipse
& Galant and Toyota
1993-On

UNIT PACKAGE: 5



19739
(90467-09127)
Black Nylon

Bumper Cover
Push-Type Retainer
Head Diameter: 20mm
Stem Length: 26mm
Fits Into 9mm Hole
Avalon, Camry,
Corolla & Solara
1998 - On

UNIT PACKAGE: 10



21366
(90467-09227)
Black Nylon

Bumper & Engine Under Cover
Push-Type Retainer
Head Diameter: 22mm
Stem Length: 15mm
Fits Into 9mm Hole
4 Runner, RAV4 & Scion XB
2006 - On

UNIT PACKAGE: 10



19219
(90467-09096)
Black Nylon

Front Bumper
Push-Type Retainer
Head Diameter: 15mm
Stem Length: 27mm
Fits Into 9mm Hole
Lexus LS400 1993-On
Celica & Supra 1989-On

UNIT PACKAGE: 10

TOYOTA CLIPS & FASTENERS

Sec. 22



14732
(53455-14020)
Nylon

Hood Prop
Rod Clip
Holds 8mm Dia. Rod
Snaps Into 14mm Hole
UNIT PACKAGE: 15



19529
(53455-33010,
53455-33011)
Natural Nylon

Hood Prop Rod Clip
Holds 9mm Rod
Fits Into 10mm Square Hole
Camry
1996 - On

UNIT PACKAGE: 15



20470
(69293-12040)
Yellow Nylon

Door Lock Rod Clip
Rod Size: 5mm
Left (Driver) Side
Lexus ES 300 2001 - 97
Toyota Camry, Celica, Corolla,
Echo, Highlander, MR2, RAV4,
Tundra and 4-Runner
1994 - On

UNIT PACKAGE: 10

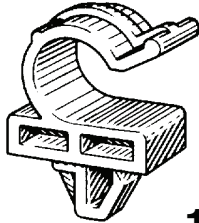

16780
(Nissan: 99604-H1400;
Toyota: 58788-13010)

Hood Prop Rod Clip
Holds 11mm Dia. Rod
Fits Into 10mm x 12mm Hole
UNIT PACKAGE: 10



21336
(69293-30030)
Natural Nylon

Door Lock Rod Clip
Rod Size: 5mm
Fits Into 8mm Hole
Overall Height: 20mm
Toyota & Lexus
1993 - On

UNIT PACKAGE: 10



20534
(69293-12050)
Natural Nylon

Door Lock Rod Clip
Rod Size: 5mm
Fits Into 8.5mm Hole
Right (Passenger) Side
Lexus ES250, 300 & RX300
and Toyota Tacoma
1990 - On

UNIT PACKAGE: 10



17631
(90959-01136)
Nylon

Hood Prop Rod Clip
Holds 6mm & 7mm Rods
Toyota

UNIT PACKAGE: 25



20469
(69293-12030)
Natural Nylon

Door Lock Rod Clip
Rod Size: 5mm
Right (Passenger) Side
Lexus ES 300 2001 - 97
Toyota Camry, Celica, Corolla,
Echo, Highlander, MR2,
RAV4, Tundra and 4-Runner
1994 - On

UNIT PACKAGE: 10



20535
(69293-12060)
Yellow Nylon

Door Lock Rod Clip
Rod Size: 5mm
Fits Into 8.5mm Hole
Left (Driver) Side
Lexus ES250, 300 & RX300
And Toyota Tacoma
1990 - On

UNIT PACKAGE: 10



17611
(53452-90351)
Nylon

Hood Prop Rod Clip
Holds 6mm & 7mm Rods
Toyota

UNIT PACKAGE: 10

Not Actual Size



14284

(Toyota: 90463-10337;
Honda: 90669-671-0000;
90669-671-0030)
Nylon

Cable Strap
Length: 110mm (5-5/16")
Max. Bundle Diameter: 23mm
Fits Into 6mm Hole

UNIT PACKAGE: 15



Not Actual Size

21553

(82711-12200)
Black Nylon

Cable Strap
Length: 170mm (6-3/4")
Width: 7mm (7/32")
Maximum Bundle Diameter:
40mm (1-9/16")
Camry, Celica, Corolla, Cressida,
Land Cruiser, MR-2, Paseo, Previa,
RAV4, Supra, T-100, Tercel
& 4-Runner
1998 - On

UNIT PACKAGE: 25



Not Actual Size

20380

(Not Supplied
By O.E.M.)
Black Nylon

Cable Strap
Length: 200mm (8")
5mm (3/16") Wide
Max. Bundle Dia: 44mm (1-3/4")
Fits Into 6.3mm (1/4") Hole
Import Cars

UNIT PACKAGE: 25



16306

(90183-03001)

Front Bumper
Cushion Clip
Toyota
1982-On

UNIT PACKAGE: 25



16671

(90468-04030)

Bumper Strip
Retainer
Toyota
1984-On

UNIT PACKAGE: 25



21611

(76879-44010)
Dacromet

Front and Rear Spoiler
Locking Fastener
16mm Wide
Corolla, Matrix, Prius
& Solara
2003 - On

UNIT PACKAGE: 15



21337

(65613-07010)
Black Nylon

Cowl Vent & Fender Apron
Nylon Flange Nut
Flange Diameter: 22mm
Stud Size: 6mm
Overall Height: 10mm
Venza
2009 - On

UNIT PACKAGE: 15



14750

(Toyota: 53879-14010-A,
53879-14020,
53879-22030; GM: 94841226;
Mazda: LA01-56-135)
Black Nylon

Fender/Wheel
Housing
#10 Screw Size
20mm Wide
31mm Long
Panel Range: Up to 1mm
Center of Hole To Edge: 11mm
Toyota, Geo And Mazda

UNIT PACKAGE: 15

19669

Same As 14750
Except For Packing
UNIT PACKAGE: 25



21359

(53879-17020)
Black Nylon

Bumper & Fender Apron
"U" Nut
M4.8 (#10) Screw Size
Center Of Hole To Edge: 10mm
Panel Range: Up To 2mm
Toyota Celica and Lexus
2000 - On

UNIT PACKAGE: 10

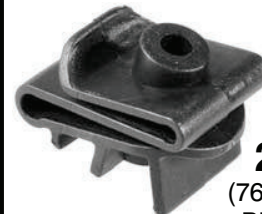

21616

(76647-42010)
Black Nylon

Fender & Mudguard
"U" Nut
M4.8 (#10) Screw Size
Panel Range: Up To 2mm
Center Of Hole To Edge: 7mm
RAV4
2001 - On

UNIT PACKAGE: 15



21613
(53879-20020)
Black Nylon

Front Fender Liner
Nylon "U" Nut
M5.5 (#12) Screw Size
Panel Range: Up To 2mm
Center Of Hole To Edge: 11mm
Camry & Sienna
1996 - On

UNIT PACKAGE: 15



21614
(90467-05128)
White Nylon

Rear Bumper & Bumper Stay
Nylon "U" Nut
M6 (#14) Screw Size
Panel Range: Up To 2mm
Center Of Hole To Edge: 12mm
RAV4 & Yaris
1996 - On

UNIT PACKAGE: 15



14276
(53879-22010)
Black Nylon

Nylon "U" Nut
Fender/Wheel
Housing Applications
#14(1/4") Screw Size
20mm Wide
29mm Long
Panel Range: Up To 1mm
Center Of Hole To Edge: 15mm

UNIT PACKAGE: 15

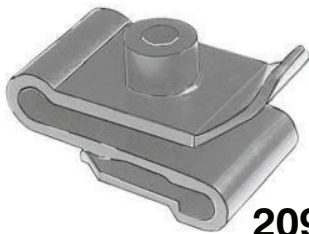

20956
(90467-05114)
Black Nylon

Bumper & Fender Apron
Nylon "U" Nut
Screw Size: M5.5 (#12)
Width: 20mm, Length: 36mm
Panel Range: Up To 1mm
Center Of Hole to Edge: 14mm
Lexus & Toyota
2000 - On

UNIT PACKAGE: 10



21615
(90467-A0018,
90467-05081)
Maroon Nylon

Left & Right Front Bumper
& Bumper Stay
Nylon "U" Nut
M6 (#14) Screw Size
Panel Range: Up To 2mm
Center Of Hole To Edge: 12mm
Toyota Avalon, Camry & Solara
and Lexus
2000 - On

UNIT PACKAGE: 15



13225
Plated

"U" Type Nut
4.2mm (#8) Screw Size
11mm Wide
16.5mm Long
Panel Range: .5mm-2.5mm
Center of Hole To Edge: 8mm

UNIT PACKAGE: 50

HELPFUL HINTS FOR USING THE AUVECO CATALOG

- The **color-coded pages** signify various sections which are as follows:
BLUE - Metric Items
BEIGE - Electrical Accessories
GREEN - Assortments, Cabinets, Bins & Racks
GRAY - Key Blanks & Accessories
PINK - Import Car Body Hardware
- Most pictures and illustrations are actual size.
- We have **Specification Charts** for:
Body Bolts (pages 20 & 49-50)
Special Tapping Screws (pages 23-26 & 54-57)
License Plate Screws (pages 33-34)
"Xmas Tree" Retainers (pages 404-413)
Push-Type Retainers (pages 450-460)
- We have **three different types of indexes** in the front of the catalog to assist you.
PICTORIAL QUICK INDEX ALPHABETICAL INDEX NUMERICAL INDEX
- There are two **O.E.M Part Cross References** at the back of the catalog.

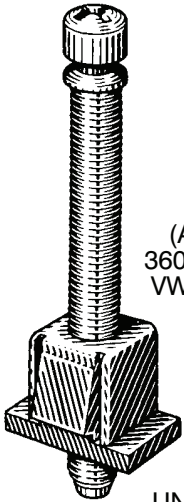
Sec. 22**VOLKSWAGEN & AUDI CLIPS & FASTENERS**

15666
(AMC: 36000148,
36001966, 56001419;
VW: 176-941-1117A)

1/4"-28 x 2-1/4"
Headlight Adjusting
Screw and
Nut Assembly
AMC & VW

UNIT PACKAGE: 10



12635
(801-853-577)
Nylon

Moulding Clip
VW

UNIT PACKAGE: 25



19136
(1HO-853-733B)
Nylon

Windshield Reveal
Moulding Clip
VW Golf & Jetta
1999-93

UNIT PACKAGE: 15



10322
(131-853-585C)
Nylon

Body Side Moulding Clip
VW

UNIT PACKAGE: 50



13189
(803-853-139A)
Nylon

Moulding Clip
Audi

UNIT PACKAGE: 50



13174
(803-853-139C)
Red Nylon

Moulding Clip
VW

UNIT PACKAGE: 25



13229
(113-853-585C)
Nylon

Moulding Clip
w/ Sealer
VW

UNIT PACKAGE: 50



21416
(191-853-733-A)
White Nylon

Moulding Clip
Width: 8mm
Length: 31mm
Passat
1997 - 90

UNIT PACKAGE: 25



21493
(4A0-853-825-A)
White Nylon

Front & Rear Door
Moulding Clip
Width: 22mm
Length: 35mm
Audi
1998 - 92

UNIT PACKAGE: 25



21390
(191-853-577-A)
White Nylon

Door Moulding Clip
Top Head Size: 11.6mm x 15mm
Bottom Head Diameter: 11mm
Stem Diameter: 6mm
Stem Length: 14mm
VW & Audi
1985 - On

UNIT PACKAGE: 25



21508
(191-853-577)
White Nylon

Door Trim & Scuff Plate
Moulding Clip
Head Size: 12mm x 15mm
Stem Diameter: 10mm
Stem Length: 19mm
Audi A1 & A2 and VW Golf & Jetta

UNIT PACKAGE: 25



21449

(3B0-853-575)
White Nylon

With Blue Rubber Grommet

Moulding Clip
Width: 17.5mm
Length: 21mm
Stem Length: 12mm
Passat
2005 – 1998

UNIT PACKAGE: 25



21481

(Audi: 4A0-853-825-C)
White Nylon

Rear Door
Moulding Clip
Width: 26mm
Length: 34.5mm
Stem Length: 6mm
Audi 100, A6, S4, S6 & Quattro
1998 – 92

UNIT PACKAGE: 25



21394

(1H0-853-585)
White Nylon

With Blue Rubber Grommet

Door Moulding Clip
Width: 34mm
Length: 38.5mm
Stem Length: 10mm
Audi & VW Cabrio, Golf
& Jetta
2002 – 1993

UNIT PACKAGE: 15



21512

(7L0-839-069)
White Nylon

Rocker Panel
Moulding Clip
Width: 10mm
Length: 28.5mm
Stem Length: 11mm
Fits Into 10mm Hole
Touareg
2010 – 05

UNIT PACKAGE: 25



21448

(3A0-853-575-A)
White Nylon

With Blue Rubber Grommet

Moulding Clip
Width: 16mm
Length: 17mm
Stem Length: 13mm
Passat
1997 - 95

UNIT PACKAGE: 25

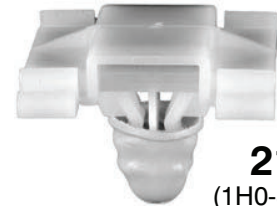

21395

(1H0-853-585-B)
White Nylon

With Blue Rubber Grommet

Door Moulding Clip
Width: 34mm
Length: 38.5mm
Stem Length: 18mm
Audi & VW Cabrio
2002 – 1999

UNIT PACKAGE: 15

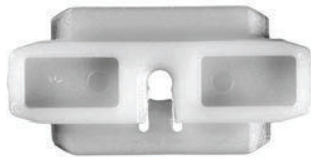

21491

(443-853-909-A)
Natural Nylon

Front Door, Fender &
Quarter Panel
Moulding Clip
Width: 20mm
Length: 41.5mm
Audi
1998 – 88

UNIT PACKAGE: 25



21447

(3B0-853-576)
White Nylon

With Blue Rubber
Grommet

Moulding Clip
Width: 24.5mm
Length: 27mm
Stem Length: 12mm
Passat
2005 – 1998

UNIT PACKAGE: 15



21492

(4A0-853-825)
White Nylon

Front & Rear Door, Fender &
Quarter Panel
Moulding Clip
Width: 22mm
Length: 35mm
Overall Height: 16mm
Audi
1998 – 92

UNIT PACKAGE: 25



21396

(1H0-853-858-A)

White Nylon

With Blue Rubber Grommet

Quarter Panel

Moulding Clip

Width: 23mm

Length: 40mm

Stem Length: 11mm

Audi & VW Cabrio, Golf & Jetta

2002 – 1993

UNIT PACKAGE: 15

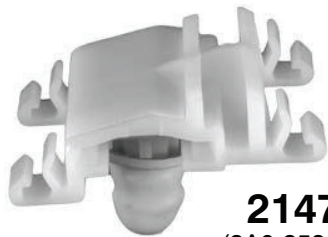

21478

(3A0-853-575)

White & Orange

Nylon With Blue

Rubber Boot

Door, Fender & Quarter Panel

Moulding Clip

Width: 35mm

Length: 38mm

Stem Length: 14mm

Volkswagen

1997 – 90

UNIT PACKAGE: 15



13173

(VW: N14389.3;

Volvo: 3104-426)

Metal

Door Panel Clip

Use With 13206

UNIT PACKAGE: 50



13176

(113-853-585B)

Metal

Moulding Clip

UNIT PACKAGE: 25



8843

Nylon

Moulding Fastener

Fits 1/2" -5/8" Mouldings

UNIT PACKAGE: 50



21498

(191-941-142)

White Nylon

Headlight Adjusting Nut

Head Size: 14mm x 18.5mm

Overall Length: 15mm

Fits Into 10mm Hole

Audi 100 and VW Golf

1994 – 86

UNIT PACKAGE: 25



14014

(VW: 175-853-674;

GM: 20475950)

Black Nylon

Air Vent Nut

Use With 14013 Screw

UNIT PACKAGE: 50



12735

(GM: 1370853;

Chry: 6029501;

VW: 179-813-883)

Nylon

Headlight Bezel Nut

#6 Screw Size

GM & VW

1982-On

UNIT PACKAGE: 50



14030

(GM: 3997391;

VW: 179-813-881)

Black Nylon

Tail Light Nut

#8 Screw Size

GM Astro & Safari

1985-On

Volkswagen

UNIT PACKAGE: 25



21510

(867-809-966, 811-807-557-C)

Black Nylon

Screw Grommet

M4.8 (#10) Screw Size

Head Diameter: 12mm

Stem Length: 12.5mm

VW & Audi

UNIT PACKAGE: 25



21480

(VW: 165-827-592)

Natural Nylon

Screw Grommet

M4.2 (#8) Screw Size

Head Diameter: 11mm

Stem Length: 13mm

VW Cabrio, EuroVan, Golf

& Jetta

2003 – 1992

UNIT PACKAGE: 25



20924

(N908-338-01)

Black Nylon

Fender Apron Screw Grommet

M4.2 (#8) Screw Size

Head Dia: 15mm

Stem Length: 12mm

Cabrio, Golf, Jetta &

Phaeton

1999 - On

UNIT PACKAGE: 15



20925
(N908-214-01)
Black Nylon

Bumper & Fender Apron
Screw Grommet
M4.2 (#8) Screw Size
Head Dia: 15mm
Stem Length: 20mm
Audi A4/S4 and A6/S6
1996 - On
VW Cabrio, Golf, Jetta & Phaeton
1999 - On

UNIT PACKAGE: 15



21399
(811-807-577-C)
Black Nylon

Screw Grommet
M4.8 (#10) Screw Size
Head Diameter: 7mm x 12.5mm
Stem Length: 11mm
Audi Quattro, A4, A6, A8, RS6,
S4, S6, TT & 90 and Volkswagen
Golf, Jetta & Passat
2010 - 1990

UNIT PACKAGE: 25



20933
(357-827-998)
Black Nylon

Front & Rear Door Panel
Screw Grommet
M4.8 (#10) Screw Size
Head Diameter: 16mm
Stem Length: 20mm
Cabrio, Golf,
Jetta & Passat
1993 - On

UNIT PACKAGE: 15



20260
(1J0-853-120)
Maroon Nylon

Scuff Plate
Screw Grommet
Head Size: 14mm x 17mm Oval
Stem Length: 10mm
M4.2 (#8) Screw Size
Golf & Jetta
1999 - On

UNIT PACKAGE: 15



13227
(113-853-615A)
Nylon

Barrel Nut
For 3mm Stud
Fits Into 4mm Hole

UNIT PACKAGE: 50



20250
(357-853-586-D)
Black Nylon

Moulding Insert
Head Diameter: 13mm
Stem Length: 6mm
Fits Into 9mm Hole
Eurovan, Golf, Jetta
& Passat
1989 - On

UNIT PACKAGE: 25



13206
(113-857-219A)
Black Vinyl

Door Panel & Trunk Liner Plug
Use With 13173
VW Beetle & Audi

UNIT PACKAGE: 50



21397
(1H0-853-586)
Blue Rubber

Moulding Clip Grommet
I.D.: 7mm
Flange O.D.: 13mm
Overall Length: 12mm
Use With Auveco Moulding Clips
21394, 21395 & 21396
Audi and VW Cabrio, Golf,
Jetta, Passat & Touareg
2007 - 1990

UNIT PACKAGE: 50



21497
(1H0-837-719)
Black Nylon

Weatherstrip Retainer
With Clear Grommet
Head Size: 6mm x 15mm
Stem Diameter: 7.5mm
Stem Length: 17mm
Audi A3 and VW Golf, Sharan,
Transporter & Corsa

UNIT PACKAGE: 25



21392
(1H0-819-055-B01C)
Black Nylon

Instrument Panel, Cowl Vent,
Defroster Grille & Ducts
Retainer
Head Diameter: 23mm
Stem Diameter: 6.5mm
Stem Length: 16mm
Phillips Drive
Audi and Volkswagen Cabrio,
Golf & Jetta
2002 - 1993

UNIT PACKAGE: 25



21515
(4A0-805-121-A)
Black Nylon

Front Fender, Bumper &
Engine Cover
Retainer
Slotted Drive
Head Diameter: 25mm
Stem Length: 22mm
Passat & Audi
1992 - On

UNIT PACKAGE: 25

Sec. 22**VOLKSWAGEN & AUDI CLIPS & FASTENERS****21509**(357-853-575)
White NylonRetainer With Gray Grommet
Top Head Diameter: 12mm
Bottom Head Diameter: 18mm
Stem Diameter: 10mm
Stem Length: 16mm
Golf, Jetta, Passat & Scirocco
UNIT PACKAGE: 25**21496**(357-853-585-A)
White NylonTrim Panel Retainer
With Black Nylon Grommet
Top Head Diameter: 12mm
Bottom Head Diameter: 18mm
Stem Diameter: 10mm
Stem Length: 12mm
Golf & Passat and Audi B3
UNIT PACKAGE: 15**21252**(Audi: 8E0-867-276)
White NylonTrim Panel Retainer
Top Head Diameter: 13mm
Bottom Head Diameter: 15mm
Stem Diameter: 9mm
Stem Length: 11mm
Audi
2002 - On
UNIT PACKAGE: 25**21450**(703-867-299)
Black NylonSide Panel & Interior
Trim Retainer
Top Head Diameter: 13.5mm
Bottom Head Diameter: 18mm
Stem Diameter: 9mm
Stem Length: 14mm
VW
2003 - 1993
UNIT PACKAGE: 25**21495**(7L5-853-994)
Blue NylonTrim Panel Retainer
Top Head Diameter: 13mm
Bottom Head Diameter: 18mm
Stem Diameter: 9mm
Stem Length: 14mm
VW, Audi & Renault

UNIT PACKAGE: 25

**21516**(357-853-585)
White NylonRetainer
With Black Nylon Grommet
Top Head Diameter: 12mm
Bottom Head Diameter: 18mm
Stem Diameter: 10mm
Stem Length: 20mm
VW Golf A2 & A3 and Audi

UNIT PACKAGE: 25

**13475**(Renault:
8934-201-681;
VW: 175-867-299)
White NylonTrim Panel Retainer
Head Dia: 19mm
Stem Length: 18mm
Stem Dia: 9mm
AMC-Renault 1984-On
VW 1982-On

UNIT PACKAGE: 50

**13179**(481-867-197)
Black NylonTrim Panel Retainer
VW

UNIT PACKAGE: 50

**21494**(171-807-249-A)
Natural NylonTrim Panel Retainer
Top Head Diameter: 12mm
Bottom Head Diameter: 18mm
Stem Diameter: 9.5mm
Stem Length: 12mm
VW Golf & Audi
1978 - On

UNIT PACKAGE: 25

**20252**(823-867-299)
Black NylonTrim Panel Retainer
Top Head Dia: 14mm
Bottom Head Dia: 18mm
Stem Dia: 9mm
Stem Length: 14mm
Corrado, Eurovan, Jetta,
Rabbit & Vanagon
1979 - On

UNIT PACKAGE: 25

**20341**(3B0-868-243)
Black NylonDoor Trim Panel Retainer
Head Diameter: 22mm
Stem Length: 10mm
Fits Into 10mm Hole
Beetle, Golf, Jetta & Passat
1998 - On

UNIT PACKAGE: 25



21398
(6K0-868-243-C)
Black Nylon

Trim Panel Retainer
Top Head Diameter: 22mm
Bottom Head Diameter: 18mm
Stem Length: 12mm
Fits Into 8mm Hole
Audi and Volkswagen Touareg
2010 – 2004

UNIT PACKAGE: 25



21415
(1H0-868-243-B)
Tan and White Nylon

Adjustable
Door Trim Panel Retainer
Head Diameter: 28.5mm
Stem Diameter: 9.5mm
Stem Length: 11mm
Overall Length: 31mm
Golf
2002 – 1993

UNIT PACKAGE: 25



19195
(161-867-299-01C)
Black Nylon

Push-Type Retainer
Head Diameter: 16mm
Stem Length: 12mm
Fits Into 8mm Hole
VW Golf & Jetta
1997-93

UNIT PACKAGE: 25



21144
(8E0-868-243)
Black Nylon

Interior Trim Panel Retainer
With Sealer
Top Head Diameter: 21.5mm
Bottom Head Diameter: 27mm
Stem Diameter: 11mm
Stem Length: 19mm
Audi A4 & S4, Avant, Cabriolet,
Quattro & Sedan Wagon,
2005 – On

UNIT PACKAGE: 25



21145
(1H5-863-849-A-01C)
Black Nylon

Hood Insulation Retainer
Head Size: 20mm x 25mm
Stem Length: 13mm
Fits Into 12mm Hole
Audi A4, A6, Cabriolet, Quattro,
S4 & S6 and Volkswagen Beetle,
Golf, Jetta, Passat, Rabbit & Touareg
1998 – On

UNIT PACKAGE: 15



21451
(333-867-633-4FB)
Black Nylon

Front Lights & Windshield Washer
Push-Type Retainer
Head Diameter: 14mm
Stem Length: 10mm
Fits Into 8.5mm Hole
VW
1998 – 95

UNIT PACKAGE: 25



21393
(1H0-868-243)
Green & Black Nylon

Trim Retainer
Large Head Diameter: 28mm
Small Head Diameter: 19mm
Overall Length: 31mm
Audi and Volkswagen Cabrio,
Golf & Jetta
1999 – 1993

UNIT PACKAGE: 25



21391
(N038-550-1)
Dark Gray Nylon

Bumper, Exterior Trim,
Fender, Quarter Panel &
Wheel Opening
Push-Type Retainer
Head Diameter: 12mm
Stem Length: 11mm
Fits Into 8mm Hole
Audi and
Volkswagen EuroVan, Golf,
Jetta & Passat
2003 – 1985

UNIT PACKAGE: 25



21479
(701-867-299)
Gray Nylon

Front Bumper & Interior Trim
Push-Type Retainer
3mm Allen Head Drive
Head Diameter: 18.5mm
Stem Length: 11mm
Fits Into 9mm Hole
VW Jetta & Passat
1999 – On

UNIT PACKAGE: 25

Sec. 22**VOLKSWAGEN & AUDI CLIPS & FASTENERS**

21251
(6Q0-868-243)
Black & White Nylon

Trim Panel
Push-Type Retainer
With Sealer
Head Diameter: 22.5mm
Stem Length: 7mm
(Not Including The Pin)
Fits Into 8mm Hole
Golf, Jetta, Passat, Phaeton,
Rabbit & Tiguan
2004 – On

UNIT PACKAGE: 15



21483
(1H0-823-397)
Natural Nylon

Hood Prop Rod Clip
Rod Size: 8mm
Stem Length: 10mm
Fits Into 7mm Square Hole
VW
1999 – 93

UNIT PACKAGE: 25



21513
(N90-335-006)
Dacromet

Splash Shield & Wheel Well
Push-On Retainer
Stud Size: 5mm
O.D.: 30mm
VW & Audi

UNIT PACKAGE: 25



21452
(1H0-819-055-C01C)
Black Nylon

Push-Type Retainer
Top Head Diameter: 23mm
Bottom Head Diameter: 16mm
Stem Length: 15mm
Fits Into 8mm x 8mm Square Hole
VW
2002 – 1993

UNIT PACKAGE: 25



21514
(6N0-823-397-AC)
Black Nylon

Hood Prop Rod Clip
Rod Size: 8mm
Head Diameter: 15mm
Fits Into 7mm Square Hole
VW & Audi

UNIT PACKAGE: 25



21485
(N90-796-501,
N90-796-502)
Dacromet

Radiator Support & Splash Shield
Push-On Retainer
Stud Size: 5mm
O.D.: 30mm
VW
2006 – 1999

UNIT PACKAGE: 25



21482
(1H0-867-199-A)
Black Nylon

Push-Type Retainer
Head Diameter: 24mm
Stem Length: 13mm
Fits Into 9mm Square Hole
Passat
1999 – 90

UNIT PACKAGE: 25



Not Actual Size

21305
(Not Available From O.E.M.)
Natural Nylon

Push-Mount Cable Strap
Overall Length: 156mm (6-1/8")
Strap Width: 5mm (3/16")
Snaps Into 6.3mm (1/4") Hole
Maximum Bundle Diameter:
40mm (1-9/16")
European Makes & Universal

UNIT PACKAGE: 25



13217
(N15.422.2)
Plated

"U" Nut
4.2mm (#8) Screw Size
Panel Range: .7mm -1.6mm
Center Of Hole To Edge: 7mm

UNIT PACKAGE: 25



13216
Zinc

"U" Nut
4.8mm Screw Size
Panel Range: .9mm -2mm
Center Of Hole To Edge: 8mm

UNIT PACKAGE: 25



21456
(171-201-969)
Black Nylon

Moulding Nylon Flange Nut
Stud Size: 5mm
Hex: 10mm
Flange Diameter: 18.5mm
Overall Height: 10.5mm
Audi A8, S8 & 90
2003 - 1993

UNIT PACKAGE: 25



12595
(GM: 11503752, 11505329;
VW: N90100001)
Phosphate

Free Spinning Washer Nut
M6-1.0
16mm Washer O.D.
10mm Hex

UNIT PACKAGE: 25

16268

Same As 12595 Except For Packing

UNIT PACKAGE: 50



14013
(GM: 20475949;
VW: 175-853-673)
Black Nylon

Air Vent Screw
Use With 14014

UNIT PACKAGE: 50



11404
(N14-4003)
Plain Steel

Manifold Stud
M8-1.25 x 35mm

UNIT PACKAGE: 25



13031
(111-837-581J)
Black Nylon

Window Crank Handle
VW Beetle

UNIT PACKAGE: 1



14194
(321-837-581-016)

Window Crank Handle
VW, Scirocco & Dasher
1974-On

UNIT PACKAGE: 1

You Can E-Mail
Your New Item
Suggestions To
mail@auveco.com

Volvo



12637
(591-740)
Nylon

Body Side
Moulding Clip

UNIT PACKAGE: 50



13195
(1201-930)
Black Nylon

Moulding Clip

UNIT PACKAGE: 10



20405
(9151649-2)
White Nylon

Rocker Panel Moulding Clip
Stem Length: 14mm,
Fits Into 8mm Hole
850, C70, S70 & V70
1993 - On

UNIT PACKAGE: 10



13173
(VW: N14389.3;
Volvo: 3104-426)

Metal
Panel Clip

UNIT PACKAGE: 50



14211
(1-255-551)
Black Nylon

Windshield Clip

UNIT PACKAGE: 25

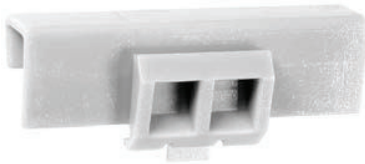
Sec. 22**VOLVO CLIPS & FASTENERS****14212**(1-246-926)
Gray Nylon

Windshield Clip

UNIT PACKAGE: 25

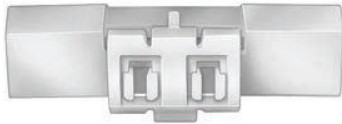
**14210**(1-255-553)
White Nylon

Windshield Clip

UNIT PACKAGE: 15

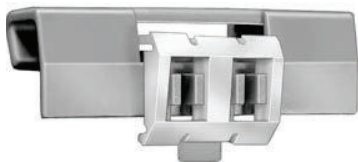
**14209**(1-246-993)
Green Nylon

Windshield Clip

UNIT PACKAGE: 15

**13191**(680-097)
Black Nylon

Moulding Retainer

UNIT PACKAGE: 50

**13230**(Mercedes 000-990-03-92;
Volvo 947-098)
Black NylonPush-Type Retainer
Head Dia. 10mm
Stem Length: 7mm
Fits Into 5mm Hole

UNIT PACKAGE: 50

**19904**(9133417-7)
Black NylonRocker Panel
Push-Type Retainer
Head Diameter: 16mm
Stem Length: 14mm
Fits Into 9mm Hole
850 Series
1994 - On

UNIT PACKAGE: 15

**19248**(1268176-3)
Black NylonBumper Cover
Push-Type Retainer
Head Diameter: 16mm
Stem Length: 14mm
Fits Into 6mm Hole
740 & 760
1993-On

UNIT PACKAGE: 15

**20407**(9133073-8)
Black NylonHood Insulation &
Radiator Seal Push-Type Retainer
Head Size: 8mm x 25mm
Stem Length: 10mm
Fits Into 5mm Hole
850, 940, 960, S80, S90 & V90
1991 - On

UNIT PACKAGE: 25

**19249**(3512624-2)
Black NylonRocker Panel
Push-Type Retainer
Head Diameter: 16mm
Stem Length: 12mm
Fits Into 8mm Hole
1993-On

UNIT PACKAGE: 25

**13220**(Mercedes
000-994-09-45;
Volvo 946-418;
Opel 20-72-175)
Plated"U" Type Nut
6.3mm Screw Size
Panel Range: .7mm-1.5mm
Center of Hole To Edge: 13mm

UNIT PACKAGE: 50

UNIVERSAL EUROPEAN IMPORT FASTENERS**16132**

Black Nylon

Trim Panel Retainer
Head Dia: 19mm
Stem Length: 20mm
Fits Into 8mm Hole

UNIT PACKAGE: 25

**16134**

Zinc & Yellow

Thread Cutting Nut
With Sealer
For 3mm Stud
13.5mm O.D.
8mm Hex

UNIT PACKAGE: 25