

Technical Information

Weld-in adapter, Process adapter and Flanges

Level and pressure measurement



Application

The adapters and the flanges are used to connect level or pressure sensors to a vessel or a pipe.

Your benefits

- High-quality, corrosion resistant materials for use in aggressive media
- Versions without crevices and dead space of the weld-in adapters and the process adapters according to international hygiene regulations
- A variety of seals for application in diverse processes
- Flanges are specified according to both flange standards DIN/EN

Table of contents

General information	3	Preparation	36
Suitable for hygienic processes	3	Welding procedure	37
Weld-in adapter - overview level	5	Install measuring device	37
Weld-in adapter and accessories - level	9	Pressure resistance	38
G ¾", d=29 for pipe-mounting	9	Flange - Overview	39
G ¾", d=50 for vessel-mounting	10	Specifications	39
G ¾", d=55 with flange for flush-mounted installation	11	Versions	39
G 1", d=53 without flange for pipe-mounting	12	Flange Norm DIN EN 1092-1	39
G 1", d=60 with flange for flush-mounted installation	13	Height of raised face	40
G 1" sensor can be positioned	14	Mechanical Construction	41
RD 52 sensor can be positioned	15	DIN flanges (DIN 2527)	41
UNI D85	15	PN10	41
UNI D65	16	PN16	42
M24 D65	16	PN25	42
DRD DN50 for flush-mounted installation of devices	17	PN40	43
Weld-in adapter - overview pressure.	18	PN64	43
Weld-in adapter and accessories - Pressure	21	PN100	44
UNI D85	21	EN flanges (DIN EN 1092-1)	45
UNI D65	22	PN16	45
DRD DN50 for flush-mounted install. of devices with DRD-Flange	23	PN25	45
G 1", d=60 with flange for flush-mounted installation with sealing surface	24	PN40	46
G 1½" flush-mounted	25	PN63	46
G 1" flush-mounted with metallic sealing taper	25	PN100	47
G ½" flush-mounted	25	ASME-Flange (ASME B16.5-2013)	48
M24 D65	26	Class 150	48
Process adapter M24 - overview level and pressure	27	Class 300	49
Process connection M24 - level and pressure.	28	Class 600	49
Varivent F DN32 PN40	28	Class 900	50
Varivent N DN50 PN40	28	Class 1500	50
DIN11851 DN40	29	JIS flanges (B 2220)	51
DIN11851 DN50	29	10 K	51
SMS 1½"	30	20 K	51
Clamp 1½"	30	63 K	52
Clamp 2"	31	Pressure-temperature dependencies	53
APV-Inline	31	EN flanges	53
Process adapter UNI - overview pressure	32	ASME flanges	53
Process adapter UNI - Pressure.	33	JIS flanges	53
Clamp 2"	33	Adapter flange FAU70	54
Varivent N	33	FAU70E Version with metrical thread	54
DIN11851 DN40	34	FAU70A Version with conical thread	54
DIN11851 DN50	34	Slip-on flange FAU80	55
DRD DN50	35	FAU80 Version slip-on flange	55
Welding hints	36	Screw in flange FAX50	56
Weld-in adapter with leakage hole or leakage port	36	FAX50 universal flange DIN-ASME-JIS	56
Notes for pressure measuring devices	36	G ¾", NPT ¾"	56
		G 1", NPT 1"	56
		G 1½", NPT 1½"	57
		G 2", NPT 2"	57
		Order information FAX50	58

General information

Pressure equipment directive PED 2014/68/EU:

The herein listed adapters are not subject to the pressure equipment directive independent of the maximum allowable amount of pressure, because they have no pressurised housing.

NOTICE

Maximum pressure and temperature may be limited by the sensor installed in the adapter.

- ▶ Maximum design pressure and temperature stated is for the adapter only and not for the sensor being installed in the adapter. Consult sensor supplier for sensor pressure-temperature ratings.

Suitable for hygienic processes

3-A und EHEDG



NOTICE

- ▶ Depending of device versions meet the requirements of 3-A sanitary standard no. 74. Endress+Hauser confirms this compliance by affixing the 3-A symbol.
- ▶ For the hygienic design accordingly 3-A, EHEDG and ASME BPE is the use of appropriate fittings for pipings and gaskets should be noted.
- ▶ To avoid the risk of contamination, install the device in accordance with the design principles of EHEDG, Document 37 "Hygienic Design and Application for Sensors" and Document 16 "Hygienic Pipe Connections".
- ▶ Suitable connections and seals must be used in order to guarantee hygiene-compliant design as per 3-A and EHEDG specifications.
- ▶ If installed horizontally, ensure that the leakage hole is pointing downwards. This allows leaks to be detected as quickly as possible, see chapter "Weld-in adapter with leakage hole/leakage port" → 35.
- ▶ The gap-free connections can be cleaned of all residue using sterilization in place (SIP) and cleaning in place (CIP), which are typical cleaning methods within the industry. Attention must be paid to the pressure and temperature specifications of the sensor and process connections for CIP and SIP processes.

Material conformity

Conform materials according to FDA 21 CFR (Code of Federal Regulations)

PART 177 - Indirect Food Additives: Polymers

- Part 177.1550: Perfluorocarbon resins (PTFE)
- Part 177.2600: Rubber articles intended for repeated use (EPDM, Silicone (VMQ), Viton (FKM))

Conform to regulation (EC) No. 1935/2004 on materials and articles intended to come into contact with food (European)

- BfR (Federal Institute for Risk Assessment) Recommendation XV. Commodities based on Silicones: Silicone (VMQ)
- BfR (Federal Institute for Risk Assessment) Recommendation XXI. Commodities based on Natural and Synthetic Rubber: EPDM, Viton (FKM)
- PTFE conform to regulation (EC) No. 10/2011

NOTICE

- ▶ The data concerning suitability for hygienic processes are listed under the relevant device version.

Weld-in adapter - overview level

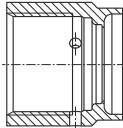
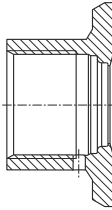
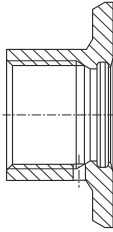
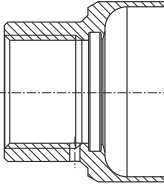
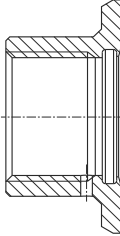
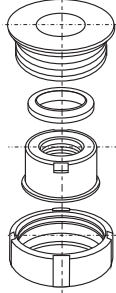
Weld-in adapter	 a0008246	 a0008251	 a0008256	 a0011924	 a0008248	 a0008253
	G ¾", d=29 for pipe- mounting	G ¾", d=50 for vessel- mounting	G ¾", d=55 with flange	G 1", d=53 without flange	G 1", d=60 with flange	G 1" adjustable
Material	316L (1.4435)	316L (1.4435)	316L (1.4435)	316L (1.4435)	316L (1.4435)	316L (1.4435)
Roughness µm (µin) process side	≤ 1.5 (59.1)	≤ 0.8 (31.5)	≤ 0.8 (31.5)	≤ 0.8 (31.5)	≤ 0.8 (31.5)	≤ 0.8 (31.5)
Order number weld-in adapter	71258357	71258355	52001052	71258358	52001051 ¹⁾	52001221 ²⁾
Order number weld-in adapter with inspection certificate ^{3) 4)}	52028295	52018765	52011897	71093129	52011896 ¹⁾	52011898 ²⁾
Order number for seal replacement (5 pieces) ⁵⁾	Silicone O-ring 52021717	Silicone O-ring 52021717	Silicone O-ring 52014473	Silicone O-ring 52014472	Silicone O-ring 52014472	Silicone profile gasket 52014424
Order number welding dummy ⁶⁾	71174959	71174959	71168889	71166879	71166879	71181945
Order number blind plug ⁶⁾	71167850	71167850	71177193	71173810	71173810	71166366
Order number blind plug with inspection certificate ^{4) 6)}	-	-	71190074	71167291	71167291	71196853
Measuring device	Suitable for process connection option⁷⁾					
Liquicap						
FMI51	-	GQJ	-	GWJ	GWJ	-
FMI52	-	-	-	GWJ	GWJ	-
FTI51	-	GQJ	-	GWJ	GWJ	-
FTI52	-	-	-	GWJ	GWJ	-
Liquipoint						
FTW23, FTW33	W5J	W5J	-	WSJ	WSJ	-

- 1) Replace the weld-in adapter with order number 917969-1000.
- 2) Replace the weld-in adapter with order number 215159-0000.
- 3) AD2000: The material 316L (in contact with process) corresponds to AD2000 – W0/W2.
- 4) Inspection certificate EN10204-3.1 material
- 5) One seal is included in scope of delivery.
- 6) TSP modification number. Can be ordered only FTSP, PTSP or NTSP.
- 7) The option can be selected in the Product Configurator via the order feature "Process Connection".

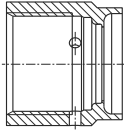
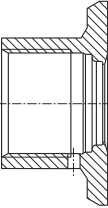
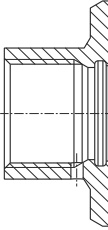
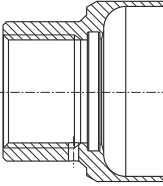
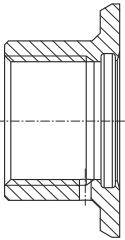
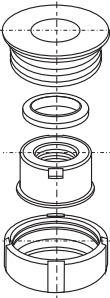

 Product Configurator: www.endress.com

Weld-in adapter						
	G 3/4", d=29 for pipe- mounting	G 3/4", d=50 for vessel- mounting	G 3/4", d=55 with flange	G 1", d=53 without flange	G 1", d=60 with flange	G 1" adjustable
Measuring device	Suitable for process connection option ¹⁾					
Liquiphant						
FTL33, FTL31	W5J	W5J	-	WSJ	WSJ	WSJ
FTL20	1	1	-	7	7	7
FTL20H	GDJ	GDJ	-	GEJ	GEJ	GEJ
FTL260	-	-	-	0	0	-
FTL330x	-	-	-	G	G	G
FTL50, FTL50H	-	-	GQ2	GW2	GW2	GW2
FTL51, FTL51H	-	-	-	GW2	GW2	GW2
FTL80	-	-	WCJ	WSJ	WSJ	WSJ
FTL81	-	-	-	WSJ	WSJ	WSJ
	Adapter as an accessory enclosed option ²⁾					
Liquipoint						
FTW23, FTW33	PC/PD	PA/PB	-	PG/PH	PE/PF	-
Liquiphant						
FTL31, FTL33	PC/PD	PA/PB	-	PG/PH	PE/PF	-

1) The option can be selected in the Product Configurator via the order feature "Process Connection".

2) The option can be selected in the Product Configurator via the order feature "Accessory Enclosed".

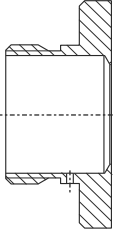
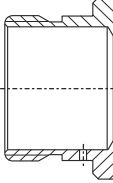
 Product Configurator: www.endress.com

Weld-in adapter					
	a0008252	a0008245	A0017639	a0008552	a0008254
	RD52	UNI D85	UNI D65	M24 D65	DRD DN50 65 mm (2.56 in) (weld-in flange)
Material	316L (1.4435)	316L (1.4435)	316L (1.4435)	316L (1.4435)	316L (1.4435) 304 (1.4301)
Roughness μm (μin) process side	≤ 0.8 (31.5)	≤ 0.76 (29.9)	≤ 0.76 (29.9)	$\leq 0,76$ (29.9)	≤ 0.76 (29.9)
Order number weld-in adapter	52001047 ¹⁾	52006262	214880-0002	71041381	52002041/ 916743-0000
Order number weld-in adapter with inspection certificate ²⁾	52006909 ¹⁾	52010173	52010174	71041383	52011899/ -
Order number for seal replacement (5 pieces) ³⁾	Silicone profile gasket 52014424	Silicone profile gasket 52023572	Silicone profile gasket 52023572	EPDM O-ring 52024267	PTFE flat seal 52024228
Order number welding dummy	71181945 ⁴⁾	71114210	71114210	-	71114209
Order number blind plug ⁴⁾	71114210	71181340	71181340	71171418	71181450
Slotted nut	52021715	52021715	52021715	-	-
Measuring device	Suitable for process connection option⁵⁾				
Liquicap					
FMI5x	-	UPJ	UPJ	-	-
FTI5x	-	UPJ	UPJ	-	-
Liquipoint					
FTW23, FTW33	-	-	-	X2J	-
Liquiphant					
FTL33	5ZJ	-	-	X2J	-
FTL20H	UPJ	-	-	-	-
FTL330x	F	-	-	-	-
FTL5xH	EE2	-	-	-	PE2

1) Replace the weld-in adapter with order number 942329-0001.

2) Inspection certificate EN10204-3.1 material; AD2000: The material 316L (in contact with process) corresponds to AD2000 - W0/W2.



3) One seal is included in scope of delivery.

4) TSP modification number. Can be ordered only FTSP, PTSP or NTSP.

5) The option can be selected in the Product Configurator via the order feature "Process Connection".

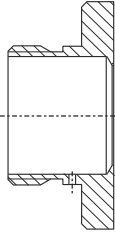
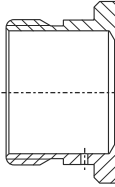

Product Configurator: www.endress.com

Weld-in adapter					
	a0008252	a0008245	A0017639	a0008552	a0008254
	RD52	UNI D85	UNI D65	M24 D65	DRD DN50 65 mm (2.56 in) (weld-in flange)
Measuring device	Suitable for process connection option ¹⁾				
Levelflex					
FMP41C	-	UPK/UQK	UPK/UQK	-	-
FMP43	-	-	-	U1J	-
FMP53	-	-	-	U1J	-
	Adapter as an accessory enclosed option ²⁾				
Liquipoint					
FTW23, FTW33	-	-	-	PM/PN	-
Liquiphant					
FTL33	PO/PQ	-	-	PM/PN	-



1) The option can be selected in the Product Configurator via the order feature "Process Connection".

2) The option can be selected in the Product Configurator via the order feature "Accessory Enclosed".

 Product Configurator: www.endress.com

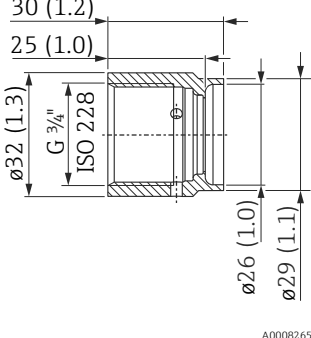

Weld-in adapter and accessories - level

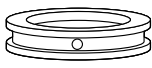
G 3/4", d=29 for pipe-mounting

Dimensions mm (in)	Version	Order number
 <p style="text-align: center;">A0008265</p> <p>Pressure and temperature range of the adapter</p> <ul style="list-style-type: none"> ▪ max. 25 bar (362 psi) / max. 150 °C (302 °F) ▪ max. 40 bar (580 psi) / max. 100 °C (212 °F) 	<ul style="list-style-type: none"> ▪ Without inspection certificate ▪ With inspection certificate EN10204-3.1 material <p>Material: AISI 316L (1.4435) Roughness (process side): Ra ≤ 1.5 μm (59.1 μin)</p>	71258357 52028295
	<p>Silicone O-ring, ø 14.9 x 2.7 mm (0.59 x 0.11 in) Material: VMQ 75 Conform according to FDA, 3-A</p> <ul style="list-style-type: none"> ▪ For this version a simple replacement of the seal is possible. 	52021717 (5 pieces)
	<p>Welding dummy for welding the weld-in adapter Material: Brass</p>	71174959 ¹⁾
	<p>Blind plug for closing weld-in adapter Material: AISI 316L (1.4435) Roughness (process side): Ra ≤ 3.2 μm (126 μin)</p>	71167850 ¹⁾
	<p>Approved by EHEDG</p>	
Alternative seals and pressure ring		Order number
 <p style="text-align: center;">A0021901</p>	<p>ø 15.08 x 2.62 mm (0.59 x 0.10 in) Material: EPDM Conform according to FDA Approved by EHEDG</p>	71167872 ¹⁾ (5 pieces)
	<p>ø 15.08 x 2.62 mm (0.59 x 0.10 in) Material: FKM Conform according to FDA Approved by EHEDG</p>	71167890 ¹⁾ (5 pieces)
	<p>ø14.9 x 2.7mm (0.59 x 0.11 in) Material: Silicone VMQ 80 Conform according to FDA, USP Class VI, 3-A</p>	71086117 (3 pieces)
 <p style="text-align: center;">A0021902</p>	<p>Pressure ring Material: 316L (1.4435)</p> <ul style="list-style-type: none"> ▪ The seal with pressure ring enables easy exchange of defective sealing rings. 	52027421

1) TSP modification number. Can be ordered only FTSP, PTSP or NTSP.

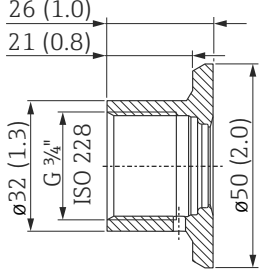
G 3/4", d=50 for vessel-mounting

Dimensions mm (in)	Version	Order number
 <p data-bbox="517 645 815 696">Pressure and temperature range of the adapter of the adapter</p> <ul data-bbox="517 696 756 831" style="list-style-type: none"> max. 25 bar (362 psi) / max. 150 °C (302 °F) max. 40 bar (580 psi) / max. 100 °C (212 °F) 	<ul style="list-style-type: none"> Without inspection certificate With inspection certificate EN10204-3.1 material <p>Material: AISI 316L (1.4435) Roughness (process side): Ra ≤ 0.8 μm (31.5 μin)</p>	<p>71258355 52018765</p>
	<p>Silicone O-ring, ø 14.9 x 2.7 mm (0.59 x 0.11 in) Material: VMQ 75 Conform according to FDA, 3-A</p> <ul style="list-style-type: none"> For this version a simple replacement of the seal is possible. 	<p>52021717 (5 pieces)</p>
	<p>Welding dummy for welding the weld-in adapter Material: Brass</p>	<p>71174959¹⁾</p>
	<p>Blind plug for closing weld-in adapter Material: AISI 316L (1.4435) Roughness (process side): Ra ≤ 3.2 μm (126 μin)</p>	<p>71167850¹⁾</p>
	<p>Approved by EHEDG</p>	
Alternative seals and pressure ring		Order number
	<p>ø 15.08 x 2.62 mm (0.59 x 0.10 in) Material: EPDM Conform according to FDA Approved by EHEDG</p>	<p>71167872 ¹⁾ (5 pieces)</p>
	<p>ø 15.08 x 2.62 mm (0.59 x 0.10 in) Material: FKM Conform according to FDA Approved by EHEDG</p>	<p>71167890 ¹⁾ (5 pieces)</p>
	<p>ø 14.9 x 2.7 mm (0.59 x 0.11 in) Material: Silicone VMQ 80 Conform according to FDA, USP Class VI, 3-A</p>	<p>71086117 (3 pieces)</p>
	<p>Pressure ring Material: 316L (1.4435)</p> <ul style="list-style-type: none"> The seal with pressure ring enables easy exchange of defective sealing rings. 	<p>52027421</p>

1) TSP modification number. Can be ordered only FTSP, PTSP or NTSP.

G 3/4", d=55 with flange for flush-mounted installation

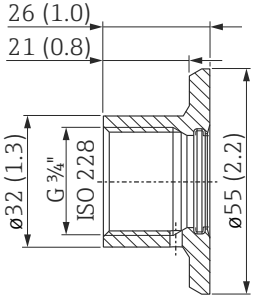
Dimensions mm (in)	Version	Order number
 <p style="text-align: center; font-size: small;">A0008274</p>	<ul style="list-style-type: none"> ■ Without inspection certificate ■ With inspection certificate EN10204-3.1 material <p>Material: AISI 316L (1.4435) Roughness (process side): Ra ≤ 0.8 μm (31.5 μin)</p>	<p>52001052 52011897</p>
<p>Pressure and temperature range of the adapter</p> <ul style="list-style-type: none"> ■ max. 25 bar (362 psi) / max. 150 °C (302 °F) ■ max. 40 bar (580 psi) / max. 100 °C (212 °F) 	<p>Silicone O-ring, ø 21.89 x 2.62 mm (0.86 x 0.10 in) Material: VMQ 70 Conform according to FDA, 3-A</p>	<p>52014473 (5 pieces)</p>
	<p>Welding dummy for welding the weld-in adapter Material: Brass</p>	<p>71168889¹⁾</p>
	<p>Blind plug for closing weld-in adapter</p> <ul style="list-style-type: none"> ■ Without inspection certificate ■ With inspection certificate EN10204-3.1 material <p>Material: AISI 316L (1.4435) Roughness (process side): Ra ≤ 0.76 μm (29.9 μin)</p>	<p>71177193¹⁾ 71190074¹⁾</p>
Approved by EHEDG		
	<p>Alternative seals ø 21.89 x 2.62 mm (0.86 x 0.10 in)</p>	<p>Order number</p>
	<p>Material: EPDM-70 Conform according to FDA, USP Class VI, 3-A</p>	<p>71140670 (3 pieces)</p>
	<p>Material: Kalrez Comp. 2035</p>	<p>71167883¹⁾</p>
	<p>Material: FKM</p>	<p>71172153¹⁾ (5er Set)</p>
	<p>Material: FKM/FEP-FEK 75 Shore</p>	<p>71167747¹⁾</p>
	<p>Material: Silicone VMQ 23-70 Conform according to FDA, USP Class VI</p>	<p>71086100 (3 pieces)</p>

1) TSP modification number. Can be ordered only FTSP, PTSP or NTSP.

G 1", d=53 without flange for pipe-mounting

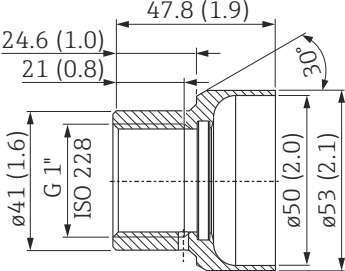
Dimensions mm (in)	Version	Order number	
 <p data-bbox="512 645 839 696">Pressure and temperature range of the adapter</p> <ul data-bbox="512 696 756 831" style="list-style-type: none"> max. 25 bar (362 psi) / max. 150 °C (302 °F) max. 40 bar (580 psi) / max. 100 °C (212 °F) 	<ul style="list-style-type: none"> Without inspection certificate With inspection certificate EN10204-3.1 material <p>Material: AISI 316L (1.4435) Roughness (process side): Ra ≤ 0.8 µm (31.5 µin)</p>	<p>71258358 71093129</p>	
	<p>Silicone O-ring, ø 28.17 x 3.53 mm (1.11 x 0.14 in) Material: VMQ 70 Conform according to FDA, 3-A</p>	<p>52014472 (5 pieces)</p>	
	<p>Welding dummy for welding the weld-in adapter Material: Brass</p>	<p>71166879¹⁾</p>	
	<p>Blind plug for closing weld-in adapter</p> <ul style="list-style-type: none"> Without inspection certificate With inspection certificate EN10204-3.1 material <p>Material: AISI 316L (1.4435) Roughness (process side): Ra ≤ 0.76 µm (29.9 µin)</p>	<p>71173810¹⁾ 71167291¹⁾</p>	
	<p>Approved by EHEDG</p>		
	<p>Alternative seals ø 28.17 x 3.53 mm (1.11 x 0.14 in)</p>		<p>Order number</p>
	<p>Material: EPDM-70 Conform according to FDA, USP Class VI, 3-A</p>	<p>71140668 (3 pieces)</p>	
	<p>Material: FKM665 Conform according to FDA</p>	<p>71182264¹⁾ (5 pieces)</p>	
	<p>Material: FKM Conform according to FDA, USP Class VI, 3-A</p>	<p>71166227¹⁾</p>	
	<p>Material: Kalrez comp. 4079</p>	<p>71166292¹⁾</p>	
<p>Material: Silicone VMQ 3-70 Conform according to FDA, USP Class VI</p>	<p>71086102 (3 pieces)</p>		

1) TSP modification number. Can be ordered only FTSP, PTSP or NTSP.

G 1", d=60 with flange for flush-mounted installation with sealing surface

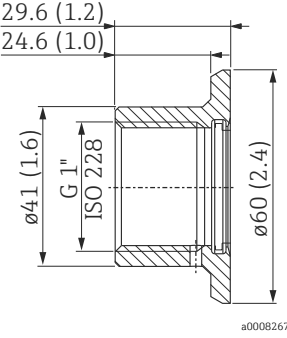
Dimensions mm (in)	Version	Order number
 <p>29.6 (1.2) 24.6 (1.0)</p> <p>Ø41 (1.6) G 1" ISO 228</p> <p>Ø60 (2.4)</p> <p>a0008267</p>	<ul style="list-style-type: none"> ▪ Without inspection certificate ▪ With inspection certificate EN10204-3.1 material <p>Material: AISI 316L (1.4435) Roughness (process side): Ra ≤ 0.8 µm (31.5 µin)</p>	<p>52001051 52011896</p>
<p>Pressure and temperature range of the adapter</p> <ul style="list-style-type: none"> ▪ max. 25 bar (362 psi) / max. 150 °C (302 °F) ▪ max. 40 bar (580 psi) / max. 100 °C (212 °F) 	<p>Silicone O-ring, Ø 28.17 x 3.53 mm (1.11 x 0.14 in) Material: VMQ 70 Conform according to FDA, 3-A</p>	<p>52014472 (5 pieces)</p>
	<p>Welding dummy for welding the weld-in adapter Material: Brass</p>	<p>71166879¹⁾</p>
	<p>Blind plug for closing weld-in adapter</p> <ul style="list-style-type: none"> ▪ Without inspection certificate ▪ With inspection certificate EN10204-3.1 material <p>Material: AISI 316L (1.4435) Roughness (process side): Ra ≤ 0.76 µm (29.9 µin)</p>	<p>71173810¹⁾ 71167291¹⁾</p>
	<p>Approved by EHEDG</p>	
	<p>Alternative seals Ø 28.17 x 3.53 mm (1.11 x 0.14 in)</p>	<p>Order number</p>
	<p>Material: EPDM-70 Conform according to FDA, USP Class VI, 3-A</p>	<p>71140668 (3 pieces)</p>
	<p>Material: FKM665 Conform according to FDA</p>	<p>71182264¹⁾ (5 pieces)</p>
	<p>Material: FKM Conform according to FDA, USP Class VI, 3-A</p>	<p>71166227¹⁾</p>
	<p>Material: Kalrez comp. 4079</p>	<p>71166292¹⁾</p>
	<p>Material: Silicone VMQ 3-70 Conform according to FDA, USP Class VI</p>	<p>71086102 (3 pieces)</p>

1) TSP modification number. Can be ordered only FTSP, PTSP or NTSP.

G 1" sensor can be positioned

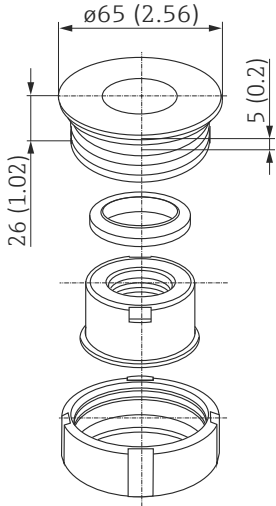
Dimensions mm (in)	Version	Order number
 <p data-bbox="767 824 820 837">a0008272</p> <p data-bbox="517 862 815 913">Pressure and temperature range of the adapter</p> <ul data-bbox="517 913 756 1021" style="list-style-type: none"> ■ max. 25 bar (362 psi) / max. 150 °C (302 °F) ■ max. 40 bar (580 psi) / max. 100 °C (212 °F) 	<ul style="list-style-type: none"> ■ Without inspection certificate ■ With inspection certificate EN10204-3.1 material <p>Material: AISI 316L (1.4435) Roughness (process side): Ra ≤ 0.8 μm (31.5 μin)</p>	<p>52001221 52011898</p>
	<p>Silicone profile gasket, ø 29 x 36 x 3.7 mm (1.14 x 1.42 x 0.15 in) Material: SI-60 Conform according to FDA</p>	<p>52014424 (5 pieces)</p>
	<p>Welding dummy for welding the weld-in adapter Material: Brass</p>	<p>71181945¹⁾</p>
	<p>Blind plug for closing weld-in adapter Material: AISI 316L (1.4435) Roughness (process side): Ra ≤ 0.76 μm (29.9 μin)</p>	<p>71166366¹⁾</p>
	<p>Approved by EHEDG</p>	
	<p>Alternative seals ø 29 x 36 x 3.7 mm (1.14 x 1.42 x 0.15 in)</p>	<p>Order number</p>
<p>Material: EPDM-60 Conform according to FDA, 3-A</p>	<p>52012805</p>	
<p>Material: Silicone VMQ 60 Conform according to FDA, USP Class VI</p>	<p>71075662 (5 pieces)</p>	

1) TSP modification number. Can be ordered only FTSP, PTSP or NTSP.

RD 52 sensor can be positioned

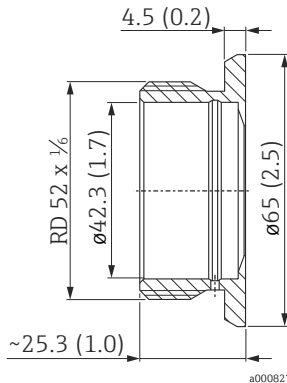
Dimensions mm (in)	Version	Order number
 <p>Pressure and temperature range of the adapter</p> <ul style="list-style-type: none"> max. 25 bar (362 psi) / max. 150 °C (302 °F) max. 40 bar (580 psi) / max. 100 °C (212 °F) 	<ul style="list-style-type: none"> Without inspection certificate With inspection certificate EN10204-3.1 material Material: AISI 316L (1.4435) Roughness (process side): Ra ≤ 0.8 µm (31.5 µin)	52001047 52006909
	Silicone profile gasket, ø 29 x 36 x 3.7 mm (1.14 x 1.42 x 0.15 in) Material: SI-60; Conform according to FDA <ul style="list-style-type: none"> For this version a simple replacement of the seal is possible. 	52014424 (5 pieces)
	Welding dummy for welding the weld-in adapter Material: Brass	71181945 ¹⁾
	Blind plug for closing weld-in adapter Material: AISI 316L (1.4435) Roughness (process side): Ra ≤ 0.76 µm (29.9 µin)	71166366 ¹⁾
	Alternative seals ø 29 x 36 x 3.7 mm (1.14 x 1.42 x 0.15 in)	Order number
	Material: EPDM-60 Conform according to FDA	52012805
	Material: Silicone VMQ 60 Conform according to FDA, USP Class VI, 3-A	71075662 (5 pieces)

1) TSP modification number. Can be ordered only FTSP, PTSP or NTSP.

UNI D85

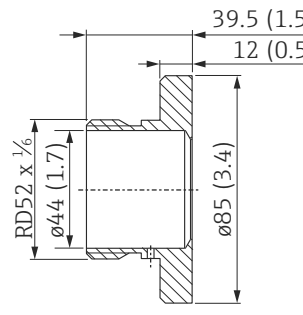
Dimensions mm (in)	Version	Order number
 <p>Pressure and temperature range of the adapter</p> <ul style="list-style-type: none"> max. 16 bar (232 psi) / max. 150 °C (302 °F) 	<ul style="list-style-type: none"> Without inspection certificate With inspection certificate EN10204-3.1 material Material: AISI 316L (1.4435) Roughness (process side): Ra ≤ 0.76 µm (29.9 µin)	52006262 52010173
	Silicone profile gasket, ø 34 x 41.5 x 6.4 mm (1.34 x 1.63 x 0.25 in) Material: SI-60 Conform according to FDA, USP Class VI, 3-A	52023572 (5 pieces)
	Welding dummy for welding the weld-in adapter Material: Brass	71114210
	Blind plug for closing weld-in adapter Material: AISI 316L (1.4435) Roughness (process side): Ra ≤ 0.76 µm (29.9 µin)	71181340 ¹⁾
	Approved by EHEDG	
	Alternative seal ø 34 x 41.5 x 6.4 mm (1.34 x 1.63 x 0.25 in)	Order number
	Profile gasket Material: EPDM-70 Conform according to FDA, USP Class VI, 3-A	71100719 (5 pieces)

1) TSP modification number. Can be ordered only FTSP, PTSP or NTSP.

UNI D65

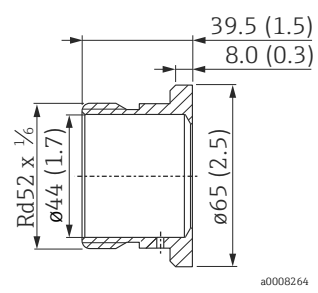
Dimensions mm (in)	Version	Order number
 <p>Pressure and temperature range of the adapter</p> <ul style="list-style-type: none"> max. 16 bar (232 psi) / max. 150 °C (302 °F) 	<ul style="list-style-type: none"> Without inspection certificate With inspection certificate EN10204-3.1 material Material: AISI 316L (1.4435) Roughness (process side): Ra ≤ 0.76 µm (29.9 µin)	214880-0002 52010174
	Silicone profile gasket ø 34 x 41.5 x 6.4 mm (1.34 x 1.63 x 0.25 in) Material: SI-60 Conform according to FDA, USP Class VI, 3-A	52023572 (5 pieces)
	Welding dummy for welding the weld-in adapter Material: Brass	71114210
	Blind plug for closing weld-in adapter Material: AISI 316L (1.4435) Roughness (process side): Ra ≤ 0.76 µm (29.9 µin)	71181340 ¹⁾
	Approved by EHEDG	
	Alternative seal ø 34 x 41.5 x 6.4 mm (1.34 x 1.63 x 0.25 in)	Order number
Profile gasket Material: EPDM-70 Conform according to FDA, USP Class VI, 3-A	71100719 (5 pieces)	

1) TSP modification number. Can be ordered only FTSP, PTSP or NTSP.

M24 D65

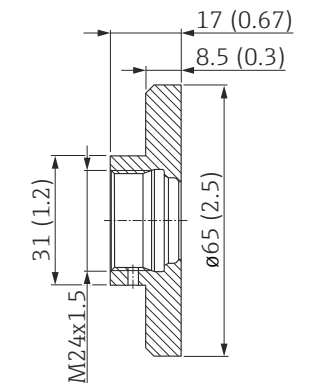
Dimensions (mm)	Version	Order number
 <p>Pressure and temperature range of the adapter</p> <ul style="list-style-type: none"> max. 25 bar (362 psi) / max. 150 °C (302 °F) 	<ul style="list-style-type: none"> Without inspection certificate With inspection certificate EN10204-3.1 material Material: AISI 316L (1.4435) Roughness (process side): Ra ≤ 0.76 µm (29.9 µin)	71041381 71041383
	O-ring, ø 15.54 x 2,62 mm (0.61 x 0.1 in) Material: EPDM Conform according to USP Class VI, 3-A	52024267 (5 pieces)
	Blind plug for closing weld-in adapter Material: AISI 316L (1.4435) Roughness (process side): Ra ≤ 0.76 µm (29.9 µin)	71171418 ¹⁾



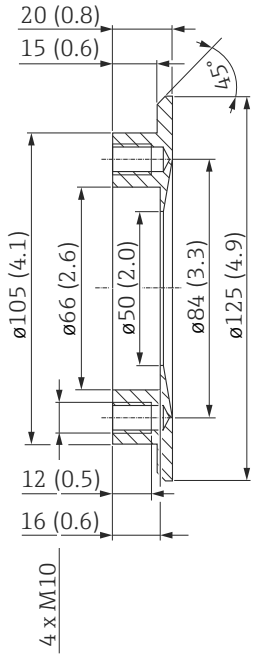

1) TSP modification number. Can be ordered only FTSP, PTSP or NTSP.

**DRD DN50 (65 mm (2.56 in))
for flush-mounted
installation of devices with
DRD-flange**

Dimensions mm (in)	Version	Order number
 <p>a0008263</p> <p>Pressure and temperature range of the adapter</p> <ul style="list-style-type: none"> max. 25 bar (362 psi) / max. 150 °C (302 °F) max. 40 bar (580 psi) / max. 100 °C (212 °F) 	<ul style="list-style-type: none"> Without inspection certificate With inspection certificate EN10204-3.1 material <p>Material: AISI 316L (1.4435) Roughness (process side): Ra ≤ 0.76 µm (29.9 µin)</p>	<p>52002041 52011899</p>
	<p>Material: AISI 304 (1.4301) Roughness (process side): Ra ≤ 0.8 µm (31.5 µin)</p>	<p>916743-0000</p>
	<p>Flat seal, ø 50 x 65 x 1 mm (1.97 x 2.56 x 0.04 in) Material: PTFE Conform according to FDA</p>	<p>52024228 (5 pieces)</p>
	<p>Welding dummy for welding the weld-in adapter Material: Brass</p>	<p>71114209</p>
	<p>Blind plug for closing weld-in adapter Material: AISI 316L (1.4435) Roughness (process side): Ra ≤ 0.76 µm (29.9 µin)</p>	<p>71181450¹⁾</p>

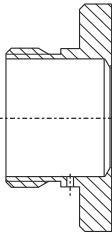
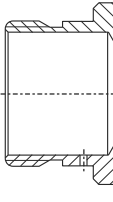
1) TSP modification number. Can be ordered only FTSP, PTSP or NTSP.

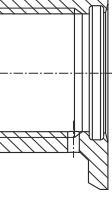
Weld-in adapter - overview pressure

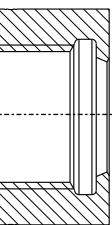
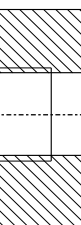
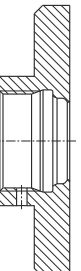
Weld-in adapter								
	a0008245	A0017639	a0008254	a0008248	a0008247	a0008249	a0008250	a0008552
	UNI D85	UNI D65	DRD DN50 65 mm (2.56 in) (weld-in flange)	G 1" d=60 with flange	G 1 ½" flush- mounted	G 1" flush- mounted (sealing taper)	G ½" flush- mounted	M24 D65
Material	316L (1.4435)	316L (1.4435)	316L (1.4435) 304 (1.4301)	316L (1.4435)	316L (1.4435)	316L (1.4404)	316L (1.4435)	316L (1.4435)
Roughness µm (µin) process side	≤ 0.76 (29.9)	≤ 0.76 (29.9)	≤ 0.76 (29.9)	≤ 0.8 (31.5)	≤ 0.8 (31.5)	≤ 0.8 (31.5)	≤ 0.8 (31.5)	≤ 0,76 (29.9)
Order number weld-in adapter	52006262	214880- 0002	52002041 /916743- 0000	52001051	52024469	52005087	52002643	71041381
Order number weld-in adapter with inspection certificate ^{1) 2)}	52010173	52010174	52011899 / -	52011896	52024470	52010171	52010172	71041383
Order number for seal replacement (5 pieces) ³⁾	Silicone profile gasket 52023572	Silicone profile gasket 52023572	PTFE flat seal 52024228	Silicone O-ring 52014472	-	-	-	EPDM O-Ring 52024267
Order number Welding dummy	71114210	71114210	71114209	71166879 ⁴⁾	52024471	52005272	52005082	-
Order number blind plug ⁴⁾	71181340	71181340	71181450	71173810	-	71171731	-	71171418
Order number blind plug with inspection certificate ^{2) 4)}	-	-	-	71167291	-	-	-	-
Measuring device	Suitable for process connection							
Cerabar	option ⁵⁾							
PMP135	-	-	-	N	-	M	-	-
PMP21	-	-	-	-	-	-	WUJ	-
PMP23	52J	52J	-	WSJ	-	WQJ	-	X2J/X3J







1) AD2000: The material 316L (in contact with process) corresponds to AD2000 – W0/W2.

2) Inspection certificate EN10204-3.1 material

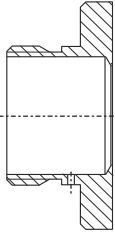
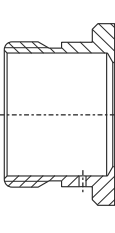
3) One seal is included in scope of delivery.

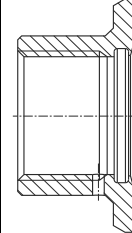
4) TSP modification number. Can be ordered only FTSP, PTSP or NTSP.

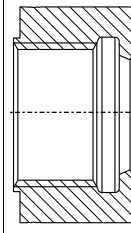
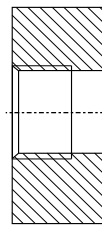





5) The option can be selected in the Product Configurator via the order feature "Process Connection".

Weld-in adapter								
	a0008245	A0017639	a0008254	a0008248	a0008247	a0008249	a0008250	a0008552
	UNI D85	UNI D65	DRD DN50 65 mm (2.56 in) (weld-in flange)	G 1" d=60 with flange	G 1½" flush- mounted	G 1" flush- mounted (sealing taper)	G ½" flush- mounted	M24 D65
Measuring device	Suitable for process connection option ¹⁾							
Ceraphant								
PTP31	-	-	-	-	-	-	AG	
PTP35	-	-	-	BB	-	BA	-	
PTP31B	-	-	-	-	-	-	WUJ	-
PTP33B	-	-	-	WSJ	-	WQJ	-	X2J/X3J
Cerabar M								
PMC51	UNJ/UPJ	UNJ/UPJ	TIJ	-	GVJ	-	-	-
PMP51	-	-	TIJ	GZJ	GVJ	GXJ	GOJ	-
PMP55	UPJ	UPJ	TIJ	-	GVJ	-	-	-
Cerabar S								
PMC71	-	-	TK	-	1G/1H/1J	-	-	-
PMP71	-	-	-	-	1G/1H	-	-	-
PMP75	00	00	TK	-	1G/1H	-	-	-
Deltapilot M								
FMB50	UNJ/UPJ	UNJ/UPJ	TIJ	-	GGJ/GGC	-	-	-
FMB51	-	-	-	-	GGJ/GGC	-	-	-
FMB52	-	-	-	-	GGJ/GGC	-	-	-
Deltapilot S								
FMB70	00/01	00/01	TK	-	1G/1H	-	-	-
Deltabar S								
FMD78	00/UT	00/UT	TK	-	-	-	-	-
Deltabar								
FMD71	UNJ/UPJ	UNJ/UPJ	TIJ	-	GVJ	-	-	-
FMD72	-	-	TIJ	-	GVJ	-	-	-

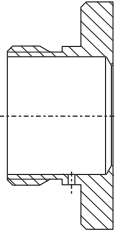
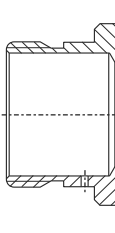
1) The option can be selected in the Product Configurator via the order feature "Process Connection".

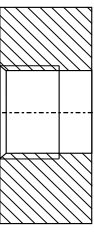

Product Configurator: www.endress.com

Weld-in adapter								
	a0008245	A0017639	a0008254	a0008248	a0008247	a0008249	a0008250	a0008552
	UNI D85	UNI D65	DRD DN50 65 mm (2.56 in) (weld-in flange)	G 1" d=60 with flange	G 1½" flush- mounted	G 1" flush- mounted (sealing taper)	G ½" flush- mounted	M24 D65
Measuring device	Adapter as an accessory enclosed option ¹⁾							
Ceraphant								
PTP31B	-	-	-	-	-	-	QA/QB	-
PTP33B	-	-	-	QJ/QK	-	QE/QF	-	PM/PN
Cerabar								
PMP21	-	-	-	-	-	-	QA/QB	-
PMP23	QP/QR	QL/QM	-	QJ/QK	-	QE/QF	-	PM/PN
PMC51	Q2/Q3	QT/QU	QP/QR	-	QJ/QK	-	-	-
PMP51	-	-	QP/QR	-	QJ/QK	QE/QF	QA/QB	-
PMP55	-	-	QP/QR	-	QJ/QK	-	-	-
Deltapilot M								
FMB50	Q2/Q3	QT/QU	QP/QR	-	QJ/QK	-	-	-
FMB51	-	-	-	-	QJ/QK	-	-	-
FMB52	-	-	-	-	QJ/QK	-	-	-

1) The option can be selected in the Product Configurator via the order feature "Accessory Enclosed".



Product Configurator: www.endress.com

Weld-in adapter and accessories - Pressure

UNI D85

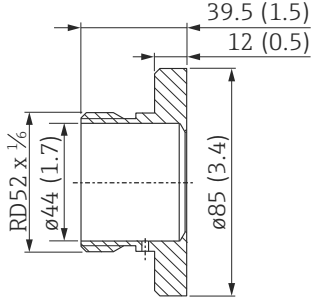
Dimensions mm (in)	Version	Order number	
 <p>Pressure and temperature range of the adapter</p> <ul style="list-style-type: none"> max. 16 bar (232 psi) / max. 150 °C (302 °F) 	<ul style="list-style-type: none"> Without inspection certificate With inspection certificate EN10204-3.1 material <p>Material: AISI 316L (1.4435) Roughness (process side): Ra ≤ 0.76 μm (29.9 μin)</p>	52006262 52010173	
	<p>Silicone profile gasket, ø 34 x 41.5 x 6.4 mm (1.34 x 1.63 x 0.25 in) Material: SI-60 Conform according to FDA, USP Class VI, 3-A</p>	52023572 (5 pieces)	
	<p>Pressure welding dummy for welding the weld-in adapter Material: Brass</p>	71114210	
	<p>Blind plug for closing weld-in adapter Material: AISI 316L (1.4435) Roughness (process side): Ra ≤ 0.76 μm (29.9 μin)</p>	71181340 ¹⁾	
	Approved by EHEDG		
	<p>Alternative seals ø 34 x 41.5 x 6.4 mm (1.34 x 1.63 x 0.25 in)</p>		Order number
	<p>Profile gasket Material: EPDM-70 Conform according to FDA, USP Class VI, 3-A</p>		71100719 (5 pieces)

1) TSP modification number. Can be ordered only FTSP, PTSP or NTSP.

UNI D65

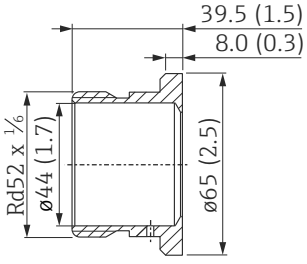
Dimensions mm (in)	Version	Order number	
 <p data-bbox="778 600 831 616">a0008264</p> <p data-bbox="517 640 815 689">Pressure and temperature range of the adapter</p> <ul data-bbox="517 692 756 745" style="list-style-type: none"> max. 16 bar (232 psi) / max. 150 °C (302 °F) 	<ul style="list-style-type: none"> Without inspection certificate With inspection certificate EN10204-3.1 material <p>Material: AISI 316L (1.4435) Roughness (process side): Ra ≤ 0.76 µm (29.9 µin)</p>	<p>214880-0002 52010174</p>	
	<p>Silicone profile gasket, ø 34 x 41.5 x 6.4 mm (1.34 x 1.63 x 0.25 in) Material: SI-60 Conform according to FDA, USP Class VI, 3-A</p>	<p>52023572 (5 pieces)</p>	
	<p>Pressure welding dummy for welding the weld-in adapter Material: Brass</p>	<p>71114210</p>	
	<p>Blind plug for closing weld-in adapter Material: AISI 316L (1.4435) Roughness (process side): Ra ≤ 0.76 µm (29.9 µin)</p>	<p>71181340¹⁾</p>	
	<p>Approved by EHEDG</p>		
	<p>Alternative seal ø 34 x 41.5 x 6.4 mm (1.34 x 1.63 x 0.25 in)</p>		<p>Order number</p>
	<p>Profile gasket Material: EPDM-70 Conform according to FDA, USP Class VI, 3-A</p>		<p>71100719 (5 pieces)</p>

1) TSP modification number. Can be ordered only FTSP, PTSP or NTSP.

**DRD DN50 (65 mm (2.56 in))
for flush-mounted
installation of devices with
DRD-Flange**

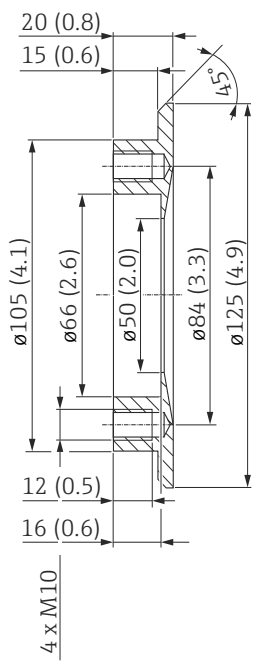
Dimensions mm (in)	Version	Order number
 <p>a0008263</p> <p>Pressure and temperature range of the adapter</p> <ul style="list-style-type: none"> ■ max. 25 bar (362 psi) / max. 150 °C (302 °F) ■ max. 40 bar (580 psi) / max. 100 °C (212 °F) 	<ul style="list-style-type: none"> ■ Without inspection certificate ■ With inspection certificate EN10204-3.1 material <p>Material: AISI 316L (1.4435) Roughness (process side): Ra ≤ 0.76 µm (29.9 µin)</p>	<p>52002041 52011899</p>
	<p>Material: AISI 304 (1.4301) Roughness (process side): Ra ≤ 0.8 µm (31.5 µin)</p>	<p>916743-0000</p>
	<p>Flat seal, ø 50 x 65 x 1 mm (1.97 x 2.56 x 0.04 in) Material: PTFE Conform according to FDA</p>	<p>52024228 (5 pieces)</p>
	<p>Pressure welding dummy for welding the weld-in adapter Material: Brass</p>	<p>71114209</p>
	<p>Blind plug for closing weld-in adapter Material: AISI 316L (1.4435) Roughness (process side): Ra ≤ 0.76 µm (29.9 µin)</p>	<p>71181450¹⁾</p>

1) TSP modification number. Can be ordered only FTSP, PTSP or NTSP.

G 1", d=60 with flange for flush-mounted installation with sealing surface

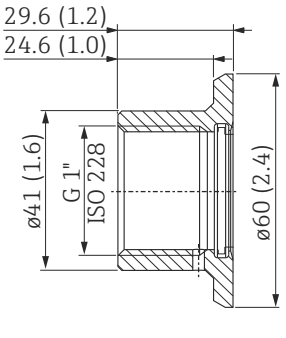
Dimensions mm (in)	Version	Order number	
 <p>Pressure and temperature range of the adapter</p> <ul style="list-style-type: none"> max. 25 bar (362 psi) / max. 150 °C (302 °F) max. 40 bar (580 psi) / max. 100 °C (212 °F) 	<ul style="list-style-type: none"> Without inspection certificate With inspection certificate EN10204-3.1 material <p>Material: AISI 316L (1.4435) Roughness (process side): Ra ≤ 0.8 μm (31.5 μin)</p>	<p>52001051 52011896</p>	
	<p>Silicone O-ring, ø 28.17 x 3.53 mm (1.11 x 0.14 in) Material: VMQ 70 Conform according to FDA, 3-A</p>	<p>52014472 (5 pieces)</p>	
	<p>Pressure welding dummy for welding the weld-in adapter Material: Brass</p>	<p>71166879¹⁾</p>	
	<p>Blind plug for closing weld-in adapter</p> <ul style="list-style-type: none"> Without inspection certificate With inspection certificate EN10204-3.1 material <p>Material: AISI 316L (1.4435) Roughness (process side): Ra ≤ 0.76 μm (29.9 μin)</p>	<p>71173810¹⁾ 71167291¹⁾</p>	
	<p>Approved by EHEDG</p>		
	<p>Alternative seals ø 28.17 x 3.53 mm (1.11 x 0.14 in)</p>		<p>Order number</p>
	<p>Material: EPDM-70 Conform according to FDA, USP Class VI, 3-A</p>		<p>71140668 (3 pieces)</p>
<p>Material: FKM665 Conform according to FDA</p>		<p>71182264¹⁾ (5 pieces)</p>	
<p>Material: FKM Conform according to FDA, USP Class VI, 3-A</p>		<p>71166227¹⁾</p>	
<p>Material: Kalrez comp. 4079</p>		<p>71166292¹⁾</p>	
<p>Material: Silicone VMQ 3-70 Conform according to FDA, USP Class VI</p>		<p>71086102 (3 pieces)</p>	

1) TSP modification number. Can be ordered only FTSP, PTSP or NTSP.

G 1½" flush-mounted

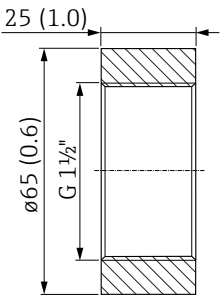
Dimensions mm (in)	Version	Order number
	<ul style="list-style-type: none"> Without inspection certificate With inspection certificate EN10204-3.1 material Material: AISI 316L (1.4435) Roughness (process side): Ra ≤ 0.8 μm (31.5 μin)	52024469 52024470
	Pressure welding dummy for welding the weld-in adapter Material: Brass	52024471

G 1" flush-mounted with metallic sealing taper

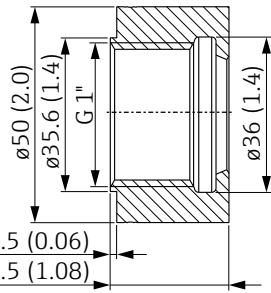
Dimensions mm (in)	Version	Order number
	<ul style="list-style-type: none"> Without inspection certificate With inspection certificate EN10204-3.1 material Material: AISI 316L (1.4435) Roughness (process side): Ra ≤ 0.8 μm (31.5 μin)	52005087 52010171
	Pressure welding dummy for welding the weld-in adapter Material: Brass	52005272
	Blind plug for closing weld-in adapter Material: AISI 316L (1.4435) Roughness (process side): Ra ≤ 0.76 μm (29.9 μin)	71171731 ¹⁾

1) TSP modification number. Can be ordered only FTSP, PTSP or NTSP.

G ½" flush-mounted

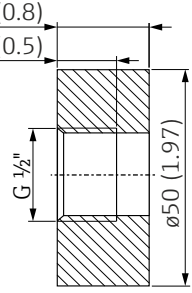



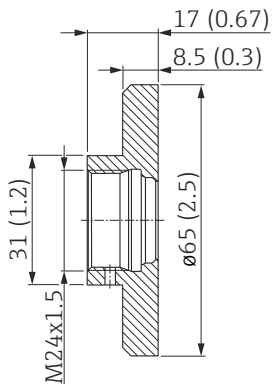

Dimensions mm (in)	Version	Order number
	<ul style="list-style-type: none"> Without inspection certificate With inspection certificate EN10204-3.1 material Material: AISI 316L (1.4435) Roughness (process side): Ra ≤ 0.8 μm (31.5 μin) Max. pressure resistance: 100 bar (1500 psi)	52002643 52010172
	Pressure welding dummy for welding the weld-in adapter Material: Brass	52005082

M24 D65

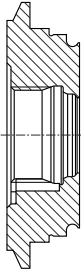
Dimensions (mm)	Version	Order number
 <p data-bbox="518 750 805 851"> Pressure and temperature range of the adapter <ul style="list-style-type: none"> max. 25 bar (362 psi) / max. 150 °C (302 °F) </p>	<ul style="list-style-type: none"> Without inspection certificate With inspection certificate EN10204-3.1 material Material: AISI 316L (1.4435) Roughness (process side): Ra ≤ 0.76 µm (29.9 µin)	71041381 71041383
	O-ring, ø 15.54 x 2,62 mm (0.61 x 0.1 in) Material: EPDM Conform according to USP Class VI, 3-A	52024267 (5 pieces)
	Blind plug for closing weld-in adapter Material: AISI 316L (1.4435) Roughness (process side): Ra ≤ 0.76 µm (29.9 µin)	71171418 ¹⁾

1) TSP modification number. Can be ordered only FTSP, PTSP or NTSP.

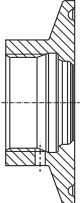
Process adapter M24 - overview level and pressure

Process adapter								
	A0023286	A0023419	A0023547	A0023418	A0023420	A0023423	A0023426	A0023422
	Varivent F DN32 PN40	Varivent N DN50 PN40	DIN11851 DN40	DIN11851 DN50	SMS 1½"	Clamp 1½"	Clamp 2"	APV-Inline
Material	316L (1.4435)	316L (1.4435)	316L (1.4435)	316L (1.4435)	316L (1.4435)	316L (1.4435)	316L (1.4435)	316L (1.4435)
Roughness µm (µin) process side	≤ 0,76 (29.9)	≤ 0,76 (29.9)	≤ 0,76 (29.9)	≤ 0,76 (29.9)	≤ 0,76 (29.9)	≤ 0,76 (29.9)	≤ 0,76 (29.9)	≤ 0,76 (29.9)
Order number process adapter	52023996	52023997	52023999	52023998	52026997	52023994	52023995	52024000
Order number process adapter with inspection certificate ¹⁾	52024003	52024004	52024006	52024005	52026999	52024001	52024002	52024007
Order number for seal replacement (5 pieces) ²⁾	EPDM 52024267	EPDM 52024267	EPDM 52024267	EPDM 52024267	EPDM 52024267	EPDM 52024267	EPDM 52024267	EPDM 52024267
Slotted nut	-	-	71258361	71258361	-	-	-	-
Measuring device	Suitable for process connection option ³⁾							
Liquipoint								
FTW23, FTW33	X2J	X2J	X2J	X2J	X2J	X2J	X2J	X2J
Liquiphant								
FTL33	X2J	X2J	X2J	X2J	X2J	X2J	X2J	X2J
Ceraphant								
PTP33B	X2J/X3J	X2J/X3J	X2J/X3J	X2J/X3J	X2J/X3J	X2J/X3J	X2J/X3J	X2J/X3J
Cerabar								
PMP23	X2J/X3J	X2J/X3J	X2J/X3J	X2J/X3J	X2J/X3J	X2J/X3J	X2J/X3J	X2J/X3J
	Adapter as an accessory enclosed option ⁴⁾							
Liquipoint								
FTW23	RC/RD	RA/RB	-	RE/RF	RG/RH	RI/RJ	RK/RL	-
FTW33	RC/RD	RA/RB	-	RE/RF	RG/RH	-	-	-
Liquiphant								
FTL33	RC/RD	RA/RB	-	RE/RF	RG/RH	-	-	-

1) Inspection certificate EN10204-3.1 material; AD2000: The material 316L (in contact with process) corresponds to AD2000 - W0/W2.

2) One seal is included in scope of delivery.

3) The option can be selected in the Product Configurator via the order feature "Process Connection".

4) The option can be selected in the Product Configurator via the order feature "Accessory Enclosed".

Process connection M24 - level and pressure



Pay attention to the temperature and pressure specifications for the seals and clips used at the customer site!

Varivent F DN32 PN40

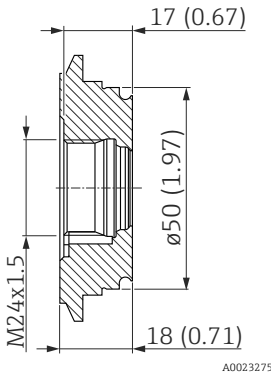
Dimensions mm (in)	Version	Order number
 <p>Pressure and temperature range of the adapter</p> <ul style="list-style-type: none"> max. 25 bar (362 psi) / max. 150 °C (302 °F) max. 40 bar (580 psi) / max. 100 °C (212 °F) 	<ul style="list-style-type: none"> Without inspection certificate With inspection certificate EN10204-3.1 material <p>Material: AISI 316L (1.4435) Roughness (process side): Ra ≤ 0.76 μm (29.9 μin)</p>	<p>52023996 52024003</p>
	<p>Seal, ø 15.54 x 2.62 mm (0.61 x 0.1 in) Material: EPDM Conform according to FDA, 3-A</p>	<p>52024267 (5 pieces)</p>
	<p>Approved by EHEDG</p>	

Varivent N DN50 PN40

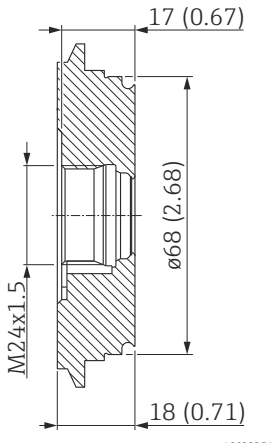
Dimensions mm (in)	Version	Order number
 <p>Pressure and temperature range of the adapter</p> <ul style="list-style-type: none"> max. 25 bar (362 psi) / max. 150 °C (302 °F) max. 40 bar (580 psi) / max. 100 °C (212 °F) 	<ul style="list-style-type: none"> Without inspection certificate With inspection certificate EN10204-3.1 material <p>Material: AISI 316L (1.4435) Roughness (process side): Ra ≤ 0.76 μm (29.9 μin)</p>	<p>52023997 52024004</p>
	<p>Seal, ø 15.54 x 2.62 mm (0.61 x 0.1 in) Material: EPDM Conform according to FDA, 3-A</p>	<p>52024267 (5 pieces)</p>
	<p>Approved by EHEDG</p>	

DIN11851 DN40

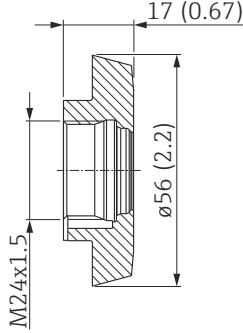
Dimensions mm (in)	Version	Order number
 <p data-bbox="691 663 743 678">A0023548</p> <p data-bbox="427 701 722 808"> Pressure and temperature range of the adapter <ul style="list-style-type: none"> max. 25 bar (362 psi) / max. 150 °C (302 °F) </p>	<ul style="list-style-type: none"> Without inspection certificate With inspection certificate EN10204-3.1 material <p data-bbox="775 394 1233 450"> Material: AISI 316L (1.4435) Roughness (process side): Ra ≤ 0.76 µm (29.9 µin) </p>	<p data-bbox="1270 304 1374 353">52023999 52024006</p>
	<p data-bbox="775 477 1137 555"> Seal, ø 15.54 x 2.62 mm (0.61 x 0.1 in) Material: EPDM Conform according to FDA, 3-A </p>	<p data-bbox="1270 477 1374 526">52024267 (5 pieces)</p>
	<p data-bbox="775 589 967 611">Approved by EHEDG</p>	

DIN11851 DN50

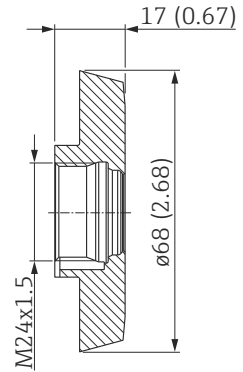
Dimensions in mm (in)	Version	Order number
 <p data-bbox="691 1364 743 1379">A0023273</p> <p data-bbox="427 1402 722 1509"> Pressure and temperature range of the adapter <ul style="list-style-type: none"> max. 25 bar (362 psi) / max. 150 °C (302 °F) </p>	<ul style="list-style-type: none"> Without inspection certificate With inspection certificate EN10204-3.1 material <p data-bbox="775 1059 1233 1115"> Material: AISI 316L (1.4435) Roughness (process side): Ra ≤ 0.76 µm (29.9 µin) </p>	<p data-bbox="1270 969 1374 1019">52023998 52024005</p>
	<p data-bbox="775 1142 1137 1220"> Seal, ø 15.54 x 2.62 mm (0.61 x 0.1 in) Material: EPDM Conform according to FDA, 3-A </p>	<p data-bbox="1270 1142 1374 1191">52024267 (5 pieces)</p>
	<p data-bbox="775 1254 967 1276">Approved by EHEDG</p>	

SMS 1½"

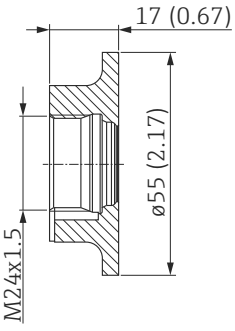
Dimensions mm (in)	Version	Order number
 <p data-bbox="774 656 829 672">A0023278</p> <p data-bbox="517 696 815 745">Pressure and temperature range of the adapter</p> <ul data-bbox="517 748 758 801" style="list-style-type: none"> max. 25 bar (362 psi) / max. 150 °C (302 °F) 	<ul style="list-style-type: none"> Without inspection certificate With inspection certificate EN10204-3.1 material <p data-bbox="858 394 1324 448">Material: AISI 316L (1.4435) Roughness (process side): Ra ≤ 0.76 µm (29.9 µin)</p>	<p data-bbox="1369 304 1476 353">52026997 52026999</p>
	<p data-bbox="858 479 1220 555">Seal, ø 15.54 x 2.62 mm (0.61 x 0.1 in) Material: EPDM Conform according to FDA, 3-A</p>	<p data-bbox="1369 479 1476 528">52024267 (5 pieces)</p>

Clamp 1½"

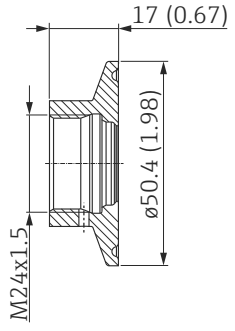
Dimensions mm (in)	Version	Order number
 <p data-bbox="774 1305 829 1321">A0023284</p> <p data-bbox="517 1346 815 1395">Pressure and temperature range of the adapter</p> <ul data-bbox="517 1397 758 1534" style="list-style-type: none"> max. 25 bar (362 psi) / max. 150 °C (302 °F) max. 40 bar (580 psi) / max. 100 °C (212 °F) 	<ul style="list-style-type: none"> Without inspection certificate With inspection certificate EN10204-3.1 material <p data-bbox="858 1057 1324 1111">Material: AISI 316L (1.4435) Roughness (process side): Ra ≤ 0.76 µm (29.9 µin)</p>	<p data-bbox="1369 967 1476 1016">52023994 52024001</p>
	<p data-bbox="858 1142 1220 1218">Seal, ø 15.54 x 2.62 mm (0.61 x 0.1 in) Material: EPDM Conform according to FDA, 3-A</p>	<p data-bbox="1369 1142 1476 1191">52024267 (5 pieces)</p>
	<p data-bbox="858 1254 1045 1281">Approved by EHEDG</p>	

Clamp 2"

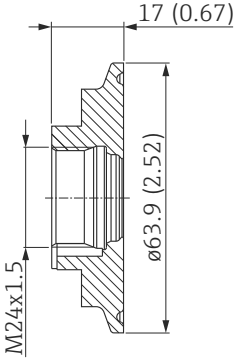
Dimensions mm (in)	Version	Order number
 <p>A0023281</p> <p>Pressure and temperature range of the adapter</p> <ul style="list-style-type: none"> max. 25 bar (362 psi) / max. 150 °C (302 °F) max. 40 bar (580 psi) / max. 100 °C (212 °F) 	<ul style="list-style-type: none"> Without inspection certificate With inspection certificate EN10204-3.1 material <p>Material: AISI 316L (1.4435) Roughness (process side): Ra ≤ 0.76 µm (29.9 µin)</p>	<p>52023995 52024002</p>
	<p>Seal, ø 15.54 x 2.62 mm (0.61 x 0.1 in) Material: EPDM Conform according to FDA, 3-A</p>	<p>52024267 (5 pieces)</p>
	<p>Approved by EHEDG</p>	

APV-Inline

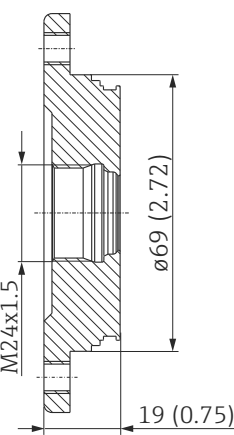
Dimensions mm (in)	Version	Order number
 <p>A0023421</p> <p>Pressure and temperature range of the adapter</p> <ul style="list-style-type: none"> max. 25 bar (362 psi) / max. 150 °C (302 °F) max. 40 bar (580 psi) / max. 100 °C (212 °F) 	<ul style="list-style-type: none"> Without inspection certificate With inspection certificate EN10204-3.1 material <p>Material: AISI 316L (1.4435) Roughness (process side): Ra ≤ 0.76 µm (29.9 µin)</p>	<p>52024000 52024007</p>
	<p>Seal, ø 15.54 x 2.62 mm (0.61 x 0.1 in) Material: EPDM Conform according to FDA</p>	<p>52024267 (5 pieces)</p>
	<p>Approved by EHEDG</p>	

Process adapter UNI - overview pressure

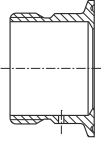
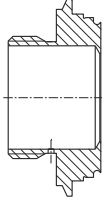
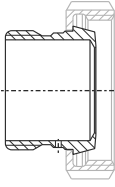
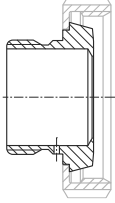
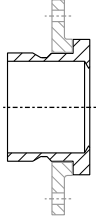

The following adapters can be used to create a connection between the customer's process connection and the Endress+Hauser instrument with a universal adapter.

Process adapter					
	A0023532	A0023530	A0023413	A0023417	A0021898
	Clamp 2"	Varivent N	DIN11851 DN40	DIN11851 DN50	DRD DN50
Material	316L (1.4435)	316L (1.4435)	316L (1.4435)	316L (1.4435)	316L (1.4435)
Roughness μm (μin) process side	≤ 0.76 (29.9)	≤ 0.76 (29.9)	≤ 0.76 (29.9)	≤ 0.76 (29.9)	≤ 0.76 (29.9)
Order number weld-in adapter	71114176	71114177	71114172	71114173	71114174
Order number weld-in adapter with inspection certificate ¹⁾	71114207	71114208	71114178	71114205	71114206
Order number for seal replacement (5 pieces) ²⁾	Silicone profile gasket 52023572	Silicone profile gasket 52023572	Silicone profile gasket 52023572	Silicone profile gasket 52023572	Silicone profile gasket 52023572
Scope of delivery	-	-	Slotted nut	Slotted nut	DRD-flange
Measuring device	Suitable for process connection option ³⁾				
Cerabar					
PMC51	UNJ/UPJ	UNJ/UPJ	UNJ/UPJ	UNJ/UPJ	UNJ/UPJ
PMP55	UPJ	UPJ	UPJ	UPJ	
Deltapilot					
FMB50	UNJ/UPJ	UNJ/UPJ	UNJ/UPJ	UNJ/UPJ	UNJ/UPJ
Deltabar					
FMD71	UNJ/UPJ	UNJ/UPJ	UNJ/UPJ	UNJ/UPJ	UNJ/UPJ
Cerabar	Adapter as an accessory enclosed option ⁴⁾				
PMC51	RD / R4	RF/R6	RA/R1	RB/R2	RC/R3
Deltapilot					
FMB50	RD/R4	RF/R6	RA/R1	RB/R2	RC/R3

- 1) Inspection certificate EN10204-3.1 material; AD2000: The material 316L (in contact with process) corresponds to AD2000 – W0/W2.
- 2) One seal is included in scope of delivery.
- 3) The option can be selected in the Product Configurator via the order feature "Process Connection".
- 4) The option can be selected in the Product Configurator via the order feature "Accessory Enclosed".



Product Configurator: www.endress.com

Process adapter UNI - Pressure

Clamp 2"

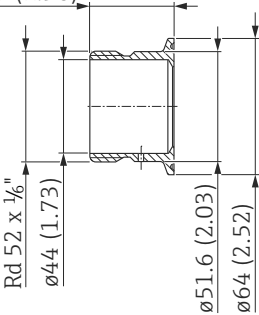
Dimensions mm (in)	Version	Order number
 <p style="text-align: center;">A0023531</p> <p>Pressure- and temperature range</p> <ul style="list-style-type: none"> max. 10 bar (150 psi) / max. 100 °C (212 °F) 	<ul style="list-style-type: none"> Without inspection certificate With inspection certificate EN10204-3.1 material <p>Material: AISI 316L (1.4435) Roughness (process side): Ra ≤ 0.76 μm (29.9 μin)</p>	71114176 71114207
	<p>Silicone profile gasket, ø 34 x 41.5 x 6.4 mm (1.34 x 1.63 x 0.25 in) Material: SI-60 Conform according to FDA, USP Class VI, 3-A</p>	52023572 (5 pieces)
	Approved by EHEDG	
	<p>Alternative seal ø 34 x 41.5 x 6.4 mm (1.34 x 1.63 x 0.25 in)</p>	Order number
<p>Profile gasket Conform according to FDA, USP Class VI, 3-A</p>	71100719 (5 pieces)	
Approved by EHEDG		

Varivent N

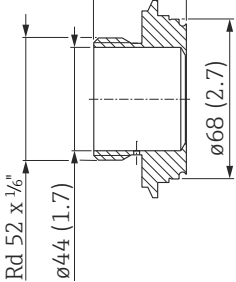
Dimensions mm (in)	Version	Order number
 <p style="text-align: center;">A0023526</p> <p>Pressure- and temperature range</p> <ul style="list-style-type: none"> max. 10 bar (150 psi) / max. 100 °C (212 °F) (max. 135 °C (275 °F) for 30 minutes) 	<ul style="list-style-type: none"> Without inspection certificate With inspection certificate EN10204-3.1 material <p>Material: AISI 316L (1.4435) Roughness (process side): Ra ≤ 0.76 μm (29.9 μin)</p>	71114177 71114208
	<p>Silicone profile gasket, ø 34 x 41.5 x 6.4 mm (1.34 x 1.63 x 0.25 in) Material: SI-60 Conform according to FDA, USP Class VI, 3-A</p>	52023572 (5 pieces)
	Approved by EHEDG	
	<p>Alternative seal ø 34 x 41.5 x 6.4 mm (1.34 x 1.63 x 0.25 in)</p>	Order number
<p>Profile gasket Material: EPDM-70 Conform according to FDA, USP Class VI, 3-A</p>	71100719 (5 pieces)	
Approved by EHEDG		

DIN11851 DN40

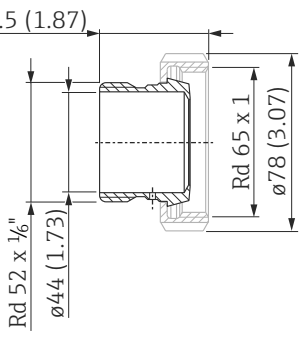
Dimensions mm (in)	Version	Order number
 <p>Pressure- and temperature range</p> <ul style="list-style-type: none"> max. 10 bar (150 psi) / max. 100 °C (212 °F) (max. 135 °C (275 °F) for 30 minutes) 	<ul style="list-style-type: none"> Without inspection certificate With inspection certificate EN10204-3.1 material <p>Material: AISI 316L (1.4435) Roughness (process side): Ra ≤ 0.76 µm (29.9 µin)</p>	<p>71114172 71114178</p>
	<p>Material slotted nut: Endress+Hauser supplies these slotted nuts in stainless steel AISI 304 (DIN/EN material number 1.4301) or in AISI 304L (DIN/EN material number 1.4307).</p>	
	<p>Silicone profile gasket, ø 34 x 41.5 x 6.4 mm (1.34 x 1.63 x 0.25 in) Material: SI-60 Conform according to FDA, USP Class VI, 3-A</p>	<p>52023572 (5 pieces)</p>
	<p>Approved by EHEDG</p>	
	<p>Alternative seal ø 34 x 41.5 x 6.4 mm (1.34 x 1.63 x 0.25 in)</p>	<p>Order number</p>
	<p>Profile gasket Material: EPDM-70 Conform according to FDA, USP Class VI, 3-A</p>	<p>71100719 (5 pieces)</p>
<p>Approved by EHEDG</p>		

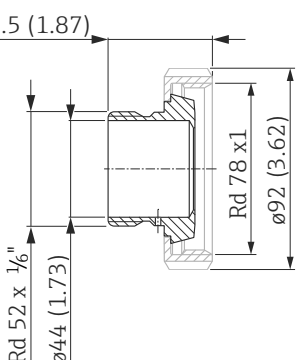

DIN11851 DN50

Dimensions mm (in)	Version	Order number
 <p>Pressure- and temperature range</p> <ul style="list-style-type: none"> max. 10 bar (150 psi) / max. 100 °C (212 °F) (max. 135 °C (275 °F) for 30 minutes) 	<ul style="list-style-type: none"> Without inspection certificate With inspection certificate EN10204-3.1 material <p>Material: AISI 316L (1.4435) Roughness (process side): Ra ≤ 0.76 µm (29.9 µin)</p>	<p>71114173 71114205</p>
	<p>Material slotted nut: Endress+Hauser supplies these slotted nuts in stainless steel AISI 304 (DIN/EN material number 1.4301) or in AISI 304L (DIN/EN material number 1.4307).</p>	
	<p>Silicone profile gasket, ø 34 x 41.5 x 6.4 mm (1.34 x 1.63 x 0.25 in) Material: SI-60 Conform according to FDA, USP Class VI, 3-A</p>	<p>52023572 (5 pieces)</p>
	<p>Approved by EHEDG</p>	
	<p>Alternative seal ø 34 x 41.5 x 6.4 mm (1.34 x 1.63 x 0.25 in)</p>	<p>Order number</p>
	<p>Profile gasket Material: EPDM-70 Conform according to FDA, USP Class VI, 3-A</p>	<p>71100719 (5 pieces)</p>
<p>Approved by EHEDG</p>		

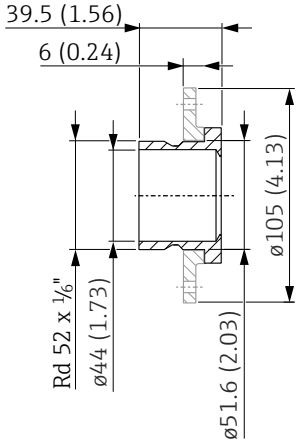
DRD DN50

Dimensions mm (in)	Version	Order number
 <p>A0021388</p> <p>Pressure- and temperature range</p> <ul style="list-style-type: none"> max. 10 bar (150 psi) / max. 100 °C (212 °F) (max. 135 °C (275 °F) for 30 minutes) 	<ul style="list-style-type: none"> Without inspection certificate With inspection certificate EN10204-3.1 material <p>Material: AISI 316L (1.4435) Roughness (process side): Ra ≤ 0.76 µm (29.9 µin)</p>	<p>71114174 71114206</p>
	<p>Material DRD flange: Endress+Hauser supplies these slotted nuts in stainless steel AISI 304 (DIN/EN material number 1.4301).</p>	
	<p>Silicone profile gasket, Ø 34 x 41.5 x 6.4 mm (1.34 x 1.63 x 0.25 in) Material: SI-60 Conform according to FDA, USP Class VI</p>	<p>52023572 (5 pieces)</p>
	<p>Alternative seal Ø 34 x 41,5 x 6,4 mm (1.34 x 1.63 x 0.25 in)</p>	<p>Order number</p>
<p>Profile gasket Material: EPDM-70 Conform according to FDA, USP Class VI</p>	<p>71100719 (5er-Set)</p>	

Welding hints

-  Absolute care must be taken when welding stainless steel. The applied workpieces and tools must be rust-free. Also, no normal steel parts may be present in the vicinity.
-  During the welding, the adapter should be protected against deformations by the welding dummy or by other means of cooling according to usual welding practice (e.g. water cooling). With a suitable seal the welding dummy can also be used to flush-plug the process when starting-up the plant. Before doing so, make sure that the material of the dummy fits the process.

Weld-in adapter with leakage hole or leakage port

If installed horizontally and weld-in adapters with a leakage hole or leakage port are used, ensure that the leakage hole or the leakage port is pointing down. This allows leaks to be detected as quickly as possible.

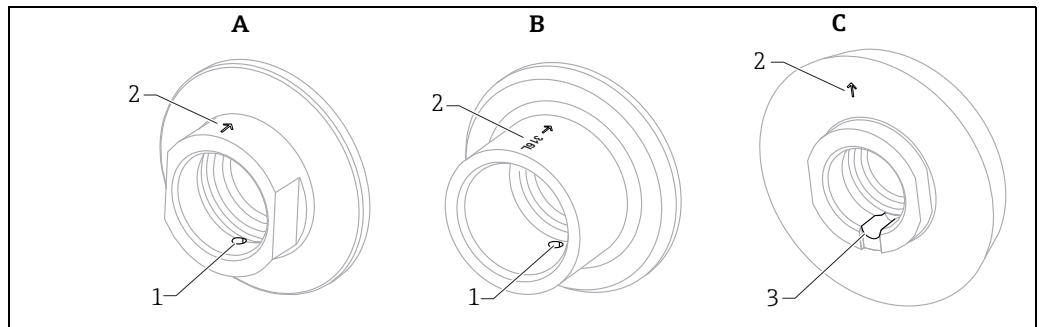

- A Process adapter with leakage hole
- B Weld-in adapter with leakage hole
- C Process adapter with leakage port
- 1 Leakage hole
- 2 Mark, e.g. material and/or arrow, 180° across from hole
- 3 Leakage port

Notes for pressure measuring devices

Before mounting a weld-in adapter for a pressure measuring device, please note the following:

- The maximum pressure resistance of a sensor is limited. Therefore, the welding must be performed very carefully if a weld-in adapter is applied for screwing-in a pressure measuring cell.
- In order to avoid deformations of the weld-in adapter during the welding it is essential to use the correct welding dummy for heat dissipation. Otherwise the tightness and pressure resistance can not be guaranteed after screwing in the sensor. The welding dummy prevents deformation of the weld-in adapter, which could cause leaks after the mounting of the sensor.

Preparation

- Drill a hole at the required position into the wall of the vessel or pipe
Hole diameter: The outer diameter of the welding adapter (max. tolerance: +0.2 mm (0.01 in))
- Slide the weld-in adapter with welding dummy into the hole and align it in a way as to ensure that the sensor will be positioned correctly. See the chapter "Install measuring device" from →  36.

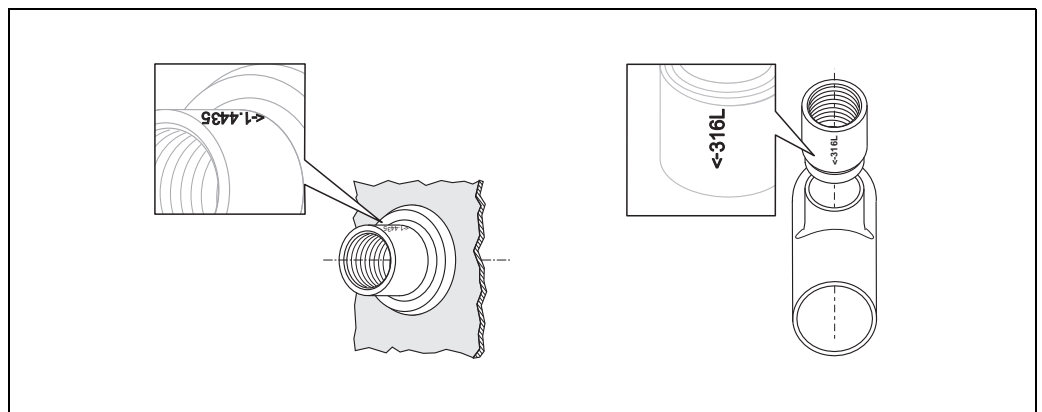

a0008868

Welding procedure

It is recommended to partition the welding seam into several segments (according to common welding practice).

- Pin the weld-in adapter with four or six welding spots to the vessel or tube (see the figures).
- Weld the segments between the spots in order to avoid deformations and leakages. After welding a segment always weld the opposite segment.
- After welding two segments stop the welding procedure until the workpiece is cooled down.
- Let the weld-in adapter cool down after the welding and remove the welding dummy.

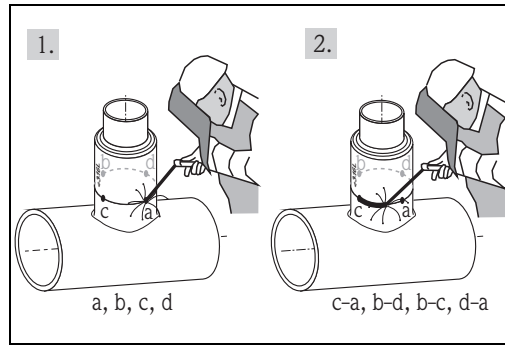

Welding of pipes

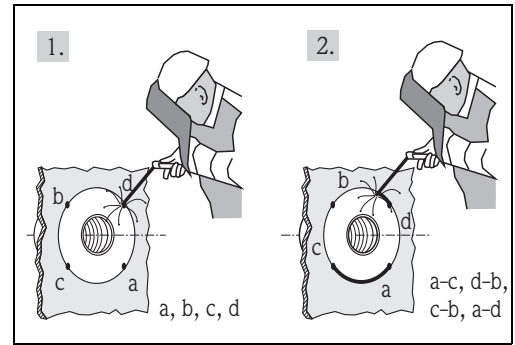

Welding of vessels



To obtain the desired surface roughness, the range of the welding seam must be polished.

Install measuring device

Notes for level measuring device (e.g. Liquiphant)

The marking indicates the position of the tuning fork. The marking appears either as a material specification (e.g. 316L) or a thread designation (e.g. G 1/2") in the following locations: On the process- or weld-in adapter or on the name plate of the measuring device.

If installed horizontally in vessels

- the marking is face up
- ensure that the leakage hole is pointing down. This allows leaks to be detected as quickly as possible, see chapter "Weld-in adapter with leakage hole/leakage port" → 35.

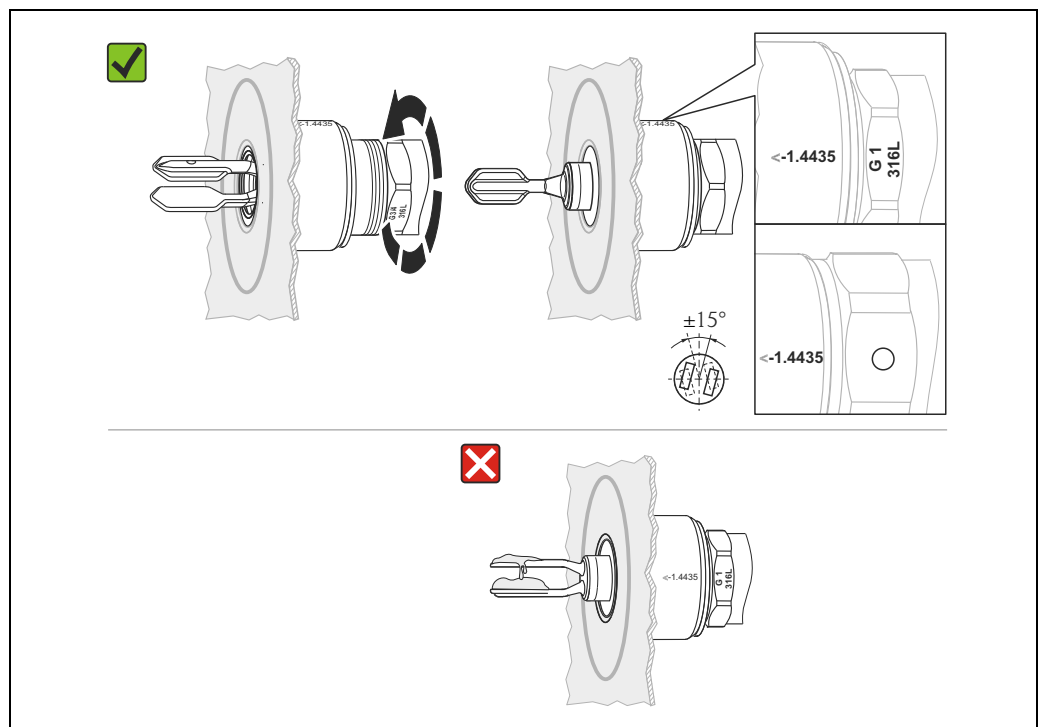

Orientation in the vessel

When mounted into pipes, the fork must be aligned in the direction of the flow according to the mark.

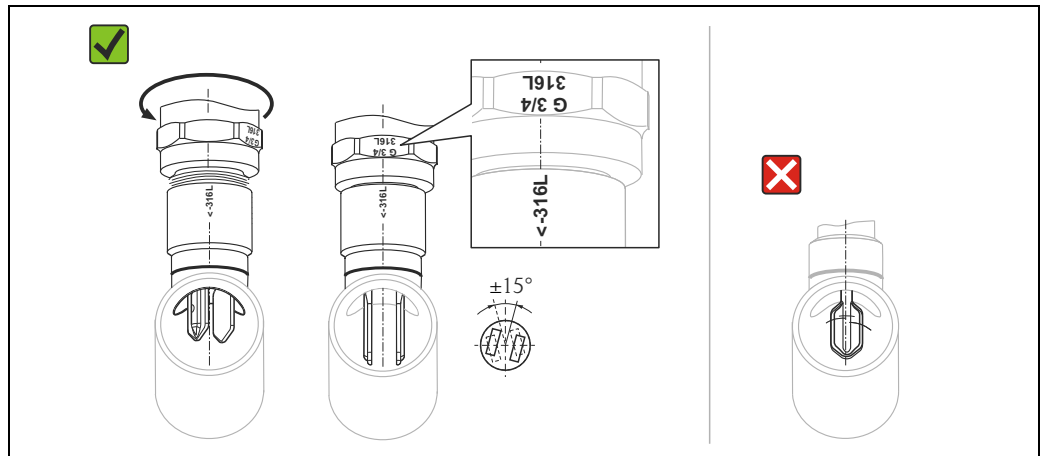

Orientation in the pipe

Notes for pressure sensor

- Before mounting, all sealing surfaces at the weld-in adapter must be cleaned.
- Remove the protective cap from the pressure sensor.
-  Do not touch or damage the process isolating diaphragm!
- Screw the pressure sensor firmly at the hexagonal nut. The threaded connection must be fastened fingertight. It is recommended to secure the threaded connection with a torque of 60 Nm (± 20 Nm) to protect it against vibrations and other influences.

Pressure resistance

The material of the weld-in adapter and the quality of the welding are crucial for pressure resistance. The complete length of the thread has to be used in order to ensure maximum pressure resistance.

Flange - Overview

Specifications

The material of the flanges delivered is AISI 316L with the material number 1.4404 or 1.4435. With regard to their stability-temperature property, the materials 1.4404 and 1.4435 are grouped in DIN EN 1092-1 table 18 under 13EO and in JIS B2220:2004 table 5 under O23b. The ASME flanges are dual rated flanges (316/316L) and grouped in table 2-2.2 according to ASME B16.5-2013.



Values in inches are converted to values in millimeters using the factor 2.54.
The mm values are rounded off to the nearest 0 or 5 in the ASME standard.





Versions

DIN flanges	EN flanges	ASME flanges	JIS flanges
German National Standards Institute	European Standards	America Society of Mechanical Engineers	Japanese Industrial Standard
DIN 2527	DIN EN 1092-1:2002-06 and 2007	ASME B16.5-2013	B2220:2004

Flange Norm DIN EN 1092-1

Endress+Hauser usually delivers only flanges with flat face. This type of flange has hardly changed. Thus, a comparison is done only for this sealing surfaces. Due to the change of the designation of the sealing surface mistakes may occur occasionally. The roughness (Rz) of the old raised face form C and the new one B1 have an overlapping between 40 to 50 μm . In this roughness window both standards are fulfilled.

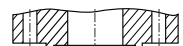
Therefore, at Endress+Hauser the flanges are specified according to both flange standards. This double marking makes it clear that both standards are met.

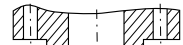
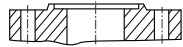
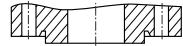
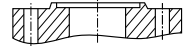
Flange	Sealing Surface	DIN 2526 ¹⁾		DIN EN 1092-1		
		Form	Rz (μm)	Form	Rz (μm)	Ra (μm)
without raised face		A B	- 40 - 160	A ²⁾	12.5 - 50	3.2 - 12.5
with raised face		C	40 - 160	B1 ³⁾	12.5 - 50	3.2 - 12.5
		D	40			
		E	16	B2	3.2 - 12.5	0.8 - 3.2
tongue		F	-	C	3.2 - 12.5	0.8 - 3.2
groove		N	-	D		
projection		V 13	-	E	12.5 - 50	3.2 - 12.5
recess		R 13	-	F		
projection		V 14	for O-rings	H	3.2 - 12.5	3.2 - 12.5
recess		R 14		G		

1) contained in DIN 2527

2) typically of PN2.5 bis PN40

3) typically of PN63



Flange to the old DIN standard are compatible to the new DIN EN 1092-1.
Change in pressure rating: old DIN standards PN64 → DIN EN 1092-1 PN63.

Height of raised face

Dimensions in mm (in).

Standard	Flange	Height of raised face f	Tolerance
DIN EN 1092-1:2002-06	all types	2 (0.08)	0 -1 (-0.04)
DIN EN 1092-1:2007	≤ DN 32	2 (0.08)	0 -1 (-0.04)
	> DN 32 up to DN 250	3 (0.12)	0 -2 (-0.08)
	> DN 250 up to DN 500	4 (0.16)	0 -3 (-0.12)
	> DN 500	5 (0.19)	0 -4 (-0.16)
ASME B16.5-2013	≤ Class 300	1.6 (0.06)	±0.75 (±0.03)
	≥ Class 600	6.4 (0.25)	±0.5 (±0.02)
JIS B2220:2004	< DN 20	1.5 (0.06) 0	-
	> DN 20 up to DN 50	2 (0.08) 0	
	> DN 50	3 (0.12) 0	

Mechanical Construction

DIN flanges (DIN 2527)

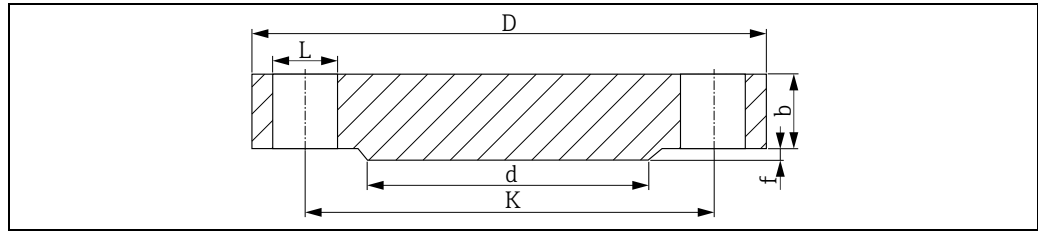

(Raised face DIN 2526 form C)

- L* Diameter of holes
- d* Raised face diameter
- K* Diameter of hole circle
- D* Flange diameter
- b* Total flange thickness
- f* Raised face height (general 2 mm (0.08 in))

PN10

In following tables, the dimensions are indicated in mm (in) unless otherwise noted.

DN	D	b	K	d	L	approx. kg (lbs)
25	115 (4.53)	16 (0.63)	85 (3.35)	68 (2.68)	4xØ14 (0.55)	1.23 (2.71)
32	140 (5.51)	16 (0.63)	100 (3.94)	78 (3.07)	4xØ18 (0.71)	1.80 (3.97)
40	150 (5.91)	16 (0.63)	110 (4.33)	88 (3.46)	4xØ18 (0.71)	2.09 (4.61)
50	165 (6.50)	18 (0.71)	125 (4.92)	102 (4.02)	4xØ18 (0.71)	2.88 (6.35)
65	185 (7.28)	18 (0.71)	145 (5.71)	122 (4.80)	4xØ18 (0.71)	3.70 (8.16)
80	200 (7.87)	20 (0.79)	160 (6.30)	138 (5.43)	8xØ18 (0.71)	4.83 (10.65)
100	220 (8.66)	20 (0.79)	180 (7.09)	158 (6.22)	8xØ18 (0.71)	5.75 (12.68)
125	250 (9.84)	22 (0.87)	210 (8.27)	188 (7.40)	8xØ18 (0.71)	8.59 (18.94)
150	285 (11.2)	22 (0.87)	240 (9.45)	212 (8.35)	8xØ22 (0.87)	10.6 (23.37)
175	315 (12.4)	24 (0.94)	270 (10.6)	242 (9.53)	8xØ22 (0.87)	14.3 (31.53)
200	340 (13.4)	24 (0.94)	295 (11.6)	268 (10.6)	8xØ22 (0.87)	16.9 (37.26)
250	395 (15.6)	26 (1.02)	350 (13.8)	320 (12.6)	12xØ22 (0.87)	24.7 (54.46)
300	445 (17.5)	26 (1.02)	400 (15.7)	370 (14.6)	12xØ22 (0.87)	31.9 (70.34)

PN16

DN	D	b	K	d	L	approx. kg (lbs)
25	115 (4.53)	16 (0.63)	85 (3.35)	68 (2.68)	4xØ14 (0.55)	1.23 (2.71)
32	140 (5.51)	16 (0.63)	100 (3.94)	78 (3.07)	4xØ18 (0.71)	1.80 (3.97)
40	150 (5.91)	16 (0.63)	110 (4.33)	88 (3.46)	4xØ18 (0.71)	2.09 (4.61)
50	165 (6.50)	18 (0.71)	125 (4.92)	102 (4.02)	4xØ18 (0.71)	2.88 (6.35)
65	185 (7.28)	18 (0.71)	145 (5.71)	122 (4.80)	4xØ18 (0.71)	3.70 (8.16)
80	200 (7.87)	20 (0.79)	160 (6.30)	138 (5.43)	8xØ18 (0.71)	4.83 (10.65)
100	220 (8.66)	20 (0.79)	180 (7.09)	158 (6.22)	8xØ18 (0.71)	5.75 (12.68)
125	250 (9.84)	22 (0.87)	210 (8.27)	188 (7.40)	8xØ18 (0.71)	8.59 (18.94)
150	285 (11.2)	22 (0.87)	240 (9.45)	212 (8.35)	8xØ22 (0.87)	10.6 (23.37)
175	315 (12.4)	24 (0.94)	270 (10.6)	242 (9.53)	8xØ22 (0.87)	14.3 (31.53)
200	340 (13.4)	24 (0.94)	295 (11.6)	268 (10.6)	12xØ22 (0.87)	16.5 (36.38)
250	405 (15.9)	26 (1.02)	355 (14.0)	320 (12.6)	12xØ26 (1.02)	25.6 (56.45)
300	460 (18.1)	28 (1.10)	410 (16.1)	378 (14.9)	12xØ26 (1.02)	36.1 (79.60)

PN25

DN	D	b	K	d	L	approx. kg (lbs)
25	115 (4.53)	18 (0.71)	85 (3.35)	68 (2.68)	4xØ14 (0.55)	1.38 (3.04)
32	140 (5.51)	18 (0.71)	100 (3.94)	78 (3.07)	4xØ18 (0.71)	2.03 (4.48)
40	150 (5.91)	18 (0.71)	110 (4.33)	88 (3.46)	4xØ18 (0.71)	2.35 (5.18)
50	165 (6.50)	20 (0.79)	125 (4.92)	102 (4.02)	4xØ18 (0.71)	3.20 (7.06)
65	185 (7.28)	22 (0.87)	145 (5.71)	122 (4.80)	8xØ18 (0.71)	4.33 (9.55)
80	200 (7.87)	24 (0.94)	160 (6.30)	138 (5.43)	8xØ18 (0.71)	5.94 (13.1)
100	235 (9.25)	24 (0.94)	190 (7.48)	162 (6.38)	8xØ22 (0.87)	7.64 (16.85)
125	270 (10.6)	26 (1.02)	220 (8.66)	188 (7.40)	8xØ26 (1.02)	11.0 (24.26)
150	300 (11.8)	28 (1.10)	250 (9.84)	218 (8.58)	8xØ26 (1.02)	14.7 (32.41)
175	330 (13.0)	28 (1.10)	280 (11.0)	248 (9.76)	12xØ26 (1.02)	17.6 (38.81)
200	360 (14.2)	30 (1.18)	310 (12.2)	278 (10.9)	12xØ26 (1.02)	22.7 (50.05)
250	425 (16.7)	32 (1.26)	370 (14.6)	335 (13.2)	12xØ30 (1.18)	34.2 (75.41)
300	485 (19.1)	34 (1.34)	430 (17.0)	395 (15.6)	16xØ30 (1.18)	47.3 (104.3)

PN40

DN	D	b	K	d	L	approx. kg (lbs)
25	115 (4.53)	18 (0.71)	85 (3.35)	68 (2.68)	4xØ14 (0.55)	1.38 (3.04)
32	140 (5.51)	18 (0.71)	100 (3.94)	78 (3.07)	4xØ18 (0.71)	2.03 (4.48)
40	150 (5.91)	18 (0.71)	110 (4.33)	88 (3.46)	4xØ18 (0.71)	2.35 (5.18)
50	165 (6.50)	20 (0.79)	125 (4.92)	102 (4.02)	4xØ18 (0.71)	3.20 (7.06)
65	185 (7.28)	22 (0.87)	145 (5.71)	122 (4.80)	8xØ18 (0.71)	4.33 (9.55)
80	200 (7.87)	24 (0.94)	160 (6.30)	138 (5.43)	8xØ18 (0.71)	5.94 (13.1)
100	235 (9.25)	24 (0.94)	190 (7.48)	162 (6.38)	8xØ22 (0.87)	7.64 (16.85)
125	270 (10.6)	26 (1.02)	220 (8.66)	188 (7.40)	8xØ26 (1.02)	11.0 (24.26)
150	300 (11.8)	28 (1.10)	250 (9.84)	218 (8.58)	8xØ26 (1.02)	14.7 (32.41)
175	350 (13.8)	32 (1.26)	295 (11.6)	260 (10.2)	12xØ30 (1.18)	22.4 (49.39)
200	375 (14.8)	34 (1.34)	320 (12.6)	285 (11.2)	12xØ30 (1.18)	27.6 (60.86)
250	450 (17.7)	38 (1.50)	385 (15.2)	345 (13.6)	12xØ33 (1.30)	44.5 (98.12)
300	515 (20.3)	42 (1.65)	450 (17.7)	410 (16.1)	16xØ33 (1.30)	64.3 (141.8)

PN64

DN	D	b	K	d	L	approx. kg (lbs)
25	140 (5.51)	24 (0.94)	100 (3.94)	68 (2.68)	4xØ18 (0.71)	2.65 (5.84)
32	155 (6.10)	24 (0.94)	110 (4.33)	78 (3.07)	4xØ22 (0.87)	3.24 (7.14)
40	170 (6.69)	26 (1.02)	125 (4.92)	88 (3.46)	4xØ22 (0.87)	4.09 (9.02)
50	180 (7.09)	26 (1.02)	135 (5.31)	102 (4.02)	4xØ22 (0.87)	4.51 (9.94)
65	205 (8.07)	26 (1.02)	160 (6.30)	122 (4.80)	8xØ22 (0.87)	5.71 (12.59)
80	215 (8.46)	28 (1.10)	170 (6.69)	138 (5.43)	8xØ22 (0.87)	6.92 (15.26)
100	250 (9.84)	30 (1.18)	200 (7.87)	162 (6.38)	8xØ26 (1.02)	10.1 (22.27)
125	295 (11.6)	34 (1.34)	240 (9.45)	188 (7.40)	8xØ30 (1.18)	16.0 (35.28)
150	345 (13.6)	36 (1.42)	280 (11.0)	218 (8.58)	8xØ33 (1.30)	23.5 (51.82)
175	375 (14.8)	40 (1.57)	310 (12.2)	260 (10.2)	12xØ33 (1.30)	30.8 (67.91)
200	415 (16.3)	42 (1.65)	345 (13.6)	285 (11.2)	12xØ36 (1.42)	39.7 (87.54)
250	470 (18.5)	46 (1.81)	400 (15.7)	345 (13.6)	12xØ36 (1.42)	57.4 (126.6)
300	530 (20.9)	52 (2.05)	460 (18.1)	410 (16.1)	16xØ36 (1.42)	81.0 (178.6)

PN100

DN	D	b	K	d	L	approx. kg (lbs)
25	140 (5.51)	24 (0.94)	100 (3.94)	68 (2.68)	4xØ18 (0.71)	2.65 (5.84)
32	155 (6.10)	24 (0.94)	110 (4.33)	78 (3.07)	4xØ22 (0.87)	3.24 (7.14)
40	170 (6.69)	26 (1.02)	125 (4.92)	88 (3.46)	4xØ22 (0.87)	4.09 (9.02)
50	195 (7.68)	28 (1.10)	145 (5.71)	102 (4.02)	4xØ26 (1.02)	5.84 (12.88)
65	220 (8.66)	30 (1.18)	170 (6.69)	122 (4.80)	8xØ26 (1.02)	8.03 (17.71)
80	230 (9.06)	32 (1.26)	180 (7.09)	138 (5.43)	8xØ26 (1.02)	9.43 (20.79)
100	265 (10.4)	36 (1.42)	210 (8.27)	162 (6.38)	8xØ30 (1.18)	14.3 (31.53)
125	315 (12.4)	40 (1.57)	250 (9.84)	188 (7.40)	8xØ33 (1.30)	22.6 (49.83)
150	355 (14.0)	44 (1.73)	290 (11.4)	218 (8.58)	12xØ33 (1.30)	31.8 (70.12)
175	385 (15.2)	48 (1.89)	320 (12.6)	260 (10.2)	12xØ33 (1.30)	41.3 (91.07)
200	430 (16.9)	52 (2.05)	360 (14.2)	285 (11.2)	12xØ36 (1.42)	56.1 (123.7)
250	505 (19.9)	60 (2.36)	430 (16.9)	345 (13.6)	12xØ39 (1.54)	89.6 (197.6)
300	585 (23.0)	68 (2.68)	500 (19.7)	410 (16.1)	16xØ42 (1.65)	119 (262.4)

EN flanges (DIN EN 1092-1)

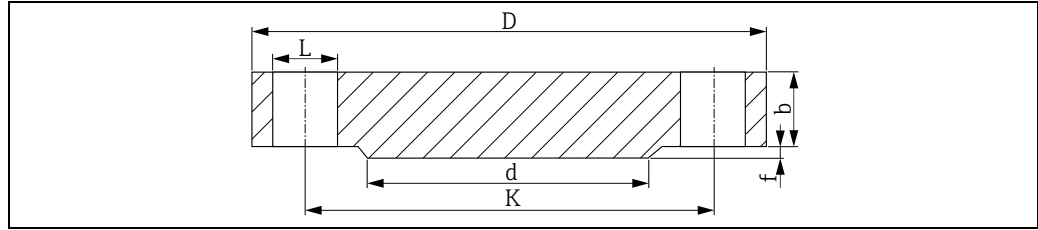

(Raised face B1)

- L Diameter of holes
- d Raised face diameter
- K Diameter of hole circle
- D Flange diameter
- b Total flange thickness
- f Raised face height (general 2 mm (0.08 in))

PN16 In following tables, the dimensions are indicated in mm (in) unless otherwise noted.

DN	D	b	K	d	L	approx. kg (lbs)
25	115 (4.53)	18 (0.71)	85 (3.35)	68 (2.68)	4xØ14 (0.55)	1.50 (3.31)
32	140 (5.51)	18 (0.71)	100 (3.94)	78 (3.07)	4xØ18 (0.71)	2.00 (4.41)
40	150 (5.91)	18 (0.71)	110 (4.33)	88 (3.46)	4xØ18 (0.71)	2.50 (5.51)
50	165 (6.50)	18 (0.71)	125 (4.92)	102 (4.02)	4xØ18 (0.71)	2.90 (6.39)
65	185 (7.28)	18 (0.71)	145 (5.71)	122 (4.80)	8xØ18 (0.71)	3.50 (7.72)
80	200 (7.87)	20 (0.79)	160 (6.30)	138 (5.43)	8xØ18 (0.71)	4.50 (9.92)
100	220 (8.66)	20 (0.79)	180 (7.09)	158 (6.22)	8xØ18 (0.71)	5.50 (12.13)
125	250 (9.84)	22 (0.87)	210 (8.27)	188 (7.40)	8xØ18 (0.71)	8.00 (17.64)
150	285 (11.2)	22 (0.87)	240 (9.45)	212 (8.35)	8xØ22 (0.87)	10.5 (23.15)
200	340 (13.4)	24 (0.94)	295 (11.6)	268 (10.6)	12xØ22 (0.87)	16.5 (36.38)
250	405 (15.9)	26 (1.02)	355 (14.0)	320 (12.6)	12xØ26 (1.02)	25.0 (55.13)
300	460 (18.1)	28 (1.10)	410 (16.1)	378 (14.9)	12xØ26 (1.02)	35.0 (77.18)

PN25

DN	D	b	K	d	L	approx. kg (lbs)
25	115 (4.53)	18 (0.71)	85 (3.35)	68 (2.68)	4xØ14 (0.55)	1.50 (3.31)
32	140 (5.51)	18 (0.71)	100 (3.94)	78 (3.07)	4xØ18 (0.71)	2.00 (4.41)
40	150 (5.91)	18 (0.71)	110 (4.33)	88 (3.46)	4xØ18 (0.71)	2.50 (5.51)
50	165 (6.50)	20 (0.79)	125 (4.92)	102 (4.02)	4xØ18 (0.71)	3.00 (6.62)
65	185 (7.28)	22 (0.87)	145 (5.71)	122 (4.80)	8xØ18 (0.71)	4.50 (9.92)
80	200 (7.87)	24 (0.94)	160 (6.30)	138 (5.43)	8xØ18 (0.71)	5.50 (12.13)
100	235 (9.25)	24 (0.94)	190 (7.48)	162 (6.38)	8xØ22 (0.87)	7.50 (16.54)
125	270 (10.6)	26 (1.02)	220 (8.66)	188 (7.40)	8xØ26 (1.02)	11.0 (24.26)
150	300 (11.8)	28 (1.10)	250 (9.84)	218 (8.58)	8xØ26 (1.02)	14.5 (31.97)
200	360 (14.2)	30 (1.18)	310 (12.2)	278 (10.9)	12xØ26 (1.02)	22.5 (49.61)
250	425 (16.7)	32 (1.26)	370 (14.6)	335 (13.2)	12xØ30 (1.18)	33.5 (73.9)
300	485 (19.1)	34 (1.34)	430 (16.9)	395 (15.6)	16xØ30 (1.18)	46.5 (102.5)

PN40

DN	D	b	K	d	L	approx. kg (lbs)
25	115 (4.53)	18 (0.71)	85 (3.35)	68 (2.68)	4xØ14 (0.55)	1.50 (3.31)
32	140 (5.51)	18 (0.71)	100 (3.94)	78 (3.07)	4xØ18 (0.71)	2.00 (4.41)
40	150 (5.91)	18 (0.71)	110 (4.33)	88 (3.46)	4xØ18 (0.71)	2.50 (5.51)
50	165 (6.50)	20 (0.79)	125 (4.92)	102 (4.02)	4xØ18 (0.71)	3.00 (6.62)
65	185 (7.28)	22 (0.87)	145 (5.71)	122 (4.80)	8xØ18 (0.71)	4.50 (9.92)
80	200 (7.87)	24 (0.94)	160 (6.30)	138 (5.43)	8xØ18 (0.71)	5.50 (12.13)
100	235 (9.25)	24 (0.94)	190 (7.48)	162 (6.38)	8xØ22 (0.87)	7.50 (16.54)
125	270 (10.6)	26 (1.02)	220 (8.66)	188 (7.40)	8xØ26 (1.02)	11.0 (24.26)
150	300 (11.8)	28 (1.10)	250 (9.84)	218 (8.58)	8xØ26 (1.02)	14.5 (31.97)
200	375 (14.8)	36 (1.42)	320 (12.6)	285 (11.2)	12xØ30 (1.18)	29.0 (63.95)
250	450 (17.7)	38 (1.50)	385 (15.2)	345 (13.6)	12xØ33 (1.30)	44.5 (98.12)
300	515 (20.3)	42 (1.65)	450 (17.7)	410 (16.1)	16xØ33 (1.30)	64.0 (141.1)

PN63

DN	D	b	K	d	L	approx. kg (lbs)
25	140 (5.51)	24 (0.94)	100 (3.94)	68 (2.68)	4xØ18 (0.71)	2.50 (5.51)
32	155 (6.10)	24 (0.94)	110 (4.33)	78 (3.07)	4xØ22 (0.87)	3.50 (7.72)
40	170 (6.69)	26 (1.02)	125 (4.92)	88 (3.46)	4xØ22 (0.87)	4.50 (9.92)
50	180 (7.09)	26 (1.02)	135 (5.31)	102 (4.02)	4xØ22 (0.87)	5.00 (11.03)
65	205 (8.07)	26 (1.02)	160 (6.30)	122 (4.80)	8xØ22 (0.87)	6.00 (13.23)
80	215 (8.46)	28 (1.10)	170 (6.69)	138 (5.43)	8xØ22 (0.87)	7.50 (16.54)
100	250 (9.84)	30 (1.18)	200 (7.87)	162 (6.38)	8xØ26 (1.02)	10.5 (23.15)
125	295 (11.6)	34 (1.34)	240 (9.45)	188 (7.40)	8xØ30 (1.18)	16.5 (36.38)
150	345 (13.6)	36 (1.42)	280 (11.0)	218 (8.58)	8xØ33 (1.30)	24.5 (54.02)
200	415 (16.3)	42 (1.65)	345 (13.6)	285 (11.2)	12xØ36 (1.42)	40.5 (89.3)
250	470 (18.5)	46 (1.81)	400 (15.7)	345 (13.6)	12xØ36 (1.42)	58.0 (127.9)
300	530 (20.9)	52 (2.05)	460 (18.1)	410 (16.1)	16xØ36 (1.42)	83.5 (184.1)

PN100

DN	D	b	K	d	L	approx. kg (lbs)
25	140 (5.51)	24 (0.94)	100 (3.94)	68 (2.68)	4xØ18 (0.71)	2.50 (5.51)
32	155 (6.10)	24 (0.94)	110 (4.33)	78 (3.07)	4xØ22 (0.87)	3.50 (7.72)
40	170 (6.69)	26 (1.02)	125 (4.92)	88 (3.46)	4xØ22 (0.87)	4.50 (9.92)
50	195 (7.68)	28 (1.10)	145 (5.71)	102 (4.02)	4xØ26 (1.02)	6.00 (13.23)
65	220 (8.66)	30 (1.18)	170 (6.69)	122 (4.80)	8xØ26 (1.02)	8.00 (17.64)
80	230 (9.06)	32 (1.26)	180 (7.09)	138 (5.43)	8xØ26 (1.02)	9.50 (20.95)
100	265 (10.4)	36 (1.42)	210 (8.27)	162 (6.38)	8xØ30 (1.18)	14.0 (30.87)
125	315 (12.4)	40 (1.57)	250 (9.84)	188 (7.40)	8xØ33 (1.30)	22.5 (49.61)
150	355 (14.0)	44 (1.73)	290 (11.4)	218 (8.58)	12xØ33 (1.30)	30.5 (67.25)
200	430 (16.9)	52 (2.05)	360 (14.2)	285 (11.2)	12xØ36 (1.42)	54.5 (120.2)
250	505 (19.9)	60 (2.36)	430 (16.9)	345 (13.6)	12xØ39 (1.54)	87.5 (192.9)
300	585 (23.0)	68 (2.68)	500 (19.7)	410 (16.1)	16xØ42 (1.65)	131.5 (289.9)

ASME-Flange (ASME B16.5-2013)

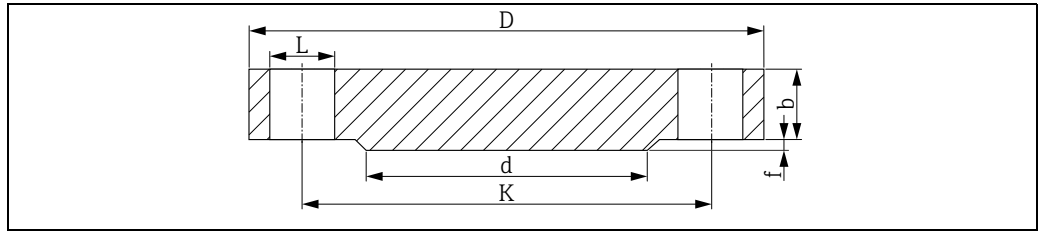

(Raised face RF)

- L Diameter of holes
- d Raised face diameter
- K Diameter of hole circle
- D Flange diameter
- b Total flange thickness
- f Raised face height Class 150/300: 1.6 mm (0.06 in) or from Class 600: 6.4 mm (0.25 in)

Note!

Surface finish of the gasket faces $R_a \leq 3.2$ to $6.3 \mu\text{m}$ (126 to 248 μin).

Class 150

In following tables, the dimensions are indicated in mm (in) unless otherwise noted.

NPS (Nominal pipe size)	D	b	K	d	L	approx. kg (lbs)
1"	108.0 (4.25)	14.2 (0.56)	79.2 (3.12)	50.8 (2.00)	4x \varnothing 15.7 (0.62)	0.86 (1.9)
1¼"	117.3 (4.62)	15.7 (0.62)	88.9 (3.50)	63.5 (2.50)	4x \varnothing 15.7 (0.62)	1.17 (2.58)
1½"	127.0 (5.00)	17.5 (0.69)	98.6 (3.88)	73.2 (2.88)	4x \varnothing 15.7 (0.62)	1.53 (3.37)
2"	152.4 (6.00)	19.1 (0.75)	120.7 (4.75)	91.9 (3.62)	4x \varnothing 19.1 (0.75)	2.42 (5.34)
2½"	177.8 (7.00)	22.4 (0.88)	139.7 (5.50)	104.6 (4.12)	4x \varnothing 19.1 (0.75)	3.94 (8.69)
3"	190.5 (7.50)	23.9 (0.94)	152.4 (6.00)	127.0 (5.00)	4x \varnothing 19.1 (0.75)	4.93 (10.87)
3½"	215.9 (8.50)	23.9 (0.94)	177.8 (7.00)	139.7 (5.50)	8x \varnothing 19.1 (0.75)	6.17 (13.60)
4"	228.6 (9.00)	23.9 (0.94)	190.5 (7.50)	157.2 (6.19)	8x \varnothing 19.1 (0.75)	7.00 (15.44)
5"	254.0 (10.0)	23.9 (0.94)	215.9 (8.50)	185.7 (7.31)	8x \varnothing 22.4 (0.88)	8.63 (19.03)
6"	279.4 (11.0)	25.4 (1.00)	241.3 (9.50)	215.9 (8.50)	8x \varnothing 22.4 (0.88)	11.3 (24.92)
8"	342.9 (13.5)	28.4 (1.12)	298.5 (11.8)	269.7 (10.6)	8x \varnothing 22.4 (0.88)	19.6 (43.22)
10"	406.4 (16.0)	30.2 (1.19)	362.0 (14.3)	323.8 (12.7)	12x \varnothing 25.4 (1.00)	28.8 (63.50)

Class 300

NPS (Nominal pipe size)	D	b	K	d	L	approx. kg (lbs)
1"	124.0 (4.88)	17.5 (0.69)	88.9 (3.50)	50.8 (2.00)	4xØ19.1 (0.75)	1.39 (3.06)
1¼"	133.4 (5.25)	19.1 (0.75)	98.6 (3.88)	63.5 (2.50)	4xØ19.1 (0.75)	1.79 (3.95)
1½"	155.4 (6.12)	20.6 (0.81)	114.3 (4.50)	73.2 (2.88)	4xØ22.4 (0.88)	2.66 (5.87)
2"	165.1 (6.50)	22.4 (0.88)	127.0 (5.00)	91.9 (3.62)	8xØ19.1 (0.75)	3.18 (7.01)
2½"	190.5 (7.50)	25.4 (1.00)	149.4 (5.88)	104.6 (4.12)	8xØ22.4 (0.88)	4.85 (10.69)
3"	209.5 (8.25)	28.4 (1.12)	168.1 (6.62)	127.0 (5.00)	8xØ22.4 (0.88)	6.81 (15.02)
3½"	228.6 (9.00)	30.2 (1.19)	184.2 (7.25)	139.7 (5.50)	8xØ22.4 (0.88)	8.71 (19.21)
4"	254.0 (10.0)	31.8 (1.25)	200.2 (7.88)	157.2 (6.19)	8xØ22.4 (0.88)	11.5 (25.36)
5"	279.4 (11.0)	35.1 (1.38)	235.0 (9.25)	185.7 (7.31)	8xØ22.4 (0.88)	15.6 (34.4)
6"	317.5 (12.5)	36.6 (1.44)	269.7 (10.6)	215.9 (8.50)	12xØ22.4 (0.88)	20.9 (46.08)
8"	381.0 (15.0)	41.1 (1.62)	330.2 (13.0)	269.7 (10.6)	12xØ25.4 (1.00)	34.3 (75.63)
10"	444.5 (17.5)	47.8 (1.88)	387.4 (15.3)	323.8 (12.7)	16xØ28.4 (1.12)	53.3 (117.5)

Class 600

NPS (Nominal pipe size)	D	b	K	d	L	approx. kg (lbs)
1"	124.0 (4.88)	17.5 (0.69)	88.9 (3.50)	50.8 (2.00)	4xØ19.1 (0.75)	1.60 (3.53)
1¼"	133.4 (5.25)	20.6 (0.81)	98.6 (3.88)	63.5 (2.50)	4xØ19.1 (0.75)	2.23 (4.92)
1½"	155.4 (6.12)	22.4 (0.88)	114.3 (4.50)	73.2 (2.88)	4xØ22.4 (0.88)	3.25 (7.17)
2"	165.1 (6.50)	25.4 (1.00)	127.0 (5.00)	91.9 (3.62)	8xØ19.1 (0.75)	4.15 (9.15)
2½"	190.5 (7.50)	28.4 (1.12)	149.4 (5.88)	104.6 (4.12)	8xØ22.4 (0.88)	6.13 (13.52)
3"	209.5 (8.25)	31.8 (1.25)	168.1 (6.62)	127.0 (5.00)	8xØ22.4 (0.88)	8.44 (18.61)
3½"	228.6 (9.00)	35.1 (1.38)	184.2 (7.25)	139.7 (5.50)	8xØ25.4 (1.00)	11.0 (24.26)
4"	273.1 (10.8)	38.1 (1.50)	215.9 (8.50)	157.2 (6.19)	8xØ25.4 (1.00)	17.3 (38.15)
5"	330.2 (13.0)	44.5 (1.75)	266.7 (10.5)	185.7 (7.31)	8xØ28.4 (1.12)	29.4 (64.83)
6"	355.6 (14.0)	47.8 (1.88)	292.1 (11.5)	215.9 (8.50)	12xØ28.4 (1.12)	36.1 (79.6)
8"	419.1 (16.5)	55.6 (2.19)	349.3 (13.8)	269.7 (10.6)	12xØ31.8 (1.25)	58.9 (129.9)
10"	508.0 (20.0)	63.5 (2.50)	431.8 (17.0)	323.8 (12.7)	16xØ35.1 (1.38)	97.5 (214.9)

Class 900

NPS (Nominal pipe size)	D	b	K	d	L	approx. kg (lbs)
1"	149.4 (5.88)	28.4 (1.12)	101.6 (4.00)	50.8 (2.00)	4xØ25.4 (1.00)	3.57 (7.87)
1¼"	158.8 (6.25)	28.4 (1.12)	111.3 (4.38)	63.5 (2.50)	4xØ25.4 (1.00)	4.14 (9.13)
1½"	177.8 (7.00)	31.8 (1.25)	124.0 (4.88)	73.2 (2.88)	4xØ28.4 (1.12)	5.75 (12.68)
2"	215.9 (8.50)	38.1 (1.50)	165.1 (6.50)	91.9 (3.62)	8xØ25.4 (1.00)	10.1 (22.27)
2½"	244.4 (9.62)	41.1 (1.62)	190.5 (7.50)	104.6 (4.12)	8xØ28.4 (1.12)	14.0 (30.87)
3"	241.3 (9.50)	38.1 (1.50)	190.5 (7.50)	127.0 (5.00)	8xØ25.4 (1.00)	13.1 (28.89)
4"	292.1 (11.50)	44.5 (1.75)	235.0 (9.25)	157.2 (6.19)	8xØ31.8 (1.25)	26.9 (59.31)
5"	349.3 (13.8)	50.8 (2.00)	279.4 (11.0)	185.7 (7.31)	8xØ35.1 (1.38)	36.5 (80.48)
6"	381.0 (15.00)	55.6 (2.19)	317.5 (12.5)	215.9 (8.50)	12xØ31.8 (1.25)	47.4 (104.5)
8"	469.9 (18.50)	63.5 (2.50)	393.7 (15.5)	269.7 (10.6)	12xØ38.1 (1.50)	82.5 (181.9)
10"	546.1 (21.50)	69.9 (2.75)	469.9 (18.5)	323.8 (12.7)	16xØ38.1 (1.50)	122 (269.0)

Class 1500

NPS (Nominal pipe size)	D	b	K	d	L	approx. kg (lbs)
1"	149.4 (5.88)	28.4 (1.12)	101.6 (4.00)	50.8 (2.00)	4xØ25.4 (1.00)	3.57 (7.87)
1¼"	158.8 (6.25)	28.4 (1.12)	111.3 (4.38)	63.5 (2.50)	4xØ25.4 (1.00)	4.14 (9.13)
1½"	177.8 (7.00)	31.8 (1.25)	124.0 (4.88)	73.2 (2.88)	4xØ28.4 (1.12)	5.75 (12.68)
2"	215.9 (8.50)	38.1 (1.50)	165.1 (6.50)	91.9 (3.62)	8xØ25.4 (1.00)	10.1 (22.27)
2½"	244.4 (9.62)	41.1 (1.62)	190.5 (7.50)	104.6 (4.12)	8xØ28.4 (1.12)	14.0 (30.87)
3"	266.7 (10.50)	47.8 (1.88)	203.2 (8.00)	127.0 (5.00)	8xØ31.8 (1.25)	19.1 (42.12)
4"	311.2 (12.3)	53.8 (2.12)	241.3 (9.50)	157.2 (6.19)	8xØ35.1 (1.38)	29.9 (65.93)
5"	374.7 (14.8)	73.2 (2.88)	292.1 (11.5)	185.7 (7.31)	8xØ41.1 (1.62)	58.4 (128.8)
6"	393.7 (15.50)	82.6 (3.25)	317.5 (12.5)	215.9 (8.50)	12xØ38.1 (1.50)	71.8 (158.3)
8"	482.6 (19.00)	91.9 (3.62)	393.7 (15.5)	269.7 (10.6)	12xØ44.5 (1.75)	122 (269.0)
10"	584.2 (23.00)	108.0 (4.25)	482.6 (19.0)	323.8 (12.7)	12xØ50.8 (2.00)	210 (463.0)

JIS flanges (B 2220)

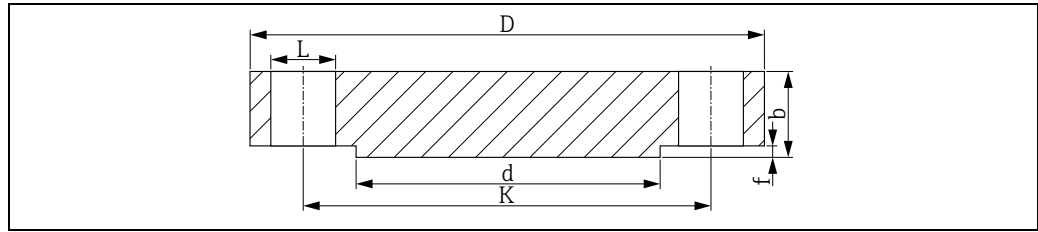

A0029174

(Raised face RF)

- L* Diameter of holes
d Raised face diameter
K Diameter of hole circle
D Flange diameter
b Total flange thickness
f Raised face height (general 2 mm (0.08 in))

Note!

Surface finish of the gasket faces $Ra \leq 3.2$ to $6.3 \mu\text{m}$ (126 to 248 μin).

10 K

In following tables, the dimensions are indicated in mm (in) unless otherwise noted.

DN	D	b	K	d	L
25	125 (4.92)	14 (0.55)	90 (3.54)	67 (2.64)	4x \varnothing 19 (0.75)
32	135 (5.31)	16 (0.63)	100 (3.94)	76 (2.99)	4x \varnothing 19 (0.75)
40	140 (5.51)	16 (0.63)	105 (4.13)	81 (3.19)	4x \varnothing 19 (0.75)
50	155 (6.10)	16 (0.63)	120 (4.72)	96 (3.78)	4x \varnothing 19 (0.75)
65	175 (6.89)	18 (0.71)	140 (5.51)	116 (4.57)	4x \varnothing 19 (0.75)
80	185 (7.28)	18 (0.71)	150 (5.91)	126 (4.96)	8x \varnothing 19 (0.75)
100	210 (8.27)	18 (0.71)	175 (6.89)	151 (5.94)	8x \varnothing 19 (0.75)
125	250 (9.84)	20 (0.79)	210 (8.27)	182 (7.17)	8x \varnothing 23 (0.91)
150	280 (11.0)	22 (0.87)	240 (9.45)	212 (8.35)	8x \varnothing 23 (0.91)
200	330 (13.0)	22 (0.87)	290 (11.4)	262 (10.3)	12x \varnothing 23 (0.91)
250	400 (15.7)	24 (0.94)	355 (14.0)	324 (12.8)	12x \varnothing 25 (0.98)
300	445 (17.5)	24 (0.94)	400 (15.7)	368 (14.5)	16x \varnothing 25 (0.98)

20 K

DN	D	b	K	d	L
25	125 (4.92)	16 (0.63)	90 (3.54)	67 (2.64)	4x \varnothing 19 (0.75)
32	135 (5.31)	18 (0.71)	100 (3.94)	76 (2.99)	4x \varnothing 19 (0.75)
40	140 (5.51)	18 (0.71)	105 (4.13)	81 (3.19)	4x \varnothing 19 (0.75)
50	155 (6.10)	18 (0.71)	120 (4.72)	96 (3.78)	8x \varnothing 19 (0.75)
65	175 (6.89)	20 (0.79)	140 (5.51)	116 (4.57)	8x \varnothing 19 (0.75)
80	200 (7.87)	22 (0.87)	160 (6.30)	132 (5.20)	8x \varnothing 23 (0.91)
100	225 (8.86)	24 (0.94)	185 (7.28)	160 (6.30)	8x \varnothing 23 (0.91)
125	270 (10.6)	26 (1.02)	225 (8.86)	195 (7.68)	8x \varnothing 25 (0.98)
150	305 (12.0)	28 (1.10)	260 (10.2)	230 (9.06)	12x \varnothing 25 (0.98)
200	350 (13.8)	30 (1.18)	305 (12.0)	275 (10.8)	12x \varnothing 25 (0.98)
250	430 (16.9)	34 (1.34)	380 (15.0)	345 (13.6)	12x \varnothing 27 (1.06)
300	480 (18.9)	36 (1.42)	430 (16.9)	395 (15.6)	16x \varnothing 27 (1.06)

63 K

DN	D	b	K	d	L
25	140 (5.51)	27 (1.06)	100 (3.94)	70 (2.76)	4xØ23 (0.91)
32	150 (5.91)	30 (1.18)	110 (4.33)	80 (3.15)	4xØ23 (0.91)
40	175 (6.89)	32 (1.26)	130 (5.12)	90 (3.54)	4xØ25 (0.98)
50	185 (7.28)	34 (1.34)	145 (5.71)	105 (4.13)	8xØ23 (0.91)
65	220 (8.66)	38 (1.50)	175 (6.89)	130 (5.12)	8xØ25 (0.98)
80	230 (9.06)	40 (1.57)	185 (7.28)	140 (5.51)	8xØ25 (0.98)
100	270 (10.6)	44 (1.73)	220 (8.66)	165 (6.50)	8xØ27 (1.06)
125	325 (12.8)	50 (1.97)	265 (10.4)	200 (7.87)	8xØ33 (1.30)
150	365 (14.4)	54 (2.13)	305 (12.0)	240 (9.45)	12xØ33 (1.30)
200	425 (16.7)	60 (2.36)	360 (14.2)	290 (11.4)	12xØ33 (1.30)
250	500 (19.7)	68 (2.68)	430 (16.9)	355 (14.0)	12xØ39 (1.54)
300	560 (22.0)	77 (3.03)	485 (19.1)	410 (16.1)	16xØ39 (1.54)

Pressure-temperature dependencies

EN flanges¹⁾

Temperature range	Nominal pressure bar (psi)				
	PN16	PN25	PN40	PN63	PN100
-10 °C ... +50 °C (+14 °F ... +122 °F)	16.0 (232)	25.0 (362)	40.0 (580)	63.0 (913)	100.0 (1450)
50 °C (122 °F)	15.5 (225)	24.3 (352)	38.9 (564)	61.3 (889)	97.3 (1411)
100 °C (212 °F)	15.1 (219)	23.6 (342)	37.9 (550)	59.7 (866)	94.7 (1373)
150 °C (302 °F)	13.7 (199)	21.5 (312)	34.4 (499)	54.3 (787)	86.1 (1248)
200 °C (392 °F)	12.7 (184)	19.8 (287)	31.8 (461)	50.1 (726)	79.5 (1153)
250 °C (482 °F)	11.9 (173)	18.6 (270)	29.9 (434)	47.1 (683)	74.7 (1083)
300 °C (572 °F)	11.0 (159)	17.2 (249)	27.6 (400)	43.5 (631)	69.0 (1000)
350 °C (662 °F)	10.5 (152)	16.5 (239)	26.4 (383)	41.7 (605)	66.1 (958)
400 °C (752 °F)	10.2 (148)	16.0 (232)	25.7 (373)	40.1 (580)	64.2 (931)

ASME flanges¹⁾

Temperature range	Nominal pressure bar (psi)				
	Class 150	Class 300	Class 600	Class 900	Class 1500
-29 °C ... +38 °C (-20 °F ... +100 °F)	19.0 (275)	49.6 (719)	99.3 (1440)	148.9 (2159)	248.2 (3599)
50 °C (122 °F)	18.4 (267)	48.1 (697)	96.2 (1395)	144.3 (2092)	240.6 (3489)
100 °C (212 °F)	16.2 (235)	42.2 (612)	84.4 (1224)	126.6 (1836)	211.0 (3059)
150 °C (302 °F)	14.8 (215)	38.5 (558)	77.0 (1116)	115.5 (1675)	192.5 (2791)
200 °C (392 °F)	13.7 (199)	35.7 (518)	71.3 (1034)	107.0 (1551)	178.3 (2588)
250 °C (482 °F)	12.1 (175)	33.4 (484)	66.8 (969)	100.1 (1451)	166.9 (2420)
300 °C (572 °F)	10.2 (148)	31.6 (458)	63.2 (916)	94.9 (1376)	158.1 (2292)
325 °C (617 °F)	9.3 (135)	30.9 (448)	61.8 (896)	92.7 (1344)	154.4 (2239)
350 °C (662 °F)	8.4 (122)	30.3 (439)	60.7 (880)	91.0 (1319)	151.6 (2189)
375 °C (707 °F)	7.4 (107)	29.9 (434)	59.8 (867)	89.6 (1299)	149.4 (2166)
400 °C (752 °F)	6.5 (94)	29.4 (426)	58.9 (854)	88.3 (1280)	147.2 (2134)

JIS flanges¹⁾

Temperature range	Nominal pressure bar (psi)			
	10 K	20 K		
	for all flanges	to DN 125	from DN 150 up to DN 250	DN 300
up to 120 °C (248 °F)	14 (203.0)	34 (493.0)	20 (290.0)	20 (290.0)
220 °C (428 °F)	12 (174.0)	31 (449.5)	20 (290.0)	-
300 °C (572 °F)	10 (145.0)	29 (420.5)	19 (275.5)	-
350 °C (662 °F)	-	26 (377.0)	17 (246.5)	-
400 °C (752 °F)	-	23 (333.5)	17 (246.5)	-
425 °C (797 °F)	-	20 (290.0)	17 (246.5)	-

1) With regard to their stability-temperature property, the materials 1.4435 and 1.4404 are grouped in DIN EN 1092-1 table 18 under 13EO and in JIS B2220:2004 table 5 under O23b. The ASME flanges are dual rated flanges (316/316L) and grouped in table 2-2.2 according to ASME B16.5-2013.

Adapter flange FAU70

An adapter flange makes it possible to use devices with a threaded connection.

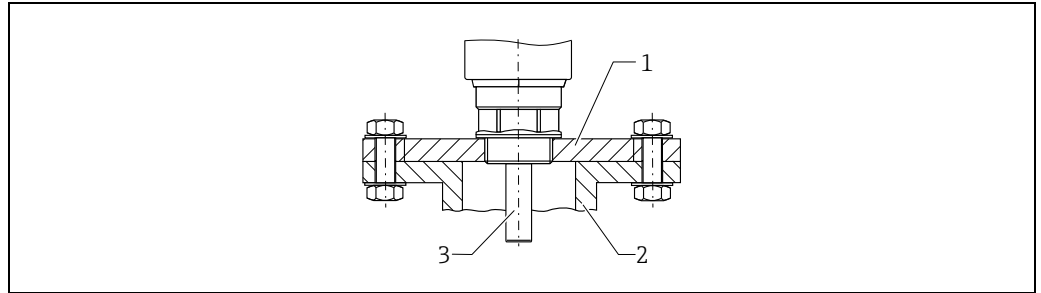

A0029173

- 1 Adapter flange
- 2 Nozzle
- 3 Probe

FAU70E Version with metrical thread

Order information

010	Process Connection	
12	DN 50 PN16 A, flange EN 1092-1 (DIN 2527 B)	
14	DN 80 PN16 A, flange EN 1092-1 (DIN 2527 B)	
15	DN 100 PN16 A, flange EN 1092-1 (DIN 2527 B)	
99	Special version, to be specified	
020	Sensor Connection	
3	Thread ISO228 G1-1/2	
4	Thread ISO228 G2	
99	Special version, to be specified	
030	Flange Material	
2	316L	
3	Steel	
7	Polypropylene	
99	Special version, to be specified	

The versions entered make up the order code:

	010	020	030
FAU70E -			

FAU70A Version with conical thread

010	Process Connection	
22	2" 150 lbs FF, flange ANSI B16.5	
24	3" 150 lbs FF, flange ANSI B16.5	
25	4" 150 lbs FF, flange ANSI B16.5	
99	Special version, to be specified	
020	Sensor Connection	
5	Thread NPT1-1/2	
6	Thread NPT2	
99	Special version, to be specified	
030	Flange Material	
2	316L	
3	Steel	
7	Polypropylene	
99	Special version, to be specified	

The versions entered make up the order code:

	010	020	030
FAU70A -			

Slip-on flange FAU80

The sensors (FDU91F, FDU80F, FDU81F) can be flush mounted using a FAU80 slip-on flange. Flanges in polypropylene (PP) should only be used with pressures up to 1.5 bar_{abs} (22 psi) flanges in 316L also above.

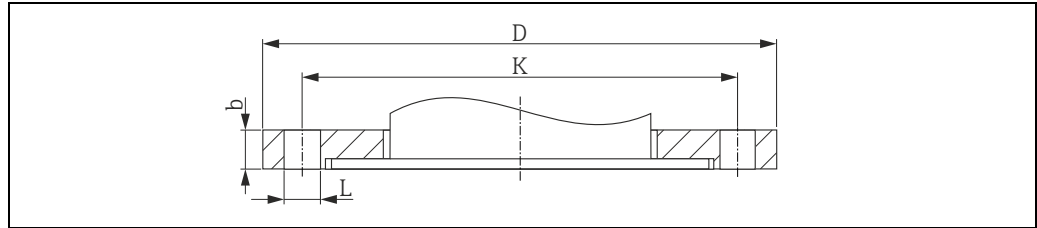

A0029186

Details to dimension "Mechanical Construction" → 40

FAU80 Version slip-on flange Order information

010	Process Connection	
AA	3" 150 lbs FF, flange ANSI B16.5	
AH	4" 150 lbs FF, flange ANSI B16.5	
CA	DN 80 PN16 A, flange EN1092-1 (DIN2527 B)	
CH	DN 100 PN16 A, flange EN1092-1 (DIN2527 B)	
KA	10K 80A FF, flange JIS B2220	
KH	10K 100A FF, flange JIS B2220	
YY	Special version, to be specified	
020	Flange Material	
J	316L	
P	PPs, max. 1.5 bar abs	
Y	Special version, to be specified	

The versions entered make up the order code:

	010	020
FAU80 -		

Screw in flange FAX50

The screw in flange is an universal flange. On the basis of dimensions min./max. it can be used for all three standards (DIN - ASME - JIS).

FAX50 universal flange DIN-ASME-JIS

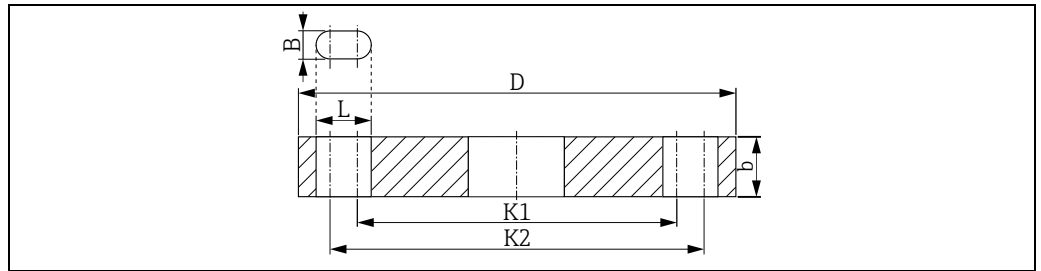

- L Diameter of holes
- K1, K2 Diameter of hole circle
- D Flange diameter
- b Total flange thickness
- B Slotted hole (width)

A0029185

G 3/4", NPT 3/4"

In following tables, the dimensions are indicated in mm (in) unless otherwise noted.

DN	D	b	L	K1	K2	approx. kg (lbs)		
						PP	PVDF	316L
50	165 (6.50)	20 (0.79)	4xØ19 (0.75)	120 (4.72)	125 (4.92)	-	-	3.11 (6.86)
80	200 (7.87)		8xØ19 (0.75)	150 (5.91)	160 (6.30)	-	-	4.37 (9.64)
100	228.6 (9.0)		8xØ19 (0.75)	175 (6.89)	190.5 (7.5)	-	-	5.79 (12.77)

G 1", NPT 1"

DN	D	b	L	K1	K2	approx. kg (lbs)		
						PP	PVDF	316L
80	200 (7.87)	20 (0.79)	8xØ19 (0.75)	150 (5.91)	160 (6.30)	0.50 (1.10)	0.97 (2.14)	4.34 (9.57)
100	228.6 (9.0)		8xØ19 (0.75)	175 (6.89)	190.5 (7.5)	0.66 (1.46)	1.29 (2.84)	5.75 (12.68)
150	285 (11.2)		8xØ23 (0.91)	240 (9.45)	241.3 (9.5)	1.09 (2.40)	2.12 (4.67)	9.44 (20.82)
200 ¹⁾	340 (13.4)		12xØ23 (0.91)	290 (11.4)	295 (11.6)	1.53 (3.37)	-	-
250	406.4 (16.0)		12xØ26 (1.02)	355 (14.0)	362 (14.3)	2.20 (4.85)	-	-

1) Only for DIN und JIS!

Exception G 1"

NPS (Nominal pipe size)	D	b	L	K1	K2	approx. kg (lbs)		
ASME						PP	PVDF	316L
8"	342.9 (13.5)	20 (0.79)	8xØ22.5 (0.89)	298.5 (11.8)	298.5 (11.8)	1.61 (3.55)	-	-

G 1½", NPT 1½"

DN	D	b	L	K1	K2	approx. kg (lbs)		
						PP	PVDF	316L
50	165 (6.50)	20 (0.79)	4xØ19 (0.75)	120 (4.72)	125 (4.92)	0.34 (0.75)	0.67 (1.48)	2.97 (6.55)
80	200 (7.87)		8xØ19 (0.75)	150 (5.91)	160 (6.30)	0.49 (1.08)	0.95 (2.09)	4.24 (9.35)
100	228.6 (9.0)		8xØ19 (0.75)	175 (6.89)	190.5 (7.5)	0.65 (1.43)	1.27 (2.80)	5.65 (12.46)
150	285 (11.2)		8xØ23 (0.91)	240 (9.45)	241.3 (9.5)	1.08 (2.38)	2.09 (4.61)	9.34 (20.59)

G 2", NPT 2"

DN	D	b	L	K1	K2	approx. kg (lbs)		
						PP	PVDF	316L
50	165 (6.50)	20 (0.79)	4xØ19 (0.75)	120 (4.72)	125 (4.92)	0.33 (0.73)	0.63 (1.39)	2.83 (6.24)
80	200 (7.87)		8xØ19 (0.75)	150 (5.91)	160 (6.30)	0.47 (1.04)	0.92 (2.03)	4.10 (9.04)
100	228.6 (9.0)		8xØ19 (0.75)	175 (6.89)	190.5 (7.5)	0.64 (1.41)	1.24 (2.73)	5.51 (12.15)
150	285 (11.2)		8xØ23 (0.91)	240 (9.45)	241.3 (9.5)	1.06 (2.34)	2.06 (4.54)	9.20 (20.29)

Order information FAX50

015		Material:
BR1	DN50 PN10/16 A, steel flange EN1092-1	
BS1	DN80 PN10/16 A, steel flange EN1092-1	
BT1	DN100 PN10/16 A, steel flange EN1092-1	
JF1	2" 150lbs FF, steel flange ANSI B16.5	
JG1	3" 150lbs FF, steel flange ANSI B16.5	
JH1	4" 150lbs FF, steel flange ANSI B16.5	
JK2	8" 150lbs FF, PP max 3 bar abs/44 psia flange ANSI B16.5	
XIF	UNI flange 2"/DN50/50, PVDF max 4 bar abs/58 psia, suitable for 2" 150 lbs/DN50 PN16/10K 50	
XIG	UNI flange 2"/DN50/50, PP max 4 bar abs/58 psia, suitable for 2" 150 lbs/DN50 PN16/10K 50	
XIJ	UNI flange 2"/DN50/50, 316L max 4 bar abs/58 psia, suitable for 2" 150 lbs/DN50 PN16/10K 50	
XJF	UNI flange 3"/DN80/80, PVDF max 4 bar abs/58 psia, suitable for 3" 150 lbs/DN80 PN16/10K 80	
XJG	UNI flange 3"/DN80/80, PP max 4 bar abs/58 psia, suitable for 3" 150 lbs/DN80 PN16/10K 80	
XJJ	UNI flange 3"/DN80/80, 316L max 4 bar abs/58 psia, suitable for 3" 150 lbs/DN80 PN16/10K 80	
XKF	UNI flange 4"/DN100/100, PVDF max 4 bar abs/58 psia, suitable for 4" 150 lbs/DN100 PN16/10K 100	
XKG	UNI flange 4"/DN100/100, PP max 4 bar abs/58 psia, suitable for 4" 150 lbs/DN100 PN16/10K 100	
XKJ	UNI flange 4"/DN100/100, 316L max 4 bar abs/58 psia, suitable for 4" 150 lbs/DN100 PN16/10K 100	
XLF	UNI flange 6"/DN150/150, PVDF max 4 bar abs/58 psia, suitable for 6" 150 lbs/DN150 PN16/10K 150	
XLG	UNI flange 6"/DN150/150, PP max 4 bar abs/58 psia, suitable for 6" 150 lbs/DN150 PN16/10K 150	
XLJ	UNI flange 6"/DN150/150, 316L max 4 bar abs/58 psia, suitable for 6" 150 lbs/DN150 PN16/10K 150	
XMG	UNI flange DN200/200, PP max 4 bar abs/58 psia, suitable for DN200 PN16/10K 200	
XNG	UNI flange DN250/250, PP max 4 bar abs/58 psia, suitable for DN250 PN16/10K 250	
YYY	Special version	

020		Sensor Connection:
A	Thread ISO228 G3/4	
B	Thread ISO228 G1	
C	Thread ISO228 G1-1/2	
D	Thread ISO228 G2	
E	Thread ANSI NPT3/4	
F	Thread ANSI NPT1	
G	Thread ANSI NPT1-1/2	
H	Thread ANSI NPT2	
Y	Special version	

The versions entered make up the order code:

	15	20
FAX50 -		



71330227

www.addresses.endress.com
