

Additional Units Kitchen Brochure 2019

If you contact Symphony's Additional Unit team then please provide the following information.

PLOT NUMBER:

SITE CODE:

(5 digit code available from your Builder, e.g. SY600)

HOUSEBUILDER NAME:

SITE NAME:

SITE ADDRESS:

SITE POSTCODE:

Symphony®





Choose from a stunning range of stylish bedroom furniture

To see our exciting range of luxury fitted bedroom furniture and sliding wardrobes simply visit your nearest Urbano studio. To locate your local retailer please visit our website or call our helpline using the details below.

There you can see for yourself the marvellous quality and stylish designs that are available. The professional design consultants at

Urbano retailers will be happy to provide a full planning and design service.

Urbano brochure line
and nearest retailer details
01226 446000 or visit
www.symphony-group.co.uk/urbano

urbano®

by Symphony®

Visit www.symphony-group.co.uk/dealer-locator to identify your local retailer



Enjoy all the benefits of a beautifully fitted bathroom

Why not complete the picture in your brand new home with beautifully fitted furniture in your bathroom too? Symphony's Aquadi range of luxury fitted bathrooms can be found in showrooms throughout the UK who are staffed by experts more than willing to help turn your dreams into a reality.

Whether you want a whole new suite or simply to enhance your existing bathroom with additional

units or complementary features, they'll be more than happy to help you with the planning and design.

Aquadi brochure line
and nearest retailer details
01226 446000 or visit
www.symphony-group.co.uk/aquadi

aquadi®

by Symphony®

Designed with you in mind

The Symphony kitchen in your new home has been built to the highest standards by one of the country's largest and most respected manufacturers of quality fitted furniture.

Designed with flair and installed with the greatest attention to detail, we are confident you will be happy with its stylish appearance and durability for many years to come.

However, we're also sure that you'll want your new kitchen to reflect your particular tastes and lifestyle, whilst meeting all your individual requirements.

We know that many new homeowners like to tailor the kitchen further to reflect your lifestyle and requirements, that's why we offer a wide choice of additional furniture, accessories and decorative

features - from wall or base units for extra storage, through to glazed worktop standing dresser cabinets to display your favourite possessions. In addition, there are alternative handles, internal storage, pull out wirework and decorative lighting to name a few options.

Simply tell us your ideas and we'll help you create the kitchen you want. After all - you're unique, so your kitchen should be too.

Whilst you will discover a world of options in this brochure, these products form only a section of our full offer. To view our full portfolio please visit www.symphony-group.co.uk or speak to our Additional Units team on 01226 446610. We wish you every success in your new home.



Call 01226 446610 or
email additional.units@symphony-group.co.uk

All dimensions in the specification document are in millimetres.

CONTENTS

IDENTIFY YOUR KITCHEN	6 - 23	PLINTHS	54, 60
CORNER UNITS	24 - 25	CORNICE AND PELMET	57 - 58
ISLAND CONFIGURATIONS	26 - 27	SPICE DRAWERS	59
BASE UNITS	28 - 32	GLASS SHELVING	61
WALL UNITS	33 - 37	UPSTANDS AND SPLASHBACKS	61
BOILER AND BASE APPLIANCE HOUSINGS	38	WORKTOPS AND ACCESSORIES	62
2100MM HIGH UNITS	39 - 44	ACCESSORIES	63 - 68
2276MM HIGH UNITS	45 - 50	FITTINGS	69
INTEGRATED APPLIANCE DOORS	51	LIGHTING	70 - 74
MID HEIGHT UNITS	52	FRONTALS	75
WORKTOP DRESSER UNITS	53	GENERAL INFORMATION	76 - 87
PANELS	54 - 56, 60		

HOW TO SPECIFY AND ORDER YOUR ADDITIONAL UNITS

Please browse through this brochure to identify the items that you would like to order. The ordering checklist provided on the back page details all the information that is needed to order your required products to complete your kitchen.

Please note that the product range included in this brochure does not reflect our entire product offer.

To view the full offer please visit www.symphony-group.co.uk, or call our team on 01226 446610.



Our Additional Units team is on hand to ensure you can order your additions easily. Simply follow the steps below.



IDENTIFYING YOUR KITCHEN UNITS

When planning your additional units please ensure you have the correct measurements. The following pages will assist you in identifying the information you require when ordering your additional kitchen units. Please use the fold out page at the back of the brochure as a checklist.



REQUEST A QUOTE

When you are ready to request a quote or to discuss your order with us please contact us on **01226 446610** or email **additional.units@symphony-group.co.uk**.

IMPORTANT INFORMATION

Please ensure that you inform us of the following information about your property:

PLOT NUMBER:

SITE CODE:

(5 digit code available from your Builder, e.g. SY600)

HOUSEBUILDER NAME:

SITE NAME:

SITE ADDRESS:

SITE POSTCODE:



PLACE AN ORDER

All orders are processed by phone so when you are ready to place an order please contact us on **01226 446610**. We accept payment for your additional units order by either credit/debit card or cheque.



DELIVERY

Our standard delivery time is 3 weeks. Please note that you will need to arrange the fitting of your additional units as we offer these on a supply only basis and do not offer a fitting service.

Your additional units will be delivered to an address of your choice. You will need to arrange for an authorised person to be present at the time of delivery to sign for the order and provide access to your property. Our team will offload and take your additional units into the property. The majority of units are supplied in an assembled format, although certain units have to be supplied ready for assembly due to their size and/or construction. Please also note that to ensure the safe transit of assembled units some items may be supplied loose such as legs and handles.

NOTE

All cabinets should be fitted by a competent/qualified fitter, all electrical work should be undertaken by a qualified electrician and all plumbing work should be undertaken by a qualified plumber.

STEP 1 IDENTIFY YOUR CABINET

Koncept 18mm Excel and 15mm Vista are the most popular cabinet specification in new homes. Please note this does not represent our entire product offer, to view the full portfolio please visit www.symphony-group.co.uk or call our team on 01226 446610.

**KONCEPT
15MM VISTA CABINETS**

Internal cabinet finished in white with a choice of external cabinet colours and Cream drawer box.



Shelf Bracket

**KONCEPT
18MM EXCEL CABINETS**

Fully co-ordinated interior and exterior cabinet colours and Cream drawer box.



Shelf Bracket

IDENTIFY YOUR CABINET

Gallery 18mm cabinets include co-ordinated interior and exterior colours with integrated soft close hinges and drawer runners as standard.

GALLERY 18MM STANDARD AND PREMIUM CABINETS

Fully co-ordinated interior and exterior cabinet colours. (Premium cabinets shown).



Gallery standard includes 3mm hardboard backs on wall units, with wall unit depths being 285mm. Gallery Premium includes 8mm solid backs on wall units, with wall unit depths being 330mm. Both Standard and Premium cabinets have Silver drawer boxes.



Shelf Bracket

STEP 2 IDENTIFY YOUR DRAWER

SUPRA DRAWER BOX

Colour: Cream
 Cabinets: 15mm Vista and 18mm Excel
 Soft close: optional upgrade



ATIRA DRAWER BOX

Colour: Grey
 Cabinets: 18mm Excel and Gallery
 Soft Close: As standard



STEP 3 IDENTIFY YOUR HINGE

**KONCEPT
 TITUS 110° STANDARD**



**KONCEPT
 TITUS 110° SOFTPLUS**



**GALLERY
 SENSYS 110° SOFTCLOSE**



170° versions of the above hinges are also available

STEP 4 IDENTIFY YOUR CABINET COLOUR

All our ranges are available with a choice of cabinet colours.



IVORY



BLODE OAK



WHITE

The majority of ranges offer frontal-matched replacement cabinet ends on 18mm Excel and Gallery cabinets. This is an alternative solution to using blender panels to create a fully co-ordinated kitchen.

*Cabinet shown is a White cabinet with Avola Grey replacement ends.
 (Door removed to show contrasting interior).*

STEP 5 IDENTIFY YOUR KITCHEN RANGE

Identify or choose your range from our most popular kitchen choices shown below. Please note this does not represent our entire product offer, to view the full portfolio please visit www.symphony-group.co.uk, or call our team on 01226 446610.

PAINT TO ORDER DOORS - GALLERY BRANDED KITCHENS ONLY



Alta Paint To Order
18mm Matt
Painted MDF.
See colour chart



Ashbourne
Paint To Order
18mm Grained Painted
Foil Wrapped with
chamfered frame.
See colour chart



Austin Paint To Order
20mm Ash Veneered
Frame with Veneered
Centre Panel.
See colour chart



New England
Paint To Order
22mm Painted Ash
Veneered Frame with
Veneered Centre Panel.
See colour chart



New York Paint To Order
22mm Matt Painted MDF



Wexford Paint To Order
20mm Ash Veneered
Frame with Veneered
Centre Panel



Anthracite Cashmere Clay Cobble Grey Cooks Blue Dove Grey Duck Egg Blue Indigo Ivory* Platinum Pumice Sage Skylon Grey Snow White Stone

*Ivory is only available in Wexford.

CONTEMPORARY DOORS



Alta Gloss Dusk Grey
18mm gloss painted and
lacquered MDF door



Alta Gloss Mussel
18mm gloss painted and
lacquered MDF door



Alta Gloss Pearl Grey
18mm gloss painted and
lacquered MDF door



Alta Gloss Pure White
18mm gloss painted and
lacquered MDF door



Alta Matt Anthracite
18mm matt painted
MDF door



Alta Matt Dark Walnut
18mm timber effect
MDF door with
1mm PVC-edging



Alta Matt Pure White
18mm matt painted
MDF door



Alta Matt Rustic Oak
18mm timber effect
MDF door with
1mm PVC-edging



Hacienda Champagne
18mm flat panel MFC
door with matching
PVC edging



Hacienda Ivory
18mm flat panel MFC
door with matching
PVC edging



Hacienda White Ash
18mm flat panel MFC
door with matching
PVC edging



Medford White
18mm Flat panel MFC
door with white PVC
edging



Minnesota
18mm Avola Grey
Textured MFC door with
matching PVC edging



New York Gloss
Cashmere
22mm gloss painted and
lacquered MDF door

IDENTIFY YOUR KITCHEN RANGE



New York Gloss Dusk Grey
22mm gloss painted and lacquered MDF door



New York Gloss Ivory
22mm gloss painted and lacquered MDF door



New York Gloss Pearl Grey
22mm gloss painted and lacquered MDF door



New York Gloss White
22mm gloss painted and lacquered MDF door



New York Matt Anthracite
(Gallery only)
22mm gloss painted and lacquered MDF door



Plaza Cashmere
18mm Cashmere MFC grained panel door with matching PVC edging



Plaza Cobble Grey
18mm Cobble Grey MFC grained panel door with matching PVC edging



Plaza Mussel
18mm Mussel MFC grained panel door with matching PVC edging

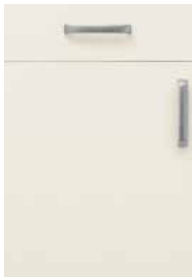

Plaza Porcelain
18mm Porcelain MFC grained panel door with matching PVC edging



Plaza Stone
18mm Stone MFC grained panel door with matching PVC edging



Quadra Cobble Grey
18mm Matt PVC Pressed MDF



Quadra White
18mm Matt PVC Pressed MDF



Virginia Oak
18mm Oak effect MFC flat panel door with matching PVC edging



Woodbury Anthracite
18mm Gloss painted MFC



Woodbury Cashmere
18mm Gloss painted MFC



Woodbury Ivory
18mm Gloss painted MFC



Woodbury Platinum
18mm Gloss painted MFC



Woodbury White
18mm Gloss painted MFC

IDENTIFY YOUR KITCHEN RANGE

CLASSIC DOORS



Oakham Oak
20mm Shaker style door with oak veneered frame and centre panel



Austin Ivory
20mm Shaker style painted ivory door with ash veneered frame and centre panel



Ashbourne Ivory
18mm grained shaker style foil wrapped MDF with chamfered frame



Cranbrook Cobble Grey
22mm foil wrapped MDF door in shaker style



Cranbrook Ivory
22mm foil wrapped MDF door in shaker style



Cranbrook Platinum
22mm foil wrapped MDF door in shaker style



Cranbrook Sage
22mm foil wrapped MDF door in shaker style



Cranbrook Stone
22mm foil wrapped MDF door in shaker style



Georgia Oak
22mm shaker style Oak foil wrapped MDF door



Newport Ivory
18mm Ivory PVC wrapped door with tongue and grooved centre panel



Calgary White
18mm White PVC wrapped door with tongue and grooved centre panel



Oregon White
18mm White PVC foil wrapped saponetta edged door



Oregon Cream
18mm Cream PVC foil wrapped saponetta edged door



Oregon Dove Grey
18mm Grey PVC foil wrapped saponetta edged door

GLAZED DOORS



Alta - frosted glass



Ashbourne - clear glass



Austin - clear glass



Calgary - clear glass



Cranbrook - clear glass



Georgia - textured glass



Metallic effect framed door - textured glass



Premium glazed Aluminium framed - frosted glass



Newport - plank effect frosted glass



New York - frosted glass



Oakham - clear glass

IDENTIFY YOUR KITCHEN RANGE

Inline kitchens present a modern linear style of kitchen design that features a stunning handle trim to the edge of doors and drawers. There is a choice of a brushed aluminium trim or a chrome wave trim.

INLINE SELECT

Gloss Dusk Grey
18mm gloss painted and lacquered MDF door



Cabinet Exterior: White

Gloss Mussel
18mm gloss painted and lacquered MDF door

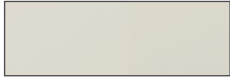

Cabinet Exterior: Ivory

Gloss Pearl Grey
18mm gloss painted and lacquered MDF door

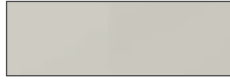

Cabinet Exterior: White

Gloss Pure White
18mm gloss painted and lacquered MDF door

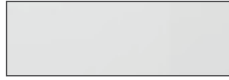

Cabinet Exterior: White

Matt Anthracite
18mm matt painted MDF door



Cabinet Exterior: White

Matt Dark Walnut
18mm timber effect MDF door with 1mm PVC-edging



Cabinet Exterior: White

Matt Pure White
18mm matt painted MDF door



Cabinet Exterior: White

Matt Rustic Oak
18mm timber effect MDF door with 1mm PVC-edging



Cabinet Exterior: White

INLINE TREND

Gloss Ice Anthracite
18mm Gloss painted MFC door



Cabinet Exterior: White

Gloss Ice Cashmere
18mm Gloss painted MFC door



Cabinet Exterior: White

Gloss Ice Ivory
18mm Gloss painted MFC door



Cabinet Exterior: Ivory

Gloss Ice Platinum
18mm Gloss painted MFC door



Cabinet Exterior: White

Gloss Ice White
18mm Gloss painted MFC door



Cabinet Exterior: White

INLINE FORM

Matt Avola Champagne
18mm Flat panel MFC door with matching PVC edging



Cabinet Exterior: Ivory

Matt Avola Grey Textured
18mm textured MFC door with matching PVC edging



Cabinet Exterior: White

Matt Avola Ivory
18mm flat panel MFC door with matching PVC edging



Cabinet Exterior: Ivory

Matt Avola White Ash
18mm flat panel MFC door with matching PVC edging



Cabinet Exterior: White

Matt Oak
18mm MFC door with matching PVC edging



Cabinet Exterior: Blonde Oak

Matt Cashmere Textured
18mm MFC textured panel door with flat matching PVC edging

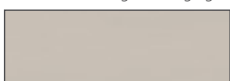

Cabinet Exterior: White

Matt Cobble Grey Textured
18mm MFC textured panel door with flat matching PVC edging



Cabinet Exterior: White

Matt Mussel Textured
18mm MFC textured panel door with flat matching PVC edging

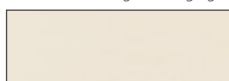

Cabinet Exterior: Ivory

Matt Porcelain Textured
18mm MFC textured panel door with flat matching PVC edging



Cabinet Exterior: White

Matt Stone Textured
18mm MFC textured panel door with flat matching PVC edging

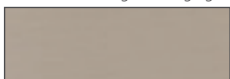

Cabinet Exterior: Ivory

Aluminium Inline Handle



Black Inline Handle



Chrome Wave Inline Handle





Identify or choose your handle from our most popular handle choices shown below. Please note this does not represent our entire product offer, to view the full portfolio please visit www.symphony-group.co.uk or call our team on 01226 446610.

Key: K = Konzept G = Gallery

Matt Nickel D Handle with Oval Feet
Handle Centres: 128mm

K

Code
HPK226

188mm Matt Nickel Bar Handle
Handle Centres: 128mm

K

Code
HPK275

Matt Nickel Grooved Bar Handle
Handle Centres: 128mm

K

Code
HPK279

Matt Nickel Square D Handle
Handle Centres: 128mm

K

Code
HPK296

Matt Nickel Soft Formed
Handle Centres: 160mm

K

Code
HPK331

Matt Nickel Long Square D
Handle Centres: 192mm

K

Code
HPK334

Pewter Square D handle
Handle Centres: 128mm

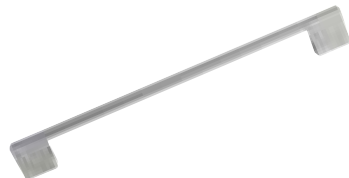
K

Code
HPK337

Matt Nickel Chunky D handle
Handle Centres: 160mm

K

Code
HPK354

Iron D handle
Handle Centres: 128mm

K

Code
HPK404

Satin Nickel Bow Handle
Handle Centres: 160mm

K

Code
HPK433

Polished chrome D handle
Handle Centres: 160mm

K G

Code
HPK445

Brushed nickel barrel D
Handle Centres: 160mm

K G

Code
HPK630

Matt Brushed Nickel Arched
Handle Centres: 160, 192mm

K G

Code
HPK631

Square Chrome Bar Handle
Handle Centres: 192mm

G

Code
HPK634

Chrome Arched 'D' Handle
Handle Centres: 160mm

K

Code
HPK639

IDENTIFY YOUR HANDLE

Chrome Chunky Bridge
Handle Centres: 160mm

K G



Code _____
HPK640

Chrome Bow Handle
Handle Centres: 128mm

K



Code _____
HPK641

Chrome Square D Handle
Handle Centres: 128mm

K G



Code _____
HPK642

Brushed Nickel Bow Handle.
Handle Centres: 160mm

K G



Code _____
HPK643

Matt Nickel Square D Handle
Handle Centres: 160mm

K G



Code _____
HPK644

Brushed Nickel Arched Handle
Handle Centres: 160mm

K



Code _____
HPK645

Matt Nickel Bar Handle
Handle Centres: 160mm

K



Code _____
HPK646

Matt Nickel Bow Handle
Handle Centres: 128mm

K



Code _____
HPK647

Matt Nickel Wide Bow Handle
Handle Centres: 160mm

K



Code _____
HPK671

Grooved Pewter D Handle
Handle Centres: 128mm

K G



Code _____
HPK672

Gothic D Handle
Handle Centres: 160mm

G



Code _____
HPK346

Stainless Steel T Knob

G



Code _____
HPK440

Stainless Steel Cup Handle
Handle Centres: 64mm

G



Code _____
HPK441

Beehive Pewter Effect Knob

G



Code _____
HPK442

Pewter Wave D Handle
Handle Centres: 128mm

G



Code _____
HPK443

IDENTIFY YOUR HANDLE

Natural Iron Fluted Knob & Backplate



Code _____
 HPK464

Pewter Lamont D Handle
 Handle Centres: 96mm



Code _____
 HPK600

Stainless Steel Jupiter Knob



Code _____
 HPK637

Pewter Lamont Cup Handle
 Handle Centres: 64mm



Code _____
 HPK638

Grooved Pewter D Handle
 Handle Centres: 128mm



Code _____
 HPK672

Smoked Oak Yo-Yo Knob



Code _____
 HPK718

Aged Brass Effect Knob



Code _____
 HPK739

Aged Brass Effect Cup Handle
 Handle Centres: 64mm



Code _____
 HPK750

Aged Brass Effect D Handle
 Handle Centres: 128mm



Code _____
 HPK753

Aged Copper Sulky D Handle
 Handle Centres: 128mm



Code _____
 HPK751

Oil Rubbed Bronze Knob



Code _____
 HPK723

Brushed Brass Knob



Code _____
 HPK724

Traditional Chrome D Handle
 Handle Centres: 128mm



Code _____
 HPK752

Gloss White & Chrome D Handle
 Handle Centres: 160mm



Code _____
 HPK405

Satin Nickel Bow Handle
 Handle Centres: 128/224mm



Code _____
 HPK434

IDENTIFY YOUR HANDLE

Gloss Ivory & Chrome D Handle
Handle Centres: 160mm



Code _____
HPK435 _____

Chrome Swept D Handle
Handle Centres: 160mm



Code _____
HPK438 _____

Curve Box Polished Chrome Handle
Handle Centres: 160mm



Code _____
HPK445 _____

Satin Nickel Wedge Handle
Handle Centres: 128mm



Code _____
HPK446 _____

Satin Nickel Strap Handle
Handle Centres: 128/160/192/224mm



Code _____
HPK447 _____

Polished Chrome D Handle
Handle Centres: 160mm



Code _____
HPK448 _____

Asymmetric Chrome D Handle
Handle Centres: 192mm



Code _____
HPK462 _____

Elongated Satin Nickel Bow Handle
Handle Centres: 106/192mm



Code _____
HPK463 _____

Satin Nickel Grooved Bow Handle
Handle Centres: 160mm



Code _____
HPK465 _____

Nickel Arched D Handle
Handle Centres: 160mm



Code _____
HPK472 _____

Gloss Cashmere & Chrome D Handle
Handle Centres: 160mm



Code _____
HPK489 _____

Gloss Anthracite & Chrome D Handle
Handle Centres: 160mm

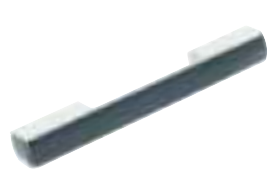

Code _____
HPK490 _____

Square Bar Polished Chrome Handle
Handle Centres: 96mm



Code _____
HPK493 _____

Chrome Circular Handle
Handle Centres: 96mm



Code _____
HPK609 _____

Vintage Nickel Pewter Handle
Handle Centres: 160mm



Code _____
HPK629 _____

IDENTIFY YOUR HANDLE

Iron D Handle
Handle Centres: 96mm



Code _____
HPK330

Satin Nickel Bridge Handle
Handle Centres: 320mm



Code _____
HPK721

Satin Nickel Bridge Handle
Handle Centres: 128mm



Code _____
HPK720

Modern Bright Chrome Bridge Handle
Handle Centres: 128mm



Code _____
HPK650

Modern Bright Chrome Bridge Handle
Handle Centres: 320mm



Code _____
HPK649

Modern Nickel Handle
Handle Centres: 160mm



Code _____
HPK651

Eight by Eight Nickel Handle
Handle Centres: 160mm



Code _____
HPK652

Chrome Basalt & Chrome D Handle
Handle Centres: 160mm

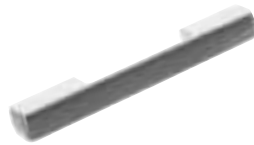

Code _____
HPK673

Chrome Satin & Nickel Handle
Handle Centres: 160mm



Code _____
HPK674

Modern Bright Chrome Offset Bridge Handle
Handle Centres: 228mm



Code _____
HPK681

Satin Nickel Offset Bridge Handle
Handle Centres: 228mm



Code _____
HPK719

Gloss Platinum & Chrome D Handle
Handle Centres: 160mm



Code _____
HPK695

Rialto Stainless Steel Handle
Handle Centres: 160mm



Code _____
HPK712

Brushed Nickel Angle Bridge Handle
Handle Centres: 160mm



Code _____
HPK714

Vintage Matt Black & Copper Bar Handle
Handle Centres: 160mm



Code _____
HPK727

IDENTIFY YOUR HANDLE

Graphite Osaka Pull Handle



Code	Size	Handle Centres
HPK728	Small	96mm
HPK729	Medium	160mm
HPK730	Large	320mm

Copper Osaka Pull Handle



Code	Size	Handle Centres
HPK731	Small	96mm
HPK732	Medium	160mm
HPK733	Large	320mm

Patterned Gunmetal Bar Handle



Code	Size	Handle Centres
HPK734	Medium	160mm
HPK735	Large	320mm

Antique Copper D Handle
Handle Centres: 160mm



Code _____
HPK754

Burbridge Brushed Brass D Handle
Handle Centres: 128mm



Code _____
HPK736

Libra 'Bullet' Handle
Handle Centres: 32mm



Code _____
HPK606

Chrome Concave D Handle



Code	Size	Handle Centres
HPK607	Medium	192mm
HPK608	Large	320mm

Traditional Antique Copper Knob



Code _____
HPK784

Traditional Antique Copper D Handle
Handle Centres: 128mm



Code _____
HPK785

IDENTIFY YOUR HANDLE

INSET HANDLE WALL UNITS

The inset handle which is available in selected ranges can be added to all wall units, bifolds and bridging cupboards and is to be combined with standard handles on base units to create a subtle, more streamlined design option for the modern kitchen.

To choose this handle option add IN to the end of the wall cabinet code e.g. WU672IN.



Inset Handle Range Availability	
Alta	Hacienda
Inline Form	Inline Select
Inline Trend	Medford
Minnesota	Virginia
Plaza	Woodbury

STEP 7 IDENTIFY YOUR UNITS

Have a look through the cabinets available and select the ones that suit your requirements whether it base, wall or larder cabinets needed to fit in the space available in your kitchen.

UNIT CODES

PREFIX LETTERS

These indicate the type of unit, such as BU for base unit; WU for wall unit; LU for larder unit; OH for oven housing unit.

NUMBERS

The numbers indicate the width of the unit followed either by the depth, or in case of wall units, the height. For example a WU1056 is a wall unit 1000mm wide and 561mm high. A BU56 is a base unit 500mm wide and 600mm deep.

SUFFIX LETTERS

Any letters following the number code indicate a variant of the type as follows:

A-K - variations of corner units or appliance housing formats

F - Full height door base unit

D - Drawer line base unit

DD - Single base unit or corner base unit with a dummy drawer

DAI - Double base unit with two dummy drawers

DAC - Double base unit with one dummy drawer

BO - Corner base unit with no corner post

BS - Corner base unit with dummy drawer and no corner post

FP - Corner base unit with flexible corner post

GL - Unit with left hand replacement end

GR - Unit with right hand replacement end

G2 - Unit with two replacement ends

IN - Inset Handle

STEP 8 SPECIFY YOUR UNIT HANDING IF REQUIRED

HANDINGS

Many units are described as left or right handed. Handings should be expressed as if looking at the unit from the front.

Handings required are:

- The side of the hinge on single units (e.g. left hand hinged)
- The side of the blanked end of corner units (e.g. left hand blanked)
- The position of the drainer on sink units (e.g. left hand drainer)
- The end position of a base wing end unit (e.g. left hand end)
- The side of a dummy drawer on a double base unit (e.g. left hand side)

STEP 9  **REMEMBER TO ORDER PLINTHS AND ACCESSORIES**

Specify any plinths and accessories such as cornice, pelmet, lighting, splashbacks and internal storage as required.

- 1 LED Strip Lights
- 2 Plinth Lights
- 3 LED Spot Lights
- 4 LED Square Lights
- 5 Plinth
- 6 Cornice
- 7 Pelmet
- 8 Upstand
- 9 Splashback



40MM LAMINATE WORKTOPS

Hard-wearing and stylish, our 40mm laminate worktops add the perfect finishing touch. Choose from a wide range of colours and designs, specifically developed to coordinate with the Konzept kitchen range. Worktops are supplied in a bullnose or PVC edged specification and are available with co-ordinating upstands, splashbacks and blenders.*

* maximum worktop length 4000mm

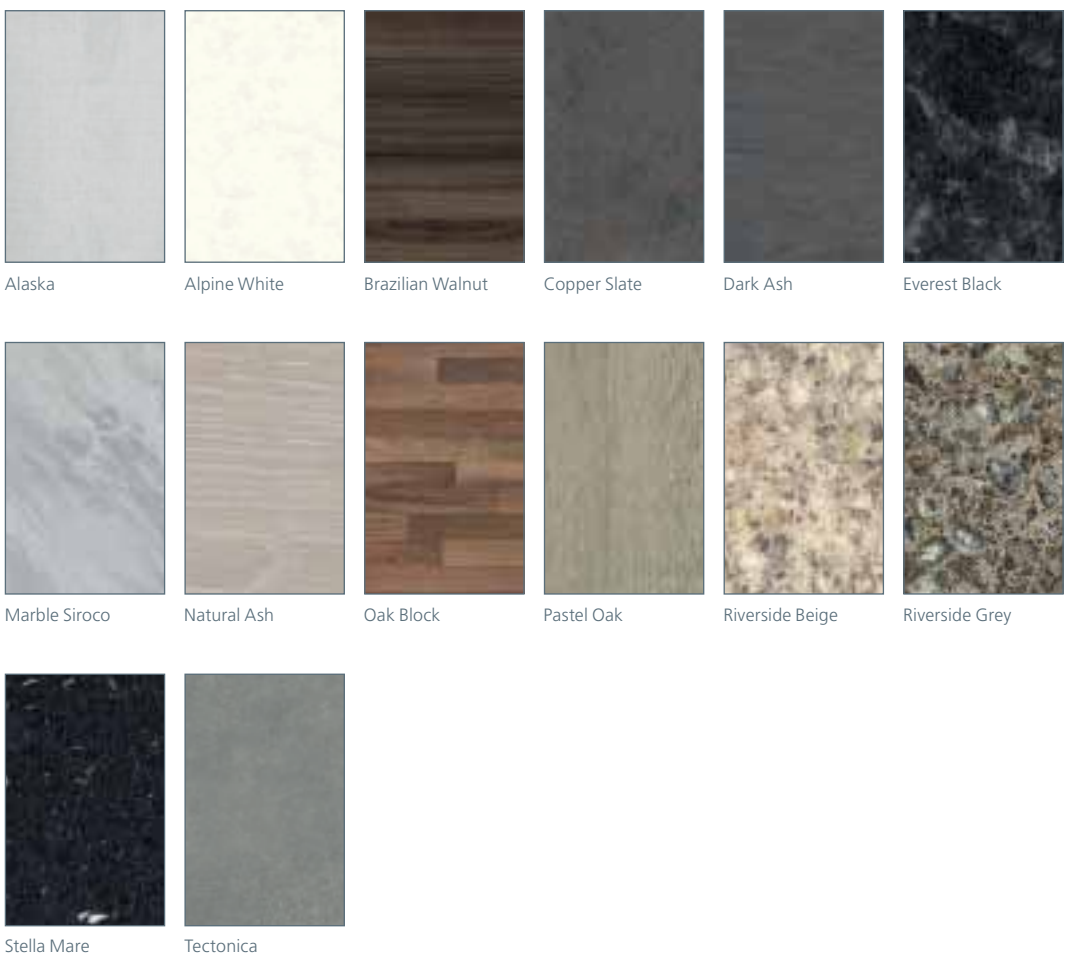

IDENTIFY YOUR WORKTOP

40MM PREMIUM WORKTOPS

Our premium 40mm worktops feature either textured or ultra smooth laminate finishes with a contemporary 3mm front radius providing a modern flat profile.

Worktops are available with co-ordinating worktop upstands and splashbacks.*

*maximum worktop length 3600mm



Chalet Oak



Cinnamon

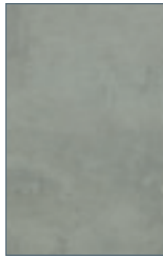

Cloudy Cement



Colmar Oak



Liberty Rock



Platinum Metallic



Roman Oak



Venice Marble



Volcanic Ash



Woodstone

22MM WORKTOP

These stunning 22mm worktops feature subtle textured surfaces and are the cutting edge of laminate worktop design. The colour palette includes finishes that match selected kitchen range decors to create an ultra modern one colour kitchen, or to provide another option for mix and match designs. Worktops are available with matching blenders, upstands and splashbacks.*

*maximum worktop length 3000mm



Brazillia

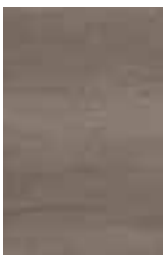

Dark Oak

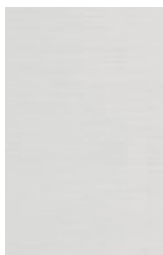

Designer White



Light Ash



Mystic Pine



Rustic Oak

STEP 11 IDENTIFY YOUR GLASS UPSTANDS AND SPLASHBACKS

A range of contemporary and subtle colours to suit any style of kitchen and complement our worktop selection.

STANDARD COLLECTION

This collection features the four core splashback colours.



Bride



Chalk White



Ebony

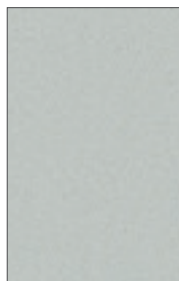

Pewter



GLOSS COLLECTION

Our Gloss Collection feature a diverse palette of colours that match and complement a variety of the kitchen finishes, accent open display units and include three metallic effect styles.

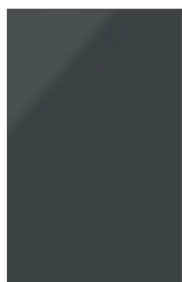

Anthracite



Blue

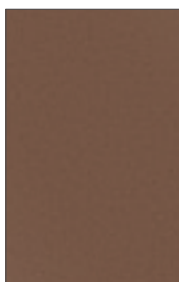

Bronze

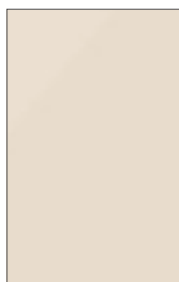

Cashmere



Dark Stone

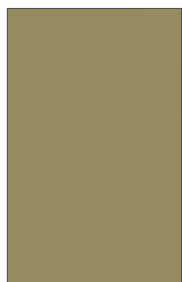

Gold

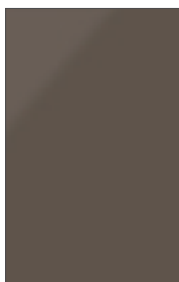

Lava

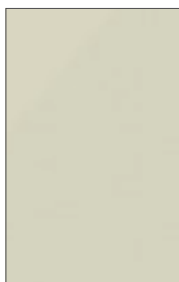

Light Stone



Midnight Stardust

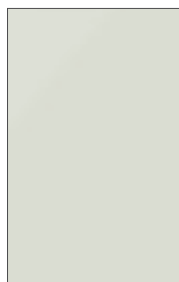

Platinum

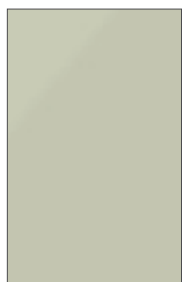

Sage

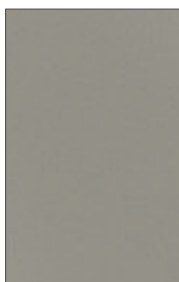

Silver

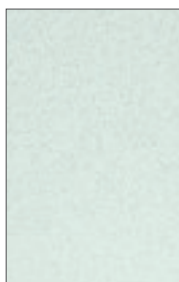

White Sparkle



Yellow

CORNER UNITS

All corner base units have centre hung doors with 110° hinges. Corner posts and blanking panels are fitted as standard. On corner base units with a corner post, a blanking panel covers the void of the unit.

A 600mm colour co-ordinated blanking panel is fitted where corner posts are NOT required - e.g. when the blank abuts a void for a freestanding appliance or tray space.

IMPORTANT: Please specify the handing of the side of the blanking panel when ordering.

Some of our corner base cabinets are available with a shelf or with a range of internal storage (not fitted). Storage options include Le Mans or a ½ Carousel.

Symphony's range of corner base units allows wide flexibility in the positioning of corner units for the clearance of water or soil vent pipes when required. Please specify the handing of the blanking panel side when ordering.

CORNER SINK BASE UNITS

1000mm corner base units can also be supplied as corner sink units. To specify a corner sink unit, change the prefix letters on the standard corner base unit code from 'CB' to 'CS' as shown in the example below.

Unit Code	Description
CS106DC	1000mm Corner Sink Base Cabinet, 600mm Door

L SHAPE CORNER BASE UNIT

A corner unit with either a shelf or a revolving carousel, supplied with 170° hinges. The two doors are hinged on the end panels. In order to facilitate transportation, the unit is supplied in two parts, one assembled and one ready for assembly (RFA) and the carousel or shelf must be fitted on site. Full height door or door and dummy drawer front styles are available. The dummy drawer fronts are fixed to the doors.

800mm Corner Base Cabinet

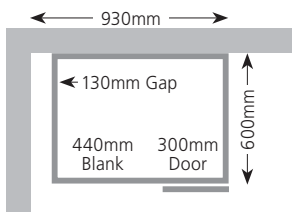

Full Height CB86FBFP
Drawer Line CB86DBFP

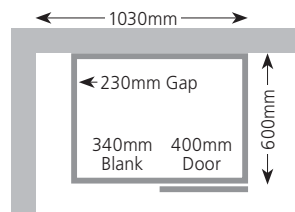

Full Height CB86FAFP
Drawer Line CB86DAFP

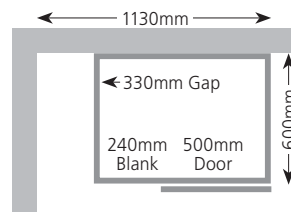

Full Height CB86FCFP
Drawer Line CB86DCFP

900mm Corner Base Cabinet

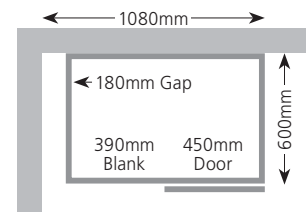

Full Height CB96FAFP
Drawer Line CB96DAFP

1000mm Corner Base Cabinet

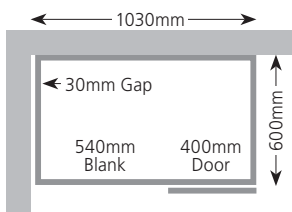

Full Height Door CB106FBFP
Drawer Line CB106DBFP

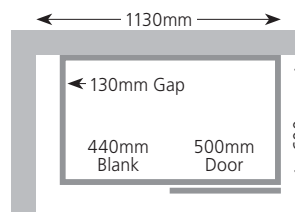

Full Height Door CB106FAFP
Drawer Line CB106DAFP

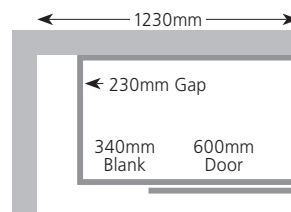

Full Height Door CB106FCFP
Drawer Line CB106DCFP

1200mm Corner Base Cabinet

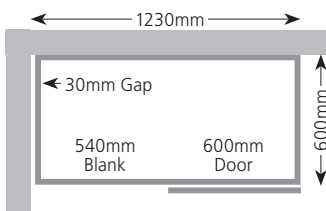

Full Height Door CB126FAFP
Drawer Line CB126DAFP

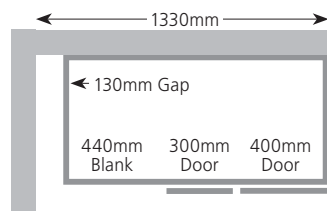

Full Height Door CB126FFFP
Drawer Line CB126DFFP

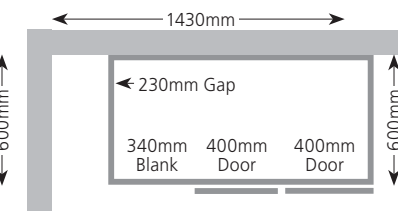

Full Height Door CB126FEFP
Drawer Line CB126DEFP

L Shaped Corner Base Cabinet

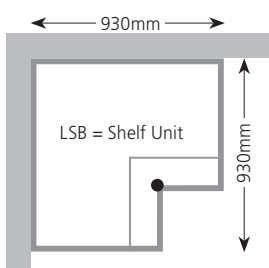

Full Height Door LSB99F
Drawer Line LSB99D

L Shaped Corner Base Cabinet with Carousel

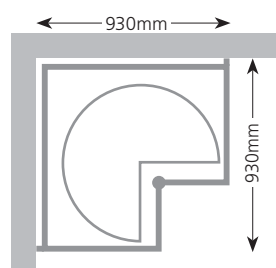

Full Height Door LCB99F
Drawer Line LCB99D

ONE PIECE CORNER POST

The corner post allows product ranges with protruding handles to be offset by 30mm in order to avoid possible clashing of drawer handles in a corner. The corner post automatically spaces out the units to the correct size across Dimension A (on Corner Post diagram below). However the fitter must remember to position the corner unit (as appropriate) from the wall. To order a one-piece corner post cabinet use the codes shown on subsequent pages without the suffix.

FLEXIBLE CORNER POSTS

A flexible corner post, allows for adjustment of the position of adjacent units in-situ. This allows the unit width to be increased by 70mm (note: the unit depth is not flexible). Flexible corner units are supplied with a fixed corner post panel, a fixed blanking panel and an adjustable corner post panel which is supplied loose. All flexible corner units will co-ordinate with the kitchen frontal. To order the flexible corner post please use the codes shown below which have 'FP' at the end of the code.

CORNER BASE UNITS VARIATIONS

A variety of corner base unit options are available, to order these, suffix the standard unit code as shown in the examples below.

Variation	Suffix	Unit Code	Description
One piece corner post	-	CB106DC	Corner base unit 1000 x 600 x 870. 600 door, one piece corner post
No corner post	BO	CB106DCBO	Corner base unit 1000 x 600 x 870. 600 door, no corner post
Dummy drawer with flexible corner post	DFP	CB106DADFP	Corner base unit 1000 x 600 x 870. 500 door, dummy drawer
No corner post and dummy drawer	BS	CB106DABS	Corner sink unit 1000 x 600 x 870. 500 door, no corner post, dummy drawer
Flexible corner post	FP	CB106DCFP*	Corner base unit 1000 x 600 x 870. 600 door, flexible corner post

* Please note that the flexible corner posts are not available on L-shaped cabinets, corner larder cabinets or 900mm high wall cabinets.

CORNER WALL CABINET

Conventional corner wall cabinets should be positioned 30mm from the return cabinet. If a corner post is supplied, this is to space out the return cabinet to avoid the clashing of protruding handles.

CORNER LARDER CABINET

Corner Larder Cabinets should be positioned 60mm from the return cabinet. The corner post, when fitted, will space out the cabinets to avoid the clash of handles. If the larder adjoins a base or wall cabinet, a full blanking panel (supplied) should be fitted.

Corner Post

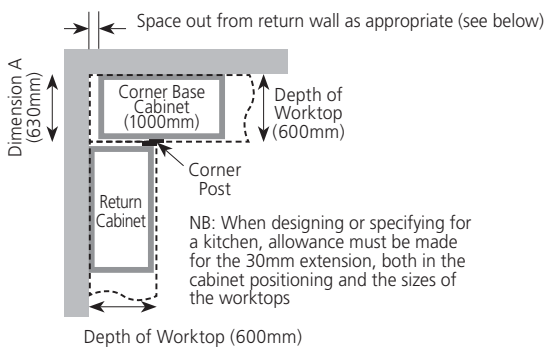

Corner Larder Cabinet

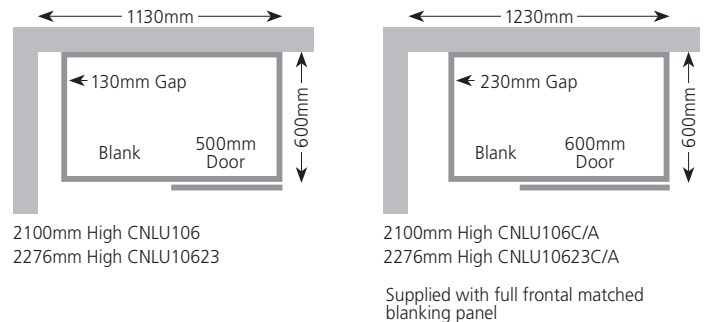

600mm Corner Wall Cabinet

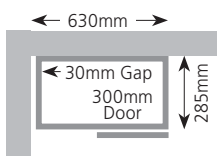

561mm High Door CWU656FP
724mm High Door CWU672FP
900mm High Door CWU690*

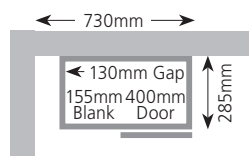

561mm High Door CWU656FBFP
724mm High Door CWU672FBFP
900mm High Door CWU690FB*

800mm Corner Wall Cabinet

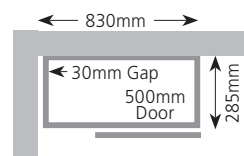

561mm High Door CWU856FAPP
724mm High Door CWU872FAPP
900mm High Door CWU890FA*

900mm Corner Wall Cabinet

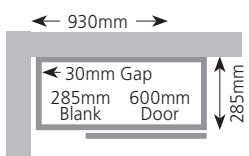

561mm High Door CWU956FCFP
724mm High Door CWU972FCFP
900mm High Door CWU990FC*

* Flexible corner post are not available with 900mm high corner cabinets. Instead order the standard code shown with additional panel. FRONTPNL90 to be cut down to suit on site.

Note: 18mm Corner posts are frontal matched. 15mm corner posts are cabinet matched.

All 'FP' codes are for frontal matched corner posts.

ISLAND CONFIGURATIONS

When designing an island, you need to think about the following:

- What do you want to use the island for?
- Is there enough space to comfortably move around, and open all the units?
- Is it possible to run services (e.g. gas or water) under the floor to the island?

MINIMUM DIMENSIONS

The recommended minimum distance in front of cabinet doors, drawers, and appliances, is between 1000mm and 1200mm. Between any other fixed points you should leave at least 750mm, to allow easy movement in between.

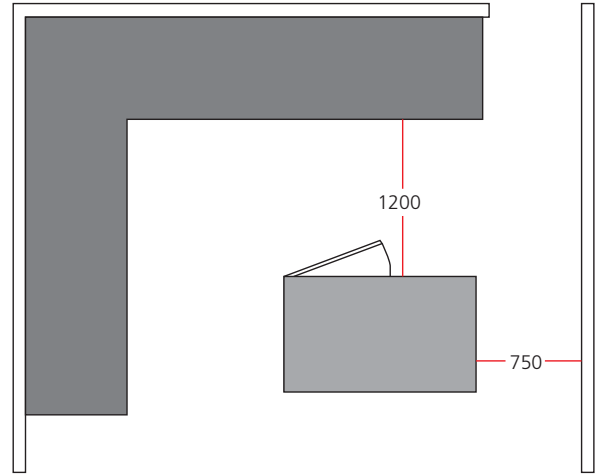

WORKTOP OPTIONS

The size of the worktop will affect the configuration of units that is possible.

Solid surface worktops, such as granite, Corian and timber, are made to order, and so are available in a variety of sizes. Speak to your solid surface supplier for more information.

Double post formed and fully PVC edged laminate worktops are available to buy in fixed widths of 665mm and 900mm. It is also possible to fit standard single edged worktops back to back to increase the size of the island.

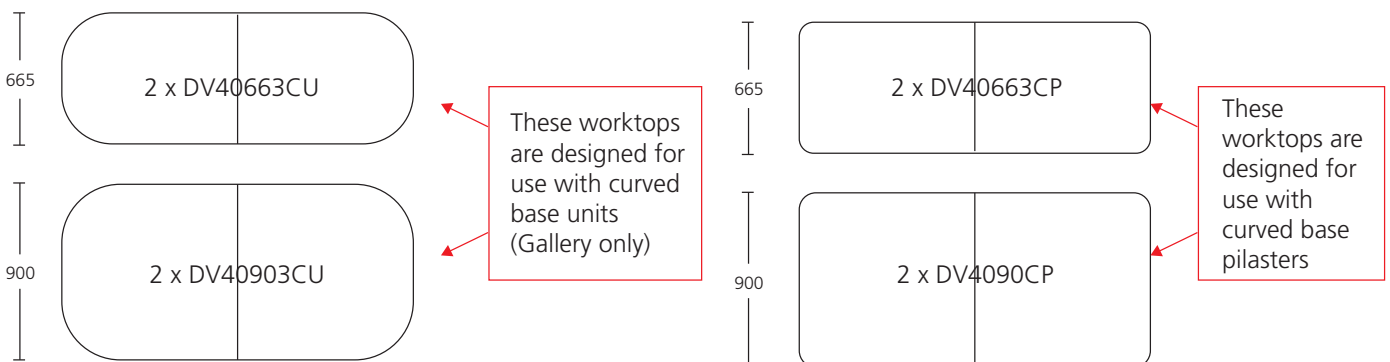
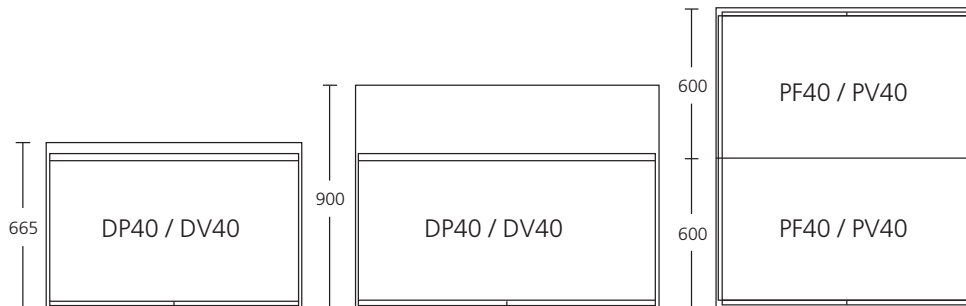

ISLAND DESIGN TIPS

- Any exposed back of a unit must be covered with a back panel (e.g. BBBP1892F), or another unit
- End panels are recommended on either end of a square island, for a neat finish
- If any of the cut edges of back panels will be visible, edging tape is required
- Worktop joints longer than 600mm require 2 x TOPSEALBOLT / TOPSEALBLT22
- For safety reasons, hobs must only be used in islands that have a minimum depth of 900mm

EXAMPLES

EXAMPLE 1

This is the simplest type of island. You can vary it by using different sizes and types of base unit, or by using frontal matched end and back panels.

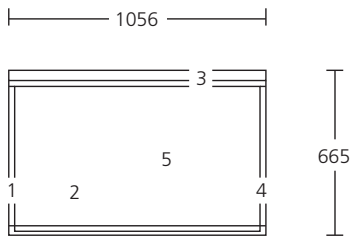

1,4	BBU6592C
2	BU106F
3	BBBP1892C
5	DP40 1056 x 665
	EDGESTRIP2210
	CONPLINTHC



EXAMPLE 2

This island uses a 900mm wide worktop to create a breakfast bar. You can vary it by using different sizes and types of base unit, or by using frontal matched end and back panels.

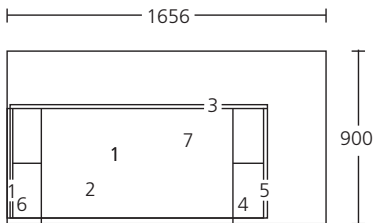

1,5	BBU6592C
2	PD106D3
3	BBBP1892C
4,6	SPWR15
7	DP40 1656 x 900
	EDGESTRIP2210
	CONPLINTHC



EXAMPLE 3 (GALLERY ONLY)

This island combines curved units and standard units. Curved plinth is supplied free of charge with the curved units. Two worktops with double curved ends are used end to end, so there will be a join in the middle of the island.

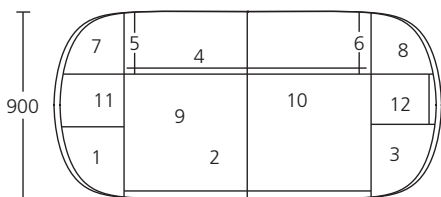

1,3,7,8	BISL372CU
2	BU126F
5,6	BWU390F
4	BBBP1892F
11,12	BU253F
9,10	DV40903CU
	2 x TOPSEALBOLT
	CONPLINTHC



CABINETS FULL HEIGHT DOOR BASE CABINETS

Reduced Depth Single Base Cabinet

Height: 870mm
Depth: 285mm
150mm not available in 15mm Vista
Single adjustable shelf.
Hand by hinge.

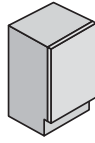

Width	Code
150mm	BU1503F
300mm	BU33F
400mm	BU43F
450mm	BU453F
500mm	BU53F
600mm	BU63F

Reduced Depth Double Base Cabinet

Height: 870mm
Depth: 285mm
Single adjustable shelf.

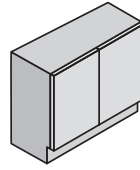

Width	Code
800mm	BU83F
900mm	BU93F
1000mm	BU103F

Single Base Cabinet

Height: 870mm
Depth: 570mm
150mm not available in 15mm Vista
Single adjustable shelf.
Hand by hinge.

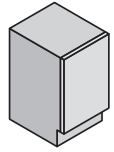

Width	Code
150mm	BU1506F
300mm	BU36F
400mm	BU46F
450mm	BU456F
500mm	BU56F
600mm	BU66F

Single Base Cabinet with Pull Out Basket

Height: 870mm
Depth: 570mm
Available in 18mm only
Chrome pull out basket to be fitted on site.



150mm Pull Out Base Units

Width	Code
150mm (Excel)	BU1506BAF
150mm (Gallery)	BU1506BAFAR

Double Base Cabinet

Height: 870mm
Depth: 570mm
Single adjustable shelf.

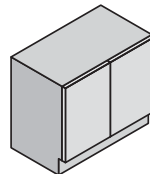

Width	Code
800mm	BU86F
900mm	BU96F
1000mm	BU106F
1200mm	BU126F

Corner Cabinet

Height: 870mm
Depth: 570mm
Single adjustable shelf.
Hand by blank, right hand blank shown.
110° hinges.
Add 'FP' suffix for a frontal matched flexible corner post.
Add 'BO' suffix for no corner post.

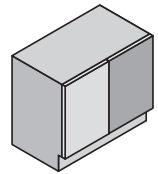

Width	Code
800mm 300 Door	CB86FB
800mm 400 Door	CB86FA
800mm 500 Door	CB86FC
900mm 450 Door	CB96FA

Corner Cabinet

Height: 870mm
Depth: 570mm
Single adjustable shelf.
Hand by blank, right hand blank shown.
110° hinges.
Add 'FP' suffix for a frontal matched flexible corner post.
Add 'BO' suffix for no corner post.

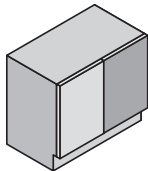

Width	Code
1000mm 400 Door	CB106FB
1000mm 500 Door	CB106FA
1000mm 600 Door	CB106FC
1200mm 600 Door	CB126FA

Corner Cabinet

Height: 870mm
Depth: 570mm
Single adjustable shelf.
Hand by blank, right hand blank shown.
110° hinges.
Add 'FP' suffix for a frontal matched flexible corner post.
Add 'BO' suffix for no corner post.

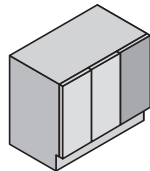

Width	Code
1200mm 300 and 400mm Doors	CB126FF
1200mm Two 400 Doors	CB126FE

L Shaped Corner Cabinet

Height: 870mm
Depth: 570mm
Supplied in 2 parts, one part RFA, one part assembled.
Single adjustable shelf.
LCB99F is supplied with chrome 3/4 carousel - to be fitted on site.
170° hinges

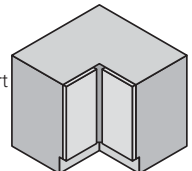

Width	Code
930x930mm	LSB99F
930x930mm with Carousel	LCB99F

45° Base Cabinet

Height: 870mm
Depth: 570mm
Single adjustable shelf.
Hand by hinge, left hand cabinet shown.
400mm door.
For soft close doors order FPK903.
Supplied RFA.

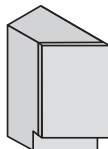

Width	Code
300mm	DBU36F45

CABINETS DRAWER LINE BASE CABINETS

Reduced Depth Single Base Cabinet

Height: 870mm
Depth: 285mm
Dummy drawer.
Single adjustable shelf.
Hand by hinge.
Not available in Inline.

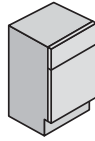

Width	Code
300mm	BU33D
400mm	BU43D
450mm	BU453D
500mm	BU53D
600mm	BU63D

Double Reduced Depth Base Unit

Height: 870mm
Depth: 285mm
Two dummy drawers.
Single adjustable shelf.
Not available in Inline.

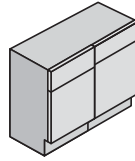

Width	Code
800mm	BU83D
900mm	BU93D
1000mm	BU103D

Single Base Cabinet

Height: 870mm
Depth: 570mm
Single drawer.
Single adjustable shelf.
Hand by hinge.
Not available in Inline.

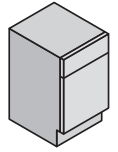

Width	Code
300mm	BU36D
400mm	BU46D
450mm	BU456D
500mm	BU56D
600mm	BU66D

Double Base Cabinet

Height: 870mm
Depth: 570mm
Two drawers.
Single adjustable shelf.
Not available in Inline.

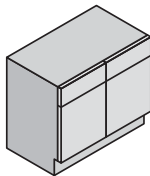

Width	Code
800mm	BU86D
900mm	BU96D
1000mm	BU106D
1200mm	BU126D

Corner Cabinet

Height: 870mm
Depth: 570mm
Single drawer.
Single adjustable shelf.
Hand by blank, right hand blank shown.
110° hinges.
Add 'FP' suffix for a frontal matched flexible corner post.
Add 'BO' suffix for no corner post.
Not available in Inline.

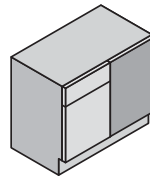

Width	Code
800mm 300 Door	CB86DB
800mm 400 Door	CB86DA
800mm 500 Door	CB86DC
900mm 450 Door	CB96DA

Corner Cabinet

Height: 870mm
Depth: 570mm
Single drawer.
Single adjustable shelf.
Hand by blank, right hand blank shown.
110° hinges.
Add 'FP' suffix for a frontal matched flexible corner post.
Add 'BO' suffix for no corner post.
Not available in Inline.

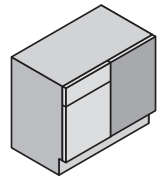

Width	Code
1000mm 400 Door	CB106DB
1000mm 500 Door	CB106DA
1000mm 600 Door	CB106DC
1200mm 600 Door	CB126DA

Corner Cabinet

Height: 870mm
Depth: 570mm
Two drawers.
Single adjustable shelf.
Hand by blank, right hand blank shown.
110° hinges.
Add 'FP' suffix for a frontal matched flexible corner post.
Add 'BO' suffix for no corner post.
Not available in Inline.

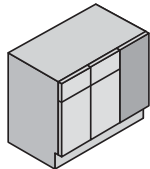

Width	Code
1200mm 300 and 400 Doors	CB126DF
1200mm Two 400 Doors	CB126DE

L Shaped Corner Cabinet

Height: 870mm
Depth: 570mm
Two dummy drawers.
Single adjustable shelf.
Supplied in 2 parts, one part RFA, one part assembled.
LCB99D is supplied with chrome 3/4 carousel - to be fitted on site.
Not available in Inline.
170° hinges.

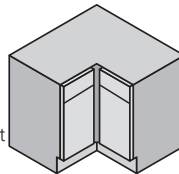

Width	Code
930x930mm	LSB99D
930x930mm with Carousel	LCB99D

45° Base Cabinet

Height: 870mm
Depth: 570mm
Dummy drawer.
Hand by hinge, left hand cabinet shown.
400mm door.
Not available in Inline.
Supplied RFA.

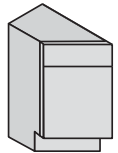

Width	Code
300mm	DBU36D45

CABINETS SINK & HOB BASE CABINETS

Single Full Height Sink Cabinet

Height: 870mm
Depth: 570mm
Supplied with Sink Liner.
Single adjustable shelf.
Hand by hinge.
For full height sink units without sink liners order standard base unit codes.

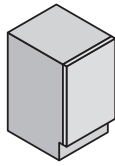

Width	Code
500mm	SU56SLF
600mm	SU66SLF

Double Full Height Sink Cabinet

Height: 870mm
Depth: 570mm
Supplied with Sink Liner.
Single adjustable shelf.
For full height sink units without sink liners order standard base unit codes.

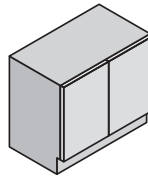

Width	Code
800mm	SU86SLF
900mm	SU96SLF
1000mm	SU106SLF
1200mm	SU126SLF

Single Drawer Line Sink Cabinet

Height: 870mm
Depth: 570mm
With dummy drawer (159mm high).
Supplied with Sink Liner.
Single adjustable shelf.
Hand by hinge.
Not available in Inline.

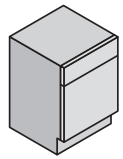

Width	Code
500mm	SU56SLD
600mm	SU66SLD

Double Drawer Line Sink Cabinet

Height: 870mm
Depth: 570mm
With one dummy drawer (159mm high).
Supplied with Sink Liner.
Hand by drainer i.e. left hand (LHD) supplied with right hand dummy drawer.
Single adjustable shelf.
Not available in Inline.

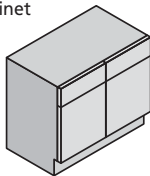

Width	Code
800mm	SU86SLD
900mm	SU96SLD
1000mm	SU106SLD
1200mm	SU126SLD

Double Drawer Line Sink Cabinet

Height: 870mm
Depth: 570mm
With two dummy drawers (159mm high).
Supplied with Sink Liner.
Single adjustable shelf.
Not available in Inline.

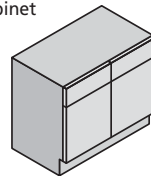

Width	Code
800mm	SU86SLDAI
900mm	SU96SLDAI
1000mm	SU106SLDAI
1200mm	SU126SLDAI

Single Drawer Line Sink Cabinet

Height: 870mm
Depth: 570mm
With dummy drawer (159mm high).
Single adjustable shelf.
Hand by hinge.
Not available in Inline.

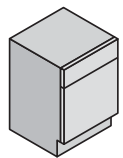

Width	Code
500mm	SU56DDD
600mm	SU66DDD

Double Drawer Line Sink Cabinet

Height: 870mm
Depth: 570mm
With one dummy drawer (159mm high).
Hand by drainer i.e. left hand (LHD) supplied with right hand dummy drawer.
Single adjustable shelf.
Not available in Inline.

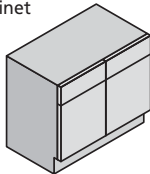

Width	Code
800mm	SU86D
900mm	SU96D
1000mm	SU106D
1200mm	SU126D

Double Drawer Line Sink Cabinet

Height: 870mm
Depth: 570mm
With two dummy drawers (159mm high).
Single adjustable shelf.
Not available in Inline.

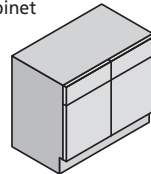

Width	Code
800mm	SU86DAI
900mm	SU96DAI
1000mm	SU106DAI
1200mm	SU126DAI

Sink Cabinet Three Drawer

Height: 870mm
Depth: 570mm
With dummy top drawer (159mm high) and middle and bottom cut away drawers (276mm high).
Not available in 15mm Vista.
Supplied with Atira drawer box.
Check sink depth. Maximum sink depth 220mm plus worktop thickness.

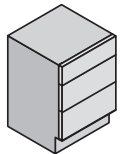

Width	Code
800mm	PD86D3SU3
900mm	PD96D3SU3
1000mm	PD106D3SU3

Sink Cabinet Two Drawer

Height: 870mm
Depth: 570mm
With top and bottom cut away drawers (358mm high).
Not available in 15mm Vista.
Not available in Calgary and Newport.
Supplied with Atira drawer box.
Check sink depth. Not compatible with undermount sinks.
Maximum sink depth 140mm plus worktop thickness.

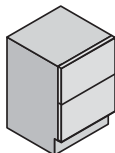

Width	Code
800mm	PD86D2SU2
900mm	PD96D2SU2

Belfast Sink Cabinet

Height: 600mm
Depth: 570mm
Supplied with Sink Liner.
Cabinet not compatible with laminate worktops.
Supplied with 47mm fascia panel.
Hand by hinge.
Not available in Inline.
Suitable for use with the Blanco Belfast Sink BL468008.

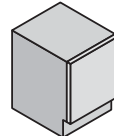

Width	Code
600mm	BSU66SLF

Four Drawer Cabinet

Height: 870mm
Depth: 570mm
With dummy top drawer (159mm high) and three deeper drawers (183mm high).
Not available in Inline.

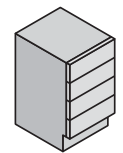

Width	Code
400mm	DU46DAQ
500mm	DU56DAQ
600mm	DU66DAQ

CABINETS DRAWER BASE CABINETS

Four Drawer Cabinet

Height: 870mm
Depth: 570mm

With one shallow drawer (159mm high) and three deeper drawers (183mm high).

Not available in Inline.

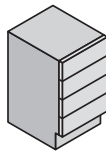

Width	Code
400mm	DU46D
500mm	DU56D
600mm	DU66D

Full Height Door with 4 Shallow Internal Drawers

Height: 870mm
Depth: 570mm
Hand by hinge.

Full height door.

With four Atira internal drawers (108mm high). Suitable for cutlery trays 50mm smaller than the cabinet. Trays available for 450, 500 and 600 width cabinets, see pages 64-65 for details.

For Konzept the soft close buffer SMOVE1170 is supplied automatically for soft close doors to be used in place of the standard buffer.

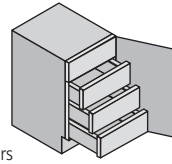

Width	Code
300mm	BU36F4ID
400mm	BU46F4ID
450mm	BU456F4ID
500mm	BU56F4ID
600mm	BU66F4ID

Full Height Door with 1 Shallow, 2 Deep Internal Drawers

Height: 870mm
Depth: 570mm
Hand by hinge.

Full height door.

With one Atira internal shallow drawer (108mm high) and two Atira internal deep drawers (187mm high). Suitable for cutlery trays 50mm smaller than the cabinet. Trays available for 450, 500 and 600 width cabinets, see pages 64-65 for details. For Konzept the soft close buffer SMOVE1170 is supplied automatically for soft close doors to be used in place of the standard buffer.

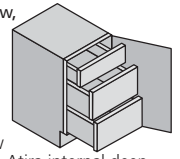

Width	Code
300mm	BU36F3IDC
400mm	BU46F3IDC
450mm	BU456F3IDC
500mm	BU56F3IDC
600mm	BU66F3IDC

Full Height Pull-out Drawer with 1 Shallow and 2 Deep Internal Drawers

Height: 870mm
Depth: 570mm

Full height frontal attached to a deep internal drawer, with one shallow internal (108mm high) drawer and one deep internal drawer (187mm high).

Suitable for 600mm cutlery tray, see pages 64-65 for details.

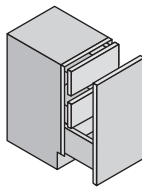

Width	Code
600mm	BU66F2ID

Three Drawer Cabinet

Height: 870mm
Depth: 570mm

With one shallow drawer (159mm high) and two pan drawers (276mm high).

Not available in 15mm Vista.

The two pan drawers on 800, 900 and 1000 widths supplied with Atira drawer box.

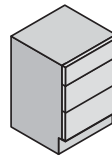

Width	Code
500mm	PD56D3
600mm	PD66D3
800mm	PD86D3
900mm	PD96D3
1000mm	PD106D3

Two Drawer Cabinet

Height: 870mm
Depth: 570mm

With two deep pan drawers (358mm high).

Not available in 15mm Vista.

Not available in Calgary and Newport.

800 and 900 widths supplied with Atira drawer box.

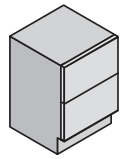

Width	Code
500mm	PD56D2
600mm	PD66D2
800mm	PD86D2
900mm	PD96D2
1000mm	PD106D2

Two Drawer Cabinet

Height: 870mm
Depth: 570mm

With two deep pan drawers (358mm high) and internal top drawer (92mm high).

Not available in 15mm Vista.

Not available in Calgary and Newport.

800 and 900 widths supplied with Atira drawer box.

All widths supplied with Atira internal drawer boxes.

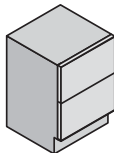

Width	Code
500mm	PD56D2IDT
600mm	PD66D2IDT
800mm	PD86D2IDT
900mm	PD96D2IDT
1000mm	PD106D2IDT

CABINETS FEATURE BASE CABINETS

Wicker Basket Cabinet

Height: 870mm
Depth: 570mm
Available in melamine cabinet colours.
Not available in 15mm Vista.
Not available in Inline.

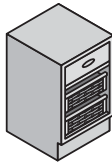

Width	Code
500mm	WBU56D

Accent Base Open Display Units

Height: 870mm
Depth: 285mm
Available in 18mm MFC matt colours: Blue, Cashmere, Dark Oak, Light Ash, Stone and Yellow.

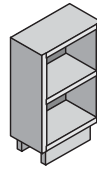

Width	Code
500mm	ODUB572AC
600mm	ODUB672AC

Spice and Wine Rack Cabinet

Height: 870mm
Depth: 285mm
Four wine racks – holds up to 12 bottles.
Available in melamine cabinet colours.
Not available in 15mm Vista.

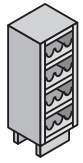

Width	Code
300mm Melamine	BWR3

Spice and Wine Rack Cabinet

Height: 870mm
Depth: 285mm
Five wine slots.
Available in melamine cabinet colours.
Not available in 15mm Vista.

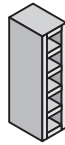

Width	Code
150mm Melamine	SPWR15

Plate Rack Cabinet

Height: 870mm
Depth: 285mm
Available in melamine cabinet colours.
Not available in 15mm Vista.
Not available in Inline.

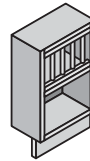

Width	Code
500mm Melamine	ODMB85

Lattice Wine Rack Cabinet

Height: 870mm
Depth: 285mm
Available in melamine cabinet colours.
Not available in 15mm Vista.
Not available in Inline.

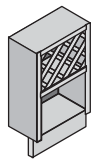

Width	Code
500mm Melamine	ODMB95

Plate and Lattice Wine Rack Cabinet

Height: 870mm
Depth: 285mm
Available in melamine cabinet colours.
Not available in 15mm Vista.
Not available in Inline.

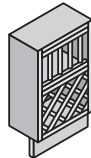

Width	Code
500mm Melamine	ODMB105

Drop Down Cabinet

Height: 362mm
Depth: 285mm
Can be used with 362 high Accent open bridging units (see page 37).
Only available in selected Inline and Contemporary ranges only.
Order pack of 4 legs separately (LEG15) and plinth to create base cabinet arrangements.

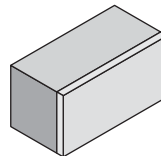

Width	Code
500mm	OCH536D
600mm	OCH636D
800mm	OCH836D
900mm	OCH936D
1000mm	OCH1036D

CABINETS 561MM HIGH STANDARD & FEATURE WALL CABINETS

KONCEPT AND GALLERY STANDARD SPECIFICATIONS SHOWN.
GALLERY PREMIUM VERSIONS ARE AVAILABLE AT A DEPTH OF 330MM.

Single 561mm Wall Cabinet

Height: 561mm
Depth: 285mm
One adjustable shelf.
Hand by hinge.

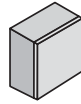

Width	Code
300mm	WU356
400mm	WU456
450mm	WU4556
500mm	WU556
600mm	WU656

Single 561mm Wall Cabinet with Inset Handle

Height: 561mm
Depth: 285mm
One adjustable shelf.
Hand by hinge.
Available in selected Inline and Contemporary ranges only. See page 19.

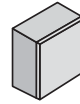

Width	Code
300mm	WU356IN
400mm	WU456IN
450mm	WU4556IN
500mm	WU556IN
600mm	WU656IN

Double 561mm Wall Cabinet

Height: 561mm
Depth: 285mm
One adjustable shelf.

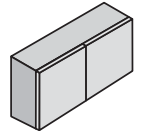

Width	Code
800mm	WU856
900mm	WU956
1000mm	WU1056

Double 561mm Wall Cabinet with Inset Handle

Height: 561mm
Depth: 285mm
One adjustable shelf.
Available in selected Inline and Contemporary ranges only. See page 19.

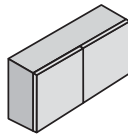

Width	Code
800mm	WU856IN
900mm	WU956IN
1000mm	WU1056IN

Canopy Extractor Wall Cabinet

Height: 561mm
Depth: 285mm
Designed to suit the standard Zanussi canopy extractor ZHG51250GA. Includes ducting.
Hand by hinge.
Not available in 15mm Vista.
Supplied on a white cabinet only.

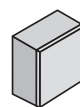

Width	Code
600mm	CANWUJEX656

Canopy Extractor Wall Cabinet with Inset Handle

Height: 561mm
Depth: 285mm
Designed to suit the standard Zanussi canopy extractor ZHG51250GA. Includes ducting.
Hand by hinge.
Available in selected Inline and Contemporary ranges only. See page 19.
Not available in 15mm Vista.
Supplied on a white cabinet only.

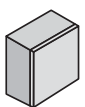

Width	Code
600mm	CANWUJEX656IN

Corner Wall Cabinet

Height: 561mm
Depth: 285mm
One adjustable shelf.
Hand by blank, right hand blank shown.
15mm cabinets are supplied with 170° hinges (for soft close doors order SOFTCL170) and 18mm cabinets with 110° hinges (for soft close doors order SMOVE1110).
'FP' suffix for a frontal matched flexible corner post.
Available in selected Inline and Contemporary ranges only. See page 19.

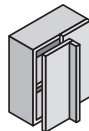

Width	Code
600mm 300 Door	CWU656
600mm 400 Door	CWU656FB
800mm 500 Door	CWU856FA
900mm 600 Door	CWU956FC

Corner Wall Cabinet with Inset Handle

Height: 561mm
Depth: 285mm
One adjustable shelf.
Hand by blank, right hand blank shown.
15mm cabinets are supplied with 170° hinges (for soft close doors order SOFTCL170) and 18mm cabinets with 110° hinges (for soft close doors order SMOVE1110).
'FP' suffix for a frontal matched flexible corner post.
Available in selected Inline and Contemporary ranges only. See page 19.

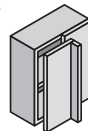

Width	Code
600mm 300 Door	CWU656IN
600mm 400 Door	CWU656INFB
800mm 500 Door	CWU856INFA
900mm 600 Door	CWU956INFC

Open Wall Cabinet

Height: 561mm
Depth: 285mm
Single fixed shelf.
Available in melamine cabinet colours.

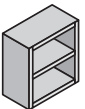

Width	Code
500mm Melamine	ODU556

Accent Open Wall Display Cabinet

Height: 561mm
Depth: 285mm
Single fixed shelf.
Available in 18mm MFC matt colours: Blue, Cashmere, Dark Oak, Light Ash, Stone and Yellow.

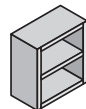

Width	Code
500mm	ODU556AC
600mm	ODU656AC

CABINETS 724MM HIGH STANDARD WALL CABINETS

KONCEPT AND GALLERY STANDARD SPECIFICATIONS SHOWN.
GALLERY PREMIUM VERSIONS ARE AVAILABLE AT A DEPTH OF 330MM.

Single Wall Cabinet

Height: 724mm
Depth: 285mm
Single adjustable shelf (15mm Vista).
Two adjustable shelves (18mm Excel and Gallery).
150mm not available in 15mm Vista.
Hand by hinge.

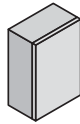

Width	Code
150mm	WU15072
255mm (Gallery Premium only)	WU2572
300mm	WU372
400mm	WU472
450mm	WU4572
500mm	WU572
600mm	WU672

Single Wall Cabinet with Inset Handle

Height: 724mm
Depth: 285mm
Single adjustable shelf (15mm Vista).
Two adjustable shelves (18mm Excel and Gallery).
150mm not available in 15mm Vista.
Hand by hinge.
Available in selected Inline and Contemporary ranges only. See page 19.

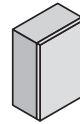

Width	Code
150mm	WU15072IN
255mm (Gallery Premium only)	WU2572IN
300mm	WU372IN
400mm	WU472IN
450mm	WU4572IN
500mm	WU572IN
600mm	WU672IN

Double Wall Cabinet

Height: 724mm
Depth: 285mm
Single adjustable shelf (15mm Vista). Two adjustable shelves (18mm Excel and Gallery).

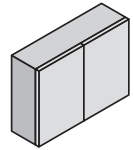

Width	Code
800mm	WU872
900mm	WU972
1000mm	WU1072

Double Wall Cabinet with Inset Handle

Height: 724mm
Depth: 285mm
Single adjustable shelf (15mm Vista).
Two adjustable shelves (18mm Excel and Gallery).
Available in selected Inline and Contemporary ranges only. See page 19.

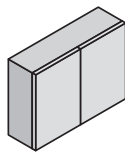

Width	Code
800mm	WU872IN
900mm	WU972IN
1000mm	WU1072IN

Bi-fold Wall Cabinet

Height: 724mm
Depth: 285mm
Single adjustable shelf.
Not available in 15mm Vista.

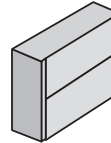

Width	Code
500mm	HFUW572
600mm	HFUW672
800mm	HFUW872
900mm	HFUW972

Bi-fold Wall Cabinet with Inset Handle

Height: 724mm
Depth: 285mm
Single adjustable shelf.
Not available in 15mm Vista.
Available in selected Inline and Contemporary ranges only. See page 19.

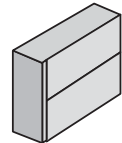

Width	Code
500mm	HFUW572IN
600mm	HFUW672IN
800mm	HFUW872IN
900mm	HFUW972IN

Canopy Extractor Wall Cabinet

Height: 724mm
Depth: 285mm
Design to suit the standard Zanussi canopy extractor ZHG51250GA. Includes ducting.
Hand by hinge.
18mm Excel and Gallery white cabinet only.

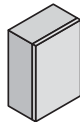

Width	Code
600mm	CANWUEX672

Canopy Extractor Wall Cabinet with Inset Handle

Height: 724mm
Depth: 285mm
Design to suit the standard Zanussi canopy extractor ZHG51250GA. Includes ducting.
Hand by hinge.
Available in selected Inline and Contemporary ranges only. See page 19.
18mm Excel and Gallery white cabinet only.

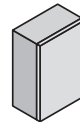

Width	Code
600mm	CANWUEX672IN

Corner Wall Cabinet

Height: 724mm
Depth: 285mm
Two adjustable shelves.
Hand by blank, right hand blank shown.
15mm cabinets are supplied with 170° hinges (for soft close doors order SOFTCL170) and 18mm cabinets with 110° hinges (for soft close doors order SMOVE1110).
'FP' suffix for a frontal matched flexible corner post.

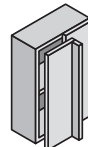

Width	Code
600mm 300 Door	CWU672
600mm 400 Door	CWU672FB
800mm 500 Door	CWU872FA
900mm 600 Door	CWU972FC

Corner Wall Cabinet with Inset Handle

Height: 724mm
Depth: 285mm
Two adjustable shelves.
Hand by blank, right hand blank shown.
15mm cabinets are supplied with 170° hinges (for soft close doors order SOFTCL170) and 18mm cabinets with 110° hinges (for soft close doors order SMOVE1110).
'FP' suffix for a frontal matched flexible corner post.
Available in selected Inline and Contemporary ranges only. See page 19.

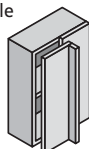

Width	Code
600mm 300 Door	CWU672IN
600mm 400 Door	CWU672INFB
800mm 500 Door	CWU872INFA
900mm 600 Door	CWU972INFC

Microwave Wall Cabinet

Height: 724mm
Depth: 330mm
296 door
47 fascia
358 aperture
This unit is deeper than standard wall units so will not line up. Check microwave dimensions before ordering. Typically 17 litre microwaves suit this housing. Maximum appliance dimensions 406mm high x 564mm wide.
The fascia panel may require scribing to suit the microwave. Supplied with Aluminium fascia cap (OHUCAP6) - Supplied loose. Not available in Inline.

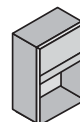

Width	Code
600mm	MWU672

CABINETS 724MM HIGH FEATURE WALL CABINETS

KONCEPT AND GALLERY STANDARD SPECIFICATIONS SHOWN.
GALLERY PREMIUM VERSIONS ARE AVAILABLE AT A DEPTH OF 330MM.

Glazed Wall Cabinet

Height: 724mm
Depth: 285mm
Two adjustable glass shelves.
See page 11 for glazed cabinet availability.
Hand by hinge.
Not available in 15mm Vista.
Not available in Inline.
110° hinges.



Width	Code
400mm	GDU472
500mm	GDU572

Metallic Framed Glazed Wall Cabinet

Height: 724mm
Depth: 285mm
Two adjustable glass shelves.
Hand by hinge.
Not available in 15mm Vista.
For soft close doors order SOFTCLOSEGL
Not available in Inline.



Width	Code
400mm	GDU472SL
500mm	GDU572SL

Accent Open Wall Display Cabinet

Height: 724mm
Depth: 285mm
Single fixed shelf.
Available in 18mm MFC matt colours: Blue, Cashmere, Dark Oak, Light Ash, Stone and Yellow.

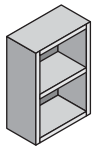

Width	Code
500mm	ODU572AC
600mm	ODU672AC

Spice and Wine Rack Wall Cabinet

Height: 724mm
Depth: 285mm
Four wine racks – holds up to 12 bottles.
Available in melamine cabinet colours.
Not available in 15mm Vista.

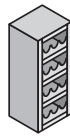

Width	Code
300mm Melamine	WWR372

Spice and Wine Rack Cabinet

Height: 724mm
Depth: 285mm
Five wine slots.
Available in melamine cabinet colours.
Not available in 15mm Vista.

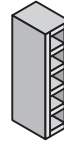

Width	Code
150mm Melamine	SPWR15

Open Wall Cabinet

Height: 724mm
Depth: 285mm
Single fixed shelf.
Available in melamine cabinet colours.

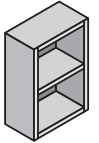

Width	Code
300mm Melamine	ODU372
400mm Melamine	ODU472
500mm Melamine	ODU572
600mm Melamine	ODU672

Three Spice Drawer Wall Cabinet

Height: 724mm
Depth: 285mm
Available in melamine cabinet colours.
Beech drawers.
Drawer frontals available in melamine cabinet colours.
Not available in 15mm Vista.
Not available in Inline.

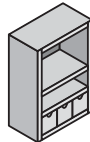

Width	Code
500mm Melamine	ODMW3572

Plate Rack Wall Cabinet

Height: 724mm
Depth: 285mm
Available in melamine cabinet colours.
Not available in 15mm Vista.
Not available in Inline.

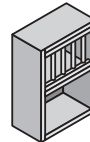

Width	Code
500mm Melamine	ODMW8572

Lattice Wine Rack Wall Cabinet

Height: 724mm
Depth: 285mm
Available in melamine cabinet colours.
Not available in 15mm Vista.
Not available in Inline.

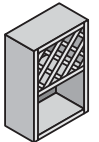

Width	Code
500mm Melamine	ODMW9572

Plate and Lattice Wine Rack Wall Cabinet

Height: 724mm
Depth: 285mm
Available in melamine cabinet colours.
Not available in 15mm Vista.
Not available in Inline.

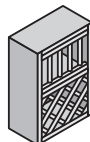

Width	Code
500mm Melamine	ODMW10572

Open Display Wall Cabinet Frame

Height: 724mm
Available in Blonde Oak, Ivory and Painted Ivory.
Not available in Inline.



Width	Code
500mm	ODUFRAME

CABINETS 900MM HIGH STANDARD & FEATURE WALL CABINETS

KONCEPT AND GALLERY STANDARD SPECIFICATIONS SHOWN.
GALLERY PREMIUM VERSIONS ARE AVAILABLE AT A DEPTH OF 330MM.

Single Wall Cabinet

Height: 900mm
Depth: 285mm
Two adjustable shelves.
Hand by hinge.

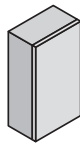

Width	Code
255mm (Gallery Premium only)	WU2590
300mm	WU390
400mm	WU490
450mm	WU4590
500mm	WU590
600mm	WU690

Single Wall Cabinet with Inset Handle

Height: 900mm
Depth: 285mm
Two adjustable shelves.
Hand by hinge.
Available in selected Inline and Contemporary ranges only. See page 19.

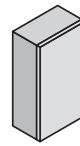

Width	Code
255mm (Gallery Premium only)	WU2590IN
300mm	WU390IN
400mm	WU490IN
450mm	WU4590IN
500mm	WU590IN
600mm	WU690IN

Double Wall Cabinet

Height: 900mm
Depth: 285mm
Two adjustable shelves.

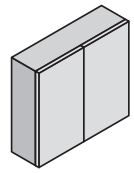

Width	Code
800mm	WU890
900mm	WU990
1000mm	WU1090

Double Wall Cabinet with Inset Handle

Height: 900mm
Depth: 285mm
Two adjustable shelves.
Available in selected Inline and Contemporary ranges only. See page 19.

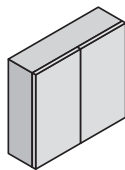

Width	Code
800mm	WU890IN
900mm	WU990IN
1000mm	WU1090IN

Corner Wall Cabinet

Height: 900mm
Depth: 285mm
Two adjustable shelves.
Hand by blank, right hand blank shown.
15mm cabinets are supplied with 170° hinges (for soft close doors order SOFTCL170) and 18mm cabinets with 110° hinges (for soft close doors order SMOVE1110).

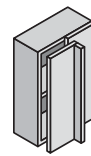

Width	Code
600mm 300 door	CWU690
600mm 400 door	CWU690FB
800mm 500 door	CWU890FA
900mm 600 door	CWU990FC

Corner Wall Cabinet with Inset Handle

Height: 900mm
Depth: 285mm
Two adjustable shelves.
Hand by blank, right hand blank shown.
15mm cabinets are supplied with 170° hinges (for soft close doors order SOFTCL170) and 18mm cabinets with 110° hinges (for soft close doors order SMOVE1110).
Available in selected Inline and Contemporary ranges only. See page 19.

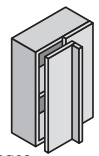

Width	Code
600mm 300 door	CWU690IN
600mm 400 door	CWU690INFB
800mm 500 door	CWU890INF A
900mm 600 door	CWU990INFC

Microwave Wall Cabinet

Height: 900mm
Depth: 330mm
450 door
72 fascia
356 aperture
This unit is deeper than standard wall units so will not line up. Check microwave dimensions before ordering. Typically 17 litre microwaves suit this housing. Maximum appliance dimensions 406mm high x 564mm wide.
The fascia panel may require scribing to suit the microwave.
Supplied with Aluminium fascia cap (OHUCAP6) - Supplied loose. Not available in Inline.

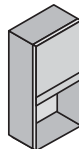

Width	Code
600mm	MWU690

Glazed Wall Cabinet

Height: 900mm
Depth: 285mm
Two adjustable glass shelves.
See page 11 for glazed cabinet availability.
Hand by hinge.
Not available in 15mm Vista.
110° hinges.
Not available in Inline.

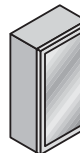

Width	Code
500mm	GDU590

Spice and Wine Rack Wall Cabinet

Height: 900mm
Depth: 285mm
Five wine racks – holds up to 15 bottles.
Available in melamine cabinet colours.
Not available in 15mm Vista.

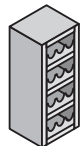

Width	Code
300mm Melamine	WWR390

Open Wall Cabinet

Height: 900mm
Depth: 285mm
Single fixed shelf.
Available in melamine cabinet colours.
Not available in 15mm Vista.

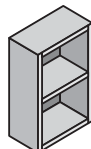

Width	Code
500mm Melamine	ODU590

Three Spice Drawer Wall Cabinet

Height: 900mm
Depth: 285mm
Available in melamine cabinet colours.
Beech drawers.
Drawer frontals available in melamine cabinet colours.
Not available in 15mm Vista.
Not available in Inline.

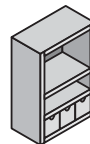

Width	Code
500mm Melamine	ODMW3590

Open Display Wall Cabinet Frame

Height: 900mm
Available in Blonde Oak, Ivory and Painted Ivory.
Not available in Inline.

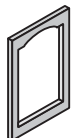

Width	Code
500mm	ODUFRAME90

CABINETS BRIDGING CABINETS

KONCEPT AND GALLERY STANDARD SPECIFICATIONS SHOWN.
GALLERY PREMIUM VERSIONS ARE AVAILABLE AT A DEPTH OF 330MM.

Over Cooker Hood

Height: 300mm
Depth: 285mm
Top lift door with flap stay.

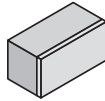

Width	Code
600mm	OCH63

Over Cooker Hood with Inset Handle

Height: 300mm
Depth: 285mm
Top lift door with flap stay.
Available in selected Inline and Contemporary ranges only.
See page 19.

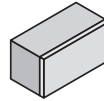

Width	Code
600mm	OCH63IN

Metallic Framed Glazed Over Cooker Hood

Height: 300mm
Depth: 285mm
Top lift door with gas piston lift.
See page 11 for ranged glazed door availability.

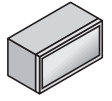

Width	Code
400	OCH43SL
500	OCH53SL
600	OCH63SL
800	OCH83SL
1000	OCH103SL

Bridging Cabinet

Height: 362mm
Depth: 285mm
Cabinets line through with bi-fold cabinets.
18mm Excel cabinet only.
Top lift door with gas piston lift.

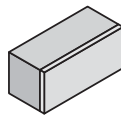

Width	Code
500mm	OCH536
600mm	OCH636
800mm	OCH836
900mm	OCH936

Bridging Cabinet with Inset Handle

Height: 362mm
Depth: 285mm
Cabinets line through with bi-fold cabinets.
Top lift door with gas piston lift.
Available in selected Inline and Contemporary ranges only.
See page 19.

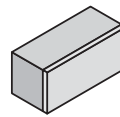

Width	Code
500mm	OCH536IN
600mm	OCH636IN
800mm	OCH836IN
900mm	OCH936IN

Bridging Unit for 1000mm Wide American Fridge Freezers

Height: 280mm
Depth: 285mm
For use over American style side by side fridge freezer.
Top lift door with flap stay.
Not available in 15mm Vista.
Maximum height of appliance when used next to 2100mm cabinets: 1800mm; 2276mm cabinets: 1976mm

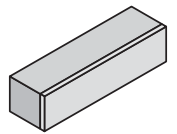

Width	Code
1000mm	OCH1028

Bridging Unit for 1000mm Wide American Fridge Freezers with Inset Handle

Height: 280mm
Depth: 285mm
For use over American style side by side fridge freezer.
Top lift door with flap stay.
18mm Excel cabinet only.
Maximum height of appliance when used next to 2100mm cabinets: 1800mm; 2276mm cabinets: 1976mm
Available in selected Inline and Contemporary ranges only. See page 19.

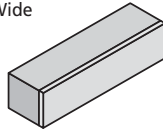

Width	Code
1000mm	OCH1028IN

Accent Open Bridging Units

Height: 362mm
Depth: 285mm
Available in 18mm MFC matt colours: Blue, Cashmere, Dark Oak, Light Ash, Stone and Yellow.

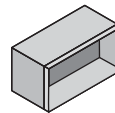

Width	Code
500mm	ODU536AC
600mm	ODU636AC
900mm	ODU936AC

CABINETS BOILER HOUSINGS AND BASE OVEN HOUSINGS

KONCEPT AND GALLERY STANDARD SPECIFICATIONS SHOWN.
GALLERY PREMIUM VERSIONS ARE AVAILABLE AT A DEPTH OF 330MM.

Wall Boiler Cabinet

Height: 724mm
Depth: 400mm
Boiler housings are not supplied with soft close doors in soft close kitchens.
Hand by hinge.
Supplied RFA with 15mm Vista cabinet only.
110° hinges.

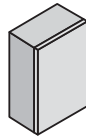

Width	Code
500mm	BH572
600mm	BH672

Wall Boiler Cabinet with Inset Handle

Height: 724mm
Depth: 400mm
Boiler housings are not supplied with soft close doors in soft close kitchens.
Hand by hinge.
Supplied RFA with 15mm Vista cabinet only.
110° hinges.
Available in Selected Inline and Contemporary ranges only. See page 19.

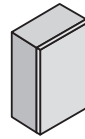

Width	Code
500mm	BH572IN
600mm	BH672IN

Wall Boiler Cabinet

Height: 900mm
Depth: 400mm
Boiler housings are not supplied with soft close doors in soft close kitchens.
Hand by hinge.
Supplied RFA with 15mm Vista cabinet only.
110° hinges.

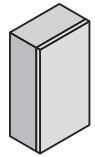

Width	Code
500mm	BH590
600mm	BH690

Wall Boiler Cabinet with Inset Handle

Height: 900mm
Depth: 400mm
Boiler housings are not supplied with soft close doors in soft close kitchens.
Hand by hinge.
Supplied RFA with 15mm Vista cabinet only.
110° hinges.
Available in Selected Inline and Contemporary ranges only. See page 19.

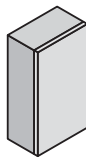

Width	Code
500mm	BH590IN
600mm	BH690IN

Dresser Boiler Cabinet

Height: 1190mm
Depth: 400mm
900 door
276 dummy drawer
Boiler housings are not supplied with soft close doors in soft close kitchens.
Hand by hinge.
Not available in 15mm Vista.
Supplied RFA.



Width	Code
600mm	BH612

Dresser Boiler Cabinet

Height: 1366mm
Depth: 400mm
1228 door
120 fascia
Boiler housings are not supplied with soft close doors in soft close kitchens.
Hand by hinge.
Not available in 15mm Vista.
Supplied RFA.

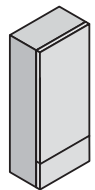

Width	Code
600mm	BH613

Dresser Boiler Cabinet

Height: 1560mm
Depth: 400mm
1228 door
47 fascia
276 dummy drawer
Boiler housings are not supplied with soft close doors in soft close kitchens.
Hand by hinge.
Supplied RFA with 15mm Vista cabinet only.
110° hinges.



Width	Code
600mm	BH615

Base Oven Housing

Height: 870mm
Depth: 570mm
72 fascia
598 aperture
47 fascia
Check that hob and oven installation depths are compatible with the thickness of worktop.
Not available in 15mm Vista.

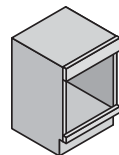

Width	Code
600mm	BOH66B

Built Under Microwave Housing

Height: 870mm
Depth: 570mm
72mm fascia
459 aperture
183 drawer
Check that hob and oven installation depths are compatible with the thickness of worktop.
Supplied with Atira drawer box.
Not available in 15mm Vista.
Supplied with Aluminium fascia cap (OHUCAP6) – supplied loose.

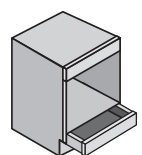

Width	Code
600mm	MBOH66

CABINETS 2100MM HIGH UNITS – 50/50 SPECIFICATION (ALIGNS 930MM HIGH BASE DOORS)

LARDER CABINETS

50/50 Larder Cabinet

Height: 2100mm
Depth: 570mm

1018 door
930 door

One fixed shelf and four additional shelves.

Hand by hinge.



Width	Code
600mm	LU66A

50/50 Larder Cabinet with Internal Drawers

Height: 2100mm
Depth: 570mm

1018 door
930 door

Five Atira internal deep drawers (187mm high).
Drawers supplied separately.

Hand by hinge.

Not available in 15mm Vista.



Width	Code
600mm	LU66AID

50/50 Corner Larder Cabinet

Height: 2100mm
Depth: 570mm

1018 door
930 door

Two doors, five additional shelves.

Supplied with frontal matched blanking panel (750x2400mm) for the blanking panel and corner post to be created on site.

Hand by blank.

Not available in 15mm Vista.

Supplied RFA.

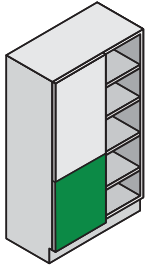

Width	Code
1000mm with 600mm doors	CNLU106A

FRIDGE/FREEZER HOUSINGS

50/50 Corner Larder Cabinet with Le Mans Pull Out

Height: 2100mm
Depth: 570mm

1018 door
930 door

x2 Le Mans Pull Out (x4 trays).

1265mm centre pole pull outs to be fitted on site.

Supplied with frontal matched blanking panel (750x2400mm) for the blanking panel and corner post to be created on site.

Hand by blank.

Available in Gallery only.

Supplied RFA.

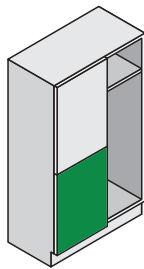

Width	Code
1000mm with 600mm door/Le Mans	CNLLM106A

50/50 Integrated Housing

Height: 2100mm
Depth: 570mm

1018 door
930 door

Hand by hinge.

One appliance behind top and bottom door.

Check fridge freezer specification. Frontals are hinged to cabinets designed for slider fixing appliances. Appliance frontals are supplied separately to the cabinet for door-on-door appliances.



Width	Code
600mm (slider fixing appliances)	IF66A
600mm (door-on-door appliances)	IF66AND
Cabinet without appliance doors	DRIFTOP1ASS
1018 appliance door	DRIFBOT1ASS
930 appliance door	DRIFBOT1ASS

OVEN HOUSINGS

Single Oven Housing – Door

Height: 2100mm
Depth: 570mm

358 flap
120 fascia (scribe required)
595 aperture
930 door

Single adjustable shelf.

Hand by hinge.

Supplied with Aluminium fascia cap (OHUCAP6) – supplied loose.

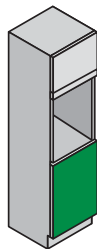

Width	Code
600mm	OH6616A

Single Oven and Integrated Fridge Housing – Door

Height: 2100mm
Depth: 570mm

358 flap
72 fascia
595 aperture
930 door

Hand by hinge.

Suitable for 880mm high integrated fridge/freezers only.

Check fridge freezer specification. Frontals are hinged to cabinets designed for slider fixing appliances. Appliance frontals are supplied separately to the cabinet for door-on-door appliances.



Width	Code
600mm (slider fixing appliances)	OFH66A
600mm (door-on-door appliances)	OFH66AND
Cabinet without appliance doors	DRIFBOT1ASS
930 appliance door	DRIFBOT1ASS

Microwave/Compact Oven Housing – Door

Height: 2100mm
Depth: 570mm

557 door
455 aperture
930 door

Single adjustable shelf.

Hand by hinge.

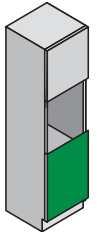

Width	Code
600mm	OH6616B

Microwave/Compact Oven and Integrated Fridge Housing – Door

Height: 2100mm
Depth: 570mm

557 door
455 aperture
930 door

Hand by hinge.

Suitable for 880mm high integrated fridge/freezers only.

Check fridge freezer specification. Frontals are hinged to cabinets designed for slider fixing appliances. Appliance frontals are supplied separately to the cabinet for door-on-door appliances.

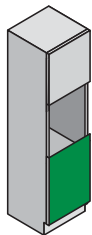

Width	Code
600mm (slider fixing appliances)	OFH66B
600mm (door-on-door appliances)	OFH66BND
Cabinet without appliance doors	DRIFBOT1ASS
930 appliance door	DRIFBOT1ASS

Important: Please check the appliance manufacturer's instructions as to the venting requirements for any particular appliance. All appliances must be fitted strictly in accordance with the manufacturer's instructions. Check appliance dimensions fit the appliance housing before ordering. Fascia panels can be cut to suit. Edging tape or the OHUCAP6 are available for re-edging the fascia after cutting.

CABINETS 2100MM HIGH UNITS – 70/30 SPECIFICATION (ALIGNS 720MM HIGH BASE DOORS)

LARDER CABINETS

70/30 Reduced Depth Larder Cabinet

Height: 2100mm
Depth: 285mm
1228 door
720 door
One fixed shelf and four additional shelves.
Hand by hinge.
Not available in 15mm Vista.



Width	Code
300mm with doors	LU33
500mm with doors	LU53
600mm with doors	LU63

70/30 Larder Cabinet

Height: 2100mm
Depth: 570mm
1228 door
720 door
One fixed shelf and four additional shelves.
Hand by hinge.



Width	Code
300mm	LU36
500mm	LU56
600mm	LU66

70/30 Larder Cabinet with Internal Drawers

Height: 2100mm
Depth: 570mm
1228 door
720 door
Five Atira internal deep drawers (187mm high).
Drawers supplied separately.
Hand by hinge.
Not available in 15mm Vista.

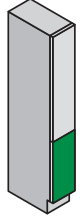

Width	Code
300mm	LU36ID
500mm	LU56ID
600mm	LU66ID

70/30 Larder Cabinet with Pull-out Chrome Baskets

Height: 2100mm
Depth: 570mm
1228 door
720 door
Two doors connected.
Five pull out baskets to be fitted on-site
Soft close.



300mm Pull Out Larder Units



Width	Code
300mm (Vista and Excel)	WPL36
300mm (Gallery only)	PL36AR
500mm (Gallery only)	PL56AR
500mm Cranked (Gallery only)	CPL56AR

70/30 Corner Larder Cabinet

Height: 2100mm
Depth: 570mm
1228 door
720 door
Two doors, five additional shelves.
Supplied with frontal matched blanking panel (750x2400mm) for the blanking panel and corner post to be created on site.
Hand by blank.
Not available in 15mm Vista.
Supplied RFA.

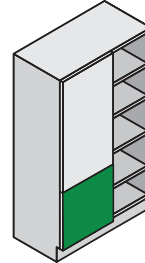

Width	Code
1000mm with 500mm doors	CNLU106
1000mm with 600mm doors	CNLU106C

70/30 Larder Cabinet with Le Mans Pull Out

Height: 2100mm
Depth: 570mm
1228 door
720 door
x2 Le Mans Pull Out (x4 trays).
1265mm centre pole pull outs to be fitted on site.
Supplied with frontal matched blanking panel (750x2400mm) for the blanking panel and corner post to be created on site.
Hand by blank.
Available in Gallery only.
Supplied RFA.

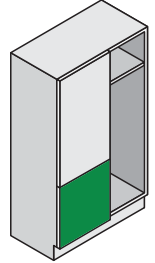

Width	Code
1000mm with 500mm door/Le Mans	CNLLM106
1000mm with 600mm door/Le Mans	CNLLM106C

FRIDGE/FREEZER HOUSINGS

70/30 Integrated Housing

Height: 2100mm
Depth: 570mm
1228 door
720 door
Hand by hinge.
One appliance behind top and bottom door.
Check fridge freezer specification.
Frontals are hinged to cabinets designed for slider fixing appliances.
Appliance frontals are supplied separately to the cabinet for door-on-door appliances.

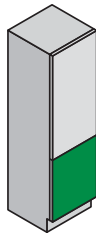

Width	Code
600mm (slider fixing appliances)	IF66D
600mm (door-on-door appliances)	IF66DND
Cabinet without appliance doors	DRIFTOP2ASS
1228 appliance door	DRIFBOT3ASS
720 appliance door	

70/30 Integrated Housing

Height: 2100mm
Depth: 570mm
1228 door
720 door
Hand by hinge.
For use with most NEFF, Bosch and Siemens appliances only (appliance sits higher to allow it to align with doors).
One appliance behind top and bottom door.
Check fridge freezer specification.
Frontals are hinged to cabinets designed for slider fixing appliances. Appliance frontals are supplied separately to the cabinet for door-on-door appliances.



Width	Code
600mm (slider fixing appliances)	IF66G
600mm (door-on-door appliances)	IF66GND
Cabinet without appliance doors	DRIFTOP2GASS
1228 appliance door	DRFH6GASS
720 appliance door	

CABINETS 2100MM HIGH UNITS – 70/30 SPECIFICATION (ALIGNS 720MM HIGH BASE DOORS)

OVEN HOUSINGS

Single Oven Housing – Door

Height: 2100mm
Depth: 570mm

557 door
72 fascia
595 aperture
720 door

Hand by hinge.



Width	Code
600mm	OH666A

Single Oven Housing – 2 Pan

Height: 2100mm
Depth: 570mm

557 door
72 fascia
595 aperture
358 drawer
358 drawer

Hand by hinge.

Not available in
Calgary and Newport.



Width	Code
600mm	OH6610E

Microwave/Compact Appliance Housing – Door

Height: 2100mm
Depth: 570mm

720 door
47 fascia
455 aperture
720 door

Hand by hinge.

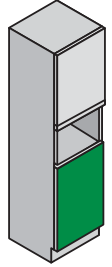

Width	Code
600mm	OH667A

Microwave/Compact Appliance Housing – 2 Pan

Height: 2100mm
Depth: 570mm

720 door
47 fascia
455 aperture
358 drawer
358 drawer

Hand by hinge.

Not available in
Calgary and Newport.

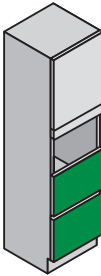

Width	Code
600mm	OH6610G

Twin Compact Appliance Housing – Door

Height: 2100mm
Depth: 570mm

296 flap
455 aperture
18 shelf (supplied loose)
455 aperture
720 door

Hand by hinge.



Width	Code
600mm	OH6612A

Twin Compact Appliance Housing – 2 Pan

Height: 2100mm
Depth: 570mm

296 flap
455 aperture
18 shelf (supplied loose)
455 aperture
358 drawer
358 drawer

Not available in
Calgary and Newport.

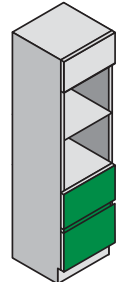

Width	Code
600mm	OH6612D

PANTRY UNITS

Two Drawer Pantry Cabinet

Height: 2100mm
Depth: 570mm

1228 door (x1)
358 drawers (x2)

One top door and two deep
pan drawers.

Three adjustable shelves.

Hand by hinge.

Not available in
Calgary and Newport.



Width	Code
600mm	PU6621D2A

Two Drawer Pantry Cabinet

Height: 2100mm
Depth: 570mm

1228 doors (x2)
358 drawers (x2)

Two top doors and two deep
pan drawers.

Three adjustable shelves.

Hand by hinge.

Not available in
Calgary and Newport.

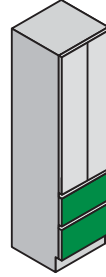

Width	Code
600mm	PU6621D2

Three Drawer Pantry Cabinet

Height: 2100mm
Depth: 570mm

1228 doors (x1)
159 drawer
276 drawers (x2)

One top door, one shallow
drawer and two pan drawers.

Three adjustable shelves.

Hand by hinge.

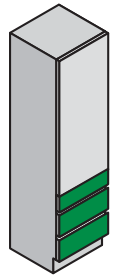

Width	Code
600mm	PU6621D3A

Three Drawer Pantry Cabinet

Height: 2100mm
Depth: 570mm

1228 doors (x2)
159 drawer
276 drawers (x2)

Two top doors, one shallow
drawer and two pan drawers.

Three adjustable shelves.



Width	Code
600mm	PU6621D3

Pantry Cabinet

Height: 2100mm
Depth: 570mm

1228 doors (x2)
720 doors (x2)

Five adjustable shelves.

Not available in 15mm Vista.

Supplied RFA.

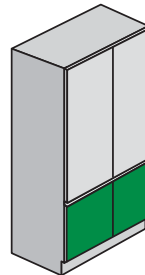

Width	Code
1000mm	PU106

CABINETS 2100MM HIGH UNITS – 30/70 SPECIFICATION (ALIGNS 720MM HIGH TOP DOORS)

LARDER CABINETS

30/70 Reduced Depth Larder Cabinet

Height: 2100mm
Depth: 285mm
720 door
1228 door
One fixed shelf and four additional shelves.
Hand by hinge.
Not available in 15mm Vista.



Width	Code
300mm	LU33B
500mm	LU53B
600mm	LU63B

30/70 Larder Cabinet

Height: 2100mm
Depth: 570mm
720 door
1228 door
One fixed shelf and four additional shelves.
Hand by hinge.



Width	Code
300mm	LU36B
500mm	LU56B
600mm	LU66B

FRIDGE/FREEZER HOUSINGS

In-Column Integrated Housing

Height: 2100mm
Depth: 570mm
720 door
1228 door
Hand by hinge.
One appliance behind bottom door.
Suitable for 1225mm high integrated fridge/freezers only.
Check fridge freezer specification.
Frontals are hinged to cabinets designed for slider fixing appliances.
Appliance frontals are supplied separately to the cabinet for door-on-door appliances.

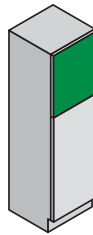

Width	Code
600mm (slider fixing appliances)	IF66B
600mm (door-on-door appliances)	IF66BND
Cabinet without appliance doors	DRIFBOT2ASS
1228 appliance door	DRIFBOT2ASS

OVEN HOUSINGS

Single Oven Housing – Door

Height: 2100mm
Depth: 570mm
720 door
72 fascia
595 aperture
557 door
Hand by hinge.



Width	Code
600mm	OH665A

Microwave/Compact Appliance Housing – Door

Height: 2100mm
Depth: 570mm
720 door
120 fascia
384 aperture
720 door
Hand by hinge.

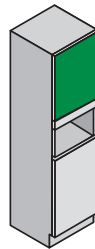

Width	Code
600mm	OH667B

Microwave/Compact Appliance Housing – 2 Pan

Height: 2100mm
Depth: 570mm
720 door
47 fascia
455 aperture
358 drawer
358 drawer
Hand by hinge.
Not available in Calgary and Newport.

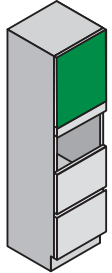

Width	Code
600mm	OH6610G

CABINETS 2100MM HIGH UNITS – IN-COLUMN SPECIFICATION (ALIGNS 296MM HIGH TOP FLAPS)

FRIDGE/FREEZER HOUSINGS

In-Column Integrated Housing

Height: 2100mm
Depth: 570mm

296 flap
930 door
720 door

Hand by hinge.

One appliance behind middle door.
Suitable for 880mm high integrated
fridge/freezers only.

Check fridge freezer specification.
Frontals are hinged to cabinets designed
for slider fixing appliances. Appliance frontals
are supplied separately to the cabinet for door-on-
door appliances.

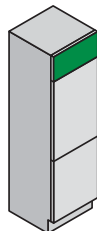

Width	Code
600mm (slider fixing appliances)	IF66C
600mm (door-on-door appliances)	
Cabinet without appliance doors	IF66CND
930 appliance door	DRIFMIDASS

OVEN HOUSINGS

Single Oven and Microwave/Compact Appliance Housing – Door

Height: 2100mm
Depth: 570mm

296 flap
47 fascia (scribe required)
437 aperture
18 shelf (supplied loose)
590 aperture
557 door

Hand by hinge.

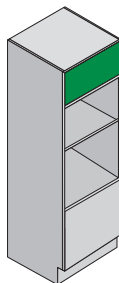

Width	Code
600mm	OH6614A

Twin Single Oven Housing – 1 Pan

Height: 2100mm
Depth: 570mm

296 flap
595 aperture
18 shelf (supplied loose)
595 aperture
450 drawer
Internal top drawer.

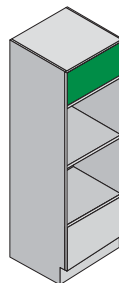

Width	Code
600mm	OH6613A

Double Oven and Microwave/Compact Appliance Housing – 1 Pan

Height: 2100mm
Depth: 570mm

296 flap
457 aperture
18 shelf (supplied loose)
875 aperture
296 drawer



Width	Code
600mm	OH668C

Twin Microwave/Compact Appliance Housing – Door

Height: 2100mm
Depth: 570mm

296 flap
455 aperture
18 shelf (supplied loose)
455 aperture
720 door

Hand by hinge.



Width	Code
600mm	OH6612A

Twin Microwave/Compact Appliance Housing – 2 Pan

Height: 2100mm
Depth: 570mm

296 flap
455 aperture
18 shelf (supplied loose)
455 aperture
358 drawer
358 drawer

Not available in
Calgary and Newport.

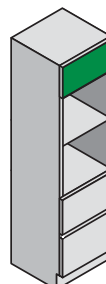

Width	Code
600mm	OH6612D

CABINETS 2100MM HIGH UNITS – MISCELLANEOUS

OVEN HOUSINGS

Double Oven Housing

Height: 2100mm
Depth: 570mm

450 door
47 fascia
890 aperture
557 door

Hand by hinge.

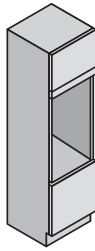

Width	Code
600mm	OH663A

Double Oven Housing

Height: 2100mm
Depth: 570mm

450 door
47 fascia
890 aperture
276 drawer
276 drawer

Hand by hinge.

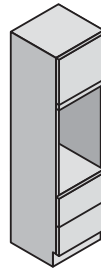

Width	Code
600mm	OH6610B

Double Oven and Microwave/Compact Appliance Housing

Height: 2100mm
Depth: 570mm

450 door
72 fascia
395 aperture
18 shelf (supplied loose)
890 aperture
120 fascia

Hand by hinge.

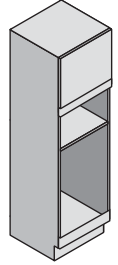

Width	Code
600mm	OH668B

Double Oven and Microwave/Compact Appliance Housing

Height: 2100mm
Depth: 570mm

450 door
72 fascia
455 aperture
18 shelf (supplied loose)
890 aperture
72 fascia

Hand by hinge.

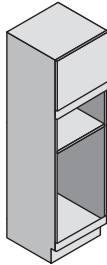

Width	Code
600mm	OH668D

CABINETS 2276MM HIGH UNITS – 50/50 SPECIFICATION (ALIGNS 1018MM HIGH BASE DOORS)

LARDER CABINETS

50/50 Larder Cabinet

Height: 2276mm
Depth: 570mm
1106 door
1018 door
One fixed shelf and five additional shelves.
Hand by hinge.



Width	Code
600mm	LU6623A

50/50 Larder Cabinet with Internal Drawers

Height: 2276mm
Depth: 570mm
1106 door
1018 door
Five Atira internal deep drawers (187mm high)
Drawers supplied separately.
Hand by hinge.
Not available in 15mm Vista.



Width	Code
600mm	LU6623AID

50/50 Corner Larder Cabinet

Height: 2276mm
Depth: 570mm
1106x600 door
1018x600 door
Two doors, five additional shelves.
Supplied with frontal matched blanking panel (750x2400mm).
Hand by blank.
Not available in 15mm Vista.
Supplied RFA.

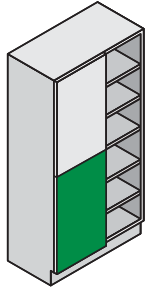

Width	Code
1000mm with 600mm doors	CNLU10623A

FRIDGE/FREEZER HOUSINGS

50/50 Corner Larder Cabinet with Le Mans Pull Out

Height: 2276mm
Depth: 570mm
1106 door
1018 door
x2 Le Mans Pull Out (x4 trays).
1265mm centre pole pull outs to be fitted on site.
Supplied with frontal matched blanking panel (750x2400mm) for the blanking panel and corner post to be created on site.
Hand by blank.
Available in Gallery only.
Supplied RFA.

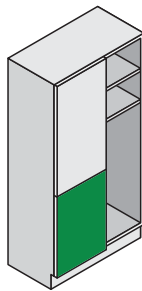

Width	Code
1000mm with 600mm door/Le Mans	CNLLM10623A

50/50 Integrated Housing

Height: 2276mm
Depth: 570mm
1106 door
1018 door
Hand by hinge.
One appliance behind top and bottom door.
Check fridge freezer specification.
Frontals are hinged to cabinets designed for slider fixing appliances.
Appliance frontals are supplied separately to the cabinet for door-on-door appliances.



Width	Code
600mm (slider fixing appliances)	IF6623J
600mm (door-on-door appliances)	IF6623JND
Cabinet without appliance doors	DRIFTOP6ASS
1106 appliance door	DRIFBOT4ASS
1018 appliance door	

OVEN HOUSINGS

Single Oven and Fridge or Freezer Housing – Door

Height: 2276mm
Depth: 570mm
450 flap
72 fascia (scribe required)
595 aperture
1018 door
Supplied with Aluminium fascia cap (OHUCAP6) – supplied loose.
Hand by hinge.
Suitable for use with 880mm high integrated fridge/freezers only.



Width	Code
600mm	OFH6623A

Single Oven Housing – Door

Height: 2276mm
Depth: 570mm
450 door
72 fascia (scribe required)
595 aperture
1018 door
Supplied with Aluminium fascia cap (OHUCAP6) – supplied loose.
Hand by hinge.

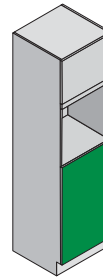

Width	Code
600mm	OH662316A

Microwave/Compact Appliance Housing – Door

Height: 2276mm
Depth: 570mm
557 door
120 fascia (scribe required)
455 aperture
1018 door
Supplied with Aluminium fascia cap (OHUCAP6) – supplied loose.
Hand by hinge.

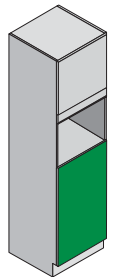

Width	Code
600mm	OH662316B

Microwave/Compact Appliance and Fridge or Freezer Housing – Door

Height: 2276mm
Depth: 570mm
557 door
120 fascia (scribe required)
455 aperture
1018 door
Supplied with Aluminium fascia cap (OHUCAP6) – supplied loose.
Hand by hinge.
Suitable for use with 880mm high integrated fridge/freezers only.

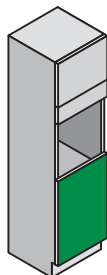

Width	Code
600mm	OFH6623B

CABINETS 2276MM HIGH UNITS – 70/30 SPECIFICATION (ALIGNS 896MM HIGH BASE DOORS)

LARDER CABINETS

70/30 Reduced Depth Larder Cabinet

Height: 2276mm
Depth: 285mm
1228 door
896 door
One fixed shelf and five additional shelves.
Not available in 15mm Vista.
Hand by hinge.



Width	Code
300mm	LU3323
500mm	LU5323
600mm	LU6323

70/30 Larder Cabinet

Height: 2276mm
Depth: 570mm
1228 door
896 door
One fixed shelf and five additional shelves.
Hand by hinge.



Width	Code
300mm	LU3623
500mm	LU5623
600mm	LU6623

70/30 Larder Cabinet with Internal Deep Drawers

Height: 2276mm
Depth: 570mm
1228 door
896 door
Five Atira internal deep drawers (187mm high)
Drawers supplied separately.
Not available in 15mm Vista.
Hand by hinge.

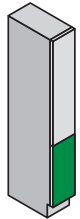

Width	Code
300mm	LU3623ID
500mm	LU5623ID
600mm	LU6623ID

70/30 Larder Cabinet with Standard Pull-out Chrome Baskets

Height: 2276mm
Depth: 570mm
1228 door
896 door
Two doors connected.
Single fixed shelf.
Five pull out baskets to be fitted on-site.
Soft close.

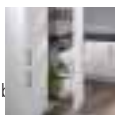

300mm Pull Out Larder Units

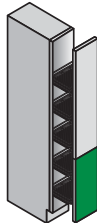

Width	Code
300mm (Vista and Excel)	WPL3623
300mm (Gallery only)	PL36AR
500mm (Gallery only)	PL56AR
500mm Cranked (Gallery only)	CPL56AR

70/30 Corner Larder Cabinet

Height: 2276mm
Depth: 570mm
1228 door
896 door
Two doors, five additional shelves.
Supplied with frontal matched blanking panel (750x2400mm) for the blanking panel and corner post to be created on site.
Hand by blank.
Not available in 15mm Vista.
Supplied RFA.

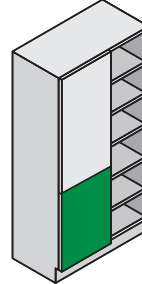

Width	Code
1000mm with 500mm doors	CNLU10623
1000mm with 600mm doors	CNLU10623C

70/30 Larder Cabinet with Le Mans Pull Out

Height: 2276mm
Depth: 570mm
1228 door
890 door
x2 Le Mans Pull Out (x4 trays).
1265mm centre pole pull outs to be fitted on site.
Supplied with frontal matched blanking panel (750x2400mm) for the blanking panel and corner post to be created on site.
Hand by blank.
Available in Gallery only.
Supplied RFA.

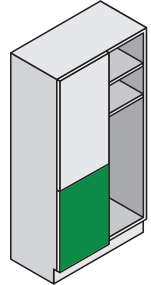

Width	Code
1000mm with 500mm door/Le Mans	CNLLM10623
1000mm with 600mm door/Le Mans	CNLLM10623C

FRIDGE/FREEZER HOUSINGS

70/30 Integrated Housing

Height: 2276mm
Depth: 570mm
1228 door
896 door
Hand by hinge.
One appliance behind top and bottom door.
Check fridge freezer specification. Frontals are hinged to cabinets designed for slider fixing appliances. Appliance frontals are supplied separately to the cabinet for door-on-door appliances.

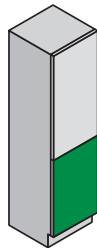

Width	Code
600mm (slider fixing appliances)	IF6623D
600mm (door-on-door appliances)	IF6623DND
Cabinet without appliance doors	DRIFTOP2ASS
1228 appliance door	DRAHBOT1ASS
896 appliance door	

70/30 Integrated Housing

Height: 2276mm
Depth: 570mm
1228 door
896 door
Hand by hinge.
For use with NEFF, Bosch and Siemens appliances only (appliance sits higher to allow it to align with doors).
One appliance behind top and bottom door.
Check fridge freezer specification. Frontals are hinged to cabinets designed for slider fixing appliances. Appliance frontals are supplied separately to the cabinet for door-on-door appliances.



Width	Code
600mm (slider fixing appliances)	IF6623G
600mm (door-on-door appliances)	IF6623GND
Cabinet without appliance doors	DRIFTOP2GASS
1228 appliance door	DRAHBOT1GASS
896 appliance door	

CABINETS 2276MM HIGH UNITS – 70/30 SPECIFICATION (ALIGNS 896MM HIGH BASE DOORS)

OVEN HOUSINGS

Single Oven Housing – Door

Height: 2276mm
 Depth: 570mm
 557 door
 72 fascia
 595 aperture
 896 door
 Hand by hinge.



Width	Code
600mm	OH66236A

Microwave/Compact Appliance Housing – Door

Height: 2276mm
 Depth: 570mm
 720 door
 47 fascia
 455 aperture
 896 door
 Hand by hinge.

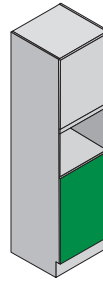

Width	Code
600mm	OH662315A

PANTRY UNITS

Pantry Cabinet

Height: 2276mm
 Depth: 570mm
 1228 doors (x2)
 896 door (x2)
 Five adjustable shelves.
 Not available in 15mm Vista.
 Supplied RFA.

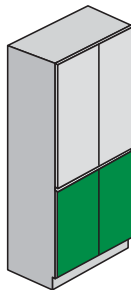

Width	Code
1000mm	PU10623

CABINETS 2276MM HIGH UNITS – 30/70 SPECIFICATION (ALIGNS 896MM HIGH TOP DOORS)

LARDER CABINETS

30/70 Reduced Depth Larder Cabinet

Height: 2276mm
Depth: 285mm
896 door
1228 door
One fixed shelf and five additional shelves.
Not available in 15mm Vista.
Hand by hinge.



Width	Code
300mm	LU3323B
500mm	LU5323B
600mm	LU6323B

30/70 Larder Cabinet

Height: 2276mm
Depth: 570mm
896 door
1228 door
One fixed shelf and five additional shelves.
Hand by hinge.



Width	Code
300mm	LU3623B
500mm	LU5623B
600mm	LU6623B

FRIDGE/FREEZER HOUSINGS

In-Column Integrated Housing

Height: 2276mm
Depth: 570mm
896 door
1228 door
Hand by hinge.
One appliance behind bottom door.
Suitable for use with 1225mm high integrated fridge/freezers only.
Check fridge freezer specification.
Frontals are hinged to cabinets designed for slider fixing appliances.
Appliance frontals are supplied separately to the cabinet for door-on-door appliances.



Width	Code
600mm (slider fixing appliances)	IF6623B
600mm (door-on-door appliances)	IF6623BND
Cabinet without appliance doors	DRIFBOT2ASS
1228 appliance door	DRIFBOT2ASS

OVEN HOUSINGS

Single Oven Housing – Door

Height: 2276mm
Depth: 570mm
896 door
72 fascia
595 aperture
557 door
Hand by hinge.



Width	Code
600mm	OH66235A

Microwave/Compact Appliance Housing – Door

Height: 2276mm
Depth: 570mm
896 door
47 fascia
457 aperture
720 door
Hand by hinge.

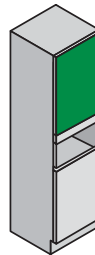

Width	Code
600mm	OH66237A

Microwave/Compact Appliance Housing – 2 Pan

Height: 2276mm
Depth: 570mm
896 door
47 fascia
456 aperture
358 drawer
358 drawer
Hand by hinge.
Not available in Calgary and Newport.

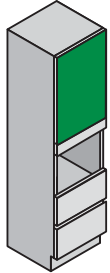

Width	Code
600mm	OH662310G

CABINETS 2276MM HIGH UNITS – ADDITIONAL 70/30 SPECIFICATION (ALIGNS 720MM HIGH BASE DOORS)

FRIDGE/FREEZER HOUSINGS

Tall 70/30 Integrated Housing

Height: 2276mm Depth: 570mm

296 flap
1106 door
720 door

Hand by hinge.

One appliance behind mid and bottom door.

Check fridge freezer specification. Frontals are hinged to cabinets designed for slider fixing appliances. Appliance frontals are supplied separately to the cabinet for door-on-door appliances.



Width	Code
600mm (slider fixing appliances)	IF6623K
600mm (door-on-door appliances)	IF6623KND
Cabinet without appliance doors	DRIFTOP6ASS
1106 appliance door	DRFH6ASS
720 appliance door	DRFH6ASS

OVEN HOUSINGS

Single Oven Housing – Door

Height: 2276mm
Depth: 570mm

720 door
72 fascia
608 aperture
720 door

Hand by hinge.



Width	Code
600mm	OH66234C

Single Oven Housing – 2 Pan

Height: 2276mm
Depth: 570mm

720 door
72 fascia
607 aperture
358 drawer
358 drawer

Hand by hinge.

Not available in Calgary and Newport.



Width	Code
600mm	OH662310E

Microwave/Compact Appliance Housing – Door

Height: 2276mm
Depth: 570mm

896 door
47 fascia
457 aperture
720 door

Hand by hinge.

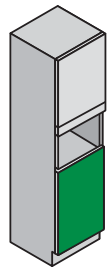

Width	Code
600mm	OH66237A

Microwave/Compact Appliance Housing – 2 Pan

Height: 2276mm
Depth: 570mm

896 door
47 fascia
456 aperture
358 drawer
358 drawer

Hand by hinge.

Not available in Calgary and Newport.



Width	Code
600mm	OH662310G

Single Oven and Microwave/Compact Appliance Housing – Door

Height: 2276mm
Depth: 570mm

296 flap
72 fascia (scribe required)
455 aperture
18 shelf (supplied loose)
595 aperture
720 door

Supplied with Aluminium fascia cap (OHUCAP6) – supplied loose.

Hand by hinge.

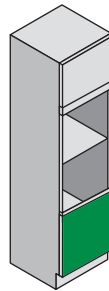

Width	Code
600mm	OH662312A

Single Oven and Microwave/Compact Appliance Housing – 2 Pan

Height: 2276mm
Depth: 570mm

296 flap
72 fascia (scribe required)
455 aperture
18 shelf (supplied loose)
595 aperture
358 drawer
358 drawer

Supplied with Aluminium fascia cap (OHUCAP6) – supplied loose.

Not available in Calgary and Newport.

Width	Code
600mm	OH662312D

CABINETS 2276MM HIGH UNITS – MISCELLANEOUS

OVEN HOUSINGS

Double Oven Housing

Height: 2276mm
Depth: 570mm

557 door
120 fascia
890 aperture
557 door
Hand by hinge.

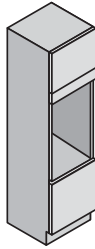

Width	Code
600mm	OH66233A

Double Oven Housing

Height: 2276mm
Depth: 570mm

557 door
120 fascia
885 aperture
276 drawer
276 drawer
Hand by hinge.

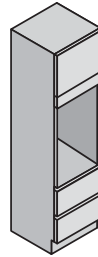

Width	Code
600mm	OH662310B

Double Oven and Microwave/Compact Appliance Housing – 1 Pan

Height: 2276mm
Depth: 570mm

450 door
120 fascia
380 aperture
18 shelf
888 aperture
276 drawer

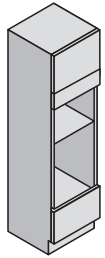

Width	Code
600mm	OH66238B

Double Oven and Microwave/Compact Appliance Housing – 1 Pan

Height: 2276mm
Depth: 570mm

450 door
47 fascia
453 aperture
18 shelf
888 aperture
276 drawer

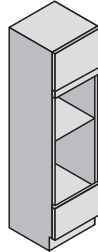

Width	Code
600mm	OH66238A

CABINETS CABINET ACCESSORIES

Oven Housing Fascia Panels
600w replacement
fascia panels

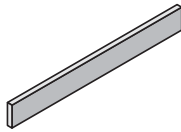

Height	Code
47mm	FAAH4
72mm	FAAH7
120mm	FAAHB

Oven Housing Fascia Cap
600w aluminium fascia cap.
Used on the underside of a
fascia panel when cut to suit
an appliance.
Supplied with selected
cabinets as detailed previously.



Width	Code
600mm	OHUCAP6

CABINETS INTEGRATED APPLIANCE DOORS & COOKER HOOD DOORS

**450w Slimline Dishwasher
Door (drilled for hinges)**
IDFD45ASS to be joined on site.

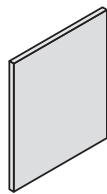

Height	Code
720mm Door	DRDW45ASS
557mm Door	IDFD45ASS
159mm Drawer and Joining Plates	

**600w Integrated Appliance
Door (undrilled for hinges)**
IDFD2ASS to be joined on
site.



Height	Code
720mm Door for Integrated Appliance	DRFH6UDASS
557mm Door for Semi-Integrated Appliances	DRDL6UDASS
557mm Door 159mm Drawer and Joining Plates for Integrated Appliances	IDFD2ASS

Integrated Cooker Hood Door
Height: 450mm
Inset handles available in
selected ranges.
See page 19.

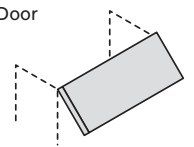

British Standard BS6172
recommended hob
clearance heights are
650mm for electric
and 750mm for gas hobs
in the absence of
manufacturer's instructions.
Check specific appliance
instructions for actual
dimensions required.

Width	Code
600mm	DRICASS
600mm with Inset Handle	DRICIN

Integrated Cooker Hood Door
Height: 560mm

Inset handles available in
selected ranges.
See page 19.

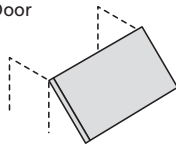

British Standard BS6172
recommended hob
clearance heights are
650mm for electric
and 750mm for gas hobs
in the absence of
manufacturer's instructions.
Check specific appliance
instructions for actual
dimensions required.

Width	Code
600mm	DRIC56ASS
600mm with Inset Handle	DRIC56IN

CABINETS MID HEIGHT CABINETS

Four Drawer Pack

Height: 1381mm
 Depth: 570mm
 120 fascia
 276 drawer (x4)
 Not available in 15mm Vista.
 Not available in Inline.

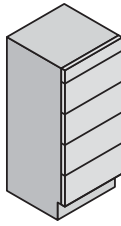

Width	Code
600mm	PD66D4

Single Oven Housing

Height: 1381mm
 Depth: 570mm
 72 fascia
 595 aperture
 557 door
 Hand by hinge.
 Not available in 15mm Vista.
 Not available in Inline.

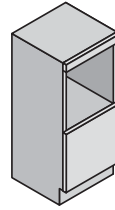

Width	Code
600mm	SOH6613

Single Oven/Microwave Housing

Height: 1381mm
 Depth: 570mm
 72 fascia
 422 aperture
 72 fascia
 595 aperture
 120 fascia
 Not available in 15mm Vista.
 Not available in Inline.

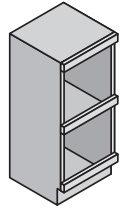

Width	Code
600mm	SOH6613A

Double Oven Housing

Height: 1381mm
 Depth: 570mm
 47 fascia
 885 aperture
 296 drawer
 Not available in 15mm Vista.
 Not available in Inline.

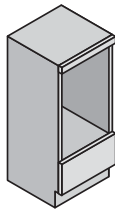

Width	Code
600mm	DOH6613

Fridge Housing

Height: 1381mm
 Depth: 570mm
 930 door
 296 drawer
 Hand by hinge.
 Not available in 15mm Vista.
 Not available in Inline.
 Check fridge freezer specification.
 Frontals are hinged to cabinets designed for slider fixing appliances. Appliance frontals are supplied separately to the cabinet for door-on-door appliances.

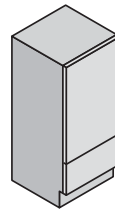

Width	Code
600mm (slider fixing appliances)	IF6613
600mm (door-on-door appliances)	IF6613ND
Cabinet without appliance doors	DRIFBOT1ASS
930 appliance door	

Microwave Oven Housing

Height: 1381mm
 Depth: 570mm
 47 fascia
 450 aperture
 159 drawer
 276 drawer (x2)
 Not available in 15mm Vista.
 Not available in Inline.

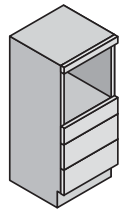

Width	Code
600mm	MOH6613D3

Larder Cabinet

Height: 1381mm
 Depth: 570mm
 1228 door
 Three shelves.
 Hand by hinge.
 Not available in 15mm Vista.
 Not available in Inline.

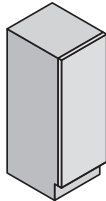

Width	Code
500mm	LU5613
600mm	LU6613

CABINETS TALL WORKTOP DRESSER CABINETS

KONCEPT AND GALLERY STANDARD SPECIFICATIONS SHOWN.
GALLERY PREMIUM VERSIONS ARE AVAILABLE AT A DEPTH OF 330MM.

Glazed Dresser Cabinet with Three Spice Drawers

Height: 1190mm
Depth: 285mm

Three glass shelves.

See page 11 for ranged glazed door availability.

WDU512SL to be ordered for all other ranges.

Beech drawers.

Drawer frontals available in melamine cabinet colours.

Not available in 15mm Vista.

Not available in Inline.

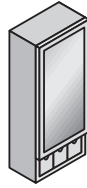

Width	Code
500mm (ranged)	WDU512
500mm (metallic framed)	WDU512SL

Glazed Dresser Cabinet with Single Spice Drawer

Height: 1190mm
Depth: 285mm

Three glass shelves.

See page 11 for ranged glazed door availability.

WDU512BSL to be ordered for all other ranges.

Beech drawers with ranged drawer fronts.

Not available in 15mm Vista.

Not available in Inline.



Width	Code
500mm (ranged)	WDU512B
500mm (metallic framed)	WDU512BSL

Tall Glazed Dresser Cabinet with Three Spice Drawers

Height: 1366mm
Depth: 285mm

Three glass shelves.

See page 11 for ranged glazed door availability.

WDU513ASL to be ordered for all other ranges.

Beech drawers.

Drawer frontals available in melamine cabinet colours.

Not available in 15mm Vista.

Not available in Inline.

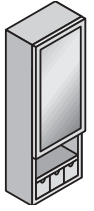

Width	Code
500mm (ranged)	WDU513A
500mm (metallic framed)	WDU513ASL

Tall Glazed Dresser Cabinet with Single Spice Drawer

Height: 1366mm
Depth: 285mm

Three glass shelves.

See page 11 for ranged glazed door availability.

WDU513BSL to be ordered for all other ranges.

Beech drawers with ranged drawer fronts.

Not available in 15mm Vista.

Not available in Inline.



Width	Code
500mm (ranged)	WDU513B
500mm (metallic framed)	WDU513BSL

RECOMMENDED BLENDER PANELS, FILLER PANELS & PLINTHS

Three specifications of panels are available. Choose a C, R or F on the end of the code to ensure the panels co-ordinate with either the cabinet, replacement end or frontal throughout the kitchen.

SPEC LEVEL	WALL BLENDER	BASE BLENDER	TALL BLENDER	SHELVING	BREAKFAST BAR PANEL	BREAKFAST BAR PANEL	PLINTH (INC SEAL)
DIMENSIONS	970x352x18mm	920x650x18mm	2400x750x18mm	2600x352x18mm	920x900x18mm	920x1800x18mm	2600x146mm (minimum size)
STANDARD	BWU390C	BBU6592C	BLU7523C	SHPANEL24C	N/A	BBBP1892C	CONPLINTHC
REPLACEMENT ENDS	BWU390R	BBU6592R	BLU7523R	SHPANEL24R	BBBP992R	BBBP1892R	CONPLINTHR
FRONTAL CO-ORDINATED	BWU390F	BBU6592F	BLU7523F	SHPANEL24F	BBBP992F	BBBP1892F	CONPLINTHF

Cabinet colour panels are matt MFC material. Panels that match replacement ends will be a combination of cabinet and frontal co-ordinating panels.

Note:

Alta and Inline Select ranges have 350mm deep filler, wall and shelving panels.

* 900mm Breakfast bars are available in selected ranges. An 1800mm panel and edging tape will be supplied for any range that has a Cabinet Matched panel specification and for Austin, Colorado, Hacienda, Kansas, Minnesota, Newport, Oakham, Plaza Mussel and Plaza Stone.

INFILL CODES

General infill panel codes have been set up to make it easier to specify the correct infills across all kitchen ranges. These specify either a frontal or blender to be used as an infill depending on the range (e.g, New York is supplied with a frontal with the integrated handle, whereas Austin is supplied with a blender panel with a flat profile).

BASE FILLER PANEL*	561mm HIGH WALL UNIT FILLER*	724mm HIGH WALL UNIT FILLER*	900mm HIGH WALL UNIT FILLER*
BFF372	WF356	WF372	WF390

* Dimensions vary by range, but will either be supplied with a 300mm frontal or 352mm wide blender panel.

RANGE PANEL SPECIFICATION

Standard 'C' panels and CPOSTPNL72/90 corner post panels are matt MFC material and will match the selected cabinet colour.

Frontal co-ordinated 'F' panels and replacement end 'R' panels are a combination of frontal material and cabinet material as detailed below.

RANGE	COLOUR	FINISH
ALTA PTO (GALLERY ONLY)	Matt Paint To Order	Matt Painted MDF
ALTA GLOSS DUSK GREY	Gloss Dusk Grey	Gloss Painted MDF
ALTA GLOSS MUSSEL	Gloss Mussel	Gloss Painted MDF
ALTA GLOSS PEARL GREY	Gloss Pearl Grey	Gloss Painted MDF
ALTA GLOSS PURE WHITE	Gloss Pure White	Gloss Painted MDF

RANGE	COLOUR	FINISH
ALTA MATT ANTHRACITE	Matt Anthracite	Matt Painted MDF
ALTA MATT DARK WALNUT	Matt Dark Walnut	Timber Effect MDF
ALTA MATT PURE WHITE	Matt Pure White	Matt Painted MDF
ALTA MATT RUSTIC OAK	Matt Rustic Oak	Timber Effect MDF

RANGE	COLOUR	FINISH
ASHBOURNE IVORY*	Ivory (F)	PVC Wrapped MDF
	Cabinet Matched (R)	Matt MFC
ASHBOURNE PTO (GALLERY ONLY)	Matt Paint To Order	Matt Painted PVC Wrapped MDF
AUSTIN*	Painted Ivory (F)	Painted (Planked/Plain) Shelving Panels (Plain/Plain)
	Cabinet Matched (R)	Matt MFC
AUSTIN PTO (GALLERY ONLY)	Matt Paint To Order	Matt Painted Ash Veneer
CALGARY	Cabinet Matched	Matt MFC
CRANBROOK COBBLE GREY*	Cobble Grey	PVC Wrapped MDF
CRANBROOK IVORY*	Ivory (F)	PVC Wrapped MDF
	Cabinet Matched (R)	Matt MFC
CRANBROOK PLATINUM	Platinum	PVC Wrapped MDF
CRANBROOK SAGE	Sage	PVC Wrapped MDF
CRANBROOK STONE	Stone	PVC Wrapped MDF
GEORGIA OAK	Cabinet Matched	Matt MFC
HACIENDA CHAMPAGNE	Avola Champagne	Matt MFC
HACIENDA IVORY	Avola Ivory	Matt MFC
HACIENDA WHITE ASH	Avola White Ash	Matt MFC
MEDFORD	Cabinet Matched	Matt MFC
MINNESOTA	Avola Grey	Textured Matt MFC
NEW ENGLAND PTO (GALLERY ONLY)	Matt Paint To Order	Matt Painted Ash Veneer
NEW YORK GLOSS CASHMERE	Gloss Cashmere	Gloss Painted MDF
NEW YORK GLOSS DUSK GREY	Gloss Dusk Grey	Gloss Painted MDF
NEW YORK GLOSS IVORY	Gloss Ivory	Gloss Painted MDF
NEW YORK GLOSS PEARL GREY	Gloss Pearl Grey	Gloss Painted MDF
NEW YORK GLOSS WHITE	Gloss White	Gloss Painted MDF

RANGE	COLOUR	FINISH
NEW YORK MATT ANTHRACITE (GALLERY ONLY)	Matt Anthracite	Matt Painted MDF
NEW YORK PTO (GALLERY ONLY)	Matt Paint To Order	Matt Painted MDF
NEWPORT*	Ivory(F)	Matt PVC (Plinth MFC)
	Cabinet Matched (R)	Matt MFC
OAKHAM*	Blonde Oak (F)	Veneered (Planked/Plain) Shelving Panels (Plain/Plain)
	Cabinet Matched (R)	Matt MFC
OREGON CREAM	Cabinet Matched	Matt MFC
OREGON DOVE GREY	Cabinet Matched	Matt MFC
OREGON WHITE	Cabinet Matched	Matt MFC
PLAZA CASHMERE	Cashmere Textured	Matt MFC
PLAZA COBBLE GREY	Cobble Grey Textured	Matt MFC
PLAZA MUSSEL	Mussel Textured	Matt MFC
PLAZA PORCELAIN	Porcelain Textured	Matt MFC
PLAZA STONE	Stone Textured	Matt MFC
QUADRA COBBLE GREY	Matt Cobble Grey	PVC Wrapped MDF
QUADRA WHITE	Matt White	PVC Wrapped MDF
VIRGINIA OAK	Cabinet Matched	Matt MFC
WEXFORD PTO (GALLERY ONLY)	Matt Paint To Order	Matt Painted Ash Veneer
WOODBURY ANTHRACITE	Gloss Anthracite	Gloss Painted MFC
WOODBURY CASHMERE	Gloss Cashmere	Gloss Painted MFC
WOODBURY IVORY	Gloss Ivory	Gloss Painted MFC
WOODBURY PLATINUM	Gloss Platinum	Gloss Painted MFC
WOODBURY WHITE	Gloss White	Gloss Painted MFC

PTO = Paint To Order

* Colour/Finish is different between F and R codes as detailed by the identified ranges.

RANGE PANEL SPECIFICATION (R/F PANELS ONLY)*

RANGE	COLOUR	FINISH
INLINE SELECT	Gloss Mussel	Gloss Painted MDF
INLINE SELECT	Gloss Pure White	Gloss Painted MDF
INLINE SELECT	Gloss Dusk Grey	Gloss Painted MDF
INLINE SELECT	Gloss Pearl Grey	Gloss Painted MDF
INLINE SELECT	Matt Anthracite	Matt Painted MDF
INLINE SELECT	Matt Dark Walnut	Timber Effect MDF
INLINE SELECT	Matt Pure White	Matt Painted MDF
INLINE SELECT	Matt Rustic Oak	Timber Effect MDF
INLINE TREND	Gloss Ice Platinum	Gloss Painted MFC
INLINE TREND	Gloss Ice Anthracite	Gloss Painted MFC
INLINE TREND	Gloss Ice Cashmere	Gloss Painted MFC
INLINE TREND	Gloss Ice Ivory	Gloss Painted MFC
INLINE TREND	Gloss Ice White	Gloss Painted MFC
INLINE FORM	Matt Avola Champagne	Matt MFC
INLINE FORM	Matt Avola Grey	Textured Matt MFC
INLINE FORM	Matt Avola Ivory	Matt MFC
INLINE FORM	Matt Avola White Ash	Matt MFC
INLINE FORM	Matt Blonde Oak	Matt MFC
INLINE FORM	Matt Cashmere Textured	Matt MFC
INLINE FORM	Matt Cobble Grey Textured	Matt MFC
INLINE FORM	Matt Mussel Textured	Matt MFC
INLINE FORM	Matt Porcelain Textured	Matt MFC
INLINE FORM	Matt Stone Textured	Matt MFC

* R = Replacement End Matched
F = Frontal Matched

RECOMMENDED CORNICE AND PELMET

GENERIC CORNICE AND PELMET CODES

Generic codes are available that will allocate the recommended cornice or pelmet style automatically to each range.

	Frontal matched code	Cabinet matched code
Cornice	CORF	CORC
Pelmet	PELF	PELC

* Specifications match the Range Panel Specification on the previous page except for Newport and Hacienda which are supplied cabinet matched.



Modern Tangent Cornice
CORT30P/CORT30V
(Calgary, Cranbrook, Georgia, Newport & Rockfort only)

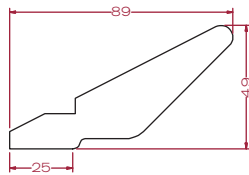

Modern Tangent Pelmet
UPST30P/UPST30V
(Calgary, Cranbrook, Georgia, Newport & Rockfort only)



Tall Foil Wrapped Cornice
CORT30V
(Ashbourne only)
CORT30PTO
(Ashbourne PTO only)

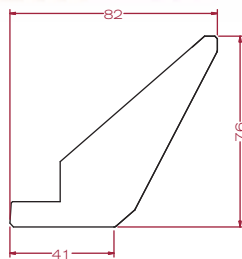

Square Foil Wrapped Pelmet
UPST30V
(Ashbourne only)
UPST30PTO
(Ashbourne PTO only)

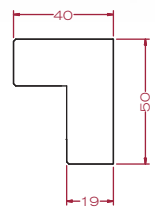

Tall Cornice
CORCT30V
(Austin and Oakham, only)
CORCT30VPTO
(Austin PTO, New England PTO and Wexford PTO only)

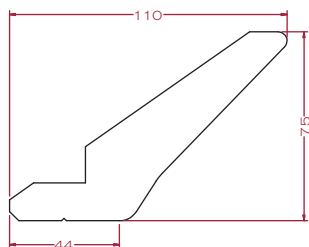

Square Pelmet
UPSCS30V
(Austin and Oakham, only)
UPSCS30PTO
(Austin PTO, New England PTO and Wexford PTO only)

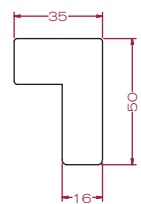

Universal Cornice and Pelmet
CORPEL30/CORPEL30F
CORPEL30G/CORPEL30PTO
(Alta PTO, Ashbourne, Calgary, Cranbrook, Georgia, Newport, New York, Virginia & Woodbury only)

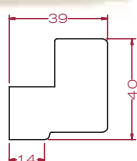

Square Universal Cornice and Pelmet
CORPEL30F
(Alta Gloss, Alta Matt, Minnesota, Plaza & Quadra only)

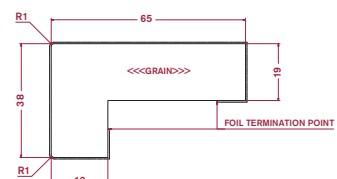

Please note: each range is only linked to certain styles of plinth, cornice and pelmet.

RECOMMENDED CORNICE AND PELMET

These are supplied automatically when generic codes are shown.

Range	Cabinet matched		Frontal matched	
	Cornice CORC	Pelmet PELC	Cornice CORF	Pelmet PELF
Alta	n/a	n/a	CORPEL30F	CORPEL30F
Ashbourne	CORT30P	UPST30P	CORT30V	UPST30V
Austin	CORT30P	UPST30P	CORCT30V	UPSCS30V
Calgary White	CORT30P	UPST30P	n/a	n/a
Cranbrook	CORT30P	UPST30P	CORT30V	UPST30V
Georgia	CORT30P	UPST30P	CORT30P	UPST30P
Hacienda	CORPEL30	CORPEL30	n/a	n/a
Medford	CORPEL30	CORPEL30	CORPEL30	CORPEL30
Minnesota	n/a	n/a	n/a	n/a
New York	n/a	n/a	CORPEL30F	CORPEL30F
New England	n/a	n/a	CORCT30V	UPSCS30V
Newport	CORT30P	UPST30P	n/a	n/a
Oakham	CORT30P	UPST30P	CORCT30V	UPSCS30V
Oregon	CORPEL30	CORPEL30	n/a	n/a
Plaza	n/a	n/a	CORPEL30F	CORPEL30F
Quadra	n/a	n/a	CORPEL30F	CORPEL30F
Virginia	CORPEL30	CORPEL30	CORPEL30	CORPEL30
Wexford	n/a	n/a	CORCT30V	UPSCS30V
Woodbury	n/a	n/a	CORPEL30F	CORPEL30F

FINISHING TOUCHES

SPICE DRAWERS & SHELVES

Spice Drawer

Set of three for 500mm dresser cabinets.
Beech drawer. Frontal available in melamine cabinet colours.

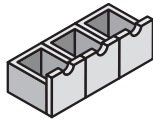

	Code
Beech	SPICE5

Spice Drawer

Single for 500mm dresser cabinets.
Beech drawer with ranged drawer front.

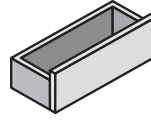

	Code
Beech	SPICE1

Spice Drawer

For 150mm wide Spice/Wine Rack Cabinets.
Beech drawer. Frontal available in melamine cabinet colours.



	Code
Beech	SPICE15

Floating Shelves

Shelf pre-routed to accept the supplied concealed shelf support brackets.
10KG per shelf weight limit. Wall should be reinforced to support the shelves.



Available in Dark Oak, Matt Cashmere and Matt Stone.

Suitable for use in utilities with the Deluxe Hanging Rail (see below).

Dimensions	Code
600 x 300 x 38mm	FLSH6PK
900 x 300 x 38mm	FLSH9PK

Shelving Panel

Available in melamine cabinet colours.



Dimensions	Code
2600x352x18mm	SHPANEL2618C

Shelf Bracket

Height: 121mm
Depth: 108mm
Width: 32mm



Adjustable. Max shelf thickness 30mm. Use one bracket every 600mm.

Code
BRKDECSH

Arrow Shelf Bracket

Height: 108mm
Depth: 180mm
Width: 18mm

Adjustable. Max 40mm shelf thickness.

Use one bracket every 600mm.

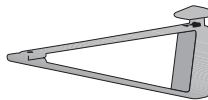

Code
SHELFBRKSS

Deluxe Hanging Rail

Available in set sizes can not be cut.

Hanging rail only, order shelf separately if required.

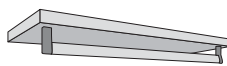

Width	Code
450mm	DXHR45K
600mm	DXHR6K
900mm	DXHR9K

FINISHING TOUCHES

FILLER PANELS, INTERNAL BASE PANELS, PLINTHS & ACCESSORIES

MFC Back Panel

Available in melamine cabinet colours.

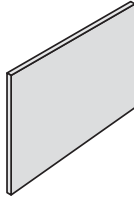

Dimensions	Code
1800x920mm 18mm Thick	BBBP1892C
650x920mm 18mm Thick	BBU6592C

MFC Panels

Available in melamine cabinet colours.



Dimensions	Code
650x920mm 18mm Thick	BBU6592C
2400x750mm 18mm Thick	BLU7523C
970x352mm x 18mm Thick	BWU390C

Tray Space

Available in melamine cabinet colours.

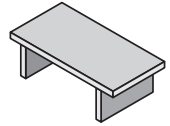

Width	Code
300mm x 570mm x 15mm Thick	TSP3X6P

Plinth

Available in melamine cabinet colours.

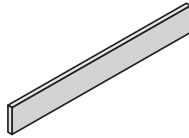

Length x Height	Code
2600x200mm	CONPLINT262C
2600x142mm	CONPLINTHC
650x200mm	RETPLINTH652

Plinth Connector

Pair.
Available in melamine cabinet colours.
To suit 15mm plinths only.

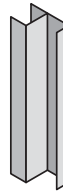

Height	Code
146mm	BRKPLINTH
200mm	BRKPLINTH200

Plinth Seal

Length: 2600mm
Included in CONPLINTHC/R/F codes.
CONPLINTHS for use with cabinet matched CONPLINTH and CONPLINTH262.
PLINTHS18 for use with frontal matched plinths.

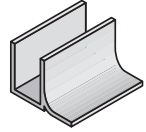

Width	Code
15mm	CONPLINTHS
18mm	PLINTHS18

Edging Tape

Size is range specific.

1.4m (22mm) available in Ashbourne, Austin and Cranbrook.

10m (22mm) available in Cabinet colours.

10m (22mm) available in Hacienda, Minnesota, Plaza and Quadra.

2.4m (25mm) available in Alta, New York and Woodbury.



Code
EDGESTRIPF (Frontal Co-ordinated)
EDGESTRIPR (Replacement End Co-ordinated)
EDGESTRIPC (Cabinet Matched)

FINISHING TOUCHES

GLASS & LAMINATE SPLASHBACKS & UPSTANDS

Coloured Glass Splashback
 Height: 750mm
 Toughened glass. Cannot be cut.
 See page 23 for colour options.



Width	Code
595mm	GLSPLASH675
795mm	GLSPLASH875
895mm	GLSPLASH975

Coloured Glass Upstand
 Height: 140mm
 Pack of two.
 Non-toughened glass.
 Can be cut.
 See page 23 for colour options.



Width	Code
1000mm	GLUP1014

Stainless Steel Splashback
 Height: 750mm
 Thickness: 1mm
 With 6mm back board to align with tiling. (Supplied loose).

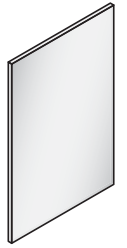

Width	Code
600mm	SBACK675
700mm	SBACK775
900mm	SBACK975

Stainless Steel Splashback
 Height: 750mm
 Thickness: 15mm



Width	Code
600mm	EFB675X
900mm	EFB975X

Laminate Worktop Splashback
 Thickness: 9mm
 Available in all 40mm and 22mm laminate worktops.
 See pages 21-22 for colour options.
 750mm high splashbacks for use behind hobs.

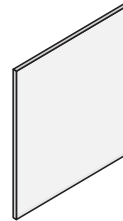

Width	Code
22mm Worktop Finishes	
3000x600mm	WT22SB30X6
600x750mm	WT22SB60X75
40mm Worktop Finishes	
600x750mm	WTSB60X75
3000x750mm	WTSB30X75

Laminate Splashback Accessories
 Available in Black or Silver.
 Compatible with all 22mm and 40mm laminate splashback finishes.
 The colour is not denoted by the worktop finish and must be specified.

	Code
End Cap	WTSBACKEND
Butt Joint	WTSBACKBUT
Corner Joint	WTSBACKCNR

Postformed Worktop Upstand
 Thickness: 12mm

See pages 21-22 for colour options.
 Available in all 40mm and 22mm laminate worktop finishes.

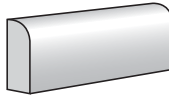

Dimensions	Code
22mm Worktop Finishes	
95x3000mm	PF22UP3095
145x3000mm	PF22UP30145
40mm Worktop Finishes	
95x3000mm	PFUP3095
145x3000mm	PFUP301452

Worktop Edging



Length		Code
3m	40mm standard and premium laminate	WTEDG4
3m	22mm PVC	EDGSTRI30
4.5m	40mm standard PVC	EDGSTRI45

FINISHING TOUCHES WORKTOPS

Bullnose Worktops

See page 21 for colour options.

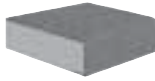

Dimensions	Code
Height 40mm Depth: up to 600mm Max Length: 4020mm	PF40
Height 40mm Depth: 601-870mm Max Length: 3550mm	PF40

Double Bullnose Worktops

See page 21 for colour options.



Dimensions	Code
Height 40mm Depth: 655mm Max Length: 4020mm	DP40
Height 40mm Depth: 900mm Max Length: 3550mm	DP40

PVC Edged Worktops

See page 21 for colour options.

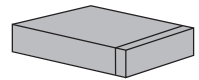

Dimensions	Code
Height 40mm Depth: up to 870mm Max Length: 4020mm	PV40

Double PVC Edged Worktops

See page 21 for colour options.

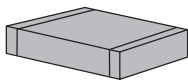

Dimensions	Code
Height 40mm Depth: up to 900mm Max Length: 4020mm	DV40

Premium Worktops with 3mm Radius Edge

See page 22 for colour options.



Dimensions	Code
Height 40mm Depth: up to 600mm Max Length: 3550mm	PR40
Height 40mm Depth: up to 870mm Max Length: 3550mm	PR40

Double Premium Worktops with 3mm Radius Edge

See page 21 for colour options.



Dimensions	Code
Height 40mm Depth: 665mm Max Length: 3550mm	DR40
Height 40mm Depth: 900mm Max Length: 3550mm	DR40

22mm PVC-edged Worktops

See page 21 for colour options.

22mm laminate worktops with 1mm PVC edging. Laminated both sides.



Dimensions	Code
Height 22mm Depth: up to 870mm Max Length: 3000mm	PV22

22mm Double PVC-edged Worktops

See page 21 for colour options.

22mm laminate worktops with 1mm PVC edging. Laminated both sides.



Dimensions	Code
Height 22mm Depth: up to 900mm Max Length: 3000mm	DV22

22mm PVC-edged Worktop Blenders

Available in 22mm worktops only.

See page 21 for colour options. 22mm laminate worktops with 1mm PVC edging. Laminated both sides.

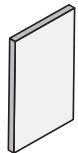

Dimensions	Code
920x650mm	CVB226592
970x352mm	CVB223597
2400x750mm	CVB227524
920x900mm	CVB22992
900x1200mm	CVB221292
900x1800mm	CVB221892
900x2400mm	CVB222492
2400x352mm	CVB222435
2400x150mm	CVB222415

Top Seal Bolt Pack

Pack of 3 bolts.

Includes 14ml tube of colour co-ordinated top seal, applicator and lint free cloth.

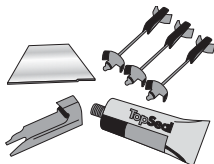

Dimensions	Code
40mm worktops	TOPSEALBOLT
22mm worktops	TOPSEALBLT22

Bullnose Worktop End Caps and Joint Strips

The colour is not denoted by the worktop finish and must be specified.

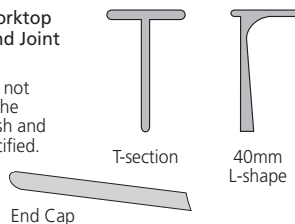

Dimensions	Code
40mm T-section (Aluminium, Black, Brown)	STRIPALT4010
40mm L-shape (Aluminium, Black, Brown)	STRIPALP4010
40mm End Cap (Aluminium, Black, Brown)	STRIPALS4010
40mm PVC Worktop End Cap (Aluminium)	STRIPALP4064

FINISHING TOUCHES

WORKTOP ACCESSORIES

22mm Worktop Blanco Sink Clips

To replace standard sink clips when using 22mm worktops. Pack of 10.



Code
BL453648

Angled Breakfast Bar Leg Light Grey

Height: 870mm
Max weight 150KG. With solid surface worktops use one leg per m² worktop overhang.

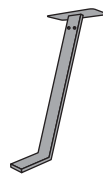

Code
LEGBARANGLE

Breakfast Bar Chrome Leg

60mm Diameter.
870mm High.



Code
LEGBARCX

FINISHING TOUCHES

DRAWER ACCESSORIES

Supra Drawer Box Cream Plastic Cutlery Tray
For use with standard shallow drawers.

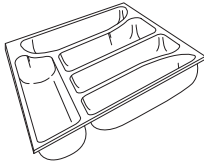

Cabinet Width	Code
400mm 3 compartments	CTRAYSUPR4V
450mm 4 compartments	CTRAYSUPR45V
500mm 4 compartments	CTRAYSUPR5V
600mm 5 compartments	CTRAYSUPR6V

Atira Drawer Box Grey Plastic Cutlery Tray
For use with Atira top drawers in 800, 900 and 1000mm 3 pan drawer cabinets and with internal drawer in 2 pan drawer cabinets.



Cabinet Width	Code
500mm	CTRAYGALL5V
600mm	CTRAYGALL6V
800mm	CTRAYGALL8V
900mm	CTRAYGALL9V
1000mm	CTRAYGALL10V

Atira Drawer Box Grey Plastic Cutlery Tray
For use with single base cabinets with internal drawers.



Cabinet Width	Code
300mm (For use with BU36F 4ID/3IDC)	CTRAYGALL275V
400mm (For use with BU46F 4ID/3IDC)	CTRAYGALL35V
450mm (For use with BU456F 4ID/3IDC)	CTRAYGALL4V
500mm (For use with BU56F 4ID/3IDC)	CTRAYGALL45V
600mm (For use with BU66F 4ID/3IDC)	CTRAYGALL55V
600mm (Full height pull out drawer cabinet) (For use with BU66F2ID)	CTRAYGALL6V

Atira Drawer Box Aluminium Cutlery Tray
Single size cutlery tray designed to be positioned as required within drawer.
Drawer mats are recommended for use with these cutlery trays.
Note: not suitable with BU456F4ID/3IDC.



Cabinet Width	Code
Universal tray width 310mm for all sizes 450, 500, 600mm drawers	CTRAYMIN456
2x Universal tray width 310mm for all sizes 800, 900, 1000mm drawers	CTRAYMIN810

Atira Drawer Box Timber Cutlery Tray
Single size cutlery tray designed to be positioned as required within drawer.
Drawer mats are recommended for use with these cutlery trays.
Note: not suitable with BU456F4ID/3IDC.



Cabinet Width	Code
Universal tray width 310mm for all sizes 450, 500, 600mm drawers	CTRAYTIN456
2x Universal tray width 310mm for all sizes 800, 900, 1000mm drawers	CTRAYTIN810

Internal Drawer for Cupboards and Larders
Height: 108mm
Additional Atira internal drawer.
Supplied with spacers.
Includes runners.

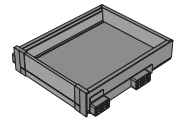

Cabinet Width	Code
300mm	IDWBU3
400mm	IDWBU4
450mm	IDWBU45
500mm	IDWBU5
600mm	IDWBU6

Internal Deep Drawer for Cupboards and Larders
Height 187mm
Additional Atira internal drawer.
Supplied with spacers.
Includes runners.

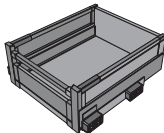

Cabinet Width	Code
300mm	IDDWBU36
400mm	IDDWBU46
450mm	IDDWBU456
500mm	IDDWBU56
600mm (hinged door)	IDDWBU66
600mm (full height pull out drawer cabinet)	IDDWPD6

Internal Drawer for Two Pan Drawers
Height: 92mm
Additional Atira internal drawer.
Includes runners.

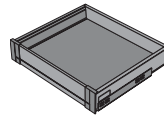

Cabinet Width	Code
500mm	IDWPD5
600mm	IDWPD6
800mm	IDWPD8
900mm	IDWPD9

Drawer Mat
For use with Atira internal and deep pan drawers only.

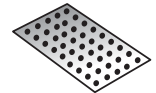

Cabinet Width	Code
300mm	DWMAT3
400mm	DWMAT4
450mm	DWMAT45
500mm	DWMAT5
550mm	DWMAT55
600mm	DWMAT6
800mm	DWMAT8
900mm	DWMAT9
1000mm	DWMAT10

FINISHING TOUCHES

DRAWER ACCESSORIES

Aluminium Pan Drawer Organiser

For use with Atira deep pan drawers and 600mm deep internal pan drawers.



Width	Code
500mm	DW47ORG5
600mm	DW47ORG6
800mm	DW47ORG8
900mm	DW47ORG9
1000mm	DW47ORG10

Orgaflag Pan Drawer Organisers

For use with Atira deep pan drawers and 600mm deep internal pan drawers.



Width	Code
500mm	ORGAF5
600mm	ORGAF6
800mm	ORGAF8
900mm	ORGAF9
1000mm	ORGAF10

Timber Pan Drawer Insert

For use with Atira deep pan drawers and deep internal drawers.

Fits 450-600mm pan drawers. For 800-1000mm drawers, 2 are required.



Code
PANDRWINS

Timber Plate Stack

Fits 276mm 2 pan deep drawers only. Special order. Allow 4 weeks for delivery.



Width	Code
500mm	PDPLATESTK5
600mm	PDPLATESTK6
800mm	PDPLATESTK8
900mm	PDPLATESTK9
1000mm	PDPLATESTK10

Timber Plate Stack

Timber Plate Stack for EKO Timber Drawer Box (276mm deep drawers only) Allow 4 weeks for delivery (Not compatible with New England or Atira drawer box)
Includes: 8 x Wooden Dowels, 1 x Base Board (Gallery only)



Width	Code
500mm	PDPLATESTK5T
600mm	PDPLATESTK6T
800mm	PDPLATESTK8T
900mm	PDPLATESTK9T
1000mm	PDPLATESTK10T

Internal Drawer Clip

For use with Atira internal drawers within pan drawer cabinets. To be ordered separately if required.

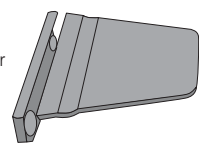

Code
IDCLIP

Timber Roll Dispenser for Atira Drawer Box

(Not available with EKO Timber drawer boxes)
Width 150mm
(Gallery only)

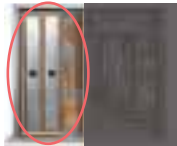

Code
ROLLHOLDINS

Timber Knife Block for Atira Drawer Box

Knives not included
(Not available with EKO Timber drawer boxes)
Width 150mm
(Gallery only)



Code
KNIFEINS

Timber Spice Rack for Atira Drawer Box

(Not available with EKO Timber drawer boxes)
Width 150mm
(Gallery only)



Code
SPICEINS

Timber Slideable Tray for Atira Drawer Box

(Not available with EKO Timber drawer boxes)
Width 110mm
(Gallery only)



Code
SLIDEINS

Top Drawer Timber Accessory Systems for Atira Drawer Box

(Not available with EKO Timber drawer boxes)
For use with 500-600mm cutlery drawers
(Gallery only)



Universal Combined Width	Code
260mm	DRWTACC1
Includes: Slideable Tray & Roll Dispenser	
260mm	DRWTACC2
Includes: Slideable Tray & Knife Block	
260mm	DRWTACC3
Includes: Slideable Tray & Spice Rack	
300mm	DRWTACC4
Includes: Cutlery Tray & Knife Block (600mm drawer only)	
300mm	DRWTACC5
Includes: Cutlery Tray & Roll Dispenser (600mm drawer only)	
300mm	DRWTACC6
Includes: Cutlery Tray & Spice Rack (600mm drawer only)	

Top Drawer Timber Accessory Systems for Atira Drawer Box

(Not available with EKO Timber drawer boxes)
For use with 800-1000mm internal cutlery drawers
(Gallery only)



Universal Combined Width	Code
610mm	DRWTACC7
Includes: Cutlery Tray, Roll Dispenser & Knife Block	
570mm	DRWTACC8
Includes: Cutlery Tray, Knife Block & Slideable Tray	
770mm	DRWTACC9
Includes: x2 Cutlery Trays & Spice Rack	
770mm	DRWTACC10
Includes: x2 Cutlery Trays & Knife Block	
770mm	DRWTACC11
Includes: x2 Cutlery Trays & Roll Dispenser	
410mm	DRWTACC12
Includes: Roll Dispenser, Slideable Tray & Knife Block	
410mm	DRWTACC13
Includes: Spice Rack, Slideable Tray & Knife Block	
410mm	DRWTACC14
Includes: Spice Rack, Slideable Tray & Roll Dispenser	

FINISHING TOUCHES

CABINET STORAGE ACCESSORIES

Two Tier Bottle Rack

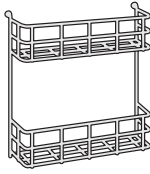

Height x Width x Depth	Code
400x382x100mm	DOORBASKTCH

Single Tier Bottle Rack



Height x Width x Depth	Code
100x382x100mm	DOORBASKSCH

Chrome Wine Rack Shelf

Open display units only.

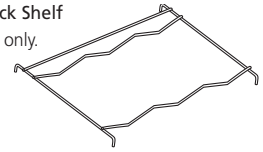

Width	Code
500mm Cabinet	WRSHELF5CX

Chrome Pull-out Larder Baskets

300mm Larder Cabinets only.

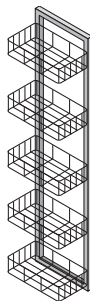

Code
PLUBASKCX

½ Carousel Basket

Pair.

For use with 1000mm Corner Base with 500mm door (CB106FA/DA) and 1200mm corner base with 600mm door (CB126FA/DA). Order units separately.
Diameter 850mm.



Code
CAROBASKCH

¾ Chrome Carousel Basket

Diameter 700mm

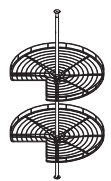

Code
CAROBASKCX

Chrome Basket with Runners

Depth 450mm

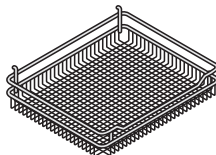

Width	Code
500mm Cabinet	PBASK5CX
600mm Cabinet	PBASK6CX

Le Mans Pull-out for Corner Base Cabinets

Handing required.

For use with Corner Base Cabinets. To be installed in corner cabinets as detailed below (ordered separately).
For corner cabinet with a door on the left hand side, order left handing, vice versa for right.

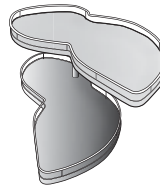

Door/Cabinet	Code
400mm Door (800 and 1000mm Cabinets)	LEMANSU4GR
500mm Door (1000mm Cabinets)	LEMANSU5GR

Le Mans Pull-out for Corner Larder Cabinets

Handing required.

For use with Corner Larder Cabinets with 500mm doors. To be installed in CNLU106 and CNLU10623 (ordered separately). Includes two LeMans (4 trays) and one LeMans axle.

For corner cabinet with a door on the left hand side, order left handing, vice versa for right.

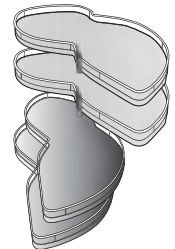

Code
LEMANSAX5GR

Wicker Basket

Pack of 2. Supplied with runners.

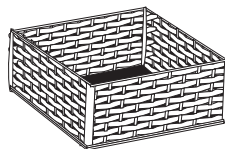

Width	Code
500mm Cabinet	WICKBASK

FINISHING TOUCHES

ARENA CABINET STORAGE ACCESSORIES

ARENA 3/4 Carousel

For use with
LSB991PCF &
LSB991PCD
(Gallery only)



Code
CARBASK34AR

ARENA Le Mans Pull-out for Corner Base Cabinets

Handing required.

For use with Corner Base
Cabinets. To be installed in
corner cabinets as detailed
below (ordered separately).

For corner cabinet with a door on the left hand side,
order left handing, vice versa for right.

(Gallery only)



Door/Cabinet	Code
400mm Door (800 and 1000mm cabinets)	LEMANSU4AR
450mm Door (900mm cabinets)	LEMANSU45AR
500mm Door (1000mm cabinets)	LEMANSU5AR
600mm Door (1000mm and 1200mm cabinets)	LEMANSU6AR

ARENA Le Mans Axle

Centre pole to allow use of Le Mans pull outs in
Corner Larder Cabinets
(x2 Le Mans units to be ordered separately)

Code
LEMANSAXLE

ARENA 300mm Pull Out Larder - 5 Baskets

(Gallery only)



Code
LUBASK5AR

ARENA 500mm Pull Out Larder - 5 Baskets

(Gallery only)



Code
PLBASK5AR

ARENA 500mm Cranked Pull Out Larder - 5 Baskets

(Gallery only)



Code
PLBASK5CRKAR

ARENA 150mm Base Pull Out - 2 Baskets

(Gallery only)



Code
PLBUBASK15AR

ARENA 150mm Base Pull Out Basket & Towel Rail

(Gallery only)



Code
PLBUBASKTRAR

ARENA 300mm Base Pull Out - 2 Baskets

Please state handing
required
For right hand fixings
order LH, for left hand
fixings order RH
(Gallery only)



Code
PLBUBASK3AR

iMove Pull Down Basket

For easy access to wall
cabinets

724 and 900mm high
cabinets only.

Not compatible
for use with
bifold cabinets.

Available in Gallery
Premium only.



Width	Code
500mm	IMOVE5
600mm	IMOVE6

FINISHING TOUCHES

CABINET STORAGE ACCESSORIES & WASTE DISPOSAL

30-Litre Ecobin

Contains three 10 litre bins.
 Height: 422mm
 Depth: 480mm
 Minimum Cabinet:
 110° hinge - 300mm cabinet
 170° hinge - 400mm cabinet



Code
ECOBIN3X10

40-Litre Ecobin

Contains one 20-Litre and two 10-Litre Bins
 Height: 320mm
 Depth: 480mm
 Minimum Cabinet:
 110° hinge - 400mm cabinet
 170° hinge - 500mm cabinet



Code
ECOBIN4

60-Litre Ecobin

Contains one 34-Litre and two 17-Litre Bins
 Height: 540mm
 Depth: 492mm.
 Full height units only.
 600mm Cabinet.
 Can be pull out or fitted behind hinged door.
 (For pull out version, the frontal, cabinet and bin need to be ordered separately).



Code
ECOBIN60L

Deluxe Chrome Swing

Min 400mm Cabinet.
 Contains one 12-Litre Bin.
 Do not use with 170° hinge.
 Height: 526mm.
 Diameter: 360mm.



Code
SWINGBINCH

Triple Recycling Bin

500mm/600mm Cabinet.
 Contains one 19-Litre, one 12-Litre and one 9-Litre Bin.
 Do not use with 170° hinge.
 Height: 525mm
 Depth: 450mm



Code
RECYCLEBIN

36-Litre Under Sink Waste Bin

Contains two 18-Litre bins.
 Height: 392mm
 Depth: 480mm
 Suitable for 400mm hinged door cabinet.
 Space saving waste available for single bowl sinks when using this waste bin - POPUPSAVER



Code
BIN435L

64-Litre Premium Waste Bin

Contains two 32-Litre bins.
 Height: 570mm
 Depth: 515mm
 Suitable for 500mm cabinet with pull-out door.
 Available as pull out (front fixed) only.
 Order frontal, cabinet and waste bin separately.



Code
BIN564L

85-Litre Premium Waste Bin

Contains two 32-Litre bins and one 21-Litre bin.
 Height: 570mm
 Depth: 515mm
 Suitable for 600mm cabinet with pull-out door.
 Available as pull out (front fixed only).
 Order frontal, cabinet and waste bin separately.



Code
BIN685L

FINISHING TOUCHES FITTINGS

Ventilation Grill
Flow rate: 200cm²

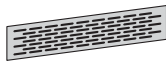

Dimensions	Code
80x550mm	VENTGRILL200

Replacement Base Cabinet Leg
Pack of four.

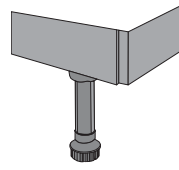

Code
LEG15

Double Towel Rail

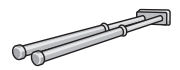

Depth	Code
430mm	METALTRAIL

Single Sink Cabinet Liner

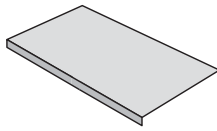

Width	Code
500mm	SU5LINER
600mm	SU6LINER

Double Sink Cabinet Liner with Middle Centre Post

To be used on corner base units if the centre post is in the middle of the unit.

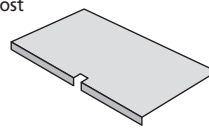

Width	Code
800mm	SU8LINER
900mm	SU9LINER
1000mm	SU10LINER
1200mm	SU12LINER

Double Sink Cabinet Liner with Offset Centre Post

To be used on corner base units with offset centre post.

Handing required*.

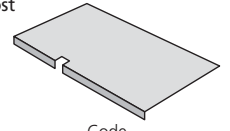

Width	Code
800mm with 300mm Door	SULINER835U
800mm with 400mm Door	SU8LINER8
800mm with 500mm Door	SULINER835U
900mm with 450mm Door	SU9LINERU
1000mm with 400mm Door	SULINER1046U
1000mm with 500mm Door	SU10LINERU
1000mm with 600mm Door	SULINER1046U
1200mm with 600mm Door	SU12LINERU
1200mm with 300mm and 400mm Doors	SULINER1234U
1200mm with Two 400mm Doors	SULINER1244U

Frontal Connecting Brackets

Pack of two.

Code
BRKLCB

What Lock

Magnetic lock system 2 x locks per pack



Code
MAGLOCK

Soft Close Hinge Buffers

Clip on hinge buffers for Titus Hinges.



	Code
110° Hinge (Pack of 5)	SOFTCLOSE5
110° Hinge (x1)	SMOVE1110
170° Hinge (x1)	SOFTCL1170
45° Unit (x1)	FPK048
St. Steel Glazed Units (x1)	SOFTCLOSEGL

Hob Shields

Recommended for use in full height base cabinets and pan drawers cabinets that are used underneath a hob.

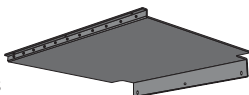

Cabinet Width	Code
600mm	HOBSHIELD6
800mm	HOBSHIELD8
900mm	HOBSHIELD9
1000mm	HOBSHIELD10

Hinge Repair Kit

To re-fit hinges if cabinet has chipped.

	Code
Pack of 2	HINGEREP2
Pack of 12	HINGEREP12

Cover Caps

Order if additional cover caps are required

Spec	Code
35mm Hinge Hole (pack of 2)	COVCAPHINGE
20mm Adhesive (pack of 9)	COVCAP20
15mm Cam (pack of 4)	COVCAPCAM
5mm Screw Hole (pack of 20)	COVCAP5
Sensys Hinge (Gallery only) (pack of 2)	COVCAPARMIM

* Style B corner base: hand sink liner opposite to corner base. Style C corner base: hand sink liner same as corner base. Style F corner base: hand sink liner opposite to corner base.

FINISHING TOUCHES

POP UP SOCKETS & LIGHTING

ALA Illuminated Shelves

Complete with touch LED dimmer switch, night light, memory function and safety function all in one. Includes integrated driver.



Width	Code
600mm	SHELFILU65W
900mm	SHELFILU98W

Pop Up Socket

Three plug sockets and two USB ports. Installation hole 90-92mm. Supplied with 2.5m long cable.



Code
POPUPSOCKU

EVOLine® Pop Up Socket

Three plug sockets and two USB ports. Premium flush finished stainless steel top. Installation hole 102mm. Supplied with 3m long cable.



Code
POPUPSOCKUSS

LED Plinth Lights

Four lights/ 1.5m cable. Driver included – maximum allowance of 4w (x22 lights). Not suitable in front of appliances.



Wattage	Code
0.72w Cool White	LEDSQPLINTCW
0.72w Warm White	LEDSQPLINTWW

HD LED InCabinet Strip Lights - 12v

Order driver separately POWDRIVE15 (Suitable for pan drawers and single wall cabinets)



Width	Wattage	Code
300mm	3.9w	PANLIGHT3
400mm	3.9w	PANLIGHT4
450mm	4.3w	PANLIGHT45
500mm	5.5w	PANLIGHT5
600mm	7.8w	PANLIGHT6
800mm	9.1w	PANLIGHT8
900mm	9.1w	PANLIGHT9
1000mm	12.4w	PANLIGHT10

HD Driver - 12v

For use with InCabinet Strip Lights. Connected wattage of lights must not exceed maximum wattage of driver.

Code
POWDRIVE15

TrioTone Surface Light

Surface mounted or recessed. Includes switch to select cool, neutral or warm light. Order driver separately LEDHDTFORM6. Supplied with 2.5m cable.



Wattage	Code
1.65w	LEDSURFTRIO

TrioTone Triangle Light

Order driver separately LEDHDTFORM6. Includes switch to select cool, neutral or warm light.



Wattage	Code
1.65w	DELTATRIO

HD Square Light

Surface mounted. Order driver separately LEDHDTFORM6. Supplied with 2.5m cable.



Wattage	Code
1.8w Cool White	LEDSQSURFHD
1.8w Warm White	LEDSQSURHDWW

SLS Quadra Under Cabinet Light

Order driver separately LEDHDTFORM6. Cable length 1.5m.



Wattage	Code
2.4w Cool White	LEDUCABSLSCW
2.4w Warm White	LEDUCABSLSWW

HD 24v Driver

Six connections. Combined wattage of connected lights must not exceed driver wattage. Supplied with 1.5m driver connection cable.



Wattage	Code
15w	LEDHDTFORM6

LED Dimmer

HD Driver with Remote Control On/Off Function - 24v



Spec	Code
30w	LEDHDDIMMER

FINISHING TOUCHES LIGHTING

HD Delta Light

Order driver separately
LEDHDTFORM6.
Supplied with 2.5m cable.



Wattage	Code
1.65w Cool White	LEDELTAHD
1.65w Warm White	LEDELTAHDWW

HD Delta Light

With on/off touch sensor.
Can switch up to two
non-sensor HD lights.
Order driver separately
LEDHDTFORM6.
Supplied with 2.5m cable.



Wattage	Code
2.15w Cool White	LEDELTAHDS
2.15w Warm White	LEDELTHDSWW

HD 24v Driver

Six connections.
Combined wattage
of connected lights
must not exceed
driver wattage.
Supplied with 1.5m driver
connection cable.



Wattage	Code
15w	LEDHDTFORM6

Example 1

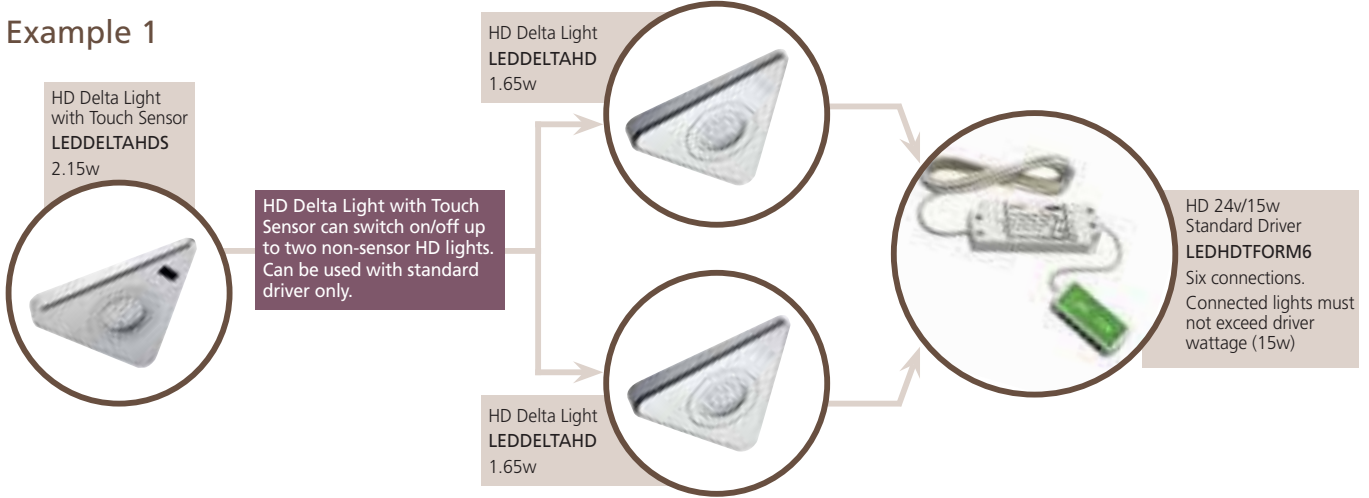

FINISHING TOUCHES LIGHTING

GX53 LED Triangle Light (240V)

Surface Mounted.
Driver not required.
Connect directly to mains.

Up to 6 lights can be connected together using a distributor block and plug (DISTRIBGX53).



Wattage	Code
240V/3w Cool White	LEDTRICW
240V/3w Warm White	LEDTRIWW

GX53 LED Round Light (240V)

Surface mounted or recessed.

Driver not required.
Connect directly to mains.

Up to 6 lights can be connected together using a distributor block and plug (DISTRIBGX53).



Description	Code
240V/3w Cool White	LEDSURFACE
240V/3w Warm White	LEDSURFACEWW

GX53 Accessories

Driver has 6 connections, 1500mm cable and 13A plug for direct mains connection.

Combined wattage of connected lights must not exceed driver wattage.



Description	Code
6 Way GX53 Distributor Block	DISTRIBGX53

GX53 Accessories



Description	Code
240V/3w Replacement Bulb	LEDREPBULB

LED Task Strip Light (240V)

Includes 1000mm mains cable and 200mm extension cable.

Driver not required.

Each light can be linked directly together, or with the optional link cable LEDSTRIPCON.



Wattage	Code
240v/2.7w, 250mm	LEDSTRIP25
240v/4.5w, 330mm	LEDSTRIP33
240v/8w, 550mm	LEDSTRIP55

500mm Task Strip Light Link Cable



Code
LEDSTRIPCON

Example 2

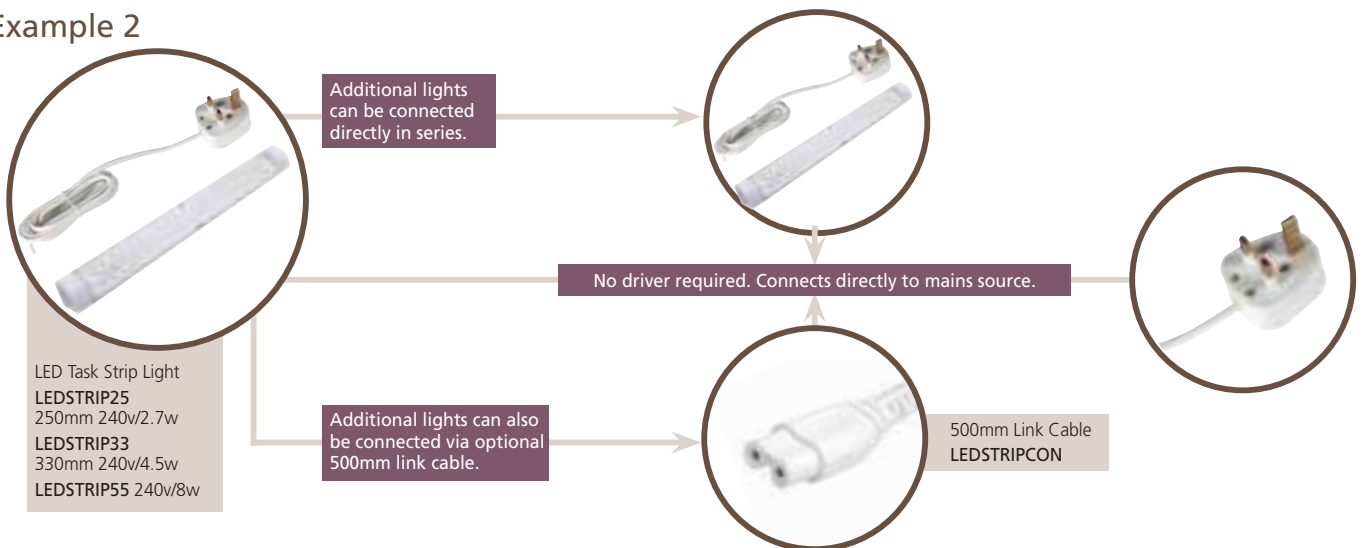

FINISHING TOUCHES LIGHTING

LED Flexible Strip

24v/0.8w.

Order driver separately.
Standard driver
LEDHDTFORM6.

Can be combined with
LEDSWITCH.

Adhesive backing for
easy installation.



Length	Code
500mm Cool White	FLEXI5CW
500mm Warm	FLEXI5WW

LED Flexible Strip

24v/5w.

Order driver separately.
Standard driver
LEDHDTFORM6.

Can be combined with
LEDSWITCH.

Adhesive backing for
easy installation.

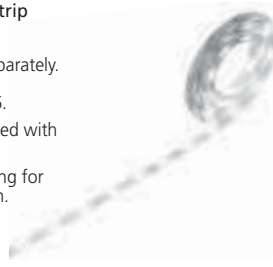

Length	Code
2000mm Cool White	FLEXI20CW
2000mm Warm	FLEXI20WW

Driver Connection Cable

Order extra cables to run
additional LED flexible strip
lights from
one driver.



Length	Code
2.5m	FLEXICON

Link Cable

Can be used to
connect one uncut
flexible strip light to
another.

Order SE10318MCC
to connect cut
strip lights.



Length	Code
1500mm	FLEXILINK15
50mm Link/Corner Cable	FLEXILINK50

Flexible Strip Connector

12mm x 8mm.

To connect one off-cut to a
full flexible strip light.

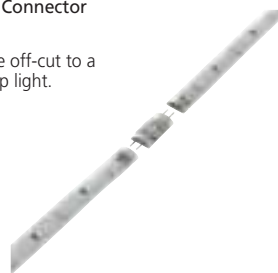

Code
SE10318MCC

HD 24v Driver

Six connections.

Combined wattage
of connected lights
must not exceed
driver wattage.

Supplied with 1.5m driver
connection cable.



Wattage	Code
15w	LEDHDTFORM6

Example 3

LED Cool White/Cool
Blue Flexible Strips
FLEXI5CW/WW
500mm 24v
FLEXI20CW/WW
2m 12v/5w

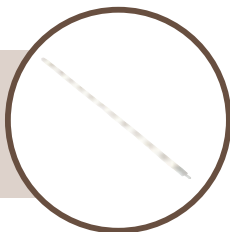

HD 24v/15w Standard Driver
LEDHDTFORM6
Six connections.
Connected lights must not
exceed driver wattage (15w)

Additional lights can be connected directly together in series without a link or via a 50mm link (for corner return) or 1500mm link. An offcut of a flexible strip light can be connected once to a full flexible strip with the strip connector piece.

Link/Connector Cables
50mm Corner Cable
FLEXILINK50
1500mm Straight Cable
FLEXILINK15
12mm Flexible Strip
Connector
SE10318MCC

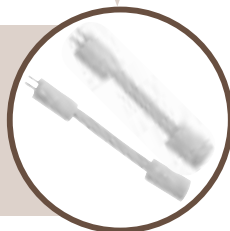

For every independent run of strip lights, a driver connection lead is required. Maximum of six per driver.



2.5m Driver
Connection Cable
FLEXICON

FINISHING TOUCHES

LED STRIP LIGHTS & ACCESSORIES

LED DuoFlex Flexible Strip Lights with Remote & Receiver Pack

Complete kit to create a single continuous light run with remote control switch.
 x1 2m Light Strip
 x1 2.5m Connection Cable
 x1 Receiver
 x1 Remote (excluding batteries)
 x1 Driver 24v
 (Potential to create 2 separate runs, order additional light and cable separately)



Spec	Code
7.5w - 2m	DUOFLXRC2P

LED DuoFlex Flexible Strip Lights

Additional strip lights
 Must order Inline Switch Pack or Remote & Receiver Pack then add additional strips
 Can be connected together to create required length.



Spec	Code
3.75w - 1m (x2 500mm)	LEDDUOFLEX1
7.5w - 2m§	LEDDUOFLEX2

Driver Connection Cable

Connects each strip light to driver when used individually



Spec	Code
2.5m	FLEXRGBCON25

Example 4



Duo Flexible Strip Pack with Remote Control and Receiver
DUOFLXC2P 2000mm
 Inc. 2.5m connection cable and 24v driver

Additional lights can be connected directly to each other. Duo flexible strip packs supplied with 24v driver



Duo flexible lights can be switched between warm and cool white

FRONTALS

	Size	Code	
720mm Wall/Full Height Frontal	150mm	KDRFH15	
	300mm	KDRFH3	
	400mm	KDRFH4	
	450mm	KDRFH45	
	500mm	KDRFH5	
	600mm	KDRFH6	
720mm Dummy Drawer and Door For LSB99D	300mm	KDRDDL3CB	
	400mm	KDRDD4LCB	
896mm Tall Wall Cabinet Frontal	300mm	KDRW63	
	400mm	KDRW64	
	450mm	KDRW645	
	500mm	KDRW65	
	600mm	KDRW66	
159mm Drawer Frontal	300mm	KDWDF3	
	400mm	KDWDF4	
	450mm	KDWDF45	
	500mm	KDWDF5	
	600mm	KDWDF6	
	800mm	KDWDF8	
	900mm	KDWDF9	
183mm Drawer Frontal	400mm	KDWPF4	
	500mm	KDWPF5	
557mm Drawer Line	300mm	KDRDL3	
	400mm	KDRDL4	
	450mm	KDRDL45	
	500mm	KDRDL5	
	600mm	KDRDL6	
	800mm	KDRDL8	
	900mm	KDRDL9	
	1000mm	KDRDL10	
	276mm Three Pan Drawer Cabinet Frontal	500mm	KDWDPF5
		600mm	KDWDPF3
800mm		KDWDPF83	
900mm		KDWDPF93	
1000mm		KDWDPF103	
358mm Two Pan Drawer and Bi-fold Bottom Frontal	500mm	KDROCH536B	
	600mm	KDROCH636B	
	800mm	KDROCH836B	
	900mm	KDROCH936B	
1228mm Larder Cabinet Frontal	300mm	KDRLU3	
	500mm	KDRLU5	
450mm Tall Appliance Frontal	600mm	KDRAH	
557mm Oven and Integrated Appliance Cabinet Frontal	47mm	KFAAH4	
	72mm	KFAAH7	
	120mm	KFAAHB	
	296mm	KDWDPF6	
	450mm	KDRAH	
	560mm	KDRDL6	
	720mm	KDRFH6	
	930mm	KDRIF609	
	1018mm	KDRIF610	
	1108mm	KDRIF611	
1228mm	KDRIF612		

	Size	Code
296mm Bridging Cabinet Frontal	600mm	KDROCH63
276mm Bridging Cabinet Frontal	1000mm	KDROCH1028
358mm Bi-fold Cabinet Top Frontal and Bridging Cabinet Frontal	500mm	KDROCH536T
	600mm	KDROCH636T
	800mm	KDROCH836T
	900mm	KDROCH936T
720mm Glazed Wall Cabinet Frontal See page 11 for glazed frontal availability.	400mm	KDRGW3
	500mm	KDRGW2
896mm Glazed Wall Cabinet Frontal See page 11 for glazed frontal availability.	500mm	KDRGW6
1025mm Glazed Dresser Cabinet Frontal See page 11 for glazed frontal availability.	500mm	KDRWD2
720mm Metallic Framed Glazed Frontal	400mm	KDRGW3SL
	500mm	KDRGW2SL

Drawer Box (Atira)	
Code	Description
INNO3BOX	300mm Full Extension/Soft Close Drawer Box
INNO4BOX	400mm Full Extension/Soft Close Drawer Box
INNO45BOX	450mm Full Extension/Soft Close Drawer Box
INNO5BOX	500mm Full Extension/Soft Close Drawer Box
INNO6BOX	600mm Full Extension/Soft Close Drawer Box
METAL3BOX855	800mm Pack of 3 Drawers (Drawer bottoms not included)
DWBOTM8P355	800mm Pack of 3 Drawer bottoms
METAL1BOX955	900mm Single Drawer (Drawer bottom not included)
DWBOTM9P155	900mm Single Drawer Bottom
METAL3BOX155	1000mm Pack of 3 Drawers (Drawer bottoms not included)
DWBOTM10P355	1000mm Pack of 3 Drawer Bottoms
PD14CON5	500mm Pan Drawer Box Conversion Kit for 3 Drawer Units
PD14CON6	600mm Pan Drawer Box Conversion Kit for 3 Drawer Units
PD14CON8	800mm Pan Drawer Box Conversion Kit for 3 Drawer Units
PD14CON9	900mm Pan Drawer Box Conversion Kit for 3 Drawer Units
PD14CON10	1000mm Pan Drawer Box Conversion Kit for 3 Drawer Units
PD17CON5	500mm Pan Drawer Box Conversion Kit for 2 Drawer Units
PD17CON6	600mm Pan Drawer Box Conversion Kit for 2 Drawer Units
PD17CON8	800mm Pan Drawer Box Conversion Kit for 2 Drawer Units
PD17CON9	900mm Pan Drawer Box Conversion Kit for 2 Drawer Units
PD17CON10	1000mm Pan Drawer Box Conversion Kit for 2 Drawer Units

Drawer Box (Supra - 15mm Vista) – Includes drawer runners	
Code	Description
SUPRA3BOX15	300mm Drawer Box
SUPRA4BOX15	400mm Drawer Box
SUPRA45BOX15	450mm Drawer Box
SUPRA5BOX15	500mm Drawer Box
SUPRA6BOX15	600mm Drawer Box

Drawer Box (Supra - 18mm Vista) – Includes drawer runners	
Code	Description
SUPRA3BOX18	300mm Drawer Box
SUPRA4BOX18	400mm Drawer Box
SUPRA45BOX18	450mm Drawer Box
SUPRA5BOX18	500mm Drawer Box
SUPRA6BOX18	600mm Drawer Box

All codes include the frontal only. Please specify hinges and handles separately if required.
For New York and Inline frontals, please specify handing (hand by hinge) and also if it's for a base or wall cabinet.

15MM VISTA CABINET INSTALLATION

WALL UNITS

Screw through the top and bottom back rails/hardboard back. (2 single/3 double cabinet wall fixings per rail). Fixing points in the bottom rail should be vertically in line with those in the top rail.

Fixing points should be located at each end of the unit as shown, no more than 100mm from the inside face of the unit.

Wall units with two doors may require a further fixing at the mid point of the top rail.

Any screws and other fixings used must be suitable to support units, when loaded, into the material to which they are to be fitted.

Please see separate wall fixings instructions for further information.

IMPORTANT

It is the responsibility of the customer:

- * to ensure that the wall is of a suitable quality and structure to hold the unit fixing in place.
- * to use the proper hardware fittings for the wall type. Screw must be a minimum of 5mm diameter and rawl plug should be appropriate for the wall used by the bracket.

We recommend two screw lengths:

- * 60mm length for plasterboard walls with noggins/patresses.
- * 100mm length for brick and block walls.

* Wall fixings not supplied.

* All dimensions in mm.

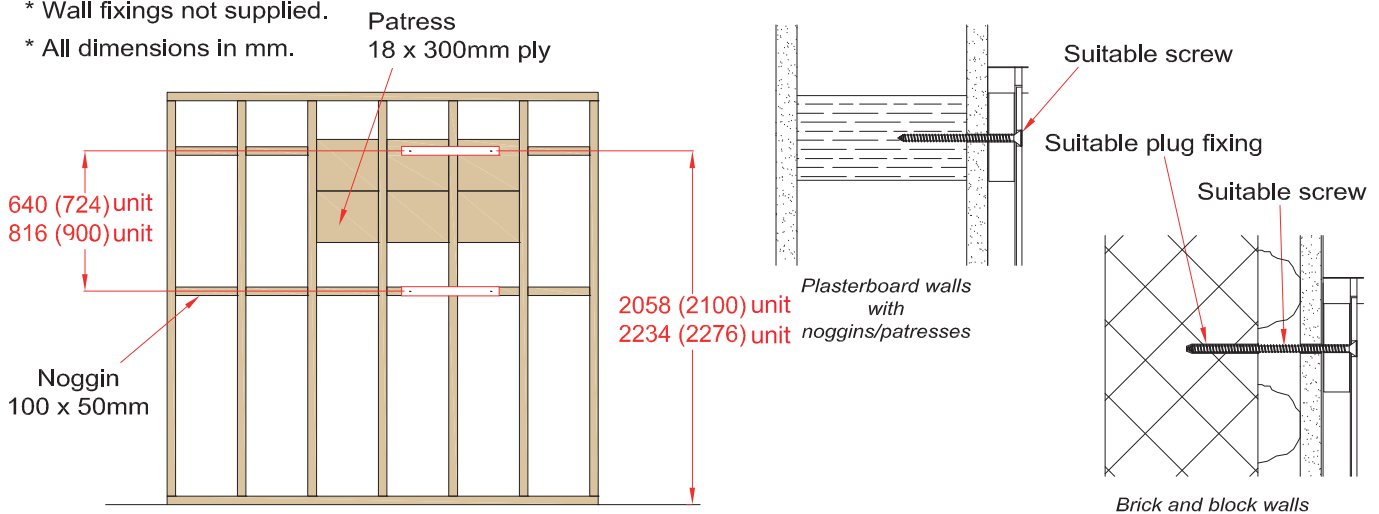

Ensure you have checked wall construction prior to attempt to fix wall unit. All screws must make a solid fixing in either timber noggins, patress boards or through to wall. If there are no firm fixing points then seek expert advice before fitting the unit, to ensure the walls are able to withstand appropriate strength for use. Under no circumstances should plasterboard fixings be used.

INTEGRATED HOUSINGS

WEIGHT LIMITS OF WALL CABINETS

Please see below the maximum weight limits of wall cabinets. The weights shown below are the maximum load capacity as a result of testing and should not be exceeded.

Cabinet Width	Recommended Weight Limit Per Cabinet
Single Door Cabinet (150mm – 600mm)	20kg (Approx. 20 bags of 1kg sugar or 50 tins of 400g soup)
Double Door Cabinet (800mm – 1200mm)	30kg (Approx. 30 bags of 1kg sugar or 75 tins of 400g soup)

Please ensure that the weight in wall cabinets is equally distributed and is not

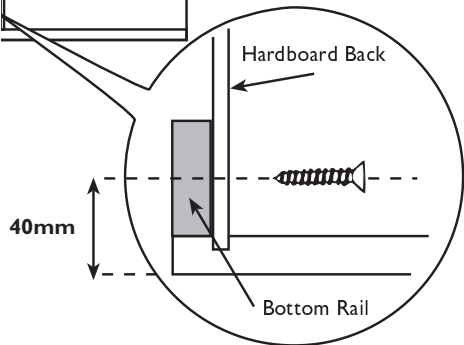
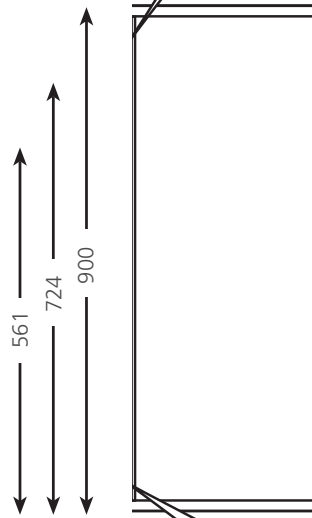
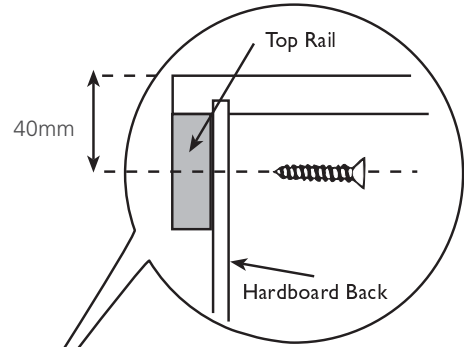

BASE UNITS

Brackets are secured to the side panel of the unit and screwed through to the wall. Legs can be adjusted as required.

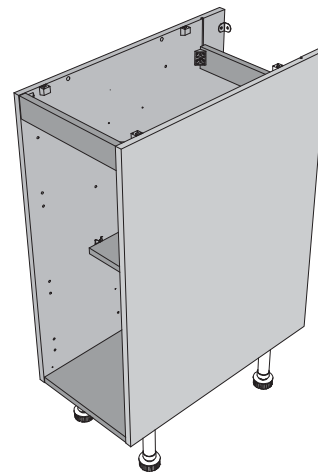
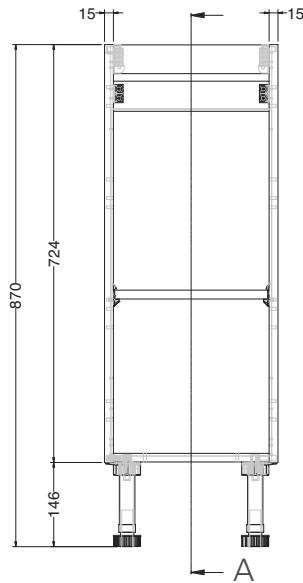
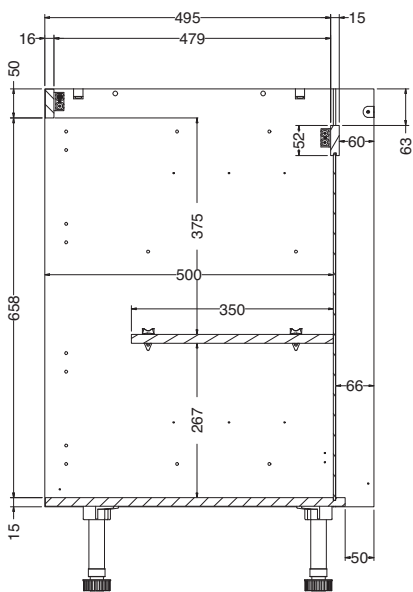

18MM EXCEL AND GALLERY CABINET INSTALLATION

WALL UNITS

Wall units are supplied with wall hanging brackets fitted to the unit. The brackets are adjustable for height and distance from the wall. When fitting the units, attach to the wall the hanging plates and make all adjustments. Remove the unit from the wall and drill through the back and vertical upright as indicated (A). Secure the unit with additional screws to a structural part of the wall. Any screws and other fixings used must be suitable to support units, when loaded, into the material to which they are to be fitted.

Please refer to separate fixing instructions provided in hanging bracket plate pack for further information.

IMPORTANT

It is the responsibility of the customer:

- * to ensure that the wall is of a suitable quality and structure to hold the unit fixing in place.
- * to use the proper hardware fittings for the wall type. Screw must be a minimum of 5mm diameter and rawl plug should be appropriate for the wall used by the bracket.

We recommend two screw lengths:

- * 60mm length for plasterboard walls with noggins/patresses.
- * 100mm length for brick and block walls.

- * Wall fixings not supplied.
- * All dimensions in mm.

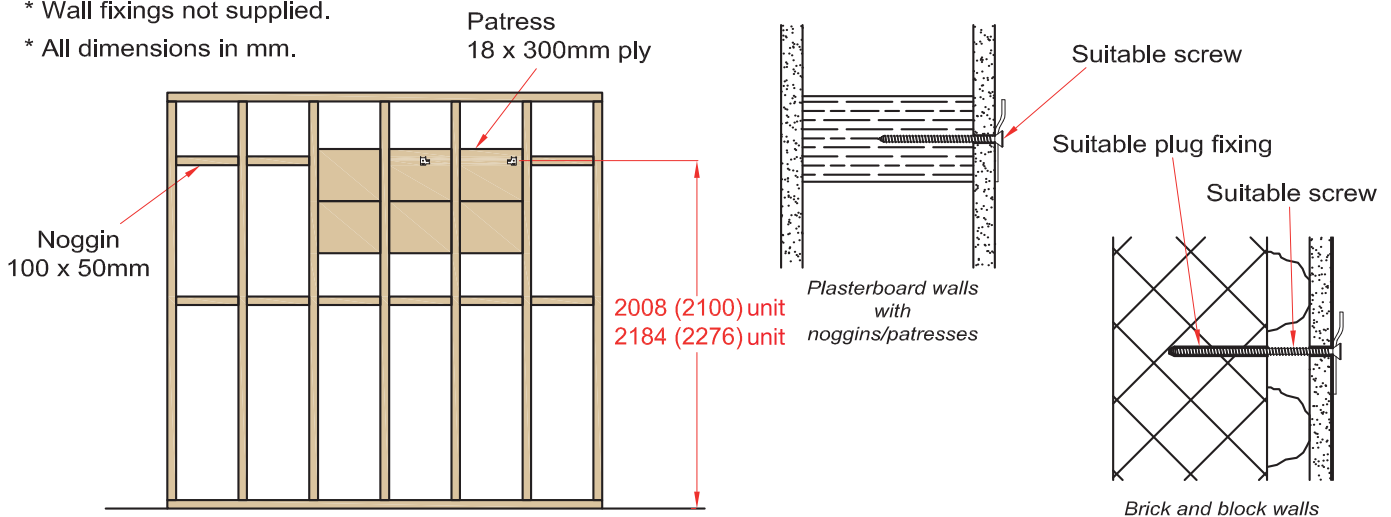

Ensure you have checked wall construction prior to attempt to fix wall bracket. All screws must make a solid fixing in either timber noggins, patress boards or through to wall. If there are no firm fixing points then seek expert advice before fitting the unit, to ensure the walls are able to withstand appropriate strength for use. Under no circumstances should plasterboard fixings be used.

INTEGRATED HOUSINGS

WEIGHT LIMITS OF WALL CABINETS

Please see below the maximum weight limits of wall cabinets. The weights shown below are the maximum load capacity as a result of testing and should not be exceeded.

Cabinet Width	Recommended Weight Limit Per Cabinet
Single Door Cabinet (150mm – 600mm)	20kg (Approx. 20 bags of 1kg sugar or 50 tins of 400g soup)
Double Door Cabinet (800mm – 1200mm)	30kg (Approx. 30 bags of 1kg sugar or 75 tins of 400g soup)

Please ensure that the weight in wall cabinets is equally distributed and is not exceeded.

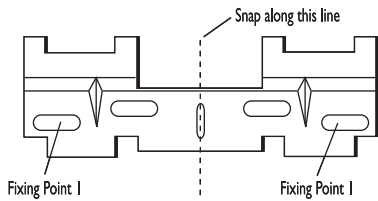
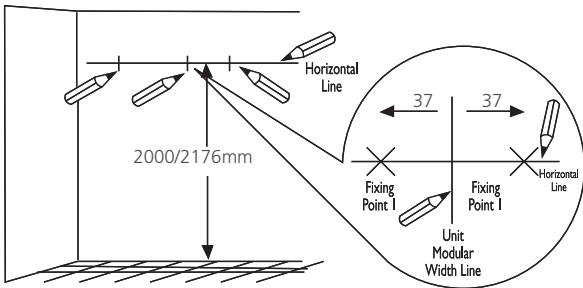
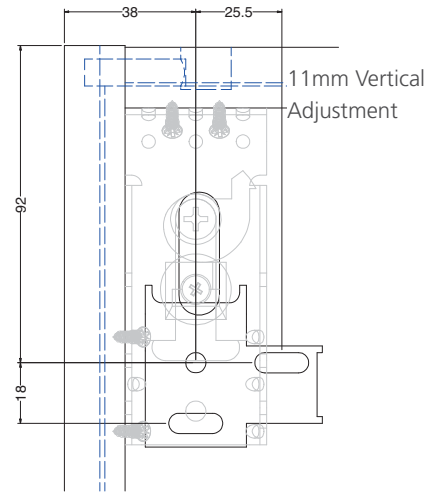

Determine the location of the unit(s) and mark a horizontal line 2176/2000mm from the floor. Mark the position of each unit. Fit the hanging bracket plates to the wall as illustrated.

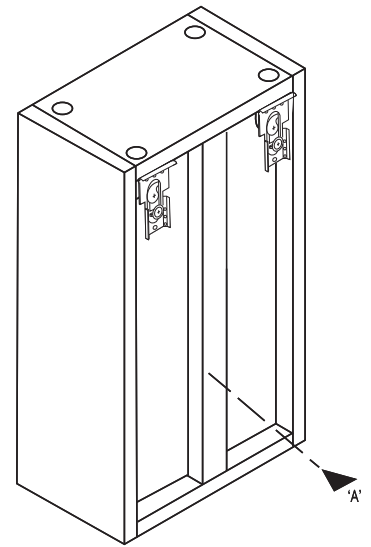

BASE UNITS

Brackets are secured to the side panel of the unit and screwed through to the wall. Legs can be adjusted as required.

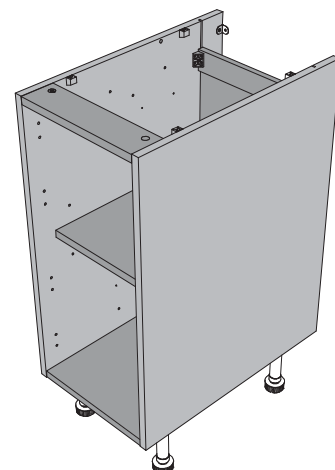
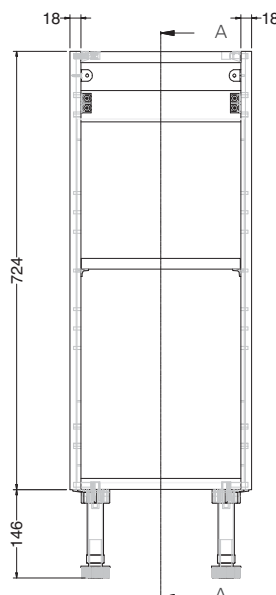
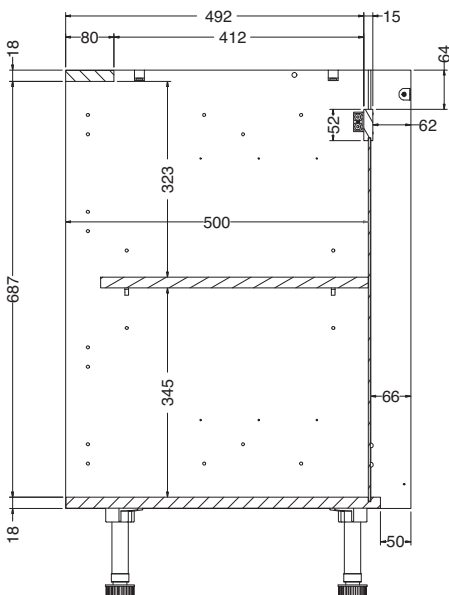

CABINET ELEVATIONS

2100mm Cabinet Elevations - Contemporary style example

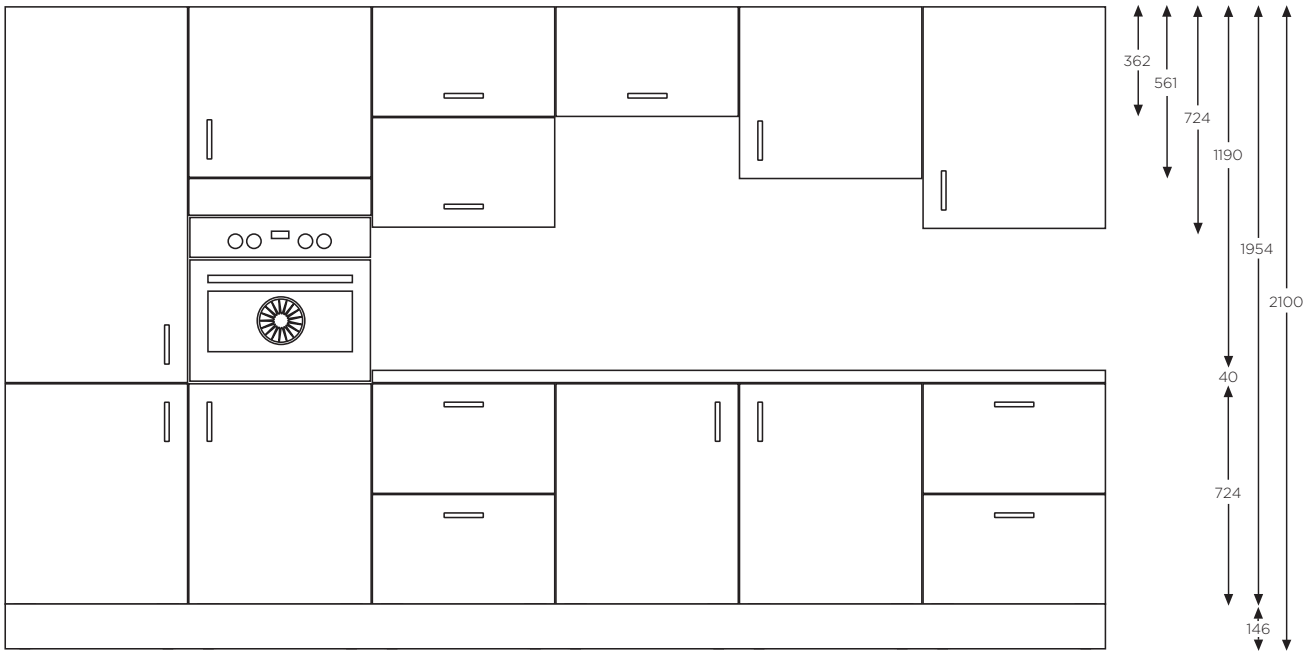

NB: Base cabinet height to underside of worktop is 870mm. Actual base cabinet depth is 470mm or 570mm (500mm or 600mm with worktop). Actual wall cabinet depth is 285mm.

2276mm Cabinet Elevations - Classic style example



NB: Base cabinet height to underside of worktop is 870mm. Actual base cabinet depth is 570mm (600mm with worktop). Actual wall cabinet depth is 285mm.

GUIDANCE NOTES

For the installation of kitchen fitments (in compliance with BS6222 part 4, 1998)

DELIVERY AND STORAGE ON SITE

ALWAYS:

- Store units, worktops and other items under cover, in dry conditions, immediately.
- Store loose shelves separate from units.
- Protect unit fronts.
- Cover units during storage to prevent dirt and debris collecting on moving parts such as drawer runners and hinges.
- Avoid twisting and distortion.
- Store worktops upright or flat, face to face on bearers with the top surface protected against damage.

NEVER:

- Store units on their sides unless they have soft, grit-free material underneath.
- Stack base units more than three high.
- Stack wall units more than four high.
- Stack frontals against each other or against a wall.
- Store units, worktops and other items near direct heat.
- Remove tapes from doors or drawers until immediately before fitting.

Customers must check units as they are delivered and sign for them as being in good condition. If they are not, the driver's copy of the advice note must be marked accordingly and signed by the customer.

INSTALLATION METHODS

Consideration should be given to following trades when allowing access to electrical points, rodding eyes, stop taps, waste traps and any other items or areas where post completion access will be required.

To prevent any accidental damage to the doors and drawers always remove them from the units and store carefully away from the working area. Any sleeving protection should remain on until they are refitted to the units and adjustment has been carried out.

Having checked the plot for level and square, commence by marking a level line on the wall around the base unit area to indicate the finished unit height.

FITTING KITCHEN UNITS

Units should be packed up or scribed down as little as possible. We recommend a maximum of 6mm packing with firm material where required.

Scribing down should be 10mm maximum, but this depends on any appliances fitting under worktops. Please check manufacturers appliance sizes before scribing down in excess of 10mm.

If ceramic tiles are to be fitted to the floor after the kitchen has been installed, scribing down of the units will be unnecessary.

Should it be necessary to scribe the rear of the units, then this must be as little as possible especially if integrated appliances are to be fitted into tall units or under worktops.

Kitchen base units should be fixed to the wall using the metal cabinet fixing bracket supplied (18mm Excel). The appropriate fixing should be dependent upon the surface being fixed to. It is not necessary to fix through every bracket on a run of units, but fixings either side of an appliance space and on the ends of each run of units must be made.

Tall units (oven housings, larders, etc.) should be level and plumb on all faces and fixed to the wall at four points.

Wall units are to be fixed level and square using hanging brackets if appropriate, or directly to the wall through the back rail where the following number of fixings should be used:

Up to 600mm wide unit	4 fixings
800mm to 1000mm wide unit	5 to 6 fixings
1200mm wide unit	6 fixings

Fixings for standard walls should be 2½" No. 10 counter sunk screws or longer. Dryline walls (dot and dab) will require longer hollow wall fixings, depending on the thickness of the dab and the type of block work being screwed into. It is essential to use the correct fixings and to check screws match the correct plug size being used.

Units should be screwed together at three positions, preferably hidden from view (e.g. by hinge block, back rail on base units and behind shelf on wall units).

All visible screw heads should be capped with colour caps. Recessed caps (10mm) are available for white carcass interiors.

Extended voids (over 600mm wide between end panels) under worktops, especially corner units, and adjacent to worktop joints, should have supporting battens fixed to the wall beneath.

Do not fit wall units directly onto stud walls. In this scenario, nogginns are required to provide extra support.

APPLIANCE SPACES

Care should be taken when leaving spaces for freestanding and integrated built-under appliances.

Built-under integrated spaces should be 603mm maximum. This will allow for easy installation and removal without causing problems with door alignment.

600mm integrated and cantilever cooker hoods require 600mm at the back and front of the void.

Freestanding appliances should have a minimum space 10mm greater than their width to allow easy installation/removal.

Adjacent units to appliance spaces must be plumb and parallel.

Hose positions for dishwasher and washing machines are critical especially on integrated appliances. Dishwasher hoses should be led through an aperture, cut at low level into the side panel at the rear of the adjacent sink unit, for connection to services within that unit. Washer hoses will have holes drilled at top level in the side panel at the rear of the sink unit if connecting to service in the unit.

When fitting any appliances the manufacturer's installation instructions must always be read prior to any installation and followed throughout.

When fitting 'wet' appliances ensure that hoses do not become kinked or trapped when the appliance is pushed home.

FILLERS

Filler panels are to be scribed to walls and sealed with matching decorator's filler and not silicone.

15mm or smaller fillers where seen, should be edged in exterior cabinet matching colour.

Tray spaces or any site constructed platforms should have the front edges to match the cabinet colour exterior.

PLINTH

Continuous plinth will be cut and edged at the unit run ends to finish flush with the cabinet end panel. Cabinet exterior matching edging tape should be applied to the raw coreboard with contact adhesive. Peel and stick edging or hot melt adhesive is not recommended.

Ventilation slots as found cut on standard transit plinths on kitchen units must be cut in the continuous plinth for oven, fridge or freezer housings. The slot is approximately 500mm long and 40mm deep and must be cut on the upper edge of the plinth.

Plinths should be fitted tight to the underside of the bottom panel of the base unit and not pushed to the floor. The plinth adds additional support to the bottom panel by keeping it up tight.

Plinths should never be glued or nailed to cabinets as this prevents easy removal.

GUIDANCE NOTES

For the installation of kitchen fitments (in compliance with BS6222 part 4, 1998)

CORNICE AND PELMET

Cornice and light pelmet mitres should be clean and accurately cut using a fine mitre saw.

Fixing cornice should be from above. If this is impossible, fixing from the inside of the cabinet is recommended. When fixing from the inside of the cabinet, 10mm recessed screw caps should be used and 1" x No. 6 CS screw. If longer screws are used and not recessed they should be covered by a matching cover cap.

Light pelmet can be fixed direct through the wall unit bottom or with half blocks/L brackets. A mixture of both methods of fixing is acceptable especially when fixing to display feature units.

All mitres should be glued using PVA wood glue or Cyanoacrylate adhesive. Under no circumstances must hot melt adhesive be used.

Only minor discrepancies in the cut should be filled with matching filler waxes, (not silicone).

Direct fixing should be positioned as close to the end panels as possible for both pelmet and cornice. The number of fixings per unit size are as follows:

300mm to 600mm wide unit 2 fixings

800mm to 1000mm wide unit 3 fixings

The third fixing for 800/1200 units to be by the centre post.

Cornice should be inset on all wall unit/tall unit returns so that the front lip of the flat (fixing) base of the cornice is inset by 15mm, but fitted with the front edge of the unit's top panel on the elevation.

Pelmet should be inset by 15mm on wall unit returns but flush with the front edge of the bottom shelf on the elevation. In this way the appearance of a uniform recess will be achieved when the unit door is closed.

WORKTOP FIXING

Worktops should be fixed to the base units and independent tops to wall battens, and levelled in both directions.

The tops are fixed through the brackets or half blocks on the base unit end panels, and up through the front rail.

The fixings in the front rail should be as close to the end panel as possible and by the centre post on a double base or corner unit.

Mason Mitre and butt joints should be flush fitted. And three jointing bolts need to be used on all kitchen worktops unless they are reduced in depth or width. A coat of silicone* should be used to seal the worktop ends prior to jointing.

If the back of the worktop has been scribed to the wall it should then be re sealed with silicone* before installation. Take special care if sealing behind a sink.

Hob and sink cut outs should also be sealed with silicone* and the chipboard should be cut and the dust then cleared away. Then silicone* should be applied to ensure all holes are filled.

*It is recommended that Silicone to BSEN150 11600 or BSS889 be used in all cases.

AFTERCARE INSTRUCTIONS

- The tape from all doors and drawers should be removed by hand, without the use of a sharp implement.
- Any marks subsequently left should be cleaned off using warm water and a mild detergent.
- DO NOT attempt to clean units, worktops or sink tops with cleaning powder or any form of abrasive material or agent.
- Drawer runners and hinges should be cleaned to ensure that no plaster, grit or other material will impede their action.

CARE FOR YOUR SYMPHONY KITCHEN

We set standards of quality to which others can only aspire

At Symphony, our commitment to quality is total. From our choice of raw materials, right through to the design, manufacture and installation of our products. What's more, every stage of our operation is constantly monitored to ensure that standards are not only maintained but also continuously improved.

In fact, our whole philosophy is one of providing not only the very best products to customers but also complete peace of mind.

YOUR SYMPHONY KITCHEN CABINET

Symphony kitchens are manufactured from high density, fine surface particle board, which complies with the British Standard BS EN 312-P2. You can be assured that all cabinets are tested to and pass FIRA Gold product certification. Cabinets are supplied on adjustable legs to cater for uneven floors and to protect against moisture ingress. Vulnerable cabinet edges are lipped to resist moisture see page in to the panels.

GENERAL CABINET CLEANING ADVICE

Sensible general cleaning practice includes avoiding use of an abrasive cleaner or strong chemicals (such as vinegar, nail varnish remover, solvents and bleach) on surfaces and always wiping off any water with a soft cloth rather than leaving it to stand. It should be noted that cabinets are not resistant to water and will swell if wet, so any spillage should be dried immediately. To clean your cabinets simply use a slightly damp non-abrasive cloth with a little liquid soap.

All Symphony frontals and doors have been made to withstand the normal wear and tear associated with kitchen life and are treated to resist normal household cleaning chemicals. However, any spills should be rinsed immediately and dried thoroughly. Avoid placing electric kettles and steamers directly below wall units and on worktop joints to minimise condensation. Naturally, you should also regularly check that all handle screws are secure and never rest heavy objects on partly opened doors or drawers.

ADJUSTABLE SHELVES

Unit shelves are adjustable to suit your needs. Whilst units have been FIRA Gold approved and tested to withstand strong weights, we recommend that you load the heaviest items on the base of the cabinet with lighter items on the shelves. It is recommended to evenly distribute items within a cabinet to avoid minor distortion of the unit. Adjustable metal hanging brackets secure wall units to the wall, though we recommend that heavy items are not placed in wall units for both accessibility and safety reasons.

In addition to the specific guidelines detailed in this brochure, you should naturally take extra care when working near to hot surfaces or using cleaning agents. For example, keep all chemicals, detergents, hot pans and sharp objects out of children's reach and never allow them to be unattended in the kitchen and to swing on doors or drawers.

A wide range of base and wall units and colour options are available in flat pack format for ease of storage and quick, easy assembly on site. Please ask your Symphony representative for information.



CARE FOR YOUR SYMPHONY KITCHEN

CHARACTERISTICS OF VARIOUS TIMBERS

As a natural material, wood reflects the endless variety of grains and textures found in nature and such variances must be expected. All timbers mellow when exposed to sunlight so a colour change is possible overtime. Whilst such definitive characteristics make them a perfect vehicle for furniture design, it is important that they are treated with care. The risk of contact with sharp or heavy objects, scratching, exposure to chemicals, etc. must be avoided before, during and after installation.



OAK (OAKHAM)

Oak is a finely grained, mature timber notable for its stability and straight graining. Because it can be used for a variety of styles and stained in a number of different colours, it is the traditional favourite of both craftsmen and, of course, homeowners.



ASH (AUSTIN)

Ash belongs to the olive tree family and due to its high flexibility it is used in a variety of furniture and flooring products. It is easy to work with and can be stained, waxed or polished very well.

CABINET/FRONTAL SURFACE CONSISTENCY

Timbers and veneers are natural materials and are subject to the variations in colours and grain differences that nature promotes. All timbers feature small graining marks and knots. These are part of the timber's natural properties and do not represent faults in the door or drawer. It is virtually impossible to guarantee a totally accurate match between timber veneered frontals and accessories. Notwithstanding the difficulties involved, Symphony endeavours wherever possible to produce the closest match that manufacturing and finishing technology allow.

Melamine and laminates are synthetic materials and so have a very stable finish, however they are still liable for changes in colour over time.

CARE OF YOUR KITCHEN FRONTALS

Doors and drawers should be wiped clean with warm water and a damp cloth containing a mild detergent. For best results, do not over wet. Also, you should avoid the use of scouring pads or wire wool and not use abrasive cleaning agents.

SOLID TIMBERS AND VENEERS

High quality wood and veneer have been used in the manufacture of all door and drawer fronts. Although the lacquered finish gives a tough hard-wearing surface, spills should be wiped clean immediately and then a wipe over with a damp cloth will restore the finish. Once dry, a final polish with a soft cloth and a reputable household furniture polish will preserve and enhance the wood's natural beauty.

PAINTED PRODUCTS

High quality durable paint has been used in the manufacture of all doors, drawers and accessories. Spillages should be wiped away quickly. To clean use a clean damp cloth, apply a small amount of soft soap (a mild washing up liquid) and water to the area to be cleaned and gently wipe over the surface in one direction. Then wipe over the surface with a clean, dry cloth. Avoid the use of abrasive agents, creams, industrial cleaners, detergents or liquid sprays that contain wax. Scratches and scrapes, if they occur, should be treated with an application of a matching touch up paint. For touching up scratches and scrapes, the paint needs to be worked into the chip/scratch, so on a level with the original paint and not overlapping the original paint.

MINOR ADJUSTMENTS

Because your kitchen doors and drawers will be in constant use, they may require adjustment from time to time to ensure perfect working order. This can be done easily with a simple screwdriver, a brush and some lubricating oil.



DOOR HINGES AND DRAWER RUNNERS

It's a good idea to inspect the door hinges and drawer runners from time to time so that any dirt, fluff or general grime can be removed.

This can be done with a soft, dry brush or a duster, or even the nozzle of a vacuum cleaner. Although lubrication is usually not required a small amount of household spray polish may be used.

ADJUSTING THE DOOR

SIDE ADJUSTMENT

The side adjustment is made by rotating the appropriate screw on the hinge arm.

HEIGHT ADJUSTMENT

For height adjustment the two mounting plate fixing screws have to be temporarily released while making the manual adjustment.

DEPTH ADJUSTMENT

The depth adjustment is made by temporarily releasing the adjustment/fixing screw. After the adjustment is made the screw has to be re-tightened.

SOFT CLOSE ADJUSTMENT (KONCEPT ONLY)

Where fitted soft close clip on buffers can be adjusted by rotating the screw at the end of the buffer. Please note that soft close buffers are not supplied with every kitchen.

ADJUSTING THE DRAWER FRONTS

SUPRA CREAM DRAWER BOX (KONCEPT ONLY)

Adjust the drawer frontal height by rotating the lever clockwise/anti-clockwise.

ATIRA SILVER DRAWER BOX

To adjust the drawer front vertically clip off the cap, rotate the grooved wheel clockwise/anti-clockwise.

To adjust the drawer front horizontally, rotate the screw clockwise/anti-clockwise.

WEIGHT LIMIT OF DRAWER BOXES

All kitchen cabinets are tested to FIRA Gold award certification to British standards BS EN 6222 Test Level H, to ensure complete confidence of your kitchen for many years to come. The weights shown on the right are the maximum load capacity of a drawer and should not be exceeded.

Cream drawer box - 20kg weight limit
Silver drawer box - 30kg weight limit

WORKTOP MAINTENANCE

GENERAL MAINTENANCE

All Symphony laminate worktop surfaces are designed for easy maintenance and long life. Everyday stains such as coffee spills and finger marks clean up easily with a quick wipe with a damp cloth. Although laminates are exceptionally resistant to scratches and normal wear and tear, always use a cutting board when using sharp knives.

CLEANING STAINS

Always start with the gentlest method. If stains persist, try the following steps:

- 1 Use a damp cloth and mild detergent.
- 2 For difficult stains, use a mild household cleaner with a soft bristled brush.
- 3 If stubborn stains remain, try a paste of baking soda or a non-scratch cleaner such as Flash, scrubbing lightly with a soft bristled brush.

DO'S AND DON'TS

Never place hot pans or dishes directly onto the worktops. Instead, use a heat shield, hot pad or trivet to avoid blistering or cracking the laminate. Never use acidic or abrasive cleaners, or apply excessive scrubbing, especially on surfaces with a gloss finish.

EARTHSTONE WORK SURFACES

Through a simple cleaning regime the unique surface can be maintained to look good longer and has the added benefit of being repairable.

You will have received a care and maintenance kit with your Earthstone worksurface along with a leaflet to explain how you can keep your worktop in a good condition.

Once installed your worktop will have been given a final sand and polish. Over time the worksurface will eventually acquire a smoother, slightly higher sheen to it.

DAILY CLEANING

It is recommended to wipe down the surface with warm soapy water during the first week of installation. Then buff the surface dry and apply a thin, even coat of Countertop Magic (included in your Care and Maintenance kit) and wipe off immediately with clean microfibre cloth.

WEEKLY POLISH

It is recommended to polish your Earthstone worksurface once a week to maintain its deep, rich lustre. Use the Earthstone Care and Maintenance kit and refer to the leaflet for information on how to do this.

RECOMMENDATIONS

- Do protect your worksurface from heat damage by using heat resistant mats
- Do wipe spills away quickly
- Do follow the weekly cleaning regime
- Don't place hot objects directly onto the worksurface
- Don't cut directly onto the worksurface
- Don't use abrasive cleaners or solvents as cleaning fluids
- Don't drop heavy objects onto the worksurface

Please note: Darker colours will show excessive marking, scratching, wear and tear more noticeably than lighter colours.



ORDERING CHECKLIST

Please fill in your property and kitchen details on the form below.
For product information, please refer to this specification guide for details.

Plot Number:	
Symphony Site code:	
Housebuilder Name:	
Site Name:	
Site Address:	
Site Postcode:	

Drawer Box style:	
Hinge:	
Cabinet colour:	
Door & Drawer Frontal Range & Colour:	
Handle (HPK code):	

Cabinets:					
Width	Height	Depth	Code	Replacement Ends (GL/GR/G2)	Handing (LH/RH)

Additional Items:			
Item	Code	Dimensions/Details	Finish (if applicable)

Call 01226 446610 or
email additional.units@symphony-group.co.uk



The Symphony Group Plc
Pen Hill Estate,
Park Spring Road, Barnsley
South Yorkshire, S72 7EZ
Tel: 01226 446610

www.symphony-group.co.uk/additional-units

Symphony®

Creating the perfect living space

In keeping with our policy of continuous product development, we reserve the right to change colours, designs, materials, descriptions or methods of manufacture. Such changes may be made without notice and without incurring any liability. Nothing in this publication should be considered to be part of any contract. The illustrations included in this publication are to indicate general format and are not necessarily correctly scaled, proportioned or detailed.

Natural wood is used in some of our kitchens. As a natural material, wood reflects the endless variety of grains and textures found in nature and such variances can be expected in any selection of timber fronted units. Timbers mellow when exposed to sunlight, so a colour change can be expected.

PVC laminates and melamine finishes are also subject to slight colour change over a period of years. Unless specified otherwise, the expression 'solid timber' refers to door and drawer fronts only. A copy of our conditions of sale is available on request. Errors and omissions excepted.

Copyright and all other rights in this brochure and the photographs and other works upon which it is based, are owned by The Symphony Group PLC. No part of the brochure and said photographs and other works may be reproduced or transmitted in any form or by any means (including but not limited to photocopying or storing in any electronic medium) without the prior express written permission of The Symphony Group PLC.

© The Symphony Group Plc 2019

