

CPP INDUSTRY'S CHOICE

Advanced Engineered Industrial Couplings

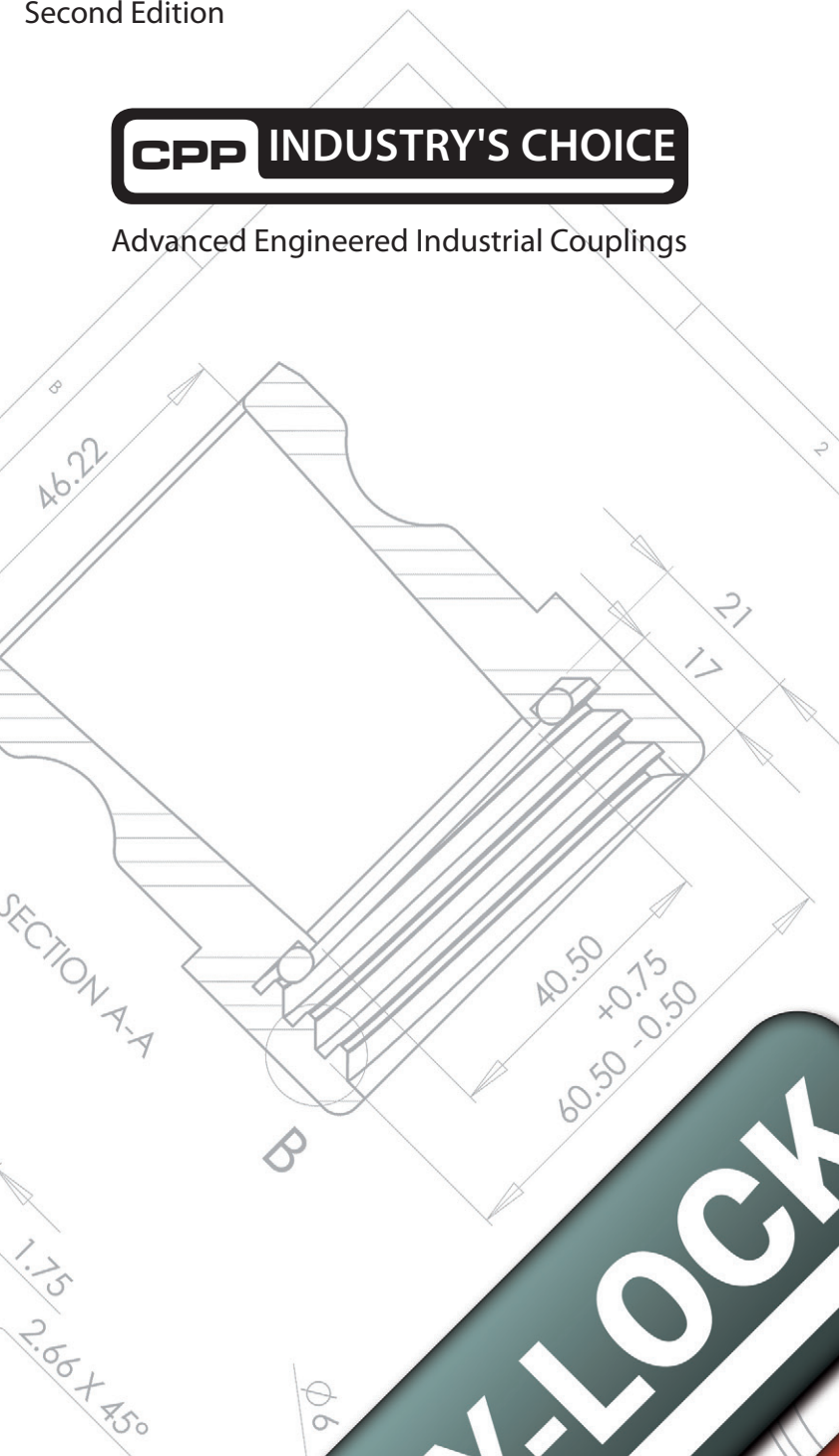

CPP KEY-LOCK

OSY-SEAL

IBC ADAPTORS

CPP DRY

CPP IBC VALVE

CP

CS



Advanced Engineered Industrial Couplings

Introduction to CPP

Welcome to our newly formed CPP brochure, we hope you find our comprehensive brochure informative and helpful.

A brief company history; we developed our first range of adapters in the early nineties and introduced Camlock, pipe threads and hose tail adapters for the most common application. Since then we have added fittings, valves and vents to our extensive range to give our customers the largest choice available anywhere in the world, straight from our warehouses in the UK and USA.

Our brochure is colour coordinated for easy reading and within each section we have included a brief description of the products we manufacture and have included a list of suitable applications.

Rest assured, we produce the best possible product available, designed and constructed for Industrial usage, moulded in food grade glass coupled polypropylene, and we include seals (where necessary) as standard.

Our products leave our warehouse, boxed, bagged and labelled as needed for easy identification and cleanliness. For large orders instead of our own identity being on the bags containing our products, we are able to offer you personalised labelling on the bags with your own company information.

The excellent chemical resistance and light weight of polypropylene combined with moving parts made of stainless steel (where deemed appropriate) makes purchasing any one of our products the most cost effective solution.

All our products are backed (as standard) with CPP product and manufacturers insurance against defects and failure.

Please enjoy looking through our brochure and we look forward to receiving orders from you soon...

Yours sincerely, All the staff at CPP

CPP UK Sales

Unit 38 Crayford ind. Est.
Swaisland Drive
Crayford
Kent, DA1 4HS
United Kingdom

E-mail: sales@cpp-lm.com
Telephone: +44 1322 551940
Fax: +44 1322 550212

Website: www.cpp-lm.com

CPP US Sales

PO Box 3752
Lake Wales
Florida
33859
USA

E-mail: sales@cpp-usa.com
Telephone: +1-866-682-7251
Fax: +1-863-223-0304

Website: www.cpp-usa.com

Contents

IBC Off-Load System	4
IBC Connectivity Reference	5
IBC Adaptors	6
Swivel-It	13
Easy-Seal	14
IBC Vents	16
Drum Adaptors	17
IBC Valves	18
Keylock	20
Camlock	22
Hose Fittings	30
Custom Fittings	34

CPP IBC OFF-LOAD SYSTEM

CPP have recognised the market need for purpose designed adaptors and fittings to ensure the quickest and most secure IBC off-load. Our primary goals were to provide the end user with an off-load system which is quick, secure, easy to maintain, compatible with the vast majority of products transported in IBC's, integrates easily with existing equipment and be cost effective. CPP now manufactures the largest range of polymer IBC adaptors in the world today. Where ever possible we base our products on dimension and tolerances as specified in international or specific country standards using state-of-art computer technology so we can offer assurance of the best possible product available. Designed and constructed for Industrial usage, moulded in food grade glass coupled polypropylene, and we include seals as standard. All bagged and labelled for easy identification and cleanliness.

All products backed (as standard) with CPP product and manufacturers insurance against defects and failure.

We developed our first range in the early nineties and introduced Camlock, pipe threads and hose tail adapters for the most common application. Since then we have added fittings, valves and vents to our extensive range to give our customers the largest choice available any where in the world, straight from our warehouses in the UK and USA.

The excellent chemical resistance and light weight of polypropylene combined with all moving parts made of stainless steel makes this off-load system one of the most cost-effective solutions.



IBC CONNECTIVITY — KEY REFERENCE

Components within this brochure are identified with a key regarding which IBC the component fitting(s).

IBC Fitting	Thread	Description	Key
		<p>Name: 560X6 (2") male buttress D1: 60mm (2.36") P1: 6mm (0.24") Standard: DIN 6131 (schütz do not us this specification) Note: Most common thread found on European IBC's</p>	▲
		<p>Name: 2" NPS male D1: 59.6mm (2.35") P1: 2.21mm (0.09" - 11.5 TPI) Standard: ANSI B1.20.1-1983 Note: American National Standard Straight Pipe Thread</p>	▼
		<p>Name: 2" Camlock male with 2" BSP D1: 63mm (2.48") (59.4mm (2.34") thread) P1: 2.3mm (0.09" 11 TPI) Standard: Camlock- A-A-59326 : 1992 Thread – BS 2779 : 1986 Note: Camlock male adaptor with added external thread for cheap and compact dust cap</p>	◆
		<p>Name: 2" Camlock male with 2 1/8" BSP D1: 63mm (2.48") (62.7mm (2.47") thread) P1: 2.3mm (0.09" 11 TPI) Standard: Camlock- A-A-59326 : 1992 Thread – N/A Note: Camlock male adaptor with added external over sized thread for cheap and compact dust cap and added seal area for connecting a female Camlock.</p>	●
		<p>Name: 2" Camlock male adaptor D1: 63mm (2.48") P1: N/A Standard: Camlock- A-A-59326 : 1992 Note: 2" Camlock male adaptor fitted to an IBC</p>	■
		<p>Name: M80X3 male thread D1: 80mm (3.15") P1: 3mm (0.12") Standard: ISO 68 (ANSI B1.13M) Note: A 80mm (3.15") metric thread found mainly on the Chinese Kingtainer IBC</p>	⬠
		<p>Name: 5100X8 (3") male buttress D1: 97-100mm (3.82" - 3.94") P1: 8mm (0.32") Standard: N/A Note: Found on a lot of 3" outlet IBC's, short length and a large thread depth</p>	★
		<p>Name: 3" Camlock with 3" BSP D1: 91.5mm (3.6") (87.7mm (3.45"0) thread) P1: 2.3mm (0.09" 11 TPI) Standard: Camlock- A-A-59326 : 1992 Thread – BS 2779 : 1986 Note: Camlock male adaptor with added external thread for cheap and compact dust cap</p>	☾

Please reference page 16 for IBC Valve Fittings and relevant keys: 

CPP IBC ADAPTORS

IBC Adaptors

We have the most comprehensive IBC Adaptor range which is all manufactured in our facility in the United Kingdom, ensuring you get the best possible product and materials. Each adaptor type is developed and tested to the highest standard so you can rely on the CPP branded fittings.

Each adaptor is bagged and labelled for cleanliness and identification. Chemical resistance and pressure ratings can be found on our website.

2" IBC Adaptors

Part A — Camlock male adaptor X female thread



ID	Part Number	Product Description	IBC Fitting
1	CMA/10UD/027	1" part A, 1" Camlock adaptor X S60X6 female buttress C/W	▲
2	CMA/15UD/027	1 ½" part A, 1 ½" Camlock adaptor X S60X6 female buttress	▲
3	CMA/2078RD/027	2" part A, 2" Camlock adaptor X RD 78 female G/P/P	N/A
4	CMA/20PB/027	2" part A, 2" Camlock adaptor X 2" BSP female (2828) C/W s	N/A
5	CMA/20UD/027	2" part A, 2" Camlock adaptor X S60X6 female buttress C/W	▲
6	CMAS/20UD/028	2" part A, 2" (short) Camlock adaptor X S60X6 female buttress	▲
7	CMAS/20UDNB/027	2" part A (short) Camlock adaptor X S60X6 female EX thread	▲
8	CMAS/20NNB/027	2" part A (short) Camlock male X 2" NPS female ex	▼
9	CMA/20UD/027	2" part A, 2" ext. part A, 2" Camlock adaptor X S60X6 female	▲
10	CMA/2080KT/027	2" part `A`, 2" Camlock adaptor X M80X3 female (KT), G/P/P	✳

Part C — Camlock female coupler X Hose tail



ID	Part Number	Product Description	IBC Fitting
1	CFC/20T/027	2" part C, 2" Camlock coupler X 2" (25mm) hose tail G/P/P	◆●■
2	CFC/212T/027	2" part C, 2" Camlock coupler X 1 ¼" (32mm) hose tail G/P/	◆●■
3	CFC/215T/027	2" part C, 2" Camlock coupler X 1 ½" (38mm) hose tail G/P/	◆●■
4	CFC/21T/027	2" part C, 2" Camlock coupler X 1" (25mm) hose tail G/P/P	◆●■

Part F — Camlock male adaptor X male thread



ID	Part Number	Product Description	IBC Fitting
1	CMFS/152B/027	1 ½" part F, 1 ½" Camlock adaptor X 2" BSPT male G/P/P	N/A
2	CMFR/2012B/027	2" part F, 2" Camlock adaptor X 1 ¼" BSPT male, G/P/P	N/A
3	CMFR/2015B/027	2" part F, 2" Camlock adaptor X 1 ½" BSPT male, G/P/P	N/A

CPP CAMLOCK

Our Camlock range of glass fibre filled polypropylene cam and groove couplings are moulded to the highest standards in our factory in the UK under a quality management system approved by the BSI.

For more info visit www.cp-lm.com



Part HA — Male thread X female thread



ID	Product Number	Product Description	IBC Fitting
1	HMFB/75UD/027	¾" BSP hex male adaptor X S60X6 female buttress C/W seal G	▲
2	HMFB/10UD/027	1" BSP hex male adaptor X S60X6 female buttress C/W seal G/P	▲
3	HMFB/12UD/027	1 ¼" BSP hex male adaptor X S60X6 female buttress C/W seal	▲
4	HMFB/15UD/027	1 ½" BSP hex male adaptor X S60X6 female buttress C/W seal	▲
5	HMFB/20UD/027	2" BSP hex male adaptor X S60X6 female buttress C/W seal G/P	▲
6	HMFB/225U/027	2" BSP hex male adaptor X S75X6 female buttress C/W seal G/P	◐
7	HMF1/20UD/028	2" IDF male thread X S60X6 female buttress G/P/P (food)	▲
8	HMFJ/20UD/028	2" RJT male thread X S60X6 female buttress, G/P/P (food)	▲
9	HMF2/20UD/027	2" NPSM hex male adaptor X S60X6 female buttress C/W seal G	▲▼
10	HMFN/20UD/027	2" NPT male adaptor X S60X6 female buttress C/W seal	▲
11	HMFNS/20UD/027	2" NPT male (short) X S60X6 female buttress C/W plug & seal	▲
12	HMFU/20B/027	S60X6 male buttress adaptor X 2" BSP female C/W seal G/P/P	▲
13	HMFU/20M/027	S60X6 male buttress adaptor X 2" NPSM female C/W seal G/P/P	▲
14	HMFUT1/20B/027	S56x4 (Tri-sure) buttress male X 2" BSP female C/W seal	N/A
15	HMFR/2065UD/028	RD 65 (DIN 405) male X S60X6 female buttress G/P/P, nat.	▲

Part HB — Male threaded X connector



ID	Product Number	Product Description	IBC Fitting
1	HMMU/20B/027	2" BSP male X S60X6 male buttress, G/P/P	N/A
2	CFB/20UD/027	2" part 'B', 2" Camlock coupler X S60X6 male buttress, G/P/P	◆●

Part HC — Female swivelling thread X hose tail



ID	Product Number	Product Description	IBC Fitting
1	HFUD/20T/027	2" part HC, S60X6 female buttress X 2" (50mm) hose tail	▲
2	HFUD/212T/027	2" part HC, S60X6 female buttress X 1 ¼" (32mm) hose tail	▲
3	HFUD/215T/027	2" part HC, S60X6 female buttress X 1 ½" (38mm) hose tail	▲
4	HFUD/21T/027	2" part HC, S60X6 female buttress X 1" (25mm) hose tail	▲

Part HD — Female thread X female thread



ID	Product Number	Product Description	IBC Fitting
1	HFFB/12UD/027	1 ¼" BSP female X S60X6 female buttress C/W seal G/P/P	▲
2	HFFB/15UD/027	1 ½" BSP female X S60X6 female buttress C/W seal G/P/P	▲
3	HFFB/20UD/027	2" BSP female X S60X6 female buttress C/W seal G/P/P	▲
4	HFFM/20UD/027	2" NPSM female X S60X6 female buttress C/W seal G/P/P	▲▼

Seals — 2" (S60X6) sealing gasket

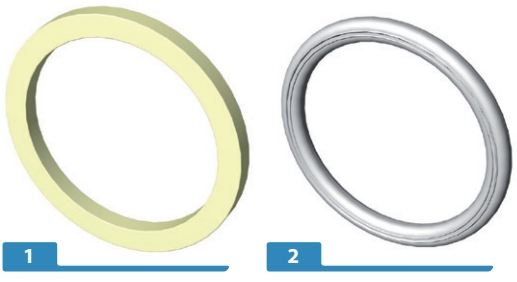

ID	Product Number	Product Description	IBC Fitting
1	FS20/EPD/NA	2" Flat gasket, nat. EPDM/P.P. (Santopene)	N/A
2	FS202/PEE/NA	S60X6 (2" BSP/NPS) flat rounded gasket, PE elastomer, Nat.	N/A

Dust Cap — 2" female thread X & Camlock X dust cap



ID	Product Number	Product Description	IBC Fitting
1	2BC/21B/024	2" dust cap for Schutz Camlock outlet, P/P black	●
2	2BCS/20B/024	2" BSP short dust cap , P/P black	◆
3	2BC/20UD/024	S60X6 female dust cap, black P/P	▲
4	2BC/20N/024	2" NPT Female Dust Cap PP Blk	▼
5	CFH/20C/027	2" part 'DC', 2" Camlock coupler X dust cap G/PP	◆●■

55 gallon (200 Ltr) drum adaptors

S64X5, S70X6 and S56X4 buttress male with pipe threaded female

Food grade glass coupled polypropylene — Seals as standard

S64X4

S70X6

S56X4

3" IBC Adaptors

Part A — Camlock male adaptor X female thread



ID	Product Number	Product Description	IBC Fitting
1	CMA/30U/027	3" part A, 3" Camlock adaptor X S10X8 female buttress, G/P	★
2	CMA/392U/027	3" part A, 3" Camlock adaptor X S92X4 female buttress, C/W	N/A

Part HA — Male thread X female thread



ID	Product Number	Product Description	IBC Fitting
1	HMF3/30U/027	3" BSP hex male adaptor X S100X8 female buttress C/W seal G/	★
2	HMF3/32U/027	2" NPS Male X S100X8 female G/P/P	★
3	HMF3/3078U/028	RD78 male X S100X8 female buttress G/P/P , nat.	★
4	HMF3/32U/027	S60X6 male buttress adaptor X S100X8 female buttress C/W seal	★
5	HMF3/926U/027	S60X6 male buttress adaptor X S92X4 female buttress C/W seal	N/A

Part HD — Female thread X female thread

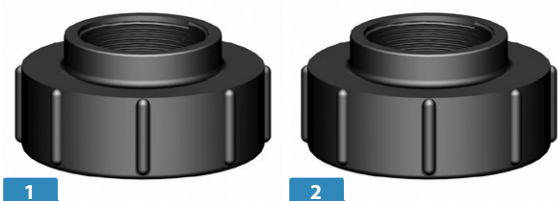

ID	Product Number	Product Description	IBC Fitting
1	HFF3/32U/027	2" BSP female X S100X8 buttress female, G/P/P C/W seals	★
2	HFF3/32U/027	2" NPS female X S100X8 buttress female, G/P/P C/W seals	★

Dust Caps — 3" Female dust cap



ID	Product Number	Product Description	IBC Fitting
1	3BC/1008U/024	S100X8 female buttress dust P/P BLACK. C/W seal	★
2	CFH/30C/027	3" part DC, 3" Camlock coupler X dust cap G/P/P	☾

Seals — 3" Sealing Gasket

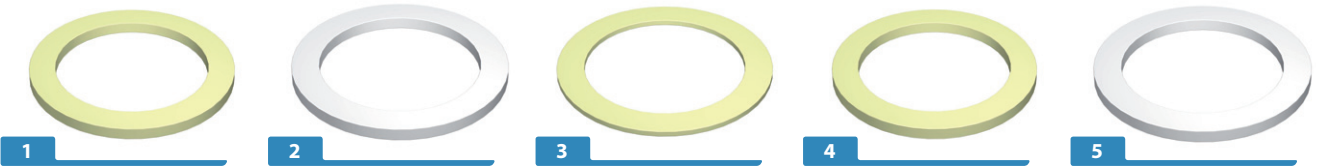

ID	Product Number	Product Description	IBC Fitting
1	HG100A/EPD/NA	S100 x 8 adaptor flat gasket, nat. Santoprene	N/A
2	HG100A/PE/NA	S100 x 8 adaptor flat gasket, nat. PE	N/A
3	HG100C/EPD/NA	S100 x 8 dust cap washer	N/A
4	HG92/LDPE/NA	S92 x 4 flat gasket, LDPE, Nat	N/A
5	HG926/EPD/NA	S92 x 4 gasket, EPDM/P.P Nat	N/A

CPP DRY-LOCK

No spills, no accidents

CPP PRECISION ENGINEERED DRY-LOCK COUPLINGS

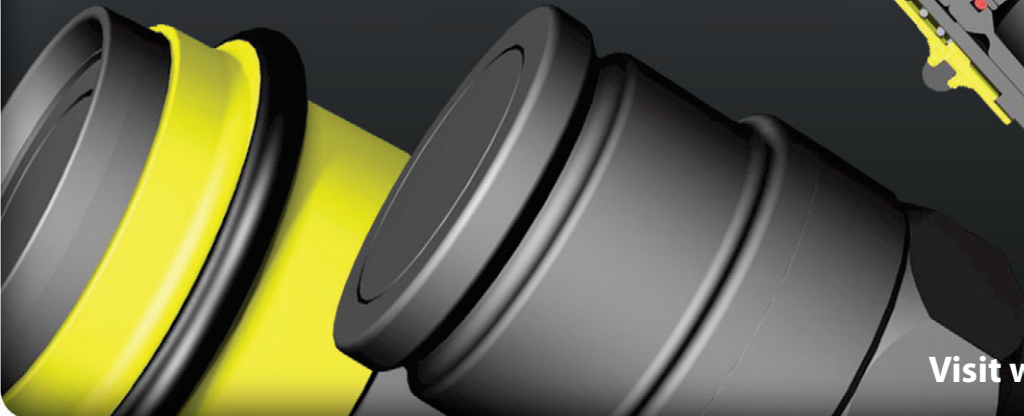

Visit www.cpp-lm.com

IBC Swivel-it

NEW — The unique IBC “Swivel-it” range has been developed at CPP to solve the issue of the one piece female to female thread socket and to stop items screwed in to them from ending up being connected in any direction or even difficult to screw into when using a long hose and pipe. Our answer was to successfully make one side of the adapters a ‘swiveling’ female nut making life easier for the operator.

As with our other IBC ranges the “Swivel-it” is moulded in our plant in the UK using food grade material then bagged and labelled for your efficient stock control and to keep the item clean ready for uses

Part “SHD” — Female swivelling thread X female thread



ID	Product Number	Product Description	IBC Fitting
1	HFFSB/60UD075B/027	S60X6 Female swivel buttress X ¾" BSP Female G/P/P	▲
2	HFFSB/60UD10B/027	S60X6 Female swivel buttress X 1" BSP Female G/P/P	▲
3	HFFSB/60UD12B/027	S60X6 Female swivel buttress X 1 ¼" BSP Female G/P/P	▲
4	HFFSB/60UD15B/027	S60X6 Female swivel buttress X 1 ½" BSP Female G/P/P	▲
5	HFFSB/60UD20B/027	S60X6 Female swivel buttress X 2" BSP Female G/P/P	▲

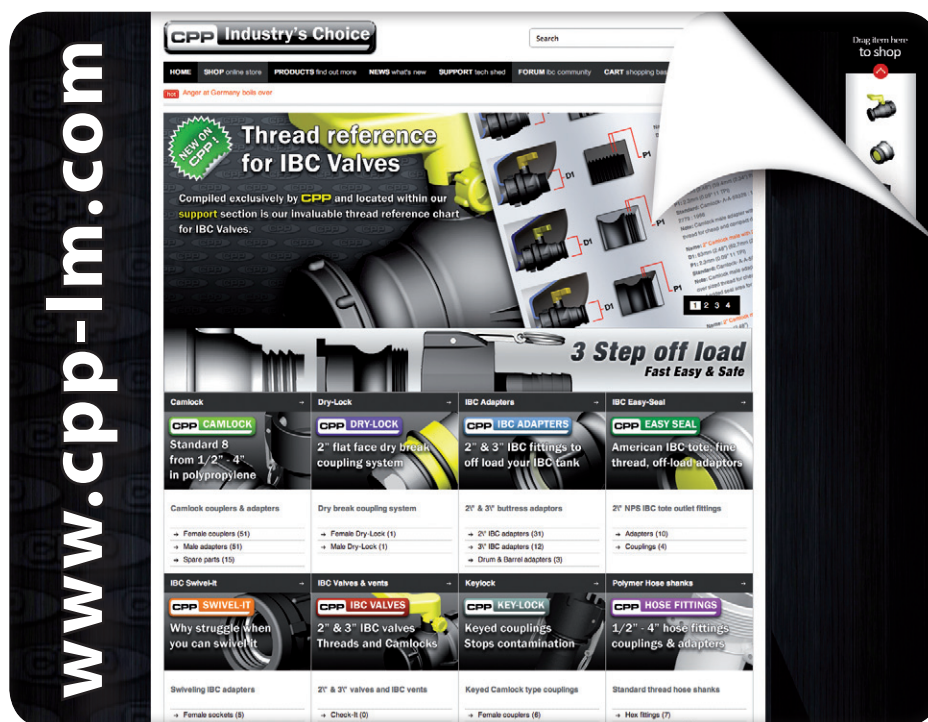

www.cpp-lm.com

CPP EASY-SEAL

IBC Easy-Seal

Connecting to your US pipe threaded IBC tote just got easy with the CPP "Easy-Seal" range of IBC adaptors. Designed especially for the fine thread IBC valve, screw it on and you are ready to go, no thread tape needed so no leaks the high performance — PE gasket takes care of that. Removing the adaptors is just as easy unscrewed and you are ready for the next container.

As with our buttress thread adaptors "Easy-Seal" are moulded at our factory in the UK using food grade polymer then bagged and labelled. The range has most common sizes and hose barbs to get connected with least amount of effort

Part 'A' — Camlock male adaptor X female thread



ID	Product Number	Product Description	IBC Fitting
1	CMA/1020M/027	1" part `A`, 1" Camlock adaptor X 2" NPS female Easy-Seal	▼
2	CMA/1520M/027	1 ½" part `A`, 1 ½" Camlock adaptor X 2" NPS female Easy-Seal	▼
3	CMA/20M/027	2" part `A`, 2" Camlock adaptor X 2" NPS female Easy-Seal	▼
4	CMAS/20NNB/027	2" Part `A` (short) Camlock male X 2" NPS female - ex thread	▼
5	CMAX/20M/027	2" part `A`, 2" X part `A`, 2" Camlock adaptor X 2" NPS Fe.ES	▼

Part 'HC' — Female swivelling thread X hose tail



ID	Product Number	Product Description	IBC Fitting
1	HFM/20T/027	2" NPS female Easy-Seal X 2" hose barb	▼
2	HFM/215T/027	2" NPS feamle Easy-Seal X 1 ½" hose barb	▼
3	HFM/212T/027	2" NPS female Easy-Seal X 1 ¼" hose barb	▼
4	HFM/21T/027	2" NPS female Easy-Seal X 1" hose barb	▼

Part 'HA' — Male thread X female thread



ID	Product Number	Product Description	IBC Fitting
1	HMFN/7520M/027	¾" NPT male X 2" NPS female Easy-Seal	▼
2	HMFN/1020M/027	1" NPT male X 2" NPS female Easy-Seal	▼
3	HMFN/1220M/027	1 ¼" NPT male X 2" NPS female Easy-Seal	▼
4	HMFN/1520M/027	1 ½" NPT male X 2" NPS female Easy-Seal	▼
5	HMFU/20M/027	S60X6 male buttress adaptor X 2" NPS female Easy-Seal	▼

Seals — 2" sealing gasket



ID	Product Number	Product Description	IBC Fitting
1	FS20/EPD/NA	2" Flat gasket, nat. EPDM/P.P. (Santopene)	N/A
2	FS202/PEE/NA	S60X6 (2" BSP/NPS) flat rounded gasket, PE elastomer, Nat.	N/A

CPP CHECK-IT

Eliminate back flow and IBC contamination by simply replacing with **CPP's** new Check-It seal!



Retro fit directly on the IBC valve outlet

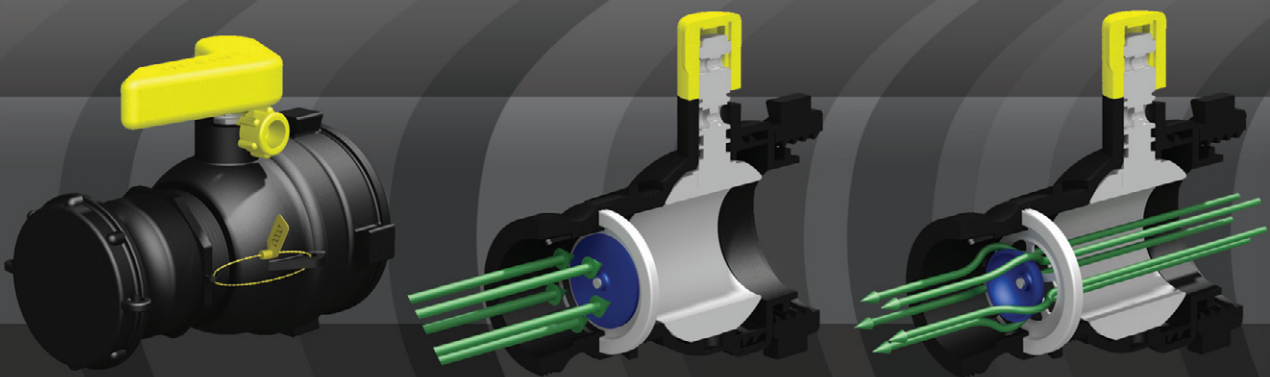

CPP IBC VENTS

IBC Vents

The newly designed pressure and vacuum vent from CPP will protect your container and valuable content without the need to remove the top. Moulded in glass coupled polypropylene and springs in stainless steel this product will give you the chemical resistance and durability you expect from CPP.

We are introducing more vents over the coming months please check our website regularly for details.

Cross section description:

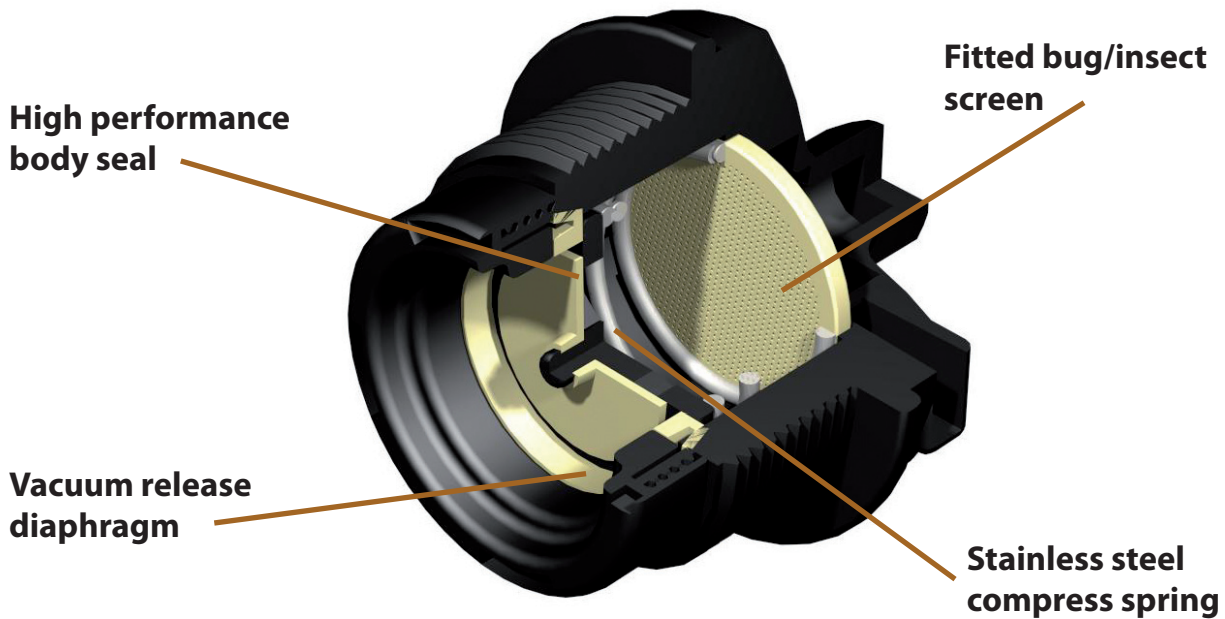

IBC Vents — 2" male threaded vent



ID	Product Number	Product Description	IBC Fitting
1	HMVN/20NR/027	2" NPT male vent, 1 PSI vacuum & pressure G/P/P SS	N/A
2	HMVN/20BR/027	2" BSP male vent, 1 PSI vacuum & pressure G/P/P SS	N/A
3	HMVBS-65MD-SAN	2" vent bug screen, SAN	N/A

Drum Adaptors

We have taken the best of what we have learnt from the IBC off load systems and have since applied it to drum adaptors, offering you adaptors for the most common imported and domestic plastic drums to ensure you can always make a connection. Designed and constructed for Industrial usage, moulded in food grade class coupled polypropylene, and we include seals as standard. All bagged and labelled for easy identification and cleanliness.

All products backed (as standard) with CPP product and manufacturers insurance against defects and failure.

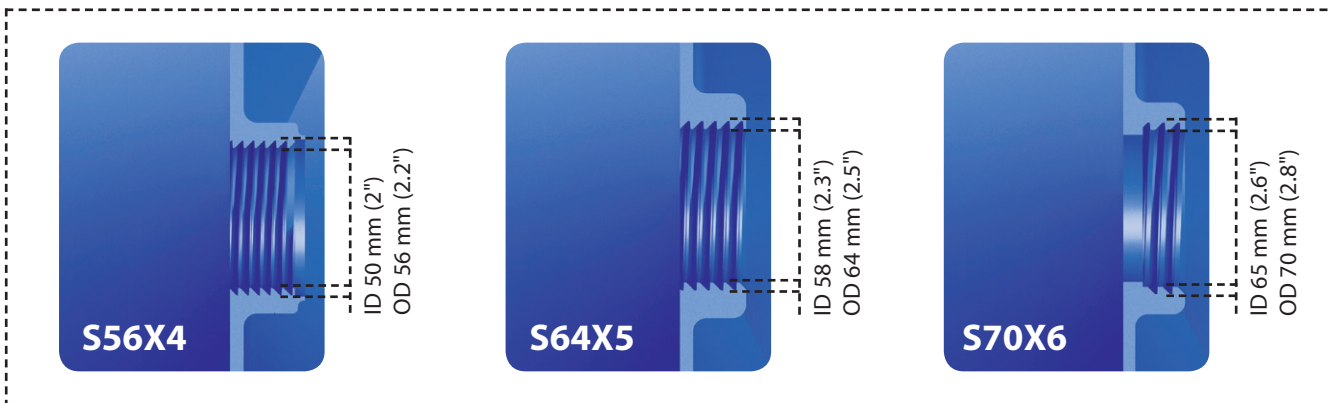

Part 'DA' — Male thread X female thread









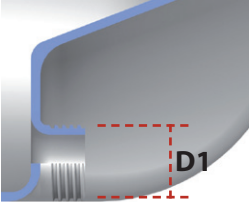
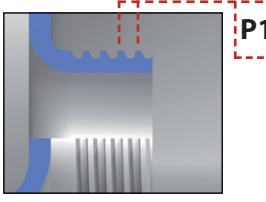

ID	Product Number	Product Description	Drum Fitting
1	DBMFB/56U20B/027	S56X4 male drum thread x 2" BSP female G/P/P W/C o-ring	S56X4
2	DBMFB/56U75B/027	S56X4 male drum thread x ¾" BSP female G/P/P W/C o-ring	S56X4
3	DBMFB/64U20B/027	S64X5 male drum thread x 2" BSP female G/P/P W/C o-ring	S64X5
4	DBMFB/64U75B/027	S64X5 male drum thread x ¾" BSP female G/P/P W/C o-ring	S64X5
5	DBMFB/70U20B/027	S70X6 male drum thread x 2" BSP female G/P/P W/C o-ring	S70X6
6	DBMFB/70U75B/027	S70X6 male drum thread x ¾" BSP female G/P/P W/C o-ring	S70X6

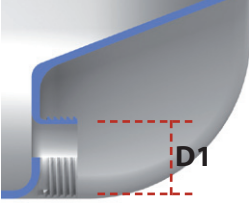
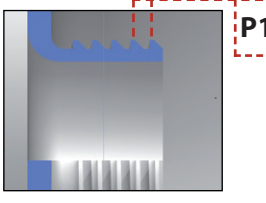
CPP IBC VALVES

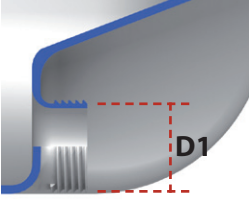
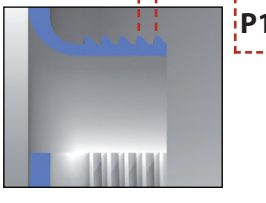
IBC Valves

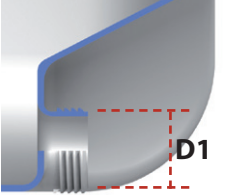
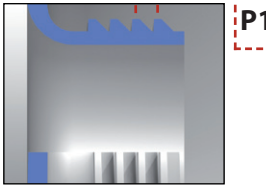
The 2" Darcie and 3" Stellar IBC valves from CPP offers greater flexibility and reliability than any other IBC valve on the market today. The features include: PE seals to reduce stock levels – no need to have VITON and EPDM seals, the 'swivel' back collar speeds up assembly – no need to turn the whole valve, Greater product range with 2" & 3" Camlock, 2" male NPT, 2" male S60 buttress, 1 1/2" female, S100 male buttress end connections, Full flow valves decrease empty times and allow greater IBC drainage with less residual for the IBC reconditioner to handle, Increased compatibility with all PP body and all PE seals and gaskets and essentially reduce labour costs All valve assemblies come complete with gasket, dust cap, lanyard and lock pin.

IBC Fitting	Thread	Description	Key
		Name: S60X6 (2") male buttress D1: 60mm (2.36") P1: 6mm (0.24") Manufacturer: Greif, Mauser (Mamor), Sotralentz	
		Name: S75X6 (2") male buttress D1: 75mm (2.95") P1: 6mm (0.24") Manufacturer: Schütz, Clawson, Fustiplast	
		Name: S80X6 (2") male buttress D1: 80mm (3.15") P1: 6mm (0.24") Manufacturer: Mauser (Hoover)	
		Name: S100X8 (3") male buttress D1: 100mm (3.94") P1: 8mm (0.32") Manufacturer: Schütz, Greif, Mauser (Mamor), Fustiplast, Sotralentz	

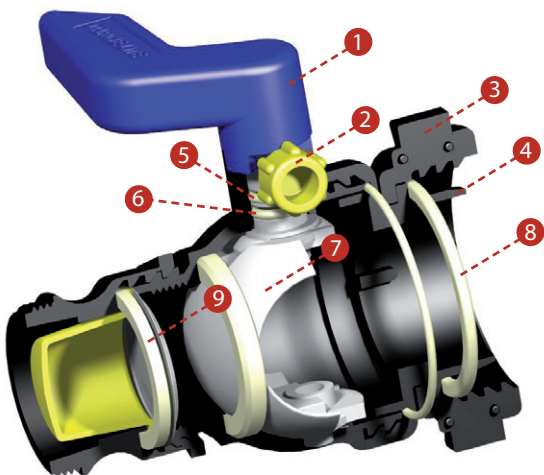

ID	Description
1	Angled for more room in the IBC valve recess
2	Locking pin as standard
3	Independant swiveling nut moulded in plastic eliminating chemical attack
4	Additional spigot for secure fit to the IBC
5	Stainless steel reinforced spindle
6	Dual spindle o-rings
7	Exclusive ball design with top and bottom spindles for low pressure sealing
8	Seal moulded in LDPE or PP elastomers
9	Ball seat profiled and precision injection moulded for maximum sealing

IBC Valves — 2" IBC Valves

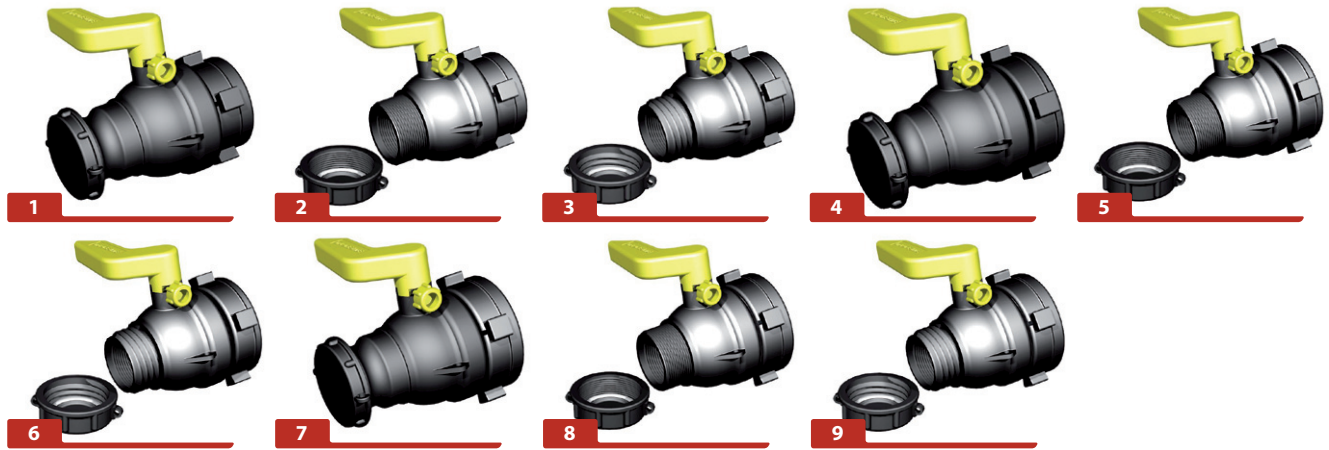

ID	Product Number	Product Description	IBC Fitting
1	DL2/60UF/2CAM/7	2" 'DARCIE-LITE' IBC ball valve, S60X6 female buttress in-let X 2" Camlock adaptor C/W dust cap, BLACK,G/P/P	
2	DL2/60UF/2NPM/7	2" 'DARCIE-LITE' IBC ball valve, S60X6 female buttress in-let X 2" NPT male, C/W dust cap, BLACK,G/P/P	
3	DL2/60UF/60UM/7	2" 'DARCIE-LITE' IBC ball valve, S60X6 female buttress in-let X S60X6 male, C/W dust cap, BLACK,G/P/P	
4	DL2/75UF/2CAM/7	2" 'DARCIE-LITE' IBC ball valve, S75X6 female buttress in-let X 2" Camlock adaptor C/W dust cap, BLACK, G/P/P	
5	DL2/75UF/2NPM/7	2" 'DARCIE-LITE' IBC ball valve, S75X6 female buttress in-let X 2" NPT male, C/W dust cap, BLACK, G/P/P	
6	DL2/75UF/60UM/7	2" 'DARCIE-LITE' IBC ball valve, S75X6 female buttress in-let X S60X6 male, C/W dust cap, BLACK, G/P/P	
7	DL2/80UF/2CAM/7	2" 'DARCIE-LITE' IBC ball valve, S80X6 female buttress in-let X 2" Camlock adaptor C/W dust cap, BLACK, G/P/P	
8	DL2/80UF/2NPM/7	2" 'DARCIE-LITE' IBC ball valve, S80X6 female buttress in-let X 2" NPT male, C/W dust cap, BLACK, G/P/P	
9	DL2/80UF/60UM/7	2" 'DARCIE-LITE' IBC ball valve, S80X6 female buttress in-let X S60X6 male, C/W dust cap, BLACK, G/P/P	

IBC Valves — 3" IBC Valves



ID	Product Number	Product Description	IBC Fitting
1	SL3/10U/10U/7	3" 'STELLAR-LITE' IBC valve, 100X8 female buttress in-let X S100 MALE OUT-LET G/P/P.	
2	SL3/10U/3A/7	3" 'STELLAR-LITE' IBC valve, 100X8 female buttress in-let X 3" Camlock adaptor with external 3" BSP, with cap and lanyard. nat G/P/P.	

CPP KEYLOCK

Key-lock

The CPP range of keyed couplers and adaptors comes as standard in three key sets Alpha, Beta and Delta, an Alpha Coupler will only fit with an 'Alpha' adaptor stopping cross contamination. All our male Keylocks have a seal at the base of the female thread for quick and easy sealing and essentially we have thread options for connecting to European and US IBC totes.

Chemical resistance, pressure ratings and food contact details are available from our website.

2" Keylock couplers

Part 'KD' — Keylock female coupler X female thread



ID	Product Number	Product Description	IBC Fitting
1	KACFD/20B/027	2" part `KD`, 2" Keylock coupler Alpha X 2" BSP female, G/P/P	N/A
2	KBCFD/20B/027	2" part `KD`, 2" Keylock coupler Beta X 2" BSP female, G/P/P	N/A
3	KDCFD/20B/027	2" part `KD`, 2" Keylock coupler Delta X 2" BSP female, G/P/P	N/A
4	KACFD/20N/027	2" part `KD`, 2" Keylock coupler Alpha X 2" NPT female, G/P/P	N/A
5	KBCFD/20N/027	2" part `KD`, 2" Keylock coupler Beta X 2" NPT female, G/P/P	N/A
6	KDCFD/20N/027	2" part `KD`, 2" Keylock coupler Delta X 2" NPT female, G/P/P	N/A

Keylock gasket



ID	Product Number	Product Description	IBC Fitting
1	KCG202/EPM/BL	2" Keylock gasket for 2" female coupler SAN., black	N/A

Part 'KA' — Keylock male adaptor X female thread

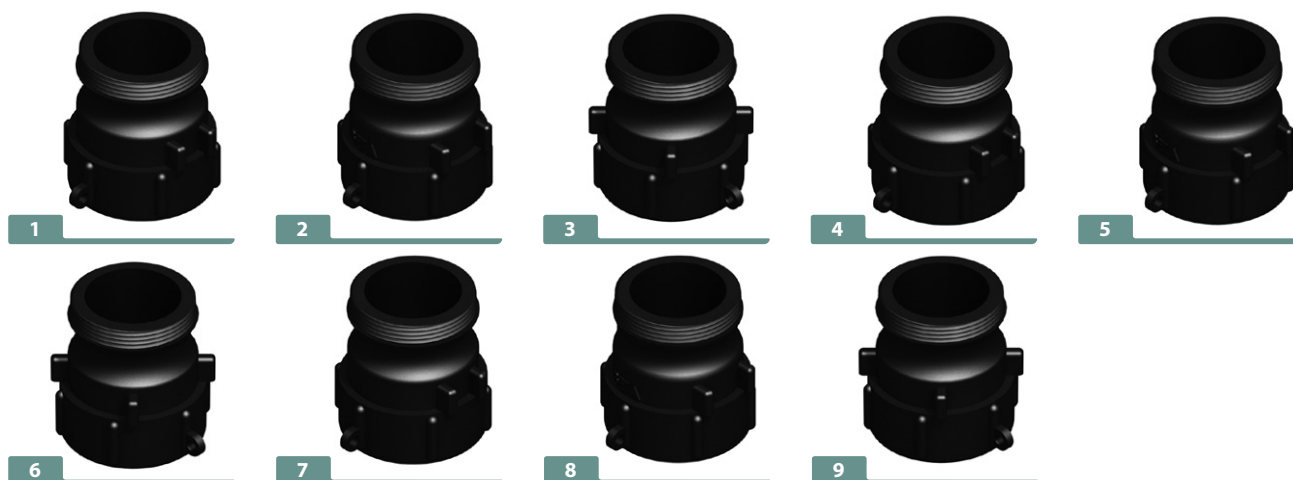

ID	Product Number	Product Description	IBC Fitting
1	KACMA/20BP/027	2" part `KA`, 2" Keylock adaptor Alpha X 2" BSP female C/W seal, G/P/P	N/A
2	KBCMA/20BP/027	2" part `KA`, 2" Keylock adaptor Beta X 2" BSP female C/W seal, G/P/P	N/A
3	KDCMA/20BP/027	2" part `KA`, 2" Keylock adaptor Delta X 2" BSP female C/W seal, G/P/P	N/A
4	KACMA/20M/027	2" part `KA`, 2" Keylock adaptor Alpha X 2" NPS female C/W seal, G/P/P	▼
5	KBCMA/20M/027	2" part `KA`, 2" Keylock adaptor Beta X 2" NPS female C/W seal, G/P/P	▼
6	KDCMA/20M/027	2" part `KA`, 2" Keylock adaptor Delta X 2" NPS female C/W seal, G/P/P	▼
7	KACMA/20UD/027	2" part `KA`, 2" Keylock adaptor Alpha X 2" S60X6 female C/W seal, G/P/P	▲
8	KBCMA/20UD/027	2" part `KA`, 2" Keylock adaptor Beta X 2" S60X6 female C/W seal, G/P/P	▲
9	KDCMA/20UD/027	2" part `KA`, 2" Keylock adaptor Delta X 2" S60X6 female C/W seal, G/P/P	▲

Part 'KDP' — Keylock male adaptor X dust plug



ID	Product Number	Product Description	IBC Fitting
1	KCMP/20P/027	2" part 'KDP', 2" Keylock male dust plug, fits all, G/P/P	N/A

Spares — Keylock dust cap and spares

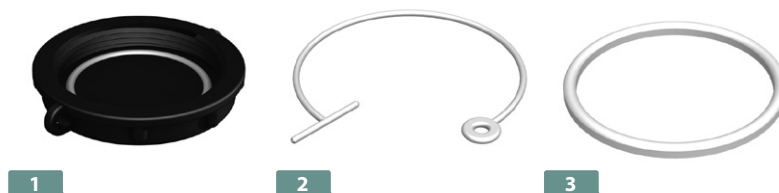

ID	Product Number	Product Description	IBC Fitting
1	K2BCS/20B/027	2" Keylock cap for male adaptor, C/W seal & lanyard, G/P/P	N/A
2	KMF/LAN/80	Keylock Lanyard White LD 80	N/A
3	KGC202/EPM/NAT	2" Keylock Cap Gasket SAN. Natural	N/A

CPP CAMLOCK

Camlock

Each of our Camlock range of glass fibre filled polypropylene cam and groove couplings are moulded to the highest standards in our factory in the UK under a quality controlled management system. The excellent chemical resistance and light weight of polypropylene combined with all moving parts made of stainless steel makes this quick disconnect coupling one of the most cost-effective products on the market.

Part 'A' — Camlock male adaptor X BSP female thread



ID	Product Number	Product Description
1	CMA/05B/027	½" part 'A', ¾" Camlock adaptor X ½" BSP female G/PP
2	CMA/75B/027	¾" part 'A', ¾" Camlock adaptor X ¾" BSP female G/PP
3	CMA/10B/027	1" part 'A', 1" Camlock adaptor X 1" BSP female G/PP
4	CMA/1012B/027	1" part 'A', 1" Camlock adaptor X 1 ¼" BSP female G/P/P
5	CMA/16B/027	True 1 ¼" part 'A', 1 ¼" Camlock adaptor X 1 ¼" BSP female G/PP
6	CMA/12B/027	1 ¼" part 'A', 1 ½" Camlock adaptor X 1 ¼" BSP female G/PP
7	CMA/15B/027	1 ½" part 'A', 1 ½" Camlock adaptor X 1 ½" BSP female G/PP
8	CMA/20B/027	2" part 'A', 2" Camlock adaptor X 2" BSP female G/PP
9	CMA/30B/027	3" part 'A', 3" Camlock adaptor X 3" BSP female G/PP
10	CMA/40B/027	4" part 'A', 4" Camlock adaptor X 4" BSP female G/PP

IBC Adaptors

- 2" and 3" Butress Threads
- Glass coupled Polypropylene
- Food grade
- Direct from stock

visit www.cpp-lm.com



Part 'A' — Camlock male adaptor X NPT female threaded

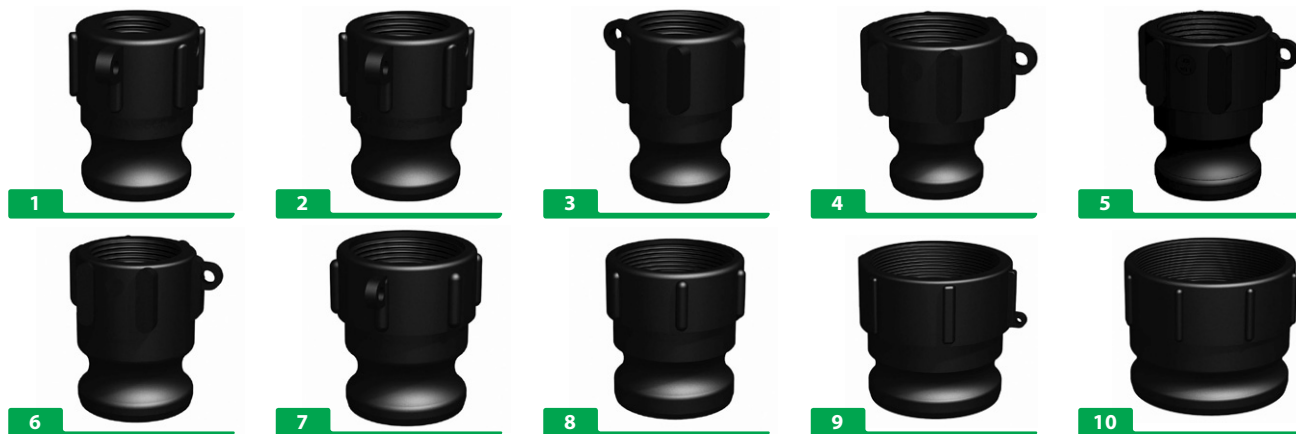

ID	Product Number	Product Description
1	CMA/05N/027	½" part 'A', ¾" Camlock adaptor X ½" NPT female G/PP
2	CMA/75N/027	¾" part 'A', ¾" Camlock adaptor X ¾" NPT female G/PP
3	CMA/10N/027	1" part 'A', 1" Camlock adaptor X 1" NPT female G/PP
4	CMA/1012N/027	1" part 'A', 1" Camlock adaptor X 1 ¼" NPT female G/P/P
5	CMA/16N/027	True 1 ¼" part 'A', 1 ¼" Camlock adaptor X 1 ¼" NPT female G/PP
6	CMA/12N/027	1 ¼" part 'A', 1 ½" Camlock adaptor X 1 ¼" NTP female G/PP
7	CMA/15N/027	1 ½" part 'A', 1 ½" Camlock adaptor X 1 ½" NPT female G/PP
8	CMA/20N/027	2" part 'A', 2" Camlock adaptor X 2" NPT female G/PP
9	CMA/30N/027	3" part 'A', 3" Camlock adaptor X 3" NPT female G/PP
10	CMA/40N/027	4" part 'A', 4" Camlock adaptor X 4" NPT female G/PP

Part 'B' — Camlock female coupler X male BSPT male thread



ID	Product Number	Product Description
1	CFB/05B/027	½" part 'B', ¾" Camlock coupler X ½" BSPT male G/PP
2	CFB/75B/027	¾" part 'B', ¾" Camlock coupler X ¾" BSPT male G/PP
3	CFB/10B/027	1" part 'B', 1" Camlock coupler X 1" BSPT male G/PP
4	CFB/1012B/027	1" X 1 ¼" part 'B', 1" Camlock coupler X 1 ¼" BSPT male G/P/P
5	CFB/16B/027	True 1 ¼" part 'B', 1 ¼" Camlock coupler X 1 ¼" BSPT male G/PP
6	CFB/12B/027	1 ¼" part 'B', 1 ½" Camlock coupler X 1 ¼" BSPT male G/PP
7	CFB/15B/027	1 ½" part 'B', 1 ½" Camlock coupler X 1 ½" BSPT male G/PP
8	CFB/20B/027	2" part 'B', 2" Camlock coupler X 2" BSPT male G/PP
9	CFB/30B/027	3" part 'B', 3" Camlock coupler X 3" BSPT male G/PP
10	CFB/40B/027	4" part 'B', 4" Camlock coupler X 4" BSPT male G/PP

Part 'B' — Camlock female coupler X male NPT thread



ID	Product Number	Product Description
1	CFB/05N/027	1/2" part 'B', 3/4" Camlock coupler X 1/2" NPT male G/PP
2	CFB/75N/027	3/4" part 'B', 3/4" Camlock coupler X 3/4" NPT male G/PP
3	CFB/10N/027	1" part 'B', 1" Camlock coupler X 1" NPT male G/PP
4	CFB/1012N/027	1" X 1 1/4" part 'B', 1" Camlock coupler X 1 1/4" NPT male G/P/P
5	CFB/16N/027	True 1 1/4" part 'B', 1 1/4" Camlock coupler X 1 1/4" NPT male G/PP
6	CFB/12N/027	1 1/4" part 'B', 1 1/2" Camlock coupler X 1 1/4" NPT male G/PP
7	CFB/15N/027	1 1/2" part 'B', 1 1/2" Camlock coupler X 1 1/2" NPT male G/PP
8	CFB/20N/027	2" part 'B', 2" Camlock coupler X 2" NPT male G/PP
9	CFB/30N/027	3" part 'B', 3" Camlock coupler X 3" NPT male G/PP
10	CFB/40N/027	4" part 'B', 4" Camlock coupler X 4" NPT male G/PP

Part 'C' — Camlock female coupler X hose tail



ID	Product Number	Product Description
1	CFC/05T/027	1/2" part 'C', 3/4" Camlock coupler X 1/2" (13mm) hose tail
2	CFC/75T/027	3/4" part 'C', 3/4" Camlock coupler X 3/4" (19mm) hose tail
3	CFC/10T/027	1" part 'C', 1" Camlock coupler X 1" (25mm) hose tail
4	CFC/16T/027	True 1 1/4" part 'C', 1 1/4" Camlock coupler X 1 1/4" (32mm) hose tail
5	CFC/12T/027	1 1/4" part 'C', 1 1/2" Camlock coupler X 1 1/4" (32mm) hose tail
6	CFC/15T/027	1 1/2" part 'C', 1 1/2" Camlock coupler X 1 1/2" (38mm) hose tail
7	CFC/20T/027	2" part 'C', 2" Camlock coupler X 2" (50mm) hose tail
8	CFC/30T/027	3" part 'C', 3" Camlock coupler X 3" (75mm) hose tail
9	CFC/40T/027	4" part 'C', 4" Camlock coupler X 4" (101.5mm) hose tail

Part 'D' — Camlock female coupler X female BSP thread



ID	Product Number	Product Description
1	CFD/05B/027	½" part 'D', ¾" Camlock coupler X ½" BSP female G/PP
2	CFD/75B/027	¾" part 'D', ¾" Camlock coupler X ¾" BSP female G/PP
3	CFD/10B/027	1" part 'D', 1" Camlock coupler X 1" BSP female G/PP
4	CFD/1012B/027	1" X 1 ¼" part 'D', 1" Camlock coupler X 1 ¼" BSP female G/P/P
5	CFD/16B/027	True 1 ¼" part 'D', 1 ¼" Camlock coupler X 1 ¼" BSP female G/PP
6	CFD/12B/027	1 ¼" part 'D', 1 ½" Camlock coupler X 1 ¼" BSP female G/PP
7	CFD/15B/027	1 ½" part 'D', 1 ½" Camlock coupler X 1 ½" BSP female G/PP
8	CFD/20B/027	2" part 'D', 2" Camlock coupler X 2" BSP female G/PP
9	CFD/30B/027	3" part 'D', 3" Camlock coupler X 3" BSP female G/PP
10	CFD/40B/027	4" part 'D', 4" Camlock coupler X 4" BSP female G/PP

Part 'D' — Camlock female coupler X female NPT thread



ID	Product Number	Product Description
1	CFD/05N/027	½" part 'D', ¾" Camlock coupler X ½" NPT female G/PP
2	CFD/75N/027	¾" part 'D', ¾" Camlock coupler X ¾" NPT female G/PP
3	CFD/10N/027	1" part 'D', 1" Camlock coupler X 1" NPT female G/PP
4	CFD/1012N/027	1" X 1 ¼" part 'D', 1" Camlock coupler X 1 ¼" NPT female G/P/P
5	CFD/16N/027	True 1 ¼" part 'D', 1 ¼" Camlock coupler X 1 ¼" NPT female G/PP
6	CFD/12N/027	1 ¼" part 'D', 1 ½" Camlock coupler X 1 ¼" NPT female G/PP
7	CFD/15N/027	1 ½" part 'D', 1 ½" Camlock coupler X 1 ½" NPT female G/PP
8	CFD/20N/027	2" part 'D', 2" Camlock coupler X 2" NPT female G/PP
9	CFD/30N/027	3" part 'D', 3" Camlock coupler X 3" NPT female G/PP
10	CFD/40N/027	4" part 'D', 4" Camlock coupler X 4" NPT female G/PP

Part 'E' — *Camlock male adaptor X hose tail*

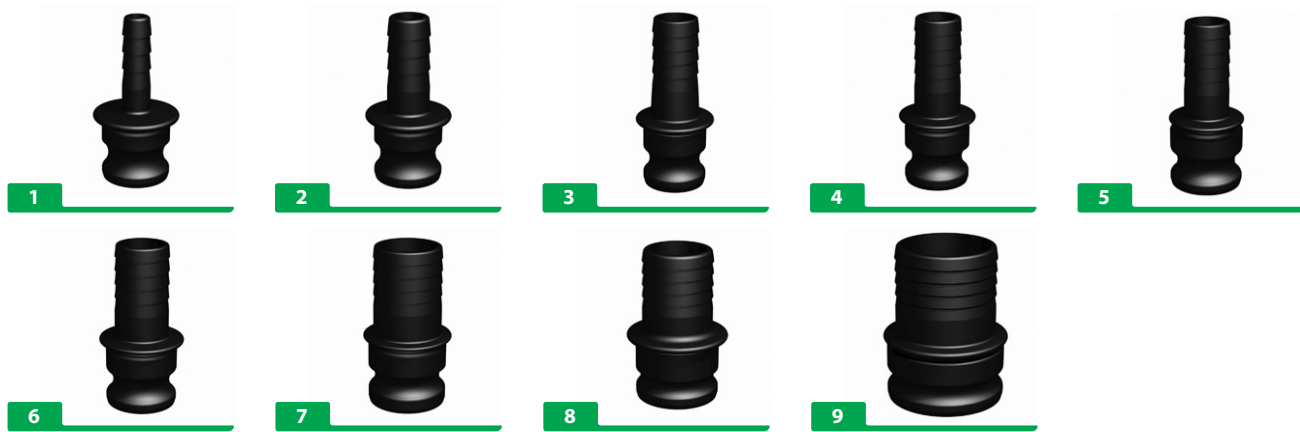

ID	Product Number	Product Description
1	CME/05T/027	1/2" part 'E', 3/4" Camlock adaptor X 1/2" (13mm) hose tail
2	CME/75T/027	3/4" part 'E', 3/4" Camlock adaptor X 3/4" (19mm) hose tail
3	CME/10T/027	1" part 'E', 1" Camlock adaptor X 1" (25mm) hose tail
4	CME/16T/027	True 1 1/4" part 'E', 1 1/4" Camlock adaptor X 1 1/4" (32mm) hose tail
5	CME/12T/027	1 1/4" part 'E', 1 1/2" Camlock adaptor X 1 1/4" (32mm) hose tail
6	CME/15T/027	1 1/2" part 'E', 1 1/2" Camlock adaptor X 1 1/2" (38mm) hose tail
7	CME/20T/027	2" part 'E', 2" Camlock adaptor X 2" (50mm) hose tail
8	CME/30T/027	3" part 'E', 3" Camlock adaptor X 3" (75mm) hose tail
9	CME/40T/027	4" part 'E', 4" Camlock adaptor X 4" (101..5mm) hose tail

Part 'F' — *Camlock male adaptors X male BSPT thread*



ID	Product Number	Product Description
1	CMF/05B/027	1/2" part 'F', 3/4" Camlock adaptor X 1/2" BSPT male G/PP
2	CMF/75B/027	3/4" part 'F', 3/4" Camlock adaptor X 3/4" BSPT male G/PP
3	CMF/10B/027	1" part 'F', 1" Camlock adaptor X 1" BSPT male G/PP
4	CMF/1012B/027	1" X 1 1/4" part 'F', 1" Camlock adaptor X 1 1/4" BSP male G/P/P
5	CMF/16B/027	True 1 1/4" part 'F', 1 1/4" Camlock adaptor X 1 1/4" BSPT male G/PP
6	CMF/12B/027	1 1/4" part 'F', 1 1/2" Camlock adaptor X 1 1/4" BSPT male G/PP
7	CMF/15B/027	1 1/2" part 'F', 1 1/2" Camlock adaptor X 1 1/2" BSPT male G/PP
8	CMF/20B/027	2" part 'F', 2" Camlock adaptor X 2" BSPT male G/PP
9	CMF/30B/027	3" part 'F', 3" Camlock adaptor X 3" BSPT male G/PP
10	CMF/40B/027	4" part 'F', 4" Camlock adaptor X 4" BSPT male G/PP

Part 'F' — *Camlock male adaptors X male NPT thread*



ID	Product Number	Product Description
1	CMF/05N/027	½" part 'F', ¾" Camlock adaptor X ½" NPT male G/PP
2	CMF/75N/027	¾" part 'F', ¾" Camlock adaptor X ¾" NPT male G/PP
3	CMF/10N/027	1" part 'F', 1" Camlock adaptor X 1" NPT male G/PP
4	CMF/1012B/027	1" X 1 ¼" part 'F', 1" Camlock adaptor X 1 ¼" NPT male G/P/P
5	CMF/16N/027	True 1 ¼" part 'F', 1 ¼" Camlock adaptor X 1 ¼" NPT male G/PP
6	CMF/12N/027	1 ¼" part 'F', 1 ½" Camlock adaptor X 1 ¼" NPT male G/PP
7	CMF/15N/027	1 ½" part 'F', 1 ½" Camlock adaptor X 1 ½" NPT male G/PP
8	CMF/20N/027	2" part 'F', 2" Camlock adaptor X 2" NPT male G/PP
9	CMF/30N/027	3" part 'F', 3" Camlock adaptor X 3" NPT male G/PP
10	CMF/40N/027	4" part 'F', 4" Camlock adaptor X 4" NPT male G/PP

Part 'DC' — *Camlock female coupler X dust cap*



ID	Product Number	Product Description
1	CFH/75C/027	¾" part 'DC', ¾" Camlock coupler X dust cap G/PP
2	CFH/10C/027	1" part 'DC', 1" Camlock coupler X dust cap G/PP
3	CFH/16C/027	True 1 ¼" part 'DC', 1 ¼" Camlock coupler X dust cap G/PP
4	CFH/15C/027	1 ½" part 'DC', 1 ½" Camlock coupler X dust cap G/PP
5	CFH/20C/027	2" part 'DC', 2" Camlock coupler X dust cap G/PP
6	CFH/30C/027	3" part 'DC', 3" Camlock coupler X dust cap G/PP
7	CFH/40C/027	4" part 'DC', 4" Camlock coupler X dust cap G/PP

Part 'DP' — Camlock male adaptor X dust plug



ID	Product Number	Product Description
1	CMP/75P/027	3/4" part 'DP', 3/4" Camlock adaptor X dust plug G/PP
2	CMP/10P/027	1" part 'DP', 1" Camlock adaptor X dust plug G/PP
3	CMP/16P/027	True 1 1/4" part 'DP', 3/4" Camlock adaptor X dust plug G/PP
4	CMP/15P/027	1 1/2" part 'DP', 1 1/2" Camlock adaptor X dust plug G/PP
5	CMP/20P/027	2" part 'DP', 2" Camlock adaptor X dust plug G/PP
6	CMP/30P/027	3" part 'DP', 3" Camlock adaptor X dust plug G/PP
7	CMP/40P/027	4" part 'DP', 4" Camlock adaptor X dust plug G/PP

Spare parts — Cam arms

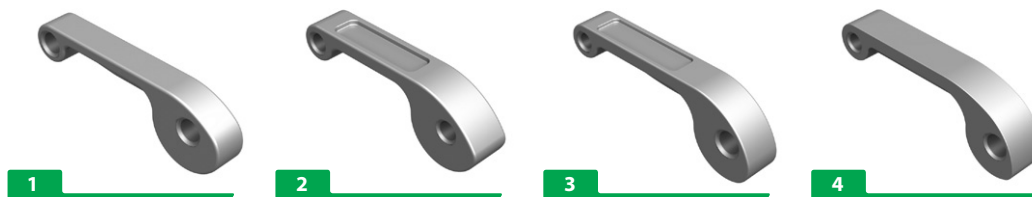

ID	Product Number	Product Description
1	CAS/75S/SS	1/2" - 3/4" cam arm, stainless steel
2	CAS/10S/SS	1" cam arm, stainless steel
3	CAS/22S/SS	1 1/4" - 2 1/2" cam arm, stainless steel
4	CAS/34S/SS	3" - 4" cam arm, stainless steel

Spare parts — Cam arm pins



ID	Product Number	Product Description
1	CAP/75M/SS	1/2" - 3/4" cam arm pin, stainless steel
2	CAP/10M/SS	1" cam arm pin, stainless steel
3	CAP/15M/SS	1 1/4" - 1 1/2" cam arm pin, stainless steel
4	CAP/20M/SS	2" cam arm pin, stainless steel
5	CAP/34M/SS	3" - 4" cam arm pin, stainless steel

Spare parts — Cam arm finger ring



1

ID	Product Number	Product Description
1	CAR/ALL/SS	½" - 4" cam arm finger ring, stainless steel

Spare parts — Camlock female gaskets



1



2



3



4



5



6



7

ID	Product Number	Product Description
1	CG75/EPM/BL	½" - ¾" cam gasket, EPDM/P.P, black
2	CG10/EPM/BL	1" cam gasket, EPDM/P.P, black
3	CG12/EPM/BL	True 1 ¼" cam gasket, EPDM/P.P, black
4	CG15/EPM/BL	1 ½" cam gasket, EPDM/P.P, black
5	CG20/EPM/BL	2" cam gasket, EPDM/P.P, black
6	CG30/EPM/BL	3" cam gasket, EPDM/P.P, black
7	CG40/EPM/BL	4" cam gasket, EPDM/P.P, black

CPP HOSE FITTINGS

Polymer Hose Fittings

Hex: Glass coupled polypropylene hose tails with parallel male thread

Lugged couplings: Polypropylene hose couplings, caps and plugs in BSP and URT threads

Standard Hex threaded polypropylene fittings

Part 'HE' — Male threaded x hose tail

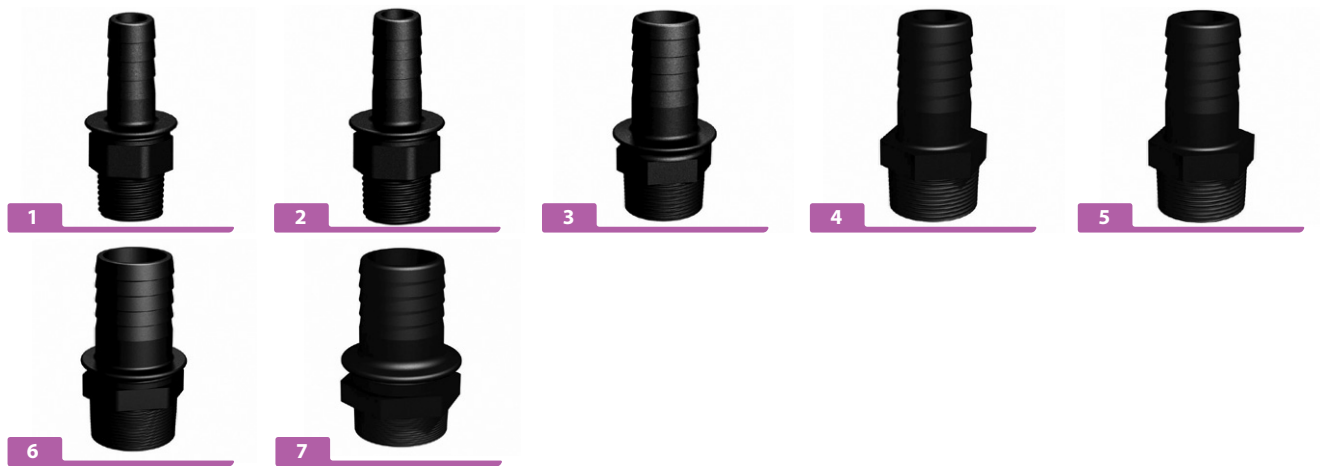

ID	Product Number	Product Description
1	HMB/05T/027	½" BSP hex. Male X ½"(13mm) hose tail G/P/P
2	HMB/75T/027	¾" BSP hex. Male X ¾"(19mm) hose tail G/P/P
3	HMB/10T/027	1" BSP hex. Male X 1"(25mm) hose tail G/P/P
4	HMB/12T/027	1 ¼" BSP hex. Male X 1 ¼"(32mm) hose tail G/P/P
5	HMB/15T/027	1 ½" BSP hex. Male X 1 ½"(38mm) hose tail G/P/P
6	HMB/20T/027	2" BSP hex. Male X 2"(50mm) hose tail G/P/P
7	HMB/30T/027	3" BSP hex. Male X 3"(75mm) hose tail G/P/P

Standard Lugged threaded polypropylene fittings

Part 'LC' — Female thread lugged nut X hose tail



ID	Product Number	Product Description
1	LFBG/15S/025	1 ½" BSP lugged female - flat gasket x 1 ½" (38mm) hose tail P/P
2	LFBG/20S/025	2" BSP lugged female - flat gasket x 2" (50mm) hose tail P/P
3	LFBG/25S/025	2 ½" BSP lugged female - flat gasket x 2 ½" (63mm) hose tail P/P
4	LFBG/30S/025	3" BSP lugged female - flat gasket x 3" (75mm) hose tail P/P
5	LFBG/40S/025	4" BSP lugged female x 4" - flat gasket (101.5mm) hose tail P/P

Part 'LE' — Male thread lugged X hose tail



ID	Product Number	Product Description
1	LMB/15S/025	1 ½" BSP lugged male x 1 ½" (38mm) hose tail P/P
2	LMB/20S/025	2" BSP lugged male x 2" (50mm) hose tail P/P
3	LMB/25S/025	2 ½" BSP lugged male x 2 ½" (63mm) hose tail P/P
4	LMB/30S/025	3" BSP lugged male x 3" (75mm) hose tail P/P
5	LMB/40S/025	4" BSP lugged male x 4" (101.5mm) hose tail P/P

Part 'LDC' — Female threaded lugged nut X dust cap



ID	Product Number	Product Description
1	LCBG/15P/025	1 ½" BSP lugged female - flat gasket x dust cap P/P
2	LCBG/20P/025	2" BSP lugged female - flat gasket x dust cap P/P
3	LCBG/25P/025	2 ½" BSP lugged female - flat gasket x dust cap P/P
4	LCBG/30P/025	3" BSP lugged female - flat gasket x dust cap P/P
5	LCBG/40P/025	4" BSP lugged female - flat gasket x dust cap P/P

Part 'LDP' — Male thread lugged X dust cap



ID	Product Number	Product Description
1	LPB/15P/025	1 ½" BSP lugged male x dust plug P/P
2	LPB/20P/025	2" BSP lugged male x dust plug P/P
3	LPB/25P/025	2 ½" BSP lugged male x dust plug P/P
4	LPB/30P/025	3" BSP lugged male x dust plug P/P
5	LPB/40P/025	4" BSP lugged male x dust plug P/P

Part 'LUC' — *URT female threaded lugged nut X hose tail*

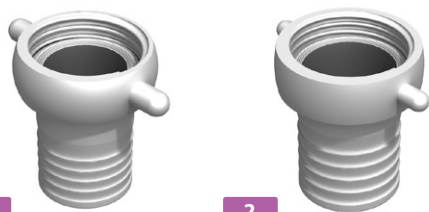

ID	Product Number	Product Description
1	LFUG/30S/025	3" URT lugged female - flat gasket x 3" (75mm) hose tail P/P
2	LFUG/40S/025	4" URT lugged female - flat gasket x 4" (101.5mm) hose tail P/P

Part 'LUE' — *URT male thread lugged X hose tail*

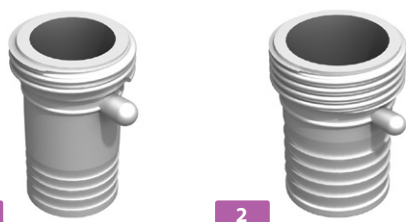

ID	Product Number	Product Description
1	LMU/30S/025	3" URT lugged male x 3" (75mm) hose tail P/P
2	LMU/40S/025	4" URT lugged male x 4" (101.5mm) hose tail P/P

Part 'LUDC' — *URT female threaded lugged nut X dust cap*

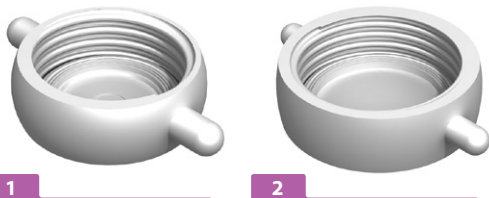

ID	Product Number	Product Description
1	LCUG/30P/025	3" URT lugged female - flat gasket x dust cap P/P
2	LCUG/40P/025	4" URT lugged female - flat gasket x dust cap

Part 'LUDP' — *URT male thread lugged X dust plug*

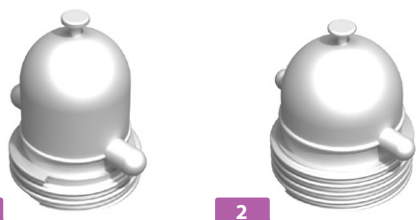

ID	Product Number	Product Description
1	LPU/30P/025	3" URT lugged male x dust plug P/P
2	LPU/40P/025	4" URT male lugged x dust plug P/P

Part 'LUB' — URT female threaded nut X male thread



2

ID	Product Number	Product Description
1	AFGM/004/025	4" URT lugged female - flat gasket x 3" URT male adaptor P/P

Spares — Lugged coupling gaskets



1

2

3

4

5

ID	Product Number	Product Description
1	LG15/PP/WT	1 ½" Lugged Gasket Ribbed White PP
2	LG20/PP/WT	2" Lugged Gasket Ribbed White PP
3	LG25/PP/WT	2 ½" Lugged Gasket Ribbed White PP
4	LG30/PP/WT	3" Lugged Gasket Ribbed White PP
5	LG40/PP/WT	4" Lugged Gasket Ribbed White PP

Design and Development

Working closely with our customers, the CPP engineering team develops fully-capable manufacturing systems that meet and exceed customers' quality and time-to-market objectives.

The effective program management and close customer communication that result ensure that all expectations are met and a long-term, cost-effective manufacturing solution is achieved

Tooling

CPP Manufacturing builds high-quality precision moulds, offering the latest in CNC and EDM technology. Our plants are equipped and staffed to cost-effectively meet the needs of our customers.

A quality product must begin with the highest-quality mould, and quality moulds have been key building blocks in CPP's success.

Manufacturing

CPP's industry-leading production facilities offer the very latest in closed-loop control injection molding technology and automation systems.

Our injection moulding facilities are designed to maximize efficiency and product output while our employees are extensively trained to focus on quality and to meet our customers' needs

Testing & Quality

At CPP, quality is at the heart of everything we do. It is our goal to provide our customers with defect-free products, and to continually push the limits of and redefine the term "World-Class" quality for injection moulded products.

What is your cost of quality?

- Do you spend time inspecting/sorting plastic parts?
- Do you lose productivity or yields due to defective plastic product?
- Do you lose customer satisfaction or market share due to warranty returns or product failures?

These are just a few factors that drive your overall cost of quality. The "lowest cost" supplier for a project can actually end up costing your company more in the long run, if they are unable to minimize the overall cost of quality on incoming plastic products. It is no longer necessary to sacrifice price to get world-class quality or to sacrifice quality to get a competitive price for you plastic product needs.

Our commitment to Continuous Improvement, Statistical Process Control and technological advantages, allow us to meet your most stringent injection moulding and plastics quality requirements, minimizing your total cost of quality. We understand that the product we mould not only determines our reputation but also the reputation of our customer.

Terms and Conditions

Definitions

In these terms and conditions 'the company' shall mean CPP-LM Ltd whose registered office is Unit 38, Crayford Industrial Estate, Crayford Kent DA1 4HS, United Kingdom.

'The customer' shall mean the person, firm, company or organisation purchasing or agreeing to purchase the products from the company.

General

All orders for products on the company's website or brochure are accepted by the company subject to these terms and conditions of sale. No other terms will apply to the supply of the products unless agreed in writing by an authorised signatory of the company.

All descriptions of the products contained in the company website/brochure or otherwise communicated to the customer are approximate only and shall not form any part of the contract between the company and the customer. We reserve the right to alter any specifications without notice.

Whilst every effort has been made by the company to ensure that the illustrations and specifications of every product depicted on this website or brochure is correct, the company cannot be held responsible for any damages incurred as a result of inconsistencies within the specifications.

Prices

The prices on our website/brochure are correct at the time of publication, however they may be subject to change without notice.

All prices exclude VAT which the company will add at the rate applicable at the time of despatch. Delivery charges are not included in the product prices but are stated separately.

Ordering

The customer must submit orders using the company's part numbers and the priced units used in the website/brochure and must specify which delivery option is required. The company sale price shall be charged and any error on customer order will only be advised if necessary.

Delivery

The company will aim to deliver the products in accordance with the customer's order. The customer's delivery options, and the prices for them, are set out in the company's website or brochure and will be notified to the customer at the time of placing the order. Delivery will be made to the address specified within the customer's order.

The company will not be liable for the consequences of any delay in delivery, however occasioned, but every effort to achieve them will be made.

If any delivery is late, the customer must notify the company and the company will try to determine if the product has been delivered and/or when it is expected to be delivered. The company will, at its discretion, refund the total delivery charge to the customer or if a revised delivery time is not acceptable offer an alternative delivery option. These are the customer's exclusive remedies for late delivery.

Payment

The Company requires to be paid for order placed on its website at the time of ordering. Payment is only accepted by credit, debit card and paypal.

Trade accounts are available subject to status and a specific conditions of sales

The company reserves the right to decline to trade with any company or person.

Returns and/or Order Cancellation

The company reserves the right to refuse the return of any goods ordered in error. Such errors must be notified to the company within 7 days of receipt of the goods.

No reasonable request to cancel the order will be refused by the company.

The company reserves the right to charge a handling fee of up to 25% of the invoice amount if the goods have already been despatched.

Damage and/or Faulty Products

It is the customer's responsibility to inspect the goods promptly on arrival.

Any defect in the product that is apparent on reasonable examination must be communicated in writing within 4 days of receipt. In this case, the company will, at its discretion, replace the product free of charge and delivery costs or refund the purchase price.

Guarantee

For products purchased from the company, the company guarantees that if a product is defective. It will replace or repair the product or refund the purchase price. This guarantee is subject to the company being notified in writing within 4 months of the original date of despatch.

Any misuse or abuse of the products will invalidate this guarantee.

The company will not be held liable for any charges incurred by the customer in attempting to rectify/repair and/or modify the products without the written permission of the company. These actions will also invalidate the guarantee.

If agreement has been made to return the product to the company, the customer must obtain a returns number from the company which must be quoted on all future paperwork that relates to the product returned. Failure to quote the return number could lead to unnecessary delay.

Title

The company remains the owner of the products supplied to the customer until such time that payment has been made in full.

Force Majeure

A force majeure event is any event beyond the reasonable control of the company (including strikes, traffic congestion, industrial disputes or articles required for the performance of the contract). If the company is prevented or restricted from carrying out all or some of its obligations under these terms and conditions of such by reason of force majeure then the company may elect by written notice to cancel any agreement with the customer or elect that the time for performance shall be extended until such time the company can reasonably effect performance.

Disclaimer

While every effort has been made to ensure all details and information contained within this web site are correct, the company cannot be held responsible for any omissions or errors that may occur.

Rights in the web site

The customer acknowledges that the customer and its licensors own the intellectual property rights in the website/brochure, the website/brochure content and the stock numbers, and that their whole or partial reproduction without the written prior consent of the company is prohibited.

Law and Jurisdiction

The contract between the company and the customer shall be governed by and subject to the interpretation of English Law.