



**HYDRLOGIC**

Advanced Hydronic Control Solutions  
for Geothermal heat pumps



## Table of Contents

---

HydroLogic Control Panels . . . . .	4
HydroLogic Control Panel Features . . . . .	5
HydroLogic Features and Benefits . . . . .	6
Hydronic Applications . . . . .	9
HydroLogic Control Panel Application Examples . . . . .	14
Dimensional Data . . . . .	26
Pump Curves . . . . .	29
Physical and Electrical Data . . . . .	30
System Piping . . . . .	31
Panel Installation . . . . .	34
Heat Pump Control . . . . .	38
Expansion Panel Control - Installation . . . . .	50
Expansion Panel Control - Dimensional Data . . . . .	51
Expansion Panel Control - Wiring . . . . .	52
Expansion Panel Control - User Interface . . . . .	55
Expansion Panel Control - Sequence of Operation . . . . .	55
Control Troubleshooting . . . . .	57
Expansion Panel Control - Troubleshooting . . . . .	61
Service Parts . . . . .	62

# HYDROLOGIC

Advanced Hydronic Control Solutions

The all-new HydroLogic radiant control system is a complete solution for a variety of hydronic applications. With a robust, communicating control system, HydroLogic brings more control to all aspects of the system. Below are just a few of the features and benefits these exciting products bring to customers.

**Complete Package:** Each HydroLogic control panel contains all of the necessary parts to connect the geothermal heat pump to the hydronic system. The control panel is factory assembled and tested before shipping. This means less labor on the jobsite, and peace of mind for system quality. The compact panel, and attractive cover, make for a clean installation in the space.

**Application Flexibility:** There's a HydroLogic control panel for most applications and types of equipment.

- Combination Units: Forced air and hydronic heating control up to 6 tons.
- Water-to-Water Units: Hydronic heating and cooling up to 6 tons.

**Powerful Controls:** The HydroLogic control is a communicating system; therefore it knows exactly what's going on within the space, as well as outdoors. This allows the control to modify tank temperature, and coordinate operation for maximum comfort and efficiency. By using outdoor reset, and indoor feedback, the perfect temperature in the buffer tank is maintained. Another added benefit is forced air heating and cooling control, as well as radiant, all from one thermostat.

**Simple Installation:** Since each HydroLogic panel is assembled, and is a snap to install. Once the panel is mounted on the wall, it just needs to be plumbed and wired into the system. A standard 115V plug powers the panel from a nearby outlet. Thermostats are two-wire, non-polarity sensitive, communicating back to the control. This makes wiring, or retrofitting even easier.

These are just some of the many advantages HydroLogic can bring to your next installation. By choosing, or specifying HydroLogic products, you can be assured that your customer is investing in the ultimate comfort system and peace of mind for many years to come.



## HydroLogic Control Panel Features

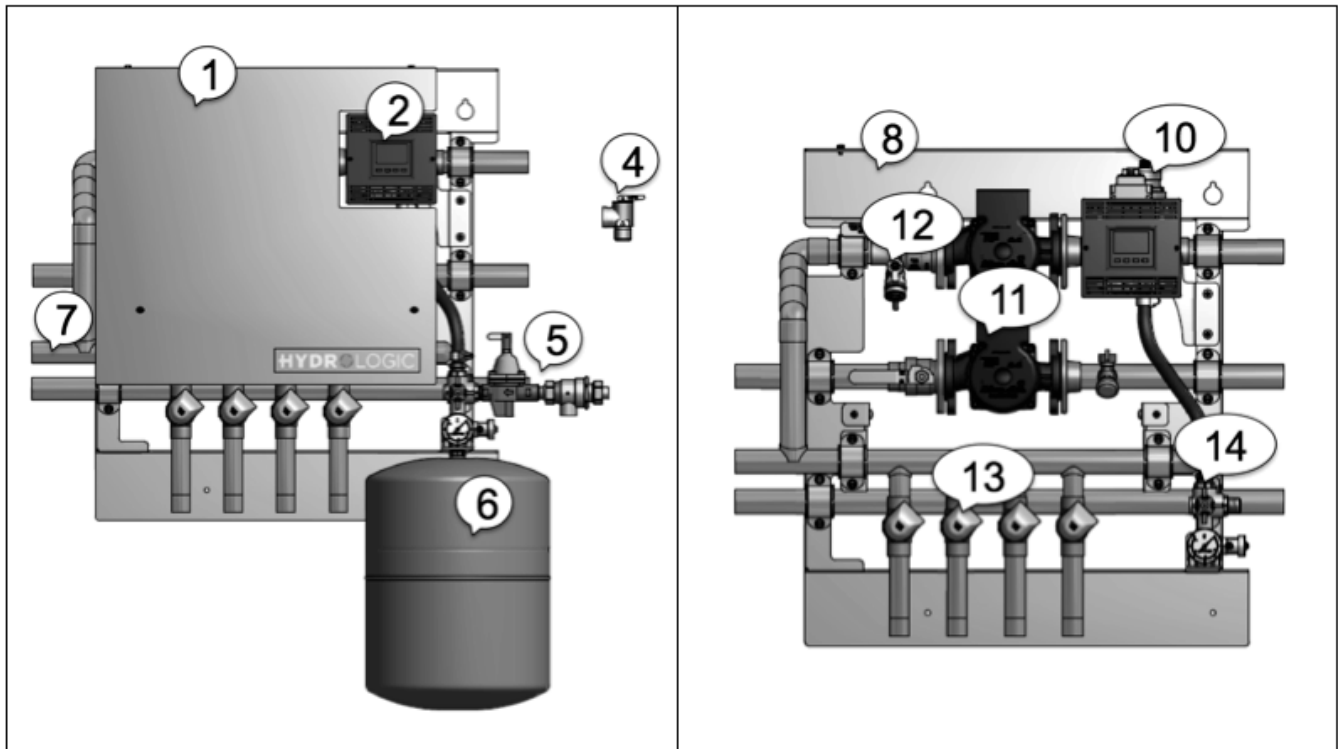



1	<b>Powder-coated steel cover:</b> Sleek finished look	8	<b>Rugged steel frame:</b> Components come pre-mounted and tested
2	<b>Communicating controls:</b> Zone thermostats work together	9	<b>Sensors:</b> Outdoor and water temperature sensors are included (not shown)
3	<b>115V Plug:</b> Simple 3-prong plug for electrical power (not shown)	10	<b>Micro-bubble air separator:</b> Reliable air removal is included
4	<b>Pressure relief valve:</b> 30 psi relief included	11	<b>Water pumps:</b> Built-in Grundfos pumps for circulation of heated or chilled water
5	<b>Automatic fill valve:</b> Controlled pressure fill valve with backflow preventer included	12	<b>Fill and Purge valves:</b> Drain valves with hose thread connections for commissioning
6	<b>Expansion tank:</b> Includes 4.5 gal with 3-Ton models and 6.0 gal tank with 6-Ton models	13	<b>Zone valves:</b> Actuators, valves, and standard 1" copper connections
7	<b>Zone expansion connection:</b> Adding zones is done easily with copper connections	14	<b>Service valve with pressure gauge:</b> Fill water and expansion tank can be isolated for servicing

## Features and Benefits

### Thermostats:

Only Hydrologic thermostats may be used with the Hydrologic system. The thermostats in the system communicate with the control panel to provide intelligent heat-to-cool switchover and synchronized modes of operation. When the system is in heating mode, Hydrologic thermostats make it possible to control hydronic radiant heating as first stage, air heating as second and third stage, and backup heat.

Model #	Features
 <p>TP42H01</p>	Heating/Cooling
 <p>TA42H01</p>	Heating Only
 <p>TP10H01</p>	Heating Only

### Zoned heating

Connections for 4 hydronic heating zones are included with each control panel. Each system can be expanded to a total of 6 or 8 zones with the addition of a zone expansion kit. For large individual zones with more flow demand, up to 4 zone valves can be wired in parallel to respond as one zone, i.e. 8 zone valves can serve as 2 zones for 2 thermostats. Only valve actuators may be parallel wired, and not Hydrologic thermostat wires.

### Air groups

Multiple hydronic heating zone thermostats can be assigned to a single air group when those zones are serviced by one air handler for cooling. Temperature readings from multiple thermostats can be averaged for air handler operation when they are members of an air group. Each air group requires one master heat/cool thermostat which includes the air handler controls. Multiple stages of heating and cooling, as well as humidification or dehumidification are controlled by the air group

master thermostat.

### Outdoor reset with indoor feedback

The heating supply water temperature in a Hydrologic system is not only influenced by outdoor temperature, but is also influenced by the indoor temperature response. The temperature is automatically adjusted warmer when more heat is needed to satisfy the heating load. It is also automatically lowered if less heat is needed, which maximizes system efficiency.

### Hydronic zone synchronization

Zone cycles are coordinated to begin together, and turn off independently as the zone demands are satisfied. This type of zone control results in stable temperature response and efficient cycling of equipment.

### Hydronic heat/cool source control

Each control panel has the ability to control two stages of hydronic heating and cooling heat pump sources. If two heat pumps are used, equal runtime rotation can be configured. Additionally there is on/off control for a backup hydronic heating source.

## Features and Benefits cont.

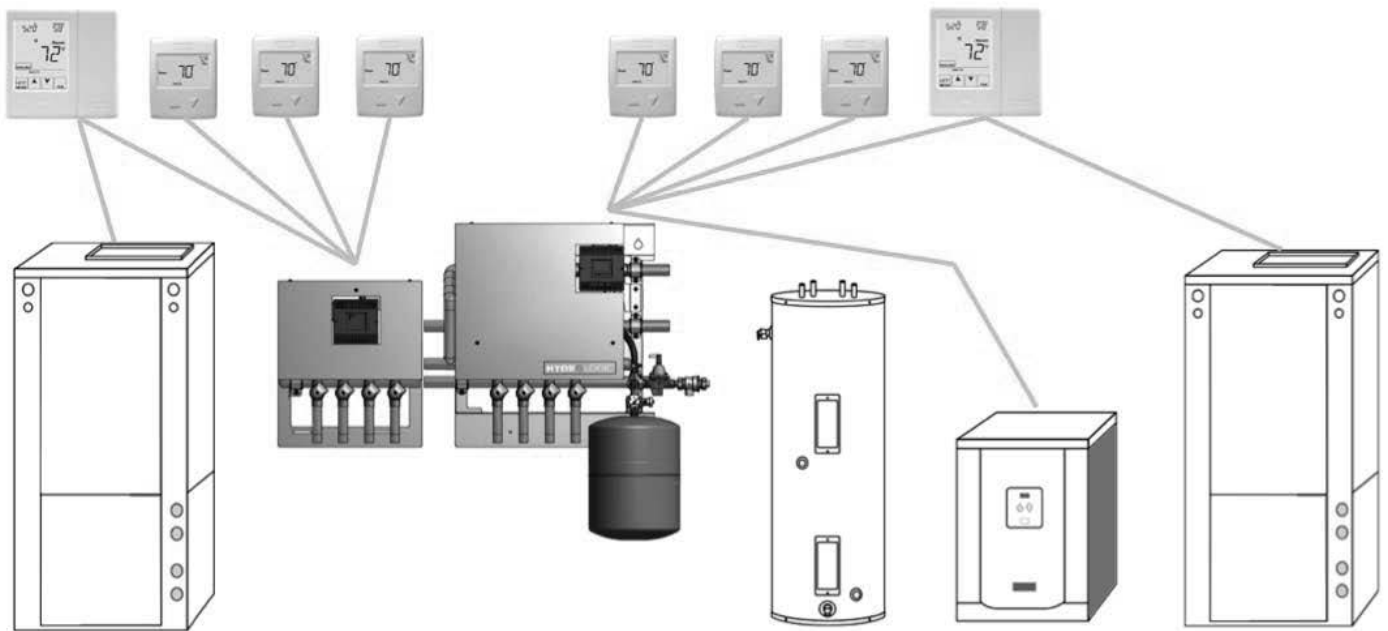

## Features and Benefits cont.

Hydrologic is easy to select for water-to-water or combination heat pump based systems. The water-to-water control panel includes two water pumps; one for distribution out to zones, and a second to move water through the load side of the heat pump. The combination system model only includes one water pump for distributing to zones, and assumes the load side circulator is integrated elsewhere in the system. The Hydrologic system is intended for residential and light commercial space conditioning, and supported applications are described in the HydroLogic Control Panel Application Examples section. The control panels and zone expansions are designed for non-potable closed-loop hydronic heating and cooling only.

The control panels are available in two sizes, as shown in the Model Nomenclature and Specification section. If hydronic terminal units other than radiant floor are used, such as fan coils and panel radiators, the pump curves shown in the zoning flow output graphs can be used to determine flow capability compared to required system flow. The stated maximum total radiant floor coverage, up to 2,000 or 5,000 square feet, is reduced when other terminal units are also used for heating simultaneously. The flow requirements of all terminal units added together should be selected to fit within the pump performance curve. Radiant floor flow requirements and loop tubing design are described in the Hydronic Application section.

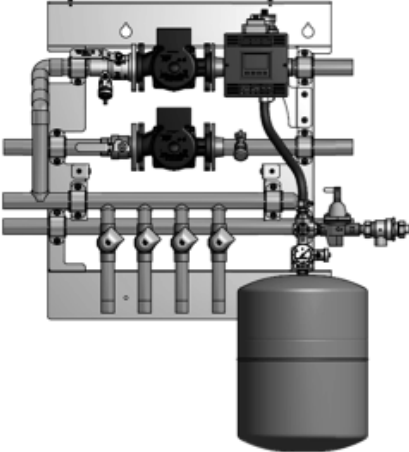
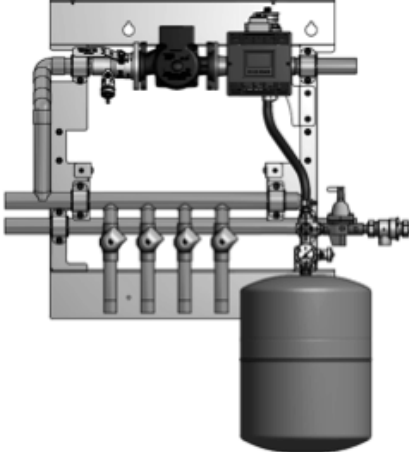
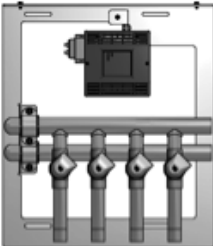
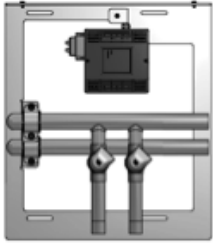
<p style="text-align: center;"><b>Water-to-Water System Control Panel</b></p>  <p>shown without cover</p>	<p style="text-align: center;"><b>Combination System Control Panel</b></p>  <p>shown without cover</p>
<p style="text-align: center;"><b>4 Zone Expansion</b></p>  <p>shown without cover</p>	<p style="text-align: center;"><b>2 Zone Expansion</b></p>  <p>shown without cover</p>



## Hydronic Applications

Heating with hot water is versatile because there are many ways of distributing the heat through the building. The options range from heavy cast iron radiators seen in older buildings to modern, baseboard-style convection radiation, and from invisible radiant floor heating to forced air systems using fan coil units.

In space heating, a major consideration for hydronic heat pump based systems is the maximum water temperature which the system is required to produce in order to satisfy heating load. Both the capacity and efficiency of the heat pump decrease as the required output temperature increases. Because of this, larger emitters and lower water temperatures are generally used for heating in heat pump systems compared to boiler systems. The Hydrologic controls limit design water temperature to 120°F for use with heat pumps with an outlet limit of 130°F, and design limit 140°F for outlet limit 150°F. Figure 1 illustrates the effect of source and load temperatures on the system. The heating capacity of the heat pump also decreases as the temperature difference increases.

### Source Water to Load Water

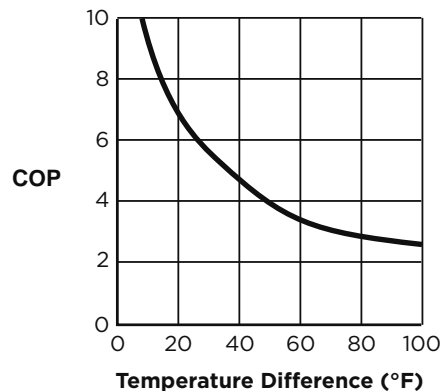

**Figure 1:** As the  $\Delta T$  increases, the Coefficient of Performance (COP) decreases. When the system produces 130°F water from a 30°F earth loop, the  $\Delta T$  is 100°F, and the COP is approximately 2.5. If the system is producing water at 90°F, the  $\Delta T$  is 60°F and the COP rises to about 3.8, an increase of over 50%.

When using the various types of hydronic heat distribution systems, the temperature limits of the geothermal system must be considered. In new construction, the distribution system can easily be designed with the temperature limits in mind. In retrofits, care must be taken to address the operating temperature limits of the existing distribution system.

**By Elevation:** The elevation changes between floors within a structure usually cause air temperature differences. Different floors should be zoned for independent temperature control.

**By Use of Space:** People prefer separate zone temperature control in living areas, bedrooms, and bathrooms. This can be due to the way the rooms are used, types of clothing worn, and presence of devices that may create extra heat.

**By Fenestration:** The amount and area of windows and doors have a large influence on heating and cooling loads. Rooms with different amounts of fenestration may need to be separate zones.

**By Floor Covering (radiant):** Higher floor covering R-value requires longer heating cycles or higher water temperature. Spaces with radiant floor heating and different floor coverings may need independent controls.

## Baseboard Radiation

In existing systems, baseboard radiation is typically designed to operate with 160° to 240°F water or steam. Baseboard units are typically copper pipe with aluminum fins along the length of the pipe, as shown in Figure 2. A decorative cover is normally fitted over the fin tube.

The operation of a baseboard radiation system depends on setting up a convection current in the room: air is warmed by the fin tube, rises and is displaced by cool air.

The heating capacity of a baseboard system is a factor of the area of copper tube and fins exposed to the air and the temperature difference between the air and the fin tube. The velocity and volume of water flowing through the baseboard affects the temperature of the copper and fins. Baseboard units are normally rated in heat output/length of baseboard at a standard water temperature and flow. Manufacturers can provide charts which will give the capacities at temperatures and flows below the standard. Figure 3 shows approximate heating capacities for fin tube radiation using water from 110° to 150°F water.

Baseboards are available using two or three fin tubes tiered above one another in the same cabinet. With the additional surface area, the air can be heated enough to set up a convection current with water temperatures as low as 110° to 150°F (see Figure 3).

It is important to ensure that the heat output of the system is adequate to meet the heat loss of the room or building at the temperatures the geothermal system is capable of producing.

Baseboard radiation is limited to space heating. Cooling is typically provided by a separate, forced air distribution system.

**Figure 2:** Baseboard radiators are typically constructed of copper tube with closely spaced aluminum fins attached to provide more surface area to dissipate heat. Some of the factors affecting the amount of heat given off by fin tube radiators are the water temperature, water velocity, air temperature, and fin spacing and size.

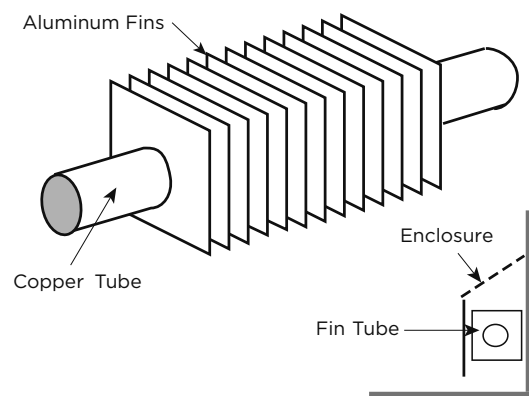

## Hydronic Applications, cont.

The heating capacity (Btu/linear foot) of baseboard radiators drop as the water temperature is reduced. The heating capacity of most baseboard radiators is rated using 200°F water, 65°F air temperature. Listed in Figure 3 is the range of heating capacities of baseboard radiators at the standard temperatures and the range of capacities when the temperatures are reduced to the operating range of a heat pump system. Some of the factors that effect the capacity of a radiator are:

- Size of the fins - range from 2.75 in. x 3 in. to 4 in. x 4 in.
- Fin spacing - 24 to 48 foot
- Diameter of copper tube - range from .75 in. to 2 in.
- Fin material - aluminum or steel
- Configuration and height of the enclosure
- Height unit is mounted from the floor
- Water flow through the radiator

Generally, the smaller fins with fewer fins/foot will have lower heating capacity. Larger copper tube diameter and aluminum fins will have a higher capacity. Higher water flow will increase capacity. Adding a second fin tube to the same enclosure will increase the capacity by 50 to 60%. Adding two fin tubes will increase the capacity by 75 to 80%.

Figure 3: Heating output per linear foot

Average Water Temp.	Entering Air Temperatures		
	55°F	65°F	70°F
110°F	190-380	<b>160-320</b>	150-300
120°F	240-480	<b>205-410</b>	195-390
130°F	295-590	<b>265-532</b>	245-490
140°F	355-710	<b>335-650</b>	300-600
150°F	420-830	<b>415-780</b>	360-720

### Cast Iron Radiation

Retrofit applications for hydronic/geothermal heat pump systems are often required to work with existing cast iron radiators or their replacements (see Figure 4). Typically, cast iron radiator systems operate with water temperatures of 125° to 160°F.

There are some geothermal water-to-water heat pumps are specifically designed to meet these higher temperatures. Cast iron radiators can work with geothermal systems, provided the heat output of the radiators will meet the maximum heat loss of the building at the lower temperatures.

If the insulation of the building has been upgraded since the original installation, it is possible that the lower temperatures will be able to meet the reduced heat loss of the building.

Figure 4: Baseboard System

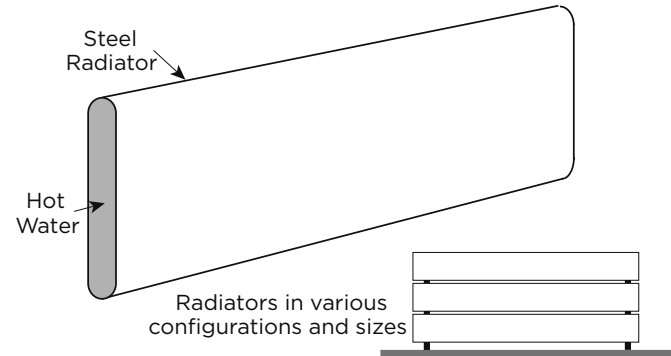

### Radiant Floor Heating

Radiant floor heating has been the system of choice in many parts of Europe for some time. Manufacturers have developed tubing designed for installation in concrete floors and raised wood floors.

Floor heating systems have several benefits in residential, commercial and industrial heating applications. In a building with a radiant floor heating system, the entire floor acts as a heat source for the room. People feel comfortable with lower air temperatures if their feet are warm. Typically the space will feel comfortable with air temperatures as low as 65°F. Since the heat loss of a building is directly related to the temperature difference ( $\Delta T$ ) between the inside and outside, a lower  $\Delta T$  means the heat loss is lower.

Air temperatures in a room with a forced air heating system tend to be warmer nearer to the ceiling than the floor (see Figure 5). The hot air rises and creates a greater pressure imbalance between the inside and outside. The infiltration increases, resulting in a higher heat loss. Air temperatures in a room with radiant floor heating tend to be warmer at the floor than the ceiling, helping to cut down on infiltration in the building. The energy savings in a building with radiant floor heating can range from 10 to 20%.

Figure 5: Temperature Comparison

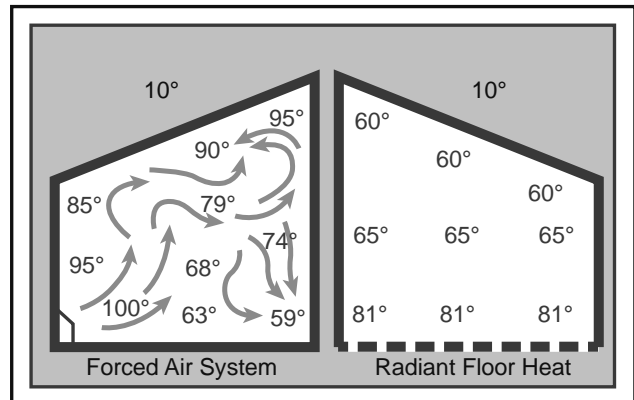

## Hydronic Applications, cont.

A floor heat system can be designed to heat a building with water temperatures as low as 90°F.

Figure 1 shows how a geothermal system operates more efficiently with a lower  $\Delta T$  between the source and the load. With only a 60°F temperature difference, a geothermal heat pump will operate at approximately 4 COP, about 20% higher than a forced air geothermal system in the same installation.

Some of the factors affecting the heating capacity of a floor heating system are as follows:

- The type of finish flooring
- The spacing of the pipe
- The water flow through the pipe
- The temperature of the supply water
- The floor material (wood, concrete or poured Gypcrete™)
- Insulation value under the floor
- The piping layout

For residential and light commercial radiant floor heating, the recommended loop designs use 1/2" tubing with 300-350 feet loop lengths or 3/8" tubing with 200-250 feet loop lengths. The typical tubing spacing range is from 8" to 12" on center for these applications. Radiant flooring heating circuits, when designed within these recommended guidelines, should typically operate at 0.3 gpm per 100 square feet and at a pressure differential of 12 to 16 feet of head. These flow rates ensure good heat transfer from the tubing for comfortable floors, as well as air bubble removal. This also results in varying  $\Delta T$  depending on load. In typical heating output design, high load is 30 Btu/(hr ft<sup>2</sup>) at 20°F  $\Delta T$ , medium load is 20 Btu/(hr ft<sup>2</sup>) at 13°F  $\Delta T$ , and low load is 10 Btu/(hr ft<sup>2</sup>) at 7°F  $\Delta T$ . Locating each zone manifold near the zone it services will maximize use of loop piping in floors. Typically 3/4" or 1" piping will be used to connect a zone valve from a Hydrologic control panel to a radiant zone manifold. Check flow requirements for pipe size in the System Piping section. Up to 4 zone valves can be wired in parallel to serve as 1 zone, i.e. 1 thermostat can control 4 valves, each connected to a different manifold, as 1 zone. Only valve actuators may be parallel wired, and not Hydrologic thermostat wires.

The 3 ton Hydrologic control panel can pump 100 to 1,000 square feet of radiant floor per zone valve in a system of total size up to 2,000 square feet. The 6 ton control panel can pump 200 to 2,000 square feet per zone valve in a system of total size up to 5,000 square feet. Radiant floor heating systems work well with geothermal heat pump systems. For efficient operation, the system must be designed with the lowest possible water temperatures.

There are some drawbacks with a radiant floor heating system. Air conditioning is only possible by adding a second system using forced air. This can add substantial cost to an installation where air conditioning is also needed. A separate air handling system is needed to clean the air or to introduce fresh air.







Industrial buildings, especially those with high ceilings and large overhead doors, have an advantage with a radiant floor heating system. Heat is stored in the concrete floor, and when a door is opened, the stored heat is immediately released to the space. The larger the  $\Delta T$  between the air in the space and the floor, the quicker the floor releases its heat to the space.

Maintenance garages benefit from radiant floor heating systems. Cold vehicles brought into the garage are warmed from underneath. The snow melts off the vehicle and dries much more quickly than when heated from above.

Some pipe manufacturers include an oxygen diffusion barrier in the pipe to prevent oxygen diffusion through the pipe. Good system design and careful installation and water treatment will eliminate virtually all of the problems encountered with air in the system. Like earth loop design, it is important to design the system to facilitate flushing the air initially and ensuring that the flows can be balanced properly.

## Hydronic Applications, cont.

The example design supply water temperature table below can be used for informational purposes when selecting a radiant floor construction method and choosing floor coverings. The building load should be calculated by a professional and based on the building envelope and climate. The water temperature values shown are based on the typical ranges of construction methods, R-10 insulation below the floor construction where indicated, and 10°F outdoor temperature. It is best to design the building envelope, select a radiant floor type, and choose a floor covering such that the required design supply water temperature is less than 120°F. This ensures efficient operation of the heat pump, as well as reduces the chances that backup heat will be used.

Example Design Supply Water Temperature for Radiant Floor							
		<b>Heating output:</b> High Load, 30 Btu/(hr ft <sup>2</sup> ), Supply – Return Water 20°F ΔT Medium Load, 20 Btu/(hr ft <sup>2</sup> ), Supply – Return Water 13°F ΔT Low Load, 10 Btu/(hr ft <sup>2</sup> ), Supply – Return Water 7°F ΔT					
	4" concrete slab on grade, tubing 3" below surface Insulated below slab 1/2" tubing, 9" spacing 300' - 350' tubing loop lengths	<b>Floor Covering</b>			<b>Supply Water Temperature (F)</b>		
					High Ld.	Med. Ld.	Low Ld.
		None	R-	0.0	110	96	82
		Engineered Wood	R-	0.7	131	110	89
Carpet and Pad	R-	2.0	n/a	136	102		
	4" concrete slab on grade, tubing 3" below surface Insulated below slab 1/2" tubing, 12" spacing 300' - 350' tubing loop lengths	<b>Floor Covering</b>			<b>Supply Water Temperature (F)</b>		
					High Ld.	Med. Ld.	Low Ld.
		None	R-	0.0	113	98	83
		Engineered Wood	R-	0.7	134	112	90
Carpet and Pad	R-	2.0	n/a	138	103		
	Wooden track system above concrete slab on grade Un-insulated 3/8" tubing, 8" spacing 200' - 250' tubing loop lengths	<b>Floor Covering</b>			<b>Supply Water Temperature (F)</b>		
					High Ld.	Med. Ld.	Low Ld.
		Tile, Thinset, Backer	R-	0.25	131	110	89
		Hardwood	R-	0.7	n/a	119	94
Carpet and Pad	R-	2.0	n/a	n/a	107		
	Wooden track system above wooden frame floor Insulated below subfloor 3/8" tubing, 8" spacing 200' - 250' tubing loop lengths	<b>Floor Covering</b>			<b>Supply Water Temperature (F)</b>		
					High Ld.	Med. Ld.	Low Ld.
		Tile, Thinset, Backer	R-	0.25	125	106	87
		Hardwood	R-	0.7	139	115	92
Carpet and Pad	R-	2.0	n/a	n/a	105		
	1-1/2" poured gypsum above frame floor, tubing 1" below surface Insulated below subfloor 1/2" tubing, 9" spacing 300' - 350' tubing loop lengths	<b>Floor Covering</b>			<b>Supply Water Temperature (F)</b>		
					High Ld.	Med. Ld.	Low Ld.
		Tile and Thinset	R-	0.12	115	99	84
		Engineered Wood	R-	0.7	133	111	90
Carpet and Pad	R-	2.0	n/a	137	103		
	Tubing attached below wooden frame floor, conductive plates Insulated below tubing system 1/2" tubing, 8" spacing 300' - 350' tubing loop lengths	<b>Floor Covering</b>			<b>Supply Water Temperature (F)</b>		
					High Ld.	Med. Ld.	Low Ld.
		Tile, Thinset, Backer	R-	0.25	n/a	119	94
		Engineered Wood	R-	0.7	n/a	128	98
Carpet and Pad	R-	2.0	n/a	n/a	111		

NOTE: Light grey shading indicates temperatures can only be achieved using OptiHeat units.

## Hydronic Applications, cont.

### Fan Coil Units and Air Handlers

Fan coil units, air handlers, force flow units, etc. are all basically a hot water radiator or coil (usually copper piping with aluminum fins) with a fan or blower to move the air over the coil (see Figure 6). The term “fan coil units” typically applies to smaller units that are installed in the zone or area in which heating (or cooling) is needed. They are available in many different configurations, sizes and capacities. Fan coil units are designed to be connected to a ductwork system and can be used to replace a forced air furnace. Other units are designed for use without ductwork and are mounted in a suspended ceiling space with only a grille showing in place of a ceiling tile. Some can be mounted on a wall under a window, projecting 8 in. to 10 in. into the room or even flush to the wall surface, mounted between wall studs. Some are available with or without finished, decorative cabinets. For industrial applications, inexpensive “unit heaters” are available, with only a coil and an axial fan. Fan coil units and unit heaters are normally available with air handling capacities of 200 to 2,000 cfm.

The term “air handler” normally applies to larger units, mounted in mechanical rooms, mechanical crawl spaces or rooftops. They typically have an air handling capacity of over 2,000 cfm and are available for capacities of up to 50,000 cfm. Air handlers are typically built for a specific installation and are available with many different types of heating and cooling coils. They can include additional coils for heating make-up air, dehumidification and exhaust air heat recovery.

Fan coils and air handlers typically have one or two coils and a blower. Air is heated by hot water circulated through the hot water coil. Chilled water is circulated through the coil if air conditioning is needed. Blowers can be provided to fit various applications, with or without duct-work. Unit heaters typically use axial fans in applications where ductwork is not needed.

Fan coil units and air handlers are used in many different applications. They have been used to heat buildings using water temperatures as low as 90° to 100°F. New systems can be designed to operate very efficiently with a geothermal system.

**Figure 6:** Fan Coils

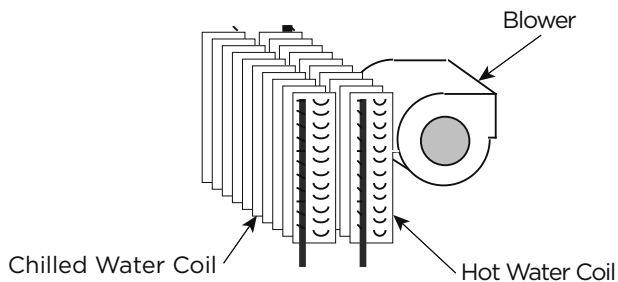

### Cooling with a Hydronic System

The Hydronic Control panel does not support radiant cooling. It only supports chilled water fan coil cooling. Cooling a building with an existing radiant hydronic heating system can be a challenge. If baseboard, cast iron radiators or a radiant floor heating system is cooled lower than the dew point, condensation will form on the floor or drip off the radiators.

There is generally minimal or no ductwork for ventilation in existing buildings with radiant hydronic heat. Typically, cooling is provided with separate units where it is needed. This is often done using through-the-wall or window air conditioners, ductless split air conditioning units, or rooftop units.

A water-to-water heat pump system can provide water to ducted or unducted fan coil units. The system can provide chilled water to cool the building, as well as hot water for the heating system when needed.

A limited amount of cooling can be done by circulating chilled water through the piping in the floor. This can be effective in buildings with high solar loads or lighting loads, where much of the heat gain is radiant heat being absorbed by the floor. Cooling fresh air used for ventilation as it is brought into the building, using a chilled water coil, can sometimes provide the additional cooling needed. Care must be taken to avoid cooling the floor below the dew point because condensation may form on the floor.

Buildings with fan coil units and air handlers can generally be easily retrofitted for cooling. Often it is simply a matter of adding a cooling coil to the existing air handlers and fan coil units. Water-to-water heat pumps can provide hot water for the heating coils as well as chilled water for the air conditioning.

## Application Example 1:

### Single Forced Air Heating/Cooling Unit, and Single Water to-Water Unit for Radiant Floor Heating with Back-up Boiler

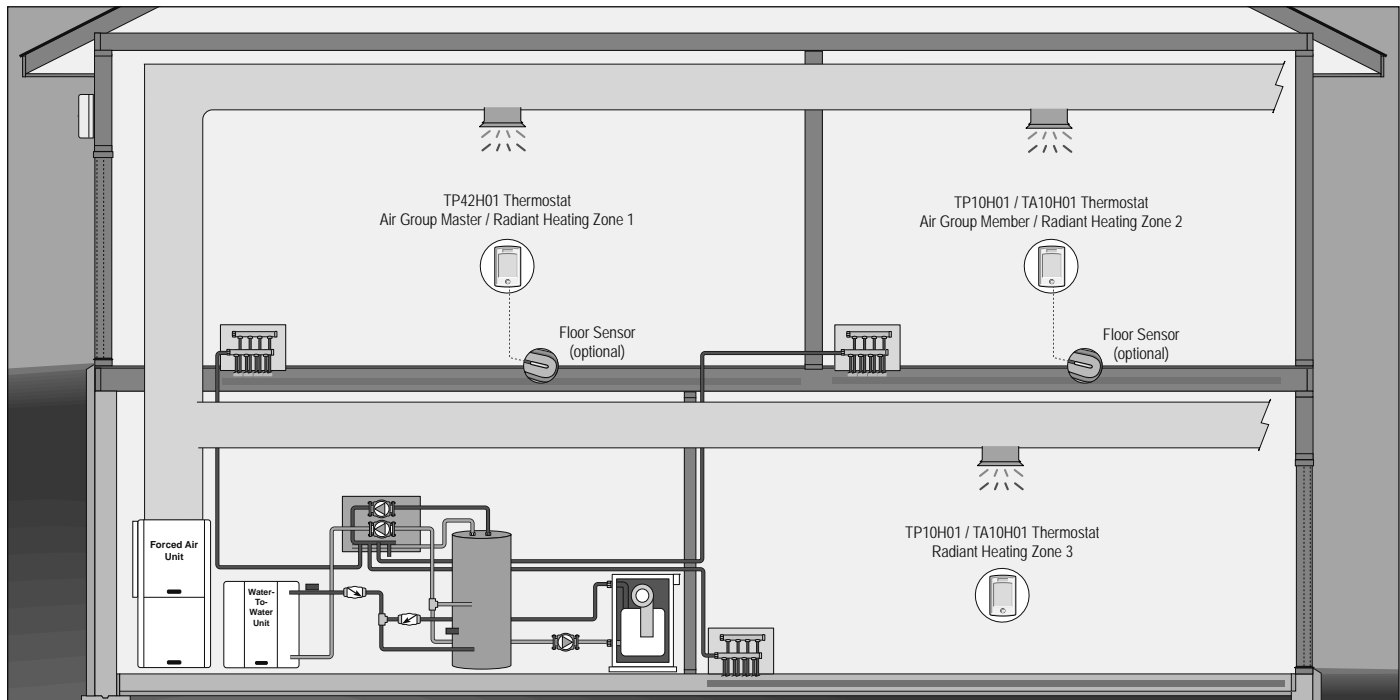

#### Application Description

- 1 x water-to-water heat pump, with backup boiler, provides hydronic radiant floor heating for 3 radiant floor zones.
- 1 x water-to-air heat pump provides air heating and air cooling for into all of the hydronic radiant heating floor zones. The air heating serves primarily as supplemental heat for the hydronic radiant floor heating. Zone 1 is the controlling thermostat and is configured as Air Group Master #1 while zone 2 is configured as an Air Group Member #1. Zone 3 is not configured as an Air Group Member so its temperature is not considered in the average calculated by the Air Group Master.

#### Sequence of Operation

##### Hydronic heating

- Provided the Heat Pump control is not in WWSD (Warm Weather Shutdown) and any hydronic zone requires heat, the Heat Pump control will call on the water-to-water heat pump for hydronic heating.
- If the water-to-water heat pump cannot satisfy the load requirements or the water-to-water heat pump is disabled due to a supply temperature limit, the boiler is turned on to provide supplemental hydronic heat.
- The hydronic heating target is based on outdoor reset with indoor temperature feedback per zone.
- The hydronic floor heating zones operate using an Automatic Heating Cycle (number of cycles per hour).
- Zones with floor sensors (and built-in air sensors) will operate to maintain their respective floor minimum during mild outdoor temperature. As the outdoor temperature drops, more heat will be put into the floor (limited to the floor maximum) to satisfy the air temperature setpoint.
- Zone post purge operates load pump and single zone after the heat pump is turned off.

##### Air heating

- Air heating usually supplements the hydronic heating with stage 2 and, if applicable stage 3, turning on in sequence as needed to satisfy the load. Electric strip heat, if applicable, would operate as a supplement to the water-to-air heat pump stages.
- Provided zone 1 (Air Group Master #1) is not in WWSD and there is a requirement for supplemental air heating, the water-to-air heat pump stages are operated. If the Zone 1 Mode is set to Auto, an interlock time is applied to the Heat-Cool switchover in Zone 1.
- Since zone 2 is an Air Group Member, it contributes its air temperature to the Air Group Master. The Air Group Master then displays and operates based on the average air temperature of the air group zones.

##### Air cooling

- Provided zone 1 is not in CWSD (Cold Weather Shutdown) and there is a requirement for cooling, the water-to-air heat pump is operated to maintain the setpoint air temperature. If Mode is set to Auto, an interlock time is applied to the Heat-Cool switchover.
- Since zone 2 is an Air Group Member, it contributes its air temperature to the Air Group Master. The Air Group Master then displays and operates based on the average air temperature of the air group zones.

##### Hydronic / Air integration

- Hydronic heating is disabled in zone 2 (Air Group Member) if zone 1 (Air Group Master) is operating in a cooling state.
- Network sharing of outdoor temperature, real time, schedules, and global Away mode is available.

# Application Example 1: cont.

Single Forced Air Heating/Cooling Unit, and Single Water to-Water Unit for Radiant Floor Heating with Back-up Boiler

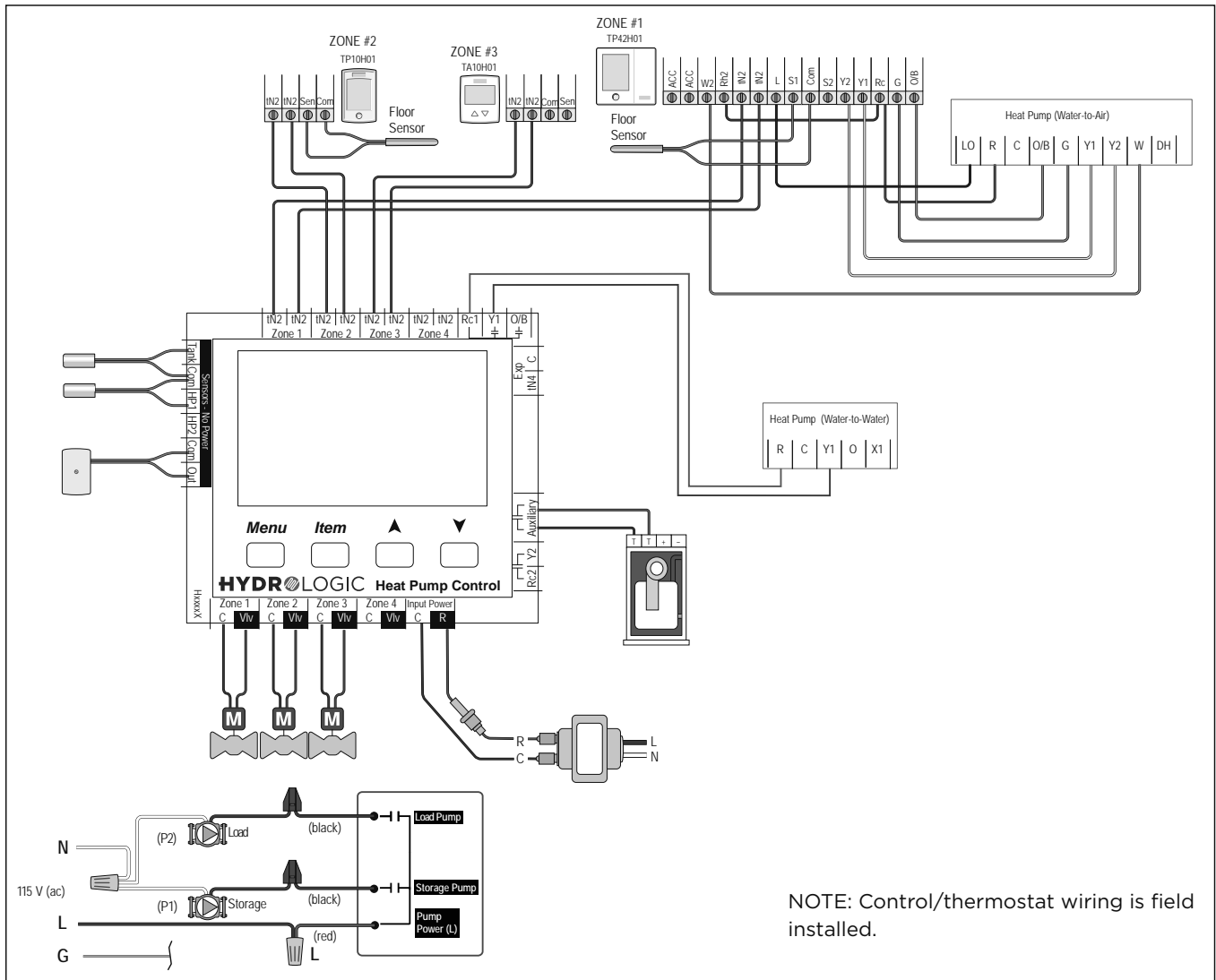

Key Settings			
	ZONE 1	ZONE 2	ZONE 3
<b>Control Panel</b>	<b>TP42H01*</b>	<b>TP10H01/ TA10H01*</b>	<b>TP10H01/ TA10H01*</b>
WWSD (40° F to 100° F)	W1 RELAY = ON	AIR GROUP MEMBER = 1	AIR GROUP MEMBER = NONE
BALANCE PT (OFF, -10° F to 60° F)	Y1 RELAY = HP1		
	W2 RELAY (ON, OFF)		
	COOLING CWSD (OFF, 35° F to 75° F)		
	BALANCE POINT (OFF, 10° F TO 70° F)		
	W1 HEAT WWSD (OFF, 32° F TO 80° F)		
	AIR GROUP MASTER = 1		

\*Reference thermostat manuals for specific thermostat settings.

## Application Example 2:

### Multiple Forced Air Heating/Cooling Units and Multiple Water-to-Water Units for Radiant Floor Heating

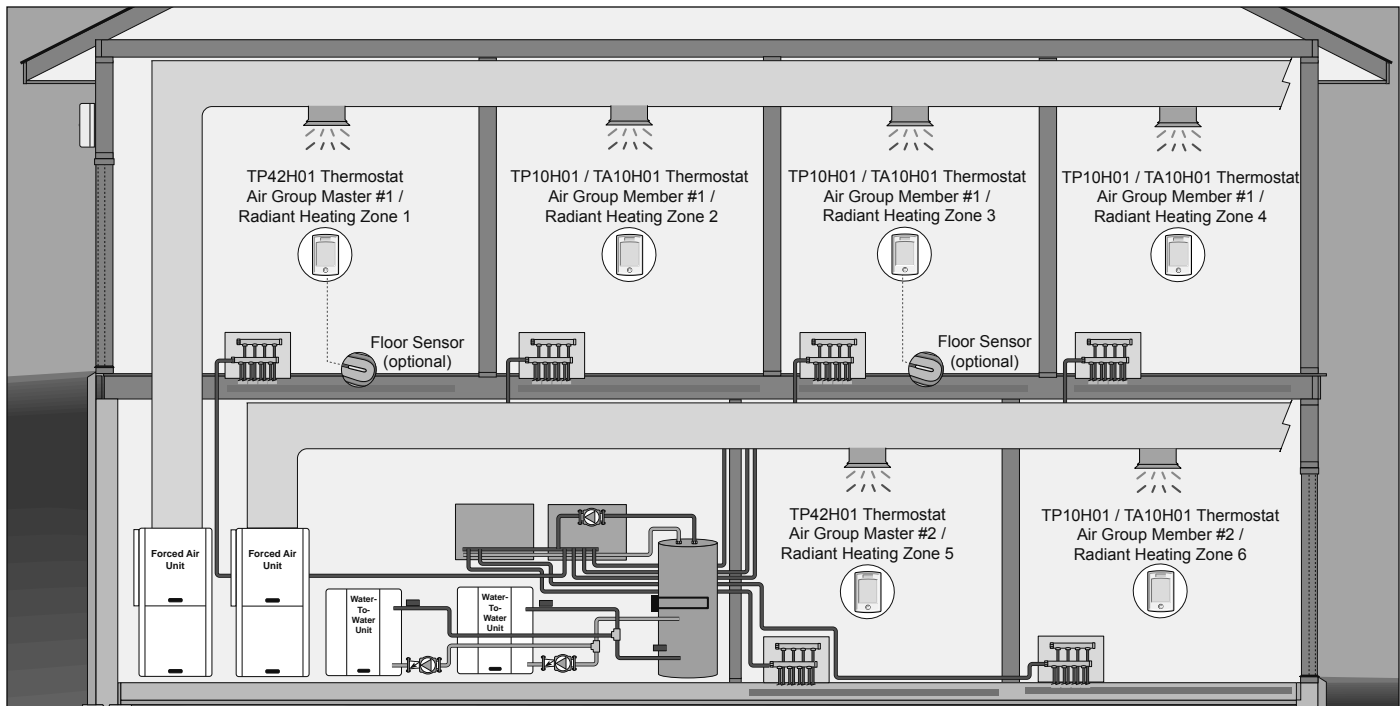

#### Application Description

- 2 x water-to-water heat pumps, with backup electric element, provide hydronic heating for 6 radiant floor zones.
- 2 x water-to-air heat pump, one servicing upstairs and the other downstairs, provide air heating and air cooling into their respective hydronic radiant floor heating zones. The air heating serves primarily as supplemental heat for the hydronic radiant floor heating. Zone 1 is the controlling thermostat for the upstairs and is configured as Air Group Master #1 while zones 2, 3 and 4 are configured as Air Group Members #1. Zone 5 is the controlling thermostat for the downstairs and is configured as Air Group Master #2 while zone 6 is configured as Air Group Member #2.

#### Sequence of Operation

##### Hydronic heating

- Provided the Heat Pump control is not in WWSD (Warm Weather Shut-Down) and any hydronic zone requires heat, the Heat Pump control will stage on the water-to-water heat pumps for hydronic heating. Equal run time rotation is available for the water-to-water heat pumps.
- If the water-to-water heat pumps cannot satisfy the load requirements or the water-to-water heat pump(s) are disabled due to a supply temperature limit, the electric element is turned on to provide supplemental hydronic heat.
- The hydronic heating target is based on outdoor reset with indoor temperature feedback per zone.
- The hydronic floor heating zones operate using an Automatic Heating Cycle (number of cycles per hour).
- For the Air Group master thermostats, Zone 1 and Zone 5, a local WWSD can be set up that is independent from WWSD setting on the heat pump control. This would allow, during mild weather, for the radiant floor to be turned off and the air heating to operate as the primary source.
- Zones with floor sensors (and built-in air sensors) will operate

to maintain their respective floor minimum during mild outdoor temperature. As the outdoor temperature drops, more heat will be put into the floor (limited to the floor maximum) to satisfy their respective air temperature setpoint.

- Zone post purge operates load pump and single zone after heat pump is turned off.

##### Air heating

- Air heating usually supplements the hydronic heating with stage 2 and, if applicable stage 3, turning on in sequence as needed to satisfy the load. Electric strip heat, if applicable, would operate as a supplement to the water-to-air heat pump stages.
- Provided zone 1 (Air Group Master #1) is not in WWSD and there is a requirement for supplemental air heating, the upstairs water-to-air heat pump stages are operated. If the Zone 1 Mode is set to Auto, an interlock time is applied to the Heat-Cool switchover in Zone 1.
- Provided zone 5 (Air Group Master #2) is not in WWSD and there is a requirement for supplemental air heating, the downstairs water-to-air heat pump stages are operated. If the Zone 5 Mode is set to Auto, an interlock time is applied to the Heat-Cool switchover in Zone 5.

##### Air cooling

- Provided the Zone 1 (Air Group Master #1) thermostat is not in CWSD (Cold Water Shutdown) and there is a requirement for cooling, the upstairs water-to-air heat pump is operated to maintain the cooling setpoint air temperature in Zone 1. If the Zone 1 Mode is set to Auto, an interlock time is applied to the Heat-Cool switchover.
- Provided the Zone 5 (Air Group Master #2) thermostat is not in CWSD and there is a requirement for cooling, the downstairs water-to-air heat pump is operated to maintain the cooling setpoint air temperature in Zone 5. If the Zone 5 Mode is set to Auto, an interlock time is applied to the Heat-Cool switchover.



# Application Example 2: cont.

## Multiple Forced Air Heating/Cooling Units and Multiple Water-to-Water Units for Radiant Floor Heating

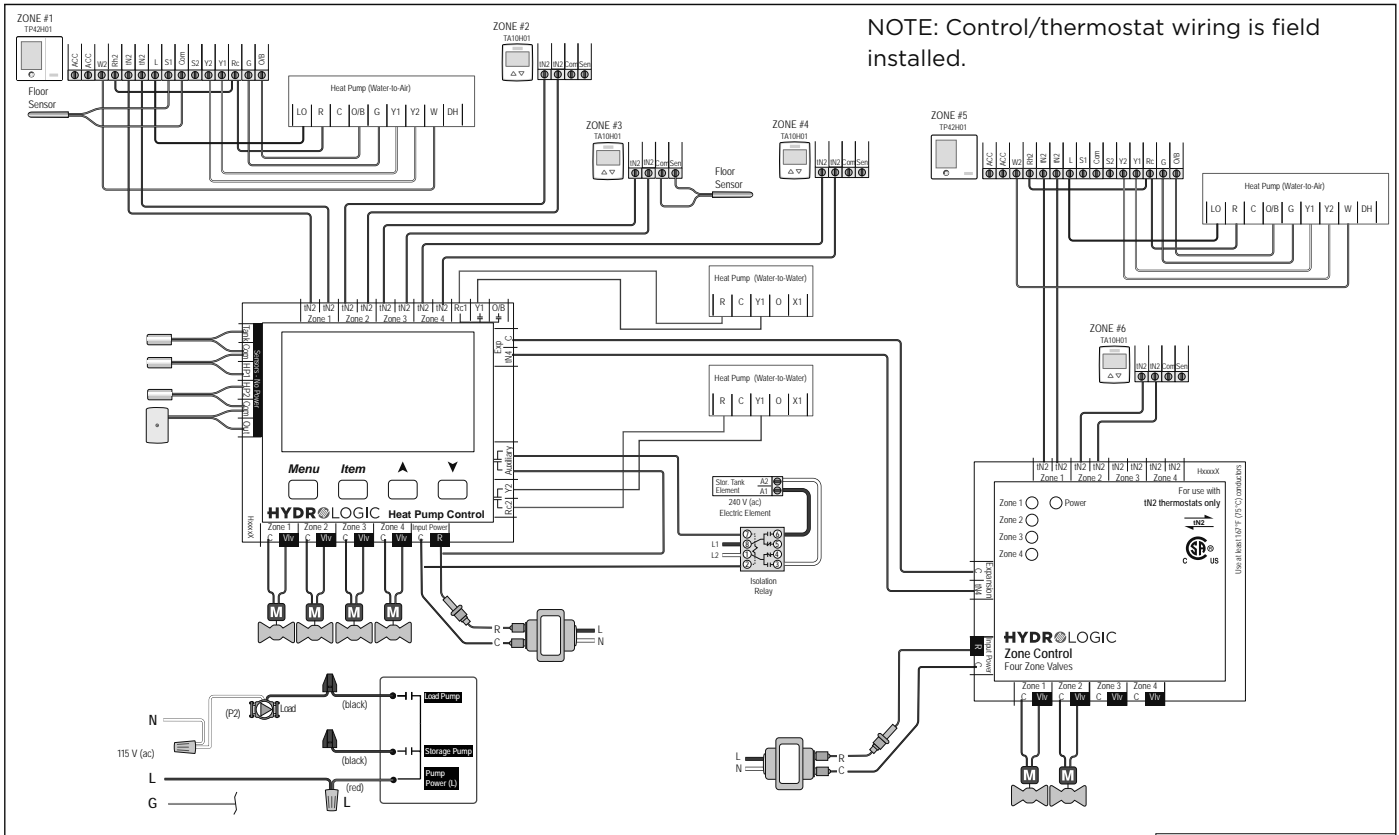

### Hydronic / Air integration

- Hydronic heating is disabled in the Air Group #1 zones if Zone 1 (Air Group Master #1) is operating in a cooling state.
- Hydronic heating is disabled in the Air Group #2 zones if Zone 5 (Air Group Master #2) is operating in a cooling state.
- Network sharing of outdoor temperature, real time, schedules, and global Away mode is available.

Key Settings				
	ZONE 1	ZONES 2, 3, 4	ZONE 5	ZONE 6
<b>Control Panel</b>	<b>TP42H01*</b>	<b>TP10H01/ TA10H01*</b>	<b>TP42H01*</b>	<b>TP10H01/ TA10H01*</b>
WWSD (40°F to 100°F)	W1 RELAY = ON	AIR GROUP MEMBER = 1	W1 RELAY = ON	AIR GROUP MEMBER = 2
BALANCE PT (OFF, -10°F to 60°F)	Y1 RELAY = HP1		Y1 RELAY = HP1	
	W2 RELAY (ON, OFF)			
	COOLING CWSD (OFF, 35°F to 75°F)		COOLING CWSD (OFF, 35°F to 75°F)	
	BALANCE POINT (OFF, 10°F to 70°F)		BALANCE POINT (OFF, 10°F to 70°F)	
	AIR GROUP MASTER = 1		AIR GROUP MASTER = 2	

\*Reference thermostat manuals for specific thermostat settings.

## Application Example 3:

### Single Water-to-Water Unit with Radiant Heat Flooring and Forced Air Heating/Cooling via Hydronic Air Handler

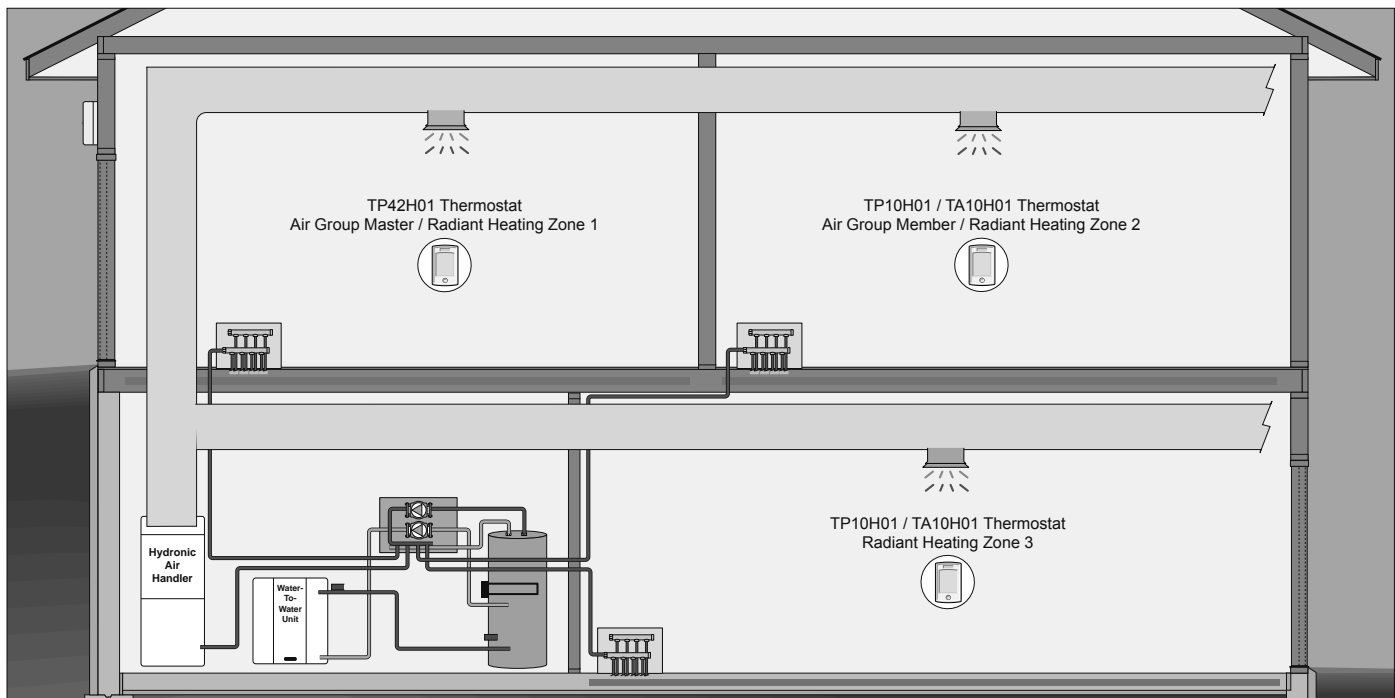

#### Application Description

- 1 x water-to-water heat pump, with backup electric element, provides hydronic heating for 3 radiant floor heating zones and 1 AHU.
- The AHU provides air heating and air cooling into all of the radiant floor heating zones. The air heating serves primarily as supplemental heat for the hydronic radiant floor heating. Zone 1 is the controlling thermostat and is configured as an Air Group Master while zone 2 is configured as an Air Group Member. Zone 3 is not configured as an Air Group Member so its temperature is not considered in the average calculated by the Air Group Master.

#### Sequence of Operation

##### Hydronic Heat/Cool Vote

- Determination of the Heat Pump control heating or cooling mode is based on a vote among all heat/cool thermostats.
  - If the Heat Pump control is in the heating mode, then a majority of heat/cool thermostats must require cooling before the Heat Pump control will switch to cooling mode.
  - If the Heat Pump control is in the cooling mode, then a majority of heat/cool thermostats must require heating before the Heat Pump control will switch to heating mode.
  - Heat/cool thermostats in their dead-band between heating and cooling are not included in the vote.
  - Heat only thermostats are not included in the vote.
  - If only one heat/cool thermostat is present, then its mode will determine the Heat Pump control heating or cooling mode.
  - The Heat Pump control applies an interlock time when switching between heating and cooling.

##### Hydronic Heating

- Provided the Heat Pump control is not in WWSD and any hydronic zone requires heat, the Heat Pump control will call on the water-to-water heat pump for hydronic heating (including the AHU).

- If the water-to-water heat pump cannot satisfy the load requirements or the water-to-water heat pump is disabled due to a supply temperature limit, the electric element is turned on to provide supplemental hydronic heat.
- The hydronic heating target is based on outdoor reset with indoor temperature feedback per zone.
- The hydronic heating zones operate using an Automatic Heating Cycle (number of cycles per hour).
- Zone post purge operates load pump and single zone after the heat pump is turned off.

##### Air heating

- Radiant floor heating (zone 1) is supplemented by the hydronic AHU as needed to satisfy the load. Electric strip heat, if applicable, would operate as a supplement to the AHU.
- Provided Zone 1 (Air Group Master) is not in WWSD, there is a requirement for stage 2 AHU, and the Heat Pump Control is in the heating mode, the water-to-water heat pump is operated to provide an outdoor reset water temperature for the AHU. If the Zone 1 Mode is set to Auto, an interlock time is applied to the Heat-Cool switchover.

##### Air cooling

- Provided Zone 1 (Air Group Master) is not in CWSD and the Heat Pump Control is in the cooling mode, the water-to-water heat pump is operated to provide a chilled setpoint water temperature for the AHU. If the Zone 1 Mode is set to Auto, an interlock time is applied to the Heat-Cool switchover.

##### Hydronic / Air integration

- Network sharing of outdoor temperature, real time, schedules, and global Away mode is available.

# Application Example 3: cont.

## Single Water-to-Water Unit with Radiant Heat Flooring and Forced Air Heating/Cooling via Hydronic Air Handler

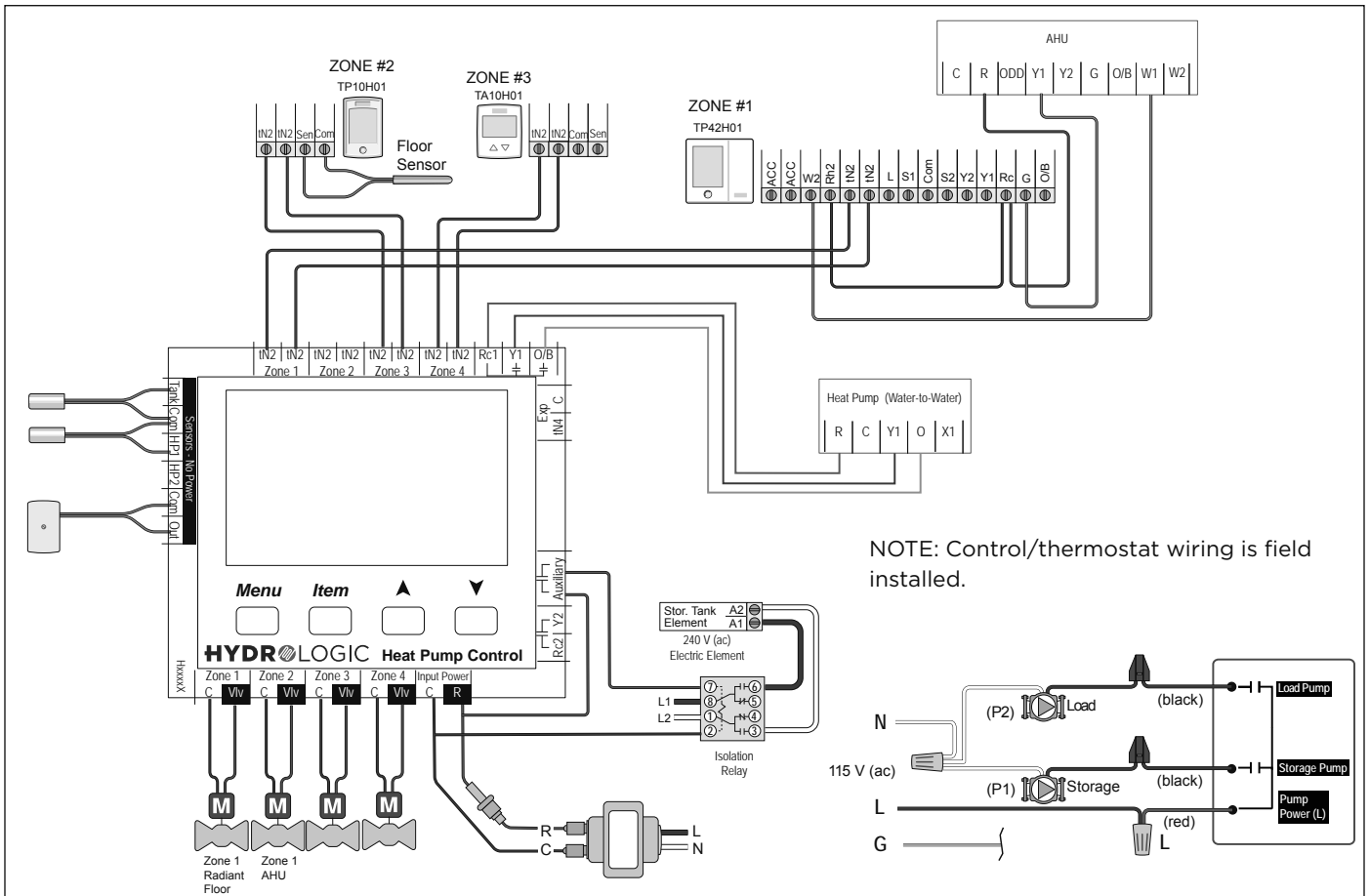

Key Settings			
	ZONE 1	ZONE 2	ZONE 3
<b>Control Panel</b>	<b>TP42H01*</b>	<b>TP10H01/ TA10H01*</b>	<b>TP10H01/ TA10H01*</b>
WWSD (40° F to 100° F)	W1 RELAY = ON	AIR GROUP MEMBER = 1	AIR GROUP MEMBER = NONE
BALANCE PT (OFF, -10° F to 60° F)	Y1 RELAY = HP1		
Y COOLING CWSD (OFF, 35° F to 75° F)	W2 RELAY (ON, OFF)		
	W1 HEAT WWSD (OFF, 32° to 80° F)		
	AIR GROUP MASTER = 1		

\*Reference thermostat manuals for specific thermostat settings.

## Application Example 4:

### Single Water-to-Water Unit with Radiant Floor Heating and Forced Air Heating/Cooling via Multiple Hydronic Air Handlers

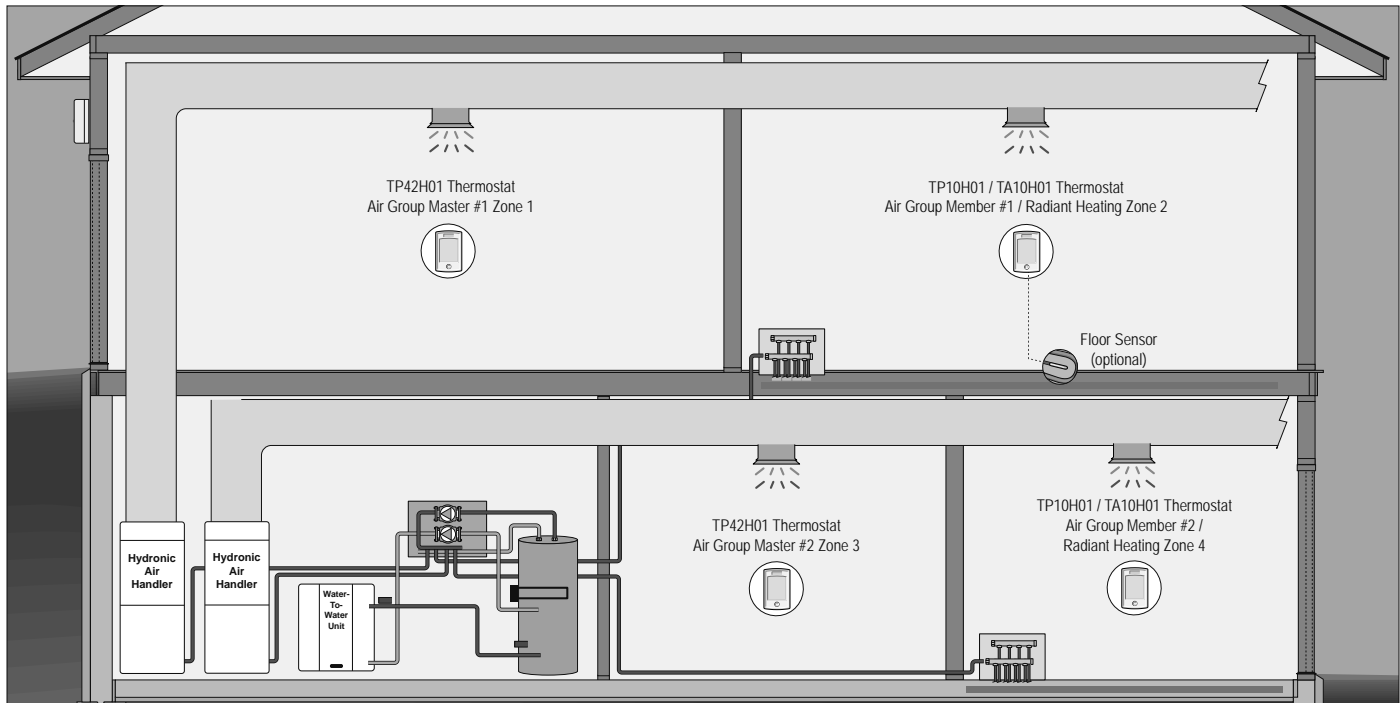

#### Application Description

- 1 x water-to-water heat pump, with backup electric element, provides hydronic heating for 2 radiant floor zones and 2 AHUs.
- 2 x AHUs, one servicing upstairs and the other downstairs, provide air heating and air cooling into their respective areas. Zone 1 is the controlling thermostat for the upstairs and is configured as Air Group Master #1 while zone 2 is configured as an Air Group Member #1. Zone 3 is the controlling thermostat for the downstairs and is configured as Air Group Master #2 while zone 4 is configured as Air Group Member #2.

#### Sequence of Operation

##### Hydronic Heat/Cool Vote

- Determination of the Heat Pump control heating or cooling mode is based on a vote among all heat/cool thermostats.
  - If the Heat Pump control is in heating mode, then a majority of heat/cool thermostats must require cooling before the Heat Pump control will switch to cooling mode.
  - If the Heat Pump control is in cooling mode, then a majority of heat/cool thermostats must require heating before the Heat Pump control will switch to heating mode.
  - Heat/cool thermostats in their dead-band between heating and cooling are not included in the vote.
  - Heat only thermostats are not included in the vote.
  - If only one heat/cool thermostat is present, then its mode will determine the Heat Pump control heating or cooling mode.
  - The Heat Pump control applies an interlock time when switching between heating and cooling.

##### Hydronic Heating

- Provided the Heat Pump control is not in WWSD (Warm Weather Shutdown) and any hydronic zone requires heat and the Heat Pump control is in heating mode, the Heat Pump control will call on the water-to-water heat pump for hydronic heating (including the AHU).

- If the water-to-water heat pump cannot satisfy the load requirements or the water-to-water heat pump is disabled due to a supply temperature limit, the electric element is turned on to provide supplemental hydronic heat.
- The hydronic heating target is based on outdoor reset with indoor temperature feedback per zone.
- The hydronic floor heating zones operate using an Automatic Heating Cycle (number of cycles per hour).
- Zones with floor sensors (and built-in air sensors) will operate to maintain their respective floor minimum during mild outdoor temperature. As the outdoor temperature drops, more heat will be put into the floor (limited to the floor maximum) to satisfy their respective air temperature setpoint.
- Zone post purge operates load pump and single zone after the heat pump is turned off.

##### Air heating

- Provided Zone 1 is not in WWSD and the Heat Pump control is in heating mode, the water-to-water heat pump is operated to provide an outdoor reset water temperature for the AHU. If the Zone 1 Mode is set to Auto, an interlock time is applied to the Heat-Cool switchover.
- Provided Zone 3 is not in WWSD and the Heat Pump control is in heating mode, the water-to-water heat pump is operated to provide an outdoor reset water temperature for the AHU. If the Zone 3 Mode is set to Auto, an interlock time is applied to the Heat-Cool switchover.

##### Air cooling

- Provided Zone 1 is not in CWSD and the Heat Pump Control is in cooling mode, the water-to-water heat pump is operated to provide a chilled setpoint water temperature for the AHU. If the Zone 1 Mode is set to Auto, an interlock time is applied to the Heat-Cool switchover.

# Application Example 4: cont.

## Single Water-to-Water Unit with Radiant Floor Heating and Forced Air Heating/Cooling via Multiple Hydronic Air Handlers

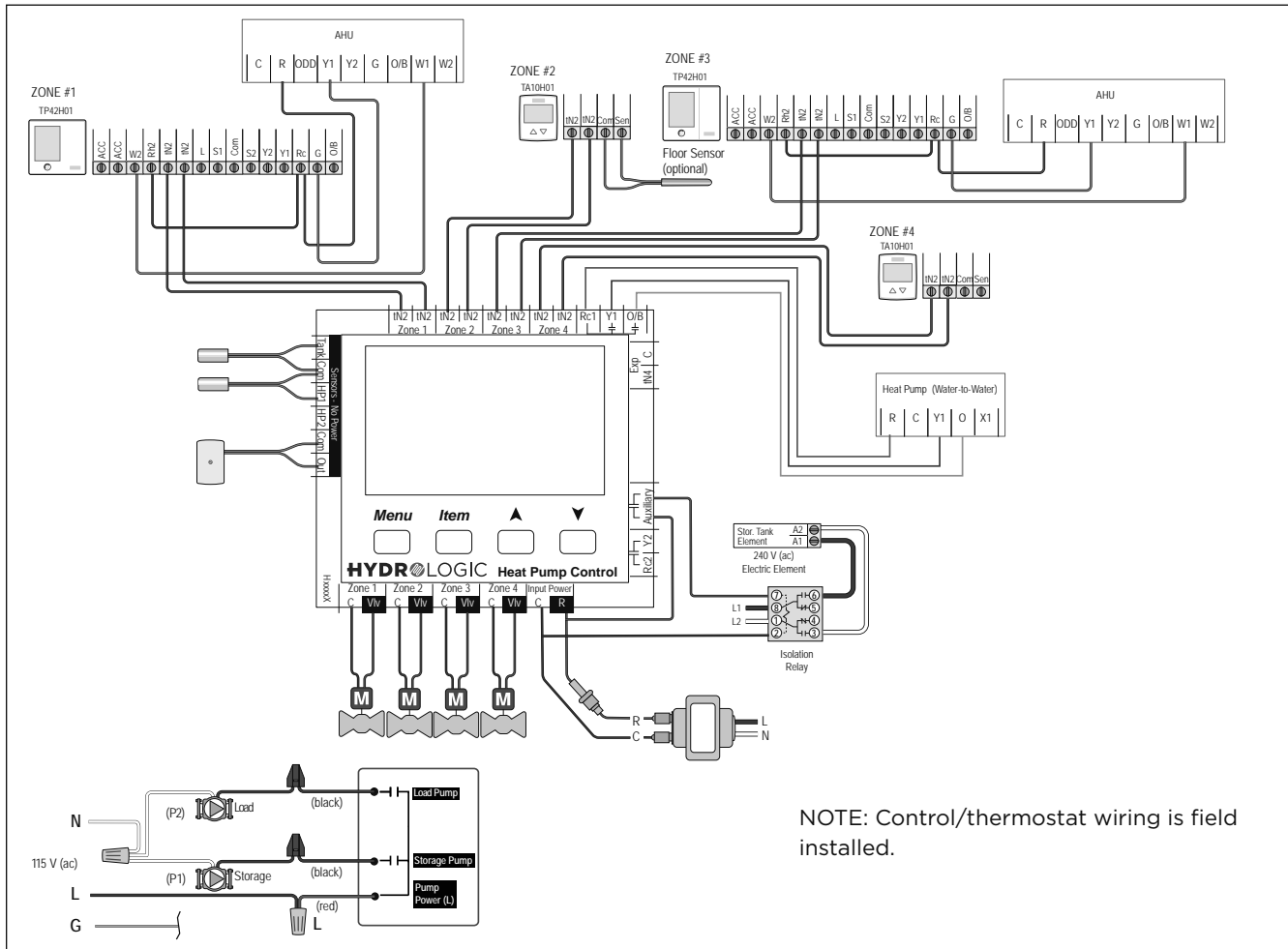

- Provided Zone 3 is not in CWSD and the Heat Pump Control is in cooling mode, the water-to-water heat pump is operated to provide a chilled setpoint water temperature for the AHU. If the Zone 1 Mode is set to Auto, an interlock time is applied to the Heat-Cool switchover.

### Hydronic / Air integration

- Hydronic heating is disabled in Zone 3 if Zone 1 is operating in the cooling mode.
- Hydronic heating is disabled in Zone 1 if Zone 3 is operating in the cooling mode.
- Network sharing of outdoor temperature, real time, schedules and global Away mode is available.

Key Settings				
	ZONE 1	ZONE 2	ZONE 3	ZONE 4
<b>Control Panel</b>	TP42H01*	TP10H01/ TA10H01*	TP42H01*	TP10H01/ TA10H01*
WWSD (40°F to 100°F)	W1 RELAY = OFF	AIR GROUP MEMBER = 1	W1 RELAY = OFF	AIR GROUP MEMBER = 2
BALANCE PT (OFF, -10°F to 60°F)	Y1 RELAY = COIL		Y1 RELAY = COIL	
Y COOLING CWSD (OFF, 35°F to 75°F)	W2 RELAY (ON, OFF)		AIR GROUP MASTER = 2	
	AIR GROUP MASTER = 1			

\*Reference thermostat manuals for specific thermostat settings.

## Application Example 5:

### Single Combination Unit with Radiant Floor Heat and Forced Air Heating/Cooling

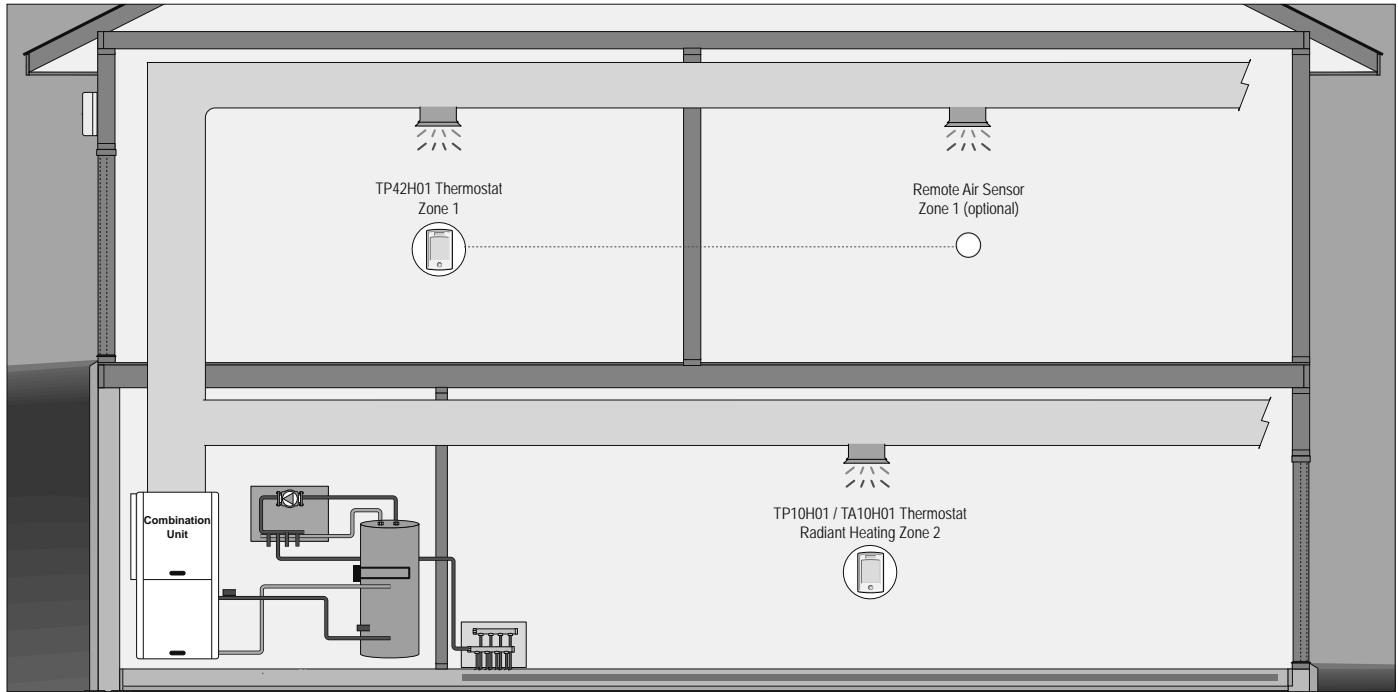

#### Application Description

- 1 x Packaged Heat Pump, with backup electric element, provide hydronic heating for 1 radiant floor zone.
- The heat pump also provides air heating and air cooling for the whole house including radiant floor zone. Zone 1 is the controlling thermostat for the Air system.

#### Sequence of Operation

##### Hydronic heating

- Provided the Heat Pump control is not in WWSD (Warm Weather Shutdown) and any hydronic zone requires heat, the Heat Pump control will call on the Packaged Heat Pump for hydronic heating.
- The hydronic heating load may not be met if the Packaged Heat Pump is unavailable for hydronic heating (ie. due to Air heating/cooling).
- If the heat pump cannot satisfy the load requirements or the heat pump is disabled due to a supply temperature limit, the electric element is turned on to provide supplemental hydronic heat.
- The hydronic heating target is based on outdoor reset with indoor temperature feedback per zone.
- The hydronic floor heating zone operates using an Automatic Heating Cycle (number of cycles per hour).
- Zone post purge operates load pump and zone after the heat pump is turned off.

##### Air heating

- Provided Zone 1 is not in WWSD and there is a requirement for heating, the heat pump is operated to maintain the setpoint air temperature. If the Zone 1 Mode is set to Auto, an interlock time is applied to the Heat-Cool switchover.

##### Air cooling

- Provided Zone 1 is not in CWSD (Cold Weather Shutdown) and there is a requirement for cooling, the heat pump is operated to maintain the setpoint air temperature. If the Zone 1 Mode is set to Auto, an interlock time is applied to the Heat-Cool switchover.

##### Hydronic / Air integration

- If heat pump is configured for air heating priority, hydronic heating is disabled if the Heat Pump is in air heating mode.
- If heat pump is configured for air cooling priority, hydronic heating is disabled if the Heat Pump is in air cooling mode.
- Network sharing of outdoor temperature, real time, schedules, and global Away mode is available.

# Application Example 5: cont.

## Single Combination Unit with Radiant Floor Heat and Forced Air Heating/Cooling

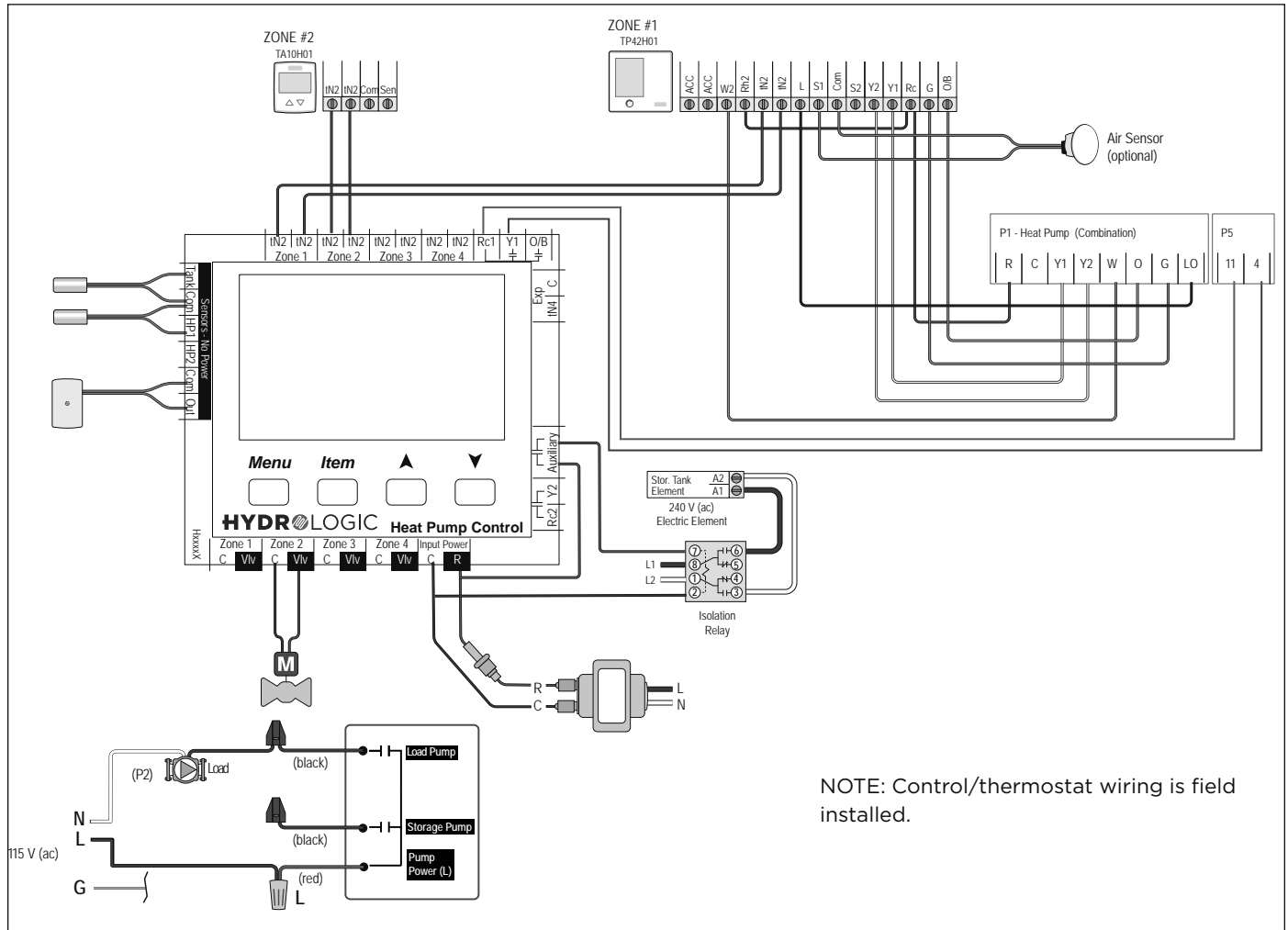

Key Settings		
	ZONE 1	ZONE 2
<b>Control Panel</b>	<b>TP42H01*</b>	<b>TP10H01/ TA10H01*</b>
WWSD (40°F to 100°F)	W1 RELAY = OFF	AIR GROUP MEMBER = NONE
BALANCE PT (OFF, -10°F to 60°F)	Y1 RELAY = HP1	
	W2 RELAY (ON, OFF)	
	COOLING CWSD (OFF, 35°F to 75°F)	
	BALANCE POINT (OFF, 10°F to 70°F)	
	W1 HEAT WWSD (OFF, 32°F to 80°F)	
	AIR GROUP MASTER = NONE	

\*Reference thermostat manuals for specific thermostat settings.

## Application Example 6:

### Single Combination Unit with Radiant Floor Heating and Forced Air Heating/Cooling with Multiple Hydronic Zones

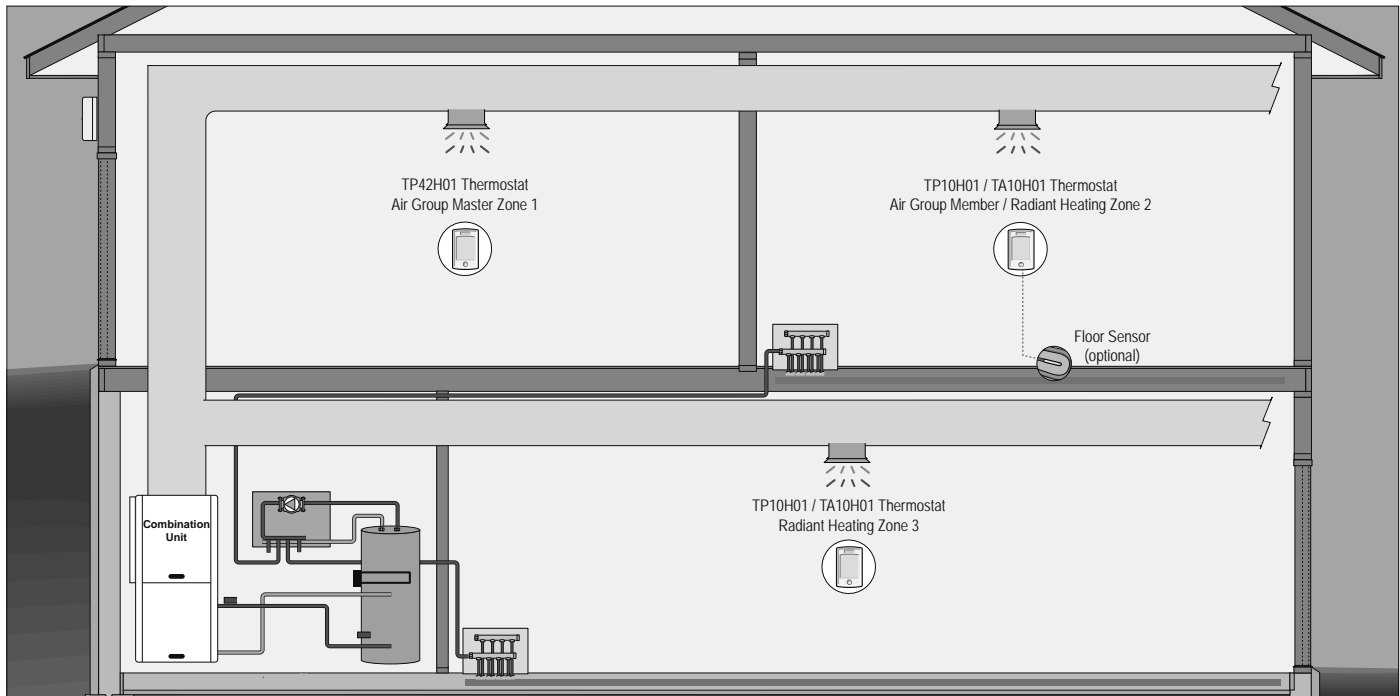

#### Application Description

- 1 x Combination Unit, with backup electric element, provide hydronic heating for 2 radiant floor zones.
- The heat pump also provides air heating and air cooling for the whole house including the radiant floor zones. Zone 1 is the controlling thermostat and is configured as the Air Group Master while zone 2 is configured as an Air Group Member. Zone 3 is not configured as an Air Group Member so its temperature is not considered in the average calculated by the Air Group Master.

#### Sequence of Operation

##### Hydronic Heating

- Provided the Heat Pump control is not in WWSD (Warm Weather Shutdown) and any hydronic zone requires heat, the Heat Pump control will call on the Combination Unit for hydronic heating.
- The hydronic heating load may not be met if the Combination Unit is unavailable for hydronic heating (ie. due to Air heating/cooling).
- If the heat pump cannot satisfy the load requirements or the heat pump is disabled due to a supply temperature limit, the electric element is turned on to provide supplemental hydronic heat.
- The hydronic heating target is based on outdoor reset with indoor temperature feedback per zone.
- The hydronic floor heating zone operates using an Automatic Heating Cycle (number of cycles per hour).
- Zones with floor sensors (and built-in air sensors) will operate to maintain their respective floor minimum during mild outdoor temperature. As the outdoor temperature drops, more heat will be put into the floor (limited to the floor maximum) to satisfy their respective air temperature setpoint.
- Zone post purge operates load pump and single zone after the heat pump is turned off.

##### Air heating

- Provided Zone 1 is not in WWSD and there is a requirement for heating, the heat pump is operated to maintain the setpoint air temperature. If the Zone 1 Mode is set to Auto, an interlock time is applied to the Heat-Cool switchover.

##### Air cooling

- Provided Zone 1 is not in CWSD (Cold Weather Shutdown) and there is a requirement for cooling, the heat pump is operated to maintain the setpoint air temperature. If the Zone 1 Mode is set to Auto, an interlock time is applied to the Heat-Cool switchover.

##### Hydronic / Air integration

- If heat pump is configured for air heating priority, a hydronic heating call is delayed until the forced air heating demand is satisfied.
- If heat pump is configured for air cooling priority, a hydronic heating call is delayed until the forced air cooling demand is satisfied.
- If the heat pump is configured for hydronic heating priority a forced air heating call is satisfied with auxiliary heat.
- If the heat pump is configured for hydronic heating priority a forced air cooling call is delayed until the hydronic heating demand is satisfied.
- Network sharing of outdoor temperature, real time, schedules, and global Away mode is available.



# Application Example 6: cont.

## Single Combination Unit with Radiant Floor Heating and Forced Air Heating/Cooling with Multiple Hydronic Zones

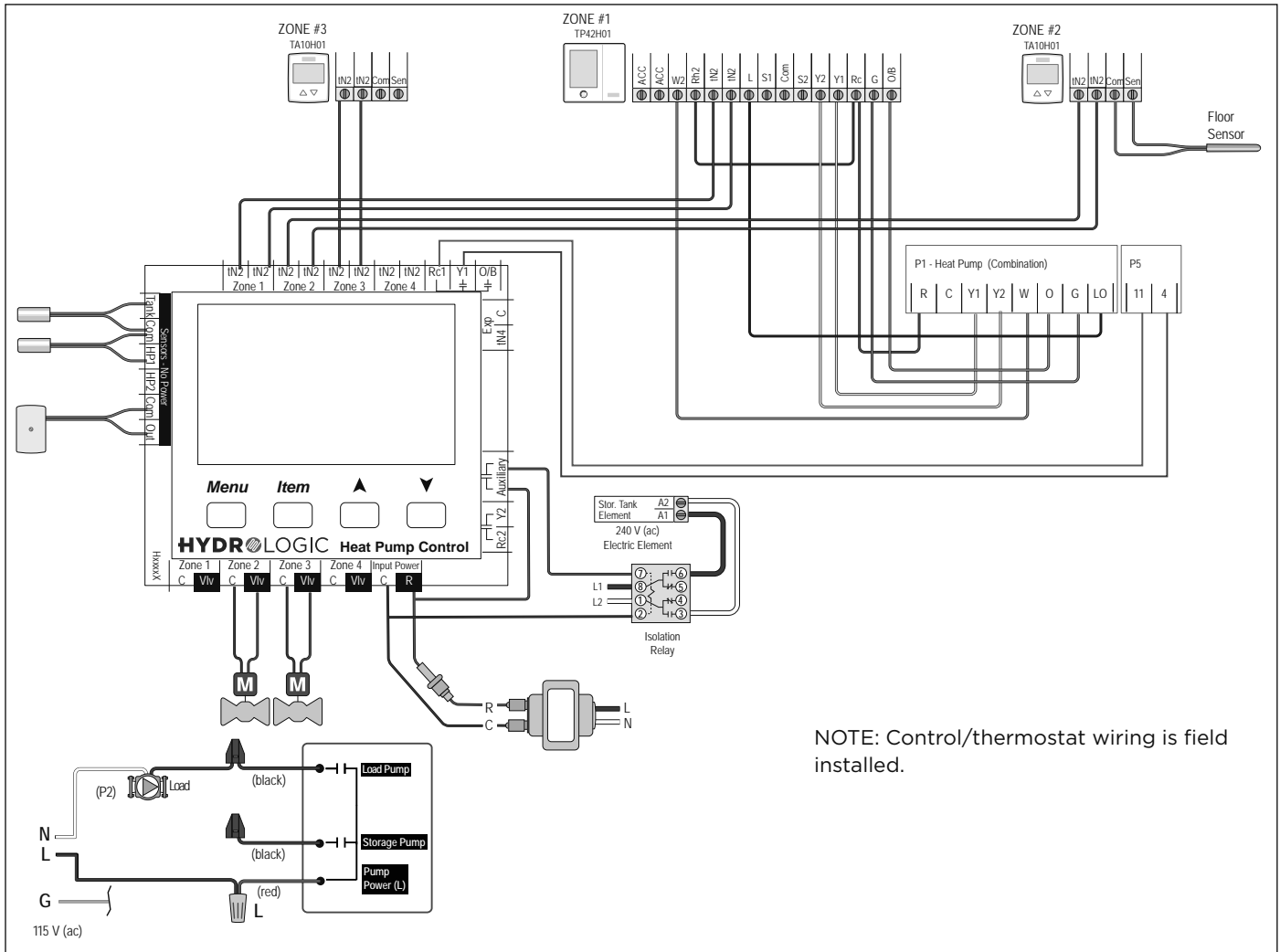

Key Settings			
	ZONE 1	ZONE 2	ZONE 3
<b>Control Panel</b>	<b>TP42H01*</b>	<b>TP10H01/ TA10H01*</b>	<b>TP10H01/ TA10H01*</b>
WWSD (40° F to 100° F)	W1 RELAY = OFF	AIR GROUP MEMBER = 1	AIR GROUP MEMBER = NONE
BALANCE PT (OFF, -10° F to 60° F)	Y1 RELAY = HP1		
	COOLING CWSD (OFF, 35° F to 75° F)		
	BALANCE POINT (OFF, 10° F to 70° F)		
	W1 HEAT WWSD (OFF, 32° F to 80° F)		
	AIR GROUP MASTER = 1		

\*Reference thermostat manuals for specific thermostat settings.

## Dimensional Data - Combination Unit Control Panel

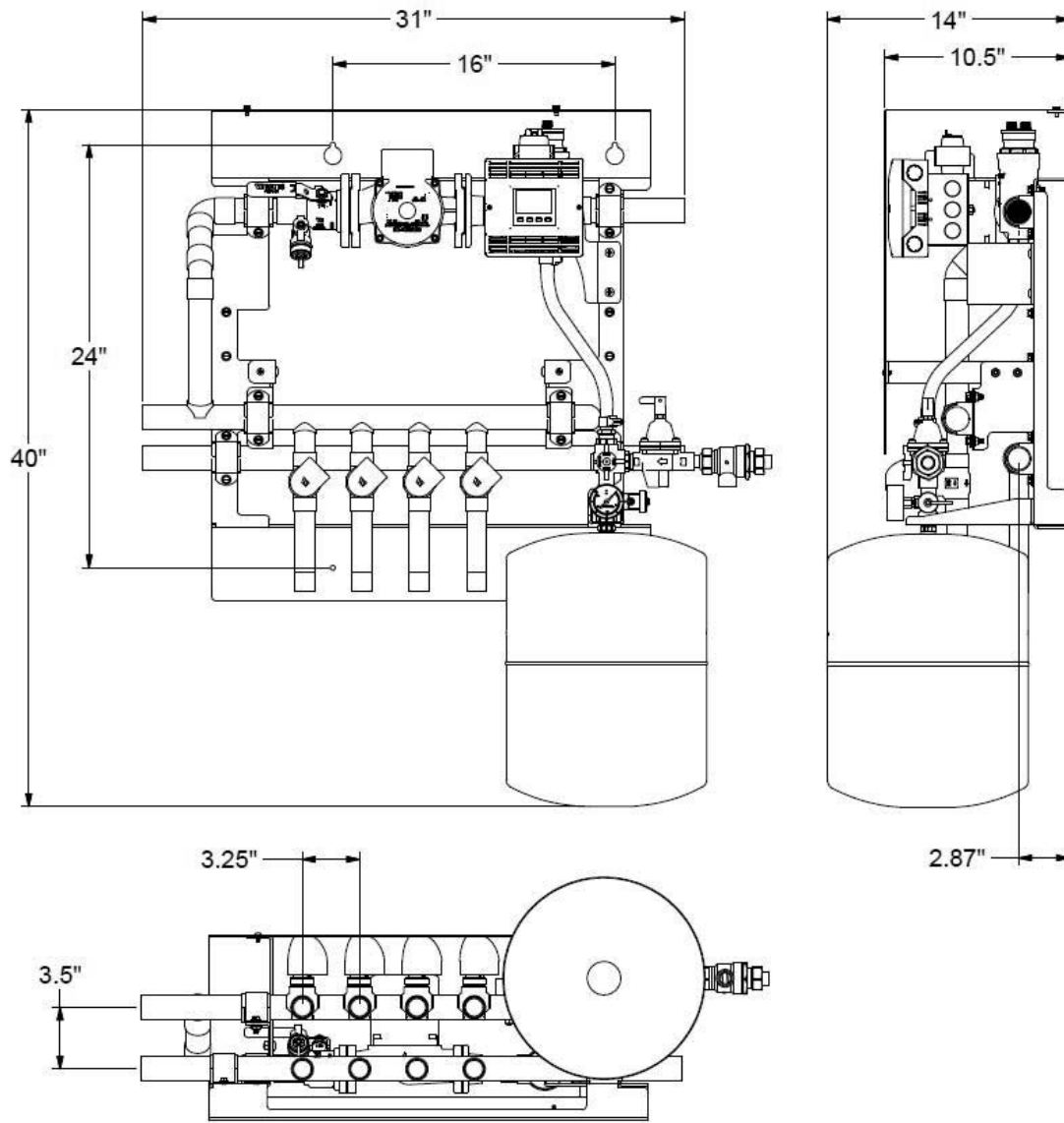

## Dimensional Data - Water-to-Water Control Panel

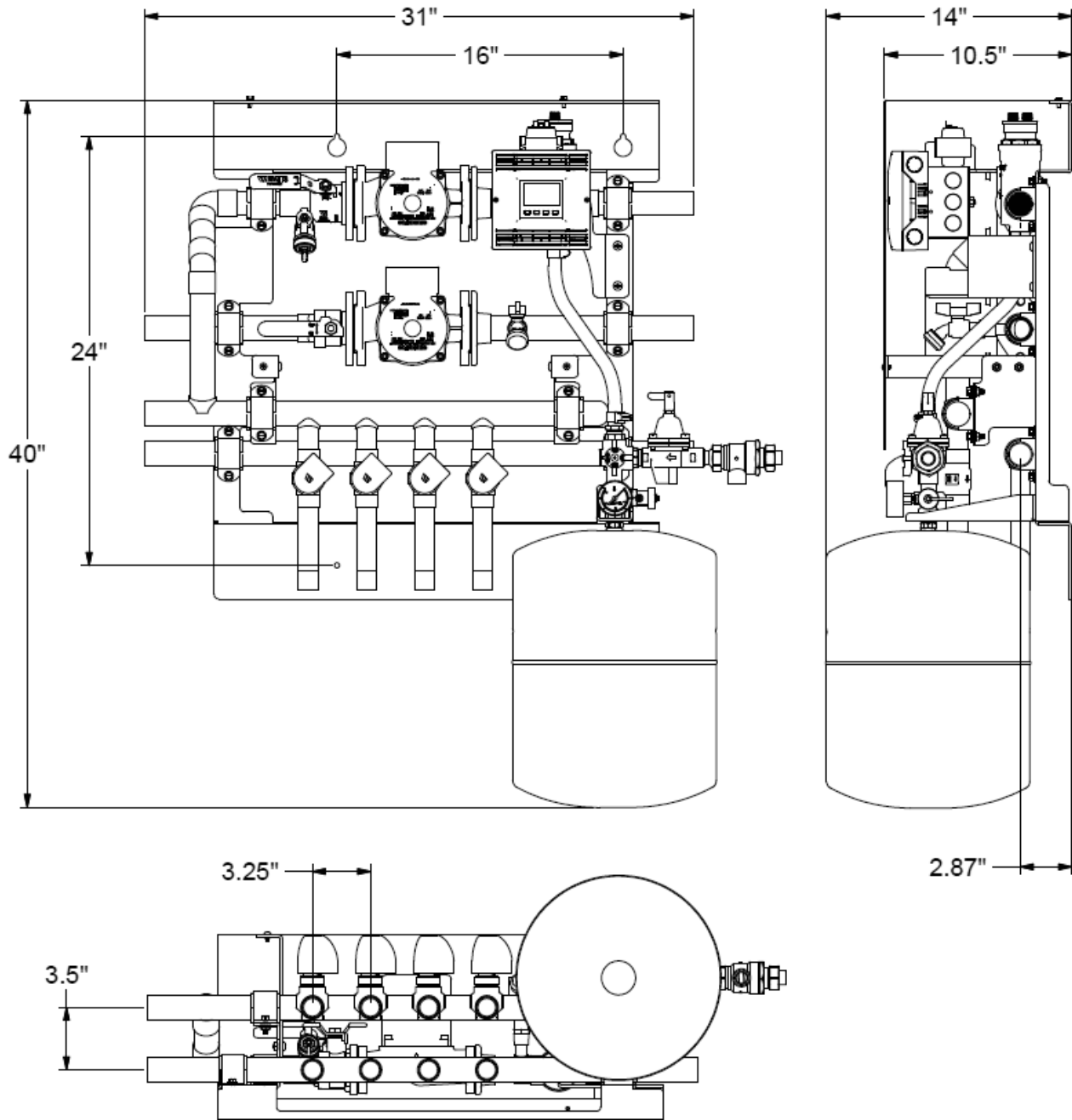

## Dimensional Data - Zone Expansion Panel

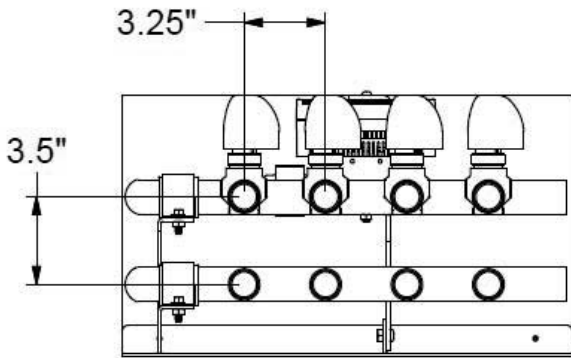
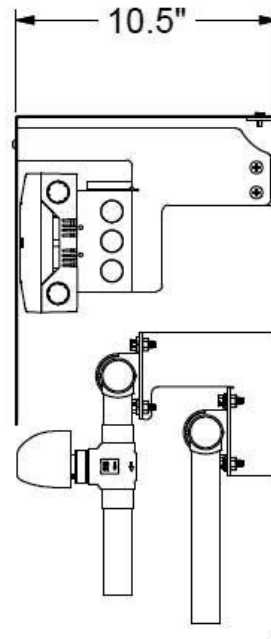
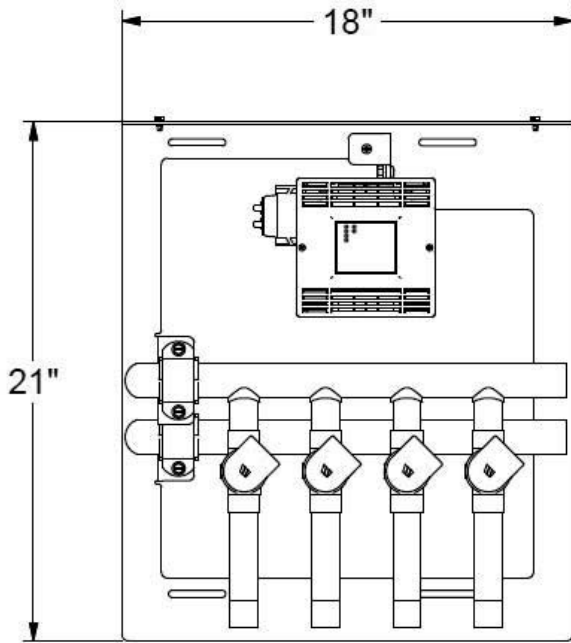

# Pump Curves - Control Panels

Zoning Flow Output - Control Panels for up to 3 Ton Units

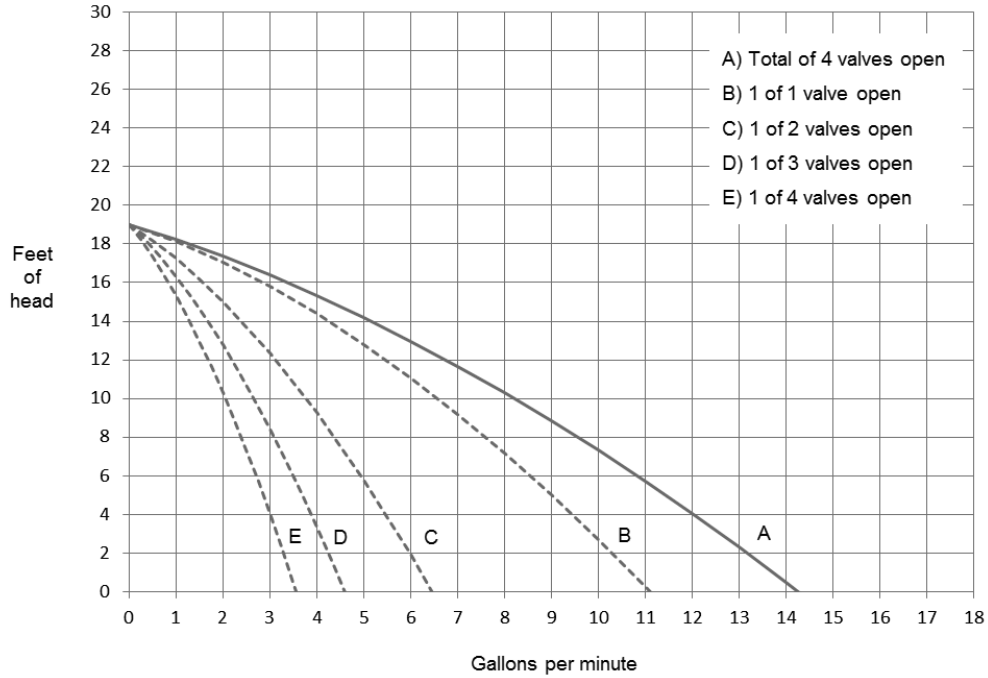

Zoning Flow Output - Control Panels for up to 6 Ton Units

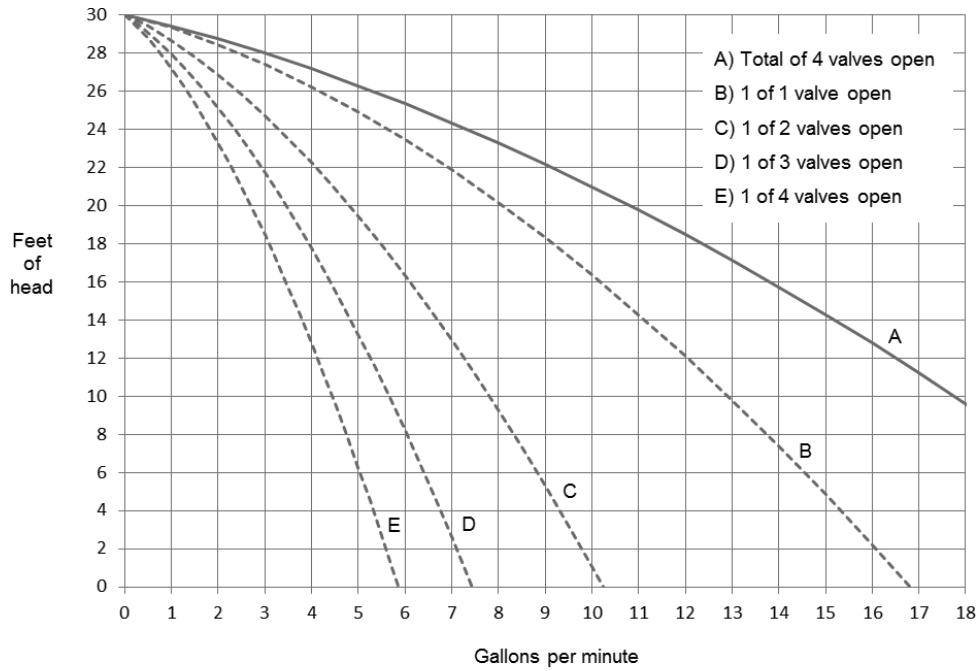

## Physical and Electrical Data - Water-to-Water and Combination

Control Panel Specifications – Water-to-Water and Combination System		
Model Size:	3 Ton	6 Ton
Total hydronic zoning capability:	Up to 2,000 square feet of radiant	Up to 5,000 square feet of radiant
Capability of each zone (valve):	100 to 1,000 square feet of radiant	200 to 2,000 square feet of radiant
Tank and Heat Pump connections:	1-1/4" Copper	
Zone connections:	1" Copper	
Pump maximum electrical usage:	90 W, 120 VAC, 0.75 A	200 W, 120 VAC, 1.67 A
Electrical transformer:	120 VAC to 24 VAC and 40VA (40 W)	
Valve actuator type:	(4x) Thermal motor, 3 minute warm-up, IP54	
Valve actuator max. elec. Usage:	1.8 W, 24 VAC, 0.08 A	
Ambient conditions:	Indoor use only	
Water temperature limits:	36F (2.2C) – 180F (82.2C) Insulation required when water temperature is below local dew-point	
Operating pressure:	10 to 30 psi	
Fluid type:	Water with low mineral concentration and corrosion inhibitor Inhibited propylene glycol can be added if freeze protection is required	

## Physical and Electrical Data - Combination Unit Control Panel

Control Panel Specifications – Combination System		
Model Size:	3 Ton	6 Ton
Model Number – Standard:	HLPC3U	HLPC6U
Model Number – With Insulation:	HLPC3I	HLPC6I
Pump (circulator) type:	Wet rotor, iron volute, Grundfos UP15-58	Wet rotor, iron volute, Grundfos UP26-99
Total maximum electrical usage:	115 W, 120 VAC, 1.0 A	225 W, 120 VAC, 1.9 A
Weight:	90 lbs (41 kg)	95 lbs (43 kg)

## Physical and Electrical Data - Water-to-Water Control Panel

Control Panel Specifications – Water-to-Water System		
Model Size:	3 Ton	6 Ton
Model Number – Standard:	HLPW3U	HLPW6U
Model Number – With Insulation:	HLPW3I	HLPW6I
Heat Pump load connection:	Up to 3 tons output	3 to 6 tons output
Pump (circulator) type:	Wet rotor, iron volute, (2x) Grundfos UP15-58	Wet rotor, iron volute, (2x) Grundfos UP26-99
Total maximum electrical usage:	205 W, 120 VAC, 1.7 A	425 W, 120 VAC, 3.5 A
Weight:	100 lbs (45 kg)	110 lbs (50 kg)

# System Piping

## System Piping

System piping to the zones, tank and heat pump should be sized for flow velocity between 2 and 5 feet per second. Check pipe size and pressure drop tables in comparison to pump performance. The table below has data for one possible pipe type.

Pipe Flow Rate and Velocity				
Pipe Size	Lower Flow Resistance		Higher Flow Resistance	
	2 ft/sec	3 ft/sec	4 ft/sec	5 ft/sec
	GPM	GPM	GPM	GPM
3/4" CTS SDR9	2.2	3.3	4.4	5.5
1" CTS SDR9	3.7	5.5	7.3	9.2
1-1/4" CTS SDR9	5.5	8.2	11.0	14.0

## OptiHeat Water-to-Water Standard Piping

- Standard

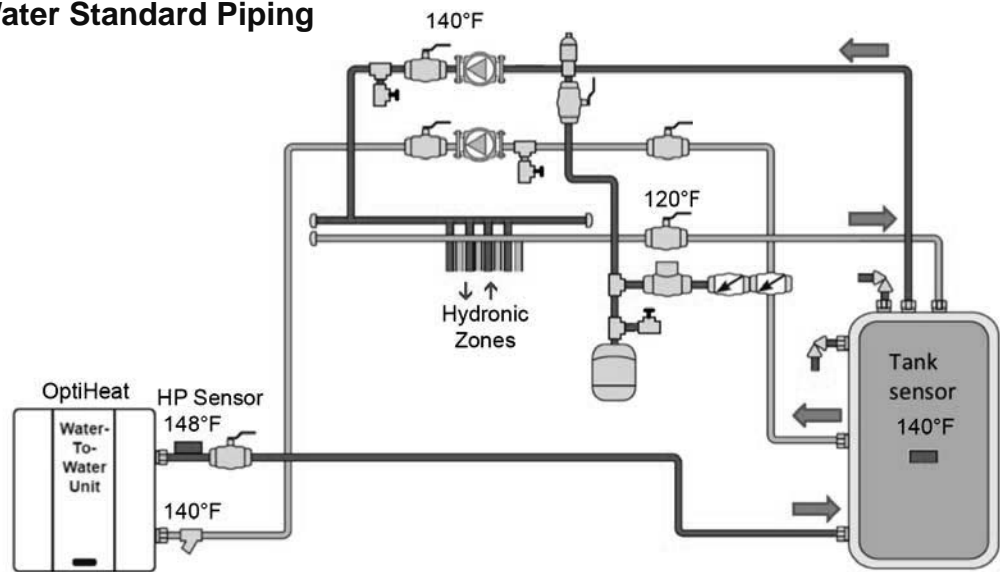

\*Temperatures shown for illustration purposes only

## OptiHeat Water-to-Water Alternate Piping

- Supply Temperature extension in heating and cooling
- Faster response
- Supply temperature differential increases
- Less standby tank losses

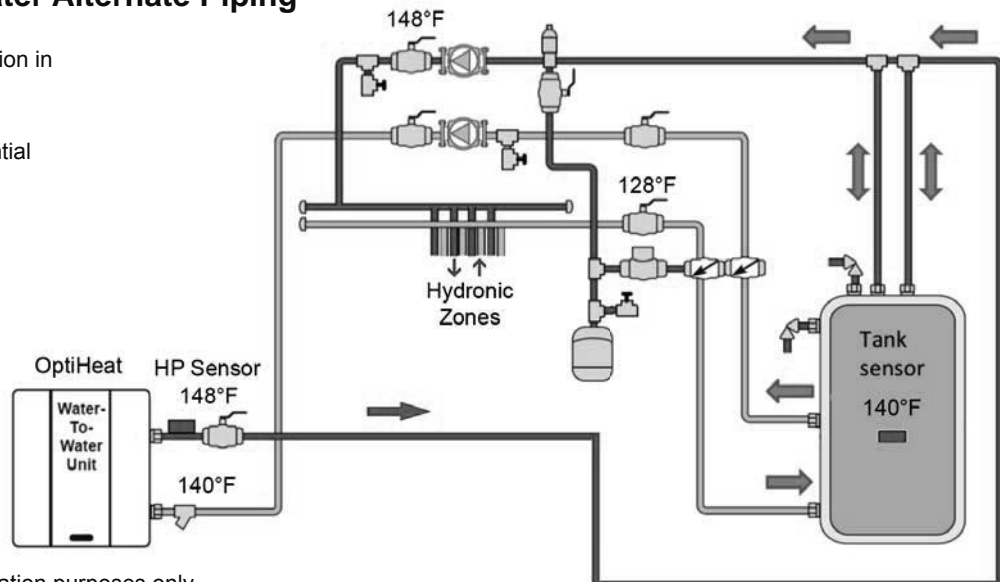

\*Temperatures shown for illustration purposes only

# System Piping

## System Piping

System piping to the zones, tank and heat pump should be sized for flow velocity between 2 and 5 feet per second. Check pipe size and pressure drop tables in comparison to pump performance. The table below has data for one possible pipe type.

Pipe Flow Rate and Velocity				
Pipe Size	Lower Flow Resistance		Higher Flow Resistance	
	2 ft/sec	3 ft/sec	4 ft/sec	5 ft/sec
	GPM	GPM	GPM	GPM
3/4" CTS SDR9	2.2	3.3	4.4	5.5
1" CTS SDR9	3.7	5.5	7.3	9.2
1-1/4" CTS SDR9	5.5	8.2	11.0	14.0

## Non-OptiHeat Water-to-Water Standard Piping

- Standard

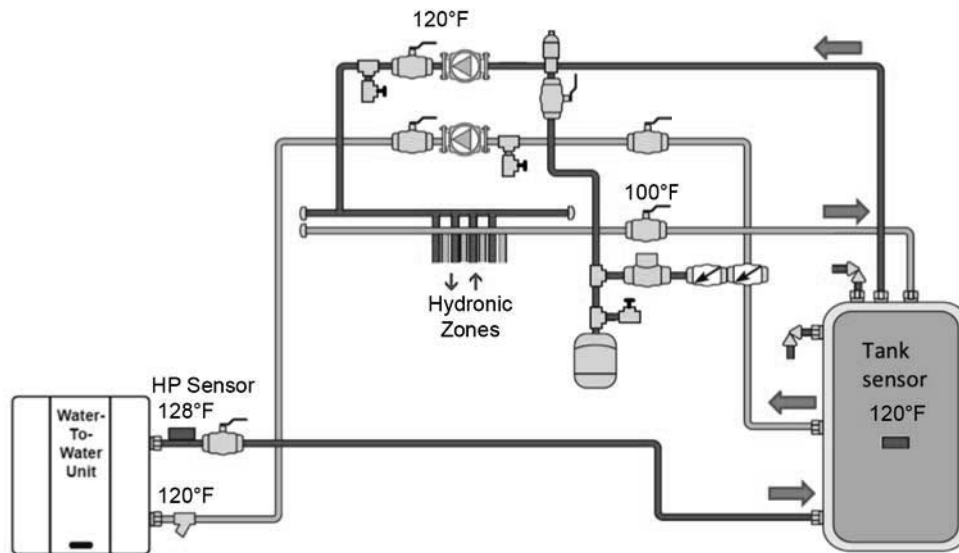

\*Temperatures shown for illustration purposes only

## Non-OptiHeat Water-to-Water Alternate Piping

- Supply Temperature extension in heating and cooling
- Faster response
- Supply temperature differential increases
- Less standby tank losses

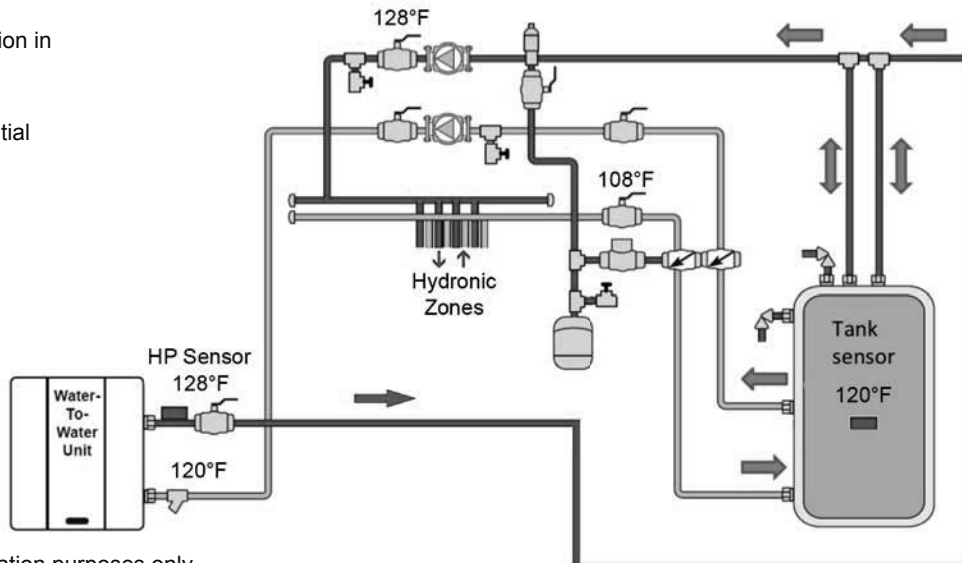

\*Temperatures shown for illustration purposes only



## System Piping, cont.

### Combination System Standard Piping

- Standard

\*Temperatures shown for illustration purposes only

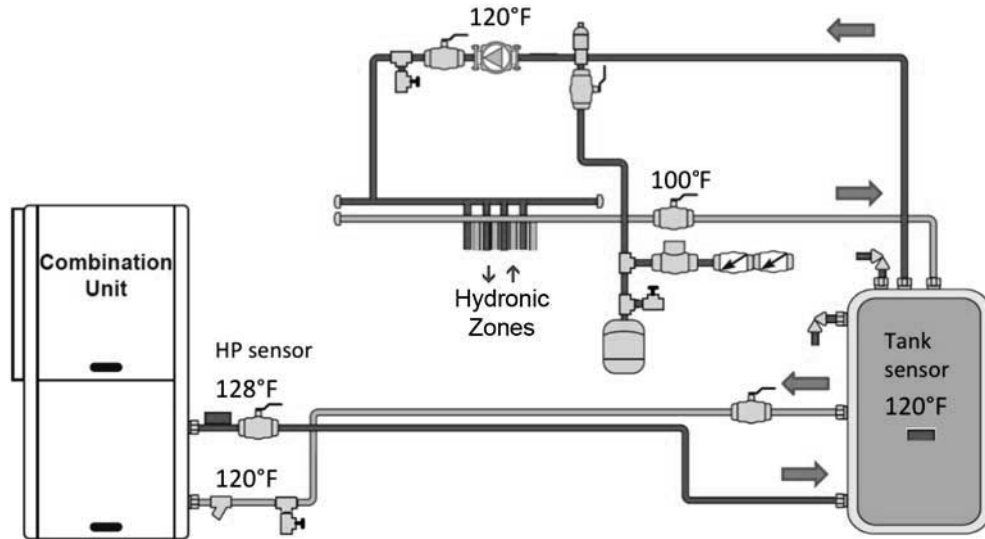

### Combination System Alternate Piping

- Supply Temperature extension in hydronic heating
- Faster response
- Supply temperature differential increases
- Less standby tank losses

\*Temperatures shown for illustration purposes only

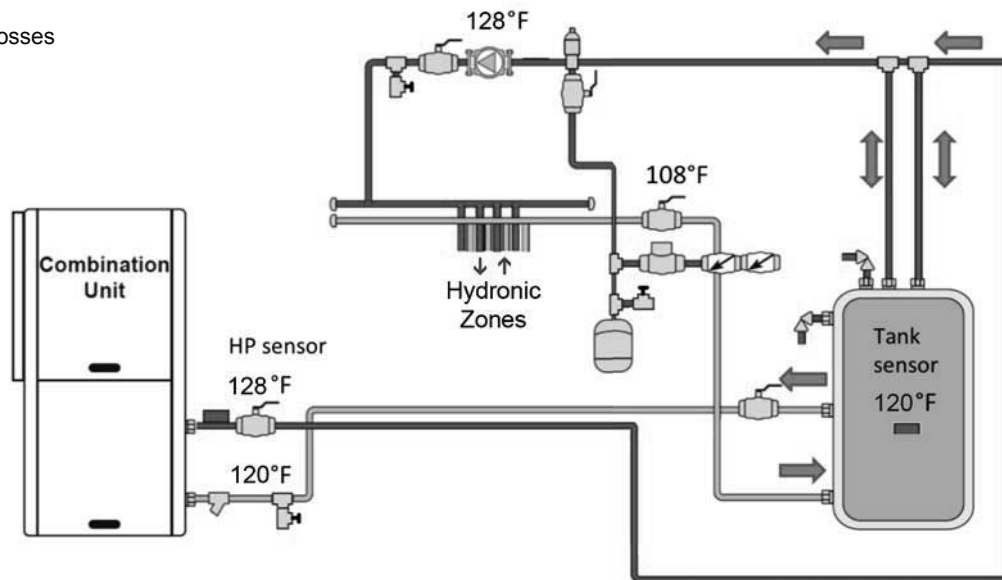

# Panel Installation

## Preparing Installation Location

To begin installation, verify that there is enough space on the wall area to fit the panels and the required connection piping to the storage tank and heat pump. The units must be installed upright on a wall or permanent stand with the air removal device facing up as shown. Next, locate where the top two mounting holes for the control panel will be. The unit may be secured to wall studs with the included 1/4" x 2 1/2" lag screws, or anchored to wood blocking or other surface with other appropriate 1/4" hardware. The hardware and thread engagement depth should comply with the weight load of the units. Mark the top two mounting locations for the control panel, and drill pilot holes (1/8" for wood), and install mounting hardware, leaving a 1/2" gap from flush to allow hanging of the control panel.

Always use two people for lifting the control panel in any of the installation steps. Remove the control panel's cover and hang it onto the top two mounting screws. Mark locations through the bottom two holes for the lower mounting hardware. Lift and remove the control panel, and move the unit onto a work surface for attaching adapters. Drill the lower pilot holes that were marked on the mounting surface.

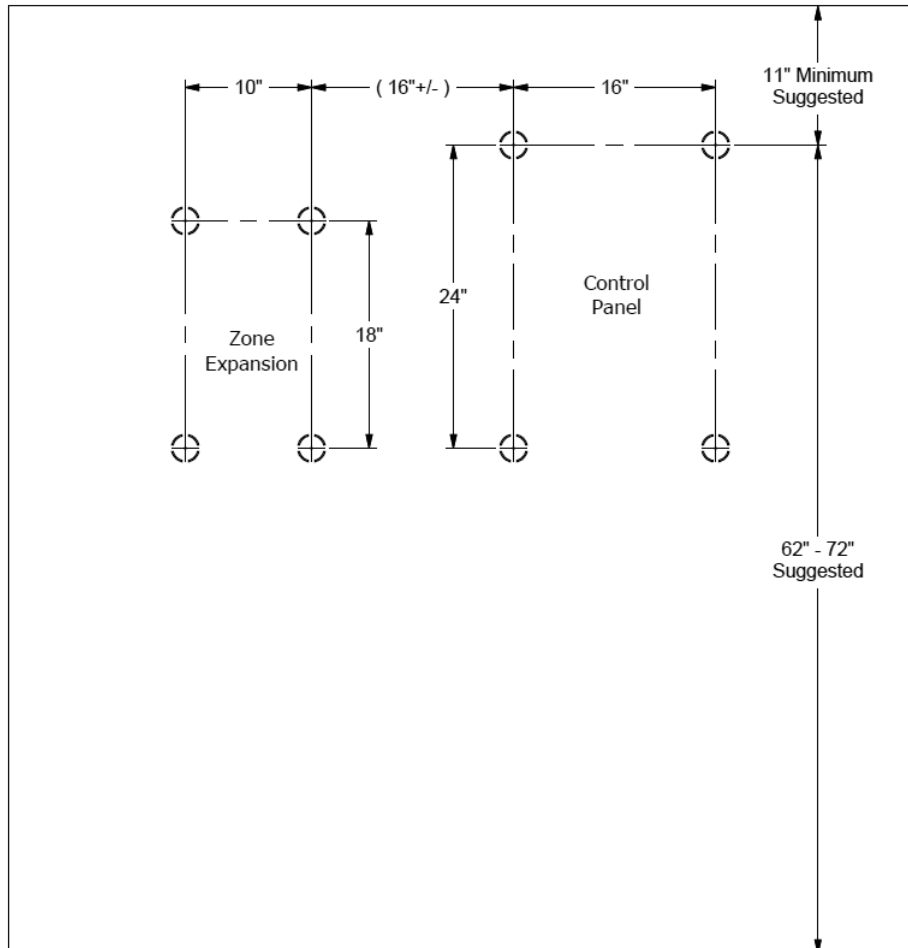
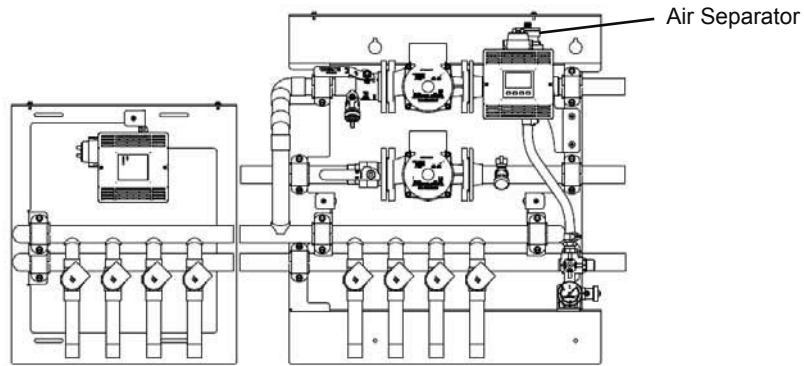

## Panel Installation, cont.

### Preparing Control Panel for Installation

Based on the system piping chosen, described in the System Piping section, determine the adapter fittings required to transition from copper pipe on the control panel to the system piping. When soldering to the control panel, it is recommended to wrap a damp cloth around the area near the rubber cushion clamps to protect from excess heat. **Before soldering to the copper at the zone supply valves, unscrew and remove the valve actuators by turning the knurled silver rings.** The actuators can be temporarily tied away during soldering, and will not be re-installed until later during the filling process. Attach the adapters to the control panel for system piping connections. When the entire system is connected, air pressure of 30 psi may be introduced to locate joint leaks. Air pressure may be held for 24 hours or longer to detect small leaks. Small drops in pressure may result from temperature drop. The automatic air vents need to be closed in the system for an air test. If there are fiber gaskets in the system, they may leak air when dry and seal when wetted.

### Mounting and Connecting Control Panel

Hang the control panel on the top two mounting screws, previously described, and using two people lifting. Secure the bottom two mounting holes with mounting hardware. If a zone expansion panel will be used, dry-fit the expansion panel to the control panel and mark mounting locations, or use provided dimensions to pre-drill mounting holes. Mount and attach the expansion panel and pipe connections to the control panel.

Remove the blue control cover(s) and wire the thermostats and sensors to the control panel's on-board control box as described in the application drawings. Use 18 gauge thermostat wire and use the rear openings for wire routing. **Do not connect Rc1, Y1, O/B, Rc2, Y2, or Auxiliary at this time.** If valve wiring is changed, use an Ohm meter to check that the resistance between C and Vlv terminals are greater than 10 ohms, indicating there are no shorted circuits. Plug the power cord 3-prong plug(s) into a 120VAC outlet, protected by a (15A) breaker. Check that the devices power on without showing errors. If there are errors, troubleshoot using the control installation documents. Unplug to turn off the controls after wiring is confirmed.

Review the piping and related piping component placements, and complete system piping installation in accordance with applicable codes and best practices. The expansion tank pressure can be checked before installation, and a tire gauge reading of around 12 psi at ambient temperature (70F) is normal. The fill pressure regulation valve supply line should be installed with an isolation ball valve upstream. The 30 psi pressure relief valve may be installed on the top of the storage tank in the 3/4" hot (no dip tube) port. Alternatively, it can replace an existing higher pressure relief valve, and an air vent can be installed in the top of tank hot port.

It is recommended to connect the automatic fill valve assembly to a water supply as a means to add water to the system without introducing new air. The fill valve is used to top off pressure during air purging initially, and in the case of seasonal maintenance.

### Filling and Purging

Before filling, estimate the volume of water in the system to be filled. All water sources, city and well, hard and soft, have ability to cause problems with corrosion and biological growth over time in a closed loop system. Water that has low mineral content and free of microbes is preferred fill water. Obtain both corrosion inhibitor and microbial inhibitor water treatment designed for hydronic heating and cooling systems in the quantity recommended by the chemical product manufacturer for your application. If antifreeze will be used, inhibited versions are available, or ensure inhibitors are compatible when added.

## Panel Installation, cont.

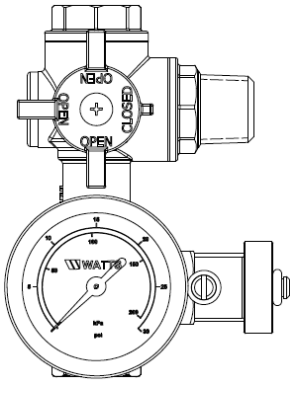
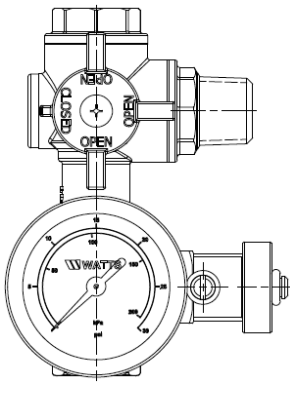
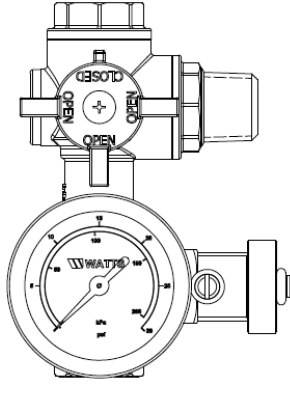
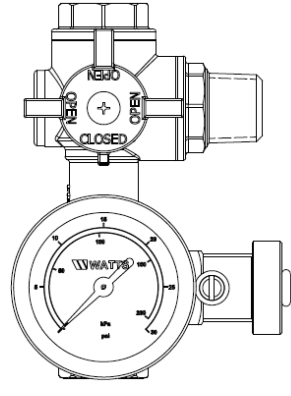
RBFF			
Position 1	Position 2	Position 3	Position 4
			
Water Treatment and Normal Operation	Fill / Purge and Operation	Pressure Regulator Adjustment	Expansion Tank Maintenance and Replacement

Adjust the RBFF valve (A) to position 1 by pressing the red handle inward and turning. Open the vents at the top of the air remover (B) approximately 1 turn from closed. If not already removed, unscrew the valve actuators (C) to open the valves manually. Inhibitor water treatment solution can be added by closing valve D and pumping into drain port E with drain port F opened for venting. Alternatively, inhibitor water treatment may be added into the storage tank by other means.

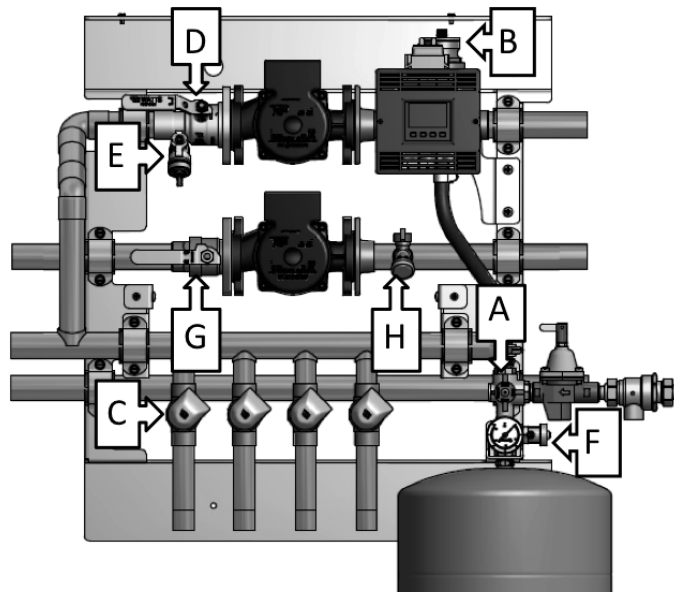

Close valve D, connect drain hose to port E and H (or inlet side drain for combination unit) and route to empty catch bucket or floor drain, and close ports F and H. Turn valve A to position 2 and open water supply to pressure regulated fill assembly. Open port E and allow water to fill the system until there is more water than air exiting the drain hose, then close port E. Open drain port H (or inlet side drain for combination unit) and allow fill until more water than air is exiting, then close port H. Open the air vent or pressure relief valve on the top of the storage tank to allow that air to purge, then close.

## Panel Installation, cont.

---

With initial air purging complete, allow water pressure in the system to rise to 10-15 psi. The circulator pumps will be used for the remaining air removal. Plug in the electrical cords to power the system. Use the following sequence to activate pumping.

– Adjust,  – Mode, ▲ ▼ – Off

– Toolbox,  – Access, ▲ ▼ – Installer

– Toolbox,  – User Test, ▲ - Test

When in test mode, press  to advance past zone valve test and hold 1-4, and stop at pump hold.

– Tank Pump test hold

Allow air to vent from the air remover (B) and allow the fill valve to add water. Open and close combinations of zone valves by reattaching zone actuators, while allowing at least 1 to remain open at a time. When it appears most of the bubbles of air have escaped. Loosen the vent screw in the center of the pump and ensure water has filled the pump. Once air is purged, retighten vent screw on pump. The  button can be pressed to stop the pump.

If the application is a combination system (HLPCxx), slightly purge the drain on the inlet side of the unit once more to ensure the internal pump has water. If the application is a water-to-water system (HLPWxx), repeat the controller user test steps and continue pressing the  button and pause on HP Pump test hold.

– HP Pump test hold

Slightly purge drain port H to ensure the pump has water at the suction side. Slightly purge the air vent or relief valve at the top of the storage tank to ensure the air has been removed. Loosen the vent screw in the center of the pump and ensure water has filled the pump. Once air is purged, retighten vent screw on pump. Press the  button to stop the pump.

The water pressure (static charge) in the system should be brought up to 10-15 psi after air is removed.

# Heat Pump Control

---

## Introduction

The HydroLogic Heat Pump Control is designed to operate the equipment in a 2-pipe, single tank, hydronic heating and cooling system. It operates two heat pump stages (water-to-water) with a backup heat source (boiler or electric resistance). The heat pump provides either hot or chilled water to a storage tank loop. For radiant heating, the water temperature is calculated using outdoor temperature reset. For radiant cooling, the chilled water temperature is maintained at an adjustable setpoint.

## Features

- One or two-stage heat pump control
- Equal runtime rotation for two heat pumps
- Auxiliary backup (electric element/ on-off boiler)
- Tank, outdoor reset temperatures
- Four 24 V (ac) built in powered zone valve outputs
- CSA C US Certified for use in USA and Canada

## Benefits

- Energy efficiency through Outdoor Temperature Reset with Indoor Temperature Feedback
- Indoor Temperature Feedback minimizes the water temperature (increasing energy savings), and the efficiency of your mechanical equipment through integrated HydroLogic Thermostats
- Zone Synchronization reduces equipment cycling
- Auto Differential - Reduces cycling
- Compact enclosure for flexible installation
- Simple zone expansion using Wiring Centers

# Heat Pump Control, cont.

## User Interface - Display

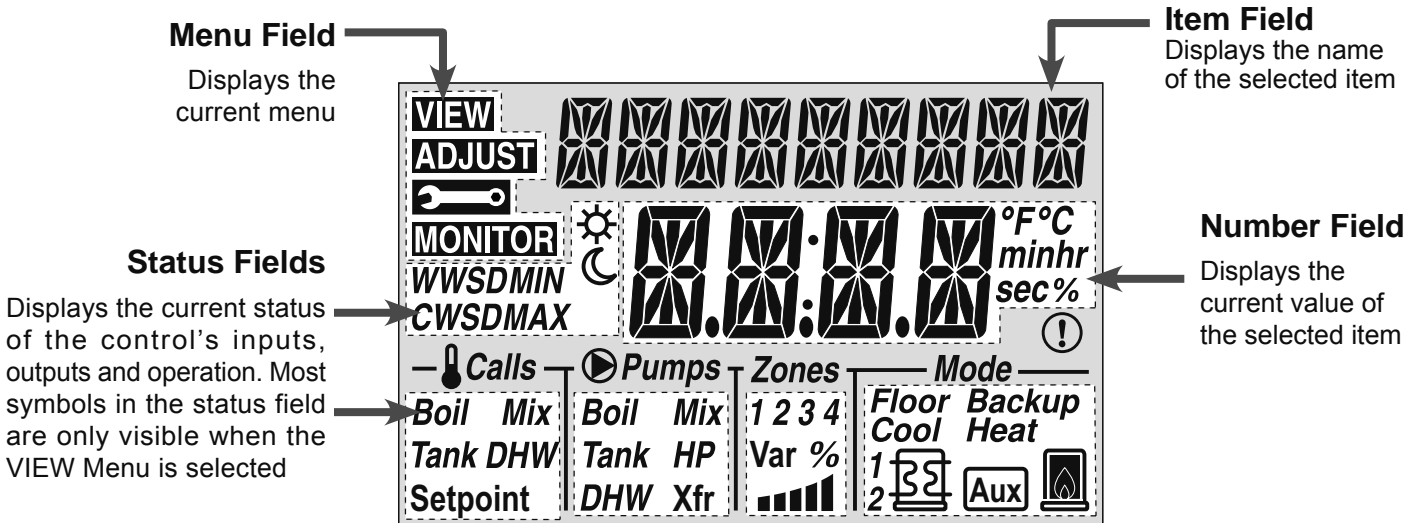

Calls	<b>CALLS</b> Displays any call for heat or cool the control is receiving.
Pumps	<b>PUMPS</b> Displays any pump currently operating.
Zones 1 2 3 4	<b>ZONES</b> Displays if an on-board zone is operating.
WWSD CWSD	<b>WWSD / CWSD</b> The system is currently in Warm Weather Shut Down or Cold Weather Shut Down.
MIN MAX	<b>MIN / MAX</b> Heat pump is prevented from operating due to high or low return water temperature.
	<b>OCCUPIED</b> Indicates that a User Switch or Timer has put the system into Occupied.
	<b>UNOCCUPIED</b> Indicates that a User Switch or Timer has put the system into UnOccupied.

1 2	<b>HEAT PUMP</b> Heat pump stage 1 or 2 is operating.
	<b>AUXILIARY</b> An auxiliary backup heat source is currently operating using the Backup relay.
<i>Backup</i>	<b>BACKUP</b> Backup heat source is required to assist in heating the tank sensor to its target.
<i>Cool Heat</i>	<b>COOL / HEAT</b> The heat pump is operating in either cool or heat mode.
°F°C minhr sec%	<b>°F, °C, MINUTES, HOURS, SECONDS, %</b> Units of measurement for current number.
	<b>WARNING</b> Displays if an error exists on the system.

### Navigating the Display

The Heat Pump Control uses a simple user interface to accomplish a variety of functions. The four buttons beneath

#### Menu Button

The menus display in the Menu Field at the top left side of the LCD. Four menus are available: View, Adjust, Monitor and Toolbox (identified by the wrench symbol).

- The View menu allows the user to view the current status of various system parameters.
- The Adjust menu allows the installer to adjust settings to ensure control operation matches requirements of the mechanical system.

the display are used to change the menu, sort through Items, and adjust each setting as required.

- The Monitor menu keeps track of run times and other important data that is collected during system operation.
- The Toolbox menu is a source of system information and includes useful tools for commissioning and testing the system.

## Heat Pump Control, cont.

### Item Button

Each menu contains a list of Items that can be viewed and, in some cases, adjusted. Press the item button to scroll through the list in each Menu.

- To view the next available item, press and release the Item button.
- To view the previous item, hold down the Item button, and press and release the Up button.

### Up and Down Buttons

The Up and Down buttons are primarily used for adjusting settings.

To adjust a setting:

- Select the appropriate menu using the Menu button.

- Select the item using the Item button.
- Use the Up or Down button to make the adjustment.

### Default Item

When navigating menus, the display reverts back to the default item (View Menu) after 60 seconds of button inactivity.

- To set the default item in the View menu, display the item for more than five seconds.

### Access Levels and Thermostat Lock

The Heat Pump Control is shipped pre-programmed with common settings. The Heat Pump Control has an 'Installer' access level that allows full access to all settings and a 'User' access level that restricts the number of settings available. The Heat Pump Control defaults to the 'User' access level after 12 hours of operation.

All thermostats are locked while the Heat Pump Control is in the 'User' access level. Certain settings on the thermostat will be unavailable while the thermostat is locked.

To change to the 'Installer' access level and Unlock the thermostats:

- In the Toolbox menu, locate Access
- Adjust the access level to 'Installer' by pressing the up or down button. This will permit setting changes to the control.

### Programming and Settings

The Heat Pump Control settings can be found in the 'Adjust' menu. When changing the items value, the setting is saved to the control's memory once the Item button is pressed to advance to the next item, or after 60 seconds, the control times out and reverts back to the 'View' menu.

All settings are stored in permanent memory and will be kept correctly during any loss of power.

### View Menu

The View menu items display the current operating temperatures and status information of the system.

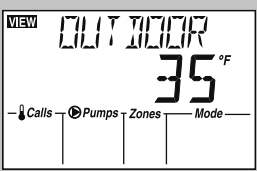
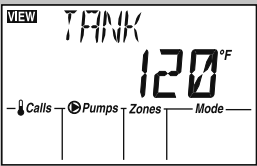
Item Field	Range	Description
	---, -76 to 149°F (-60 to 65°C)	<b>OUTDOOR</b> Current outdoor air temperature as measured by the local or remote outdoor sensor. The outdoor air temperature is shared to all thermostats in the system. "---" is displayed when no outdoor sensor is available.
	---, -22 to 266°F (-30 to 130°C)	<b>TANK</b> Current tank supply water temperature as measured by the tank sensor. The control operates the heat pump and backup so that the tank supply is equal to the tank target. "---" is displayed when no tank sensor is available.



## Heat Pump Control, cont.



### View Menu

The View menu items display the current operating temperatures and status information of the system.

Item Field	Range	Description
	---, 35 to 200°F (1.5 to 93.0°C)	<b>TANK TARGET</b> The temperature the control is currently trying to maintain at the tank sensor. The tank target is calculated based on the outdoor design and tank design settings. “---” is displayed when no heat is required for tank zones.
	---, -22 to 266°F (-30 to 130°C)	<b>HEAT PUMP 1 SUPPLY</b> Current supply water temperature for heat pump #1 as measured by the HP1 sensor. “---” is displayed when no heat pump supply sensor is available
	---, -22 to 266°F (-30 to 130°C)	<b>HEAT PUMP 2 SUPPLY</b> Current supply water temperature for heat pump #2 as measured by the HP2 sensor. “---” is displayed when no heat pump supply sensor is available
		<b>SYSTEM IN AWAY</b> The heating system is in the Away scene. Use the User Switch to change scene out of Away.
		<b>PURGING HEAT</b> Heat is being purged from the storage tank and the heat pump is not allowed to come on. This may continue for up to 30 minutes and then precool will begin.
		<b>PRECOOL TANK</b> The heat pump is cooling the storage tank while the zones remain off. This may continue for up to 30 minutes and then the zones are allowed to call for cooling.
		<b>PURGING COOL</b> Cool water is being purged from the storage tank and the heat pump is not allowed to come on. This may continue for up to 30 minutes and then preheat will begin.
		<b>PREHEAT TANK</b> The heat pump is heating the storage tank while the zones remain off. This may continue for up to 30 minutes and then the zones are allowed to call for heating.



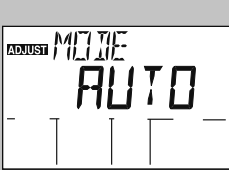
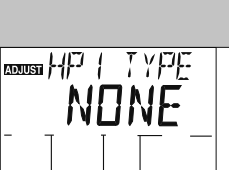
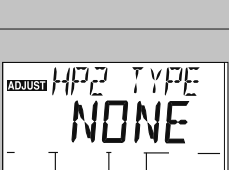
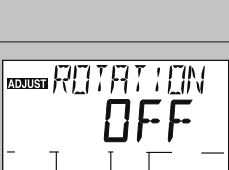
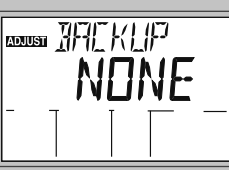
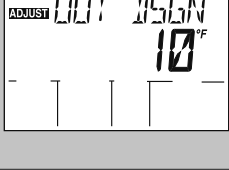
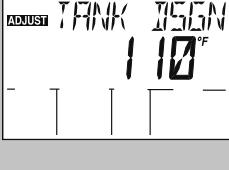

## Heat Pump Control, cont.

**Adjust Menu** The Adjust menu items are the programmable settings used to determine what type of system to operate.

Item Field	Range	Description
	AUTO, BKUP, OFF Default = AUTO <b>Access:</b> User <b>Set to:</b>	<b>MODE</b> AUTO - Automatic heat pump switchover between heating and cooling. Backup heat is brought on automatically as needed. BKUP - Heat pump is disabled. Boiler or backup heat is brought on automatically as needed. OFF - Heat pump is disabled. Boiler or backup heat is disabled.
	NONE, COMB, WW1N, WW2N, WW1H, WW2H Default = NONE <b>Access:</b> Installer <b>Set to:</b>	<b>HEAT PUMP 1 TYPE</b> NONE - Heat pump 1 is not available. COMB - Single stage combination unit. Uses 130°F as heat pump supply limiting temp. WW1N - Single stage water-to-water unit. Uses 130°F as heat pump supply limiting temp. WW2N - Two stage water-to-water unit. Uses 130°F as heat pump supply limiting temp. WW1H - Single stage water-to-water unit. Uses 150°F as heat pump supply limiting temp. WW2H - Two stage water-to-water unit. Uses 150°F as heat pump supply limiting temp.
	NONE, COMB, WW1N, WW1H Default = NONE <b>Access:</b> Installer <b>Set to:</b>	<b>HEAT PUMP 2 TYPE</b> NONE - Heat pump 2 is not available. COMB - Single stage combination unit. Uses 130°F as heat pump supply limiting temp. WW1N - Single stage water-to-water unit. Uses 130°F as heat pump supply limiting temp. WW1H - Single stage water-to-water unit. Uses 150°F as heat pump supply limiting temp. Note: Item is only available when HP1 TYPE = COMB, WW1N or WW1H.
	OFF, ON Default = OFF <b>Access:</b> Installer <b>Set to:</b>	<b>ROTATION</b> OFF - Rotation is disabled. ON - Rotation is enabled with a frequency of 48 hours. Note: Item is only available when HP1 TYPE = COMB, WW1N or WW1H AND HP2 TYPE = COMB, WW1N or WW1H.
	NONE, AUX Default = NONE <b>Access:</b> Installer <b>Set to:</b>	<b>BACKUP</b> NONE - No backup heat source is available. AUX - An auxiliary heat source (electric or instantaneous water heater) is either inside or in-line with the storage tank.
	-60 to 45°F (-51 to 7°C) Default = 10°F (-12°C) <b>Access:</b> Installer <b>Set to:</b>	<b>OUTDOOR DESIGN</b> The outdoor air temperature used in the heating curves that determine the tank, mix, and boiler target temperatures. Typically set to the temperature of the coldest day of the year.
	70 to 120°F (21 to 49.0°C) OR 70 to 140°F (21 to 60.0°C) Default = 110°F (43.5°C) <b>Access:</b> Installer <b>Set to:</b>	<b>TANK DESIGN</b> The supply water temperature required for the zones to heat the building on the typical coldest day of the year. This is also the tank maximum temperature. The range is dependent on the the type of heat pump(s) selected.
	OFF, 70 to 110°F (21 to 43.5°C) Default = OFF <b>Access:</b> Installer <b>Set to:</b>	<b>TANK MINIMUM</b> The minimum allowed tank target temperature.

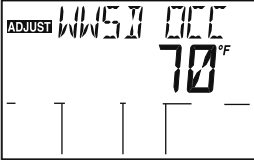
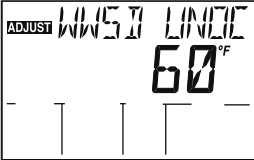
## Heat Pump Control, cont.

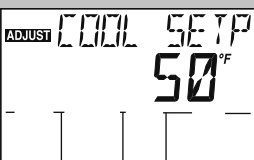
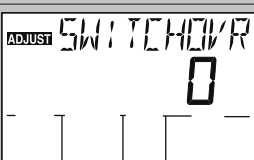
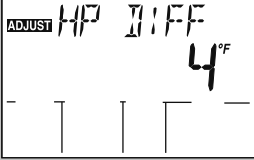
### Adjust Menu - Cont.

Item Field	Range	Description
	40 to 100°F (4.5 to 38°C) Default = 70°F (21°C) <hr/> <b>Access:</b> <i>User</i> <b>Set to:</b>	<b>WWSO OCCUPIED</b> The system's Warm Weather Shut Down temperature during Occupied periods or when a schedule is not used.
	40 to 100°F (4.5 to 38°C) Default = 60°F (15.5°C) <hr/> <b>Access:</b> <i>User</i> <b>Set to:</b>	<b>WWSO UNOCCUPIED</b> The system's Warm Weather Shut Down temperature during Unoccupied periods. <b>Note:</b> Item is only available when a schedule or User Switch is present on the system.
	10 to 180 minutes Default = 30 minutes <hr/> <b>Access:</b> <i>Installer</i> <b>Set to:</b>	<b>INTERLOCK</b> Set the minimum delay between the heat pump switching from heat to cool or cool to heat. <b>Note:</b> The interlock delay only applies when the MODE is set to AUTO.
	35 to 70°F (4 to 21°C) Default = 50°F (10°C) <hr/> <b>Access:</b> <i>Installer</i> <b>Set to:</b>	<b>COOL SETPOINT</b> Tank setpoint that will be maintained when in cooling mode.
	O, B Default = O <hr/> <b>Access:</b> <i>Installer</i> <b>Set to:</b>	<b>SWITCHOVER</b> O - Close O/B contacts to operate heat pump in cool mode. B - Close O/B contacts to operate heat pump in heat mode.
	2 to 20°F (1 to 11°C) Default = 4°F <hr/> <b>Access:</b> <i>Installer</i> <b>Set to:</b>	<b>HEAT PUMP DIFFERENTIAL</b> Differential for the tank sensor which the heat pump will cycle its compressor
	AUTO, 2:00 to 20:00 minutes Default = AUTO <hr/> <b>Access:</b> <i>Installer</i> <b>Set to:</b>	<b>HEAT PUMP 2 DELAY</b> The minimum time delay between the Y1 and Y2 stages of the heat pump. <b>Note:</b> Item is only available when: HP1 TYPE = WW2N, WW2H OR (HP1 TYPE = WW1N, WW1H, COMB AND HP2 TYPE = WW1N, WW1H, COMB)
	OFF, -10 to 60°F (-23.5 to 15.5°C) Default = OFF <hr/> <b>Access:</b> <i>Installer</i> <b>Set to:</b>	<b>BALANCE POINT</b> Prevents the heat pump from operating in heating mode if the outdoor air temperature falls below this setting.

## Heat Pump Control, cont.





### Adjust Menu - Cont.

Item Field	Range	Description
	OFF, 35 to 100°F (OFF, 1.5 to 38.0°C) Default = OFF <b>Access:</b> <i>Installer</i> <b>Set to:</b>	<b>Y COOLING CWSD</b> Prevents the heat pump from operating in cooling mode if the outdoor air temperature falls below this setting (Cold Weather Shut Down).
	0:30 to 10:00 minutes Default = 5:00 minutes <b>Access:</b> <i>Installer</i> <b>Set to:</b>	<b>Y MINIMUM RUN-TIME</b> Minimum compressor run-time for the heat pump.
	0:30 to 10:00 minutes Default = 5:00 minutes <b>Access:</b> <i>Installer</i> <b>Set to:</b>	<b>Y MINIMUM OFF-TIME</b> Minimum compressor off-time for the heat pump.
	10 to 180 minutes, OVR Default = 60 minutes <b>Access:</b> <i>Installer</i> <b>Set to:</b>	<b>BACKUP DELAY</b> The time that heat pump(s) have to run at full output before the backup heat source is called upon. OVR (override) - When selected, the backup source will not be called upon for heat unless the MODE is set to BKUP or the heat pump is locked out on high supply temperature or outdoor temperature. <b>Note:</b> This item is only available when BACKUP is set to AUX.
	°F or °C Default = °F <b>Access:</b> <i>User</i> <b>Set to:</b>	<b>UNITS</b> Selects units for temperature display.

## Heat Pump Control, cont.

### Monitor Menu

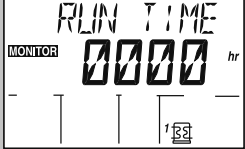
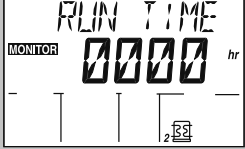
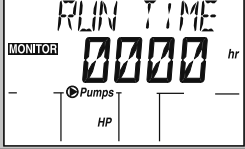
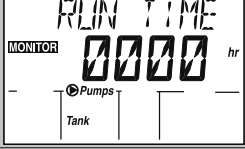



The Monitor menu items provide information about the system's operation and performance. To clear any item back to default, press and hold the Up and Down buttons while viewing that item.

Item Field	Range	Description
 <p>MONITOR Outdoor Low 5°F</p>	<p>-76 to 149°F (-60.0 to 65.0°C)</p> <p><b>Access:</b> User</p>	<p><b>OUTDOOR LOW</b> Records the lowest outdoor temperature since the item was last reset. Press and hold the Up and Down buttons while viewing to reset.</p>
 <p>MONITOR Outdoor High 78°F</p>	<p>-76 to 149°F (-60.0 to 65.0°C)</p> <p><b>Access:</b> User</p>	<p><b>OUTDOOR HIGH</b> Records the highest outdoor temperature since the item was last reset. Press and hold the Up and Down buttons while viewing to reset.</p>
 <p>MONITOR RUN TIME 0000 hr</p>	<p>0 to 9999 Hours Default = 0 hr</p> <p><b>Access:</b> User</p>	<p><b>RUN TIME (HEAT PUMP STAGE 1)</b> The total 'on' time of the Y1 relay since the item was last reset. Press and hold the Up and Down buttons while viewing to reset.</p>
 <p>MONITOR RUN TIME 0000 hr</p>	<p>0 to 9999 Hours Default = 0 hr</p> <p><b>Access:</b> User</p>	<p><b>RUN TIME (HEAT PUMP STAGE 2)</b> The total 'on' time of the Y2 relay since this item was last reset. Press and hold the Up and Down buttons while viewing to reset. <b>Note:</b> Item is only available when HP1 TYPE = WW2N, WW2H OR (HP1 TYPE = WW1N, WW1H, COMB AND HP2 TYPE = WW1N, WW1H, COMB).</p>
 <p>MONITOR RUN TIME 0000 hr</p> <p>Pumps HP</p>	<p>0 to 9999 Hours Default = 0 hr</p> <p><b>Access:</b> Installer</p>	<p><b>RUN TIME (HP LOOP PUMP)</b> The total running time of the HP Loop Pump since the item was last reset. Press and hold the Up and Down buttons while viewing to reset.</p>
 <p>MONITOR RUN TIME 0000 hr</p> <p>Pumps Tank</p>	<p>0 to 9999 Hours Default = 0 hr</p> <p><b>Access:</b> Installer</p>	<p><b>RUN TIME (TANK PUMP)</b> The total running time of the Tank System Pump since this item was last reset. Press and hold the Up and Down buttons while viewing to reset.</p>
 <p>MONITOR RUN TIME 0000 hr</p> <p>Aux</p>	<p>0 to 9999 Hours Default = 0 hr</p> <p><b>Access:</b> Installer</p>	<p><b>RUN TIME (AUXILIARY)</b> The total 'on' time of the Backup relay since the item was last reset. Press and hold the Up and Down buttons while viewing to reset. <b>Note:</b> Item is only available when BACKUP = AUX.</p>

## Heat Pump Control, cont.

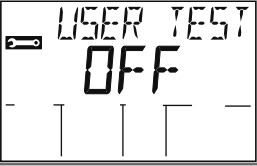
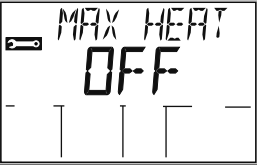
### Toolbox Menu

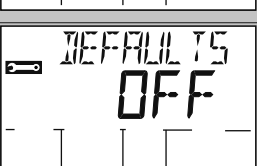
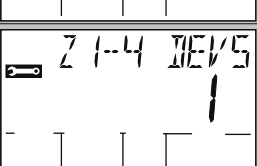
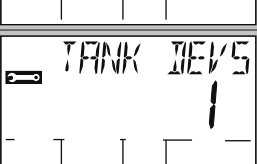
The Toolbox Menu is a location for system information and Test functions. If any errors are present on the system, they will be located at the beginning of this menu.

Item Field	Range	Description
	ON or OFF Default = OFF <b>Access: Installer</b>	<b>USER TEST</b> Begins the test routine which tests the main control's functions. See the Testing the Control section for more details. Use the up button to turn the User Test On.
	ON or OFF Default = OFF <b>Access: Installer</b>	<b>MAX HEAT</b> When selected, control operates the system up to maximum set temperatures. Will operate up to 24 hours, or can be manually turned Off. See the Max Heat section for more details.
	Flashes Between J12 09A to 09Z <b>Access: User</b>	<b>TYPE AND SOFTWARE VERSION</b> Displays the type number of the product, followed by the current software version beneath.
	INST (Installer) or USER Default = INST <b>Access: User</b>	<b>ACCESS LEVEL</b> Selects the access level of the control, which determines the Menu items available. USER provides the most limited level of access and shows the fewest possible items. When set to USER, all thermostats are locked and the number of thermostat settings available are reduced.
	OFF, SEL Default = Off <b>Access: Installer</b>	<b>FACTORY DEFAULTS</b> Loads the factory default settings. Hold the Up and Down buttons for 1 second until SEL is shown.
	0 to 4 devices <b>Access: Installer</b>	<b>ZONE 1-4 DEVICES</b> Displays the number of tN2 thermostats connected to the House Control on zones 1-4. These thermostats could be assigned to be on the Tank, Mix or Boil bus.
	0 to 24 devices <b>Access: Installer</b>	<b>TANK DEVICES</b> Displays the number of devices connected to the Tank bus expansion terminals, tN4 and C.
	See Troubleshooting Guide <b>Access: Installer</b>	<b>HISTORY 1-5</b> Displays a history of any past errors that have occurred on the system. Will clear after 30 days, or press Up and Down buttons for 1 second to manually clear. The last 5 history items will display if present.

# Heat Pump Control, cont.

## Heat / Cool Operation

### Mode

There are five different modes that the heat pump and backup can operate in. Use the MODE setting in the Adjust Menu to select one of the following modes:

### AUTO

The heat pump and backup will automatically switchover between heat and cool mode.

### COOL

While in cool mode, the heat pump will satisfy any cooling calls. "Cool" is displayed in the Mode status field while in cool mode.

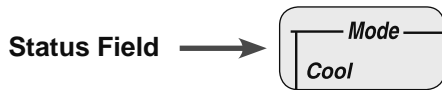

### HEAT

While in heat mode, the heat pump will satisfy any heating calls from the zones. The backup will operate automatically to satisfy calls for heat. "Heat" is displayed in the Mode status field while in heat mode.

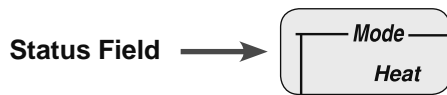

### BKUP (Backup)

While in backup mode, the heat pump is disabled. The backup will operate automatically to satisfy calls for heat. "Backup" is displayed in the Mode status field while in backup mode.



### OFF

While in off mode, the heat pump and backup are disabled.

### Interlock Delay

The interlock delay is the minimum time between heat/cool switchovers while in the AUTO mode. Use the INTERLOCK setting in the Adjust Menu to select an interlock time between 10 minutes and 180 minutes.

### Switchover

Switchover is determined by polling the thermostats. When enough thermostats are calling for the opposite mode and the interlock delay has elapsed, a switchover will occur. This ensures that the system actually requires the new tank mode before switching over. Switchover includes purging and preheat or precool.

### Purging

Once Switchover begins, the heat pump is forced off. All zones that are off remain off and all zones that become satisfied and turn off also remain off. The remaining zones are allowed to continue calling for 30 minutes or until the tank temperature changes by 15°F (8°C). This allows the tank to be purged before the heat pump is allowed to switch modes and reverse the water temperature of the tank. While this is happening, the words "PURGING HEAT" or "PURGING COOL" will be displayed in the view menu depending if the tank is currently in the heat or cool mode.

### Pre-Heat or Pre-Cool

Once the purging has completed, the heat pump is allowed to preheat or precool the tank. All zones are prevented from calling for 30 minutes or until the tank temperature reaches within 10°F (5.5°C) of its new target. This allows time for the heat pump to switch the tank temperature to its new target before turning on zones again.

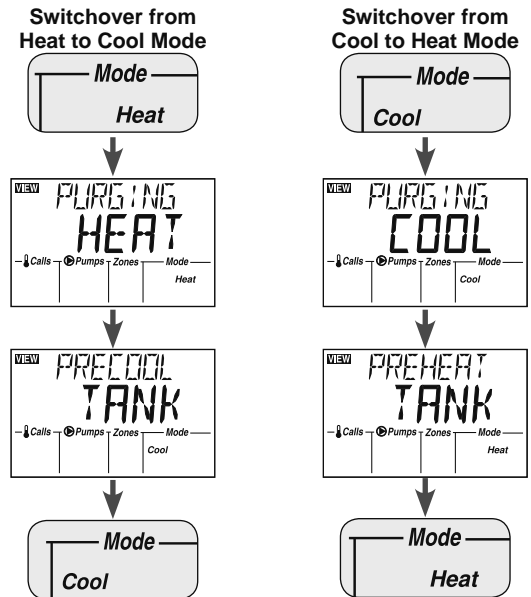

# Heat Pump Control, cont.

## Hydronic Operation

### Hydronic Heat & Cool Calls

When a thermostat, or other HydroLogic device calls for heating or cooling, the Heat Pump Control will register the call on the corresponding bus and display the call in the “Calls” box of the status field. Calls for heating or cooling come from the tank bus.

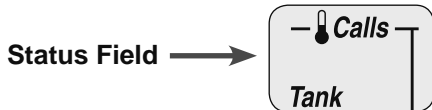

### Cool Setpoint

For a cooling call other than floor cooling, the Heat Pump Control will operate the bus at an adjustable cooling setpoint. Use the COOL SETP setting in the Adjust Menu to select a cooling setpoint.

### Outdoor Temperature Reset

Once a space heating call is present, the target water temperature for that bus is determined using outdoor temperature reset together with indoor temperature feedback from the thermostats. A heating curve is used for each bus to determine the outdoor temperature reset calculation. The heating curve operates based on the principle that a buildings heat loss increases with colder outdoor temperatures. See the default heating curves for each bus below:

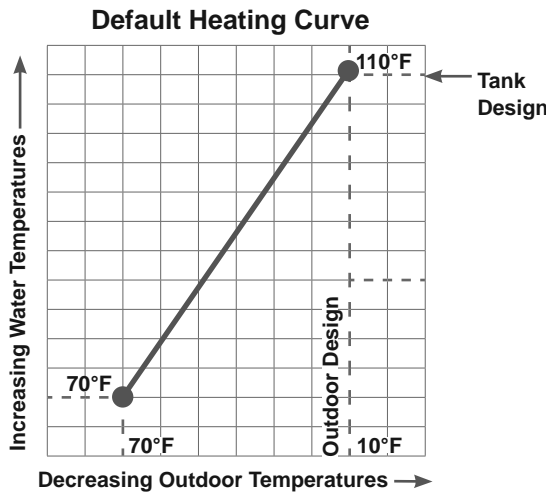

### Warm Weather Shut Down (WWSD)

During warmer weather, heating of the rooms is typically no longer required. To prevent energy waste from unnecessary heat pump and backup operation, the control goes into Warm Weather Shut Down (WWSD) when the outdoor temperature rises above the WWSD temperature. Use the WWSD OCC and WWSD UNOC settings in the Adjust Menu to set an appropriate WWSD temperature.

### Outdoor Design

The outdoor design is the lowest outdoor temperature on the typical coldest day of the year. At this outdoor temperature, the heating curve will calculate the design water temperature to be the target. Use the OUT DSGN setting in the Adjust Menu to select an appropriate outdoor design temperature for your city.

### Design Water Temperature

The Heat Pump Control will target the design water temperature when the outdoor temperature reaches the outdoor design. These two parameters set the upper point for each heating curve. Adjust the TANK DSGN settings in the Adjust Menu.

### Tank Minimum

The TANK MIN settings in the Adjust Menu set the lowest water temperature that the control is allowed to use as the tank target. It is useful to set a minimum target water temperature when using a fan coil to prevent blowing cold air into the room.

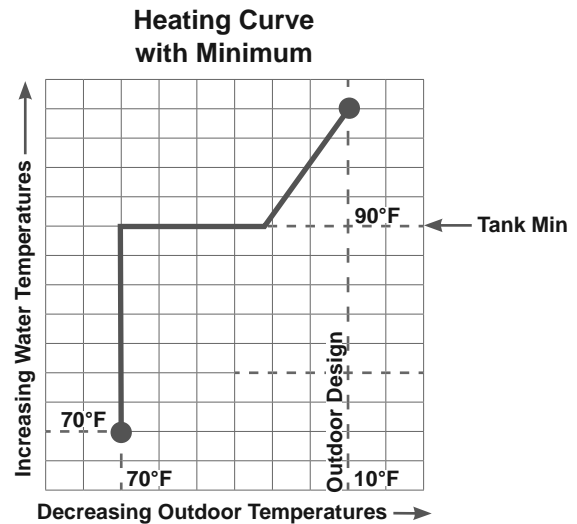

### Maximum Target

The highest water temperature that the control is allowed to use as the tank target is the TANK DSGN temperature.



## Heat Pump Control, cont.

### Heat Pump Operation

#### Equal Run Time Rotation

If the system has two heat pumps that require equal run time, set the ROTATION setting to ON. This way the two heat pumps will rotate their starting order when one heat pump accumulates 48 hours more run time than the other.

#### Staging

The Heat Pump Control will stage on sequentially, but turns off both stages at once. This allows the ground to naturally recover better since there are longer periods of time between the heat pump transferring heat to or from the ground source.

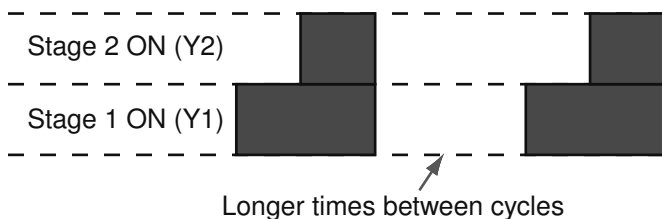

#### Stage Delay

The Heat Pump Control stages two heat pumps or a two-stage heat pump automatically. A manual stage delay can also be set between 2 and 20 minutes which forces the second stage to remain off for this adjustable amount of time. Use the HP2 DELAY setting in the Adjust Menu to select either an automatic or manual stage delay when two heat pump stages have been configured.

#### O/B Switchover

Depending on the manufacturer, a heat pump may be designed to satisfy a dominant heating load or dominant cooling load. A reversing valve on the heat pump is used to switch between heating and cooling and is energized with either an O or B terminal on the heat pump. The Heat Pump Control has an O/B output which can operate in the following ways:

- O = Heat pump normally operates in heat mode. Energize O to operate the heat pump in cool mode
- B = Heat pump normally operates in cool mode. Energize B to operate the heat pump in heat mode

Use the SWITCHOVR setting in the Adjust Menu to select the proper operation of the O/B terminal.

### Backup Delay

To allow the heat pump to operate at full output for some adjustable amount of time before the backup heat source is allowed to come on, a backup delay is used. Use the BKUP DLY setting in the Adjust Menu to set an appropriate backup delay time. When OVR is selected, the backup source will not be called upon for heat unless the MODE is set to BKUP or the heat pump is locked out on high return temperature or outdoor temperature. This ensures that the heat pump is being used to its full potential during heating.

### Cooling

During cool weather, cooling of the rooms is typically no longer required. The control shuts down the heat pump when the outdoor temperature falls below an adjustable temperature to prevent energy waste from unnecessary heat pump operation during cooling. Use the Y COOLING CWSD setting in the Adjust Menu to set the low outdoor air temperature limit for cooling.

**Note:** the CWSD icon is displayed in status field of the display when the outdoor temperature falls below either the BALNCE PT or Y COOLING CWSD settings in the Adjust Menu.



### Heat Pump Differential

The differential operates by closing the Y1 contact when the tank water temperature is the differential below the tank target. As the tank temperature reaches the tank target, the Y1 contact is opened, turning the heat pump off.

### Pump Operation

The Heat Pump Control operates six different pump outputs on the back side of the enclosure. The "Pumps" box in the status field indicates which pumps are operating at any given time.

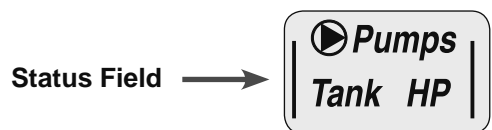

### Pump Exercising

The control operates each pump every three days for 10 seconds to help prevent corrosion and/or precipitate build up that would cause the pump to seize. The control ensures that no heat is supplied to the zones during exercising.

## Expansion Panel Control - Installation

### Introduction

The HLP313 is designed to operate up to four zone valves in a hydronic heating system. It can be mounted in the mechanical room or near a remote zone manifold, providing a convenient location to wire both thermostats and zone valves while only requiring two wires to be run back to the mechanical room. When combined with tekmarNet@2 Thermostats, all devices communicate to provide a synchronized end switch that reduces cycling of equipment.

### Features

- Four 24 V (ac) powered zone outputs
- For use with tekmarNet@2 Thermostats
- Supports two-stage tekmarNet@2 Thermostats
- tN4 expansion terminals
- External diagnostic LEDs
- CSA C US Certified for use in USA and Canada

### Benefits

- Simple, convenient wiring location
- Compact enclosure for flexible installation
- Reduce equipment cycling through the use of tekmarNet@2 Thermostats

### Installation



**WARNING:** Improper installation and operation of this control could result in damage to the equipment and possibly even personal injury or death. It is your responsibility to ensure that this control is safely installed according to all applicable codes and standards. This electronic control is not intended for use as a primary limit control. Other controls that are intended and certified as safety limits must be placed into the control circuit. Do not attempt to service the control. Refer to qualified personnel for servicing. There are no user serviceable parts. Attempting to do so voids warranty and could result in damage to the equipment and possibly even personal injury or death.

### Radio Frequency Interference

The installer must ensure that this control and its wiring are isolated and/or shielded from strong sources of electromagnetic noise. Conversely, this Class B digital apparatus complies with Part 15 of the FCC Rules and meets all requirements of the Canadian Interference-Causing Equipment Regulations. However, if this control does cause harmful interference to radio or television reception, which is determined by turning the control off and on, the user is encouraged to try to correct the interference by re-orientating or relocating the receiving antenna, relocating the receiver with respect to this control, and/or connecting the control to a different circuit from that to which the receiver is connected.



### Preparation

#### Tools Required

- Jeweller screwdriver
- Phillips head screwdriver
- Needle-nose pliers
- Wire stripper

#### Materials Required

- (2) #10 x 1" wood screws
- (2) wire nuts
- 18 AWG LVT solid wire (low voltage connections)
- 14 AWG solid wire (line voltage connections)
- tekmar 009 (24 V (ac) transformer)
- Cable or conduit connectors

#### Power Required

- 120 V (ac), 1-phase, 15 A service from circuit breaker panel
- Power disconnect (optional)

### Installation Location

When choosing the location for the control, consider the following:

- Keep dry. Avoid potential leakage onto the control. RH  $\leq$  90% to 122°F (50°C) in a non-condensing environment.
- Do not expose to operating temperatures beyond 32 - 122°F (0-50°C).
- Provide adequate ventilation.
- Keep away from equipment, appliances or other sources of electrical interference.
- Locate the control near zone valves if possible.
- Provide easy access for wiring and viewing the control.
- Mount approximately 5 ft. (1.5 m) off the finished floor.
- Install to wall using #10 x 1" wood screws. Wall anchors are recommended when mounting to sheet rock, wallboard or masonry.

# Expansion Panel Control - Dimensional Data

Front View

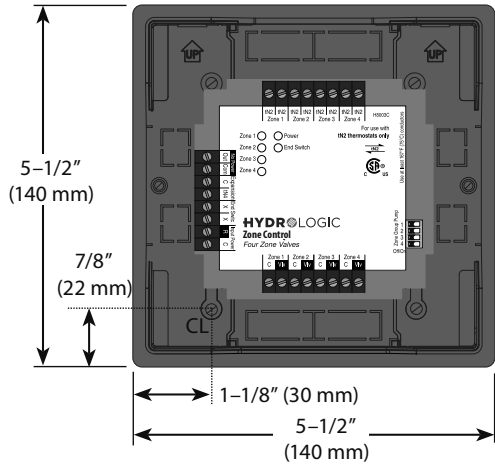

Side View

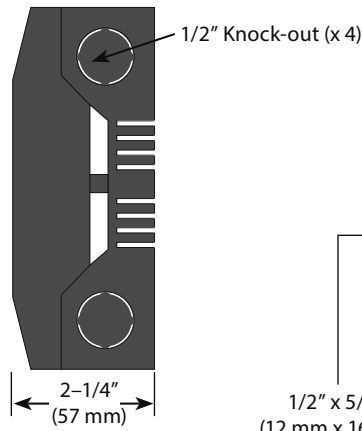

Back View

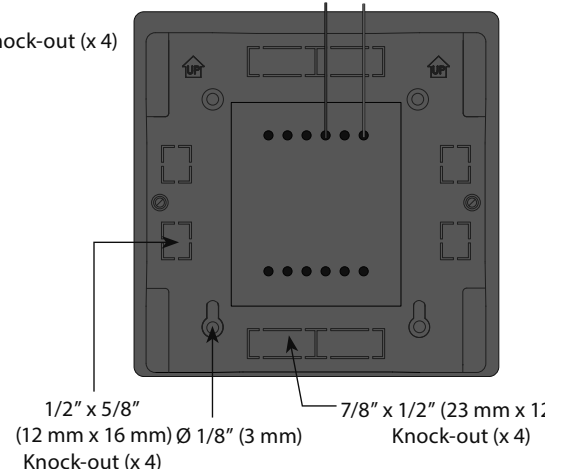

# Expansion Panel Control Wiring

## Rough-in Wiring

### Line Voltage Wiring

In most cases, the control can be mounted directly to a wall without the need for any line voltage connections. As an option, the control may be mounted to a 4" x 4" electrical junction box so that the high voltage electrical connections for the transformer are safely contained. For ease of service, the circuit breaker or power disconnect should be located in reasonably close proximity to the equipment. All line voltage wire connections are recommended to be pulled inside a flexible or solid conduit. Always follow proper wiring practices, building and electrical codes for your jurisdiction. Each cable must be pulled to the electrical junction box. It is recommended to label each cable for easy identification. All line voltage wires should be stripped to a length of 1/2" (13 mm). Pull a three conductor 14 AWG cable for the following equipment:

- Circuit Breaker or Power Disconnect (if applicable)

### Low Voltage Wiring

Each cable must be pulled from the equipment to the control's plastic enclosure. All low voltage wiring connections enter the enclosure through conduit knockouts on the sides, or through the square knockouts on the rear. It is recommended to label each cable for easy identification. All low voltage wires are to be stripped to a length of 3/8" (9 mm) to ensure proper connection to the control. **Pull two conductor 18 AWG LVT cable, up to 500 feet (150 m) for the following equipment**

- HydroLogic Thermostats
- 24 V (ac) Power
- Zone Valves

## Control Wiring

### Line Voltage Wiring



**CAUTION: TURN ALL POWER OFF BEFORE PERFORMING ANY WIRING.**

#### Wire the Grounds

- Connect the power supply ground to the electrical box as shown in Figure 1.

#### Wire the Neutrals (N)

- Connect the 115 V (ac) neutral (N) wire to the 115 V (ac) side of the transformer. Use a wire nut or approved connector. See Figure 1.

#### Wire the Power

- Connect the 115 V (ac) line voltage (L) wire to the 115 V (ac) side of the transformer. Use a wire nut or approved connector. See Figure 1.

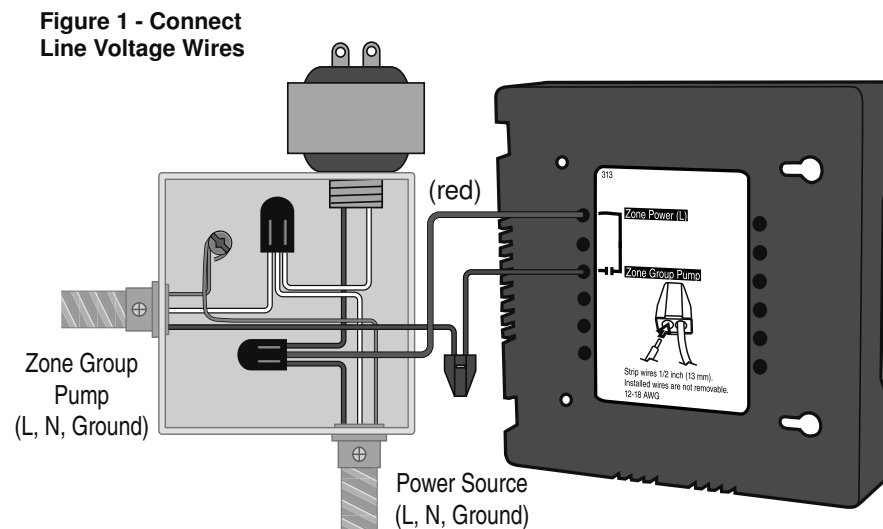

## Expansion Panel Control Wiring, cont.

### Install the Enclosure

- The enclosure may be mounted directly to a wall or to an electrical junction box.
- Ensure that the high voltage wires are neatly tucked inside the electrical junction box.
- Using 2 of the 4 holes in the back of the enclosure, securely fasten it to the electrical junction box with 2 #10 screws as shown in Figure 2.

Figure 2

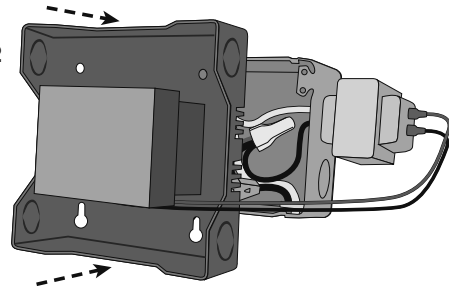

### Low Voltage Wiring

#### External Power Supply

It is strongly recommended that a transformer with an in-line fuse be used in order to protect the transformer from high currents. The HLP733 Transformer includes a fuse. Connect the 24 V (ac) leads from the transformer to the C and R terminals marked "Input Power" on the 313.

#### HydroLogic Thermostats

The HLP313 is designed to operate with HydroLogic Thermostats. They provide the heating and cooling control for each zone, and communicate with any other HydroLogic device on the system.

- Connect the tN2 terminals from each thermostat to the corresponding tN2 terminals for each zone on the HLP313.

#### Zone Valves

- Wire the zone valves to the C and Vlv terminals on the HLP313.
- End switches on zone valves are not required when using the HLP313.

#### tN4 Expansion Terminals

The HLP313 uses the Expansion tN4 and C terminals to communicate with HLP406, and other HydroLogic devices.

- Connect the tN4 and C Expansion terminals on the HLP313 to the corresponding tN4 and C Expansion terminals of the HLP406.

### 2 Stage TP42H01 Thermostat Wiring

A two stage TP42H01 thermostat is automatically detected when connected to Zone 1 or Zone 3. If there is no tN2 thermostat connected to Zone 2 or Zone 4, these outputs will automatically operate the heating equipment for second stage heat.

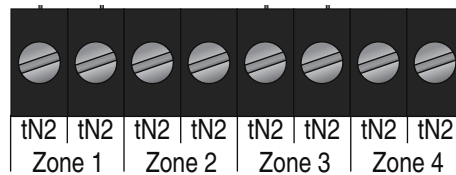

Two-Stage Terminal Designation			
Zone 1		Zone 3	
Stage 1	Stage 2	Stage 1	Stage 2

## Expansion Panel Control Wiring, cont.

### Testing the Control Wiring

#### Testing the Power

In most cases, the control can be mounted directly to a wall without the need for any line voltage connections. As an option, the control may be mounted to a 4" x 4" electrical junction box so that the high voltage electrical connections for the transformer are safely contained. For ease of service, the circuit breaker or power disconnect should be located in reasonably close proximity to the equipment. All line voltage wire connections are recommended to be pulled inside a flexible or solid conduit. Always follow proper wiring practices, building and electrical codes for your jurisdiction. Each cable must be pulled to the electrical junction box. It is recommended to label each cable for easy identification. All line voltage wires should be stripped to a length of 1/2" (13 mm). Pull a three conductor 14 AWG cable for the following equipment:

- Circuit Breaker or Power Disconnect (if applicable)

#### Testing the Thermostat

If the thermostat display turns on, this indicates that the thermostat is operating correctly and there are no electrical issues. In the event that the display is off, or the display is cycling on and off, follow this procedure.

1. Remove the tN2 wires from the thermostat.
2. Use an electrical meter to measure DC voltage between the tN2 terminals.

If the DC voltage is 0 V (dc) for 20 seconds, then there is an open or short circuit in the tN2 wires. If the DC voltage is 0 V (dc) for 10 seconds and then is 23 to 24 V (dc) for 5 seconds, this indicates the wiring is correct.

3. Connect the thermostat to the tN2 wires from a zone on a HLP406 or HLP313.
4. If the thermostat display is off, or is cycling on and off, move the thermostat to the next available zone on the HLP406 or HLP313.

If the thermostat display remains permanently on, there may be a fault with the previously tried zone on the HLP406 or HLP313.

If the thermostat display continues to be off, or is cycling on and off, there may be a fault on the thermostat.

If a fault is suspected, contact your tekmar sales representative for assistance.

#### Testing the Zone Output

1. Use an electrical test meter to measure the (ac) voltage between the C and the Vlv terminals for each zone valve output.

- Lower the thermostat temperature setting. When the zone LED is off, the reading should be 0 V (ac) and the valve should be closed.
- Raise the thermostat temperature setting. When the zone LED is on, the reading should be 24 V (ac) + / - 10% and the valve should be open.

**Note:** If power to the zone valve is present but the zone valve does not operate properly, refer to any troubleshooting information supplied by the zone valve manufacturer.





#### Testing the Expansion

To test the tN4 Network, check the wires for continuity and shorts.

1. Disconnect the two tN4 expansion wires (tN4 and C) at one end and twist them together.
2. Go to the other end of the wires and disconnect them.
3. Using an electrical test meter, check for continuity. Resistance should read 0 ohms, or continuity should produce a tone. If not, this indicates that there are damaged wires connecting the HLP406 control to the HLP313. Repair or replace the wires as necessary.
4. Go back to the original end of the wires and, using a wire nut, cap each expansion wire individually so that these ends cannot touch another conductor.
5. Go to the other end of the wires and again, test for shorts. Resistance should be infinite, or O.L. and there should be no tone. If tone exists or less than 50 000 ohms is found, then the wires are not insulated from one another. This is generating a short on the wires connecting the HLP406 control to the HLP313.
6. Replace the damaged wires, test, and reconnect them to their proper terminals

## Expansion Panel Control - User Interface

### LED's

	<p><b>ZONE 1</b> The zone 1 thermostat is calling for heat and the 24 V (ac) output is energized.</p>
	<p><b>ZONE 2</b> The zone 2 thermostat is calling for heat and the 24 V (ac) output is energized.</p>
	<p><b>ZONE 3</b> The zone 3 thermostat is calling for heat and the 24 V (ac) output is energized.</p>
	<p><b>ZONE 4</b> The zone 4 thermostat is calling for heat and the 24 V (ac) output is energized.</p>
	<p><b>POWER</b> 24 V (ac) is being applied to the Wiring Center to provide it with power.</p>

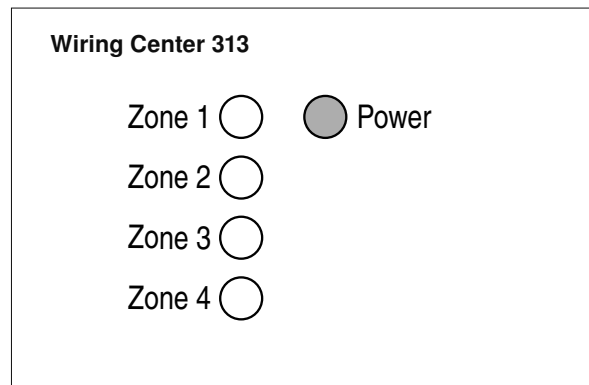

### Zone LED Flashing

The zone has an open or short circuit and communication to the thermostat on the zone has been interrupted. Check the wiring between the thermostat and the HLP313 for open or short circuits. If the thermostat was intentionally removed, power the HLP313 off for 10 seconds.

## Expansion Panel Control - Sequence of Operation

### HydroLogic System

HydroLogic is a family of products that use communication to operate the HVAC system in a comfortable and efficient manner. The HLP313 is a zoning component in a HydroLogic system and requires HydroLogic (tN2) Thermostats to be directly connected to it.

The HydroLogic (tN4) Expansion terminals can link the HLP313 with other HydroLogic components:

- HLP406

### Relay Outputs

#### End Switch Operation

All communication messages will pass through the HLP313's tN4 expansion connection. tN4 messages are required in order to create a demand on the HLP406 Control.

#### 24 V (ac) Zone Relay Operation

When a thermostat calls for heat, it sends a message to the Wiring Center and the corresponding zone LED turns on. Power is then supplied to the appropriate zone output as indicated by the LED.

## Expansion Panel Control - Sequence of Operation, cont.

### Energy Savings Features

#### Network Schedules

Adding a schedule to a HydroLogic system is both easy and valuable. The TP42H01 and TP10H01 provides scheduling with up to 4 events per day. Sharing of the schedules is available including the non-programmable TA10H01. Turning down the room temperatures when they are unoccupied reduces boiler on-time and energy consumption which helps save money and the environment.

1. Remove the tN2 wires from the thermostat.
2. Use an electrical meter to measure DC voltage between the tN2 terminals.

If the DC voltage is 0 V (dc) for 20 seconds, then there is an open or short circuit in the tN2 wires. If the DC voltage is 0 V (dc) for 10 seconds and then is 23 to 24 V (dc) for 5 seconds, this indicates the wiring is correct.

3. Connect the thermostat to the tN2 wires from a zone on a HLP406 or HLP313.
4. If the thermostat display is off, or is cycling on and off, move the thermostat to the next available zone on the HLP406 or HLP313.

If the thermostat display remains permanently on, there may be a fault with the previously tried zone on the HLP406 or HLP313.

If the thermostat display continues to be off, or is cycling on and off, there may be a fault on the thermostat.

If a fault is suspected, contact your tekmar sales representative for assistance.

#### Zone Synchronization





The Wiring Center includes an energy saving feature called Zone Synchronization. In typical zoned systems, the thermostats operate on a stand-alone basis. This means that a zone turns on and off as required without any regard for other zones. The net effect is random operation of the zones causing short cycling of the heat source. HydroLogic thermostats communicate to ensure that their cycles are synchronized. Energy is saved by ensuring zones requiring heat operate on the same cycle, therefore reducing short cycling of the boiler.

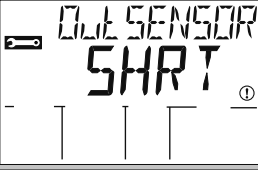
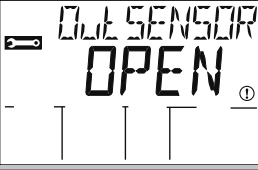

## Control Troubleshooting

It is recommended to complete all wiring to ensure trouble free operation. Should an error occur, simply follow these steps:

1. **Find:** If the House Control or Thermostat flashes ① on the screen, it is indicating a problem on the system.
2. **Identify:** Use the Menu button to locate the Toolbox Menu. The Error code should appear as the first item.
3. **Solve:** Using the lookup chart below, match the Error code to the one on the control. Use the Description in the chart to solve the problem.

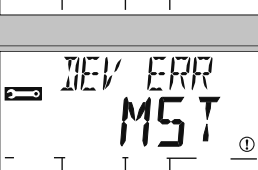
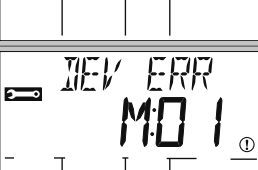
Error Message	Description
	<p><b>ADJUST ERROR</b></p> <p>The control failed to read the Adjust menu settings, and reloaded the factory default settings. Operation stops until all the Adjust menu settings are checked.</p> <p><b>Note:</b> To clear the error, the access level must be set to Installer and each setting in the Adjust menu must be checked.</p>
	<p><b>OUTDOOR SENSOR SHORT CIRCUIT</b></p> <p>Due to a short circuit, the control failed to read the outdoor sensor. As a result, the control assumes an outdoor temperature of 32°F (0°C) and continues operation. Locate and repair the problem as described in the “Test the Sensor Wiring” section.</p>
	<p><b>OUTDOOR SENSOR OPEN CIRCUIT</b></p> <p>Due to an open circuit (disconnected or broken wire), the control failed to read the outdoor sensor. As a result, the control assumes an outdoor temperature of 32°F (0.0°C) and continues operation. Locate and repair the problem as described in the “Test the Sensor Wiring” section.</p>
	<p><b>TANK SENSOR SHORT CIRCUIT</b></p> <p>Due to a short circuit, the control failed to read the tank sensor. The control no longer operates the heat pump or backup. Locate and repair the problem as described in the “Test the Sensor Wiring” section.</p>
	<p><b>TANK SENSOR OPEN CIRCUIT</b></p> <p>Due to an open circuit (disconnected or broken wire), the control failed to read the tank sensor. The control no longer operates the heat pump or backup. Locate and repair the problem as described in the “Test the Sensor Wiring” section.</p>
	<p><b>TANK DEVICE LOST (T:01 TO T:24)</b></p> <p>Each device (thermostat, setpoint control, timer) has an address. The device with this address on the tank water temperature is no longer reporting back to the Heat Pump Control.</p> <p>The device can be located by either the address, or by going to each device in the building, checking that the LCD is on, and the communication symbol is on. Trace the wires from the control to the lost device looking for loose or damaged wires.</p> <p><b>Note:</b> If you deliberately remove a device, hold the Up and Down buttons to clear this error.</p>
	<p><b>MASTER DEVICE ERROR</b></p> <p>More than one master has been detected on the 4 expansion terminals. The Heat Pump Control is a “Master Device” and no other reset controls can be added to the 4 expansion terminals. If one has been added, remove it from the system.</p>
	<p><b>DEVICE ERROR AT ADDRESS M:01 to M:24</b></p> <p>Each device (thermostat, setpoint control, timer) has an address. One of the devices on the mix water temperature has an error. If there is a record of the device address together with the room name, go to that device to correct the error. Otherwise, go to each device in the building, checking for the flashing Warning symbol. Once the error on the device is corrected, the error message will clear.</p>

## Control Troubleshooting, cont.

Symptom	Look For...	Corrective Action
LCD display is off	Fuse holder	Control power supply has a 24 V (ac) fuse which if blown, requires replacement.
	Power to control	Use electrical meter to measure 24 V (ac) voltage on input power R and C terminals.
No central heating	Heat pump symbol on LCD	If the heat pump symbol is on the LCD, there is a problem with the heat pump. Check the heat pump for faults or reference the manufacturers' literature.
	WWSD symbol on LCD	Warm Weather Shut Down (WWSD) is an energy saving feature that prevents central heating during the summer. Ensure the outdoor temperature reading is accurate and replace outdoor sensor if necessary. WWSD setting can be increased if heating is required.
	Tank Calls on LCD	If there are no Tank Calls, there are no thermostats calling for heat.
	System in AWAY	During AWAY, the thermostats operate at a lower temperature. Locate a 'User Switch' and set to Normal to resume heating.
	MODE setting	The mode of the Heat Pump Control can be set to Auto, Backup, or Off. For central heating to occur, ensure the mode is set to either Auto, or Backup.
No central cooling	Cool outdoor air temperature	The heat pump is prevented from operating due to low outdoor air temperature. Adjust the Y COOLING CWSD setting to an appropriate outdoor temperature to stop cooling.
	Tank Calls on LCD	If there are no Tank Calls, there are no thermostats calling for cooling.
	System in AWAY	During AWAY, the thermostats operate at a higher temperature. Locate a 'User Switch' and set to Normal to resume heating.
	MODE setting	The mode of the Heat Pump Control can be set to Auto, Backup, or Off. For central cooling to occur, ensure the mode is set to Auto.
Single zone over heating	LCD shows zone on	Thermostats have a differential of +/- 1.5°F of the temperature setting. Due to the display rounding numbers up, heating can appear on when the temperature is 2°F above the setting. This is normal operation.
	LCD shows zone off	Ensure zone valve terminals measure 0 V (ac). Measuring 0 V (ac) indicates mechanical zone valve may have failed in open position. Measuring 24 V (ac) indicates control relay may have failed.
Single zone under heating	LCD shows zone on	Ensure zone valve terminals measure 24 V (ac). Measuring 24 V (ac) indicates mechanical zone valve may have failed in closed position. Measuring 0 V (ac) indicates control relay may have failed.
	LCD shows zone off	Check for calls

## Control Troubleshooting, cont.

### Testing the Sensor Wiring

A good quality test meter capable of measuring up to 5,000 kΩ (1 kΩ = 1000 Ω) is required to measure the sensor resistance. In addition to this, the actual temperature must be measured with either a good quality digital thermometer, or if a thermometer is not available, a second sensor can be placed alongside the one to be tested and the readings compared.

First measure the temperature using the thermometer and then measure the resistance of the sensor at the control. The wires from the sensor must not be connected to the control while the test is performed. Using the chart below, estimate the temperature

measured by the sensor. The sensor and thermometer readings should be close. If the test meter reads a very high resistance, there may be a broken wire, a poor wiring connection or a defective sensor. If the resistance is very low, the wiring may be shorted, there may be moisture in the sensor or the sensor may be defective. To test for a defective sensor, measure the resistance directly at the sensor location.

**Do not apply voltage to a sensor at any time as damage to the sensor may result.**

Temperature		Resistance	Temperature		Resistance	Temperature		Resistance	Temperature		Resistance
°F	°C	Ω	°F	°C	Ω	°F	°C	Ω	°F	°C	Ω
-50	-46	490,813	20	-7	46,218	90	32	7,334	160	71	1,689
-45	-43	405,710	25	-4	39,913	95	35	6,532	165	74	1,538
-40	-40	336,606	30	-1	34,558	100	38	5,828	170	77	1,403
-35	-37	280,279	35	2	29,996	105	41	5,210	175	79	1,281
-30	-34	234,196	40	4	26,099	110	43	4,665	180	82	1,172
-25	-32	196,358	45	7	22,763	115	46	4,184	185	85	1,073
-20	-29	165,180	50	10	19,900	120	49	3,760	190	88	983
-15	-26	139,403	55	13	17,436	125	52	3,383	195	91	903
-10	-23	118,018	60	16	15,311	130	54	3,050	200	93	829
-5	-21	100,221	65	18	13,474	135	57	2,754	205	96	763
0	-18	85,362	70	21	11,883	140	60	2,490	210	99	703
5	-15	72,918	75	24	10,501	145	63	2,255	215	102	648
10	-12	62,465	80	27	9,299	150	66	2,045	220	104	598
15	-9	53,658	85	29	8,250	155	68	1,857	225	107	553

## Control Troubleshooting, cont.

### Testing the Power

If the control display does not turn on, check the Input Power wiring terminals using an electrical multimeter. The voltage should measure between 21.6 to 26.4 V (ac). If the voltage is below this range, measure the line voltage side of the transformer. The voltage should measure between 103.5 to 126.5 V (ac).

### Testing the Thermostats

If the thermostat display turns on, this indicates that the thermostat is operating correctly and there are no electrical issues. In the event that the display is off, or the display is cycling on and off, follow this procedure.

1. Remove the tN2 wires from the thermostat.
2. Use an electrical meter to measure DC voltage between the tN2 terminals.
3. If the DC voltage is 0 V (dc) for 20 seconds, then there is an open or short circuit in the tN2 wires. If the DC voltage is 0 V (dc) for 10 seconds and then is 23 to 24 V (dc) for 5 seconds, this indicates the wiring is correct.
4. Connect the thermostat to the tN2 wires from a zone on a House Control, Wiring Center, or Zone Manager.
5. If the thermostat display is off, or is cycling on and off, move the thermostat to the next available zone on the House Control, Wiring Center, or Zone Manager.
  - If the thermostat display remains permanently on, there may be a fault with the previously tried zone on the House Control, Wiring Center, or Zone Manager.
  - If the thermostat display continues to be off, or is cycling on and off, there may be a fault on the thermostat.
  - If a fault is suspected, contact your tekmar sales representative for assistance.

### User Test

The User Test is found in the Toolbox menu of the control. Press the Menu button to access the Toolbox Menu. Press the Item button to locate the User Test.

Start the test sequence by going to the User Test item and pressing the 'Up' arrow button.

Pause the test sequence by pressing the Item button. To advance to the next step, press the Item button again.

If the test sequence is paused for more than five minutes, the control exits the entire test routine and returns to normal operation.

To advance to a particular step, repeatedly press and release the Item button to display the appropriate device.

### User Test Sequence

- Step 1 Zone 1 turns on for 10 seconds.
- Step 2 Zone 2 turns on for 10 seconds.
- Step 3 Zone 3 turns on for 10 seconds.
- Step 4 Zone 4 turns on for 10 seconds.
- Step 5 The tank system pump turns on for 10 seconds.
- Step 6 The O/B contacts are closed for 10 seconds.
- Step 7 The HP loop pump turns on for 10 seconds.
- Step 8 The HP loop pump turns on and the Y1 contacts are closed for 10 seconds
- Step 9 The HP loop pump turns on and the Y2 contacts are closed for 10 seconds if HP TYPE = ROT.  
The HP loop pump turns on and the Y1 and Y2 contacts are closed for 10 seconds if HP TYPE = 2STG.
- Step 10 The Backup contacts are closed for 10 seconds if BACKUP = AUX.
- Step 11 Control returns to normal operation.

### Testing the Zone Output

Activate the User Test sequence and pause at Step 1 by pressing the Item button once Zone 1 turns on. Using an electrical meter, measure the voltage between the zone valve and the common (C) terminals. The voltage should measure between 21.6 V (ac) and 26.4 V (ac). Repeat for Zones 2, 3, and 4.

### Testing the Tank System Pump

Activate the User Test sequence and pause at Step 8 by pressing the Item button once the tank system pump turns on. Using an electrical meter, measure the voltage between the tank system pump and a neutral. The voltage should measure between 103.5 V (ac) and 126.5 V (ac).

### Testing the O/B Contact

Activate the User Test sequence and pause at Step 9 by pressing the Item button once the O/B contact turns on. Using an electrical meter, measure for continuity between the O/B and Rc1 terminals.

### Testing the HP Loop Pump

Activate the User Test sequence and pause at Step 10 by pressing the Item button once the HP Loop pump turns on. Using an electrical meter, measure the voltage between the HP Loop pump and a neutral. The voltage should measure between 103.5 V (ac) and 126.5 V (ac).

### Testing the Heat Pump Stage 1 Contact

Activate the User Test sequence and pause at Step 11 by pressing the Item button once the Y1 contact turns on. Using an electrical meter, measure for continuity between the Y1 and Rc1 terminals.

## Control Troubleshooting, cont.

### Testing the Heat Pump Stage 2 Contact

Activate the User Test sequence and pause at Step 12 by pressing the Item button once the Y2 contact turns on. Using an electrical meter, measure for continuity between the Y2 and Rc2 terminals.

### Testing the Backup Contact

Activate the User Test sequence and pause at Step 13 or Step 18 by pressing the Item button once the boiler stage 1 turns on. Using an electrical meter, measure for continuity over the Backup terminals.

## Expansion Panel Control - Troubleshooting

Symptom	Look For...	Corrective Action
Power LED is off	Power to control	Use electrical meter to measure 24 V (ac) voltage on input power R and C terminals.
No central heating	Zone LEDs	If there are no green Zone LEDs, there are no thermostats calling for heat.
	System in AWAY	During AWAY, the thermostats operate at a lower temperature. Locate a 'User Switch' and set to Normal to resume heating.
Single zone over heating	LED shows zone on	Thermostats have a differential of +/- 1.5°F (0.8°C) of the temperature setting. Due to the display rounding numbers up, heating can appear on when the temperature is 2°F (1°C) above the setting. This is normal operation.
	LED shows zone off	Ensure zone valve terminals measure 0 V (ac). Measuring 0 V (ac) indicates mechanical zone valve may have failed in the open position. Measuring 24 V (ac) indicates control relay may have failed.
Single zone under heating	LED shows zone on	Ensure zone valve terminals measure 24 V (ac). Measuring 24 V (ac) indicates mechanical zone valve may have failed in the closed position. Measuring 0 V (ac) indicates control relay may have failed.
	LED shows zone off	Check the thermostat to see if it is calling for heat (H1 displayed on the screen).
	Zone LED flashing	The zone has an open or short circuit and communication to the thermostat on the zone has been interrupted. Check the wiring between the thermostat and the Wiring Center for open or short circuits. If the thermostat was intentionally removed, power the Wiring Center off for 10 seconds.

## Service Parts

<b>WFI</b>	<b>Description</b>	<b>Where Used</b>
HLP377	Pump, GF, UP15-58F 115V	All 3 ton panels except zone expansion
HLP376	Pump, GF, UP26-99F 115V	All 6 ton panels except zone expansion
HLP502	Actuator, 24V, 26LC	All Units
HLP733	Transformer	All Units
HLP406	Heat Pump Control Replacement	All Units
HLP313	Zone Control Replacement	All Units

## Revision Guide

---

<b>Pages:</b>	<b>Description:</b>	<b>Date:</b>	<b>By:</b>
All	First Published	8 Jan 2016	MA

# HYDR<sup>o</sup>LOGIC

Advanced Hydronic Control Solutions

