



Raychem



TRACER

DigiTrace

TraceTek

ADVANCED INDUSTRIAL SOLUTIONS HEAT-TRACING PRODUCTS & SERVICES



ADVANCED INDUSTRIAL SOLUTIONS

As the world's largest provider of complete electrical heat management systems, primarily for the general process, oil and gas, chemical, and power generation industries, Pentair Thermal Management provides innovative products and turnkey solutions under market-leading brands—Raychem, Pyrotенax, and Tracer. Our premiere turnkey solutions include full life cycle support—ranging from front-end engineering and installation to maintenance and operation services. Our global experience and office presence in 48 countries uniquely position us to manage the heat needed for projects of any size and scope.

THE HEART OF OUR SOLUTIONS

As the inventor of self-regulating heat tracing, our Raychem brand is recognized for technical leadership in the industries we serve. Raychem cable delivers the appropriate amount of heat exactly when and where it is needed, adjusting the output produced in response to ambient and process conditions, making it ideal for heat management systems. Since inventing the technology, Pentair Thermal Management has sold over 1.6 billion feet (500,000 km) of Raychem brand self-regulating cable.

In addition to a self-regulating product set addressing a full range of temperature needs, we also offer other types of heating cables, control and monitoring solutions, and a full range of services related to our products.

The Pyrotенax brand of mineral insulated heating cables and wiring have led the industry for more than 75 years. Able to withstand extreme, harsh environments, Pyrotенax cables provide the most reliable heat-tracing solution for high-temperature applications.

The DigiTrace line of products represent the industry's most complete range of dedicated heat-tracing control and monitoring systems, from simple thermostats to advanced networked systems, with easy-to-use interface technologies that put information and programming at your fingertips.

Our Tracer Turnkey Solutions Team is widely regarded as the premiere provider of industrial turnkey heat-tracing solutions. With our full suite of services, from front-end engineering and installation to maintenance and operation services, we are capable of handling heat-tracing projects of any size and scope. By focusing on safety and utilizing time-tested methods and solutions, Pentair Thermal Management's heat-tracing designs and installations are timely, thorough, and cost-effective.

POLE TO POLE, ONE RELIABLE PARTNER IN HEAT TRACING

Raychem



TRACER

DigiTrace

TraceTek

WE MANAGE THE HEAT YOU NEED

BEFORE YOU BUY, WEIGH THE FACTS

- Widest range of heat-tracing technologies for any application
- Continuous innovation of our products and services
- Advanced line of control and monitoring systems
- Highest excellence in operations with major logistic hubs and customer service centers worldwide
- Global company with local presence—more than 2,500 employees in over 85 locations

We are the leading full-service integrator for heat management systems offering project services for complete construction, project management and maintenance and we provide total care in heat tracing.



ELECTRIC HEAT-TRACING SYSTEMS



An electrical heat-tracing system is much more than just the heating cable. Pentair Thermal Management provides a complete system including the transformer, control and monitoring panels, power connections, heating cable, end terminations, and related accessories. We manage the heat you need - from pipe freeze protection, or process temperature maintenance, to process heat-up applications.

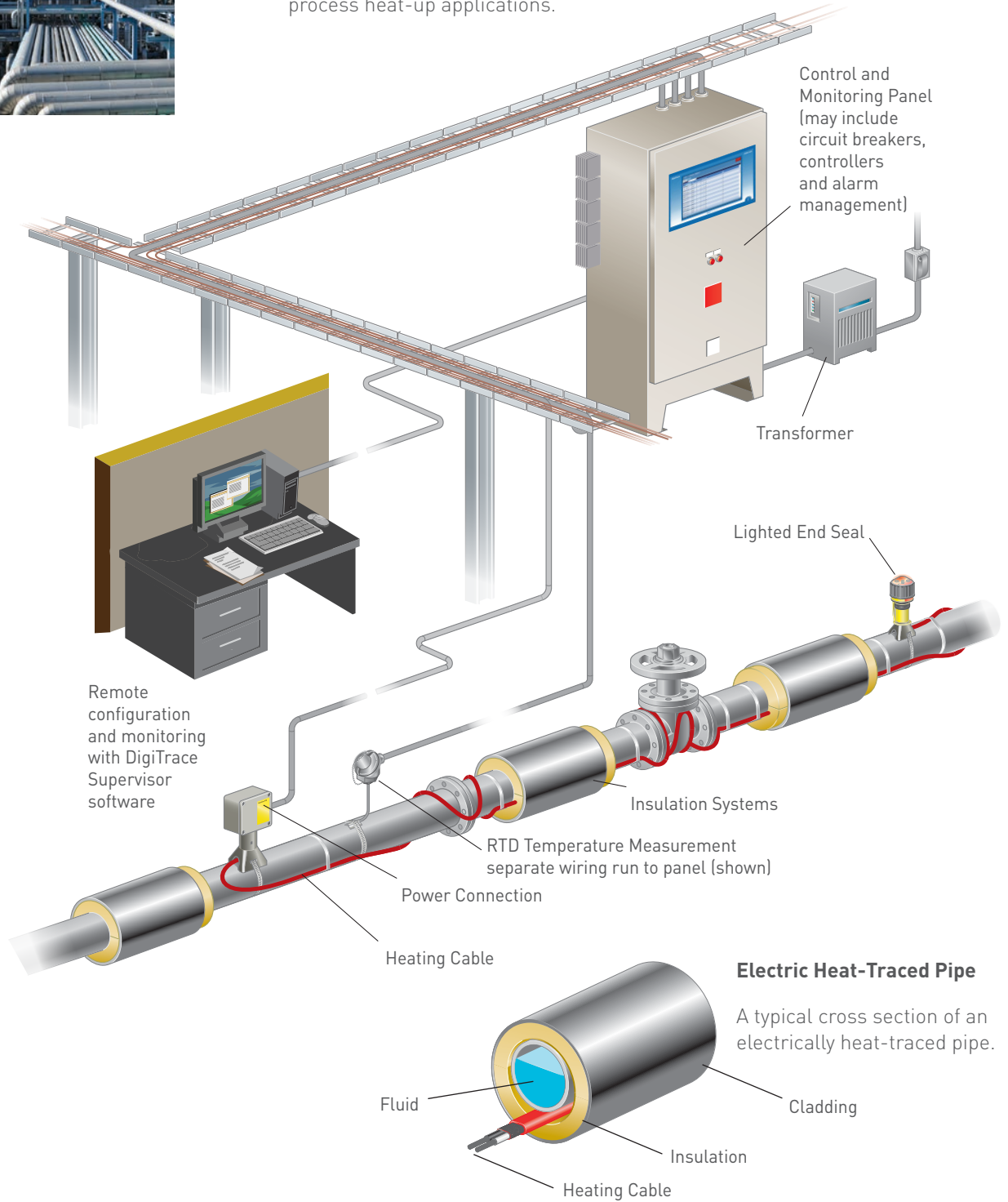

Note: The illustrations on these pages do not necessarily depict actual applications and installations.

A RICH HISTORY IN INNOVATIONS

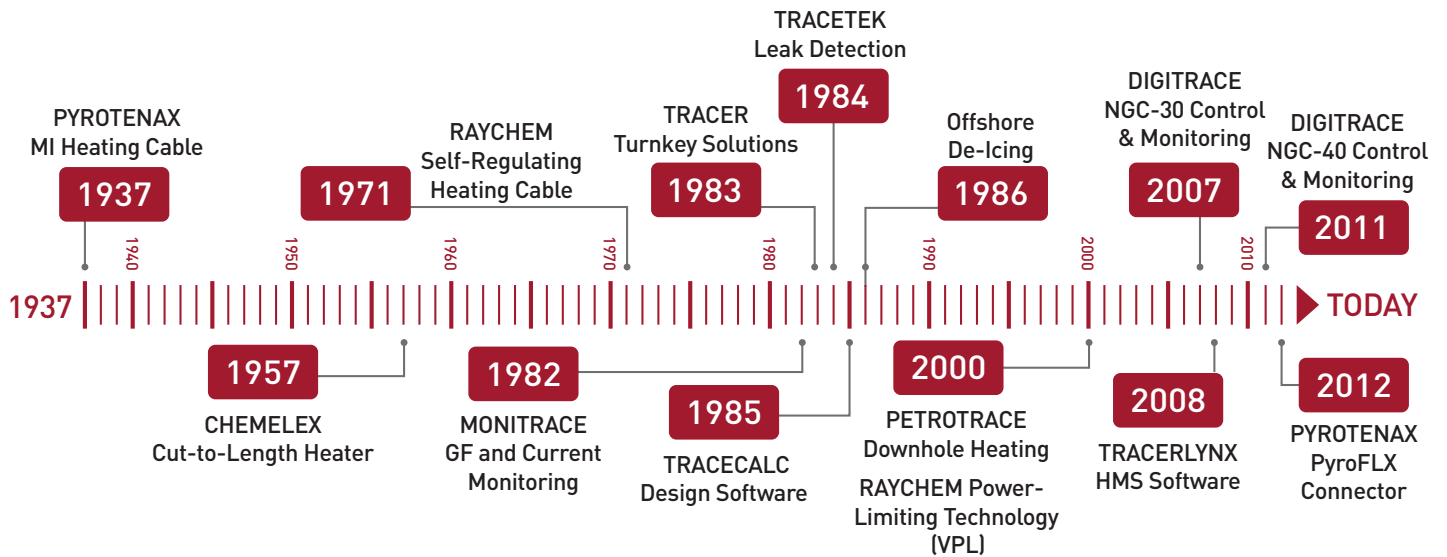

Heat Tracing



Turnkey Solutions



Control and Monitoring



Fire-Rated Wiring Products

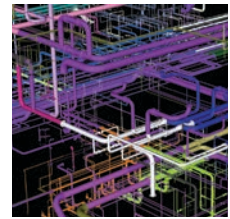

3D Plant Modeling

PRODUCT TECHNOLOGY PORTFOLIO

Pentair Thermal Management offers the industry's most complete line of heat-tracing product technologies to meet every need—for everything from pipe freeze protection to high temperature process maintenance. We provide solutions that cover a wide range of temperature and length requirements for any application.

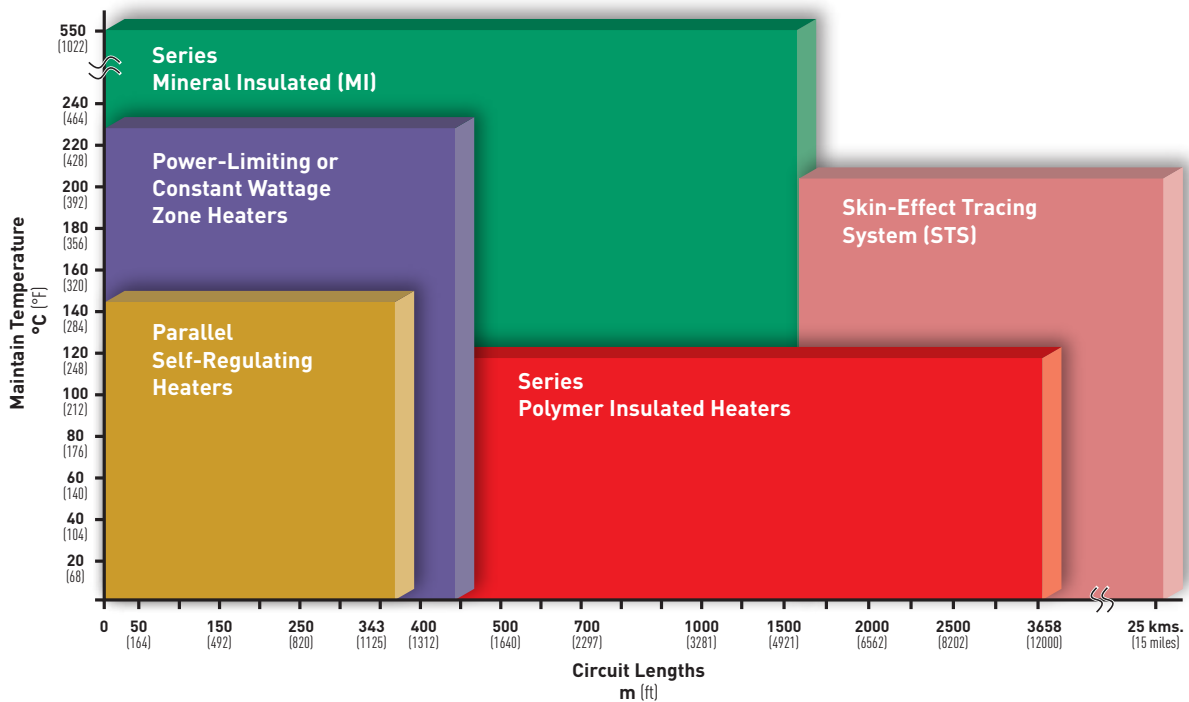

INNOVATIVE HEAT-TRACING SYSTEMS

SELF-REGULATING TECHNOLOGY

Raychem revolutionized the heat-tracing industry when it invented self-regulating heater technology over 40 years ago. Self-regulating heating cables incorporate a heating element made of polymer mixed with conductive carbon black. This special formulation of materials creates an electrical path for conducting current between the parallel bus wires along the entire cable length. In each heating cable, the number of electrical paths between the bus wires changes in response to temperature fluctuations, allowing for more uniform temperatures. Additionally, the ability to cut-to-length on site allow for easy installation.

Applications include: freeze protection, temperature maintenance, viscosity control, or anti-condensation for any process in pipes, tanks or vessels.

How it works:

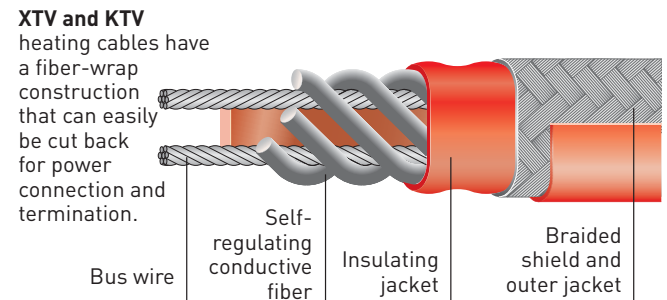
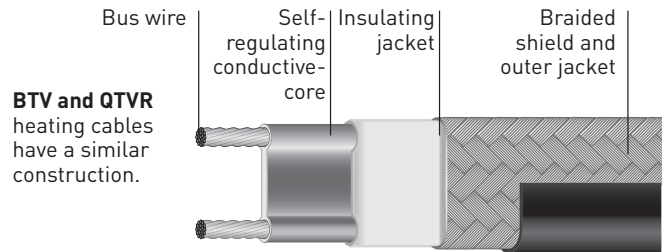
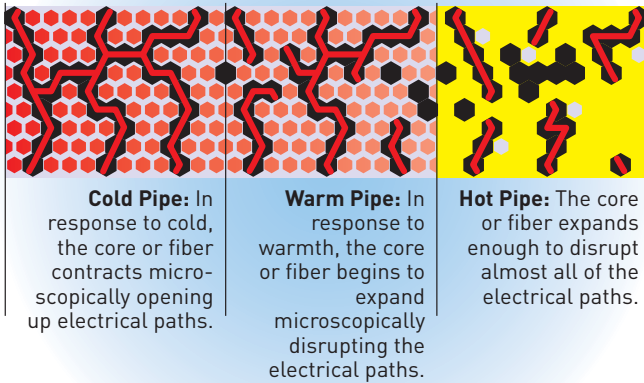

POWER-LIMITING TECHNOLOGY (VPL)

The Raychem Power-Limiting (VPL) heater is based on a coiled resistor alloy heating element wrapped around two parallel bus wires. The resistance of this heating element increases as its temperature increases, creating a positive temperature coefficient (PTC) effect. VPL can be used for high power output and /or high temperature exposure requirements which can reduce the number of heating cable runs required. Applications include: all industrial applications with a need for high maintain or high continuous exposure temperatures.

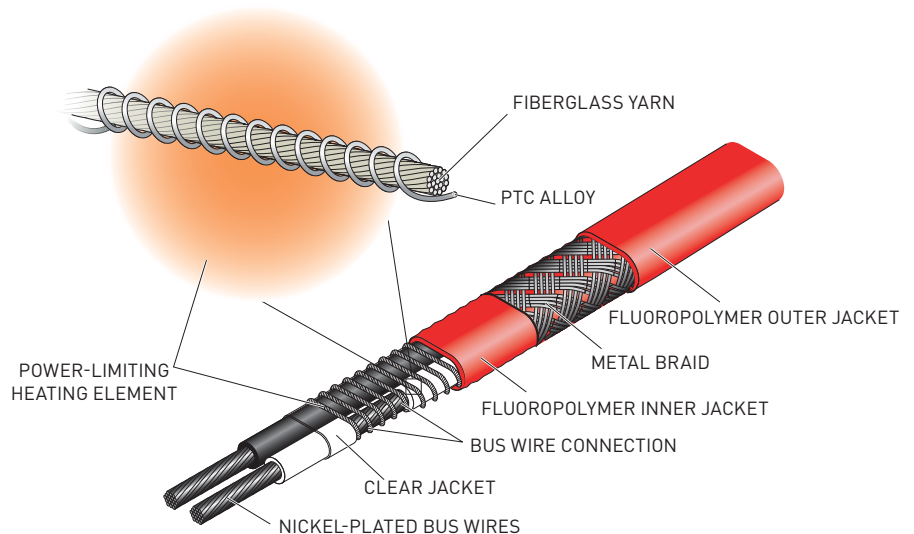

MINERAL INSULATED TECHNOLOGY (MI)

The Pyrotenax brand has been synonymous with the production of the highest quality mineral insulated (MI) systems for decades. These heating systems provide the optimum solution when extreme high power outputs and temperatures are required.

Applications include: industrial processes with a need for very high maintain temperatures (<600°C) or extreme exposure temperatures (<1000°C).

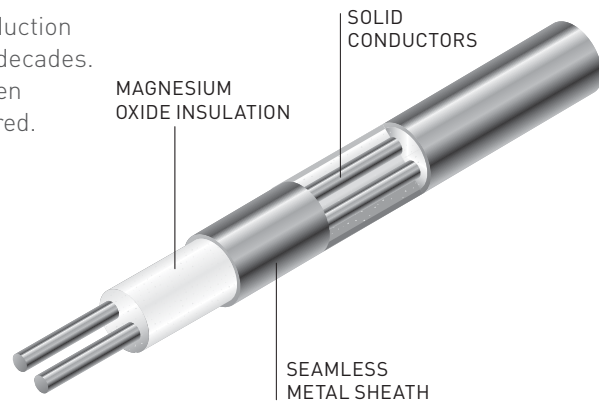

SKIN-EFFECT HEAT-TRACING TECHNOLOGY (STS)

The Raychem STS system is versatile engineered heat management system configured to deliver heat for medium to long pipelines with circuit lengths up to 25 kilometers/15 miles.

Applications include: temperature maintenance in material transfer lines, snow and ice melting, tank foundation heating, and subsea transfer lines.

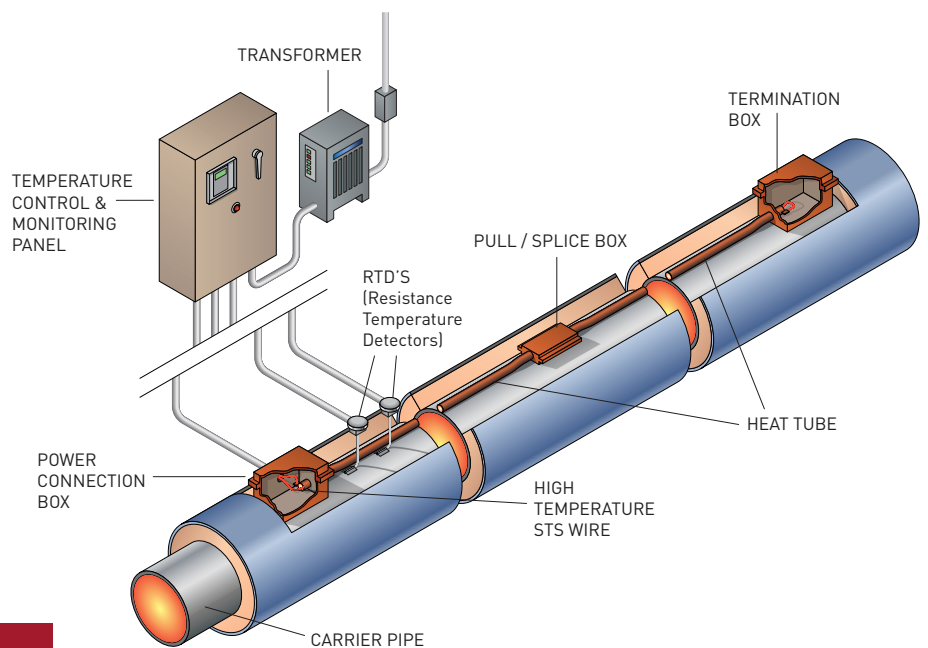

ADVANCED CONNECTION KITS

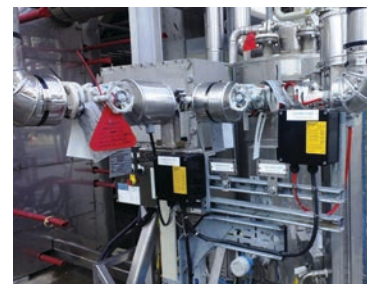

Raychem connection kits are rugged, resist corrosion, take less time to install, have fewer parts and permit visible monitoring status of power and continuity.

- One range of connection kits for all Raychem self-regulating cables.
- An integral part of the complete hazardous area system approval.
- Unique Raychem cold-applied core sealer (patented technology) allows connection without the use and required curing time of RTV silicone.
- Spacious boxes with front access, reliable spring type terminals and captive lid screws for fast installation.

CONTROL AND MONITORING SYSTEMS



Many aspects can influence the selection of the control and monitoring system for each project and application. The most effective solutions are often a blend of various combined technologies to achieve a balance between total installed costs (TIC), total operating cost (TOC) and long-term benefits associated with the entire heat management system, during the life of the plant.

Pentair Thermal Management offers a wide range of control and monitoring systems that provide scalable solutions from the most proven and economical simple mechanical thermostats to the very latest innovations in local control and central monitoring systems.

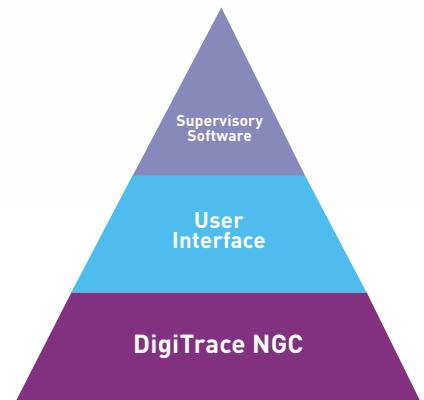

DIGITRACE NGC-30 AND NGC-40

DigiTrace NGC-30 is an advanced electronic multipoint control, monitoring and power distribution system for industrial heat-tracing applications for up to 260 circuits.

DigiTrace NGC-40 is an advanced modular control, monitoring and power distribution system whose single control module per heat tracing circuit provides the highest reliability architecture for your heat-tracing application.



FEATURES

- Most comprehensive product line to cover single circuit and multi-circuit applications
- Advanced monitoring and diagnostic capabilities
- Modular systems including single point architecture for maximum reliability
- State-of-the-art touch screen user interface
- Multiple RTD capabilities- versatile system for critical applications
- Capable of switching up to 690 V and 60 A current ratings to reduce power distribution costs
- Value-added accessories to provide significant cost savings

DIGITRACE SUPERVISOR

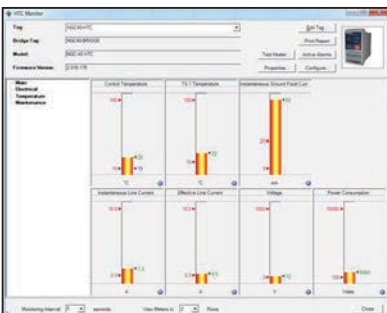

DigiTrace Supervisor (DTS) software is an integrated configuration and monitoring software for the NGC system family. It provides the capability to remotely configure the control systems, monitor status, alarms and other advanced features such as data logging and trending reports for a heat-tracing system.

SPECIALIZED ENGINEERED SYSTEMS

PETROTRACE DOWNHOLE HEATING SYSTEMS

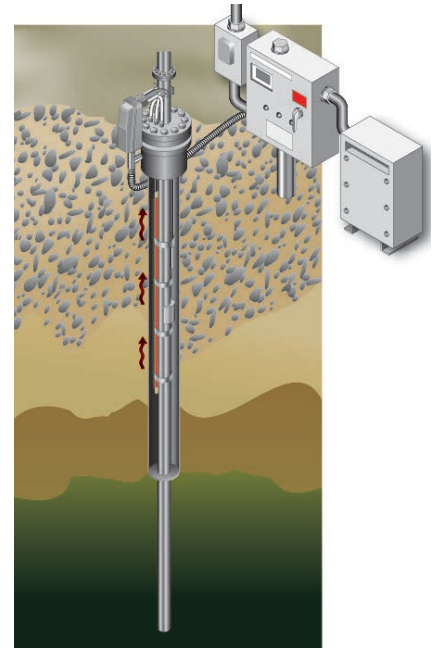

For over 20 years, oil companies around the world have relied on PetroTrace downhole heating systems as an Enhanced Oil Recovery and Flow Assurance tool to increase production, reduce total cost, and provide an environment friendly solution.

PetroTrace Downhole Heating systems utilize electro-thermal heating technologies to raise the oil temperature and reduce its viscosity for Enhanced Oil Recovery applications, and to mitigate the risk of wax or hydrate formation in the production tube for Flow Assurance applications.

TRAC-LOC TANK INSULATION SYSTEM

The Trac-Loc system is a thermally efficient and cost effective solution to help reduce a customer's total installed and operating cost. The system is virtually maintenance free, structurally superior and provides lower insulation cost than conventional insulation methods. Trac-Loc is ideal for large, flat-bottomed tanks used for storage of materials that are sensitive to temperature fluctuations and require a covering of insulation and jacketing to reduce heat loss or gain. With its unique design, panel construction and installation techniques, Trac-Loc is provided as a complete installed heat management system.



TRACETEK LEAK DETECTION SYSTEMS

TraceTek reliable liquid leak detection systems, with sensor cables and monitoring systems for hydrocarbon and environmental applications, lets you detect and pinpoint the source of a leak, allowing you to take corrective action before an incident becomes a "news story".

Rely on TraceTek leak detection systems for greater protection of your tank farms, airfields, pipelines, refueling ports and refineries—and ultimately, the protection of the environment and your reputation.



ADVANCED INDUSTRIAL SOLUTIONS

PENTAIR THERMAL MANAGEMENT PROVIDES SOLUTIONS TO A WIDE RANGE OF INDUSTRIAL MARKETS, PRIMARILY FOR THE OIL AND GAS, POWER GENERATION, TRANSPORT AND STORAGE, AND (PETRO-) CHEMICAL INDUSTRIES.

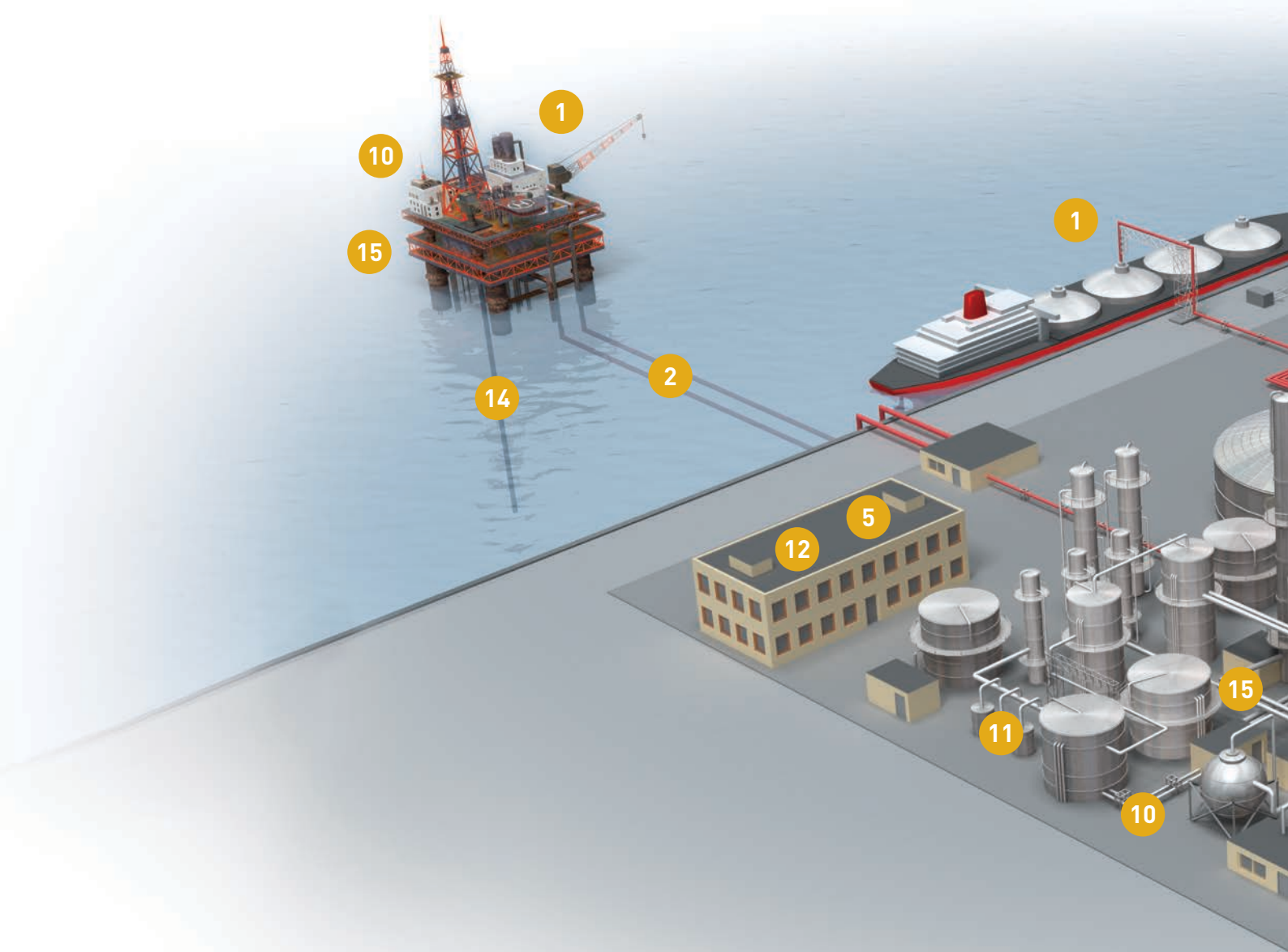

- 1 Anti-icing & de-icing
- 2 Heating of subsea transfer lines
- 3 Frost heave prevention of cryogenic LNG tanks
- 4 Long line heating with STS skin effect systems & pre-insulated pipes
- 5 Leak detection with TraceTek detection systems
- 6 Tank insulation with Trac-Loc vertical lock seam systems
- 7 Oilfield Services with PetroTrace Electric Downhole Heating systems
- 8 Tank heating
- 9 Process temperature maintenance
- 10
- 11
- 12
- 13
- 14
- 15

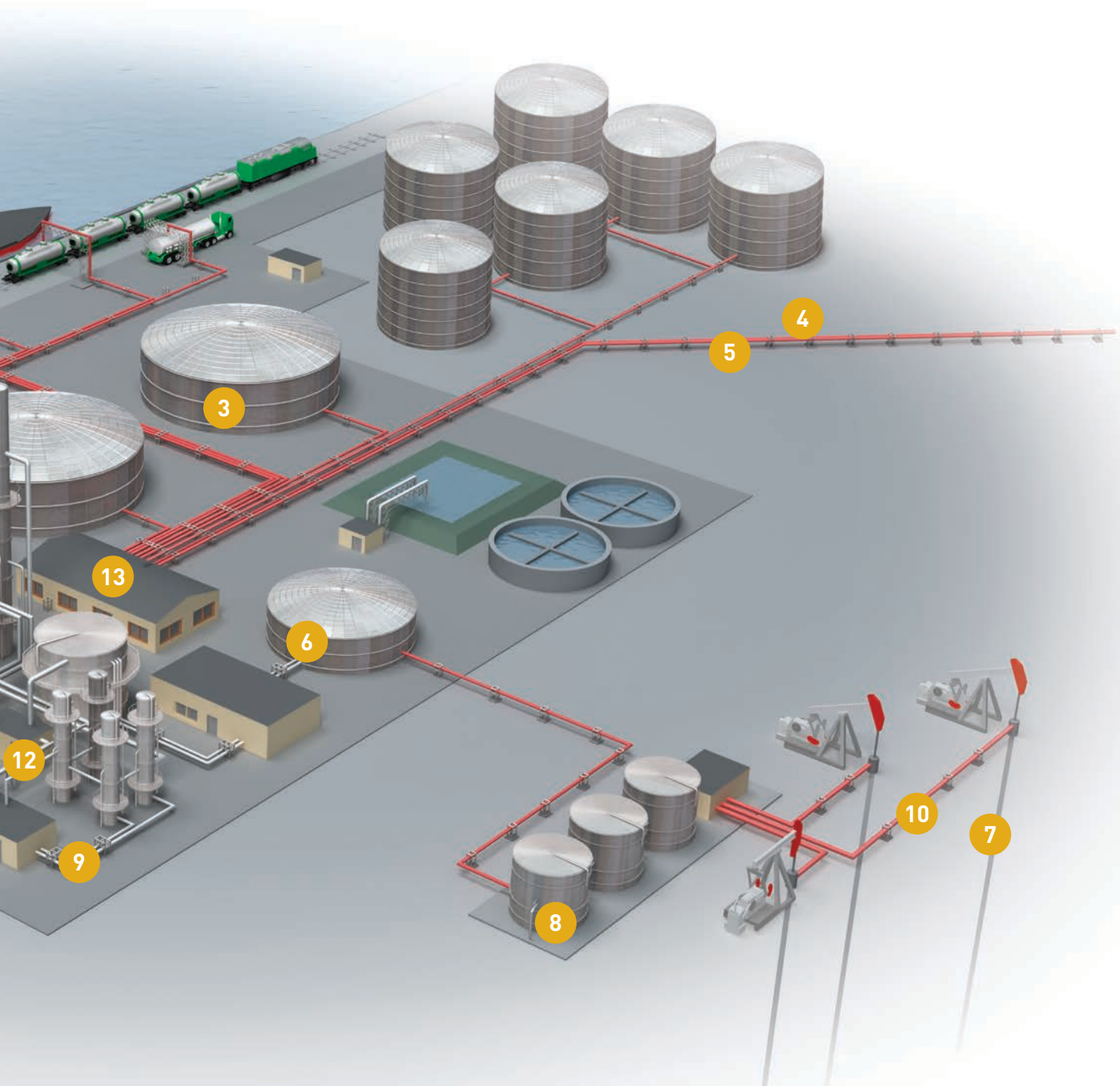

- 10** Pipe freeze protection
 - 11** Pre-traced, pre-insulated tubing for instrumentation & sample lines
 - 12** Control & Monitoring with DigiTrace systems
- 13** Power distribution
 - 14** Flow assurance with PetroTrace Electric Downhole heating systems
 - 15** Fire & performance wiring

TURNKEY SOLUTIONS

A Heat Management System is an engineered system designed to maintain or protect process piping, equipment, vessels and instruments at predetermined temperatures and within defined design criteria.



Committed to safety through proactive safety management techniques.

Safety

Safety is our number one concern. We are recognized as a leader in the industry in safety performance by consistently challenging the norm through safety innovations including training and motivational programs.



Warm Pipe Warranty

By allowing Pentair Thermal Management to handle all of the engineering, design, and construction of your heat-tracing system, we can provide you with a Warm Pipe Warranty, ensuring that the system operates as specified.

Detailed Engineering

Our experienced engineers apply product and optimization strategies to design a heat management system which meets your specific requirements at the lowest possible cost.

Front End Planning

Engaging Pentair Thermal Management early in the planning process allows us to help you make decisions which can reduce overall installed cost of the heat management system.

Post Installation Services and Maintenance

Providing regular Heat Management System audits or implementing a maintenance agreement, Pentair Thermal Management provides you with the security of having your system regularly evaluated by experts in the heat-tracing industry, allowing timely resolution of potential system problems.



Procurement

Pentair Thermal Management will manage all materials procurement and fabrication activities making sure the right materials get to the right work location at the right time.

Installation and Construction

Our construction teams are fully trained and experienced in heat-tracing installation techniques. Leverage our expertise to ensure timely and correct installation of your heat management system components, insulation and cladding.

Site Services

Using our Site Services allows you to maintain a single point of responsibility and accountability through the entire installation process. This ensures continuity of project knowledge from engineering through start-up. We can manage all the necessary services you need:

Engineering, Procurement, Construction and Construction Management, Quality Assurance.

Commissioning

Our commissioning services ensure that the heat management system is operating as expected. This includes full system audits, programming and set up of control panels and operational checks.

Quality Assurance/ Quality Control

Our Quality Management System addresses all processes including the design, supply, installation, and commissioning to ensure your Heat Management System is operating as intended.

APPROVALS AND WARRANTY



GLOBAL APPROVALS

Pentair Thermal Management heating systems are tested to the most stringent industry standards to ensure maximum reliability and performance for our customers. They are approved and certified for use in nonhazardous and hazardous locations by the major agencies including FM, CSA, UL, PTB, Baseefa, NEPSI, DNV, ABS and many more.



WARRANTY

As an endorsement of our product quality and our commitment to providing customer value and peace of mind, a 10-Year extended product warranty program is available. Visit our website for more information.



By allowing Pentair Thermal Management to handle all of the engineering, design, and construction of your heat-tracing system, we can provide you with a Warm Pipe Warranty, ensuring that the system operates as specified.



WEB SERVICES AND SOFTWARE

VISIT WWW.PENTAIRTHERMAL.COM

Our website provides all the latest tools and information you need to design, select, and purchase a complete heat-tracing system. Use our web-based program, or download design software to help you with your projects.

Browse and find the most up-to-date product brochures, data sheets and installation instructions.

ON-LINE TECHNICAL SUPPORT

On our frequently asked questions and answers (FAQ) page, you'll find questions broken down by markets and product lines. If your question does not appear, simply submit a new question.

A Pentair Thermal Management technical expert will answer your question.



DESIGN SOFTWARE

Save time with TraceCalc Pro. This software provides complete heat-tracing designs for pipes, tanks and vessels in a fraction of the time needed for manual design.

TraceCalc Net is an on-line tool that walks you through heat-tracing design in three simple steps:

- Finding the right products for your application
- Choosing quantities for a complete bill of materials
- Selecting optional control and monitoring systems



TraceCalc Pro





WWW.PENTAIRTHERMAL.COM

NORTH AMERICA

Tel: +1.800.545.6258
Fax: +1.800.527.5703
Tel: +1.650.216.1526
Fax: +1.650.474.7711
thermal.info@pentair.com

EUROPE, MIDDLE EAST, AFRICA

Tel: +32.16.213.511
Fax: +32.16.213.603
thermal.info@pentair.com

ASIA PACIFIC

Tel: +86.21.2412.1688
Fax: +86.21.5426.2917
cn.thermal.info@pentair.com

LATIN AMERICA

Tel: +1.713.868.4800
Fax: +1.713.868.2333
thermal.info@pentair.com

Pentair, AMC, BTV, DigiTrace, DigiTrace logo, DigiTrace Supervisor, HBTV, HQTV, HTPG, HTPI, HXTV, JBM, JBS, KTV, LBTV, NGC, PetroTrace, PLI, Pyrotenax, Pyrotenax logo, QTVR, RayClic, RaySol, RayStat, RHS, RMM2, SC, SHC, ShowerGuard, SLBTV, STS, Trac-Loc, Trac Calc, TraceCalc Net, TraceCalc Net logo, TraceCalc Pro logo, Tracer, Tracer logo, TraceTek, TraceTek logo, VLBTV, VLKTV, VPL, We manage the heat you need and XTV are owned by Pentair or its global affiliates. All other trademarks are the property of their respective owners.

© 2001-2013 Pentair.