



Cisco D9859 Advanced Receiver Transcoder Software Version 1.10 Installation and Configuration Guide

Please Read This Entire Guide

Veillez lire entièrement ce guide

Bitte das gesamte Handbuch durchlesen

Sírvase leer completamente la presente guía

Si prega di leggere completamente questa guida

Important

Please read this entire guide before you install or operate this product. Give particular attention to all safety statements.

Important

Veillez lire entièrement ce guide avant d'installer ou d'utiliser ce produit. Prêtez une attention particulière à toutes les règles de sécurité.

Zu beachten

Bitte lesen Sie vor Aufstellen oder Inbetriebnahme des Gerätes dieses Handbuch in seiner Gesamtheit durch. Achten Sie dabei besonders auf die Sicherheitshinweise.

Importante

Sírvase leer la presente guía antes de instalar o emplear este producto. Preste especial atención a todos los avisos de seguridad.

Importante

Prima di installare o usare questo prodotto si prega di leggere completamente questa guida, facendo particolare attenzione a tutte le dichiarazioni di sicurezza.

Notices

THE SPECIFICATIONS AND INFORMATION REGARDING THE PRODUCTS IN THIS MANUAL ARE SUBJECT TO CHANGE WITHOUT NOTICE. ALL STATEMENTS, INFORMATION, AND RECOMMENDATIONS IN THIS MANUAL ARE BELIEVED TO BE ACCURATE BUT ARE PRESENTED WITHOUT WARRANTY OF ANY KIND, EXPRESS OR IMPLIED. USERS MUST TAKE FULL RESPONSIBILITY FOR THEIR APPLICATION OF ANY PRODUCTS.

THE SOFTWARE LICENSE AND LIMITED WARRANTY FOR THE ACCOMPANYING PRODUCT ARE SET FORTH IN THE INFORMATION PACKET THAT SHIPPED WITH THE PRODUCT AND ARE INCORPORATED HEREIN BY THIS REFERENCE. IF YOU ARE UNABLE TO LOCATE THE SOFTWARE LICENSE OR LIMITED WARRANTY, CONTACT YOUR CISCO REPRESENTATIVE FOR A COPY.

The following information is for FCC compliance of Class A devices: This equipment has been tested and found to comply with the limits for a Class A digital device, pursuant to part 15 of the FCC rules. These limits are designed to provide reasonable protection against harmful interference when the equipment is operated in a commercial environment. This equipment generates, uses, and can radiate radio-frequency energy and, if not installed and used in accordance with the instruction manual, may cause harmful interference to radio communications. Operation of this equipment in a residential area is likely to cause harmful interference, in which case users will be required to correct the interference at their own expense.

The following information is for FCC compliance of Class B devices: This equipment has been tested and found to comply with the limits for a Class B digital device, pursuant to part 15 of the FCC rules. These limits are designed to provide reasonable protection against harmful interference in a residential installation. This equipment generates, uses and can radiate radio frequency energy and, if not installed and used in accordance with the instructions, may cause harmful interference to radio communications. However, there is no guarantee that interference will not occur in a particular installation. If the equipment causes interference to radio or television reception, which can be determined by turning the equipment off and on, users are encouraged to try to correct the interference by using one or more of the following measures:

Reorient or relocate the receiving antenna.

Increase the separation between the equipment and receiver.

Connect the equipment into an outlet on a circuit different from that to which the receiver is connected.

Consult the dealer or an experienced radio/TV technician for help.

Modifications to this product not authorized by Cisco could void the FCC approval and negate your authority to operate the product.

The Cisco implementation of TCP header compression is an adaptation of a program developed by the University of California, Berkeley (UCB) as part of UCB's public domain version of the UNIX operating system. All rights reserved. Copyright © 1981, Regents of the University of California.

NOTWITHSTANDING ANY OTHER WARRANTY HEREIN, ALL DOCUMENT FILES AND SOFTWARE OF THESE SUPPLIERS ARE PROVIDED "AS IS" WITH ALL FAULTS. CISCO AND THE ABOVE-NAMED SUPPLIERS DISCLAIM ALL WARRANTIES, EXPRESSED OR IMPLIED, INCLUDING, WITHOUT LIMITATION, THOSE OF MERCHANTABILITY, FITNESS FOR A PARTICULAR PURPOSE AND NONINFRINGEMENT OR ARISING FROM A COURSE OF DEALING, USAGE, OR TRADE PRACTICE.

IN NO EVENT SHALL CISCO OR ITS SUPPLIERS BE LIABLE FOR ANY INDIRECT, SPECIAL, CONSEQUENTIAL, OR INCIDENTAL DAMAGES, INCLUDING, WITHOUT LIMITATION, LOST PROFITS OR LOSS OR DAMAGE TO DATA ARISING OUT OF THE USE OR INABILITY TO USE THIS MANUAL, EVEN IF CISCO OR ITS SUPPLIERS HAVE BEEN ADVISED OF THE POSSIBILITY OF SUCH DAMAGES.

Cisco and the Cisco logo are trademarks or registered trademarks of Cisco and/or its affiliates in the U.S. and other countries. To view a list of Cisco trademarks, go to this URL: www.cisco.com/go/trademarks. Third-party trademarks mentioned are the property of their respective owners. The use of the word partner does not imply a partnership relationship between Cisco and any other company. (1110R)

Any Internet Protocol (IP) addresses and phone numbers used in this document are not intended to be actual addresses and phone numbers. Any examples, command display output, network topology diagrams, and other figures included in the document are shown for illustrative purposes only. Any use of actual IP addresses or phone numbers in illustrative content is unintentional and coincidental.

© 2014 Cisco Systems, Inc. All rights reserved.

AVC/MPEG-4/H.264 Products

With respect to each AVC/MPEG-4/H.264 product, Cisco is obligated to provide the following notice:

THIS PRODUCT IS LICENSED UNDER THE AVC PATENT PORTFOLIO LICENSE FOR THE PERSONAL AND NON-COMMERCIAL USE OF A CONSUMER TO (i) ENCODE VIDEO IN COMPLIANCE WITH THE AVC STANDARD ("AVC VIDEO") AND/OR (ii) DECODE AVC VIDEO THAT WAS ENCODED BY A CONSUMER ENGAGED IN A PERSONAL AND NON-COMMERCIAL ACTIVITY AND/OR WAS OBTAINED FROM A VIDEO PROVIDER LICENSED TO PROVIDE AVC VIDEO. NO LICENSE IS GRANTED OR SHALL BE IMPLIED FOR ANY OTHER USE. ADDITIONAL INFORMATION MAY BE OBTAINED FROM MPEG LA, L.L.C. SEE [HTTP://WWW.MPEGLA.COM](http://www.mpegla.com).

Accordingly, please be advised that service providers, content providers and broadcasters are required to obtain a separate use license from MPEG LA prior to any use of AVC/MPEG-4/H.264 encoders and/or decoders.

Safety Precautions

This symbol alerts you to the presence of uninsulated dangerous voltage inside the product enclosure that poses a risk of electric shock.	<div style="border: 1px solid black; padding: 5px; text-align: center; margin: 5px 0;"> CAUTION RISK OF ELECTRIC SHOCK DO NOT OPEN </div>	This symbol alerts you to important operating and maintenance (servicing) instructions included with this product.
<p>CAUTION</p> <p>TO REDUCE THE RISK OF ELECTRICAL SHOCK, DO NOT REMOVE COVERS FROM THIS UNIT. NO USER-SERVICEABLE PARTS INSIDE. REFER SERVICING TO QUALIFIED PERSONNEL. SEE ADDITIONAL SAFETY INSTRUCTIONS BELOW.</p>		
<p>WARNING</p> <p>TO REDUCE THE RISK OF ELECTRICAL SHOCK, DO NOT EXPOSE THIS PRODUCT TO RAIN OR MOISTURE.</p>		
<p>CAUTION</p> <p>THIS EQUIPMENT MAY HAVE UP TO TWO POWER SUPPLY CORDS. TO REDUCE THE RISK OF ELECTRIC SHOCK, TWO POWER SUPPLY CORDS MAY HAVE TO BE DISCONNECTED BEFORE SERVICING.</p>		

- 1 Read Instructions - All the safety and operating instructions should be read before the product is operated.
- 2 Retain Instructions - The safety and operating instructions should be retained for future reference.
- 3 Heed Warnings - All warnings on the product and in the operating instructions should be adhered to.
- 4 Follow Instructions - All operating and use instructions should be followed.
- 5 Cleaning - Unplug this product from the wall outlet before cleaning. Do not use liquid cleaners or aerosol cleaners. Use a damp cloth for cleaning.

Exception: A product that is meant for uninterrupted service and that, for some specific reason, such as the possibility of the loss of an authorization code for a CATV converter, is not intended to be unplugged by the user for cleaning or any other purpose, may exclude the reference to unplugging the product in the cleaning description above.

- 6 Attachments - Do not use attachments not recommended by the product manufacturer as they may cause hazards.
- 7 Water and Moisture - Do not use this product near water - for example, near a bath tub, wash bowl, kitchen sink, or laundry tub; in a wet basement; or near a swimming pool; and the like.

Accessories - Do not place this product on an unstable cart, stand, tripod, bracket, or table.

The product may fall, causing serious injury to a child or adult, and serious damage to the product.

Safety Precautions

Use only with a cart, stand, tripod, bracket, or table recommended by the manufacturer, or sold with the product. Any mounting of the product should follow the manufacturer's instructions, and should use a mounting accessory recommended by the manufacturer.

- 8 A product and cart combination should be moved with care. Quick stops, excessive force, and uneven surfaces may cause the product and cart combination to overturn.

PORTABLE CART WARNING



- 9 Ventilation - Slots and openings in the cabinet are provided for ventilation and to ensure reliable operation of the product and to protect it from overheating, and these openings must not be blocked or covered. The openings should never be blocked by placing the product on a bed, sofa, rug, or other similar surface. This product should not be placed in a built-in installation such as a bookcase or rack unless proper ventilation is provided or the manufacturer's instructions have been adhered to.
- 10 Power Sources - This product should be operated only from the type of power source indicated on the marking label. If you are not sure of the type of power supply to your home, consult your product dealer or local power company. For products intended to operate from battery power, or other sources, refer to the operating instructions.
- 11 Grounding or Polarization - This product may be equipped with a polarized alternating-current line plug (a plug having one blade wider than the other). This plug will fit into the power outlet only one way. This is a safety feature. If you are unable to insert the plug fully into the outlet, try reversing the plug. If the plug should still fail to fit, contact your electrician to replace your obsolete outlet. Do not defeat the safety purpose of the polarized plug. Alternate Warnings - This product is equipped with a three-wire grounding-type plug, a plug having a third (grounding) pin. This plug will only fit into a grounding-type power outlet. This is a safety feature. If you are unable to insert the plug into the outlet, contact your electrician to replace your obsolete outlet. Do not defeat the safety purpose of the grounding-type plug.
- 12 Power-Cord Protection - Power-supply cords should be routed so that they are not likely to be walked on or pinched by items placed upon or against them, paying particular attention to cords at plugs, convenience receptacles, and the point where they exit from the product.

- 13 Protective Attachment Plug - The product is equipped with an attachment plug having overload protection. This is a safety feature. See Instruction Manual for replacement or resetting of protective device. If replacement of the plug is required, be sure the service technician has used a replacement plug specified by the manufacturer that has the same overload protection as the original plug.
- 14 Outdoor Antenna Grounding - If an outside antenna or cable system is connected to the product, be sure the antenna or cable system is grounded so as to provide some protection against voltage surges and built-up static charges. Article 810 of the National Electrical Code, ANSI/NFPA 70, provides information with regard to proper grounding of the mast and supporting structure, grounding of the lead-in wire to an antenna discharge unit, size of grounding conductors, location of antenna-discharge unit, connection to grounding electrodes, and requirements for the grounding electrode.

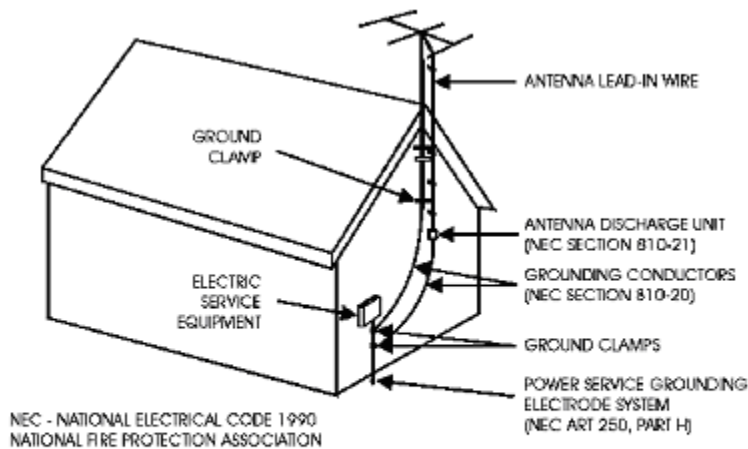

TO CATV SYSTEM INSTALLER
This reminder is provided to call the CATV system installer's attention to Article 820-40 of the National Electrical Code (NEC) that provides guidelines for proper grounding, and in particular, specifies that the cable ground shall be connected to the grounding system of the building, as close to the point of entry as practical.

- 15 Lightning - For added protection for this product during a lightning storm, or when it is left unattended and unused for long periods of time, unplug it from the wall outlet and disconnect the antenna or cable system. This will prevent damage to the product due to lightning and power-line surges.
- 16 Power Lines - An outside antenna system should not be located in the vicinity of overhead power lines or other electric light or power circuits, or where it can fall into such power lines or circuits. When installing an outside antenna system, extreme care should be taken to keep from touching such power lines or circuits as contact with them might be fatal.
- 17 Overloading - Do not overload wall outlets, extension cords, or integral convenience receptacles as this can result in a risk of fire or electric shock.
- 18 Object and Liquid Entry - Never push objects of any kind into this product through openings as they may touch dangerous voltage points or short-out parts that could result in a fire or electric shock. Never spill liquid of any kind on the product.

Safety Precautions

- 19 Servicing – Do not attempt to service this product yourself as opening or removing covers may expose you to dangerous voltage or other hazards. Refer all servicing to qualified service personnel.
- 20 Damage Requiring Service – Unplug this product from the wall outlet and refer servicing to qualified service personnel under the following conditions:
 - a When the power-supply cord or plug is damaged,
 - b If liquid has been spilled, or objects have fallen into the product,
 - c If the product has been exposed to rain or water,
 - d If the product does not operate normally by following the operating instructions. Adjust only those controls that are covered by the operating instructions as an improper adjustment of other controls may result in damage and will often require extensive work by a qualified technician to restore the product to its normal operation,
 - e If the product has been dropped or damaged in any way, and
 - f When the product exhibits a distinct change in performance – this indicates a need for service.
- 21 Replacement Parts – When replacement parts are required, be sure the service technician has used replacement parts specified by the manufacturer or have the same characteristics as the original part. Unauthorized substitutions may result in fire, electric shock, or other hazards.
- 22 Safety Check – Upon completion of any service or repairs to this product, ask the service technician to perform safety checks to determine that the product is in proper operating condition.
- 23 Wall or Ceiling Mounting – The product should be mounted to a wall or ceiling only as recommended by the manufacturer.
- 24 Heat – The product should be situated away from heat sources such as radiators, heat registers, stoves, or other products (including amplifiers) that produce heat.

Protect yourself from electric shock and your system from damage!

- This product complies with international safety and design standards. Observe all safety procedures that appear throughout this guide, and the safety symbols that are affixed to this product.
- If circumstances impair the safe operation of this product, stop operation and secure this product against further operation.

Avoid personal injury and product damage! Do not proceed beyond any symbol until you fully understand the indicated conditions!



You will find this symbol on the product and/or in the literature that accompanies this product.

It indicates important operating or maintenance instructions.

 You may find this symbol on the product and/or in the literature that accompanies this product.

It indicates a live terminal; the symbol pointing to the terminal device.

 You may find this symbol on the product and/or in the literature that accompanies this product.

It indicates a protective earth terminal.

 You may find this symbol on the product and/or in the literature that accompanies this product.

It indicates excessive or dangerous heat.

Power

- Important! This is a Class I product. You must earth this product. This equipment may have up to two power supply cords. To reduce the risk of electric shock, two power supply cords may have to be disconnected before servicing.
- This product plugs into a socket-outlet. The socket-outlet must be near this product, and must be easily accessible.
- Connect this product only to the power source that is indicated on the rear panel of this product.
- If this product does not have a mains power switch, the power cord serves this purpose

Enclosure

- Do not allow moisture to enter this product.
- Do not open the enclosure of this product unless otherwise specified.
- Do not push objects through openings in the enclosure of this product.

Cables

- Always disconnect all power cables before servicing this product.
- Always pull on the plug or the connector to disconnect a cable. Never pull on the cable itself.
- Do not walk on or place stress on cables or plugs.

Factory service

- Refer service only to service personnel who are authorized by the factory.

Règles de sécurité

Protégez-vous des risques d'électrocution et protégez votre système contre les endommagements éventuels.

Ce produit respecte les standards internationaux de sécurité et de conception. Veuillez observer toutes les procédures de sécurité qui apparaissent dans ce guide, ainsi que les symboles de sécurité qui figurent sur le produit.

Si, du fait des circonstances, ce produit cesse de fonctionner normalement, cessez de l'utiliser et empêchez-en l'utilisation future.

Évitez le risque de blessures et de dommages aux produits! Ne procédez à aucune tâche tant que vous n'aurez pas entièrement assimilé les conditions indiquées par un symbole!

 Ce symbole figure dans la documentation accompagnant ce produit. Il indique d'importantes instructions de fonctionnement ou d'entretien.

 Ce symbole peut être attaché à ce produit. Il indique une borne sous tension; la direction indique la borne.

 Ce symbole peut être attaché à ce produit. Il indique une borne de terre de protection.

 Ce symbole peut être attaché à ce produit. Il indique une température excessive ou dangereuse.

Alimentation

- Important! Ce produit fait partie de la classe I. Vous devez le mettre à la terre.
- Ce produit se branche dans une prise murale. Cette dernière doit être placée à proximité du produit et doit être facilement accessible.
- Ne branchez ce produit qu'à la source d'alimentation indiquée sur son panneau arrière.
- Si ce produit n'a pas d'interrupteur d'alimentation générale, le cordon d'alimentation remplit ce rôle.

Enceinte

- Ne laissez pas l'humidité pénétrer dans ce produit.
- N'ouvrez pas l'enceinte de ce produit, sauf instructions contraires.
- Ne forcez pas d'objets dans les ouvertures du boîtier.

Câbles

- Débranchez toujours tous les cordons d'alimentation avant de réparer ce produit.
- Tirez toujours sur la prise ou le connecteur pour débrancher un câble. Ne tirez jamais directement sur le câble.

- Ne marchez pas sur les câbles ou les prises et n'y exercez aucune pression.

Réparations effectuées à l'usine





- Ne confiez les travaux de réparations qu'au personnel autorisé par l'usine.

Sicherheitsvorkehrungen

Schützen Sie sich gegen elektrischen Schlag, und Ihr Gerät gegen Beschädigung!

- Dieses Gerät entspricht internationalen Sicherheits- und Ausführungsnormen. Beachten Sie alle in diesem Handbuch enthaltenen Sicherheitshinweise sowie die am Gerät angebrachten Warnzeichen.
- Sollten örtliche Umstände den sicheren Betrieb dieses Gerätes beeinträchtigen, schalten Sie es ab und sichern es gegen weitere Benutzung.

Vermeiden Sie Verletzungen sowie Beschädigung des Gerätes! Wenn Sie zu einem der folgenden Warnzeichen gelangen, nicht weiterarbeiten, bis Sie seine Bedeutung voll verstanden haben!

-  **Dieses Symbol erscheint auf dem Gerät und/oder in der ihm beiliegenden Literatur. Es bedeutet wichtige, zu beachtende Betriebs- oder Wartungsanweisungen.**
-  **Wenn dieses Zeichen am Gerät angebracht ist, warnt es vor einer spannungsführenden Stelle.**
-  **Dieses Symbol kennzeichnet auf dem Gerät die Anschlußstelle der Sicherheitserde.**
-  **Wenn dieses Zeichen am Gerät angebracht ist, warnt es vor heißen Stellen, die zu Verbrennungen führen können.**

Netzspannung

- Wichtig! Dieses Gerät ist ein Produkt der Schutzklasse I. Es muß geerdet werden.
- Das Gerät ist an einer Steckdose anzuschließen. Diese muß sich leicht zugänglich in unmittelbarer Nähe des Gerätes befinden.
- Die Netzversorgung muß den auf der Rückwand des Gerätes angegebenen Werten entsprechen.
- Falls sich kein Hauptschalter am Gerät befindet, dient das Netzkabel diesem Zweck.

Gehäuse

- Das Innere des Gerätes ist vor Feuchtigkeit zu schützen.
- Das Gehäuse ist nicht zu öffnen.
- Niemals einen Gegenstand durch die Gehäuseöffnungen einführen!

Safety Precautions

Kabel

- Vor jeglicher Wartung des Gerätes sind alle Kabel zu entfernen.
- Hierzu grundsätzlich am Stecker oder Verbindungsstück und niemals am Kabel selber ziehen.
- Nicht auf die Kabel oder Stecker treten oder diese einer Zugbelastung aussetzen.

Hersteller-Wartung

- Wartungsarbeiten sind nur durch vom Hersteller autorisierte Techniker vorzunehmen.





Precauciones de seguridad

¡Protéjase contra la electrocución y proteja su sistema contra los daños!

Este producto cumple con los criterios internacionales de seguridad y diseño. Observe todas los procedimientos de seguridad que aparecen en esta guía, y los símbolos de seguridad adheridos a este producto.

Si las circunstancias impiden la operación segura de este producto, suspenda la operación y asegure este producto para que no siga funcionando.

¡Evite lastimarse y evite dañar el producto! No avance más allá de cualquier símbolo hasta comprender completamente las condiciones indicadas!

-  **Encontrará este símbolo en el impreso que acompaña a este producto. Este símbolo indica instrucciones importantes de funcionamiento o mantenimiento.**
-  **Es posible que este símbolo esté pegado al producto. Este símbolo indica un terminal vivo, la flecha apunta hacia el aparato terminal.**
-  **Podría encontrar este símbolo pegado al producto. Este símbolo indica un terminal de protección de tierra.**
-  **Podría encontrar este símbolo pegado al producto. Este símbolo indica calor excesivo o peligroso.**

Alimentación

- Importante! Este es un producto de Clase I. Tiene que estar conectado a tierra.
- Este producto se conecta a un enchufe. El enchufe necesita estar cerca del producto y ser fácilmente accesible.
- Conecte este producto únicamente a la fuente de suministro eléctrico indicada en el panel posterior del producto.
- Si el producto no tiene interruptor para la línea principal, utilice el cordón toma de corriente para este propósito.

Cubierta

- No permita que la humedad penetre en este producto.
- No abra la cubierta del producto a menos que se indique lo contrario.
- No introduzca objetos a través de las aberturas de la cubierta del producto.

Cables

- Siempre desconectar todos los cables eléctricos antes de revisar o reparar el producto.
- Tire siempre del enchufe o del conector para desconectar un cable. Nunca tire del cable mismo.
- No camine ni aplique presión sobre los cables o enchufes..

Revisión y reparación de fábrica





- Solo personal aprobado por la fábrica puede darle servicio al producto.

Precauzioni di sicurezza

Protegetevi da scosse elettriche e proteggete il vostro sistema da possibili danni!

- Questo prodotto soddisfa le norme internazionali per la sicurezza ed il design. Seguite tutte le procedure di sicurezza contenute in questa guida e i simboli di sicurezza applicati al prodotto.
- Se circostanze avverse compromettono la sicurezza d'uso di questo prodotto, interrompetene l'uso e assicuratevi che il prodotto non venga più utilizzato.

Evitare infortuni alla persona e danni al prodotto! Non procedere oltre a qualunque simbolo fino a quando non si siano comprese pienamente le condizioni indicate!

-  **Questo simbolo, che appare nella letteratura di accompagnamento del prodotto, indica importanti istruzioni d'uso e di manutenzione.**
-  **Sul prodotto potete vedere questo simbolo che indica un dispositivo terminale sotto tensione; la freccia punta verso il dispositivo.**
-  **Potrete trovare il presente simbolo applicato a questo prodotto. Questo simbolo indica un terminale protettivo di messa a terra.**
-  **Potrete trovare il presente simbolo attaccato a questo prodotto. Questo simbolo indica un calore eccessivo o pericoloso.**

Alimentazione

- Importante! Questo prodotto è di Classe I. Va messo a terra.
- Questo prodotto si inserisce in una presa di corrente. La presa di corrente deve essere in prossimità del prodotto, e deve essere facilmente accessibile.

Safety Precautions

- Collegare questo prodotto solamente alla fonte di alimentazione indicata sul pannello posteriore di questo prodotto.
- Se questo prodotto non è dotato di un interruttore principale, il cavo di alimentazione funge a questo scopo.

Chiusura

- Proteggete da umidità questo prodotto.
- Non aprire la chiusura di questo prodotto a meno che non sia specificato diversamente. Non inserire oggetti attraverso le fessure della chiusura.

Cavi

- Staccare sempre tutti i cavi di alimentazione prima di svolgere l'assistenza tecnica al prodotto.
- Per scollegare un cavo tirate la spina o il connettore, non tirare mai il cavo stesso.
- Non calpestare o sottoporre a sollecitazioni i cavi o le prese.

Riparazioni di fabbrica

- Per le riparazioni contattate solamente personale tecnico autoizzato dalla fabbrica.

Contents

Safety Precautions	vii
---------------------------	------------

About This Manual	xxiii
--------------------------	--------------

Objective.....	xxiii
Audience	xxiii
Required Knowledge.....	xxiii

Chapter 1 Introduction	1
-------------------------------	----------

D9859 Advanced Receiver Transcoder	2
Digital Program Distribution.....	2
Key Features	2
Software Update	3
Transport Stream Outputs.....	4
DVB-ASI Outputs.....	4
MPEGoIP Output	4
MPE Output.....	5
Disaster Recovery.....	6

Chapter 2 Quick Setup - Read Me First!	9
---	----------

Maintenance of EMC Compliance	10
Connecting the Transcoder to Other Equipment	11
Setting up for Network Connection.....	12
Quick Setup Instructions for RF Acquisition	13
Assigning a Program Channel to a PE (Program Entry)	15
Setting up the ASI Output.....	16
Setting the DPM Mode.....	17

Chapter 3 Installation	19
-------------------------------	-----------

Power Connection	20
Installing the D9859 Transcoder.....	21
Rack Mounted.....	21
Cooling	21
Grounding.....	21
Mounting the D9859 Transcoder to a Rack.....	21
Connecting the AC Power to the D9859 Transcoder	22

Rear Connector Panel.....	23
Connecting the Input/Output Signals.....	25
Connecting the RF Inputs	25
Connecting the ASI Input	25
Connecting the Video Outputs	25
Connecting the Balanced Audio Output.....	25
Connecting the Ethernet Management Interface	26
Connecting the IP TS Output.....	26
Connecting the ASI Outputs.....	27
Connecting an External Alarm System	27
Connecting the RS-232 Data Interface.....	28
Connecting the Cue Tone/Cue Trigger Interface	28
Configuring Open-collector Outputs	29
Setting Admin User Privileges via a Telnet/SSH Connection.....	30
Administrator User Privileges	30
Starting a Telnet/SSH Session	30
Adding a New User.....	31
Deleting a User.....	31
Changing a Username	32
Changing a Password (allowed by all Users)	32
Printing the List of Users.....	32
Resetting the Login Credentials	32

Chapter 4 Front Panel Operation 33

About the Front Panel	34
LCD.....	34
Keypad	34
Front Panel LEDs	34
Navigation/Selection Keypad	35
Locking/Unlocking the Front Panel	38
Startup Screen.....	39
Main Structure	39
Channel Authorization Status	39
LCD Panel	39
LCD Symbol	40
Assigning Program to the Program Entry	41
Deleting a Program from the Program Entry	42
Main Menu	43
Status Menu	44
Structure	44
Status Menu - IP.....	52
Status Menu - DR.....	53
Setup Menu	56
Setup Menu: Admin.....	57
Setup Menu: TS Input.....	62
Setup Menu: IP.....	68

Setup Menu: Services	76
Setup Menu: Outputs	88
Setup Menu: CA	115
Setup Menu: Alarm/Warning	117
Setup Menu: Noise Cutoffs	119
Setup Menu: DR.....	121
About Menu	124
General	124
Licenses	125
Versions Menu	126
Main Versions	126
Transcoder Software Versions	128
Transcoder Hardware Versions	128
Diagnostics Menu	129
Alarms/Warnings	129
Logs.....	129
PSI - Frequency Plan.....	130
PSI - Channels	130
PSI - Tables.....	131
Power On.....	131
Health Monitor	132

Chapter 5 Web GUI Setup and Monitoring 133

Logging On to the Web GUI.....	134
D9859 Summary Overview	135
Shortcuts.....	135
Modules.....	136
Alarms/Warnings	137
D9859 Menus	138
D9859 Web GUI Environment	140
Window Buttons	140
Setting up Input Information	141
Setting up the RF Input	141
Setting up the ASI Input.....	146
Setting up SI Receive Parameters	148
Setting up Muting Threshold Controls	151
Viewing the Input Status.....	153
Configuring the Disaster Recovery Settings	154
Viewing the Disaster Recovery Status	157
Setting up the Channel Selections	159
Viewing the Channel Status.....	160
Viewing the CA Status.....	162
Setting up the BISS Mode.....	163
Viewing the PSI Tables.....	164
Viewing PSI Frequency Information.....	165
Viewing the PSI Channels.....	166

Viewing the PID Input Status.....	167
Setting up Audio and Video Information.....	168
Setting up the Video Parameters	168
Setting up Captions	170
Setting up Subtitles	171
Setting up VBI	173
Setting up Audio Parameters	174
Setting up Cueing Parameters	177
Setting up Cue Tone Test	179
Setting up Cue Tones.....	180
Setting up Services.....	181
Configuring Transport Stream Information.....	182
Configuring the ASI Output	182
Configuring the DPM ASI Details	188
Viewing the ASI Output Transport Status.....	194
Configuring the MPEGoIP Output.....	195
Configuring the DPM MPEGoIP Output Details	203
Viewing the MPEG Output Transport Status.....	210
Typical set up for Digital Program Mapping (DPM)	210
Setting up Default Settings for the Transcoder	213
Configuring System Settings	218
Viewing the System Identification	218
Viewing Hardware Features and Base License Information	219
Setting up IP Information.....	220
Setting up IP Routing Information	224
Configuring the MPE Settings	226
Setting up SNMP Information and Trap Destinations	228
Configuring Time/Clock Settings	230
Viewing the Alarm/ Warning Status.....	231
Setting up Alarms and Warnings	232
Viewing Alarm/ Warning History	235
Viewing Version Information	236
Viewing Transcoder Version Information	239
Setting up Import/Export File Information	241
Setting up Import/Export FTP Information	243
Managing D9859 Web GUI Accounts	245
Configuring Lock Level Settings	249
Configuring Front Panel Settings	251
Viewing Support Information	252
Viewing Contact Information	252
Viewing Diagnostic Logs	253
Viewing the Usage Counters	254
Viewing Operating Fan Speeds and Board Temperatures	255
Viewing Alarm/ Warning History	256
Loading a Software Version and License.....	257

Chapter 6 Service and Maintenance 259

D9859 Transcoder Alarm Messages.....	260
Alarms	260
Warnings	299
Power Supply Replacement.....	317

Chapter 7 Customer Information 319

Appendix A Technical Specifications 321

L-Band Input and Processing	322
General	322
LNB LO Stability	322
LNB Power and Control.....	323
DVB-S/DVB-S2.....	323
Video Inputs/Outputs and Processing.....	326
General	326
Video Inputs.....	326
Video Outputs.....	326
Audio Inputs/Outputs.....	329
VBI Data Input/Output	330
Transport Stream Outputs.....	331
ASI Output.....	331
MPEGoIP Output	331
MPE Output	331
Control, Management and Data Interfaces	333
Ethernet Management Interface	333
Ethernet Data Interface.....	333
RS-232 Data Interface	333
Alarm Interface	333
Contact Closure Interface.....	334
Power and General Specifications	335
General	335
Power.....	335
Mechanical	336
Environment	336

Appendix B Default Settings and Lock Levels 337

Factory Default Settings and Lock Levels	338
Administration.....	338
ASI Input	339
RF Input	339
Tune Mode	340
Disaster Recovery	340

IP	341
Trap Destinations	342
Protocols	342
Video.....	342
Audio.....	343
Captions	343
VBI	343
Subtitles	343
Decode	344
Cueing	344
TS Out - ASI.....	345
TS Out - MOIP	345
DPM - ASI/MOIP	346
Transcode	347
Inband.....	348
Options	348
Alarm/Warning.....	349
Noise Cutoff	349
Import/Export (Web GUI only)	350
DPM Default Settings for Different Output Modes	351

Appendix C Compliance 355

Applicable Standards and Notices	356
Safety	356
ESD	356
Electromagnetic Compatibility Regulatory Requirements	356
FCC Notices	357
Industry Canada Notice	357
Unauthorized Modifications	357
Declaration of Conformity.....	358

Index 361

About This Manual

Objective

This manual describes how to install, use and maintain the Cisco D9859 Advanced Receiver Transcoder.

Note: The manual describes all available options for the D9859 transcoder. Your D9859 transcoder may only have some of the features described in this manual.

Audience

The audience of this manual includes users (operators) and service personnel who are responsible for the installation, configuration, operation, monitoring and service of the D9859 transcoder.

Required Knowledge

To use this documentation, the user should have a basic knowledge of the technology used in relation to this product. Service personnel should have additional skills and be familiar with cabling, electronic circuitry, and wiring practices.

This manual is intended for operators who are responsible for the configuration, remote operation and maintenance of the D9859 transcoder.

1

Introduction

Overview

This chapter is a general introduction to the Cisco D9859 Advanced Receiver Transcoder. It describes the most common applications and interfaces of the transcoder.

In This Chapter

- D9859 Advanced Receiver Transcoder2
- Transport Stream Outputs.....4
- Disaster Recovery6

D9859 Advanced Receiver Transcoder

The Cisco D9859 Advanced Receiver Transcoder extends the distribution options for MPEG-4 Advanced Video Coding (AVC) high definition from solely MPEG-4 environments to existing MPEG-2 networks. Support for up to eight simultaneous high-definition or standard-definition (SD) channels of decryption and transcoding provides the advantage of density for locations requiring more than just a single channel. The D9859 can provide up to 8 down-converted MPEG-2 standard definition programs or MPEG-2 high-definition transcoded programs. Video and two audio outputs are available for analog down-conversion for one of the decrypted incoming MPEG-4 high-definition programs.

Digital Program Distribution

The Asynchronous Serial Interface (ASI) and MPEG over IP (MPEGoIP) transport outputs are individually configurable and provide the capability of carrying up to eight decrypted transcoded programs for digital tier distribution. This helps the compressed video programs to be efficiently distributed to subscribers equipped with digital set-top boxes. Digital audio passthrough is synchronized to the transcoded program output. Compliant program-specific information and service information (PSI/SI) regeneration provides integration into a digital tier distribution network for eight transcoded programs.

Key Features

The D9859 Advanced Receiver Transcoder provides the following key features:

- Four L-Band inputs
- DVB-S Demodulation for QPSK
- DVB-S2 Demodulation for QPSK and 8PSK
- Cisco PowerVu® conditional access with Data Encryption Standard (DES) or DVB descrambling
- Supports Basic Interoperable Scrambling System (BISS) conditional access
- Decryption and transcoding of up to eight programs for digital transport output
- Two digital transport outputs available (ASI and MPEGoIP)
- Support for up to eight simultaneous high-definition or standard-definition channels of decryption and transcoding and passthrough of the original channel. Total of 16 regenerated outputs (8 transcode + 8 passthrough)
- Program transcoding to support down-conversion of a MPEG-4 HD program to a MPEG-2 SD program

- PSI/SI regeneration support on all licensed outputs (up to eight programs transcoded + up to 8 original content pass through)
- 4:2:0 high-definition 1080i and 720p video decoding
- AFD support for down-conversion of a decoded HD program with aspect ratio conversion
- Dolby Digital (AC-3) and Dolby Digital Plus (E-AC-3) audio decoding
- Closed captioning passthrough of EIA-608 and EIA-708 for transcoded programs
- Audio passthrough synchronization for transcoded programs
- Additional ASI outputs for redundancy
- MPEGoIP output for network connectivity
- DVB subtitle passthrough with transcode programs
- Contact closure terminals for simple alarm monitoring
- Simple Network Management Protocol (SNMP) for setup, control, and monitoring
- Field-upgradeable software
- Field-upgradeable additional transcoder channel licenses
- Front panel LCD for control and monitoring
- Web browser interface for easy setup, control, and monitoring
- Uplink addressable decoder output control (vertical blanking interval [VBI], audio routing, DPI, and ASI output)
- Dual-tone multifrequency (DTMF) cue tone and cue trigger outputs for ad insertion
- Digital Program Mapping that provides uplink control for service replacements in blackout areas
- Advanced Disaster Recovery capabilities

Software Update

All software in the D9859 transcoder is stored in non-volatile memory that can be electrically programmed. New software releases for the D9859 transcoder can be downloaded via the Ethernet 10/100/1000BASE-T Management interface.

Transport Stream Outputs

DVB-ASI Outputs

The D9859 transcoder has three DVB-ASI outputs. These outputs can be used as inputs for multiplexers, groomers or other types of DVB-ASI reception equipment.

MPEGoIP Output

The MPEGoIP output provides a number of output modes including the capability of carrying a decrypted program for digital tier distribution. This helps ensure that compressed video programs are efficiently distributed to households equipped with digital set-top boxes. Digital Program Insertion (DPI) information will also be available along with the video and audio PIDs (Packet Identifiers) for external ad-insertion in compressed digital format.

The diagram below shows an example of the D9859 transcoder used in an ASI or MPEGoIP application.

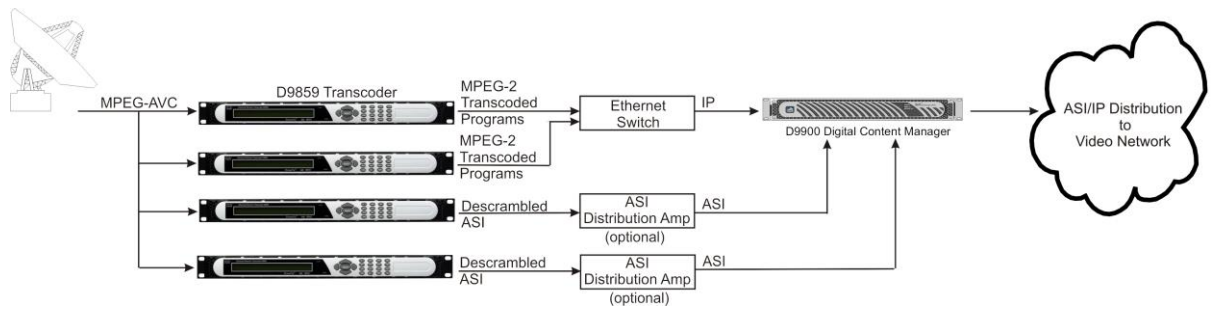

MPE Output

The Multiprotocol Encapsulation (MPE) output provides a means to carry packet oriented IP protocols on top of a transport stream. The MPE output receives IP packets from the transport stream and the IP data can be sent through an Ethernet switch to an IP router or directly to a receiving device.

The diagram below shows an example of the D9859 transcoder used in an MPE application.

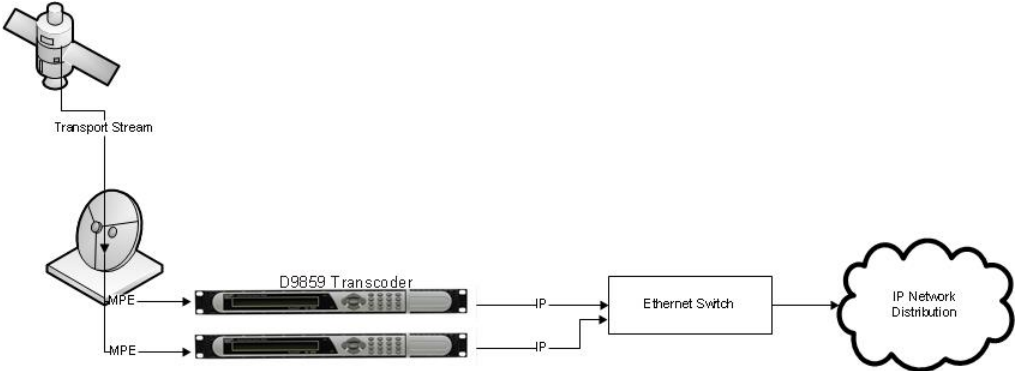

Disaster Recovery

In the event of a transmission failure on the primary feed, the disaster recovery allows for continued programming, with limited to no downtime. The failure condition could be triggered by one of the following events:

- RF Lock Loss
- Unstable RF signal
- Transport Loss (RF locked, but no transport stream packets and NULL packets received)

Once the receiver detects a failure after the configured timeout, it will initiate a disaster recovery search based on the search path determined by the disaster recovery configuration. A DR symbol is displayed on the front panel, and the D9859 web GUI displays a D/R in progress status. During a disaster, the receiver will attempt to tune to a different backup transport, based on the search path configured. The origin transport consists of origin transport tuning parameters and PE service IDs, configured in the Input menus. For more information on the Input parameters, see *RF1, RF2, RF3, RF4 (RFx) Input* (on page 63) for the front panel, and *Setting up the RF Input* (on page 141) for the web GUI.

Note: If you perform a master PE channel change during a disaster recovery search, the search will end, the current tuning parameters will be locked, and the current channel will become the origin channel. If you perform a tuning change during a disaster recovery search, the search will end, the current user tuning parameters will become the origin tuning parameters, and the origin may be updated by any of the NIT updates that follow.

For example, the disaster recovery is configured as follows:

Program Entry	Origin Transport Channel Number	Backup 1 Transport Channel Number	Backup 2 Transport Channel Number	Backup 3 Transport Channel Number
PE1	101	11	101	801
PE2	2	12		1005

When disaster occurs, the receiver will tune to channel 11, as defined on the Backup 1 transport.

If the acquisition is successful on the Backup 1 transport (PAT is received), the receiver will set PE 1 to channel 11 and PE2 to channel 12 and declare that the disaster is over.

If the acquisition fails or there is no signal lock on the Backup 1 transport, the receiver will continue to search for the next backup transport for PE1 (Backup 2 transport). If the acquisition is successful on the Backup 2 transport, the receiver will set PE1 to channel 101, but leave PE2 to channel 2 because PE2 is not specified for Backup 2 transport.

If the acquisition fails or there is no signal lock on the Backup 2 transport, it will continue the search path and set PE1 to channel 801 and PE2 to channel 1005 if the acquisition is successful on the Backup 3 transport. However, if the acquisition fails or there is no signal lock on the Backup 3 transport, the search path will continue to the origin transport. The search path will cycle through origin, Backup 1, Backup 2, and Backup 3 infinitely.

The search path is shown in the Disaster Recovery Status information on the front panel and web GUI.

By default, the disaster recovery is enabled. To set up and view the disaster recovery parameters using the front panel, see *Setup Menu: DR* (on page 121) and *Status Menu - DR* (on page 53). To set up and view the disaster recovery parameters using the web GUI, see *Configuring the Disaster Recovery Settings* (on page 154) and *Viewing the Disaster Recovery Status* (on page 157).

2

Quick Setup - Read Me First!

Overview

This chapter provides a quick setup for the Cisco D9859 Advanced Receiver Transcoder. If you are unsure about which receiver settings to use, contact your local service provider for assistance.

In This Chapter

■ Maintenance of EMC Compliance	10
■ Connecting the Transcoder to Other Equipment	11
■ Setting up for Network Connection.....	12
■ Quick Setup Instructions for RF Acquisition	13
■ Assigning a Program Channel to a PE (Program Entry)	15
■ Setting up the ASI Output	16
■ Setting the DPM Mode.....	17

Maintenance of EMC Compliance

Double-shielded (braid/foil or braid/braid) cables should be used for all ASI I/O and RF inputs. Single-shield cables are acceptable for all other inputs and outputs. For terminal block (Alarms) I/O, no shielding is required.

Connecting the Transcoder to Other Equipment

The following displays the rear panel of the D9859 transcoder:

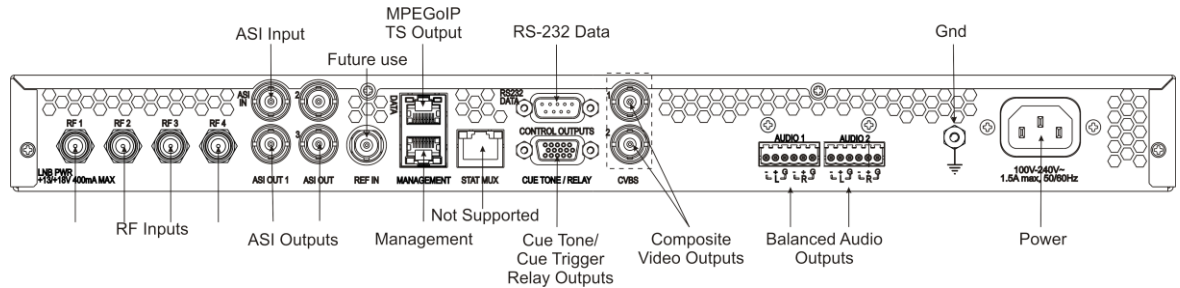

- 1 Connect the L-Band signal to RF1. 13V or 18V LNB power is only available on the RF1 port. The factory default setting for LNB power is OFF.
- 2 Connect the ASI OUT port to an ASI device for digital tier applications.
Note: A double-shielded coaxial cable is required to connect to the ASI OUT and/or the ASI IN port in order to meet EMC requirements.
- 3 Connect the Composite Video Outputs to a video monitor.
- 4 Using a multi-conductor, pluggable cable, connect the balanced audio outputs, terminal blocks AUDIO 1 and AUDIO 2 to monitoring equipment.
- 5 Apply power by connecting the transcoder to a power outlet. The message "Application Starting" will appear on the front panel. The boot-up process will take approximately 1 minute for the unit to initialize. When ready, the front panel display shows the start-up screen.

The power cord (consisting of appliance coupler, flexible cord, and plug) supplied with this product meets the requirements for use in the country for which this product was purchased. In general, the power cord must be approved by an acceptable, accredited agency responsible for evaluation in the country where the product will be used.

Setting up for Network Connection

- 1 Press **MENU** to display the Main menu.
- 2 If the Advanced Receiver Transcoder is to be connected to a network, press **▶** to move to the Setup menu. Press **SELECT**. Press **▶** twice to select the IP menu. Press **SELECT** twice to go to the IP menu.
- 3 Use the **▲▼** arrow keys to navigate up and down the IP menu, and the **◀▶** arrow keys to move across the IP menu to set the IP Address, Mask and Gateway parameters. Use the number keys to directly enter numbers in the fields. For more information on keypad operation, see *Keypad* (on page 34).
- 4 Press **SELECT** each time to save the changes. Press **MENU** four times to return to the startup screen.

Quick Setup Instructions for RF Acquisition

- 1 Press **MENU** to display the Main menu.
- 2 Press **▶** to go to the Setup menu. Press **SELECT**. Press **▶** to move to the TS Input menu. Press **SELECT**.
- 3 To setup the ASI input port, go to step 4. To setup the RF1 input port, go to step 5.
- 4 Press **SELECT** three times. Press **▼** to set the ASI port to Act (Activate). Press **SELECT**. Go to step 11.
- 5 Press **SELECT**. Press **▶** to go to RF1. Press **SELECT** twice. Use **▼** to set the RF1 port parameter to Act (Activate). Press **SELECT**.
- 6 Press **▼** to move to the LO1, LO2, Crossover menu. Verify these parameters for your application. If no change is needed, go to Step 7. If required, you may modify these settings. Use **▶** to move to the parameter that you want to modify. Press **SELECT**. Use the numerical keypad to enter new frequencies. Press **SELECT**.
- 7 Press **▼** five times to move to the Modulation and Rolloff menu. Press **SELECT**. Use **▲▼** to choose DVB-S or DVB-S2. Press **SELECT**. If DVB-S2 is used, press **▶** to choose Rolloff. Press **SELECT**. Use **▲▼** to choose the value. Press **SELECT**.
- 8 Press **▲** to move to the Freq., Sym Rate, and FEC menu. Press **SELECT**. Enter the RF frequency. Press **SELECT**. Press **▶** to move to the Sym. Rate menu. Press **SELECT**. Enter the symbol rate. Press **SELECT**. If DVB-S2 is used, proceed to step 9. If DVB-S is used, press **▶** to set up the FEC. Press **SELECT**. Use **▲▼** to select AUTO. Press **SELECT**.
- 9 Press **▼** twice to move to the Net ID menu. Press **▶** to choose Net ID. Press **SELECT**. Enter the value. Press **SELECT**.
- 10 Press **▼**. Press **SELECT**. Use **▲▼** to change the LNB power, if needed. Only the RF1 port is capable of providing 13V or 18V. Press **SELECT**.
- 11 Press **MENU** three times. Press **▶** to move to Save & Exit. Press **SELECT**. Save & Exit will return you to the Main: Setup menu; Abandon & Exit will go back to the last menu accessed with the original parameters; Cancel will go back to the last menu accessed with changes saved.
- 12 The transcoder will search for the signal and display "Acquisition Successful." It will find the first available channel on the network. Press **MENU** twice to return to the start-up menu.

Chapter 2 Quick Setup - Read Me First!

- 13 If the front LED is solid green, the unit is authorized. Proceed with *Assigning a Program Channel to a PE (Program Entry)* (on page 15)). If the front LED is flashing green, the unit is unauthorized. Please contact your service provider and provide the Tracking ID number for authorization. The Tracking ID can be found on the **ABOUT** menu. To locate the Tracking ID, press **MENU**, press **▶** twice, and then press **SELECT** twice. Make a note of the Tracking ID number. Press **MENU** three times to return to the startup screen.

Assigning a Program Channel to a PE (Program Entry)

- 1 At the start-up screen, PE1 is initially displayed.

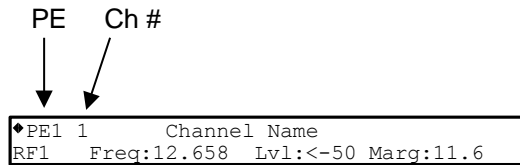

- 2 Press **ADV** and use the **▲▼** keys to scroll through the available program entries.
Note: The D9859 is available in an eight channel configuration.
- 3 Press **ADV** again to select the channel number.
- 4 Use the **▲▼** keys to scroll through the available program channels or directly enter the channel number using the 0 to 9 keys; press **SELECT** to save the channel selection.
Note: Enter 0 to remove the program channel from the Program Entry.
- 5 Repeat steps 2 to 4 to select another authorized program to decode.

Setting up the ASI Output

- 1 Press **MENU** to move to the Main Menu.
- 2 Press **▶** to move to the **Setup** menu. Press **SELECT**.
- 3 Press **▼** to move to the **Outputs** menu. Press **SELECT**.
- 4 Press **▶** to move to the **TS Out** menu. Press **SELECT**.
- 5 Press **SELECT** to access the **ASI** menu. Press **▼**. Press **SELECT**. Use **▲▼** to select the output mode. The factory default is "No Output". It is recommended to set the **Output Mode** to **Transcoding**.
- 6 Press **SELECT**. Press **▶** to select "YES" if requested to "RESYNC ALL?". Press **SELECT**.
- 7 Press **▼** to move to **Descramble Mode** menu. Press **SELECT**. Use **▲▼** to select the scrambling mode. Press **SELECT**.
- 8 Press **▶** to move to **Insert Null Packet**. Press **SELECT**. Use **▲▼** to change the mode to Yes. Press **SELECT**.
- 9 Press **APPLY**. Press **SELECT**.
- 10 Press **MENU** five times to return to the startup menu.

Setting the DPM Mode

A program can be set to one of four Digital Program Mapping (DPM) modes, either Drop, Pass, Map, or Xcode. For more information, see *TS Out - DPM* (on page 99).

LCD Setting	Description
Drop	Removes the service and its associated PMT reference from the transport output.
Pass	Permits the source content and PMT reference to appear in the transport output with the same references unless the source material is mapped on another PE.
Map	Provides the flexibility to define all the outgoing PID numbers for a PE, including those not currently on transmission.
Xcode	Provides the flexibility to define all the outgoing PID numbers for a PE, including those not currently on transmission, as in Map mode, plus the video PID is transcoded to output at the rate and settings defined for the transcode channel.

- 1 Press **MENU** to display the Main Menu.
- 2 Press **▶** to move to the Setup menu. Press **SELECT**.
- 3 Press **▶** four times to move to the Outputs menu. Press **SELECT**.
- 4 Press **▶** to move to the TS Out menu. Press **SELECT**.
- 5 Press **▶** twice to move to the DPM menu. Press **SELECT**.
- 6 Press **SELECT** to access the Global menu.
- 7 Press **SELECT** to choose ASI for Resync All. Press **▶** and then press **SELECT** to continue.
- 8 Press **MENU**. Press **▶** to move to the ASI menu. Press **SELECT**. Verify the PE1 "InCh" and "OutCh" programs.
- 9 Press **▶** three times to choose Act. Press **SELECT**. Use **▲▼** to select the DPM mode. Xcode (Transcode) is the most common mode. Press **SELECT**. Press **APPLY**. Press **SELECT** to save the changes.
- 10 Press **◀** three times to choose PE1. Press **SELECT**. Use **▲▼** to select PE2. Press **SELECT**. Verify the PE2 "InCh" and "OutCh" programs.
- 11 Press **▶** three times to choose Act. Press **SELECT**. Use **▲▼** to select the DPM mode. Xcode (Transcode) is the most common mode. Press **SELECT**. Press **APPLY**.
- 12 Press **MENU** six times to return to the startup screen.

3

Installation

Introduction

This chapter contains the information for technicians installing the Cisco D9859 Advanced Receiver Transcoder.

Qualified Personnel

Only appropriately qualified and trained service personnel should attempt to install, operate, or maintain the D9859 transcoder.



WARNING:

Allow only authorized and qualified service personnel to install, operate, maintain, and service this product. Otherwise, personal injury or equipment damage may occur.

In This Chapter

- Power Connection20
- Installing the D9859 Transcoder21
- Rear Connector Panel23
- Connecting the Input/Output Signals25
- Setting Admin User Privileges via a Telnet/SSH Connection30

Power Connection

To operate the transcoder, you must connect it to an AC power source. For information about connecting the chassis to AC power, see *Appendix A - Technical Specifications* (on page 321).

As Cisco units are designed for continuous operation, some products do not have a power switch. In this case the mains cord and/or DC power supply cable serve(s) as the mains disconnect device.



WARNING:

Make sure that at least one end of the power cable(s) remains easily accessible for unplugging, if you need to switch off the unit. For example, ensure that the socket outlet is installed near the product.



WARNING:

To avoid electrical shock, connect the three-prong plug on this product to an earth-grounded three-pin socket outlet only.

Installing the D9859 Transcoder

Rack Mounted

The D9859 transcoder is a 1U unit with connector access at the rear panel. The transcoder is intended for mounting in a standard 19" rack with minimum 1U spacing between units to allow adequate ventilation/air flow.

The D9859 transcoder is vented from front to back. Multiple units can be stacked in a rack, provided that adequate cooling is available.

Cooling

The D9859 transcoder is cooled by the use of internal fans. The air intake is from the front and the air outlet is on the rear.

Note: Adequate cooling must be provided equaling 110 W (maximum) at 25°C per unit to avoid overheating.



CAUTION:

The inlet air temperature must not exceed 50°C/122°F at any time.

Grounding

You must ensure that the unit is properly connected to ground in order to meet safety and EMC requirements. Before any other connection is made, the unit must be connected to a protected ground terminal as described below:

- Via the three wire power cord of the AC power supply. This connection is mandatory.
- In addition, via the protective ground terminal on the rear panel of the unit. This connection provides additional protection of the equipment.

Mounting the D9859 Transcoder to a Rack

- 1 Mount L-brackets in the rack to support each D9859 transcoder to be installed.
- 2 Place the transcoder in its position in the rack.
- 3 Mount the transcoder securely to the rack by securing the mounting flanges to the rack using the four screws provided.
- 4 Make sure the air outlet holes on the back of the transcoder are not obstructed to allow air flow from the front to the back of the chassis.

Connecting the AC Power to the D9859 Transcoder

- 1 Connect the power cord (supplied with the D9859 transcoder) between the rear panel power receptacle and a 100 to 120/200 to 240 V AC power outlet.
- 2 Make sure that the power cable is connected to protective ground. See for *Grounding* (on page 21) more information.

The D9859 transcoder is equipped with one power supply located in the rear of the chassis. Note the location of the power supply in the event of alarms/warnings resulting in replacement of a power supply. Alarm messages appear in the Message Log.

Rear Connector Panel

The following diagram show the rear connector panel of the D9859 transcoder:

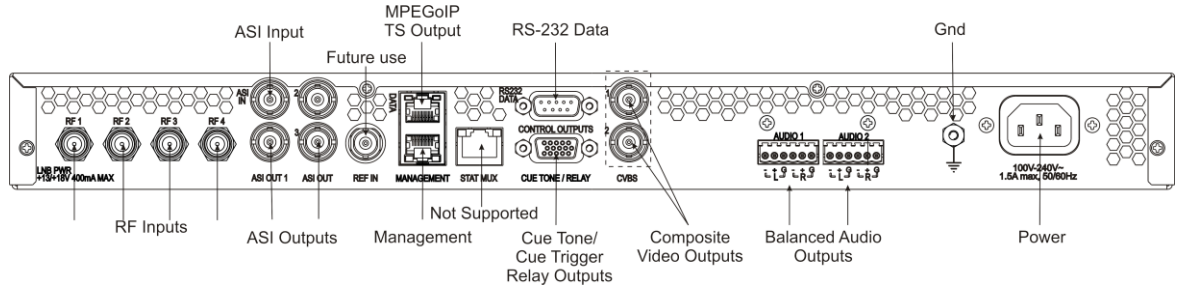

The following table describes the function and type of the various connectors.

Connector	Description	Type
RF Inputs	Each input accepts an LNB signal input. RF1 provides LNB power for use when no external LNB power source is available. RF2 to RF4 require an external LNB power source.	F
Reference Input	For future use.	BNC
ASI Input	Asynchronous Serial Interface Input.	BNC
ASI Outputs	Three Asynchronous Serial Interface Outputs.	BNC
TS Output (Data)	This is for the MPEGoIP and MPE outputs. The MPEGoIP output of the transport stream is encapsulated in the IP packets to a groomer for distribution. The MPE output receives IP packets from the transport stream.	RJ-45
Management	For accessing the web GUI and upgrading the D9859 software application (code downloading).	RJ-45
Cue Tone/Cue Trigger Relay Outputs	Program relay provides programmed responses for alarms, cue trigger states for ad-insertion equipment, or a cue tone output for connection to ad-insertion equipment.	15-pin sub-D female
RS-232 Data	RS-232 data output: 7 bits, even parity, 1 stop bit, up to 38.4 kbps. These outputs are user-configurable via the Setup menu on the front panel	9-pin sub-D female

Chapter 3 Installation

Connector	Description	Type
Composite Video Outputs	CVBS 1 and CVBS 2 provide two identical SD composite video outputs for monitoring applications.	BNC
Balanced Audio Outputs	Audio 1 and Audio 2 provide two stereo pairs or four mono channels.	Terminal Blocks
Ground	Screw	Grounding point for the transcoder
Power	AC power	IEC 60320 Sheet 14

Connecting the Input/Output Signals

Connecting the RF Inputs

Connect up to four LNB RF cables to the RF connectors labeled RF1 through RF4 on the rear of the unit.

Use 75-ohm (braid/foil or braid/braid), low insertion loss coaxial cable.

Each input accepts an LNB signal input. RF2 to RF4 require an external LNB power source.

Connecting the ASI Input

If desired, connect to the ASI IN port to an asynchronous serial interface for uplink monitoring.

Connecting the Video Outputs

Connector for the Video Output

The video output connectors are of the BNC type.

Connecting the Composite Video Output

Connect a video monitor to the CVSB 1 and CVSB 2 connectors. The two outputs are identical. Use a 75-ohm double-braided coax cable.

Connecting the Balanced Audio Output

- 1 Connect the AUDIO 1 and AUDIO 2 balanced audio outputs to monitoring equipment. Use a multi-conductor, pluggable cable from the transcoder's AUDIO 1 and AUDIO 2 (Left and Right) terminals to your equipment, as shown in the following illustration.

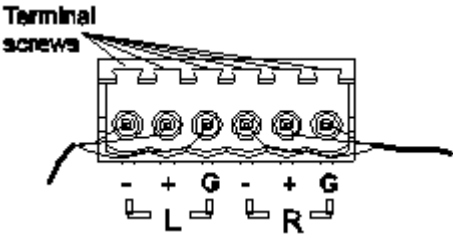
Connector	Connector type
 <p>Terminal screws</p>	Terminal Block

- 2 Feed the stripped ends of the positive, negative and ground wires into the appropriate terminals as labeled, and then screw the terminal screws (located on the top of the terminal block) finger tight to each wire.

Connecting the Ethernet Management Interface

The RJ-45 interface for 10/100/1000BASE-T Ethernet is currently intended for upgrading/downloading the software application.

Hint: If you experience problems with the 10BASE-T Ethernet it is advised that you change it to a 100BASE-T connection.

You must set up the IP address, the default gateway and the subnet mask to match the network connection. This is done through the front panel menu. For more information, see *IP* (on page 69).

Proper cables are required for reliable Ethernet operation; to run over a maximum segment length of 100 m the cable has to comply with the EIA/TIA Category 6 wire specifications.

- 1 Connect a crossed RJ-45 cable between the Ethernet connector on the D9859 transcoder and the Ethernet port of your PC.

Note: You need a crossover cable if you want to connect the Ethernet interface of the D9859 transcoder directly to another Ethernet device without using a hub or switch.

- 2 Set up the IP address on the D9859 transcoder (via the front panel display). For information on setting up the IP address via the front panel, see *IP* (on page 69).

Connecting the IP TS Output

The RJ-45 interface IP TS OUT is 10/100/1000BASE-T Ethernet. It is intended for both MPEGoIP and MPE outputs. The MPEGoIP output of the transport stream is encapsulated in the IP packets to a groomer (for example, Cisco D9900 Digital Content Manager) for distribution. The MPE output receives IP packets from the transport stream.

Note: For reliable Ethernet operation up to the maximum segment length of 100 m, ensure that the cable complies with the EIA/TIA Category 6 wire specifications.

Connect a crossed RJ-45 cable between the Ethernet connector (DATA port only) on the D9859 transcoder and the Ethernet port of the equipment after the D9859 transcoder. The equipment after the D9859 transcoder could be an IP router or a switch.

Connecting the ASI Outputs

Proceed as follows to connect to the ASI outputs:

- 1 Connect the output signal from the D9859 transcoder ASI OUT connectors. All three outputs, ASI OUT 1, 2 and 3 are identical.
- 2 Use a Belden “Brilliance” cable with foil/braid construction. The shield must provide 99% or better shielding effectiveness.

The equipment after the D9859 transcoder could be a Cisco D9887 HDTV Modular Receiver or Cisco D9854 Advanced Program Receiver.

Connecting an External Alarm System

The D9859 transcoder is equipped with a connector labeled Cue Tone/Relay which provides alarm relay outputs for remote alarm signaling. This connector provides Cue Tone, Cue Trigger and Alarm relay functionality. See *Connecting the Cue Tone/Cue Trigger Interface* (on page 28) for more information on Cue Tone and Cue Trigger equipment connections. These contact closure outputs are user-configurable via the Setup Menu on the front panel.

The Alarm output connector is a 15-pin sub-D female connector. The diagram below shows the connector and the pin allocation table for the Alarm output pins.

The connector pin states depend on the selected Relay Mode. The Relay Mode is set on the front panel. For more information, see *Cueing* (on page 89).

Changing the Relay Mode for Alarm Monitoring

The Alarm relay is a program relay that can be configured to provide programmed responses for alarms, warnings, cue trigger states for ad-insertion equipment, or a cue tone output for connection to ad-insertion equipment. As a default, the Alarm Relay is configured for Trigger mode.

- 1 On the front panel menu, go the Main: Setup: Outputs, and select **Cueing**.
- 2 Use the down arrow key to scroll through the Cueing menu to Relay Mode.
- 3 Select **Relay Mode**, change the state to **Alarm** and press the **Select** key to save the new setting. As a result, the rear panel connector pin states will change to that shown in the table below for Alarm mode.

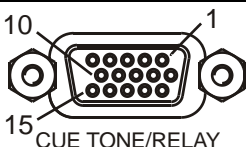
Connector	Normally closed pin	Common pin	Normally open pin	Relay Mode
	11	10	15	Trigger
	15	10	11	Alarm (default)

Note: A Normally closed state implies the state when power is applied to the relay in a normal operating state, without a trigger or alarm condition present.

Connecting the RS-232 Data Interface

The DCE DB-9 female connector is intended for low-speed data: 7 bits, even parity, 1 stop bit, up to 38.4 kbps (default). These outputs are user-configurable via the Setup Menu on the front panel.

The interconnect cable from the D9859 transcoder to a PC should be straight through (for example, no handshaking), shielded and equipped with a DB-9 male connector at one end to mate with the rear panel RS-232 Data interface, and a female DB-9 connector to connect to the PC.

RS-232 Data Connector Pin Allocation

The table shows the RS-232 Data connector and the pin allocation:

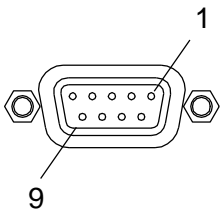
Connector	Normally closed pin	Common pin
	1	Not connected
	2	TxD
	3	RxD
	4	Not connected
	5	Ground
	6	Not connected
	7	Not connected
	8	Not connected
	9	Not connected

Connecting the Cue Tone/Cue Trigger Interface

The D9859 transcoder is equipped with a connector labeled Cue Tone/Relay for alarm relay outputs for remote alarm signaling. This connector provides Cue Tone, Cue Trigger and Alarm relay functionality. These outputs are user-configurable via the Setup Menu on the front panel.

The connector is a 15-pin sub-D female connector. The following diagram shows the connector and the pin allocation table for Cue Tone, Cue Trigger and Alarm relay connections.

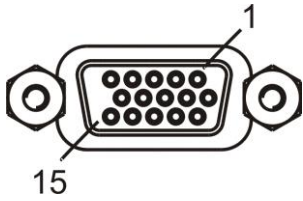
Connector	Pin	Pin allocation
	1	Cue Trig 1
	2	Cue Trig 2
	3	Cue Trig 3
	4	Cue Trig 4
	5	Cue Trig 5
	6	Cue Trig 6
	7	Cue Trig 7
	8	Cue Trig 8
	9	Not connected
	10	Alarm - Ground
	11	Alarm - Normally open
	12	Chassis ground
	13	Cue Tone -
	14	Cue Tone +
	15	Alarm - Normally closed

Connecting the Cue Tone Interface

Connect the Cue Tone pins, 13 and 14 to a device to facilitate ad-insertion using DTMF Analog Cue Tones.

Connecting the Cue Trigger Interface

Connect the Cue Trigger pins (1 to 8) to up to 8 serial control devices or a device to control ad-insertion. These outputs are user-configurable on the front panel menu.

Configuring Open-collector Outputs

The D9859 supports decoding of SCTE-35 messages with DTMF descriptor. The D9859 outputs tones or sets the open collector contacts according to the content of the DTMF descriptor in the Cisco D9054 HDTV Encoder and the Cisco D9036 Modular Encoding Platform. For information on the open-collector output settings, see the *Cisco D9054 HDTV Encoder Installation and Operation Guide* and *Cisco D9036 Modular Encoding Platform Installation and Configuration Guide*.

Setting Admin User Privileges via a Telnet/SSH Connection

Administrator User Privileges

Up to 10 usernames/passwords can be defined for login use via a telnet, SSH, or Web GUI (for example, http) session on the D9859 transcoder.

When a user tries to login via a telnet, SSH, or http connection, the user is required to provide a username and a password. The user is granted access only if this username/password pair exists in the authentication table.

The factory preset "Admin" account has Admin privileges and is allowed to add new users, delete users, change usernames, and modify its own passwords. Users with non-Admin privileges (for example, User and Guest) are only allowed to modify their own passwords.

Starting a Telnet/SSH Session

To start a communication session with the transcoder, use a utility such as Tera Term Pro or PuTTY.

Proceed as follows to log into a new connection using Tera Term:

- 1 In the New Connection window, enter the IP address in the **Host** field.
- 2 If you want to start a telnet session, select **Telnet** and enter 23 in the **TCP Port#** field.
- 3 If you want to start an SSH session, select **SSH** and enter 22 in the **TCP Port#** field.
- 4 Click **OK**.
- 5 If you started a Telnet session:
 - a At the Login prompt, type the username and press **Enter**.
 - b At the Password prompt, type the password and press **Enter**.
Note: The username and password are case-sensitive. The default username is **admin** and the default password is **localadmin**.
 - c Type **lr** and press **Enter**.
- 6 If you started an SSH session:
 - a A Security Warning message is displayed (first time only). Select **Add this machine and its key to the known hosts list** and click **Continue**. The SSH Authentication window is displayed.
 - b In the **User name** field, type the username, **admin**.

- c In the **Passphrase** field, type the password, **localadmin**. Wait a few seconds, until the **Use rhosts to log in** is disabled.

Note: The username and password are case-sensitive. The default username is **admin** and the default password is **localadmin**.

- d Click **OK**.

- 7 Type **lr** and press **Enter**.

Adding a New User

- 1 At the admin prompt, type **pwd add_user** and press **Enter**.
- 2 At the NEW USERNAME prompt, type a new username and press **Enter**.
- 3 At the NEW PASSWORD prompt, type a new password and press **Enter**.
Note: The new password must follow the rules configured in the Password Complexity parameter. For more information, see *To Change the User Login Passwords* (on page 245) for the web GUI or *Setup Menu: IP* (on page 68) for the Front Panel.
- 4 At the CONFIRM NEW PASSWORD prompt, type the new password again and press **Enter**.

Note: The New Password and Confirm New Password should be identical.

- 5 At the NEW USER PRIVILEGES prompt, enter the type of account you want to assign the user. The following table illustrates the different login types:

Account Type	Enter	Access
Guest	3	View settings only.
User	2	View and edit settings.
Admin	1	View, edit settings, and add/delete user accounts.

- 6 At the ADMINISTRATOR PASSWORD prompt, type the administrator's password and press **Enter**.

Deleting a User

- 1 At the admin prompt, type **pwd del_user** and press **Enter**.
- 2 At the USERNAME prompt, type the username you want to remove and press **Enter**.
- 3 At the ADMINISTRATOR PASSWORD prompt, type in the administrator's password and press **Enter**.

Changing a Username

- 1 At the admin prompt, type **pwd username_change** and press **Enter**.
- 2 At the CURRENT USERNAME prompt, type the username you want to edit and press **Enter**.
- 3 At the NEW USERNAME prompt, type the new username and press **Enter**.
Note: Ensure that the new username does not match any of the usernames already defined in the authentication table.
- 4 At the ADMINISTRATOR PASSWORD prompt, type the administrator's password and press **Enter**.

Changing a Password (allowed by all Users)

Passwords can be changed by all users.

- 1 At the admin prompt, type **pwd password_change** and press **Enter**.
- 2 At the CURRENT PASSWORD prompt, type the current login password you want to change and press **Enter**.
- 3 At the NEW PASSWORD prompt, type a new login password and press **Enter**.
- 4 At the CONFIRM NEW PASSWORD prompt, type the new login password again to confirm and press **Enter**.
Note: The new password and the confirm new password should be identical. Each user, including the admin user, can modify only his own password.

Printing the List of Users

At the admin prompt, type **pwd list_users** and press **Enter**.

Note: Only usernames will be printed. Passwords will not be visible.

Resetting the Login Credentials

At any time, the user authentication table can be reset from the front panel. This option is under the Setup: IP: IP menu. Scroll down to Reset Credentials and press **SELECT**. Press **►** and then press **SELECT** to confirm the operation. A new login username and randomly generated password will be displayed on the front panel display for approximately 30 seconds. The new account will have Admin privileges. We recommend that this account be replaced by a login username and password chosen by the administrator. To change the username and password, you must be an Admin user. Refer to *To Change the User Login Passwords* (on page 245).

Note: After this recovery procedure, all existing user accounts will be lost.

4

Front Panel Operation

Overview

This chapter describes how to set up the Cisco D9859 Advanced Receiver Transcoder using the front panel keys and display. This information is primarily applicable for standalone operations.

In This Chapter

■ About the Front Panel	34
■ Locking/Unlocking the Front Panel	38
■ Startup Screen.....	39
■ Main Menu	43
■ Status Menu	44
■ Setup Menu	56
■ About Menu	124
■ Versions Menu	126
■ Diagnostics Menu	129

About the Front Panel

The D9859 transcoder is operated using controls and indicators on the front panel. These include the numeric keypad, the Navigation/Selection keypad, the LCD, the Alarm and Signal indicators. These are shown in the following illustration.



LCD

The LCD provides information on the selections available at any menu level, current settings for parameters, and certain status and alarm indications. This is a 2x40, backlit LCD display. The top line may be status data or identifier information. It can also display optional functions available for tuning operations. The bottom line will show selections or parameter values available using the navigation/selection keypad. The items are selected by pressing the **SELECT** (center key) or the ▼ (down arrow) key on the navigation/selection keypad.

Keypad

The numeric keypad is used to enter alphanumeric values. The **MENU** key sets the software to the initial menu and returns to the previous menu. The **MENU** key can also be used to cancel a numeric entry at any point during the entry sequence, and the ◀ (left arrow) key allows backspacing through the entry.

Front Panel LEDs

The functions of the LEDs are described in the table below.

LED	Signal State/Color	Explanation
ALARM	Red	Solid for five seconds indicates a Warning.
	Red	Flashing indicates an Alarm.
SIGNAL	Green	Solid indicates all of the following conditions: <ul style="list-style-type: none"> ■ active RF inputs are enabled, locked to a signal, and are not muted. ■ all outputs are operating without an error.

LED	Signal State/Color	Explanation
	Green	Flashing indicates one of the following conditions: <ul style="list-style-type: none"> ■ difficulty with an input, route or output. ■ one or more RF inputs, or the ASI input are not synchronized. ■ one or more outputs are routed, but muted by a fault condition. ■ no RF signal is present or detected, or it is muted. ■ transcoder is not authorized to receive the program.
	Off	Off indicates all of the following conditions: <ul style="list-style-type: none"> ■ no RF input signal is available, enabled or detected, or the input is muted. ■ no ASI input is present ■ no valid inputs are available.

Navigation/Selection Keypad





Throughout this manual, there are references to parts of a keypad on the front of the receiver. The navigation keys (**LEFT**, **RIGHT**, **UP** and **DOWN**) and the **SELECT** key are the primary controllers. Each navigation key performs various functions, depending on the current state of the menu system (i.e., sometimes the left navigation key backspaces over an entry and sometimes moves the cursor to a different menu item). Once the cursor is over the desired function, pressing the **SELECT** (center key) key selects the current item. Pressing the **SELECT** key stores any entered values.

The following is the Navigation/Selection keypad, which changes its function, depending on the current state of the menu:



The following table shows which parts of this integral interface are being referenced by which term.

Chapter 4 Front Panel Operation

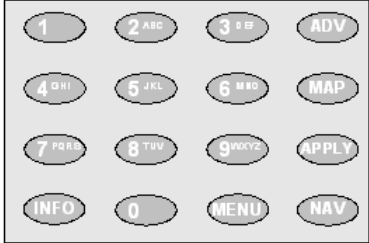
Button	Function	
LEFT Arrow key	When moving through menus, it highlights the menu item to the left. When entering data, it moves the cursor to the left. In some menus, it backspaces over the data entry.	
RIGHT Arrow key	When moving through menus, it highlights the menu item to the right. When entering data, it moves the cursor to the right.	
UP Arrow key	Highlights the menu item above.	
DOWN Arrow key	Highlights the menu item below.	
SELECT key	Runs the highlighted command or opens the highlighted menu.	
INFO key	<p>Press the key on the lower left of the numeric keypad for context-sensitive help messages, when available.</p> <p>When entering characters in numeric or alphanumeric fields, this key can be used to toggle between upper and lower case.</p>	
MENU key	Press the key on the lower right of the numeric keypad. Starts the on-screen display. Also functions as the Escape key so you can back out of menus and data entry fields.	

Button	Function
Alphanumeric Entry	<p>Pressing the numeric keys 2-9 once will enter the respective digit into a data entry field. Pressing these buttons again will enter the first of the letters displayed beside the number. Repeatedly pressing the button will toggle through all of the key's possible choices. When entering text, the 1 button can be used to insert spaces (press twice). To delete a character, press 0 twice.</p>
ADV	Toggles between Program Entry and Channel number.
MAP	Edit, insert, and delete Digital Program Mapping (DPM) Modes on Program Entries or on PIDS within Program Entries.
APPLY	Activates current changes without having to exit the menu.
NAV	For future use.

Locking/Unlocking the Front Panel

Depending on the customer's default settings, the receiver is shipped with a locked or unlocked front panel. You can lock or unlock the front panel using the front panel keypad.

Proceed as follows to unlock the front panel using the front panel keypad:

- 1 From the Startup screen, press **SELECT** and then **INFO**. This will unlock the front panel keypad and allow you to make changes to all the operating parameters; however, if the keypad remains untouched for the duration of the set timeout period (default is 60 seconds), the keypad will change back to the Lock state unless you change the keypad state on the Admin Menu. Likewise you can toggle the keypad lock state back using **SELECT** and **INFO** at any time, provided the KB Lock state on the Admin Menu is Enabled. For more information on front panel keypad buttons, see *Keypad* (on page 34).

Note: If the lock level is 3 or 4, you must enter a password to unlock the front panel. For more information on lock level password, see *Setup Menu: Admin* (on page 57).

- 2 To disable Lock completely, navigate to **Setup, Admin, KB Lock** in the LCD display and press the **SELECT** key.
- 3 Change the **KB Lock** state from **Enabled** to **Disabled**.
- 4 The front panel will now be unlocked, allowing you to change any of the operating parameters.

To lock the front panel, perform the same procedure, except use **▲▼** to change the state. In this case, you will not be prompted to confirm the operation.

Startup Screen

Main Structure

On power-up and initialization, the startup screen is displayed similar to that shown below. The screen also indicates the signal status.

PE1 ♦12345 Channel Name RF1 Freq:12.658 Lvl:100 Marg:10.8	PE: 1 2 3 4 5 6 7 8 9 10111213141516 Auth: Y N Y N Y Y Y Y Y Y Y Y Y Y
Startup Screen	Channel Authorization Status Screen

Channel Authorization Status

From the startup screen, press the right or left arrow keys on the front panel keypad to move to the PE entry authorization status screen. This screen indicates whether the selected channel is authorized.

Auth Status	Description
Y	Indicates the channel is authorized.
N	Indicates the channel is not authorized.

LCD Panel

The LCD panel displays basic signal and program information in the LCD display, as described in the following illustration:

PE1♦12345 Channel Name RF1 Freq:12.658 Lvl:<-70 Marg 17.2	⌘
--	---

LCD Setting	Description
PE	Program Entry. The transcoder supports eight Program Entries (PE1 to PE8). PE1 is the decode channel and is available at the analog outputs. PE2 to PE8 are available for the transcoded channels on the ASI and MPEG over IP outputs.
12345	Channel for program monitoring.
Channel name	Name of the monitored program.
RF	Active RF input port. Note: ASI will be shown if the ASI input port is active.

LCD Setting	Description
Freq:	Downlink frequency of the tuned signal in GHz.
Lvl:	Signal level in dBm.
Marg:	Carrier-to-noise (C/N) margin in dB.
DEGD	The Degraded indicator only appears if there is degraded tuning information in use. This occurs if the SI tables are not consistent on the incoming stream. The receiver will attempt to identify the service list based on the information available. Check the SI acquisition and stream information to ensure that the channels, network, and tuning information are operating as expected.



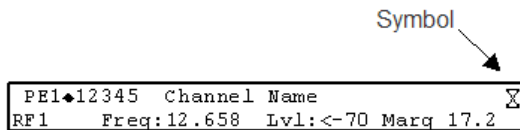

LCD Symbol

Various symbols will periodically appear in the top right-hand corner of the LCD panel, indicating which user actions are currently acceptable. The following displays the location of the symbol:



The following table describes the various symbols:

LCD Symbol	Description
⌚	The Hourglass indicates that parameters are being saved in the background. You can continue to perform any operation desired. Note: If a power-cycle/interruption occurs while the hourglass is displayed, some parameters may not be saved. Refrain from powering off the unit while the hourglass is displayed.
ⓘ	The Info symbol indicates that the INFO key is active. In most cases, this will display contextual information on the LCD screen.
Ⓢ	The Select symbol indicates that the SELECT key is active.
◀▶	The Left/Right symbol indicates that the RIGHT/LEFT arrow key is active; e.g., pressing the RIGHT/LEFT arrow key will have an affect, such as moving the cursor to the right/left.

LCD Symbol	Description
▲▼	The up/down symbol indicates that the UP/DOWN arrow key is active.
	The Download In Progress (DL) symbol indicates that the transcoder is currently downloading a software update and storing it into memory in the background. Note: Service interruption occurs during a reboot, which is always required when the transcoder's software is updated.
	The Download Trigger (DT) symbol indicates new software is ready for download, but a download trigger by the transcoder is required before it will be downloaded. Note: Service interruption occurs during a reboot, which is always required when the transcoder's software is updated.
	The Download symbol indicates that a software download for a version of software already in memory has been detected.
	The Disaster Recovery (DR) symbol indicates that a disaster is declared on the current transcoder.
o	The Session Open symbol indicates that you are changing a group of related items.

Assigning Program to the Program Entry

To assign a program to the PE:

- 1 Press **MENU** until you display the startup screen.

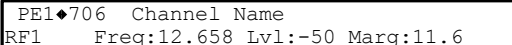
PE # Ch #
 ↓ ↓

The PE (Program Entry) channel is initially displayed.

Note: PE1 is the default.

Chapter 4 Front Panel Operation

- 2 Press the **ADV** key to select PE1.

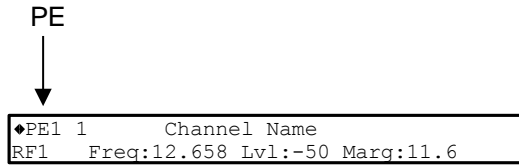

- 3 Press **▲▼** to scroll through the available program entries.
- 4 Press **ADV** again to select the channel number.

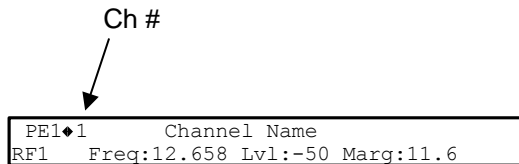

- 5 Directly enter the channel number using the 0 to 9 keys and press **SELECT** to apply the channel number, or press **▲▼** to scroll through the available channels.

Deleting a Program from the Program Entry

To delete a program from the PE:

- 1 Press **MENU** until the startup screen appears.

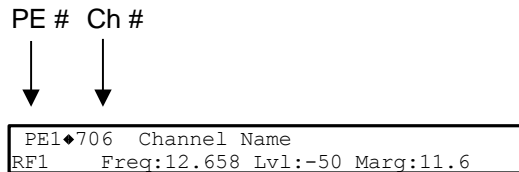

The PE channel is displayed.

Note: PE1 is the default.

- 2 Press the **ADV** key to select PE1.

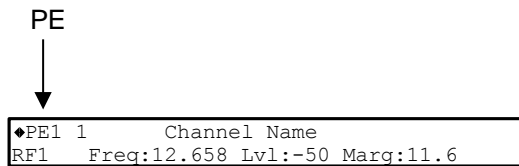

- 3 Press the **▲▼** to scroll through the available program entries.
- 4 Press **ADV** again to select the channel number.
- 5 Enter the channel number 0 with the numeric keys and press **SELECT** to apply and delete the program.

Main Menu

Operation of the D9859 Advanced Receiver Transcoder begins at the Main menu. From the startup screen, press the **MENU** key to view the Main menu.

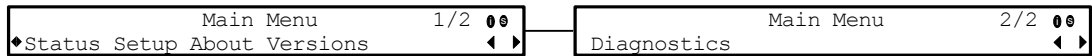

Select the desired function by moving the cursor left or right by pressing the **LEFT** or **RIGHT** arrow key. Once a selection is made by pressing the **SELECT** key, the LCD presents the second menu level for the selected function. Succeeding levels for each function include all the hierarchical levels for the function in the front panel LCD.

Status Menu

Structure

To view the **Status** menu from the **Main menu**, press the **SELECT** key. The **Status** menu indicates the status of the input and output signals, the video and audio services, and allows you to browse and/or configure the alarms and warnings.

The **Status** menu is split into four parts; General, Services, TS Input, TS Output, and IP. Each parameter is described in this section. For instructions on how to select and store settings, see *About the Front Panel* (on page 34).

The **Status** menu has the following structure:

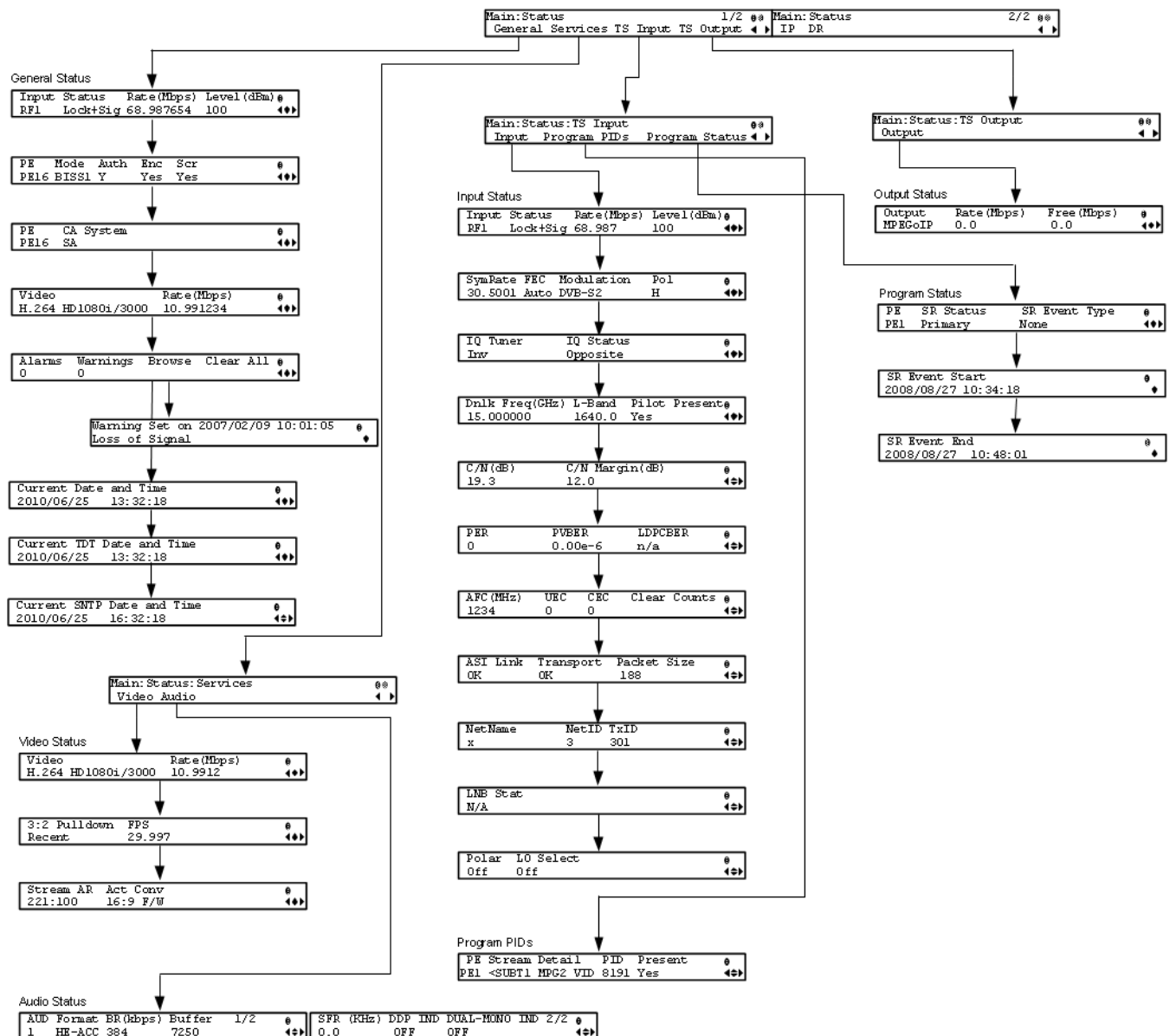

Status Menu: General

Menu Item	Description	Parameters
Input	Indicates the currently selected input source.	RF1 to RF4, or ASI
Status	Indicates whether the input signal is locked.	Locked - Indicates the receiver is locked to a carrier with no valid content. Lock+Sig - Indicates the receiver is locked to a carrier with valid content. No Lock - Indicates the receiver is not locked to a carrier.
Rate (Mbps)	Indicates the bit rate of the input transport stream, in Mbps.	
Level (dBm)	Indicates the strength of the received signal level, in dBm.	
PE	Select the Program Entry to view.	PE1 to PE8
Mode	Indicates how the program is scrambled.	Unkn, DES, DVB, BISS1, BISS2, or BISS3
Auth	Indicates whether the receiver is authorized to receive the program.	Yes or No
Enc	Indicates whether the received program is encrypted.	Yes or No
Scr	Indicates whether the received program is scrambled.	Yes or No
CA System	Indicates the type of Conditional Access (CA) system used by the program.	SA, BISS, or FTA (Free To Air)
Video	Indicates the video encoding, format, and resolution of the received program.	MPEG1, MPEG2, or H264 format with a resolution of: SD480i/2997, SD480i/3000, SD576i/2500, HD720p/5000, HD720p/5994, HD720p/6000, HD1080i/2500, HD1080i/2997, or HD1080i/3000 Unknown or Unsupported
Rate (Mbps)	Indicates the bit rate of the received video stream, in Mbps.	
Alarms	Displays the number of active alarms.	
Warnings	Indicates the number of active warnings.	

Chapter 4 Front Panel Operation

Menu Item	Description	Parameters
Browse	Select to view the current active alarms and warnings, including additional details.	
Clear All	Select to clear all the active alarms and warnings. You will be prompted to verify whether you want to clear all the alarms and warnings.	Abort, Continue. Select Abort to cancel the operation or Continue to clear all the warnings and alarms.
Current Date and Time	Displays the current SNTP date and time, if available. Otherwise, the current TDT date and time is displayed. Note: This is displayed as local time.	
Current TDT Date and Time	Displays the current TDT (Time and Date Table) date and time received from the DVB stream. Note: This is displayed as local time.	
Current SNTP Date and Time	Displays the current SNTP (Simple Networking Time Protocol) date and time if IRD receives a valid reply from the NTP server. Note: This is displayed as local time.	

Status Menu: Services

Video

Menu Item	Description	Parameters
Video	Indicates the video encoding, format, and resolution of the received program.	MPEG1, MPEG2, or H264 format with a resolution of: SD480i/2997, SD480i/3000, SD576i/2500, HD720p/5000, HD720p/5994, HD720p/6000, HD1080i/2500, HD1080i/2997, or HD1080i/3000 Unknown, or Unsupported
Rate (Mbps)	Indicates the bit rate of the received video stream, in Mbps.	
3:2 Pulldown	Indicates whether the 3:2 pull-down is detected, was recently detected, or not detected in the input video stream.	Yes, No or Recent
FPS	Indicates the frame rate of the input video stream.	Typically 25.0, 29.97, 30.0, 50.0, 59.94, 60.0, unknown or unsupported

Status Menu

Menu Item	Description	Parameters
Stream AR	Indicates the aspect ratio of the incoming video stream.	4:3, 14:9 or 16:9
Act Conv	Displays the actual applied aspect ratio conversion.	None, 4:3 L/B, 4:3 P/B, 14:9, 14:9, 4:3 F/H or 16:9 F/W

Audio

Menu Item	Description	Parameters
AUD	Indicates the current audio decoder status.	AUD1 for audio channel Aud1. AUD2 for audio channel Aud2. AUD1 to AUD4 for two stereo audio channels.
Format	Indicates the format of the audio input stream.	None, Sine, Pink, Beep, MPEG1L1, MPEG1L2, MPEG2L1, MPEG2L2, AC3, LOAS AAC, ADTS AAC, LOAS HEAAC, ADTS HEAAC, or DDP
BR (Kbps)	Indicates the bit rate of the audio input stream, in kbps.	
Buffer	Indicates the buffer level of the input audio stream, in bytes.	
SFR (KHz)	Indicates the sample rate of the input audio stream, in kHz.	32.0, 44.1, or 48.0 kHz
DDP IND	Indicates the presence of Dolby® Digital Plus frames within a Dolby Digital Plus audio stream.	OFF or ON
DUAL-MONO IND	Indicates the presence of dual mono audio outputs in the audio stream. If the dual mono indicator is set to ON, the left and right outputs will correspond to mono channel 1 and mono channel 2 respectively.	OFF or ON

Status Menu: TS Input

Input

Menu Item	Description	Parameters
Input	Indicates the active input port receiving the signal.	RF1, RF2, RF3, RF4, or ASI

Chapter 4 Front Panel Operation

Menu Item	Description	Parameters
Status	Indicates the current signal lock status for the input.	Locked - Indicates the receiver is locked to a carrier with no valid content. Lock+Sig - Indicates the receiver is locked to a carrier with valid content. No Lock - Indicates the receiver is not locked to a carrier.
Rate (Mbps)	Indicates the bit rate of the received input signal.	in Mbps
Level (dBm)	Indicates the signal level of the received signal.	in dBm
SymRate	Indicates the Symbol Rate of the received signal.	in Msymbols/second
FEC	Indicates the FEC (Forward Error Correction) rate of the received signal.	N/A, 1/2, 3/5, 2/3, 3/4, 4/5, 5/6, 7/8, 8/9 or 9/10
Modulation	Indicates the modulation type for the received signal.	N/A, QPSK, 8PSK, DVB-S, DVB-S2 or 16QAM
Pol	Indicates the signal polarization setting. This setting is only applicable when LNB Power is set to H-NIT or V-NIT. The selected setting must match the polarization of the transmitted signal.	Horiz (Horizontal), Vert (Vertical) or Auto
IQ Tuner	Indicates the IQ (Input Signal Inversion) for the received signal.	Inv or NonInv
IQ Status	Indicates the input signal spectrum inversion setting (IQ), which allows the operator to track and select inverted and non-inverted digital signals.	Auto, Opposite, or Normal
Dnlnk Freq (GHz)	Indicates the current downlink frequency.	in GHz
L-Band	Indicates the current L-Band frequency.	in MHz
Pilot Present	Indicates whether a Pilot is present for the received signal. The Pilot is set on the modulator for input signal synchronization purposes.	Yes, No, or N/A
C/N (dB)	Indicates the current Carrier-to-Noise ratio.	in dB

Menu Item	Description	Parameters
C/N Margin (dB)	Indicates the current Carrier-to-Noise Margin for the received signal. The Carrier-to-Noise margin is the actual distance that C/N is from the noise threshold.	Values can be displayed in the range of -32.0 to +30.0 dB.
PER	Indicates the current PER (Packet Error Rate) of the received signal (DVB-S2).	
PVBER	Indicates the PV (Post-Viterbi) BER for the received signal (DVB-S).	
LDPCBER	Indicates the LDPC (Low Density Parity Check) error rate for the received signal (DVB-S2).	
AFC (MHz)	Indicates the current Automatic Frequency Control count.	in MHz
UEC	Indicates the current Uncorrected Error Count for the received signal.	
CEC	Indicates the current Corrected Error Count for the received signal (DVB-S).	
Clear Counts	Select this option to clear the error counters.	
ASI Link	Indicates whether there is a transport stream link error.	Error, Ok, or N/A
Transport	Indicates the current transport synchronization status.	Error, Ok, or N/A
Packet Size	Indicates the packet size (in bytes) for the ASI input.	188, 204, or N/A
Net Name	Indicates the name assigned to the network.	Up to 12 alphanumeric characters.
NetID	Indicates the Network ID of the uplink signal the receiver is to receive when using the selected preset. The receiver's Network ID must match the Network ID associated with the transmitted signal that identifies the NIT to be used. Note: Each network must be assigned a unique ID (number).	1 to 65535
TxID	Indicates the Transport ID.	1 to 65535
LNB Stat	Indicates the current Low Noise Block (LNB) connection status.	No Load, Over Loaded, Over Temperature, Short Circuit, Disabled, Normal or N/A

Chapter 4 Front Panel Operation

Menu Item	Description	Parameters
Polar	Indicates the polarity of the LNB Power supply.	Off, 13V, or 18V
LO Select	Indicates whether a 22 kHz tone is available on input port RF1. This is applicable for dual-band applications.	On or Off

Program PIDs

Menu Item	Description	Parameters
PE	Select the Program Entry to view.	PE1 to PE8
Stream	Indicates the name assigned to the Program Entry.	Up to 4 alphanumeric characters
Detail	Indicates any detail associated with the program PID (e.g., MPG2 PID).	MPG1 VID, MPG2 VID, 422 VID, H264 VID, HD VID, MPG4 VID, MPG AUD, MPG2 AUD, DVB AC3, DVB DDP, AAC AUD, HEAAC, AUD, MPG4 AUD, DBE AUD, DTS AUD, DVB TXT, DVB VBI, DVB SUBT, DVB ASYN, DVB SYNS, DVB SYND, DVB MPE, DVB DCAR, DVB OCAR, SA VBI, ATSC AC3, ATSC DDP, SA UTLD, SCTE DPI, SA HSD, SA CDDL, SA WBD, SA SUBT, ECM, EMM, PCR, or UNKNOWN
PID	Indicates the program PID number.	1 to 8192
Present	Indicates whether the PID is present in the incoming stream.	Yes or No

Program Status

Menu Item	Description	Parameters
PE	Indicates the Program Entry number.	PE1 to PE8

Status Menu

Menu Item	Description	Parameters
SR Status	This displays the status of an alternate authorized program/service from the same transport stream when the receiver is not authorized to view the primary program. This is an uplink initiated function that maps the alternate service to the original (primary) service PIDs, replacing the original service with the alternate service at the digital transport output. No local intervention is required by the receiver operator for provision of this service replacement feature.	<p>Not Started - Indicates that an event has not started.</p> <p>Primary - Indicates that a service replacement event is active, but the primary program is being displayed.</p> <p>Alternate - Indicates that a service replacement event is active, and that the receiver has tuned to and is displaying the alternate program/event as it is not authorized to view the scheduled event.</p>
SR Event Type	Indicates the type of service replacement event.	<p>None - Indicates that no service replacement event is scheduled.</p> <p>Scheduled - Indicates that all transcoders will tune to the alternate program at the scheduled time. This status applies to PE1 to PE8.</p> <p>CA - Indicates that only transcoders unauthorized to view the scheduled program will tune to the alternate program according to the selected authorization tier bits. This status applies to PE1 to PE8.</p> <p>Cue Trigger - Indicates that only transcoders authorized by the Cue Trigger mask will tune to the scheduled program/event.</p> <p>Note: The Cue Trigger service replacement event type is not supported in the current release.</p>
SR Event Start	Displays the start time of the service replacement event when one is scheduled; otherwise, the default start time is displayed. The default start time is 2007/09/01 00:00:00.	
SR Event End	Displays the end time of the service replacement event when one is scheduled; otherwise, the default end time is displayed. The default end time is 2007/09/01 00:00:00.	

Status Menu: TS Output

Output Status

Menu Item	Description	Parameters
Output	Indicates the output type.	ASI or MPEGoIP
Rate (Mbps)	Indicates the current output bit rate.	0 to 213 Mbps
Free (Mbps)	Indicates the available bandwidth, in Mbps (without stuffing).	

Status Menu - IP

To view the IP menu from the **Status** menu, press the **RIGHT** arrow key four times. The IP menu provides Link, Redundancy, and MOIP status information.

The IP menu has the following structure:

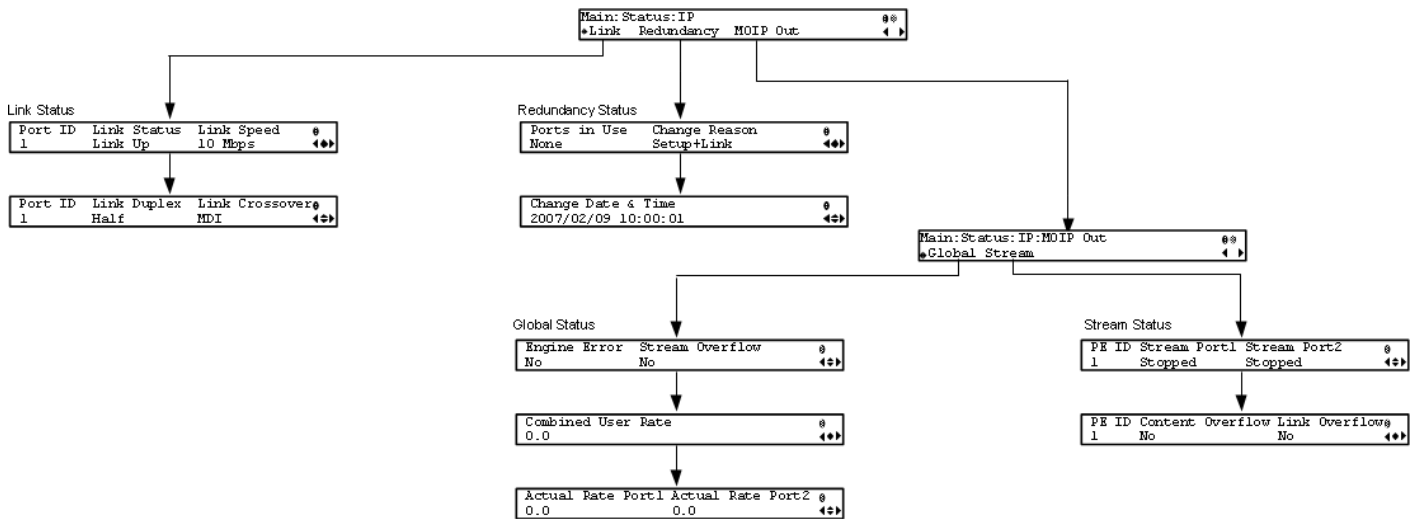

Link Status

The Link Status parameters display the port information, such as the status, speed, duplex and crossover. Port 1 is the management port and port 2 is the data port.

Redundancy Status

The Redundancy Status is not supported.

Global Status

Menu Item	Description	Parameters
Engine Error	This is not supported.	

Status Menu

Menu Item	Description	Parameters
Stream Overflow	Indicates the MPEG over IP transport stream overflow status.	Yes or No
Combined User Rate	Displays the configured output bit rate.	
Actual Rate Port 1/2	Displays the current output bit rates for the control port (Port 1) and data port (Port 2).	0 to 206 Mbps

Stream Status

Menu Item	Description	Parameters
PE ID	Displays the program entry channel.	1
Stream Port1/Port2	Indicates the stream status of the control port (Port 1) and data port (Port 2).	Stopped, Suspended, Active, or Muted
Content Overflow	Indicates if the incoming transport stream rate is higher than the configured output bit rate.	Yes or No
Link Overflow	Indicates if the configured output bit rate is close or higher than the current Ethernet link speed for the Ethernet port used for MPEGoIP output.	Yes or No

Status Menu - DR

To view the DR (Disaster Recovery) menu from the **Status** menu, press the **RIGHT** arrow key five times. The DR menu provides the current disaster recovery status information. For more information on disaster recovery, see *Disaster Recovery* (on page 6).

The DR menu has the following structure:

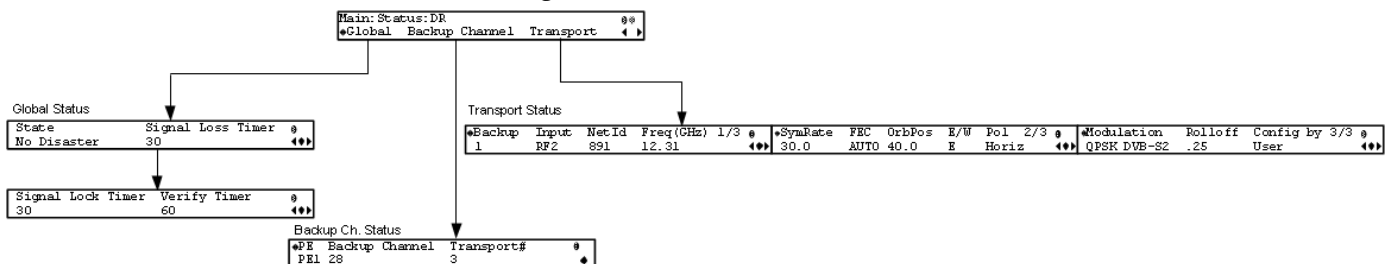

Global Status

Menu Item	Description	Parameters
State	<p>Displays the current disaster recovery status. The three statuses are:</p> <ul style="list-style-type: none"> ■ No Disaster - The unit is in a normal state. ■ D/R In Progress - The unit has detected a loss of input and it is searching for a backup transport using the configured search path. The configured search path is displayed in the Transport Status menu. ■ D/R Disabled - The disaster recovery feature is temporarily disabled. To enable disaster recover, see <i>Setup Menu: DR</i> (on page 121). 	No Disaster, D/R In Progress, D/R Disabled
Signal Loss Timer	Indicates the time, in seconds, the unit must wait (after detecting a signal loss) before declaring a disaster.	5 to 2160000
Signal Lock Timer	Indicates the time, in seconds, the unit must wait for a signal lock before declaring that the signal is not usable and move on to the next search location in the search path.	5 to 255
Verify Timer	Indicates the time, in seconds, the unit must wait for the PAT table to verify the signal has a valid transport.	10 to 255

Backup Channel Status

Menu Item	Description	Parameters
PE	Displays the program entry.	PE1 to PE8
Backup Channel	Displays the channel number assigned to the selected backup transport.	-
Transport #	Displays the backup transport number for the program entry selected.	1, 2, or 3

Backup Transport Status

Menu Item	Description	Parameters
Backup	Indicates the configured backup transport entry number.	1, 2, or 3

Status Menu

Menu Item	Description	Parameters
Input, NetId, Freq (GHz), SymRate, FEC, OrbPos, E/W, Pol, Modulation, Rolloff, Config by	<p>For information on the tuning parameters, see <i>Status Menu: TS Input</i> (on page 47).</p> <p>Note: The RF input must be configured to match the bandwidth of the backup parameters.</p>	-

Setup Menu

To view the Setup menu from the Main menu, press the **RIGHT** arrow key once and the **SELECT** key. The Setup menu is split into eight sections: Administration, TS Input, IP, Services, Outputs, CA, Alarms/Warnings, and Noise Cutoff. For instructions on how to select and store settings, see *About the Front Panel* (on page 34).

The Setup menu allows you to set all the parameters associated with the following:

- Administration - lock level, password, factory reset, keypad lock, download mode and date and time
- TS Input - frequency parameters for acquiring and locking on to an RF signal, or receiving an ASI input
- IP - parameters for setting up the Ethernet ports
- Services - audio video, captions, and VBI
- Outputs - alarm relays, cue tone/cue trigger setup, parameters for setting up the transport stream out, which includes DPM and transcoding
- CA - conditional access
- Alarms/Warnings - enables alarms/warnings traps and relays
- Noise Cutoff - muting thresholds
- DR - global, backup channel, and backup transport parameters for disaster recovery

The Setup menu has the following structure:

```

Main: Setup 1/3 @@ Main: Setup 2/3 @@ Main: Setup 3/3 @@
*Admin TS Input IP Services ◀▶ Outputs CA Alarm/Warn NoiseCutoff▶▶ DR
    
```

Setup Menu: Admin

To view the **Admin** menu from the Setup menu, press the **SELECT** key.

For instructions on how to select and store settings, see *About the Front Panel* (on page 34).

The **Admin** menu has the following structure:

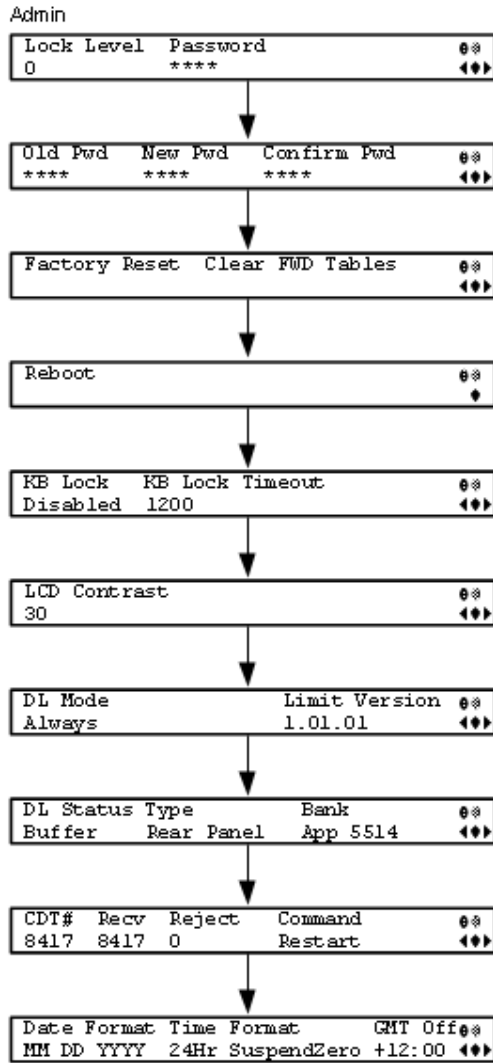

Menu Item	Description	Parameters
Lock Level	Sets the front panel interface lock level. For information on each of the lock levels, see D9859 Transcoder Lock Levels.	0, 1, 2, 3, or 4

Chapter 4 Front Panel Operation

Menu Item	Description	Parameters
Password	Enter the password to successfully set the current lock level. Depending on the unit, the default password for all lock levels is 1234. For more information on the default password, contact Cisco customer support.	
Old Pwd, New Pwd, Confirm Pwd	To change the password, enter the old password (Old Pwd). Next, enter the new password (New Pwd, four digits in the range from 0000 to 9999) and re-enter the new password for confirmation (Confirm Pwd). To change the password, the receiver must be in Lock Level 0. Depending on the unit, the default password is 1234. For more information on the default password, contact Cisco customer support.	
Factory Reset	Select this option to perform a reset of receiver settings back to the factory set (default) values. A warning message prompts you to confirm the operation.	Reboots Unit - you are prompted to verify the operation. Abort or Continue
Clear FWD tables	Select to clear settings that are only used in older applications. Reverting back to an older application will revert to the default values of the cleared settings. A warning message prompts you to confirm the operation.	Abort or Continue
Reboot	Allows you to reboot the receiver. You will be asked to confirm the operation.	Select Continue to reboot the receiver or Abort to cancel the operation.
KB Lock	Select whether to lock the front panel keypad after a time of disuse.	Enabled or Disabled
KB Lock Timeout	If KB Lock is enabled, you can set the keypad lock timeout period, in seconds. The keypad will lock after the set period of disuse. Avoid setting the period to a short duration when the keypad is used often.	5 to 1800 seconds. The default is 60 seconds.

Menu Item	Description	Parameters
LCD Contrast	Adjusts the contrast of the LCD menu panel.	1 (lowest contrast) to 30 (highest contrast)
DL Mode	Set the unforced over-the-air download mode.	<p>Always - Unforced download will be accepted and saved in memory.</p> <p>Once - An unforced download will be accepted, followed by a reboot of the receiver, and the DL Mode will change to Never.</p> <p>Never - Unforced downloads will not be accepted.</p> <p>Note: Forced downloads (initiated by the uplink) are always accepted and always result in a reboot of the receiver. <i>Service interruption will occur!</i></p>
Limit Version	Indicates the oldest version of the application that can be installed on the current unit. Older applications will not be installed.	Read-only alphanumeric value
DL Status	Indicates the current download state.	<p>Init - Download component is being initialized. You cannot perform a download while in this state.</p> <p>Ready - Download component is ready to receive downloads.</p> <p>Buffer - Download in progress. The CDTs are being received.</p> <p>Program - The application is being written to flash.</p> <p>Swap - The IRD is swapping to a new application and it will reboot.</p> <p>Shutdown - The IRD is shutting down and it will reboot.</p> <p>App Erase - An application is being erased from the flash.</p> <p>FPGA Erase - A Field Programmable Gate Array (FPGA) code is being erased from the flash.</p>

Chapter 4 Front Panel Operation

Menu Item	Description	Parameters
Type	The type of download being performed.	<p>None - No download is being performed.</p> <p>HTTP - An HTTP download from the web GUI is being performed.</p> <p>Over Air - An over-the-air download is being performed.</p>
Bank	The type of code being downloaded.	<p>App 5514 - Currently downloading code for app5514 on the main board.</p> <p>App 7109 - Currently downloading code for app7109 on the main board.</p> <p>FPGA 7109 - Currently downloading FPGA code to the main board.</p> <p>Note: The FPGA download does not occur over-the-air.</p> <p>App PPC - Currently downloading code to the application in the PowerPC on the transcoder board.</p> <p>PowerPC - Currently downloading code (such as FPGA) to the PowerPC on the transcoder board.</p>
CDT#	Indicates the total number of expected code tables in the current download.	Read-only numeric value.
Recv	Displays the number of code tables received since the last completed or aborted download, or power-cycle.	Read-only numeric value.
Reject	Displays the number of code tables rejected. Tables are rejected whenever validation fails due to things like CRC failure or incorrect code or receiver type.	Read-only numeric value.

Menu Item	Description	Parameters
Command	Select a command to issue to the current download. This command is for over-the-air downloads only. It has no effect on the HTTP download.	<p>Abort - Stops a download that is currently being received.</p> <p>Restart - Restarts a previously aborted download.</p> <p>Note: The download does not resume from where it was aborted, but restarts from the beginning.</p> <p>None - No action is to be performed.</p>
Date Format	Select the date format.	YYYY_MM_DD, DD_MM_YYYY, or MM_DD_YYYY
Time Format	Select the time format.	24Hr, 24Hr SuspendZero, 12Hr, 12Hr SuspendZero. The SuspendZero options omit the leading zero.
GMT Off	Select the local time zone offset relative to the GMT time. The time information in the transmitted stream is broadcast as GMT time and changing this setting will allow the unit to correctly display the local time.	+13:00, +12:00, +11:00, +10:00, +09:30, +09:00, +08:00, +07:00, +06:30, +06:00, +05:45, +05:30, +05:00, +04:30, +04:00, +03:30, +03:00, +02:00, +01:00, GMT, -01:00, -02:00, -03:30, -04:00, -05:00, -06:00, -07:00, -08:00, -09:00, -10:00, -11:00, -12:00

Setup Menu: TS Input

To view the TS (Transport Stream) Input menu from the Main menu, press the **RIGHT** arrow key once and then the **SELECT** key to reach the Setup menu. Then press the **RIGHT** arrow key once and the **SELECT** key to view the TS Input menu.

For instructions on how to select and store settings, see *About the Front Panel* (on page 34).

The TS Input menu has the following structure:

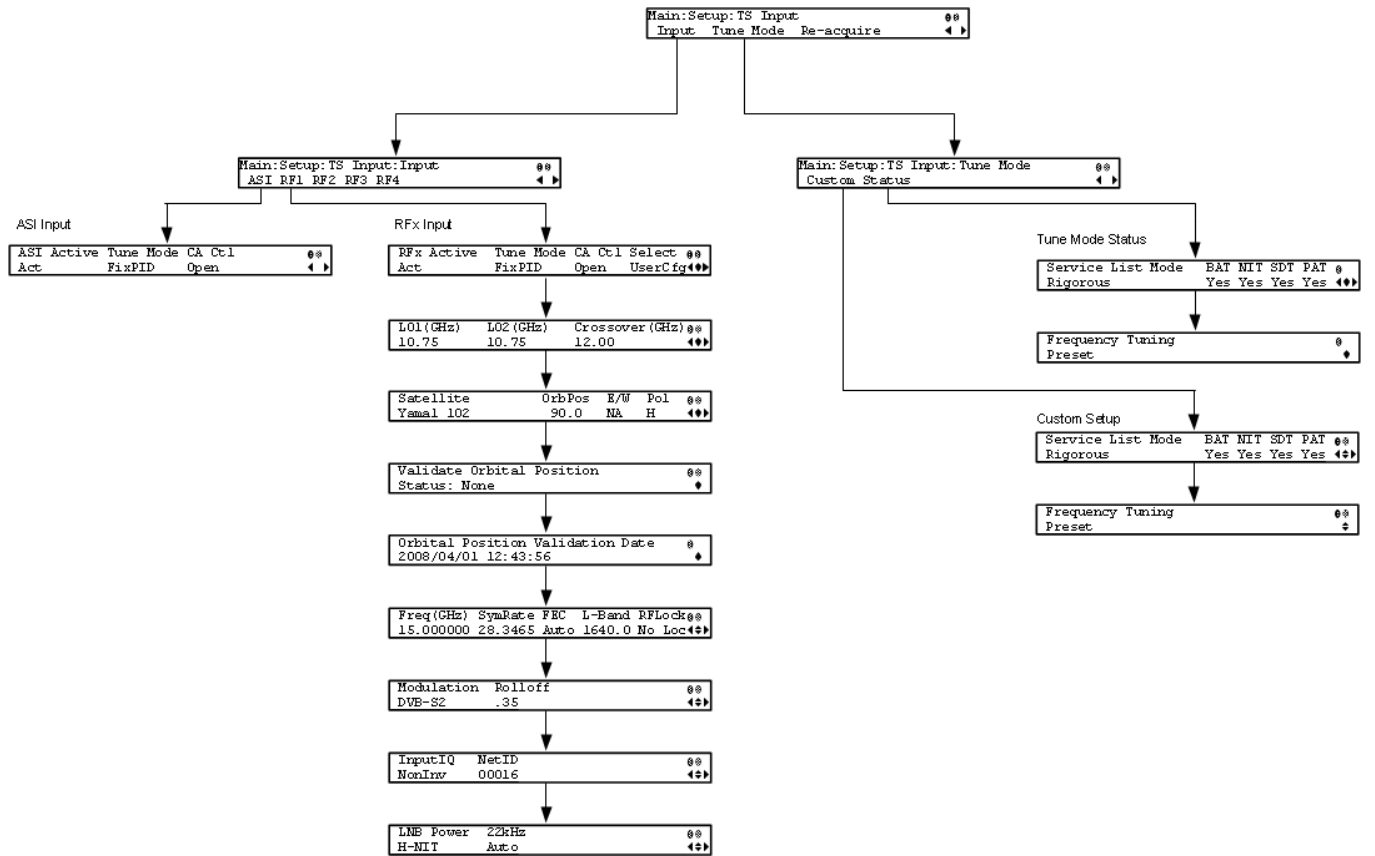

ASI Input

Menu Item	Description	Parameters
ASI Active	Select whether to tune to the ASI input. Note: Setting a new input to be active will deactivate the currently active input.	Act or No

Setup Menu

Menu Item	Description	Parameters
Tune Mode	Select the tables required for the service list creation and signal acquisition.	Basic - Requires NIT to be present. Auto - Uses all the service list tables and it will acquire if any service list tables are present. Custom - Uses the Custom Tuning parameters, specified by the user. The default is Basic.
CA Ctl	Sets how the conditional access will attempt to descramble the scrambled programs.	Std - In standard mode, if a program is not authorized, even if some services are not scrambled, the whole program will not be authorized. Open - In open mode, if a program is not authorized, services in the program that are not scrambled will still be available.

RF1, RF2, RF3, RF4 (RFx) Input

Menu Item	Description	Parameters
RFx Active (RF1, RF2, RF3, RF4)	Select the input to be active. Note: Setting a new input to be active will deactivate the currently active input.	Act or No
Tune Mode	Select which tables are required for the service list creation and signal acquisition. Note: When editing the tuning, the device is in a transient state while acquiring tuning information and channel lists, etc. The receiver reverts to the previous set of tuning settings/information and channels until these changes are either saved or abandoned.	Basic - Requires NIT to be present. Auto - Uses all the service list tables and it will acquire if any service list tables are present. Custom - Uses the Custom Tuning parameters, specified by the user. The default is Basic.

Chapter 4 Front Panel Operation

Menu Item	Description	Parameters
CA Ctl	Sets how the conditional access will attempt to descramble the scrambled programs.	Std - In standard mode, if a program is not authorized, even if some services are not scrambled, the whole program will not be authorized. Open - In open mode, if a program is not authorized, any services in the program that are not scrambled will still be available.
Select	Sets the method used by the RF tuner to determine which input to use when switching transports.	UserCfg - User configuration will only use the active RF input. SW Map - Software map uses the orbital position settings from each input and map it to those in the NIT.
LO1 (GHz)	Sets the lower oscillator frequency, in GHz, of the LNB. In a single band oscillator, set its frequency, in GHz.	0.0 to 15.0 GHz. Must be lower than the value for LO2.
LO2 (GHz)	Sets the higher oscillator frequency, in GHz, of the LNB. In a single band oscillator, set this value to 0.0.	0.0 to 15.0 GHz. Must be higher than the value for LO1.
Crossover (GHz)	This is the crossover frequency, which is an internal threshold frequency used for selecting the LO1 or LO2 frequency, depending on the current Downlink frequency settings. This option is only used in dual-band LNB applications.	0.0 to 15.0 GHz. In single-band LNB applications, set this value to 0.0.
Satellite	This is the name of the satellite currently selected. Choose the satellite you want to use to receive the signal from the list of satellites available. When you select a satellite, the orbital position (OrbPos) is displayed. This is important for automatic switching from one RF input to another in the event of loss of the signal, allowing the receiver to acquire an alternate signal.	When the satellite is not listed, enter the known orbital position (OrbPos) of the satellite you want to use to receive the signal.

Setup Menu

Menu Item	Description	Parameters
OrbPos	<p>This is the location in orbit of the satellite currently being used. The satellite position (in degrees) in combination with the direction (either E (East) or W (West)) denotes the satellite position the dish connected to the current RF Input should point to. This is used when the satellite is not available in the look-up menu list.</p> <p>For manual configuration, enter the location of the satellite using the numerical keypad. The receiver will not recognize the satellite name and identify it as Unknown. This setting is required to resolve any ambiguity between RF inputs during automatic disaster recovery.</p>	Degrees
E/W	Denotes the satellite position the dish connected to the current RF Input should point to. This is used when the satellite is not available in the look-up menu list.	E, W or NA
Pol	Marks the polarity of the signal connected to this RF input.	H (horizontal), Vert (vertical), A (Auto). Auto is only applicable when LNB Power is set to H-NIT or V-NIT.
Validate Orbital Position	This option validates the RF inputs to match those expected by the network. The transcoder will check to see if all the frequencies in the Network Information Table (NIT) can be tuned to.	
Orbital Position Validation Date	This displays the last date that the 'Validate Orbital Position' operation was performed.	N/A
Freq (GHz)	This is the current Downlink operating frequency used by the receiver for tuning the received digital signal.	0.0 to 15.0 GHz
SymRate	This is the symbol rate. The symbol rate must match that of the transmitted signal.	<p>1.0 to 45.0 Ms/s for DVB-S.</p> <p>1.0 to 30.0 Ms/s for DVB-S2 if Pilot Present is set to Yes.</p> <p>5.0 to 30.0 Ms/s for DVB-S2 if Pilot Present is set to No.</p>

Chapter 4 Front Panel Operation

Menu Item	Description	Parameters
FEC	Select the Forward Error Correction inner code rate. The FEC must match the FEC of the transmitted signal.	1/2, 2/3, 3/4, 5/6, 7/8, or Auto
L-Band	This is the L-Band operating frequency used by the receiver. This value is determined by the values set in the Freq and LO options.	950 to 2150 MHz
RF Lock	Indicate whether the tuner has locked onto the Radio Frequency signal with the current settings.	Lock or NoLock
Modulation	Sets the modulation type for the received signal.	DVB-S or DVB-S2
Rolloff	Sets the rolloff factor of the incoming signal.	.20, .25, .35. Use .20 or .35 when DVB-S modulation is used, and either of the three when DVB-S2 is used. Use a small number to reject or filter carriers close to the same frequency.
InputIQ	Select the Input signal spectrum inversion setting, which allows the operator to track and select inverted and non-inverted digital signals. This is normally used to automatically reject or filter out unwanted signals.	Auto, Normal, or Opposite. Auto - The signal is tracked and inverted for correct selection, as required. Opposite - The signal is always inverted. Normal - The signal is not inverted.
NetID	Select the Network ID of the uplink signal the receiver is to receive. The transcoder's Network ID must match the Network ID associated with the transmitted signal.	1 to 65535. The default value is 1.
LNB Power	Set the power output of RF1 to the external LNB.	Off, 13V, 18V, V-NIT, or H-NIT. V-NIT and H-NIT will use vertical and horizontal polarity until it is automatically read from the NIT. Note: Power will not be applied to the LNB when set to Off.

Setup Menu

Menu Item	Description	Parameters
22kHz	For dual band applications, select whether to transmit the 22 kHz tone Local Oscillator control signal of RF1.	On, Off, or Auto. Auto uses the crossover frequency to determine if the tone is transmitted.

Tune Mode

Custom

This menu is where you set up your custom properties. Select the channel to set up and then edit it.

Menu Item	Description	Parameters
Services List Mode	If using custom tune mode, select which tables are required for tuning.	Rigorous - Requires all service list tables to be present to acquire the signal. Degraded - Requires any service list table to be present to acquire the signal.
BAT	This is not supported in the current release.	No
NIT	If using custom tune mode, select whether to use the Network Information Table (NIT) when creating the service list.	Yes or No
SDT	If using custom tune mode, select whether to use the Service Description Table (SDT) when creating the service list.	Yes or No
PAT	If using custom tune mode, select whether to use the Program Association Table when creating the service list.	Yes or No
Frequency Tuning	If using custom tune mode, select whether to use the NIT to tune to other transports, or to force the tuning to user configuration settings.	NIT - The transcoder can change tuning parameters to use all transports available in the NIT. User Cfg - The transcoder is forced to use the user selected tuning parameters.

Chapter 4 Front Panel Operation

Status

Menu Item	Description	Parameters
Service List Mode	Indicates if all the expected service list tables are present (Rigorous) or only some of the service list tables are present (Degraded)	Degraded or Rigorous
BAT	This is not supported in the current release.	No
NIT	Indicates whether the Network Information Table (NIT) is being used to create the service list.	Yes or No
SDT	Indicates whether the Service Description Table (SDT) is being used to create the service list.	Yes or No
PAT	Indicates whether the Program Association Table (PAT) is being used to create the service list.	Yes or No
Frequency Tuning	Indicates whether tuning is using the NIT to tune to other transports, or whether tuning is forced to use the user selected parameters.	NIT or User Cfg

Re-Acquire

Menu Item	Description	Parameters
Re-Acquire	Re-acquires the signal using the tuning parameters from user settings.	Abort or Continue. Select Abort to cancel the operation or choose Continue to complete the operation.

Setup Menu: IP

To view the IP menu from the Main menu, press the **RIGHT** arrow key once and then the **SELECT** key to reach the Setup menu. Then, press the **RIGHT** arrow key twice and the **SELECT** key to view the IP menu.

The IP menu allows you to set the parameters for communicating with other equipment via the Ethernet Data and Management ports for MPEGoIP and MPE applications and upgrading application software.

For instructions on how to select and store settings, see *About the Front Panel* (on page 34).

The IP menu has the following structure:

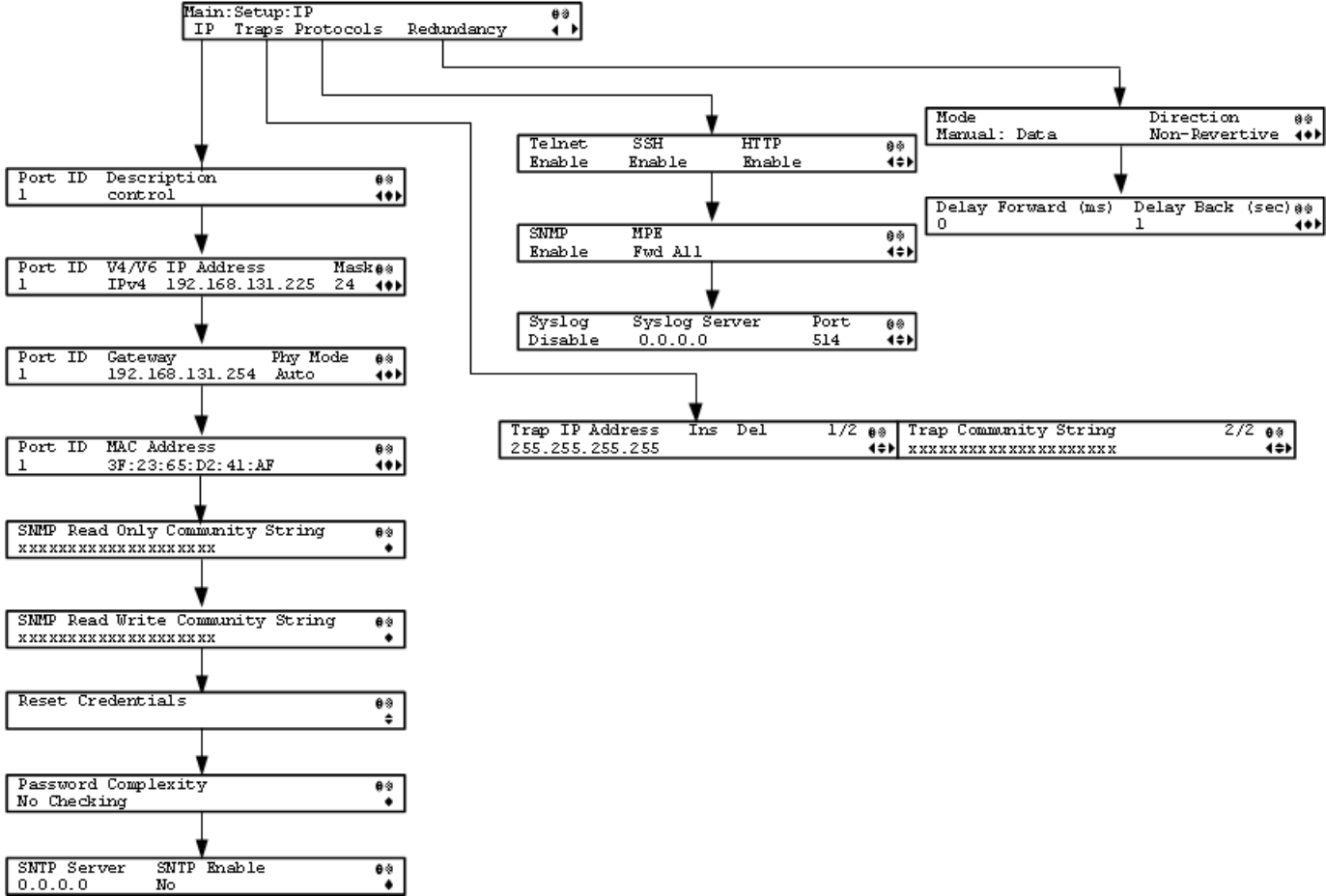

IP

Menu Item	Description	Parameters
Port ID	Select the Ethernet interface to configure.	1, 2, or 3. Interface 1 is the control and management interface and interface 2 and interface 3 are data interfaces.
Description	Sets the description or name for the Ethernet interface.	Up to 20 alphanumeric characters in length.
V4/V6	Select the IP protocol.	Only IPv4 is currently supported.
IP Address	Sets the IPv4 IP address for the interface.	12 digits in length (###.###.###.###)
Mask	Sets the number of CIDR (Classless Inter-Domain Routing) bits in the network mask.	8 to 30

Chapter 4 Front Panel Operation

Menu Item	Description	Parameters								
Gateway	Sets the Network Gateway Address on the Network, used to expose the receiver to a WAN.	<p>The IP Address/Mask and Gateway Address should be changed together, i.e., as a group. The following table shows the most commonly used Subnet mask values to enter for a chosen IP address mask, which will depend on the size of your network.</p> <table border="1"> <thead> <tr> <th>Mask</th> <th>Subnet Mask</th> </tr> </thead> <tbody> <tr> <td>8</td> <td>255.0.0.0</td> </tr> <tr> <td>16</td> <td>255.255.0.0</td> </tr> <tr> <td>24</td> <td>255.255.255.0</td> </tr> </tbody> </table>	Mask	Subnet Mask	8	255.0.0.0	16	255.255.0.0	24	255.255.255.0
Mask	Subnet Mask									
8	255.0.0.0									
16	255.255.0.0									
24	255.255.255.0									
Phy Mode	Set the speed and duplex type of the interface. Select Auto for PHY to negotiate speed and duplex with other devices on the network, or select 10 HD (half-duplex), 10 FD (full-duplex), 100 HD, 100 FD, or 1000 FD to lock into a fixed mode.	Auto (default), 1000FD (full duplex), 100HD (half duplex), 10FD, 100FD, or 10HD								
MAC Address	Displays the MAC address of the interface. It is set at the factory and is a read-only value.	N/A								
SNMP Read Only Community String	<p>Sets the password to read data from a device and to display diagnostics traps/alarms.</p> <p>This is used when communicating with a device within an SNMP environment.</p>	<p>Up to 31 alphanumeric characters in length. This string is case-sensitive.</p> <p>The default community string is: public.</p>								
SNMP Read Write Community String	<p>Sets the password to write data to a device.</p> <p>This is used when communicating with a device within an SNMP environment.</p>	<p>Up to 31 alphanumeric characters in length. This string is case-sensitive.</p> <p>The default community string is: public.</p>								

Menu Item	Description	Parameters
Reset Credentials	<p>If for some reason, you cannot access the decoder (due to a forgotten password, corrupted data, etc.), the recovery procedure for the decoder is as follows:</p> <p>Using the keypad, choose this field on the front panel menu. A default login username and randomly generated password will be displayed on the front panel display for approximately 30 seconds. The new account will have Admin privileges. It is recommended that this account be replaced by a login username/password chosen by the administrator. To change the username and password, you must be an Admin user. Refer to <i>Setting Admin User Privileges via a Telnet Connection</i> (see "<i>Setting Admin User Privileges via a Telnet/SSH Connection</i>" on page 30).</p> <p>Note: After this recovery procedure, all existing user accounts will be lost.</p>	
Password Complexity	Sets the password complexity for all users. The complexity level changes will only affect the new user accounts and password changes. It will not affect existing accounts.	No Checking, Minimal Checking, or Full Complexity Checking For more information, see the Password Complexity table below.
SNTP Server	Sets the NTP server address. If the NTP server address is not set (0.0.0.0), the IRD will not attempt to connect to the server.	12 digits in length (###.###.###.###)
SNTP Enable	Periodically request NTP timestamps from the NTP server and to synchronize its system (i.e., non-DVB related) time with the NTP server.	Yes or No

Password Complexity

Password Complexity	Description
No Checking	<p>There are no restrictions on passwords.</p> <p>Note: A minimum of one character is required.</p>

Chapter 4 Front Panel Operation

Password Complexity	Description
Minimal Checking	<p>The passwords must comply with the following requirements:</p> <ul style="list-style-type: none"> ■ It cannot contain username or reversed username. ■ It cannot contain any of the following strings: cisco, sciatl, ocsic, Itaics, atlsci, icslta, or any string achieved by full or partial capitalization of letters. ■ No letter is repeated more than three times in a row. ■ Must contain a minimum of four characters.
Full Complexity Checking	<p>The passwords must comply with the following requirements:</p> <ul style="list-style-type: none"> ■ It cannot contain username or reversed username. ■ It cannot contain any of the following strings: cisco, sciatl, ocsic, Itaics, atlsci, icslta, or any string achieved by full or partial capitalization of letters. ■ No letter is repeated more than three times in a row. ■ Must contain a minimum of eight characters. ■ Must contain a minimum of three of the following types of characters: capital letters, small letters, digits, and special characters.

Traps

Menu Item	Description	Parameters
Trap IP Address	Sets the destination IP address for SNMP trap messages for system events (i.e., fault messages).	Up to 12 digits in length, e.g., 155.128.100.200
Ins, Del	You can choose to Insert or Delete entries. Up to 25 entries can be assigned to the Trap IP Address and Community String fields. To add a new entry, press Ins and enter the new entry in the IP Address or Community String field. To delete an existing entry, scroll to the IP address or community string you want to delete and press Del.	
Trap Community String	Sets the Community string for the Trap IP Address.	Public or custom string. Up to 35 characters. The default is: public.

Protocols

The **Protocols** menu allows you to control remote access protocols (Telnet, SSH, HTTP, and SNMP) to the IRD.

Menu Item	Description	Port Number	Parameters
Telnet	Controls Telnet access to the IRD.	TCP port #23	Enable (default) - Allow Telnet connections. Disable - Disables the listener for the Telnet port.
SSH	Controls SSH access to the IRD.	TCP port #22	Enable (default) - Allow secure shell connections. Disable - Disables the listener for the SSH port.
HTTP	Controls HTTP access to the IRD.	TCP port #80 for HTTP. TCP port #443 for HTTPS.	Disable - Disables the listener for the HTTP port. Enable (default) - Allow web connections. Secure - Encrypted access to the webserver (HTTPS). For more information, see <i>Protocol Control Settings</i> (on page 221).
SNMP	Controls SNMP access to the IRD.	UDP port #161	Enable (default) - Allow SNMP connections. Disable - Disables the listener for the SNMP port.
MPE	Sets whether the MPE data is forwarded to the network. Note: The transcoder supports up to a maximum of 10 Mbps throughput when forwarding 1500 byte packets.	N/A	Fwd None - The MPE data is not forwarded to the network. Fwd All - All the MPE data is forwarded to the network. Fwd Filtered - Only the MPE data from the defined Static Multicast Filtering table is forwarded to the network. For more information on configuring the Static Multicast Filtering table, see <i>To Add a Static Multicast Filtering</i> (on page 227).

Chapter 4 Front Panel Operation

Menu Item	Description	Port Number	Parameters
Syslog	Select the logging protocol to use. The Legacy option is used by Cisco customer support only. It is highly recommended that you use the following syslog servers: Syslog-ng - Balabit for Linux Syslog Watcher - SnmpSoft for Windows For more information, see <i>System Logs</i> (on page 222).	Default port #514 for TCP and UDP	Syslog TCP, Disable, Legacy, Syslog UDP
Syslog Server	If Syslog TCP or Syslog UDP is selected as the Syslog, set the IP address of the server.	N/A	12 digits in length (###.###.###.###)
Port	This sets the TCP or UDP port number of the server.	N/A	1 to 65535

By enabling or disabling the protocols, dynamic hardware and software firewalls are created for the D9859 transcoder.

Accessing TCP and UDP Services

The following describes the commands used to access port information for all the supported protocols. The examples of TCP-based services are: Telnet, SSH, and HTTP. The examples of UDP-based services are: SNTP and SNMP.

Proceed as follows to obtain TCP or UDP information:

- 1 Start a new communication session with the receiver using a utility, such as Tera Term Pro or PuTTY. For more information on starting a new connection, see *Starting a Telnet/SSH Session* (on page 30).

- In the admin command prompt, type `ipal tcp_list` for a list of TCP connections or `ipal udp_list` for a list of UDP connections and press **Enter**. The following is an example of the results:

```

10.85.162.86 - PuTTY
admin>ipal tcp_list
Idx  family Recv-Q      Send-Q      LocalAddress      Foreignaddress
Refs State/Backlog RTO
9    IPV4  0/32768      0/32768      0.0.0.0:22        0.0.0.0:0
6    LISTEN/0      0
11   IPV4  0/32768      0/32768      0.0.0.0:23        0.0.0.0:0
5    LISTEN/0      0
13   IPV4  0/32768      0/32768      0.0.0.0:80        0.0.0.0:0
2    LISTEN/0      0
43   IPV4  1/33930      455/33930    10.85.162.86:23   10.82.247.195:55315
7    ESTABLISHED  1000
16   IPV4  0/33580      0/33580      10.85.162.86:80   10.85.160.74:1609
8    ESTABLISHED  1000

admin>ipal udp_list
Index family RecvQ      SendQ      LocalAddress      Refs
0     IPV4  0/32768      0/32768      0.0.0.0:520       2
7     IPV4  0/32768      0/32768      0.0.0.0:35010     2
8     IPV4  0/32768      0/32768      10.85.162.86:123  2
12    IPV4  0/32768      0/32768      10.85.162.86:161  2
23    IPV4  0/32768      0/32768      10.85.162.86:8401 2
10    IPV4  0/32768      0/32768      169.254.10.1:514  3
4     IPV4  0/32768      0/32768      169.254.10.1:5803 2
5     IPV4  0/32768      0/32768      169.254.10.1:5806 2
1     IPV4  0/32768      0/32768      169.254.10.1:5807 2
6     IPV4  0/32768      0/32768      169.254.10.1:5808 4
3     IPV4  0/32768      0/32768      169.254.10.1:5809 3
2     IPV4  0/32768      0/32768      169.254.10.1:5810 2

admin>

```

- All other connections that are not specifically requested by remote access protocol selection or triggered by user actions, such as an FTP transfer, do not have active listeners and the corresponding TCP/UDP ports are closed. To strengthen security, the hardware firewall drops all incoming packets for the closed ports.

Note: The hardware firewall may impose different rules for the Management and Data ports. For example, remote access protocols, such as SSH or HTTP, are only enabled on the Management port.

Redundancy

The D9859 transcoder is a single-port unit. The redundancy settings are not supported.

Setup Menu: Services

To view the Services menu from the Main menu, press the **RIGHT** arrow key once and then the **SELECT** key to reach the Setup menu. Then press the **RIGHT** arrow key three times and the **SELECT** key to view the Services menu.

The Services menu allows you to set up all the operating parameters associated with audio, video and captions services.

Each parameter is described below. The menu has the following structure:

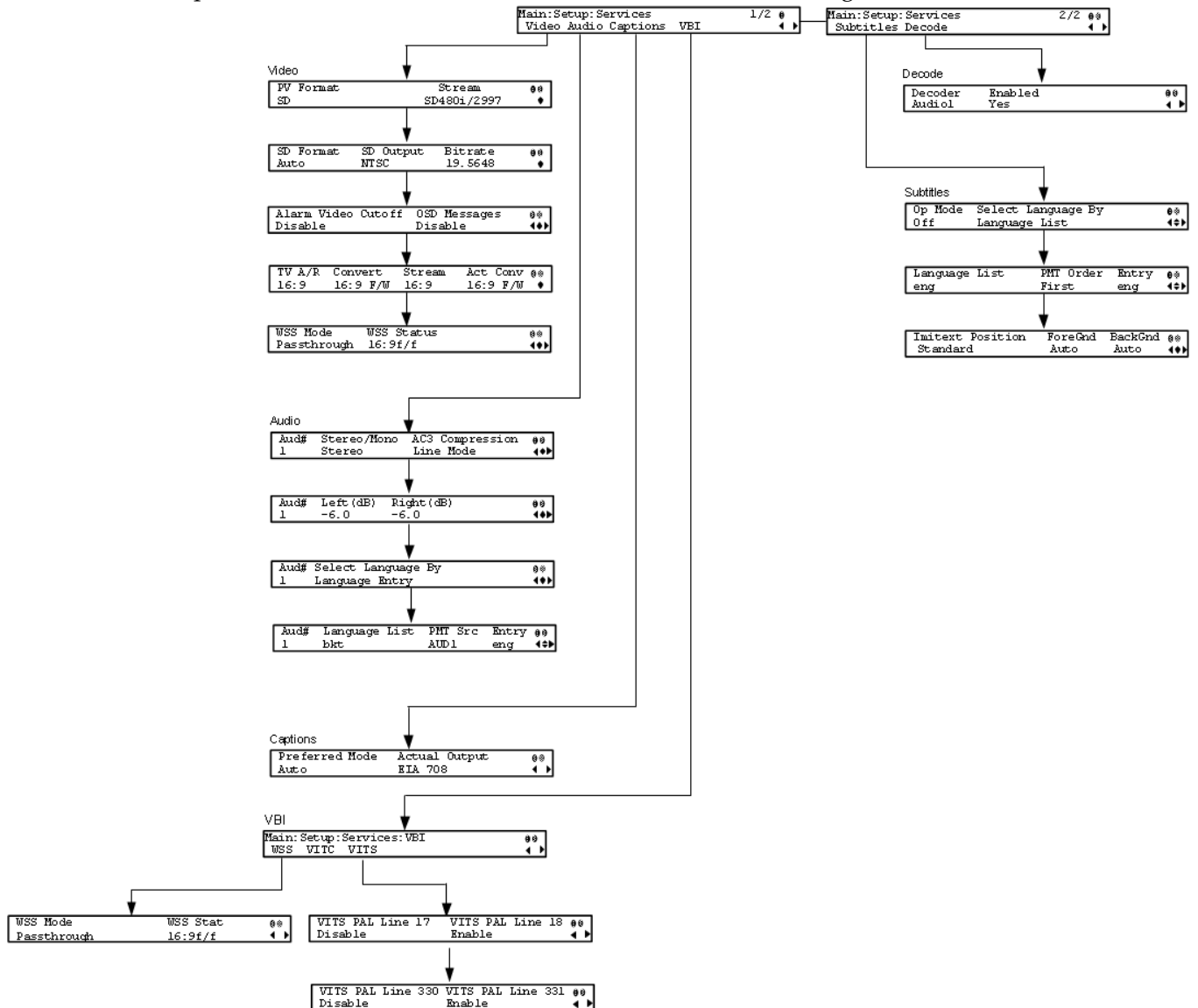

Video

Menu Item	Description	Parameters
PV Format	Sets the primary video output format for local decoding.	Auto, SD, HD 720p, or HD 1080i
Stream	Indicates the video format of the input video stream. This value is read-only.	
SD Format	Selects the standard definition output format to use on the primary video if the PV Output is set to SD.	Auto, NTSC, PAL-N (AR), PAL-M or PAL-B/G/I/D. Use NTSC for 525-line systems and PAL-B/G/I/D for 625-line systems.
SD Output	Indicates the actual standard definition format of the primary video output if the PV Output is set to SD.	NTSC, PAL-N (AR), PAL-M or PAL-B/G/I/D
Bitrate	Indicates the bit rate of the input video stream, in Mbps.	1.0 to 15.0 Mbps
Alarm Video Cutoff	Sets whether the video output is cut off if any enabled alarm is active on the receiver. When video is cut off, there will be no horizontal or vertical synchronization on the output. This is useful for downstream redundancy switching by detecting a loss of video signal. Note: This same function also exists under Setup: Alarm/Warning.	Enable or Disable. The default is Disable.
OSD Messages	Sets whether alarms and warnings are to be displayed on the on-screen display (e.g., TV monitor).	Enable or Disable
TV A/R	Select the standard definition aspect ratio of your TV monitor.	4:3 or 16:9
Convert	Select the conversion method that the receiver will perform on the incoming signal for the picture to be displayed correctly on your TV based on the TV A/R setting.	None, Auto, Auto AFD, 16:9 L/B, 4:3 P/B, 14:9, 4:3 CCO, 16:9 SCALE. The default is Auto. For more information, see <i>Aspect Ratio Conversions</i> (on page 78).
Stream	Indicates the aspect ratio of the incoming video stream. This is read-only.	4:3 or 16:9

Chapter 4 Front Panel Operation

Menu Item	Description	Parameters
Act Conv	<p>The actual aspect ratio conversion the receiver will perform based on what you have selected. This is read-only.</p> <p>Refer to the Aspect Ratio Conversions table below for the conversions performed by the receiver based on your selection, and the effect on the picture displayed by the receiver in each case (without Auto AFD)</p>	None, 16:9 L/B, 4:3 P/B, 14:9, 4:3 CCO, 16:9 SCALE
WSS Mode	Select the Wide Screen Signaling output mode. It is used to select how the receiver affects PAL WSS when it is present in the VBI line 23.	<p>Auto:Create - Creates WSS to output the correct aspect ratio when performing aspect ratio conversion.</p> <p>Auto:Modify - If WSS is present in the input stream, it is modified to output the correct aspect ratio when performing aspect ratio conversion. If WSS is not present in the input, no WSS will be present in the output.</p> <p>Suppress - Removes WSS output.</p> <p>Passthrough - Passes WSS unmodified as received by the receiver.</p> <p>The default is Passthrough.</p>
WSS Status	This indicates the current output value of PAL WSS in VBI line 23.	<p>4:3 F/F, 16:9 L/B CEN, 16:9 L/B TOP, >16:9 L/B, 14:9 L/B CEN, 14:9 L/B TOP, 14:9 F/F CEN, 16:9 F/F, or UNDEFINED</p> <p>Note: F/F is full format, and L/B is letter box.</p>

Aspect Ratio Conversions

The following table displays the conversions performed by the receiver based on the Act Conv selection:

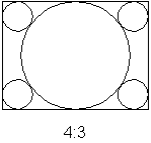
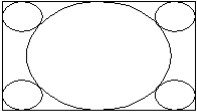
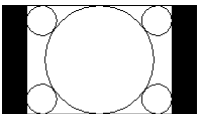
Stream	TV A/R	Conversion	Act Conv	Description	Image
4:3	4:3	None	None	Normal Picture	
4:3	4:3	Auto	None	No conversion	
4:3	4:3	16:9 L/B	None	Conversion is not possible. Normal picture.	
4:3	4:3	4:3 CCO	None	Conversion is not possible. Normal picture.	
4:3	4:3	4:3 P/B	None	Conversion is not possible. Normal picture.	
4:3	4:3	14:9	None	Conversion is not possible. Normal picture.	
4:3	4:3	16:9 SCALE	None	Conversion is not possible. Normal picture.	
4:3	16:9	None	None	Picture is short and wide.	
4:3	16:9	Auto	4:3 P/B	Uses 4:3 P/B.	
4:3	16:9	16:9 L/B	None	Conversion is not possible. Picture appears short and wide.	
4:3	16:9	4:3 CCO	None	Conversion is not possible. Picture appears short and wide.	

Chapter 4 Front Panel Operation

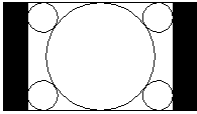
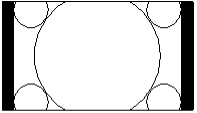
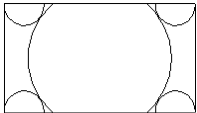
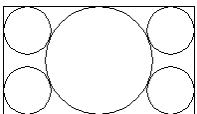
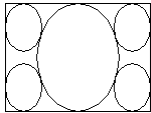
Stream	TV A/R	Conversion	Act Conv	Description	Image
4:3	16:9	4:3 P/B	4:3 P/B	4:3 picture is centered in a pillar-style box.	 4:3 PB
4:3	16:9	14:9	14:9	Compromises some up-sampling. Some black bars and cropping are visible.	 14:9
4:3	16:9	16:9 SCALE	16:9 SCALE	Vertically up-samples the center of the 4:3 picture and crops the top and bottom of the screen.	 16:9 FH
16:9	16:9	None	None	Normal	 16:9
16:9	16:9	Auto	None	No conversion. Normal picture.	
16:9	16:9	16:9 L/B	None	Conversion is not possible. Normal picture.	
16:9	16:9	4:3 CCO	None	Conversion is not possible. Normal picture.	
16:9	16:9	4:3 P/B	None	Conversion is not possible. Normal picture.	
16:9	16:9	14:9	None	Conversion is not possible. Normal picture.	
16:9	16:9	16:9 SCALE	None	Conversion is not possible. Normal picture.	
16:9	4:3	None	None	Picture appears tall and thin.	 16:9 Compressed

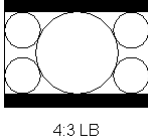
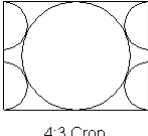
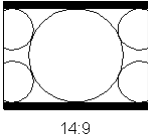
Stream	TV A/R	Conversion	Act Conv	Description	Image
16:9	4:3	16:9 L/B	16:9 L/B	Vertically down-samples the picture and applies black bars at the top and bottom of the screen.	 4:3 LB
16:9	4:3	4:3 CCO	4:3 CCO	Horizontally up-samples the center portion of the picture to fill the screen.	 4:3 Crop
16:9	4:3	4:3 P/B	None	Conversion is not possible. Picture appears tall and thin.	
16:9	4:3	14:9	14:9	Compromises some up-sampling. Some black bars and some cropping are visible.	 14:9
16:9	4:3	16:9 SCALE	None	Conversion is not possible. Picture appears tall and thin.	

Note: Active Format Descriptor (AFD) - normally it is necessary to set both the TV Aspect Ratio and Conversion to correctly display the video program on the TV system. The Auto AFD option enables the receiver output to automatically match the display format of the video program to the TV system based on specific (uplink) program information carried in the transport stream. In this case, the receiver performs the conversion based on the TV Aspect Ratio setting combined with the program-specific uplink information to provide the “best fit” for display of the program material on the TV. This feature is primarily used in 16:9 and 14:9 (wide screen) applications.

Audio

Menu Item	Description	Parameters
Aud#	Sets which balanced audio output on the rear panel to configure.	1 or 2

Chapter 4 Front Panel Operation

Menu Item	Description	Parameters
Stereo/Mono	Sets the output mixing.	<p>Stereo - Left and Right are passed directly through to Left and Right</p> <p>R-MONO - Right is passed to both the Left and Right</p> <p>L-MONO - Left is passed to both the Left and Right</p> <p>Mixed - Left is passed to both the Left and Right, and Right is passed to both the Left and Right.</p>
AC3 Compression	Sets the AC3 compression mode to use if the output is compressed Dolby Digital audio.	<p>Line Mode, Custom 1, Custom 0 or RF Mode.</p> <p>RF Mode is recommended for analog cable modulators.</p>
Left (dB)	Sets the volume adjustment for the Left audio channel, in dB.	<p>-6.0 to +6.0</p> <p>Any value can be entered with the numeric keypad (in the appropriate range), but the UP and DOWN arrows will increase or decrease in 0.5 dB steps.</p>
Right (dB)	Sets the volume adjustment for the Right audio channel, in dB.	<p>-6.0 to +6.0</p> <p>Any value can be entered with the numeric keypad (in the appropriate range), but the UP and DOWN arrows will increase or decrease in 0.5 dB steps.</p>
Select Language By	Method of selecting the audio PID for the local audio decoding. This is required if the monitored program contains more than two audio PIDs.	<p>PMT Order, Language List, Language Entry</p> <p>PMT Order (default) - Allows you to select a PMT order.</p> <p>Language List - Allows you to select a language from the available list.</p> <p>Language Entry - Allows you to enter a language code.</p>

Setup Menu

Menu Item	Description	Parameters
Language List	If Select Language By is set to Language List , select the language for the selected audio.	ara (Arabic), btk (Batak (Indonesia)), ben (Bengali), bul (Bulgarian), chi (Chinese), cze (Czech), dan (Danish), dut (Dutch), eng (English), fin (Finnish), fre (French), ger (German), gre (Greek), heb (Hebrew), hin (Hindi), hun (Hungarian), ice (Icelandic), ind (Indonesian), ita (Italian), jpn (Japanese), kor (Korean), may (Malay), mul (Multiple Languages), nor (Norwegian), per (Persian), pol (Polish), por (Portuguese), rum (Romanian), rus (Russian), san (Sanskrit), scc (Serbian), sin (Sinhalese), slo (Slovak), som (Somali), spa (Spanish), swe (Swedish), tai (Tai Other), tam (Tamil), tha (Thai), tur (Turkish), ukr (Ukrainian), or vie (Vietnamese)
PMT Src	Selects the PMT source for the audio channel.	None, AUDI to AUD64
Entry	If Select Language By is set to Language Entry , select the language entry for the selected audio.	Enter a three-character code provided by your uplink service provider under Entry using the numeric keypad (e.g., eng for English). The supported languages are according to ISO 639-2 Language Codes.

Captions

Menu Item	Description	Parameters
Preferred Mode	Selects the type of closed captioning to use if there are multiple available in the stream.	Auto, SA Custom, EIA 708, Type 3, Type 4 SA, DVS 053 Type 4 ATSC, Reserved or DVS 157. The default is Auto. Note: SA Custom is not supported when telecine video coding is enabled.
Actual Output	Indicates the actual closed caption mode in the output. This is read-only.	Auto, SA Custom, EIA 708, Type 3, Type 4 SA, Type 4 ATSC, Reserved, or DVS 157

Chapter 4 Front Panel Operation

VBI

WSS

Menu Item	Description	Parameters
WSS Mode	Selects the Wide Screen Signaling output mode. It is used to select how the receiver affects PAL WSS when it is present in the VBI line 23.	<p>Auto:Create - Creates WSS to output the correct aspect ratio, when performing aspect ratio conversion.</p> <p>Auto:Modify - If WSS is present in the input stream, it is modified to output the correct aspect ratio when performing aspect ratio conversion. If WSS is not present in the input, no WSS will be present in the output.</p> <p>Suppress - Removes WSS output.</p> <p>Passthrough - Passes WSS unmodified as received by the receiver.</p> <p>The default is Passthrough.</p>
WSS Stat	Indicates the current output value of PAL WSS in VBI line 23.	<p>4:3 F/F, 16:9 L/B CEN, 16:9 L/B TOP, >16:9 L/B, 14:9 L/B CEN, 14:9 L/B TOP, 14:9 F/F CEN, 16:9 F/F, or UNDEFINED</p> <p>Note: F/F is full format, and L/B is letter box.</p>

VITC

This is not supported in the current release.

VITS

Menu Item	Description	Parameters
VITS PAL Line 17, 18, 330, 331	Select whether to enable or disable Vertical Interval Test Signal on PAL Lines 17, 18, 330, or 331.	Enable or Disable

Subtitles

This menu allows you to configure the type of subtitling (i. e., DVB or Imtext) displayed by the transcoder, and how the transcoder displays subtitling on the TV.

Menu Item	Description	Parameters
Op Mode	Sets the subtitle mode.	<p>Off - No subtitles are displayed.</p> <p>On - Displays DVB or Imtext subtitles, if available.</p> <p>DVB - Displays only DVB titles, if available. Otherwise, no subtitles are displayed.</p> <p>Imtext - Displays only Imtext subtitles, if available. Otherwise, no subtitles are displayed.</p>
Select Language By	Select the input source for the subtitle language.	<p>Language List - Allows you to select a language from the available list.</p> <p>Language Entry - Allows you to enter a language code.</p> <p>PMT Order - Allows you to select a PMT order.</p> <p>The default setting is Language List. Language Entry and PMT Order are more applicable for advanced applications.</p>
Language List	If Language List was selected in the Select Language By menu, select the MPEG language to display.	<p>ara (Arabic), btk (Batak (Indonesia)), ben (Bengali), bul (Bulgarian), chi (Chinese), cze (Czech), dan (Danish), dut (Dutch), eng (English), fin (Finnish), fre (French), ger (German), gre (Greek), heb (Hebrew), hin (Hindi), hun (Hungarian), ice (Icelandic), ind (Indonesian), ita (Italian), jpn (Japanese), kor (Korean), may (Malay), mul (Multiple Languages), nor (Norwegian), per (Persian), pol (Polish), por (Portuguese), rum (Romanian), rus (Russian), san (Sanskrit), scc (Serbian), sin (Sinhalese), slo (Slovak), som (Somali), spa (Spanish), swe (Swedish), tai (Tai Other), tam (Tamil), tha (Thai), tur (Turkish), ukr (Ukrainian), or vie (Vietnamese)</p>

Chapter 4 Front Panel Operation

Menu Item	Description	Parameters
PMT Order	If PMT Order was selected in the Select Language By menu, select the subtitle PID entry to display. This information is available from your uplink service provider.	First to Eighth
Entry	If Language Entry was selected in the Select Language By menu, select the subtitle PID entry to display. The information is available from your uplink service provider.	Enter the three-character code provided by your uplink service provider under Entry using the numeric keypad (e.g., eng for English). The supported languages are according to ISO 639-2 Language Codes.
Imitext Position	Sets the position of the on-screen subtitle text.	Standard or Extended
ForeGnd	Sets the text color for Imitext subtitles.	Auto, Yellow, or White. Auto displays text in the color transmitted by the subtitling equipment. Yellow and White override the color set by the uplink, and display text in the selected color.
BackGnd	Sets the text background for Imitext subtitles.	Auto - Uses the uplink subtitling equipment setting. Shadow - Applies an outline to the right side of each text character. No background box is applied to subtitles, i.e., text is visible directly on top of video. Opaque - Applies a black box to each text character. Semi - Applies a semi-transparent box to subtitle text. None - No shadow or outline is applied to subtitle text.

Decode

Menu Item	Description	Parameters
Decoder	Select the local decode service to configure. Note: By default, all the decode services are enabled.	Video, Audio1 to Audio4, VBI (Vertical Blanking Interval) DATA (low speed data), MPE1 to MPE5 (Multiprotocol Encapsulation), STT (Subtitles), or DPI (Digital Program Insertion)
Enabled	Select whether the local decoding of this service is enabled or disabled.	Yes or No

Setup Menu: Outputs

To view the Outputs menus from the Main menu, press the **RIGHT** arrow key once and then the **SELECT** key to reach the Setup menu. Then press the **RIGHT** arrow key four times and the **SELECT** key to view the Outputs menu.

The Outputs menu allows you to set up the rear panel control relays for alarms, cue tones and cue triggers, and the transport stream outputs, Digital Program Mapping (DPM), and Transcoding.

For instructions on how to select and store settings, see *About the Front Panel* (on page 34).

The Outputs menu has the following structure:

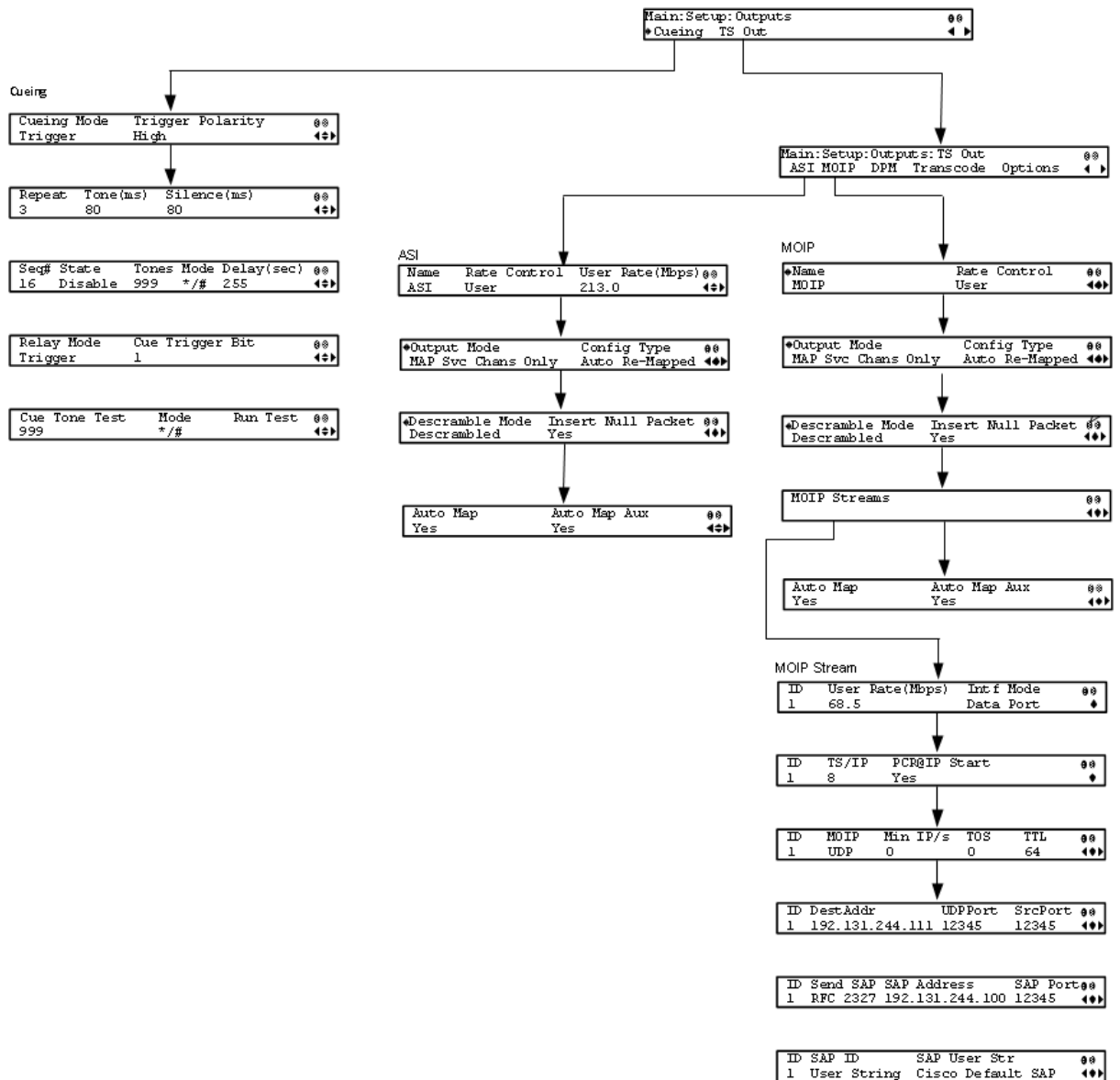

Cueing

Menu Item	Description	Parameters
Cueing Mode	Select whether cueing output should be DTMF tones or trigger pins.	<p>Trigger or Tone</p> <p>Tone - Cue tones are standard Dual-Tone Multi-Frequency (DTMF) tones. The tones are generated at the Cue Tone/Relay output on the rear panel of the receiver.</p> <p>Trigger - Cue trigger refers to open-collector pins which can be toggled at the Cue Tone/Relay output on the rear panel of the receiver.</p>
Trigger Polarity	If the Cueing Mode was set to Trigger, select the pin polarity.	<p>High or Low</p> <p>High - Pins act as open or floating collectors on an active cueing signal and as ground on an inactive signal.</p> <p>Low - Pins act as ground on an active cueing signal and as open or floating collectors on an inactive signal.</p>
Repeat	If the Cueing Mode was set to Tone, set the number of consecutive tone sequences to be generated. Values greater than 1 are provided when a scenario demands repetition to ensure that the ad insertion equipment receives the signal.	1, 2, or 3. The default is 3.
Tone (ms)	If the Cueing Mode was set to Tone, set the duration of each tone, in milliseconds.	0 to 80. The default is 40.
Silence (ms)	If the Cueing Mode was set to Tone, set the duration, in milliseconds, of each silence between tones.	0 to 80. The default is 40.
Seq#	Select the tone sequence to configure.	1 to 16
State	Select whether the current tone sequence is enabled or disabled.	Enabled or Disabled. When disabled, no cue tone is output.

Chapter 4 Front Panel Operation

Menu Item	Description	Parameters																							
Tones	Sets the three digit tone sequence.	000 to 999																							
Mode	Sets the tone sequence mode.	* - Start tone only # - End tone only */# - Start and end tones. The end tone is signaled after waiting the time specified in Delay(sec).																							
Delay(sec)	If the Mode was set to */# (Start/Stop), set the delay, in seconds, between the start and stop sequences.	1 to 255. The default is 30.																							
Relay Mode	The relay can be programmed to respond to an alarm or warning state, or the state of one of the eight cue trigger pins. The response is generated at the Cue Tone/Relay output on the rear panel of the receiver.	Alarm or Trigger The following table displays the possible field settings and their relationship to the receiver output: <table border="1" data-bbox="993 873 1438 1434"> <thead> <tr> <th rowspan="2">Relay Mode</th> <th rowspan="2">Condition</th> <th colspan="2">Relay Contact</th> </tr> <tr> <th>NC-C</th> <th>C-No</th> </tr> </thead> <tbody> <tr> <td rowspan="3">Alarm</td> <td>Unit Power Off</td> <td>Open</td> <td>Close</td> </tr> <tr> <td>Alarm State</td> <td>Open</td> <td>Close</td> </tr> <tr> <td>No Alarm</td> <td>Close</td> <td>Open</td> </tr> <tr> <td rowspan="2">Trigger</td> <td>Active (selected in PNC)</td> <td>Close</td> <td>Open</td> </tr> <tr> <td>Inactive</td> <td>Open</td> <td>Close</td> </tr> </tbody> </table>	Relay Mode	Condition	Relay Contact		NC-C	C-No	Alarm	Unit Power Off	Open	Close	Alarm State	Open	Close	No Alarm	Close	Open	Trigger	Active (selected in PNC)	Close	Open	Inactive	Open	Close
Relay Mode	Condition	Relay Contact																							
		NC-C	C-No																						
Alarm	Unit Power Off	Open	Close																						
	Alarm State	Open	Close																						
	No Alarm	Close	Open																						
Trigger	Active (selected in PNC)	Close	Open																						
	Inactive	Open	Close																						
Cue Trigger Bit	If the Relay Mode is set to Trigger , select the cue trigger bit/pin that will activate the relay.	1 to 8																							
Cue Tone Test	Sets the three digit cueing tone test sequence.	000 to 999																							
Mode	Sets the test sequence mode.	* - Start tone # - End tone																							
Run Test	Select and press continue to run the cue tone test according to the Cue Tone Test and Mode.																								

TS Out - ASI

Menu Item	Description	Parameters
Name	Displays the name assigned to the transport output for ease of reference. This is read-only.	20-character string
Rate Control	Select the output rate control.	<p>Auto - The output rate follows that set by the uplink. This setting can be used if the signal source is ASI. If Insert Null Packet is set to Yes, the output bit rate is the same as the input rate (including all the null packets). If Insert Null Packet is set to No, the output rate is equal to the payload rate of the transport stream to be encapsulated, and in most cases, it will be lower than the overall input rate.</p> <p>User - The output rate is specified by the User Rate(Mbps) parameter. It is determined by the user setting regardless of the input source. Null packets are always inserted when the configured output bit rate is higher than the payload rate of the transport stream to be encapsulated.</p>
User Rate(Mbps)	<p>If the Rate Control is set to User, set the maximum output bit rate. If null packets are inserted, this will be the output rate.</p> <p>This setting is used when the signal source is RF or ASI and allows you to set the output bit rate to a value expected by equipment connected to the ASI output.</p>	<p>0 to 206 Mbps</p> <p>Note: Output data may be lost if this bit rate is set to a value less than the actual signal bit rate.</p>

Menu Item	Description	Parameters
Output Mode	<p>Select the DPM output mode for the current output.</p> <p>With the exception of No Output and Full DPM Control, selecting a mode will configure the DPM settings to achieve the specified behavior. In this way, they act as DPM presets.</p> <p>The Config Type is changed from Unmodified to Edited by User.</p> <p>It is highly recommended to use either one of these basic modes, or, for advanced setup, enter the DPM mapping before setting the Output Mode.</p>	<p>No Output - No ASI output will be generated and the ASI port will be disabled.</p> <p>Passthrough - All PEs will be set to Pass and other DPM settings will also be set.</p> <p>Service Chans Only - This is similar to Passthrough, except that only channels applied to program entries are available on the output.</p> <p>MAP Passthrough - The output will be identical to the input, except that channels assigned to PEs and PIDs will be mapped using the DPM settings. If the input is tuned to a valid channel, the PEs are automatically set to Map. Otherwise, the PEs are automatically set to Drop. When selecting MAP Passthrough, the option to re-sync will be provided. If you select Yes, it will set the DPM mapping to the last valid (or saved) configuration. If you select No, it will use the existing DPM maps. If the PE is mapped, it uses the last saved output MAP configuration. The output map (for example, output channel PMT) does not change automatically if the input or channel number is changed.</p> <p>MAP Svc Chans Only - This is similar to MAP Passthrough, except that only channels applied to program entries are available on the output. If the input is tuned to a valid channel, the PEs are automatically set to Map. Otherwise, the PEs are automatically set to Drop. When selecting MAP Svc Chans Only, the option to re-sync will be provided. If you select Yes, it will set the DPM mapping to match the current input. If you select No, it will use the existing DPM maps. If the pE is mapped, it uses the last valid input. The output map (for example, output channel PMT) does not change automatically if the input or channel number is changed.</p> <p>Full DPM Control - The output will be generated according to the DPM settings. This is a manual control setting.</p> <p>Transcoding - The output will be generated using the DPM MAP settings, except that the DPM action (Act) will be set to Xcode and the Descramble Mode will be set to Descrambled.</p>

Setup Menu

Menu Item	Description	Parameters
Config Type	Indicates the current DPM configuration change by a user after changing the Output Mode .	<p>Edited by User - DPM changes were made.</p> <p>Unmodified - No changes were made after setting a new Output Mode.</p> <p>Auto Re-Mapped - Output map changed automatically to fix the output channel or PID conflicts at the time of setup.</p> <p>Changed by Uplink - DPM output changes were initiated by an encoder.</p>
Descramble Mode	Select whether the output will be descrambled if the input is scrambled.	<p>Scrambled - The output channel will remain scrambled even if the PE is authorized and can descramble the channel.</p> <p>Descrambled - Descrambles the output channel, and passes in-the-clear channels.</p> <p>The default is Descrambled.</p>
Insert Null Packet	Select whether to insert null packets into the output to maintain output at a constant bit rate.	<p>Yes or No</p> <p>Note: It is recommended that the Insert Null Packet is set to Yes, especially if the Output Mode is set to Transcoding.</p>
Auto Map	Sets whether the DPM resolves the channel and PID collisions automatically on the transport outputs. New values are assigned to the parameters that caused the conflict. The new assigned values are not used by any incoming transport or other PE outputs. If a collision is detected, you can review the new changes before applying the new changes.	<p>Yes or No</p>
Auto Map Aux	<p>Select whether the DPM sets the output actions for all the auxiliary PEs to Map when the Output Mode is set to Transcode. If the Fixed Output is set to Yes, the output configuration for the auxiliary PEs is determined by the fixed output table options when you resynchronize the output channels and PIDs to match the input programs.</p> <p>Note: The DPM resolves any output conflicts automatically, even if the Auto Map is set to No.</p>	<p>Yes or No</p>

MOIP

Menu Item	Description	Parameters
Name	This is the name assigned to the transport output for ease of reference.	20-character string
Rate Control	This is the DPM output rate control.	<p>Auto - The output rate follows that set by the uplink. This setting can be used if the signal source is ASI. If Insert Null Packet is set to Yes, the output bit rate is the same as the input rate (including all the null packets). If Insert Null Packet is set to No, the output rate is equal to the payload rate of the transport stream to be encapsulated, and in most cases, it will be lower than the overall input rate.</p> <p>User - The output rate is specified by the User Rate parameter. It is determined by the user setting regardless of the input source. Null packets are always inserted when the configured output bit rate is higher than the payload rate of the transport stream to be encapsulated.</p>

Menu Item	Description	Parameters
Output Mode	<p>Select the DPM output mode for the current output.</p> <p>With the exception of No Output and Full DPM Control, selecting a mode will configure the DPM settings to achieve the specified behavior. In this way, they act as DPM presets.</p> <p>The Config Type is changed from Unmodified to Edited by User.</p> <p>It is highly recommended to use either one of these basic modes, or, for advanced setup, enter the DPM mapping before setting the Output Mode.</p>	<p>No Output - No MPEGoIP output will be generated.</p> <p>Passthrough - All PEs will be set to Pass and other DPM settings will also be set.</p> <p>Service Chans Only - This is similar to Passthrough, except that only channels applied to program entries are available on the output.</p> <p>MAP Passthrough - The output will be identical to the input, except that channels assigned to PEs and PIDs will be mapped using the DPM settings. If the input is tuned to a valid channel, the PEs are automatically set to Map. Otherwise, the PEs are automatically set to Drop. When selecting MAP Passthrough, the option to re-sync will be provided. If you select Yes, it will set the DPM mapping to the last valid (or saved) configuration. If you select No, it will use the existing DPM maps. If the PE is mapped, it uses the last saved output MAP configuration. The output map (for example, output channel PMT) does not change automatically if the input or channel number is changed.</p> <p>MAP Svc Chans Only - This is similar to MAP Passthrough, except that only channels applied to program entries are available on the output. If the input is tuned to a valid channel, the PEs are automatically set to Map. Otherwise, the PEs are automatically set to Drop. When selecting MAP Svc Chans Only, the option to re-sync will be provided. If you select Yes, it will set the DPM mapping to match the current input. If you select No, it will use the existing DPM maps. If the PE is mapped, it uses the last valid input. The output map (for example, output channel PMT) does not change automatically if the input or channel number is changed.</p> <p>Full DPM Control - The output will be generated according to the DPM setting.</p> <p>Transcoding - The output will be generated using the DPM MAP settings, except that the DPM action (Act) will be set to Xcode and the Descramble Mode will be set to Descrambled.</p>

Chapter 4 Front Panel Operation

Menu Item	Description	Parameters
Config Type	Indicates the current DPM configuration change by a user after changing the Output Mode.	<p>Edited by User - DPM changes were made.</p> <p>Unmodified - No changes were made after setting a new Output Mode.</p> <p>Auto Re-Mapped - Output map changed automatically to fix the output channel or PID conflicts at the time of setup.</p> <p>Changed by Uplink - DPM output changes were initiated by an encoder.</p>
Insert Null Packet	<p>This parameter selects whether to insert null packets in the output stream.</p> <p>Null packets are always inserted if the Rate Control is set to User.</p>	Yes or No
Descramble Mode	This parameter selects whether the receiver should scramble the output even if it is authorized to receive the channel.	<p>The default mode is Descrambled.</p> <p>Scrambled - Scrambles the output channel even if the PE is authorized and can descramble the channel.</p> <p>Descrambled - Descrambles the output channel, and passes in-the-clear channels.</p>
Auto Map	Sets whether the DPM resolves the channel and PID collisions automatically on the transport outputs. New values are assigned to the parameters that caused the conflict. The new assigned values are not used by any incoming transport or other PE outputs. If a collision is detected, you can review the new changes before applying the new changes.	Yes or No

Menu Item	Description	Parameters
Auto Map Aux	<p>Select whether the DPM sets the output actions for all the auxiliary PEs to Map when the Output Mode is set to Transcode. If the Fixed Output is set to Yes, the output configuration for the auxiliary PEs is determined by the fixed output table options when you resynchronize the output channels and PIDs to match the input programs.</p> <p>Note: The DPM resolves any output conflicts automatically, even if the Auto Map is set to No.</p>	Yes or No

MOIP Streams

Menu Item	Description	Parameters
User Rate (Mbps)	<p>This parameter controls the output rate when Rate Control is set to User.</p> <p>Note: Output data will be partially or completely lost if the user-selected bit rate is set to a value that is less than the actual signal bit rate.</p>	0 to 206 Mbps
Intf Mode	This selects the MPEG over IP output mode.	<p>None - Disables the MPEG over IP interface.</p> <p>Data Port - Always output data on the Data port.</p> <p>Control Port - Always output data on the Management port.</p>
TS/IP	This selects the maximum number of transport packets per IP packet.	1 to 7
PCR@IP Start	This selects whether to always transmit a new IP packet when a new Program Clock Reference (PCR) arrives.	Yes or No

Chapter 4 Front Panel Operation

Menu Item	Description	Parameters
MOIP	Selects the transport protocol to be used for the output stream.	RTP or UDP
Min IP/s	This selects the minimum number of IP packets per second.	0, 2 to 1000
TOS (Type Of Service)	This sets the quality of service.	0 to 255
TTL (Time To Live)	This sets the hop limit of the packet's lifespan.	0 to 255
DestAddr	Enter the unicast (valid host IP only) or multicast destination IP address.	Unicast: valid host IP Multicast: IP in range of 224.0.0.0 to 239.255.255.255 Note: It is not recommended to use multicast IP addresses reserved by the Internet Assigned Numbers Authority (IANA).
UDPPort	This selects the destination port number.	1 to 65534 Note: If you selected RTP for MOIP, you must select an even destination port number. Note: It is not recommended to use destination UDP ports reserved by the IANA.
SrcPort	This selects the source UDP port number.	0 to 65535 Note: Set the SrcPort to 0 to use the default source UDP port (49162).
Send SAP	This selects whether to send Session Announcement Protocol messages.	None or RFC2327
SAP Multicast Address	This is the IP address where the SAP announcements are sent, if required.	It is not recommended to change the default IP address (224.2.127.54).
SAP Port	This is the UDP port where the SAP announcements are sent, if required.	1 to 65534 Note: It is not recommended to change the default SAP port 9875.
SAP ID	Describes the SAP output stream name source.	User String or SDT Channel
SAP User Str	Provides the SAP user string.	Up to 31 characters

TS Out - DPM

To view the DPM menu from the TS Out menu, press the **RIGHT** arrow key. The DPM menu provides access to functionality associated with Global, ASI, and MOIP outputs.

The DPM menu allows you to groom functionality on a program basis where individual service PID modifications are provided on a limited scale.

Use the digital program mapping features to:

- configure the transport output bit rate
- configure the output mode for a program entry
- configure the service and PID output settings in a program entry

Note: Any changes made to the ASI/MOIP DPM values will automatically change the **Config Type** to **Edited by User**.

The DPM menu has the following structure:

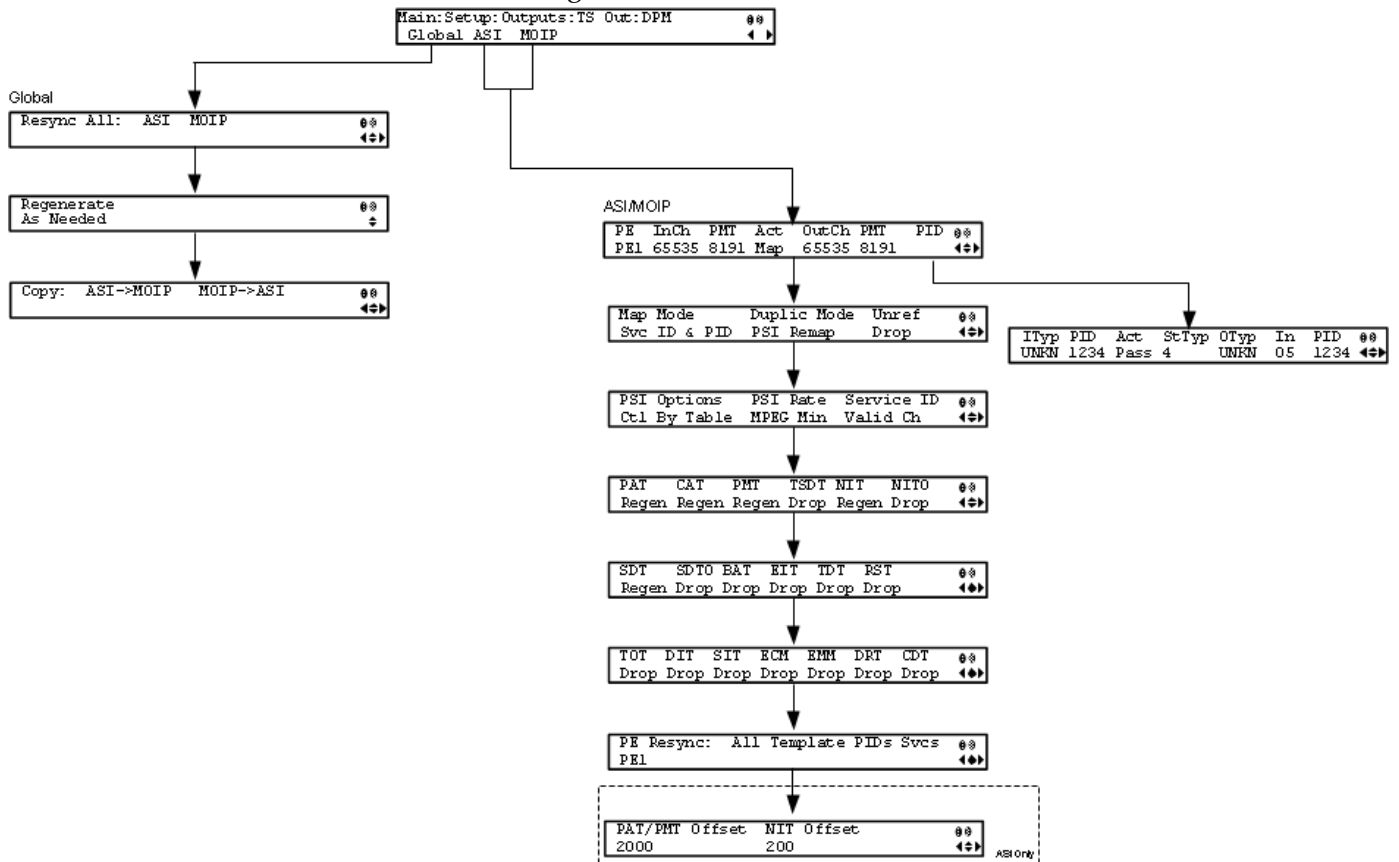

Chapter 4 Front Panel Operation

DPM - Global

Menu Item	Description	Parameters
Resync All:	Select to resynchronize all DPM output with the PMT data for all program entries on the selected output.	ASI
Regenerate	Selects whether to regenerate the PSI tables in the output.	Always or As Needed Always - All tables are regenerated. As Needed - Only regenerate the tables if the content has changed.
Copy:	This copies all DPM data from either the ASI output to the MOIP output (MPEG over IP) or from the MOIP output to the ASI output depending on your selection.	ASI->MOIP or MOIP->ASI

ASI/MOIP

Menu Item	Description	Parameters
PE	Select the Program Entry to configure.	1 to 8 (main program) 1A to 8A (auxiliary program)
InCh	Displays the channel number to which the PE is tuned. This is read-only.	1 to 65535
PMT	Indicates the input PID value of the Program Map Table for the current channel. This is read-only.	2 to 8190

Menu Item	Description	Parameters
Act	<p>Selects the action to perform on the current program entry.</p> <p>This setting controls the overall DPM behavior of the PE and will affect how the PID mapping operates.</p>	<p>Pass (default) - Output channel is the same as the input channel. The OutCh, and PMT settings are ignored. All PID map entries are ignored except for entries that explicitly drop a service.</p> <p>Map - The output channel is mapped to the OutCh and PMT settings. Only services which have entries in the PID map are available on the output. These services will appear in the PMT even if the stream is not present.</p> <p>Note: If the PE is mapped, it uses the last valid (or saved) configuration. The output map (for example, output channel PMT) does not change automatically if the input or channel number is changed.</p> <p>Drop - The current channel is not sent to the output and its PMT is removed from the output. The OutCh, PMT, and PID map entries are ignored.</p> <p>XCode - Provides the flexibility to define all the outgoing PID numbers for a PE, including those not currently on transmission, as in Map mode, plus the video PID is transcoded to output at the rate and settings defined for the transcode channel.</p> <p>Note: The Auxiliary Programs (P1A to P8A) cannot be set to XCode. Also, they are automatically dropped when the corresponding Main PE is not transcoding.</p>
OutCh	<p>If mapping the current PE (Act was set to Map), set the output channel number for the current program.</p>	<p>1 to 65535</p>
PMT	<p>If mapping the current PE (Act is set to Map), set the output PID of the PMT.</p>	<p>2 to 8190</p>

Chapter 4 Front Panel Operation

Menu Item	Description	Parameters
PID	Press Select to view and configure the PID map. The PID map is used to map input services to output PIDs. For more information, see <i>PID Map Menu</i> (on page 104).	
Map Mode	Select the DPM mapping mode for the current output.	<p>Svc ID - The elementary PIDs are not changed. Channels are remapped by changing their PSI references. When this mode is selected, PID mapping in the PID Map menu is ignored.</p> <p>Svc ID & PID - Channels and the elementary service PIDs can be mapped using the PID Map menu.</p>
Duplic Mode	Select how to handle duplicate programs. This setting is only used if the Map Mode menu is set to Svc ID & PID.	<p>PSI Remap - Every input PID can be mapped to only one output PID. If PID mapping conflicts exist, DPM will use the Precedence Rule to decide which output PID to use. All PMTs using the input PID will be updated to reference the output PID specified by the winner.</p> <p>Pkt Copy - An input PID can be mapped to multiple output PIDs. The PID will be duplicated as many times as needed (up to a certain hardware limitation).</p> <p>Note: This may increase the output bandwidth of the stream.</p> <p>Pkt Copy is recommended for most applications.</p>
Unref	Select the action to use for unreferenced content. Unreferenced content is the remainder of the transport stream that is not filtered by the program entries.	<p>Drop or Pass</p> <p>Drop - All unreferenced content is dropped.</p> <p>Pass - All unreferenced content is passed to the output unchanged.</p>

Menu Item	Description	Parameters
PSI Options	<p>Select the action to perform on the PSI tables for the output stream.</p> <p>Note: The table menus (PAT, CAT, PMT, TSDT, NIT, NITO, SDT, SDTO, BAT, EIT, TDT, RST, TOT, DIT, SIT, ECM, EMM, DRT, CDT) will only appear if you select Ctl by Table.</p>	<p>Pass All - Transmits the incoming PSI Tables as is; does not modify the content and rate. The PSI Rate and table settings are ignored.</p> <p>Drop All - Does not transmit any PSI Tables. The PSI Rate and table settings are ignored.</p> <p>Ctl by Table - Configure the table specific output mode for each table.</p>
PSI Rate	<p>If the PSI Options was set to Ctrl by Table, select the regeneration rate for those PSI tables being regenerated.</p>	<p>Auto - Matches the generated PSI tables' output rate to the incoming rate.</p> <p>MPEG Min - Transmits the generated PSI tables on the longest intervals that are allowed by MPEG standard.</p> <p>SA Std - Transmits the generated PSI tables based on PowerVu standard intervals.</p>
Service ID	<p>Select whether the receiver should always generate PSI tables for the Mapped PE even if the selected input channel is not available, or for only valid service channels/IDs.</p>	<p>Valid Ch - Only transmits the PSI tables for the mapped program if the program exists on the input stream.</p> <p>All Ch - Transmits the PSI tables for the mapped program even if the program does not exist in the input stream.</p> <p>All Ch is only valid if the PAT, NIT, SDT and PMT are set to Regenerate.</p>
PAT, CAT, PMT, TSDT, NIT, NITO, SDT, SDTO, BAT, EIT, TDT, RST, TOT, DIT, SIT, ECM, EMM, DRT, CDT	<p>Selects the tables which will be passed, dropped, regenerated, or passed with rate control (PwRC) from the output. For more information, see <i>PSI Table Settings</i> (on page 105).</p> <p>Note: The table settings are only available if you selected Ctl by Table in the PSI Options menu.</p>	

Chapter 4 Front Panel Operation

Menu Item	Description	Parameters
PE Resync: All, Template, PIDs, Svcs	Each PE output can be synchronized to its input according to one of four output modes. For information on synchronizing output services, see <i>Synchronizing Output Services</i> (on page 108).	Svcs - Map the input to the output based on the services only. PIDS - Map the input to the output based on the PIDs only. All - Map the input to the output based on the PIDs and services Template - Map the input to a fixed template output.
PAT/PMT Offset	This is a customer-specific mode, only to be used if directed by Cisco. For more information, contact Cisco customer support.	
NIT Offset	This is a customer-specific mode, only to be used if directed by Cisco. For more information, contact Cisco customer support.	

PID Map Menu

This menu allows the PID Map to be configured. The PID map is used to map input services to output PIDs.

If the PE action is Pass, or PE action is Map and Map Mode is Svc ID, only entries which drop a service are applied and all other services are passed through. If the PE action is Map and Map Mode is Svc ID & PID, all entries are applied. Any services not mapped by an entry will be dropped.

Press up and down to scroll through the PID map entries. Press **ADV** to insert or delete entries from the PID map. After inserting an entry, specify the service using OutType and In, and set the desired Action. If the action is Map, select the output PID value as well. Then press **APPLY** and save the settings to see the selected input service that will follow that mapping.

Menu Item	Description	Parameters
ITyp	Displays the input service that will be mapped by the current entry. This value is read-only and for reference purposes.	
PID	Displays the input PID that will be mapped by the current entry. This value is read-only and for reference purposes.	1 to 8190

Menu Item	Description	Parameters
Act	Select the action to perform on the current PID. The Drop action is always performed, but the Map option is only applied if the PE action is set to Map or XCode.	Map - The service selected by the OutType and Instance will be mapped to the specified PID. This is only applied if the PE action is set to Map or XCode. Drop - The service selected by the OutType and Instance will be removed from the PMT and the output stream.
SfTyp	Enter the stream type to map within a PE to a specified PID.	0 to 255
OType	Select the service to configure. If an input service matches this type and instance specified by In, then the Action will be applied.	UNKN, ETV, CDT, LSDT, DATA, TTX, MPE, DPI, VBI, SUBT, AUD, VID, PCR or INVL
In	Select the instance of the service specified by OType to configure. If an input service matches this type and instance, then the Action will be applied.	1 to 64
PID	If mapping this PID (Act is set to Map), select the output PID number.	1 to 8190

PSI Table Settings

Note: The table settings are only available if you selected Ctl by Table in the PSI Options menu. The default values for the PSI table settings are dependent on the Output Mode. For a list of default values, see *DPM Default Settings for Different Output Modes* (on page 351).

Setting	Mode Options	Description
PAT	Pass, Drop, Regen	Program Association Table
CAT	Pass, Drop, Regen	Conditional Access Table
PMT	Pass, Drop, Regen	Program Map Table
TSDT	Pass, Drop	Transport Stream Description Table
NIT	Pass, Drop, Regen, PwRC	Network Information Table

Setting	Mode Options	Description
NITO	Pass, Drop, PwRC	Network Information Table - Other
SDT	Pass, Drop, Regen, PwRC	Service Description Table
SDTO	Pass, Drop, PwRC	Service Description Table - Other
BAT	Pass, Drop, PwRC	Bouquet Association Table
EIT	Pass, Drop	Event Information Table
TDT	Pass, Drop	Time and Date Table
RST	Pass, Drop	Running Status Table
TOT	Pass, Drop	Time Offset Table
DIT	Pass, Drop	Discontinuity Information Table
SIT	Pass, Drop	Selection Information Table
ECM	Pass, Drop	Entitlement Control Message
EMM	Pass, Drop	Entitlement Management Message
DRT	Pass, Drop	Disaster Recovery Table
CDT	Pass, Drop	Code Download Table

Note: The CDT is different from the other tables listed because the CDT is referred to within the PMT, rather than outside the PMT. Select Pass to permit the output of CDTs following the configured DPM PID map configuration and all other DPM constraints. If a DPM PID map has not been configured for the CDT PID and the PE Act is set to Map, the CDT will still not output. Select Drop to override the DPM PID map configuration for CDT PIDs and to always drop all CDTs.

Setting Up Digital Program Mapping (DPM)

To set up DPM:

- 1 Verify that you are receiving a valid signal and that you have set up the channels that you want to pass, drop or map.
- 2 Go to the Setup: Outputs, TS Out: DPM: Global menu and select **Resync All** for the selected ASI output. This copies the input services PIDs to the remapped output service PIDs.
- 3 Go to Setup: Outputs: TS Out: DPM: ASI, and select the PE containing the channel you want to configure.
- 4 Set the **Act** for the selected PMT to either **Pass**, **Drop**, **XCode**, or **Map** depending on the action desired. For more information on each mode, see *ASI/MOIP1* (see "ASI/MOIP" on page 100).

- 5 Use the **RIGHT** arrow key to move to the right and select PID to display the detailed menu level.
- 6 Configure the input to output channel mapping. Video and PCR can be output on the same PID or different PIDs. If output on the same PID, they will appear identical to the input.

Note: If the parameters cannot be saved, the problem may be that the incorrect Map Mode has been selected. Ensure that Svc ID & PID is selected when remapping PIDs, otherwise a message such as “Bad configuration data” will be displayed and you will need to change the parameters to obtain the correct output.

- 7 Go to Setup: Outputs, TS Out: ASI, and set the **Output Mode** to **Full DPM Control**. Also, if necessary set the Descramble Mode according to whether the program is to be Scrambled or Descrambled for downstream viewing/monitoring.
- 8 On the same menu, set the following parameters:

Parameter	Description
Map Mode	Svc ID & PID
Duplic Mode	Pkt Copy
Unref	Drop
PSI Options	Ctl By Table
PSI Rate	Any
Svc ID	Any

- 9 Set the table parameters as follows:

Parameter	Description
PAT	Regen
CAT	Regen
PMT	Regen
TSDT	Drop
NIT	Regen or Drop
NITO	Drop
SDT	Regen
SDTO	Drop
BAT	Drop
EIT	Drop
TDT	Pass

Parameter	Description
RST	Pass
TOT	Pass
DIT	Pass
SIT	Pass
ECM	Drop
EMM	Drop
DRT	Drop
CDT	Drop

- 10** Press **MENU** three times to exit the TS Out menu and save the data. If the changes cannot be saved/made, a message will be displayed indicating "Bad configuration data". The following options are available: Abandon, Exit or Return. Select Return to re-enter the parameter.

Note: When remapping an input program channel to an output channel, ensure that the PIDs are mapped to different PIDs to avoid PID collisions.

Synchronizing Output Services

To synchronize the output to the input Services Only:

This operation synchronizes the inputs to the outputs according to the service assignments only. This is useful when you already have PID assignments set for the services but want to ensure that the services are mapped correctly.

- 1 On the DPM menu, map the output services as desired.
- 2 Select PE Resync: Svcs. The receiver will synchronize the PE output according to the available input services only, and ignore the input to output service PID mapping.

To synchronize the output to the input PIDs only:

This operation synchronizes the inputs to the outputs according to the PID assignments only. This is useful when you already have the services set up but want to synchronize to the incoming PIDs.

- 1 On the DPM menu, map the output services as desired.
- 2 Select PE Resync: PIDs. The receiver will synchronize the PE output according to the input PIDs only, and ignore the service assignment categories/names.

To synchronize the output to All (Services and PIDs):

This operation synchronizes the inputs to the outputs of the current PMT according to the service assignments and then the PID assignments. This is similar to a sample and hold function.

- 1 On the Detailed Program Mapping Active menu, map the outputs services as desired.

- 2 Select PE Resync: All. The receiver will synchronize the PE output according to the services and then the PIDs assigned to each service.

To synchronize the output to a Template:

Using a template allows you to preset the input to output mapping of a PE according to the preset template. This is helpful in pre-configuring any number of PEs for future use.

TS Out - Transcode

To view the **Transcode** menu from the TS Out menu, press the **RIGHT** arrow key three times.

The **Transcode** menu allows you to convert MPEG-4 HD services to MPEG-2 for use in CATV headends. Video and two audio monitoring outputs are available for confidence monitoring of the decrypted incoming MPEG-4 HD program.

The Transcode menu has the following structure:

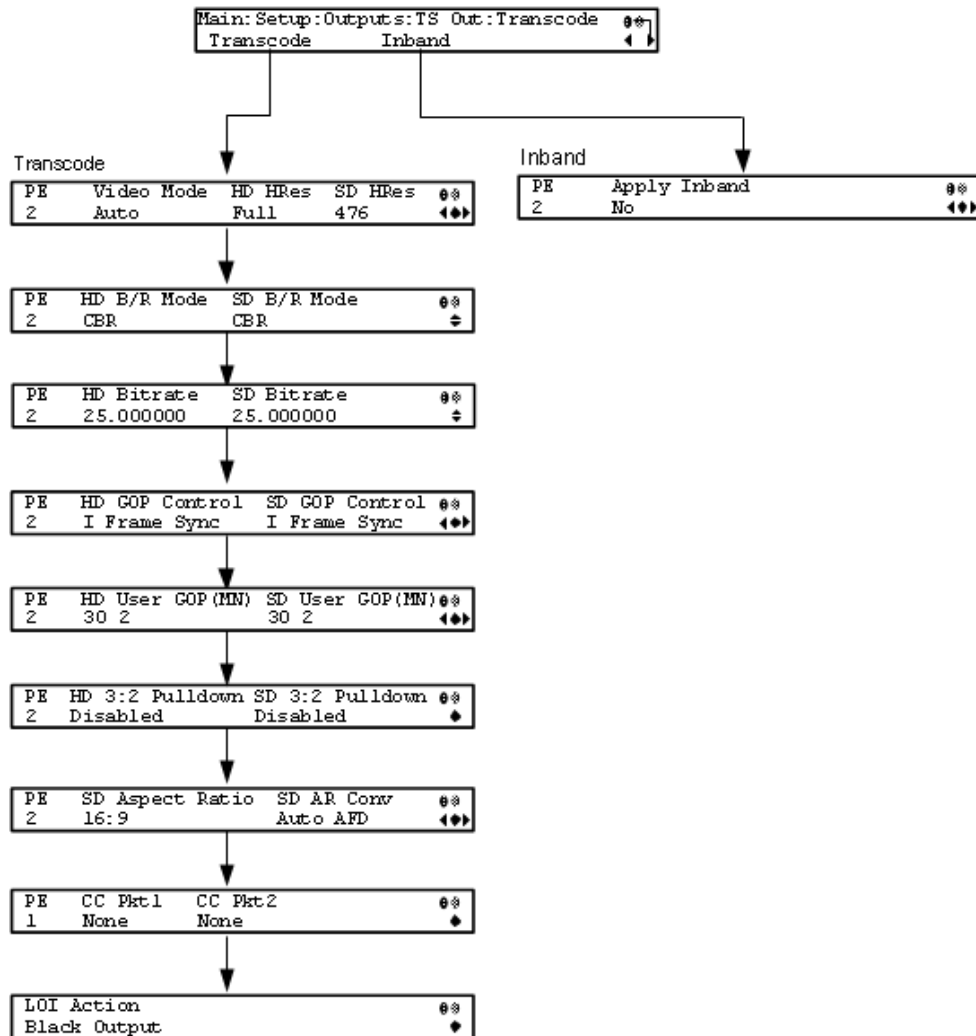

Chapter 4 Front Panel Operation

Transcode

Menu Item	Description	Parameters																	
PE	This selects the transcoder index as referenced by DPM.	1 to 8																	
Video Mode	This selects the transcode channel video mode.	<p>Auto - Leaves the input video format and resolution unchanged. e.g., SD in - SD out, HD in - HD out.</p> <p>SD Output - Down-converts from HD to SD when receiving an HD input signal. SD horizontal resolution will follow the SD Res parameter set on this menu.</p> <p>HD Output - Up-converts from SD to HD1080i when receiving an SD input signal. HD horizontal resolution will follow the HD Res parameter on this menu.</p> <p>HD720p - Sets the output vertical resolution to HD720p regardless of the input resolution.</p> <p>HD1080i - Sets the output vertical resolution to HD1080i, regardless of the input resolution.</p>																	
HD HRes	This selects the transcode channel HD horizontal output video resolution.	Full or 3/4 <table border="1" data-bbox="993 1167 1390 1541"> <thead> <tr> <th rowspan="2">Setting</th> <th colspan="2">Description</th> </tr> <tr> <th>Input Resolution</th> <th>Output Resolution</th> </tr> </thead> <tbody> <tr> <td>Full</td> <td>1080i</td> <td>1920</td> </tr> <tr> <td>3/4</td> <td>1080i</td> <td>1440</td> </tr> <tr> <td>Full</td> <td>720p</td> <td>1280</td> </tr> <tr> <td>3/4</td> <td>720p</td> <td>960</td> </tr> </tbody> </table>	Setting	Description		Input Resolution	Output Resolution	Full	1080i	1920	3/4	1080i	1440	Full	720p	1280	3/4	720p	960
Setting	Description																		
	Input Resolution	Output Resolution																	
Full	1080i	1920																	
3/4	1080i	1440																	
Full	720p	1280																	
3/4	720p	960																	
SD HRes	This selects the transcode channel SD horizontal output video resolution.	352, 480, 528, 544, 704, or 720																	
HD/SD B/R Mode	This selects the transcode channel output bit rate mode.	CBR or VBR																	
HD Bitrate	This sets the transcode channel output bit rate when HD MPEG-4/ AVC to HD MPEG-2 transcoding is selected.	8 to 25 Mb/s in 400 b/s increments. The default is 16.0 Mb/s.																	

Menu Item	Description	Parameters
SD Bitrate	This sets the transcode channel output bit rate when HD to SD transcoding is selected for the output channel.	2 to 15 Mb/s in 400 b/s increments. The default is 4.0 Mb/s.
HD/SD GOP Control	This selects the Transcode Group of Pictures (GOP) format.	User GOP (MN), I Frame Sync, or Fixed GOP
HD/SD User GOP (M N)	This selects the transcode manual GOP format value. The transcoder attempts to reuse information from the encoded bit stream to improve the video quality of the transcoded stream. Amongst others, if the incoming GOP structure is similar to that of an MPEG-2, it will reuse the frame allocations from the incoming stream as long as GOP Control is set to I Frame Sync. If the downstream transcoder does not support altering GOP structures, set the GOP Control setting to User GOP (MN). This will also require the setting of the GOP structure which is given as two numbers, where the first is the length of the GOP and the second is the number of B-pictures per sub-GOP.	Supported GOP structures - 1 0, 12 2, 15 2, 24 2 or 30 2
HD/SD 3:2 Pulldown	This enables or disables 3:2 pulldown.	Enabled or Disabled
SD Aspect Ratio	This selects the HD/SD transcode channel aspect ratio.	4:3 or 16:9 (wide aspect ratio). The default is 16:9. Set it to the corresponding value.
SD AR Conv	This selects the HD/SD transcode channel aspect ratio conversion. This is the conversion that the transcoder will perform on the output signal for the picture to be displayed correctly (i.e., to correspond to the aspect ratio of your TV) on your TV, based on your selection.	Auto, None, 16:9 L/B (letter box), 4:3 P/B (pillar box), 14:9, 4:3 CCO, 16:9 SCALE or Auto AFD (Auto setting using Active Format Descriptor). The default is set to Auto. See <i>Setup Menu: Services</i> (on page 76) for more information.

Chapter 4 Front Panel Operation

Menu Item	Description	Parameters
CC Pkt 1, CC Pkt 2	This selects the order to output the closed caption packets on the transcoded SD output.	None, SCTE-20, or CEA 708. The default is CEA 708.
LOI Action	This selects the transcode Loss Of Input (LOI) Action, which is the action that the transcoder takes when there is a loss of input signal.	No Output or Black Output

Setting Up Transcoding

To set up the transcode channel:

- 1 Verify that you are receiving a valid signal and that you have set up the channels that you want to transcode.
- 2 Go to Setup: Outputs: TS Out: DPM: ASI, and set the Output Mode to Transcoding. You will be prompted to Resync All for the selected output. This resynchronizes the inputs to outputs for the current PMT according to the service assignments and the PIDs for the PE.
- 3 Press **MENU** to exit the menu and save the data. If the changes cannot be saved/made, a message will be displayed indicating “Bad configuration data”. In this case, the menu will revert to the previously saved configuration. Note: When remapping an input program channel to an output channel, ensure that the PIDs are mapped to different PIDs to avoid PID collisions.
- 4 If desired, set a program channel for the second transcoder channel, PE2, and repeat step 2. See *LCD Symbol* (on page 40) for more information on assigning a program channel to a PE.

Inband

Menu Item	Description	Parameters
PE	This selects the transcoder index as referenced by DPM.	1 to 8
Apply Inband	This applies the uplink parameters for transcoding, such as bitrate, GOP and resolution, to the local transcoder settings for the selected program entry. This is only supported with an uplink that uses uplink transcoding controls for the user address of the selected program entry.	Yes or No

TS Out - Options

To view the **Options** menu from the TS Out menu, press the **RIGHT** arrow key four times.

The **Options** menu allows you to configure auto synchronization and fixed output options for the MPEG over IP and ASI outputs.

The Options menu has the following structure:

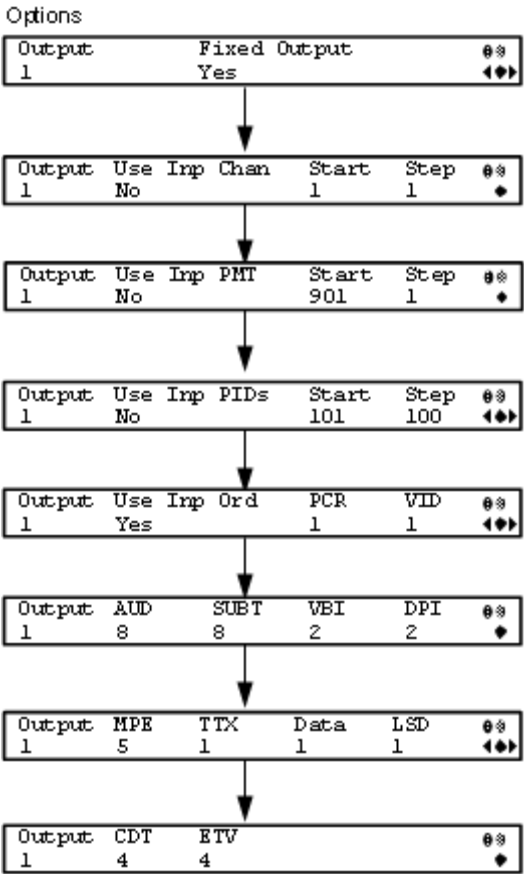

TS Output Options

Menu Item	Description	Parameters
Output	Select 1 to configure the ASI output or select 2 to configure the MPEG over IP output.	1 or 2
Fixed Output	Sets whether the DPM assigns new values for all the output channels and PIDs according to the options below when you Resynchronize All.	Yes or No

Chapter 4 Front Panel Operation

Menu Item	Description	Parameters
Use Inp Chan/PMT/PIDs	Set to Yes to use the input channel numbers, PMT PID numbers, and/or ES PID numbers. Otherwise, set to No to use the Start channel and channel Step assigned below.	Yes or No
Start	First PE channel to use if the Use Inp Chan/PMT/PIDs is set to No .	1 to 65535 for Use Inp Chan 1 to 8192 for Use Inp PMT/PIDs
Step	Offset of the subsequent PE channel, PE PMT PID, or first ES PID of subsequent channel numbers.	1 to 65535 for Use Inp Chan 1 to 8192 for Use Inp PMT/PIDs
Use Inp Ord	Set to Yes to assign the ES PID according to the incoming PMT order. Otherwise, set to No to use reserved PIDs defined below.	Yes or No
PCR, VID, AUD, SUBT, VBI, DPL, MPE, TTX, Data, LSD, CDT, ETV	Set the number of PIDs for the specified streams in one channel.	1 to 64

Setup Menu: CA

To view the CA menu from the Main menu, press the **RIGHT** arrow key once and then the **SELECT** key to reach the Setup menu. Then press the **RIGHT** arrow key six times and the **SELECT** key to view the CA menu.

The CA menu provides information about the ISE, the status of the ADP transmission, and allows you to set the BISS mode and session words available from your service provider. The CA menu has the following structure:

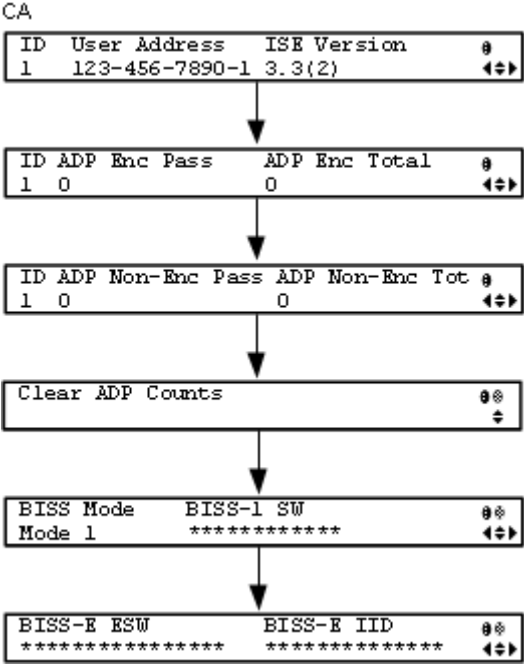

Menu Item	Description	Parameters
ID	Select the ISE to configure.	1 to 8
User Address	Indicates the ISE User Address.	11 digit address in the following format: ###-###-####-#
ISE Version	Indicates the ISE version number.	7 characters
ADP Enc Pass	Indicates the number of encrypted Addressable Data Packets successfully processed. Ideally, the ADP Enc Pass and ADP Enc Total numbers should be identical.	

Chapter 4 Front Panel Operation

Menu Item	Description	Parameters
ADP Enc Total	Indicates the total number of encrypted Addressable Data Packets received. Ideally, the ADP Enc Pass and ADP Enc Total numbers should be identical.	
ADP Non-Enc Pass	Indicates the number of non-encrypted Addressable Data Packets successfully processed. Ideally, the ADP Non-Enc Pass and ADP Non-Enc Total numbers should be identical.	
ADP Non-Enc Total	Indicates the total number of non-encrypted Addressable Data Packets received. Ideally, the ADP Non-Enc Pass and ADP Non-Enc Total numbers should be identical.	
Clear ADP Counts	Select to clear the Addressable Data Packet counters: ADP Enc Pass, ADP Enc Total, ADP Non- Enc Pass and ADP Non-Enc Total. These values are also reset whenever the receiver is turned on, reset or power-cycled.	
BISS Mode	Sets the Basic Interoperable Scrambling System (BISS) mode for the receiver. All channels assigned to a PE identified as BISS CA-controlled in the PMT will be decrypted.	Mode 1 or Mode E
BISS-1 SW	If BISS Mode is Mode 1, enter the session word.	12-character password. Once entered, it cannot be viewed and it is only displayed as asterisks (*). Contact your program provider for the session word.
BISS-E ESW	If BISS Mode is Mode E, enter the encrypted session word.	16-character password. Once entered, it cannot be viewed and it is only displayed as asterisks (*). Contact your program provider for the session word.

Menu Item	Description	Parameters
BISS-E IID	If BISS Mode is Mode E, enter the injected ID.	14-character password. Once entered, it cannot be viewed and it is only displayed as asterisks (*). Contact your program provider for the session word.

Setup Menu: Alarm/Warning

To view the Alarm/Warning menu from the Main menu, press the **RIGHT** arrow key once and then the **SELECT** key to reach the Setup menu. Then press the **RIGHT** arrow key seven times and the **SELECT** key to view the Alarm/Warning menu.

The Alarm/Warning menu allows you to browse the active alarms and warnings, and set whether the output will be disabled in the event of an alarm. This menu has the following structure:

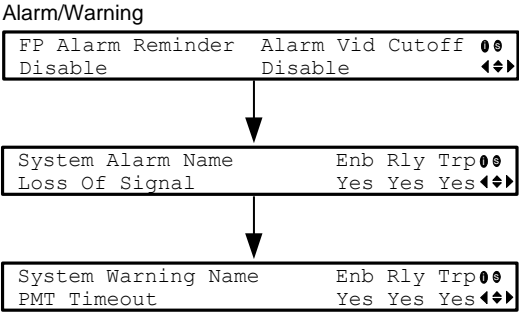

Menu Item	Description	Parameters
FP Alarm Reminder	Select whether to display alarms and warnings on the front panel. The alarm indicator will intermittently flash in the lower line, if enabled.	Enable or Disable

Chapter 4 Front Panel Operation

Menu Item	Description	Parameters
Alarm Vid Cutoff	Select whether the video output is cut off if any enabled alarm is active on the receiver. When video is cut off, there will be no horizontal or vertical synchronization on the output. This is useful for downstream redundancy switching by detecting a loss of video signal. Note: This function also exists under Setup: Services: Video.	Enable or Disable The default is Disable.
System Alarm/Warning Name	Displays the alarm or warning to configure.	
Enb	Select whether the current alarm is enabled or disabled. If the alarm is disabled, the Rly and Trp settings are ignored	Yes or No
Rly	If the current alarm or warning is enabled (Enb is set to Yes), select whether it will trigger the rear panel relay when the alarm is set or cleared.	Yes or No Note: No is a read only value that indicates the setting is Yes, but is currently being suppressed because the alarm or warning is disabled (Enb is set to No).
Trp	If the current alarm or warning is enabled (Enb is set to Yes), select whether it will send SNMP trap messages when the alarm is set or cleared.	Yes or No Note: No is a read only value that indicates the setting is Yes, but is currently being suppressed because the alarm or warning is disabled (Enb is set to No).

Setup Menu: Noise Cutoffs

To view the Noise Cutoffs menu from the Main menu, press the **RIGHT** Arrow key once and then the **SELECT** key to reach the Setup menu. Then press the **RIGHT** arrow key eight times and the **SELECT** key to view the Noise Cutoffs menu.

The Noise Cutoffs menu allows you to set the muting thresholds for both audio and video in the event of a noisy signal. This menu has the following structure:

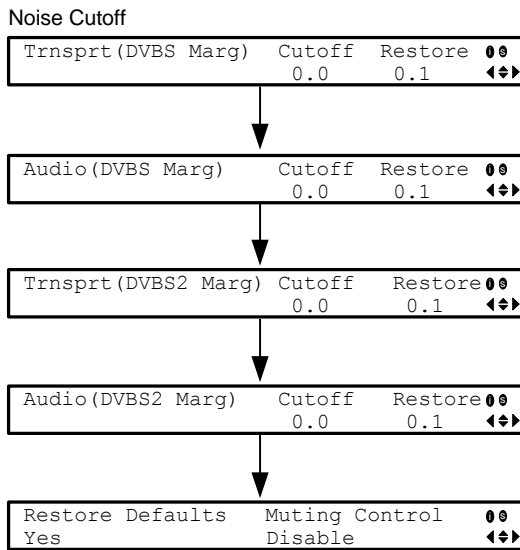

Menu Item	Description	Parameters
Trnsprt(DVBS Marg) Cutoff Trnsprt(DVBS2 Marg) Cutoff	Sets the DVB-S and DVB-S2 Carrier to Noise margins, in dB, below the transport outputs that will be muted. The receiver uses these thresholds to determine when to mute the transport in the event of a noisy signal, poor, or loss of signal condition.	-30.0 to 30.0 This setting must be below the respective Restore value. The default is 0.0. Note: Muting Control must be set to Enable for these settings to be active.
Trnsprt(DVBS Marg) Restore Trnsprt(DVBS2 Marg) Restore	Sets the DVB-S and DVB-S2 Carrier to Noise margins, in dB, above the transport outputs that will be muted. The receiver uses these thresholds to determine when to restore the transport after it has been muted.	-30.0 to 30.0 This setting must be above the respective Cutoff value. The default is 0.1. Note: Muting Control must be set to Enable for these settings to be active.

Chapter 4 Front Panel Operation

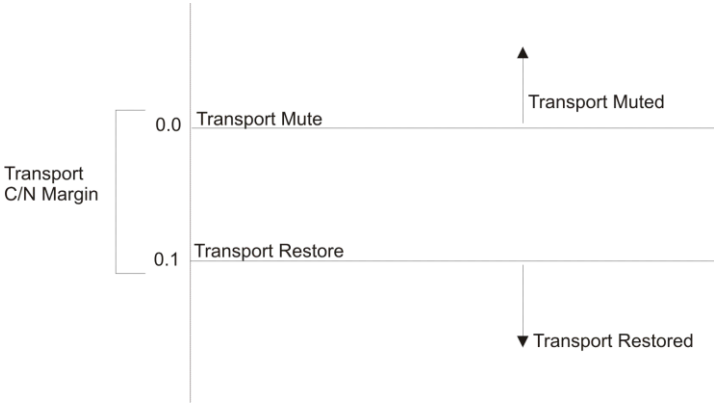
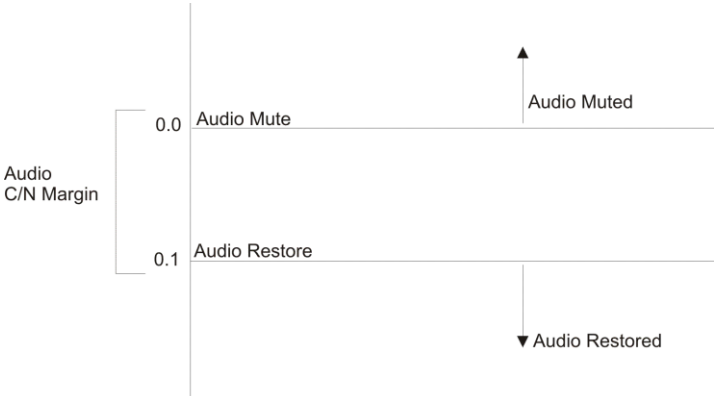
Menu Item	Description	Parameters
	<p>The following displays the Transport Default C/N Margin Relationship</p> 	
<p>Audio(DVBS Marg) Cutoff Audio(DVBS2 Marg) Cutoff</p>	<p>Sets the DVB-S and DVB-S2 Carrier to Noise margins, in dB, below the audio outputs that will be muted.</p> <p>The receiver uses these thresholds to determine when to mute the audio in the event of a noisy, poor, or loss of signal condition.</p>	<p>-30.0 to 30.0</p> <p>This setting must be below the respective Restore value.</p> <p>The default is 0.0.</p> <p>Note: Muting Control must be set to Enable for these settings to be active.</p>
<p>Audio(DVBS Marg) Restore Audio(DVBS2 Marg) Restore</p>	<p>Sets the DVB-S and DVB-S2 Carrier to Noise margins, in dB, above the audio outputs that will be restored.</p> <p>The receiver uses these thresholds to determine when to restore the audio after it has been muted.</p>	<p>-30.0 to 30.0</p> <p>This setting must be below the respective Cutoff value.</p> <p>The default is 0.1.</p> <p>Note: Muting Control must be set to Enable for these settings to be active.</p>
	<p>The following displays the Audio Default C/N Margin Relationship</p> 	

Menu Item	Description	Parameters
Restore Defaults	Select to restore the default muting thresholds.	
Muting Control	Select whether to enable or disable muting cutoffs. If disabled, all the other settings are ignored.	Enable or Disable. The default is Enable.

Setup Menu: DR

To view the DR (Disaster Recovery) menu from the Main menu, press the **RIGHT** arrow key once and then the **SELECT** key to reach the Setup menu. Then press the **LEFT** arrow key once and the **SELECT** key to view the DR menu.

The DR menu allows you to set up the disaster recovery parameters. For more information on disaster recovery, see *Disaster Recovery* (on page 6).

Each parameter is described below. The menu has the following structure:

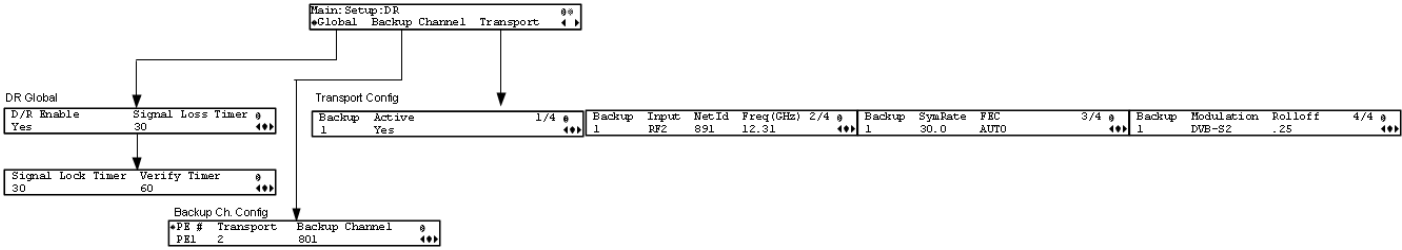

Global

Menu Item	Description	Parameters
D/R Enable	<p>Choose to enable or temporarily disable the disaster recover feature. Choose Yes (default) to enable disaster recovery. Choose No to set the disaster recovery into maintenance mode. It will automatically set the Disaster Recovery back to Yes after five minutes. This prevents the user from accidentally disabling disaster recovery permanently. To disable disaster recovery, remove all of the disaster recovery configurations (Backup Channel and Backup Transport settings).</p> <p>The maintenance mode allows you to perform any maintenance operations (such as IP setup), without the unit declaring disaster and initiating a disaster recovery search path.</p> <p>Note: Although the default is set to Yes, the disaster recovery is not operational until the search path is configured.</p>	Yes or No
Signal Loss Timer	Select the time, in seconds, the unit must wait (after detecting a signal loss) before declaring a disaster. The default is 120 seconds.	5 to 2160000 seconds
Signal Lock Timer	Select the time, in seconds, the unit must wait for a signal lock before declaring that the signal is not usable and move on to the next search location in the search path. The default is 30 seconds.	5 to 255 seconds
Verify Timer	Select the time, in seconds, the unit must wait for the PAT table to verify the signal has a valid transport. The default is 60 seconds.	10 to 255 seconds

Backup Channel

Menu Item	Description	Parameters
PE #	The Program Entry (PE) number you are configuring the backup transport channel. The transcoder supports eight program entries (PE1 to PE8). PE1 is the decode channel and is available at the analog outputs. PE2 to PE8 are available for the transcoded channels on the ASI and MPEG over IP outputs.	PE1 to PE8
Transport	The backup transport number you are configuring the backup channel.	1, 2, or 3
Backup Channel	The backup channel number for the selected backup transport.	-

Note: We recommend that you configure a minimum of one backup transport. If no backup transport is configured, an alarm is triggered, but the unit will not be able to switch to a backup transport.

Backup Transport

Menu Item	Description	Parameters
Backup	The backup number	1, 2, or 3
Active	Indicates whether the selected backup is enabled. To activate a backup, press the ADV key and press SELECT to insert. The Active menu for the selected backup number changes from No to Yes. Press APPLY to save the changes. To disable a backup, press the ADV key and press the RIGHT arrow once and press SELECT to select Delete. Press the RIGHT arrow once and press SELECT to select Continue. The Active menu for the selected backup number changes from Yes to No.	Yes or No
Input, NetId, Freq (GHz), SymRate, FEC, Backup, Modulation, Rolloff	For information on the tuning parameters, see <i>RF1, RF2, RF3, RF4 (RFx) Input</i> (on page 63). Note: The RF input must be configured to match the bandwidth of the backup parameters.	-

About Menu

To view the About menu from the Main menu press the **RIGHT** arrow key two times and then the **SELECT** key.

The About menu provides basic hardware information that is useful when requesting customer support from Cisco.

Each parameter is described below. The About menu has the following structure:

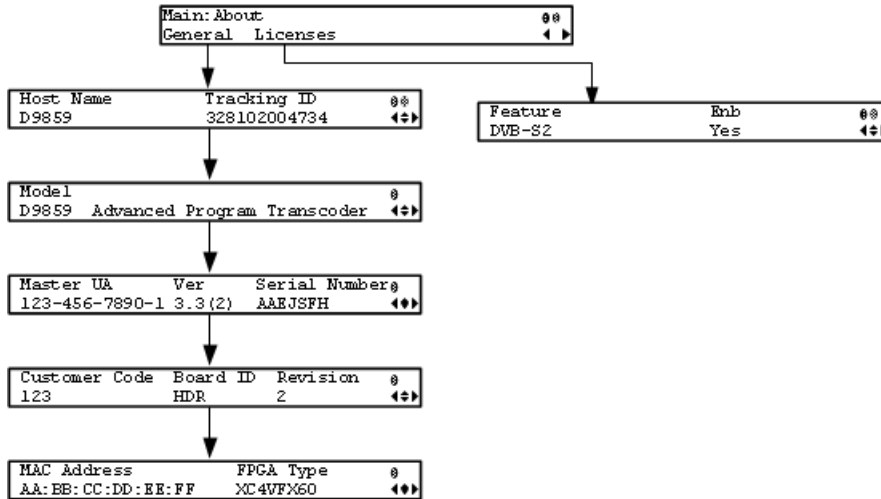

General

Menu Item	Description
Host Name	Sets the host name of the current unit. It is a user configurable name that appears on the Web Interface title to identify the transcoder.
Tracking ID	Displays the unique Tracking ID number that identifies the product version. This is read-only.
Model	Indicates the model number and name of the transcoder. This is read-only.
Master UA	Indicates the Master User Address (UA), which is required to request program authorization from the uplink. This is read-only.
Ver	Indicates the version number of the ISE.
Serial Number	Indicates the unique device serial number.
Customer Code	Indicates the unique Customer Code assigned to an organization by Cisco.
Board ID	Indicates the hardware board design identification.
Revision	Indicates the revision number of the board design.
MAC Address	Indicates the MAC address of the Control Port Ethernet interface.

Menu Item	Description
FPGA Type	Indicates the FPGA type and number information.

Licenses

Menu Item	Description	Parameters
Feature	Displays HD Transcode License Count or SD Transcode License Count	N/A
Enb	<p>HD Transcode License Count - Displays the number of program entries that can perform both SD and HD transcode.</p> <p>SD Transcode License Count - Displays the number of program entries that can perform SD transcode only.</p> <p>For example, a fully licensed D9859 transcoder, with additional 6 SD and 7 HD upgrades, is displayed as 8 for the HD Transcode License Count feature and 0 for the SD Transcode License Count feature.</p>	0 to 8

Versions Menu

To view the Versions menu from the Main menu, press the **RIGHT** arrow key three times and then the **SELECT** key.

The Versions menu provides basic software information that is useful when requesting customer support from Cisco.

The menu has the following structure:

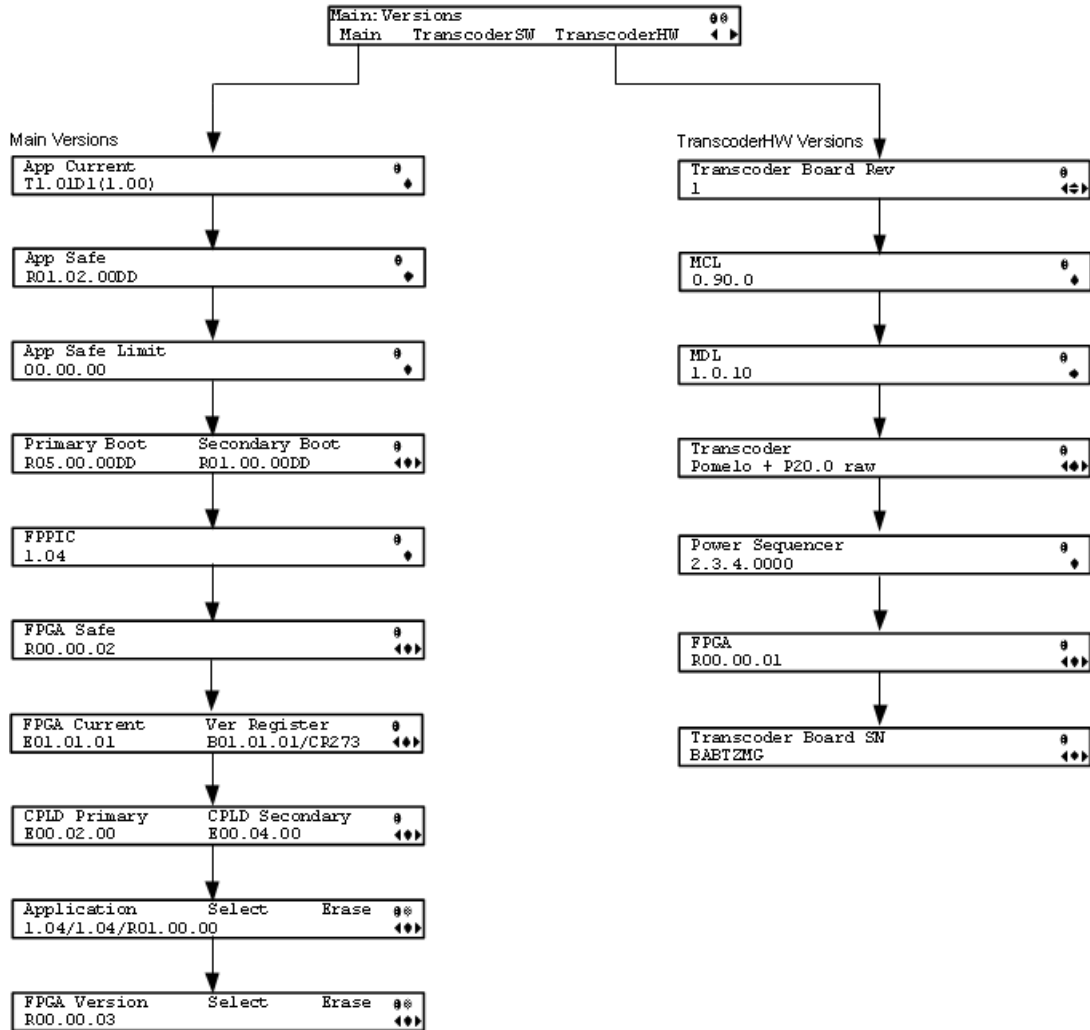

Main Versions

The following are the version numbers applicable to the Main printed circuit board.

Menu Item	Description
App Current	Indicates the version of the current application.

Menu Item	Description
App Safe	Indicates the version of the factory loaded safe application.
App Safe Limit	Indicates the version of the oldest application that can be installed on the current unit. If this value is zero, the oldest application limit is the App Safe version. If this is greater than zero, the shown value or older and the App Safe version is the limit. Older applications will not be installed.
Primary Boot/Secondary Boot	Indicates the versions of the primary and secondary processors' boot code.
FPPIC	Indicates the version of the front panel PIC microcontroller.
FPGA Safe	Indicates the version of the factory loaded safe Field Programmable Gate Array (FPGA) code.
FPGA Current	Indicates the version of the current Field Programmable Gate Array (FPGA) code.
Ver Register	Indicates the version of FPGA code read from the FPGA.
CPLD Primary, CPLD Secondary	Indicates the versions of the current primary and secondary Complex Programmable Logic Device (CPLD).
Application, Select, Erase	<p>Application - Select between all versions of the application loaded on the current unit.</p> <p>Select - Select and then scroll to Yes to reboot the unit and load the selected application. You will be prompted to continue or abort this operation.</p> <p>Note: Selecting an application will cause the unit to reboot and interrupt service.</p> <p>Erase - Select to erase the selected application. You will be prompted continue or abort this operation. You cannot erase the safe application or the current application. While an application is being erased, the busy indicator will appear. You cannot erase another application until it is complete.</p>

Chapter 4 Front Panel Operation

Menu Item	Description
FPGA Version, Select, Erase	<p>FPGA Version - Select between all versions of the FPGA code loaded on the current unit.</p> <p>Select - Select and then scroll to Yes to reboot the unit and load the selected FPGA code. You will be prompted to continue or abort this operation.</p> <p>Note: Selecting an FPGA code will cause the unit to reboot and interrupt service.</p> <p>Erase - Select to erase the selected FPGA code. You will be prompted continue or abort this operation. You cannot erase the safe FPGA code or the current FPGA code. While an FPGA code is being erased, the busy indicator will appear. You cannot erase another FPGA code until it is complete.</p>

Transcoder Software Versions

The TranscoderSW version parameters list all the software packages used for the D9859 transcoder. For more information on the software versions, contact Cisco customer support.

Transcoder Hardware Versions

The following are the version numbers applicable to the Transcoder printed circuit board.

Menu Item	Description
Transcoder Board Rev	Displays the Printed Circuit Board (PCB) revision of the transcoder board.
MCL	Indicates the hardware initialization version number for the transcoder devices on the transcoder board.
MDL	Displays the software version number that provides software access to the transcoder devices.
Transcoder	Displays the version of the firmware performing the transcode.
Power Sequencer	Indicates the firmware version running on the power-sequencer, a chip that controls power-up and power-down of multiple power supplies.
FPGA	Indicates the Field Programmable Gate Array (FPGA) version number.
Transcoder Board SN	Indicates the serial number that is uniquely assigned to the transcoder board.

Diagnostics Menu

To view the Diagnostics menus from the Main menu, press the **RIGHT** arrow key four times and then the **SELECT** key.

For instructions on how to select and store settings, see *About the Front Panel* (on page 34).

The Diagnostics menu has the following structure:

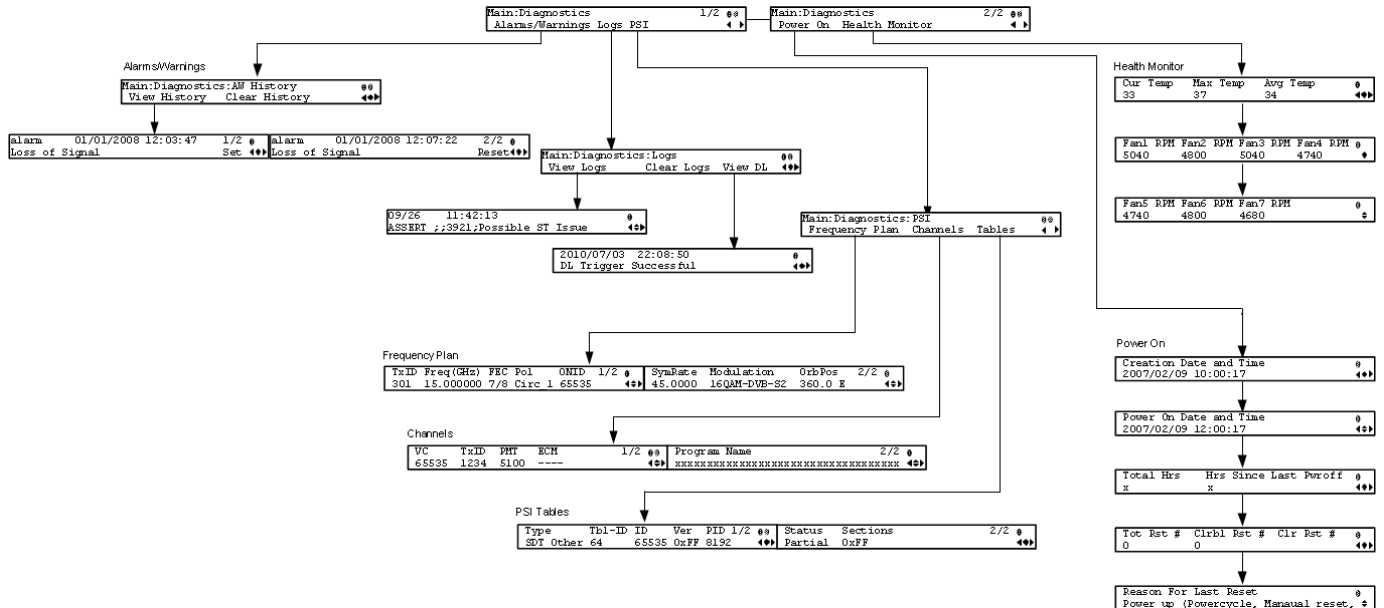

Alarms/Warnings

Menu Item	Description
View History	Select to view the system event messages. Press the UP and DOWN arrow keys to scroll through the list of alarms and warnings. Press the LEFT and RIGHT arrow keys to view the set and reset times. Press the INFO key to view the detailed message.
Clear History	Select to clear any existing history information.

Logs

Menu Item	Description
View Logs	Select to view the system log messages. Press the UP and DOWN arrow keys to scroll through the list of log messages. Press the INFO key and then UP and DOWN arrow keys to view the complete message text.

Chapter 4 Front Panel Operation

Menu Item	Description
Clear Logs	Select to clear any existing log history information.
View DL	Select to view the system download history messages. Press the UP and DOWN arrow keys to scroll through the list of downloaded messages. Press the INFO key and then UP and DOWN arrow keys to view the complete message text.

PSI - Frequency Plan

This is the Frequency Plan sub-menu. You cannot make any changes here, but you can view the available frequency plans stored in the receiver. Press the **UP** and **DOWN** arrow keys to scroll through the list of available transports.

Menu Item	Description	Parameters
TxID	Transport ID	
Freq(GHz)	Downlink Frequency (GHz)	0.0 to 15.0 GHz
FEC	Forward Error Correction inner code rate	1/2, 3/5, 2/3, 3/4, 4/5, 5/6, 7/8, 8/9, or 9/10
Pol	Polarity of the received signal (H, V, or Off)	Horiz (Horizontal), Vert (Vertical), Circ_l (Left Circular), or Circ_r (Right Circular).
ONID	Original Network ID	
SymRate	Symbol Rate, in Mbps	
Modulation	Modulation of the signal	QPSK DVB-S, QPSK DVB-S2, 8PSK DVB-S2 or 16QAM DVB-S2
OrbPos	Orbital Position of the satellite (in degrees)	East or West

PSI - Channels

This is the Virtual Channel sub-menu. You cannot make any changes here, but you can view the available channels and their settings. Press the **UP** and **DOWN** arrow keys to scroll through the list of channels.

Menu Item	Description
VC	Virtual channel number.
TxID	Identification number of the transport on which the channel is available. For more information on the transport streams, see <i>PSI - Frequency Plan</i> (on page 130).

Diagnostics Menu

PMT	PID of the channel's Program Map Table. It is displayed as --- if unavailable.
EMC	PID of the channel's Entitlement Control Message stream. It is displayed as --- if unavailable or not scrambled.
Program Name	Name of the channel.

PSI - Tables

This is the Tables received sub-menu. You cannot make any changes here, but you can view the PSI tables received and their settings. Press the UP and DOWN arrow keys to scroll through the list of tables.

Menu Item	Description	Parameters
Type	The MPEG table acronym.	PAT, CAT, PMT, TSMT, NIT, NIT Other, SDT, SDT Other, BAT, AEIT P/F, OEIT P/F, TDT, RST, ST, TOT, DIT, SIT, ECM Odd, ECM Even, EMM, MPE, DPI, DRT, CDT, MCT, MIT, MAT, ECT, or Invalid Table ID
Tbl-ID	Unique Table ID.	
ID	MPEG/DVB Table ID.	
Ver	Table Version number.	
PID	Value of the PID on which the table is present.	
Status	Reception status of the table.	None, Partial, Full, Update, Timeout, or Lost
Sections	Number of sections in the table.	

Power On

Menu Item	Description
Creation Date and Time	Displays the date and time the current unit was manufactured.
Power On Date and Time	Displays the date and time the current unit was last powered up, in relation to the current local time.
Total Hrs	Displays the total number of hours the current unit has been running since being manufactured.

Chapter 4 Front Panel Operation

Menu Item	Description
Hrs Since Last Pwroff	Displays the number of hours the current unit has been running since the last power up.
Tot Rst #,	Displays the total number of times the current unit has been reset since it was manufactured.
Clrbl Rst #	Displays the number of times the unit has been reset since the clearable reset counter was last cleared.
Clr Rst #	Select this option to clear/reset the Clrbl Rst # counter to 0.
Reason For Last Reset	Displays the reason for the last reset.

Health Monitor

Menu Item	Description	Parameters
Cur Temp, Max Temp, Avg Temp	Displays the current (Cur Temp), maximum (Max Temp) and the average (Avg Temp) operating temperature.	Degrees Celsius
Fan1 to Fan7 RPM	Displays the fan speed for the internal fans.	RPM

5

Web GUI Setup and Monitoring

Introduction

This chapter describes how to set up the D9859 Advanced Receiver Transcoder using the web GUI.

In This Chapter

- Logging On to the Web GUI.....134
- D9859 Summary Overview135
- D9859 Menus138
- D9859 Web GUI Environment140
- Setting up Input Information141
- Setting up Audio and Video Information.....168
- Configuring Transport Stream Information.....182
- Configuring System Settings218
- Viewing Support Information252

Logging On to the Web GUI

- 1 Open a web browser.
- 2 Type the IP address of the D9859 Advanced Receiver Transcoder in the Address bar and press **Enter**.



- 3 In the **Username** and **Password** fields, enter the username and password.

Note: The username and password are case-sensitive. The default username is **admin** and the default password is **localadmin**. If you have forgotten your username and password, you can reset them from the front panel menu of the D9859 Advanced Receiver Transcoder. For more information, see *Resetting the Login Credentials* (on page 32).

Important: The password and username will be remembered for the whole of the web session. Close the web browser if you want to prevent others from accessing the settings of the D9859 Advanced Receiver Transcoder.

If your session expires, you must refresh the browser and log back in.

- 4 Click **Log in**.

Note: If you check the **Remember username** check box, the user name will be remembered the next time you log into the web GUI.

D9859 Summary Overview

To access an overview of the main D9859 Advanced Receiver Transcoder settings:

From the user interface of the D9859, choose **Summary > Summary Dashboard**. The Summary Dashboard page is displayed.

The screenshot displays the D9859 Summary Dashboard interface. The main content area is titled "Summary Dashboard" and contains several sections:

- Decoded Program Status:** A table showing program elements (PE1-PE6) with columns for PE Index, Channel, Channel Name, Condition, Channel Encrypted, and Channel Scrambled.
- Audio Status:** A table showing audio streams with columns for Audio, PID, Lan..., Format, Bit Rate, SFR, Buffer, DDP Mode, and Dualmono Mode.
- Current Input Status:** A table showing input parameters such as Downlink Frequency, I/Q, L band Frequency, and Signal Status.
- Video Status:** A panel showing video-related information like Video, Bit Rate, 3:2 Pulldown, FPS, Primary Out, and Composite.
- Channel Status:** A panel showing channel information for PE1-PE6.
- PID Information:** A panel showing PID information for PE1-PE6.

Annotations in the image include:

- Arrows pointing to "Refresh Module", "Minimize/Maximize Module", and "Close Module" buttons for the Decoded Program Status table.
- An arrow pointing to the "Shortcuts - click to open the specific setup pages" text at the bottom left.
- An arrow pointing to the "Displays the number alarms, warnings, and clear messages." text at the bottom right.

The Summary Dashboard page displays an overview of the main D9859 Advanced Receiver Transcoder settings.

Shortcuts

The shortcuts below the modules in the Summary Dashboard page are shortcuts to the various setup pages. For example, click **Video Setup** to open the Video Setup page.

Modules

You can customize the Summary Dashboard by temporarily minimizing or removing the modules displayed. Each module has a maximize and minimize button, allowing you to view or hide various modules. The default view is displayed when you refresh the Summary Dashboard page.

You can also customize the Dashboard by clicking **Add/Remove Module**. The Dashboard Configuration window is displayed.

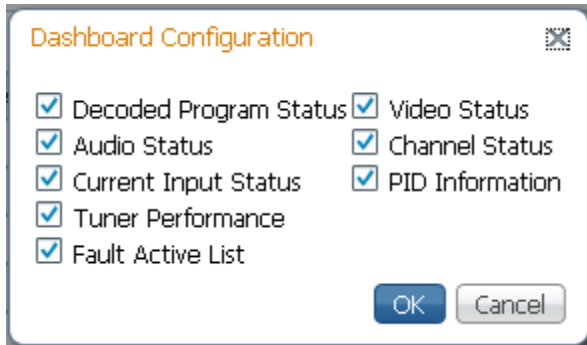

The following table describes all the available modules:

Module	Description
Decoded Program Status	Displays channel and service information.
Audio Status	Displays the current audio status information, such as the audio format and sampling frequency.
Current Input Status	Displays the current RF Tuning Status information, including the downlink frequency and signal status.
Tuner Performance	Displays the satellite dish status, such as the C/N Margin and Signal Level.
Video Status	Displays the current video information.
Channel Status	Displays the channel status information, such as the type of CA used and whether the receiver is authorized to receive the signal.
PID Information	Displays the PIDs associated with the channels.
Fault Active List	Displays the currently active alarms and warnings.

Alarms/Warnings

The bottom right corner of the **Summary Dashboard** page displays the total number of active alarms, active warnings, and clear messages. Clear messages is calculated as follows: total number of alarms + total number of warnings - total number of active alarms - total number of active warnings.

To view a detailed list of alarms and warnings, click the **Alarms** or **Warnings** link and a pop-up window is displayed with a list of all the active alarms or active warnings. The following is an example:

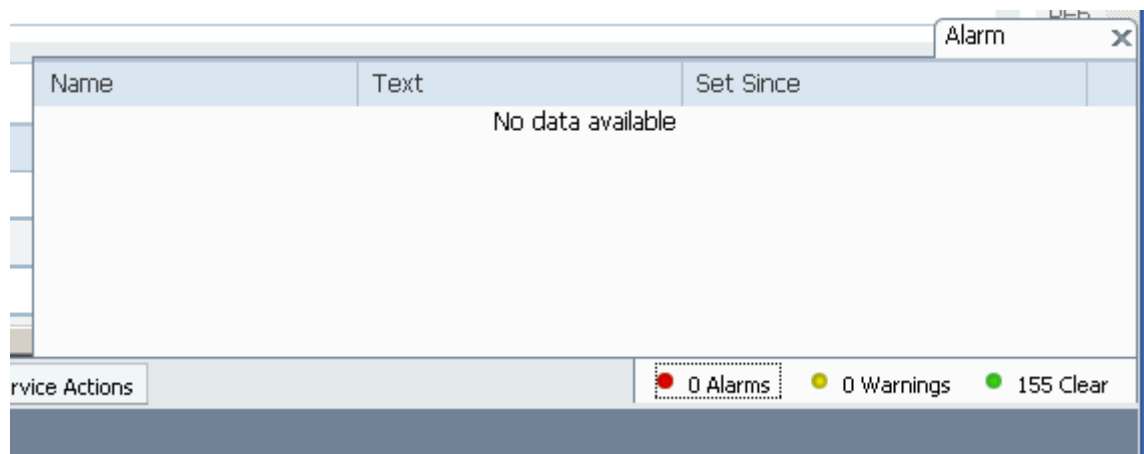

Click on an alarm or warning to open the **Status** page for more information. For more information on the **Status** page, see *Viewing the Alarm/Warning Status* (on page 231).

D9859 Menus

The web GUI of the D9859 has menus at the top of the page.



The functions for the menus are as follows:

- Summary

From this menu, you can obtain an overview of the D9859 operation.

- Input

From this menu, you can:

- set up RF and ASI inputs,
- configure muting thresholds,
- view input status,
- configure disaster recovery settings,
- configure channels,
- configure CI (Common Interface) settings,
- view PSI, Frequency, and Channel tables.

- Audio & Video

From this menu, you can:

- configure video settings,
- set up closed caption and subtitles,
- configure audio settings,
- view current audio status,
- set the cueing parameters.

- Transport Stream

From this menu, you can:

- configure ASI and MPEGoIP outputs,
- configure transcoder settings.

- System Settings

From this menu, you can:

- view alarm and warning status information

- configure ethernet ports,
- set date and time formats,
- configure lock levels.

■ Support

From this menu, you can:

- view logs,
- view contact information,
- view and upgrade software version.

D9859 Web GUI Environment

The following is an example of a D9859 Web GUI page:

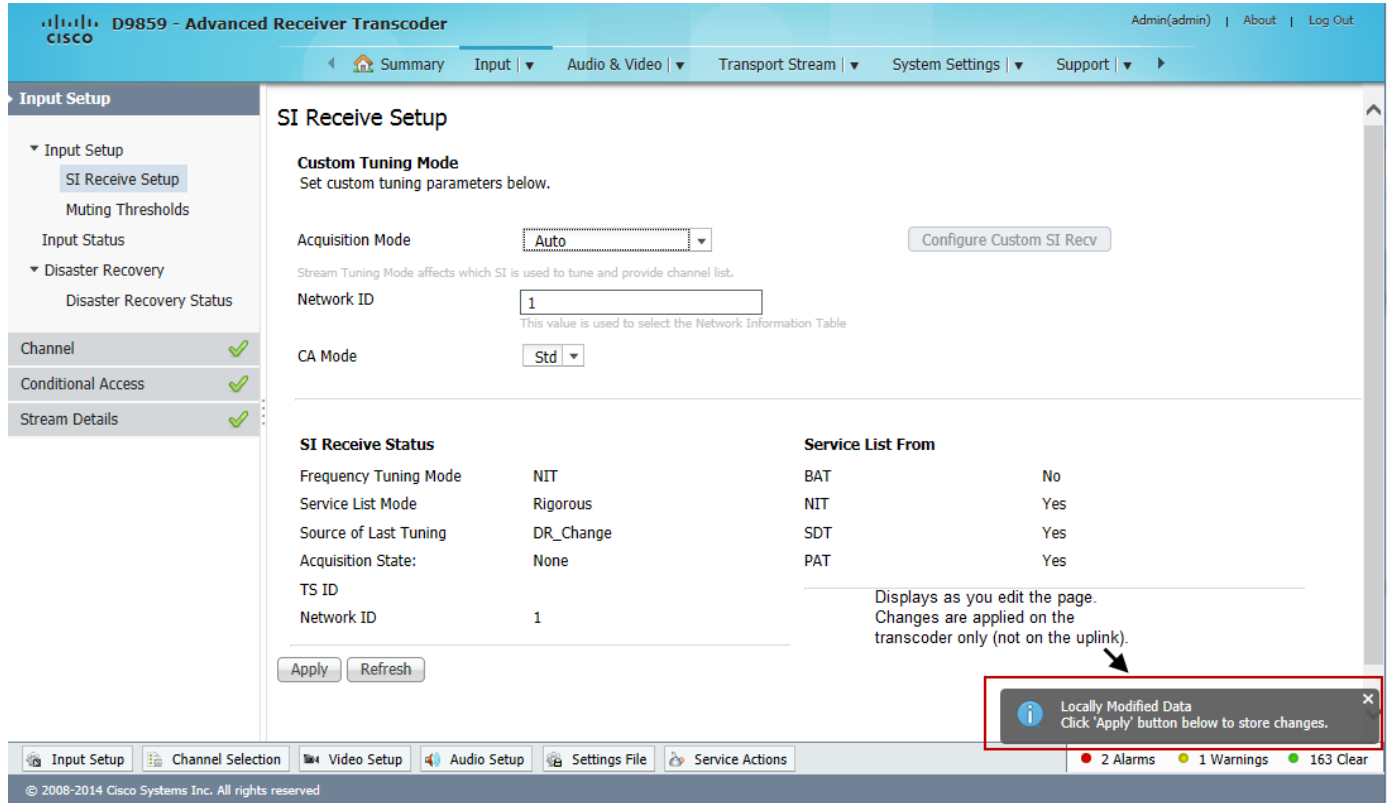

Window Buttons

The GUI of the D9859 has the following general buttons:

Button	Description
Apply	Saves and applies the settings to the transcoder.
Refresh	Reads existing data from the D9859. If edits were made in a setup page, then unsaved changes are discarded.
Reset Defaults	Discards any changes made and sets data to default values.
Clear Counters	Resets counters on the displayed page.

Setting up Input Information

Setting up the RF Input

- 1 From the user interface of the D9859, choose **Input > Input Setup**. The Input Setup page is displayed.

Input Setup

RF ASI

RF Input Selection

Use RF Input

Input Selection:

Use RF 1

Use RF 2

Use RF 3

Use RF 4

Tuning

Downlink Frequency: (GHz)

Symbol Rate: (MS/s)

FEC:

Modulation:

Roll Off:

I/Q:

RF 1 22 KHz:

RF1 Power:

RF Input LNB Configuration

Input	LO1 (Ghz)	LO2 (Ghz)	Crossover (Ghz)	Polarisation	Orbital Posn	East/West Flag
RF1	10.75	0.0	0.0	Horizontal	0.0	N/A
RF2	5.15	0.0	0.0	Horizontal	0.0	N/A
RF3	5.15	0.0	0.0	Horizontal	0.0	N/A
RF4	5.15	0.0	0.0	Horizontal	0.0	N/A

Current Input Status

Downlink Frequency (GHz)	12.31	I/Q	Normal
L band Frequency (MHz)	1560.0	Signal Status	Lock+Sig
Symbol Rate (MS/s)	30.0	FEC	9/10
TS ID	201	Input	RF1
Modulation Type	8PSK DVB-S2	Pilots	No
Acquisition State	Full	Orbital Validation Status	None
		Orbital Validation Date	1901/01/01 00:00:00

Apply Refresh Validate Orbital Position Reacquire

© 2008-2013 Cisco Systems Inc. All rights reserved

- 2 In the **RF Input Selection** area, check the **Use RF Input** check box to activate an RF input. You can select RF 1 to RF 4 below.
- 3 Choose **UserCfg** from the **Input Selection** to lock to the RF input set by the user. Choose **SW Map** to use the orbital position settings to select the RF input. We recommend that you validate the orbital position for **SW Map** option.
- 4 Click the **Use RF 1**, **Use RF 2**, **Use RF 3**, or **Use RF 4** radio button to activate an RF input.

- 5 In the **Tuning** area, enter the current operating downlink frequency used by the transcoder for tuning the received digital signal in the **Downlink Frequency** field. You can enter a value in the range from 0.0 to 15.0 GHz.
- 6 In the **Symbol Rate** field, enter the symbol rate that matches the transmitted signal. You can enter a value in the range from 1.0 to 45.0 Ms/s for DVB-S, 1.0 to 30.0 for DVB-S2 if Pilot Present is set to Yes on the Front Panel, or 5.0 to 30.0 for DVB-S2 if Pilot Present is set to No on the Front Panel.
- 7 From the **FEC** drop-down list, choose the Forward Error Correction inner code rate. The FEC rate must match the FEC of the transmitted signal. You can select 1/2, 2/3, 3/4, 5/6, 7/8, or Auto.
- 8 From the **Modulation** drop-down list, choose the modulation type for the received signal (DVB-S or DVB-S2).
- 9 From the **Roll Off** drop-down list, choose the roll-off factor of the incoming signal (.20, .25, .35). Set the value to .20 or .35 when DVB-S modulation is used, and either of the three when DVB-S2 is used. Use a small number to reject or filter carriers close to the same frequency.
- 10 From the **IQ** drop-down list, choose the input signal spectrum inversion setting, which allows the operator to track and select inverted and non-inverted digital signals. This is normally used to automatically reject or filter out unwanted signals.

When set to Auto, signal is tracked and inverted for correct selection, as required. When set to Opposite, the signal is always inverted. Conversely, when set to Normal, the signal is not inverted.

- 11 The **RF1 22KHz** is only applicable for dual band applications. Select whether to transmit the 22 kHz tone Local Oscillator control signal of RF1. The selections are On, Off, or Auto. Select Auto to use the crossover frequency to determine if the tone is transmitted.
- 12 From the **RF1 Power** drop-down list, choose the power output of RF1 to the external Low Noise Block (LNB).
You can set the RF1 Power to Off, 13V, 18V, V-NIT or H-NIT. When RF1 Power is set to V-NIT or H-NIT, it will use vertical and horizontal polarity until it is automatically read from the NIT.
Note: Power will not be applied to the LNB when set to **Off**.
- 13 In the **RF Input LNB Configuration** area, for RF1, RF2, RF3, and/or RF4, set the lower local oscillator frequency, in GHz, of the LNB in the **LO1 (Ghz)** column. If it is a single band oscillator, set its frequency, in GHz. You can enter a value in a range from 0.0 to 15.0 GHz. This value must be lower than the value for LO2.
- 14 For RF1, RF2, RF3, and/or RF4, set the higher oscillator frequency, in GHz, of the LNB in the **LO1 (Ghx)** and **LO2 (Ghz)** columns. If it is a single band oscillator, set this value to 0.0. You can enter a value in a range from 0.0 to 15.0 GHz. This value must be higher than the value for LO1. In single-band LNB applications, set this value to 0.0.

- 15 In the **Crossover** field, enter the crossover frequency for RF1, RF2, RF3, and/or RF4. This is an internal threshold frequency used for selecting the LO1 or LO2 frequency, depending on the current downlink frequency settings. This option is only used in dual-band LNB applications.

You can enter a value in a range from 0.0 to 15.0 GHz. In single-band LNB applications, set this value to 0.0.

- 16 From the **Polarisation** drop-down list, choose the signal polarisation setting (Horizontal, Vertical, or Automatic). This setting is only applicable when the LNB Power is set to H-NIT or V-NIT. It marks the polarity of the signal connected to the current RF input.

- 17 In the **Orbital Posn** field, enter the orbital position for RF1, RF2, RF3, and/or RF4, in degrees. This is the location in orbit of the satellite currently being used. The satellite position (in degrees) in combination with the direction (either E (East) or W (West)) denotes the satellite position the dish connected to the current RF Input should point. This is used when the satellite is not available in the look-up menu list.

For manual configuration, enter the location of the satellite using the numerical keypad. The receiver will not recognize the satellite name and identify it as Unknown. This setting is required to resolve any ambiguity between RF inputs during automatic disaster recovery.

- 18 From the **East/West Flag** drop-down list, choose the east/west flag for RF1, RF2, RF3, or RF4. This is the satellite position the dish connected to the current RF Input should point. The options are East, West, or N/A (Not Applicable).

- 19 Click **Apply**.

If a disaster recovery is in progress, a message is displayed, recommending that you do not apply the setup changes during a disaster recovery.

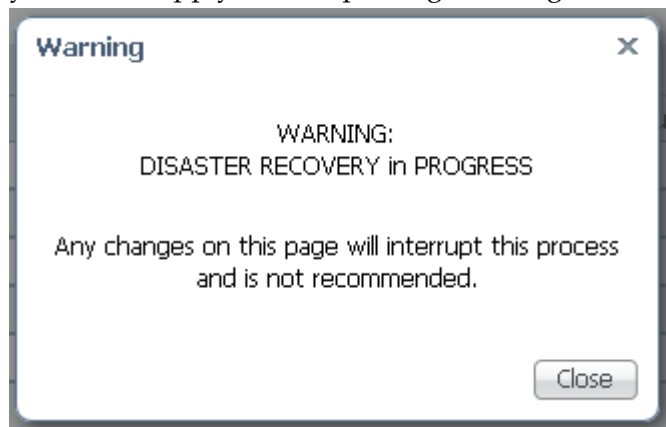

Click **Close**. If you want to save your changes during a disaster recovery, click **Apply** again. The warning message is displayed again. Click **OK** to confirm your changes. The changes are saved.

Validating the Orbital Position

Click **Validate Orbital Position** to validate the RF inputs to match those expected by the network. The receiver will check to see if all frequencies in the Network Information Table (NIT) can be tuned to. The Date is displayed as the last date that the Validate operation was performed.

Reacquiring the Network Information

Click **Reacquire** to re-acquire the signal using the tuning parameters from user settings. The Reacquire Network Information window is displayed.

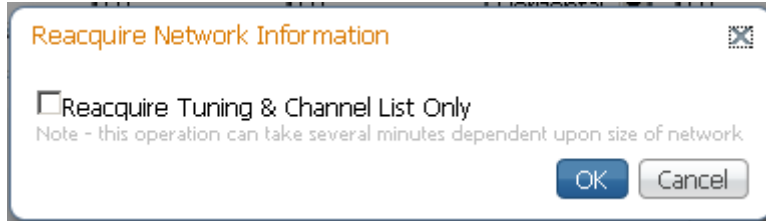

Select **Reacquire Tuning & Channel List Only** for the decoder to tune back to the user configured input and frequency and re-acquire the PSI/SI information back to the selected channel. Click **OK**.

Note: This operation can take several minutes, depending on the size of the network.

Viewing the Current Input Status

The **Current Input Status** section displays the current RF status.

RF Tuning Status			
Frequency (GHz)	12.31	Signal Status	No Lock
L band Freq. (MHz)	1560.0	AFC (MHz)	0.0
Symbol Rate (MS/s)	30.0	Acquisition State	Full
FEC Rate	N/A	Orbital Validation Status	None
		Orbital Validation Date	1901/01/01 00:00:00

The following table describes the Current Input Status information displayed:

Parameter	Description
Downlink Frequency (GHz)	The current downlink frequency, in GHz.
L band Frequency (MHz)	The current L-Band frequency, in MHz.
Symbol Rate (Msym)	Symbol rate of the received signal, in Msymbols/second.
FEC	The FEC (Forward Error Correction) rate of the received signal (N/A, 1/2, 3/5, 2/3, 3/4, 4/5, 5/6, 7/8, 8/9 or 9/10).
Modulation Type	The modulation type for the received signal (N/A, QPSK, 8PSK, DVB-S or DVB-S2).

Setting up Input Information

Parameter	Description
Pilots	Indicates whether a Pilot is present for the received signal. The Pilot is set on the modulator for input signal synchronization purposes.
I/Q	The IQ (Input Signal Inversion) for the received signal (Inv or NonInv).
Signal Status	Indicates whether the input signal is locked. <ul style="list-style-type: none"> ■ Locked - Indicates the transcoder is locked to a carrier with no valid content. ■ Lock+Sig - Indicates the transcoder is locked to a carrier with valid content. ■ No Lock - Indicates the transcoder is not locked to a carrier.
TS ID	The Transport ID (in the range from 1 to 65535).
Input	The active input port receiving the signal (RF1, RF2, RF3, RF4, or ASI).
Acquisition State	Displays Full if the ASI and PSI tables have all been found. Otherwise, it will display Degraded if there are missing tables or None if no ASI or PSI tables have been found.
Orbital Validation	Displays the last date that the Validate Orbital Position operation was performed.

Setting up the ASI Input

- 1 From the user interface of the D9859, choose **Input > Input Setup**. The Input Setup page is displayed.
- 2 Click **ASI**.

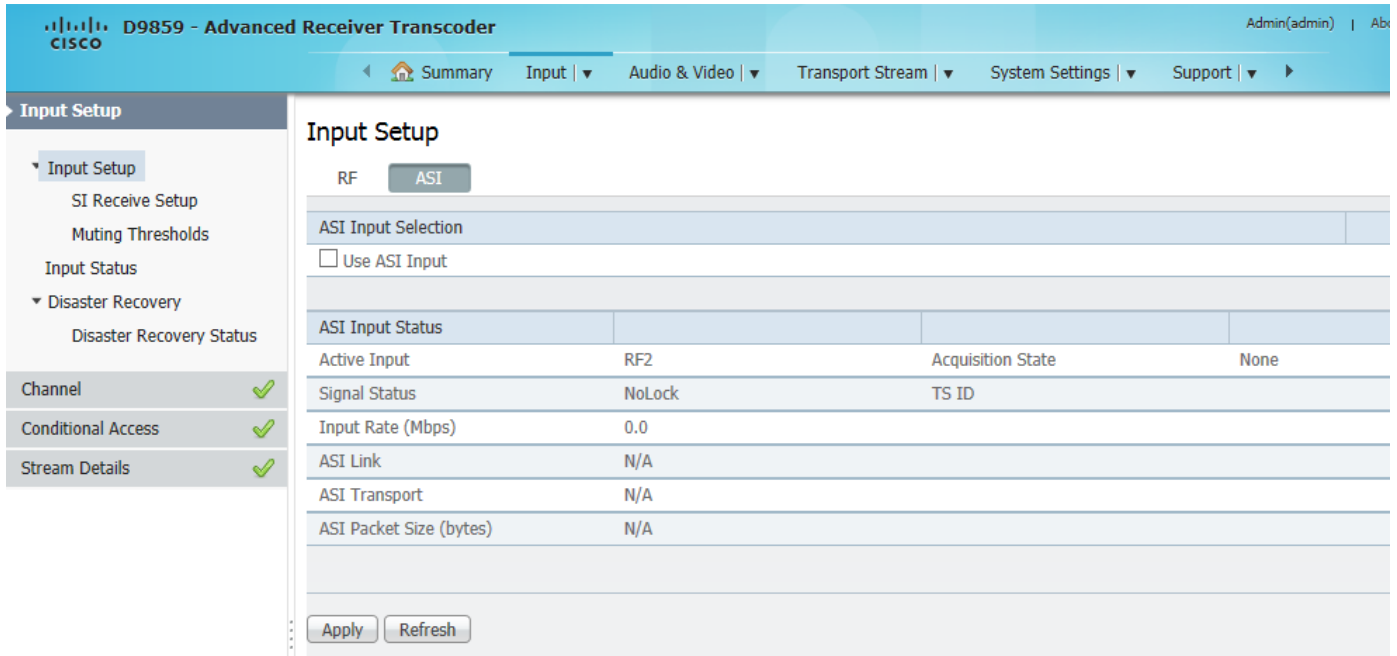

- 3 Check the **Use ASI Input** check box to tune to the ASI input.
Note: Setting a new input to be active will deactivate the currently active input.
- 4 Click **Apply**.

Viewing the ASI Input Status

The **ASI Input Status** table displays the current ASI status. The following table describes the ASI Input Status information displayed:

Parameter	Description
Active Input	Indicates the currently selected input source (RF1, RF2, RF3, RF4, or ASI).
Signal Status	Indicates whether the input signal is locked. <ul style="list-style-type: none"> ■ Locked - Indicates the transcoder is locked to a carrier with no valid content. ■ Lock+Sig - Indicates the transcoder is locked to a carrier with valid content. ■ No Lock - Indicates the transcoder is not locked to a carrier.
Input Rate (Mbps)	Displays the bit rate of the input transport stream, in Mbps.

Setting up Input Information

Parameter	Description
ASI Link	Indicates whether there is a transport stream link error (Error, Ok, or N/A).
ASI Transport	Indicates the current transport synchronization status (Error, Ok, or N/A).
ASI Packet Size (bytes)	Indicates the packet size (in bytes) for the ASI input (188, 204, or N/A).
Acquisition State	Displays Full if the ASI and PSI tables have all been found. Otherwise, it will display Degraded if there are missing tables or None if no ASI or PSI tables have been found.
TS ID	The Transport ID (in the range from 1 to 65535).

Setting up SI Receive Parameters

- 1 From the user interface of the D9859, choose **Input > SI Receive Setup**. The SI Receive Setup page is displayed.

The screenshot shows the Cisco D9859 Advanced Receiver Transcoder web interface. The top navigation bar includes 'Summary', 'Input', 'Audio & Video', 'Transport Stream', 'System Settings', and 'Support'. The left sidebar shows 'Input Setup' with sub-items: 'SI Receive Setup' (selected), 'Muting Thresholds', 'Input Status', and 'Disaster Recovery' (with 'Disaster Recovery Status' sub-item). Below these are 'Channel', 'Conditional Access', and 'Stream Details', each with a green checkmark.

The main content area is titled 'SI Receive Setup'. Under 'Custom Tuning Mode', it says 'Set custom tuning parameters below.' The configuration includes:

- Acquisition Mode:** A dropdown menu set to 'Auto'.
- Network ID:** A text input field containing '1'.
- CA Mode:** A dropdown menu set to 'Std'.

 A 'Configure Custom SI Recv' button is located to the right of the Acquisition Mode dropdown. A note below the Network ID field states: 'Stream Tuning Mode affects which SI is used to tune and provide channel list. This value is used to select the Network Information Table'.

Below the configuration fields is a table with two sections: 'SI Receive Status' and 'Service List From'.

SI Receive Status		Service List From	
Frequency Tuning Mode	NIT	BAT	No
Service List Mode	Rigorous	NIT	Yes
Source of Last Tuning	DR_Change	SDT	Yes
Acquisition State:	None	PAT	Yes
TS ID			
Network ID	1		

At the bottom of the page are 'Apply' and 'Refresh' buttons.

- 2 In the **Custom Tuning Mode** area, from the **Acquisition Mode** drop-down list, choose the tables required for the service list creation and signal acquisition. The selections are **Auto**, **Basic**, or **Custom**. The default is **Basic**. If you choose **Basic**, it requires NIT to be present. If you choose **Auto**, it uses all the available service list tables and it will acquire if any table is present.

If you choose **Custom**, click **Configure Custom SI Recv** and the Configure Custom SI Recv window opens.

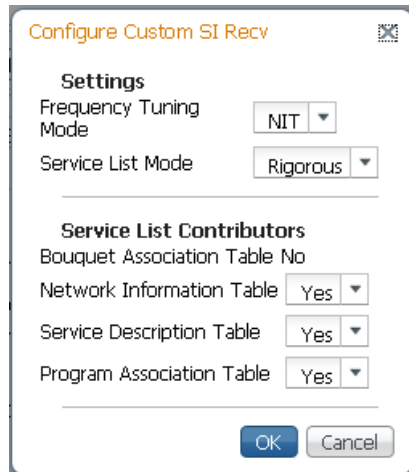

- 3 From the **Frequency Tuning Mode** drop-down list, choose the frequency tuning mode that determines whether to use the NIT to tune to other transports, or to force the tuning to user configuration settings. Select **NIT** and the receiver can change tuning parameters to use all transports available in the NIT. Select **User Cfg** to force the receiver to use the user selected tuning parameters.
- 4 The **Service List mode** determines which tables are required for tuning. **Rigorous** requires all service list tables to be present to acquire the signal. **Degraded** requires any service list table to be present to acquire the signal.
- 5 From the **Bouquet Association Table** drop-down list, choose **Yes** to use the NIT when creating the service list. If set to **No**, it is view-only. It is not supported in the current release.
- 6 From the **Network Information Table** (NIT) drop-down list, choose **Yes** to use the NIT when creating the service list.
- 7 From the **Service Description Table** (SDT) drop-down list, choose **Yes** to use the SDT when creating the service list.
- 8 From the **Program Association Table** (PAT) drop-down list, choose **Yes** to use the PAT when creating the service list.
- 9 Click **OK**.
- 10 Enter the **Network ID** of the uplink signal the receiver is to receive when using the selected preset. The transcoder's network ID must match the network ID associated with the transmitted signal that identifies the NIT to be used. You can enter a value in the range from 1 to 65535. The default is 1.
- 11 From the **CA Mode** drop-down list, choose which programs can be viewed via the transcoder. Choose **Std** (standard) for PowerVu signal or **Open** conditional access for free-to-air (that is, in-the-clear signals). The default is **Std**.
- 12 Click **Apply**.

If a disaster recovery is in progress, a message is displayed, recommending that you do not apply the setup changes during a disaster recovery.



Click **Close**. If you want to save your changes during a disaster recovery, click **Apply** again. The warning message is displayed again. Click **OK** to confirm your changes. The changes are saved.

The **SI Receive Status** area displays all the current SI Receive settings. It also displays the source of last tuning and the last Preset Number activated. The **Service List From** area displays the current settings of the allowed services (BAT, NIT, SDT, PAT).

Setting up Muting Threshold Controls

- 1 From the user interface of the D9859, choose **Input > Muting Thresholds**. The Muting Thresholds page is displayed.

The screenshot shows the Cisco D9859 Advanced Receiver Transcoder web interface. The top navigation bar includes 'Summary', 'Input', 'Audio & Video', 'Transport Stream', 'System Settings', and 'Support'. The left sidebar shows 'Input Setup' with sub-items: 'SI Receive Setup', 'Muting Thresholds', 'Input Status', and 'Disaster Recovery'. The main content area is titled 'Muting Thresholds' and features a table with the following data:

Parameters	DVB-S C/N Margin (dB)	RF Modulation DVB-S2 C/N Margin (dB)
Transport Mute	0.0	0.0
Transport Restore	0.1	0.1
Audio Mute	0.0	0.0
Audio Restore	0.1	0.1

Below the table are buttons for 'Apply', 'Refresh', and 'Reset Defaults'. A checkbox labeled 'Enable Threshold Muting' is checked.

- 2 Check the **Enable Threshold Muting** check box to mute the transport stream and audio in the event of an unstable, poor, or loss of signal condition. The default is selected.
- 3 The **Transport Mute** field for both **DVB-S C/N Margin (dB)** and **DVB-S2 C/N Margin (dB)** sets the DVB-S and DVB-S2 Carrier to Noise margins, in dB, below the transport outputs that will be muted. The receiver uses these thresholds to determine when to mute the transport in the event of a noisy, poor, or loss of signal condition. The adjustable operating range is from -30.0 to 30.0 dB. This setting must be below the respective Restore value. The default setting is 0.0.
Note: The **Enable Threshold Muting** check box must be checked for these settings to be active.
- 4 The **Transport Restore** field for both **DVB-S C/N Margin (dB)** and **DVB-S2 C/N Margin (dB)** sets the DVB-S and DVB-S2 Carrier to Noise margins, in dB, above the transport outputs that will be muted. The receiver uses these thresholds to determine when to restore the transport after it has been muted. The adjustable operating range is from -30.0 to 30.0 dB. This setting must be above the respective Mute value. The default setting is 0.1.
Note: The **Enable Threshold Muting** check box must be checked for these settings to be active.

The following displays the Transport Default C/N Margin Relationship:

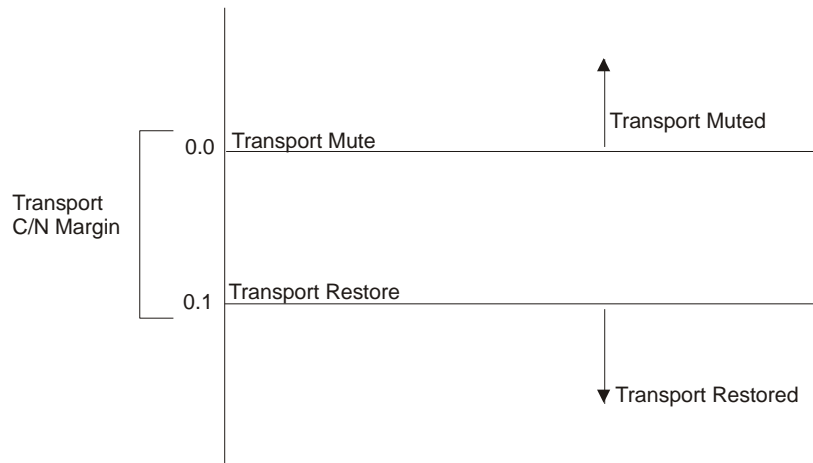

- 5 The **Audio Mute** field for both **DVB-S C/N Margin (dB)** and **DVB-S2 C/N Margin (dB)** sets the DVB-S and DVB-S2 Carrier to Noise margins, in dB, below the audio outputs that will be muted. The receiver uses these thresholds to determine when to mute the audio in the event of a noisy, poor, or loss of signal condition. The adjustable operating range is -30.0 to 30.0 dB. This setting must be below the respective Restore value. The default setting is 0.0.

Note: The **Enable Threshold Muting** check box must be selected for these settings to be active.

- 6 The **Audio Restore** field for both DVB-S C/N Margin (dB) and DVB-S2 C/N Margin (dB) sets the DVB-S and DVB-S2 Carrier to Noise margins, in dB, above the audio outputs that will be restored. The receiver uses these thresholds to determine when to restore the audio after it has been muted. The adjustable operating range is from -30.0 to 30.0 dB. This setting must be below the respective Mute value. The default setting is 0.1.

Note: The **Enable Threshold Muting** check box must be selected for these settings to be active.

The following displays the Audio Default C/N Margin Relationship:

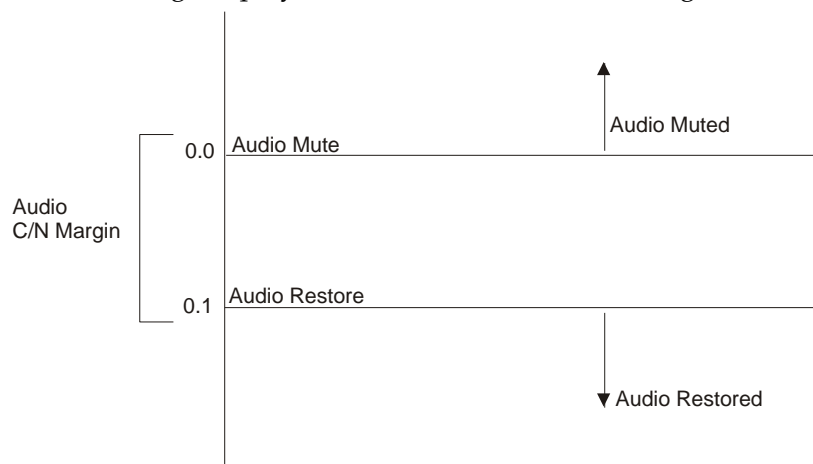

- 7 Click **Apply**.

Viewing the Input Status

From the user interface of the D9859, choose **Input > Input Status**. The Input Status page is displayed.

The screenshot shows the Cisco D9859 Advanced Receiver Transcoder web interface. The top navigation bar includes links for Summary, Input, Audio & Video, Transport Stream, System Settings, and Support. The left sidebar shows the 'Input Setup' menu with options for Input Setup, SI Receive Setup, Muting Thresholds, Input Status (selected), Disaster Recovery, and Disaster Recovery Status. Below the sidebar are status indicators for Channel, Conditional Access, and Stream Details, all marked with green checkmarks.

Input Status

Downlink Frequency (GHz)	12.25	I/Q	Opposite
L band Frequency (MHz)	1500.0	Signal Status	No Lock
Symbol Rate (MS/s)	28.3465	FEC	N/A
TS ID		Input	RF3
Modulation Type	QPSK DVB-S	Pilots	N/A
Acquisition State	None	Orbital Validation Status	None
Tune Reason	DR	Orbital Validation Date	1901/01/01 00:00:00

Tuner Performance

C/N Margin (dB) dB

Signal Level (dBm) <-70 dBm

RF Lock	NoLock	PV BER	
AFC (MHz)	-0.2	RF(1) Power	Off
LDPC ER	n/a	LNB Status	N/A
Packet ER	n/a		

Net ID	1	Network Name	
Input Rate (Mbps)	0.0	Scrambling Mode	Unk

The **Current Input Status** area displays the same information shown in the **Input Setup** page. For more information on the parameters displayed, see *Setting up the RF Input* (on page 141).

The **Tuner Performance** area displays the satellite dish information, such as the C/N Margin and Signal Level.

Configuring the Disaster Recovery Settings

The disaster recovery settings allow you to configure the search path when a disaster occurs. By default, the disaster recovery feature is enabled. For more information on disaster recovery, see *Disaster Recovery* (on page 6).

- 1 From the user interface of the D9859, choose **Input > Disaster Recovery**. The Disaster Recovery Setup page is displayed.

The screenshot shows the Cisco D9859 Web GUI. The top navigation bar includes 'Summary', 'Input', 'Audio & Video', 'Transport Stream', 'System Settings', and 'Support'. The left sidebar shows 'Input Setup' with sub-items: 'SI Receive Setup', 'Muting Thresholds', 'Input Status', 'Disaster Recovery', and 'Disaster Recovery Status'. The main content area is titled 'Disaster Recovery Setup' and contains the following configuration options:

- Enable Disaster Recovery:
- Signal Lock Period: Seconds
- Signal Loss Period: Seconds
- Signal Verify Period: Seconds

Below these options is a 'Search Path' table with the following data:

	Origin	<input checked="" type="radio"/> Backup 1 (Enabled)	<input type="radio"/> Backup 2 (Enabled)	<input type="radio"/> Backup 3 (Enabled)
PE1		801	630	
PE2		802	650	803
PE3		803	651	802
PE4				
PE5				
PE6	603			
PE7	603			
PE8	603			

At the bottom of the page, there are 'Edit / Enable' and 'Disable' buttons.

- 2 From the **Enable Disaster Recovery** drop-down list, choose to enable or temporarily disable the disaster recovery feature. Choose **Yes** (default) to enable disaster recovery. Choose **No** to set the disaster recovery into maintenance mode. It will automatically set the Disaster Recovery back to **Yes** after five minutes.

This prevents the user from accidentally disabling disaster recovery permanently. To disable disaster recovery, remove all the disaster recovery configurations (Search Path settings below).

The maintenance mode allows you to perform any maintenance operations (such as IP setup), without the unit declaring disaster and initiate a disaster recovery search path.

Note: Although the default is set to **Yes**, the disaster recovery is not operational until the Search Path is configured.

- 3 In the **Signal Lock Period** field, enter the time, in seconds, the unit must wait for a signal lock before declaring that the signal is not usable and move on to the next search location in the search path. You can enter a value in the range from 5 to 255 seconds. The default is 30 seconds.
- 4 In the **Signal Loss Period** field, enter the time, in seconds, the unit must wait (after detecting a signal loss) before declaring a disaster. You can enter a value in the range from 5 to 2160000 seconds. The default is 30 seconds.
- 5 In the **Signal Verify Period** field, enter the time, in seconds, the unit must wait for the PAT table to verify the signal has a valid transport. You can enter a value in the range from 10 to 255 seconds. The default is 60 seconds.
- 6 The **Search Path** area determines the search order of backup transports when a disaster occurs. For a list of triggers, see *Disaster Recovery* (on page 6). During a disaster, the unit will attempt to tune to the backup transport, based on the **Search Path** configured. The table displays the origin and backup channels for PE1 and PE2.

The **Origin** column is automatically updated when the RF Input is enabled and configured. For more information, see *Setting up the RF Input* (on page 141).

Disaster Recovery supports up to three backups. To configure Backup 1, 2, or 3:

- a Click the **Backup 1**, **Backup 2**, or **Backup 3** radio button.
- b Click **Edit/Enable**. A window is displayed, with tuning parameters.

- c For information on the tuning parameters, see *Setting up the RF Input* (on page 141). For information on the **Net ID** field, see *Setting up SI Receive Parameters* (on page 148).

Note: The RF input in the Input Setup page must be configured to match the bandwidth of the backup parameters.

- d Click **OK**.

Chapter 5 Web GUI Setup and Monitoring

- e In the Search Path table, click the field to edit an enabled Backup 1, 2, or 3. The following is an example of editing the enabled Backup 1 channel for PE1:

Search Path				
	Origin	<input checked="" type="radio"/> Backup 1 (Enabled)	<input type="radio"/> Backup 2 (Enabled)	<input type="radio"/> Backup 3 (Disabled)
PE1	101	2		
PE2	0			

Save | Cancel

- f Enter a channel number and click **Save**. Enter 0 to clear the backup channel.

Note: We recommend that you configure a minimum of one backup transport. If no backup transports are configured, the origin channel is used.

The configured backup is enabled. To disable a backup, click the **Backup 1**, **Backup 2**, or **Backup 3** radio button and click **Disable**.

- 7 Click **Apply**.

If a disaster recovery is in progress, a message is displayed, recommending that you do not apply the setup changes during a disaster recovery.

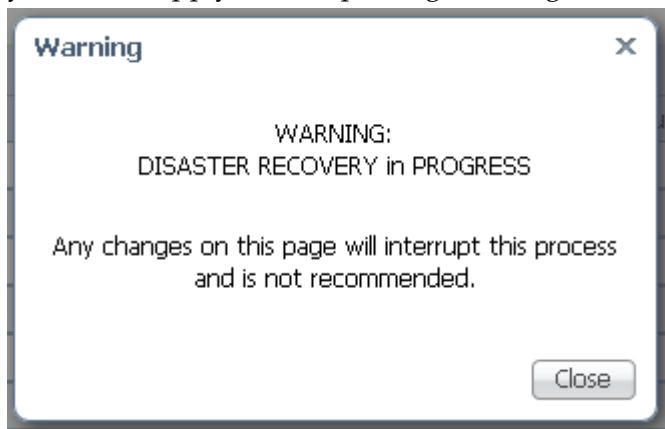

Click **Close**. If you want to save your changes during a disaster recovery, click **Apply** again. The warning message is displayed again. Click **OK** to confirm your changes. The changes are saved.

Viewing the Disaster Recovery Status

From the user interface of the D9859, choose **Input > Disaster Recovery Status**. The Disaster Recovery Status page is displayed.

The screenshot shows the 'Disaster Recovery Status' page in the D9859 web interface. The left sidebar shows the navigation menu with 'Disaster Recovery Status' selected. The main content area is divided into two sections: 'Disaster Recovery Status' and 'Backup Transport'.

Disaster Recovery Status

State	D/R in progress
Signal Lock Timer	5
Signal Loss Timer	10
Verification Timer	10

Backup Transport

	Origin	Backup 1	Backup 2	Backup 3
Input	RF3	RF2	RF3	RF4
Net ID	1	1	1	1
Frequency	12.25	12.31	12.25	12.31
Symbol Rate	28.3465	30.0	28.3465	30.0
Modulation Type	QPSK DVB-S	QPSK DVB-S2	QPSK DVB-S	QPSK DVB-S2
FEC	7/8	AUTO	AUTO	AUTO
Polarization	Vert	Horiz	Horiz	Horiz
Orbital Position	50.0	0.0	0.0	0.0
East/West Flag	West	East	East	N/A
Configured By		User	User	User

Search Path

	Origin	Backup1	Backup2	Backup3
PE1		801	630	
PE2		802	650	803
PE3		803	651	802
PE4				
PE5				
PE6	603			
PE7	603			

The **State** field displays the current disaster recovery status. The three statuses are:

- No Disaster - The unit is in a normal state.
- D/R In Progress - The unit has detected a loss of input and it is searching for a backup transport using the configured search path. The configured search path is displayed in the **Backup Transport** area.
- D/R Disabled - The disaster recovery feature is temporarily disabled. To enable disaster recovery, see *Configuring the Disaster Recovery Settings* (on page 154).

Chapter 5 Web GUI Setup and Monitoring

The **Backup Transport** area displays the tuning parameters of the current origin and backup transports configured. For example, if only Backup 1 and Backup 3 are configured, the table will display the tuning parameters for Origin, Backup 1, and Backup 3. The Configured By row indicates that the backup transport is configured by a user.

The **Search Path** area displays the channel numbers assigned to the Origin and Backup transports for PE1 to PE8.

Setting up the Channel Selections

- 1 From the user interface of the D9859, choose **Input > Channel Selection**. The Channel Selection page is displayed.

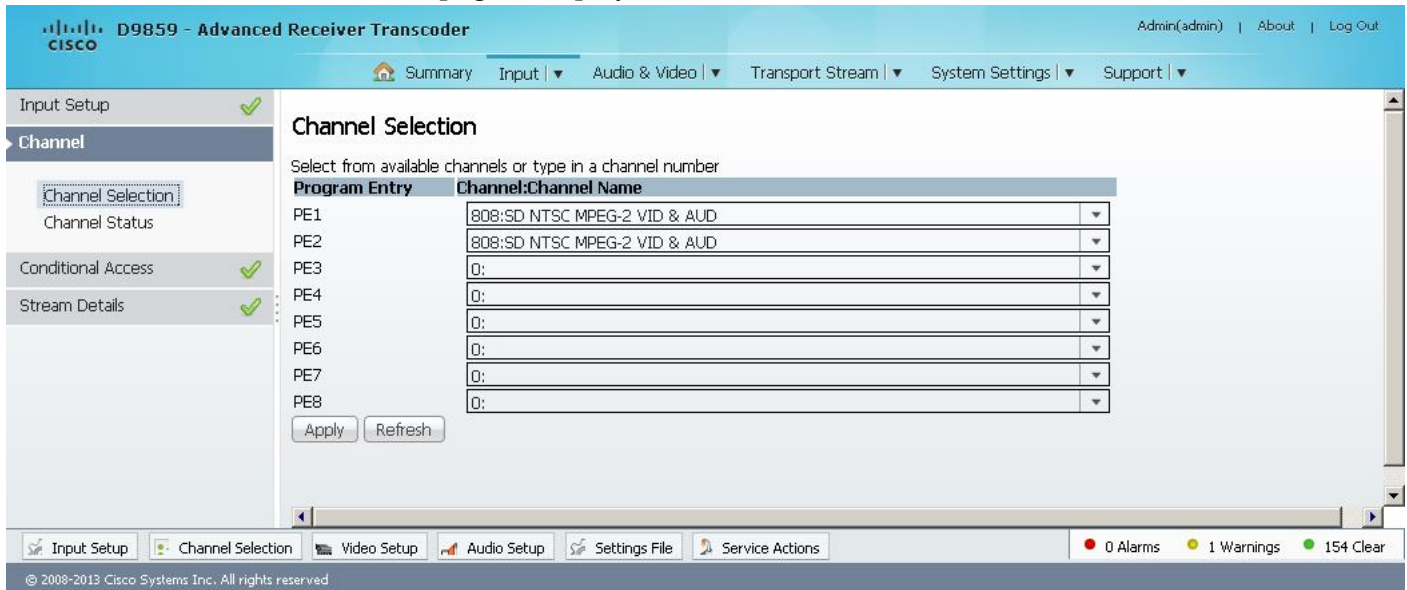

- 2 Enter or select a channel number for up to eight program entries.
- 3 Click **Apply**.

If a disaster recovery is in progress, a message is displayed, recommending that you do not apply the setup changes during a disaster recovery.



Click **Close**. If you want to save your changes during a disaster recovery, click **Apply** again. The warning message is displayed again. Click **OK** to confirm your changes. The changes are saved.

Viewing the Channel Status

From the user interface of the D9859, choose **Input > Channel Status**. The Channel Status page is displayed.

The screenshot shows the Cisco D9859 Advanced Receiver Transcoder web interface. The top navigation bar includes 'Summary', 'Input', 'Audio & Video', 'Transport Stream', 'System Settings', and 'Support'. The left sidebar shows 'Channel Status' selected under the 'Channel' section. The main content area displays the 'Channel Information Service Status' table.

PE Index	Channel	Channel N...	Conditional...	Channel A...	Channel E...	Channel Sc...	SR Status	SR Type	SR Start Ti...	SR End T
PE1	805	MMX2P6 D...	SA	Yes	Yes	Yes	Primary	None	2007/09/0...	2007/09
PE2	3		Unknown	No	No	No	Primary	None	2007/09/0...	2007/09
PE3	1		Unknown	No	No	No	Primary	None	2007/09/0...	2007/09
PE4	1		Unknown	No	No	No	Primary	None	2007/09/0...	2007/09
PE5	1		Unknown	No	No	No	Primary	None	2007/09/0...	2007/09
PE6	3		Unknown	No	No	No	Primary	None	2007/09/0...	2007/09
PE7	3		Unknown	No	No	No	Primary	None	2007/09/0...	2007/09
PE8	3		Unknown	No	No	No	Primary	None	2007/09/0...	2007/09

The following table describes the channel information displayed:

Parameter	Description
PE Index	Indicates the Program Entry number (PE1 to PE8).
Channel	Displays the input channel of the current PE. The channel is displayed in a range from 1 to 65535.
Channel Name	Displays the channel name of the current PE.
Conditional Access System ID	Indicates the type of Conditional Access (CA) system used by the program (SA, BISS, or FTA).
Channel Authorised	Indicates whether the transcoder is authorized to receive the program (Yes or No).
Channel Encrypted	Indicates whether the received program is encrypted (Yes or No).
Channel Scrambled	Indicates whether the received program is scrambled (Yes or No).

Parameter	Description
SR Status	<p>Displays the status of an alternate authorized program/service from the same transport stream when the transcoder is not authorized to view the primary program. This is an uplink initiated function that maps the alternate service to the original (primary) service PIDs, replacing the original service with the alternate service at the digital transport output. No local intervention is required by the transcoder operator for provision of this service replacement feature. The statuses are Not Started, Primary, or Alternate.</p> <p>Not Started - Indicates that an event has not started.</p> <p>Primary - Indicates that a service replacement event is active, but the primary program is being displayed.</p> <p>Alternate - Indicates that a service replacement event is active, and that the transcoder has tuned to and is displaying the alternate program/event as it is not authorized to view the scheduled event.</p>
SR Type	<p>Indicates the type of service replacement event. The types are None, Scheduled, CA, Cue Trigger</p> <p>None - Indicates that no service replacement event is scheduled.</p> <p>Scheduled - Indicates that all transcoders will tune to the alternate program at the scheduled time. This status applies to PE1 to PE8.</p> <p>CA - Indicates that only transcoders unauthorized to view the scheduled program will tune to the alternate program according to the selected authorization tier bits. This status applies to PE1 to PE8.</p> <p>Cue Trigger - Indicates that only transcoders authorized by the Cue Trigger mask will tune to the scheduled program/event.</p> <p>Note: The Cue Trigger service replacement event type is not supported in the current release.</p>
SR Start/End Time	<p>Displays the start/end time of the service replacement event when one is scheduled; otherwise, the default start/end time is displayed. The default start/end time is 2007/09/01 00:00:00.</p>

Viewing the CA Status

From the user interface of the D9859, choose **Input > CA Status**. The CA Status page is displayed.

The screenshot shows the web interface for the D9859 - Advanced Receiver Transcoder. The top navigation bar includes 'Summary', 'Input', 'Audio & Video', 'Transport Stream', 'System Settings', and 'Support'. The left sidebar shows 'Conditional Access' with 'CA Status' selected. The main content area displays the 'CA Status' table with the following data:

Index	ISE User Add...	ISE version N...	Enc Data pkt...	Enc Data pkt...	Non-Enc Dat...	Non-Enc Data pkts recvd
1	000-583-260...	4.1(2)	2640	2640	2640	2640
2	000-583-260...	4.1(2)	2640	2640	2640	2640
3	000-583-260...	4.1(2)	2640	2640	2640	2640
4	000-583-260...	4.1(2)	2640	2640	2640	2640

Buttons for 'Clear Counters' and 'Refresh' are located below the table.

The following describes the columns in the CA Status table:

Status	Description
Index	The ISE number.
ISE User Address	The ISE User Address. It is a 11 digit address in the following format: ###-###-####-#.
ISE Version Number	The ISE version number. It consists of 7 characters.
Enc Data pkts passed	Indicates the number of encrypted Addressable Data Packets successfully processed. Ideally, the ADP Enc Pass and ADP Enc Total numbers should be identical.
Enc Data pkts recvd	Indicates the number of encrypted Addressable Data Packets received. Ideally, the ADP Enc Pass and ADP Enc Total numbers should be identical.
Non-Enc Data pkts passed	Indicates the number of non-encrypted Addressed Data Packets successfully processed. Ideally, the ADP Enc Pass and ADP Enc Total numbers should be identical.
Non-Enc Data pkts recvd	Indicates the total number of non-encrypted Addressable Data Packets received. Ideally, the ADP Non-Enc Pass and ADP Non-Enc Total numbers should be identical.

Setting up the BISS Mode

- 1 From the user interface of the D9859, choose **Input > BISS**. The BISS page is displayed.

The screenshot shows the Cisco D9859 Advanced Receiver Transcoder web interface. The page title is "D9859 - Advanced Receiver Transcoder". The navigation menu includes "Summary", "Input", "Audio & Video", "Transport Stream", "System Settings", and "Support". The left sidebar shows "Conditional Access" with "BISS" selected. The main content area is titled "Biss" and contains three input fields: "BISS Mode" (set to "Mode 1"), "BISS Mode-1 Session Word" (masked with asterisks), and "BISS Mode-E Encrypted Session Word" (masked with asterisks). There is also a "BISS Mode-E Injected ID" field (masked with asterisks) and "Apply" and "Refresh" buttons at the bottom.

- 2 From the **BISS Mode** drop-down list, choose the Basic Interoperable Scrambling System for the transcoder (Mode 1 or Mode E). All channels assigned to the PE identified as BISS CA-controlled in the PMT will be decrypted.
- 3 If you selected BISS Mode 1, enter a fixed 12-character BISS mode session word in the **BISS Mode-1 Session Word** field. Once entered it cannot be viewed and it is only displayed as asterisks (*). Contact your program provider for the session word.
- 4 If you selected BISS Mode E, enter the 16-character BISS Mode-E encrypted session word in the **BISS Mode-E Encrypted Session Word** field and the 14-character BISS Mode-E injected ID in the **BISS Mode-E Injected ID** field. Once entered, neither of these values can be viewed and it is only displayed as asterisks. Contact your program provider for the respective session word and/or injected ID.
- 5 Click **Apply**.

Viewing the PSI Tables

From the user interface of the D9859, choose **Input > PSI Tables**. The PSI Tables page is displayed.

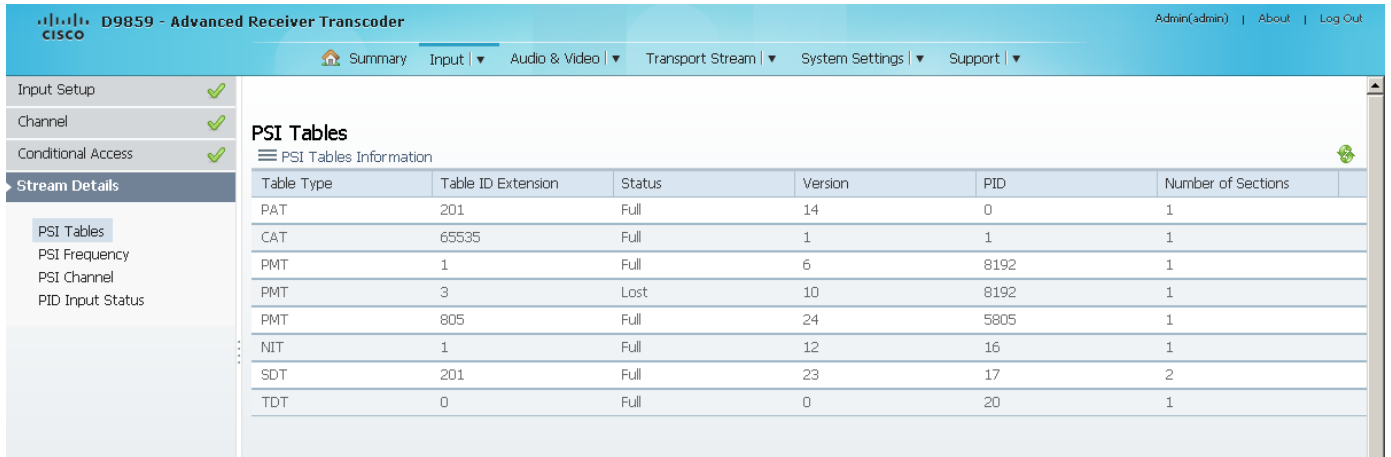

You cannot make any changes in the PSI table and can only view the PSI tables received and their settings. The following is a list of the various columns:

Abbreviation	Description
Table Type	Indicates the MPEG table acronym. PAT, CAT, PMT, TSDT, NIT, NIT Other, SDT, SDT Other, BAT, AEIT P/F, OEIT P/F, TDT, RSI, ST, TOT, DIT, SIT, ECM Odd, ECM Even, EMM, MPE, DPI, DRT, CDT, MCT, MIT, MAT, ECT, or Invalid Table ID
Table ID Extension	Displays the MPEG/DVB Table ID.
Status	Indicates the reception status of the table. None, Partial, Full, Update, Timeout, or Lost
Version	Indicates the table version number.
PID	Indicates the value of the PID on which the table is present.
Number of Sections	Indicates the number of sections in the table.

Viewing PSI Frequency Information

From the user interface of the D9859, choose **Input > PSI Frequency**. The PSI Frequency page is displayed.

The screenshot shows the Cisco D9859 Advanced Receiver Transcoder web interface. The top navigation bar includes 'Summary', 'Input', 'Audio & Video', 'Transport Stream', 'System Settings', and 'Support'. The left sidebar shows 'Stream Details' with 'PSI Frequency' selected. The main content area displays the 'PSI Frequency' page with a table of PSI Frequency Information.

Transport Stre...	Frequency (GHz)	Symbol Rate ...	Orbital Position	Polarization	Flag	FEC	RF Modulation	Network ID
101	12.25	30.8	20.0	Horiz	East	7/8	QPSK DVB-S	1
201	12.31	30.0	60.0	Vert	West	9/10	8PSK DVB-S2	1
301	12.38	30.8	50.0	Vert	West	3/4	QPSK DVB-S	1

You cannot make any changes in the PSI Frequency table and can only view the available frequency plans stored in the transcoder. The following is a list of the various columns:

Abbreviation	Description
Transport Stream ID	Displays the transport ID.
Frequency (GHz)	Displays the downlink frequency, in GHz (0.0 to 15.0 GHz).
Symbol Rate (MSym)	Displays the symbol rate, in Mbps.
Orbital Position	Displays the orbital position of the satellite, in degrees (East of West).
Polarization	Displays the polarity of the received signal (H,V, or Off).
Flag	Displays the satellite position (in degrees), in combination with the direction (East or West).
FEC	Indicates the Forward Error Correction inner code rate (1/2, 3/5, 2/3, 3/4, 4/5, 5/6, 7/8, 8/9, or 9/10).
RF Modulation	Indicates the modulation of the signal (QPSK DVB-S, QPSK DVB-S2, 8PSK DVB-S2 or 16QAM DVB-S2).
Network ID	Displays the original network ID.

Viewing the PSI Channels

From the user interface of the D9859, choose **Input > PSI Channel**. The PSI Channel page is displayed.

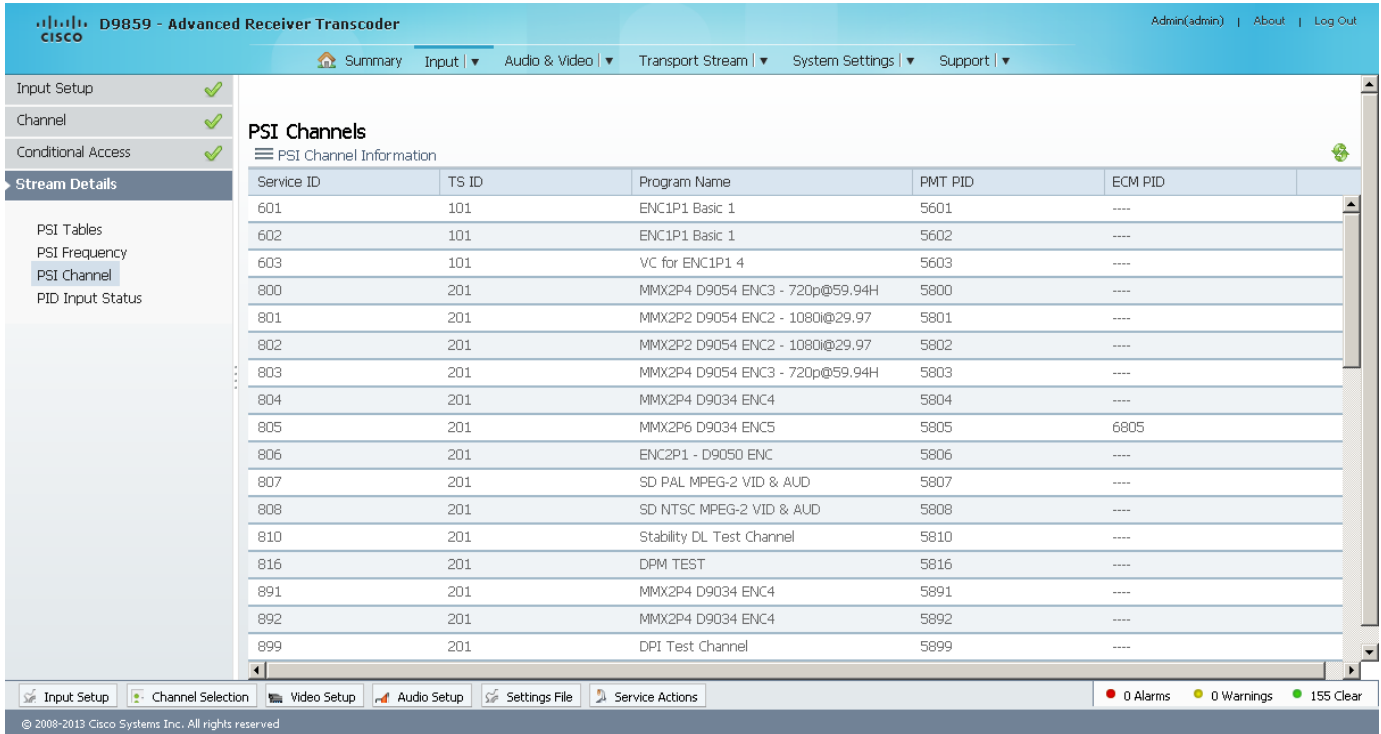

You cannot make any changes in the PSI Channel table and can only view the available channels and their settings. The following is a list of the various columns:

Abbreviation	Description
Service ID	Indicates the virtual channel number.
TS ID	Displays the identification number of the transport on which the channel is available. For more information on the transport streams, see <i>Viewing PSIFrequency Information</i> (on page 165).
Program Name	Indicates the name of the channel.
PMT PID	Indicates the PID of the channel's Program Map Table.
ECM PID	Indicates the PID of the channel's Entitlement Control Message stream.

Viewing the PID Input Status

From the user interface of the D9859, choose **Input > PID Input Status**. The PID Input Status page is displayed.

PE Index	Type	Detail	Language	PID	Present
PE1	PMT	PMT		5805	✓
PE1	ECM1	ECM		6805	✓
PE1	PCR	PCR		2548	✓
PE1	VBI1	SA VBI		206	✓
PE1	SUB1	DVB SUBT	eng	610	✓
PE1	AUD1	ATSC AC3		2510	✓
PE1	AUD2	ATSC AC3		2511	✓
PE1	VID1	H264 VID		2548	✓

You cannot make any changes in the PID Input Status table and can only view the available channels and their settings. The following is a list of the various columns:

Abbreviation	Description
PE Index	Indicates the Program Entry number (PE1 to PE8).
Type	Name assigned to the Program Entry, up to 4 alphanumeric characters.
Detail	Displays any detail associated with the program PID (e.g., MPG2 PID). The parameters are: MPG1 VID, MPG2 VID, 422 VID, H264 VID, HD VID, MPG4 VID, MPG AUD, MPG2 AUD, DVB AC3, DVB DDP, AAC AUD, HEAAC, AUD, MPG4 AUD, DBE AUD, DTS AUD, DVB TXT, DVB VBI, DVB SUBT, DVB ASYN, DVB SYNS, DVB SYND, DVB MPE, DVB DCAR, DVB OCAR, SA VBI, ATSC AC3, ATSC DDP, SA UTLD, SCTE DPI, SA HSD, SA CDDL, SA WBD, SA SUBT, ECM, EMM, PCR, or UNKNOWN.
Language	Displays the language code carried in the PMT for the current PID, if applicable. The supported languages are according to ISO 639-2 Language Codes.
PID	The program PID number, in the range from 1 to 8192.
Present	Indicates whether the PID is present in the incoming stream.

Setting up Audio and Video Information

Setting up the Video Parameters

- 1 From the user interface of the D9859, choose **Audio & Video > Video Decoding**. The Video Setup page is displayed.

Video Setup

Video Setup

Primary Video Output

Standard Definition Output

Standard Definition Aspect Ratio Enable Banner Display

Selected Aspect Ratio Conversion

Wide Screen Signalling

Video Status

Primary Video Output	SD	Video Input Format	
Standard Definition Output	NTSC	Encoding Format	Unknown
		Bit Rate(Mbps)	0.0
Aspect Ratio	4:3 -> 4:3 using None	Frame Rate(fps)	0.025
Wide Screen Signalling		3:2 Pulldown	Yes

- 2 From the **Primary Video Output** drop-down list, choose the format for local decoding. The options are Auto, HD 720p, HD 1080i, or SD.
- 3 From the **Standard Definition Output** drop-down list, choose the actual standard definition output format of the primary video if the PV Output is set to SD. The options are Auto, NTSC, PAL-N (AR), PAL-M, or PAL-B/G/I/D. You must use NTSC for 525-line systems and PAL-B/G/I/D for 625-line systems.
- 4 From the **Standard Definition Aspect Ratio** drop-down list, choose the Standard Definition aspect ratio of your TV monitor (4:3 or 16:9). The default is 4:3. Set it to the corresponding value.
- 5 From the **Selected Aspect Ratio Conversion** drop-down list, choose the aspect ratio conversion that the transcoder will perform on the incoming signal for the picture to be displayed correctly on your TV, based on the **Standard Definition Aspect Ratio** selection.

The options are None, Auto, Auto AFD, 16:9 L/B, 4:3 P/B, 14:9, 4:3 CCO, and 16:9 Scale. The default is Auto.

- 6 From the the **Wide Screen Signalling** drop-down list, choose the wide screen signaling output mode. It is used to select how the transcoder affects PAL WSS when it is present in the VBI line 23. The table below describes each of the options. The default is Auto.

WSS Mode	Description
Passthrough	Passes WSS unmodified as received by the transcoder.
Auto:Create	Creates WSS to output the correct aspect ratio when performing aspect ratio conversion.
Auto:Modify	If WSS is present in the input stream, it is modified to output the correct aspect ratio when performing aspect ratio conversion. If WSS is not present in the input, no WSS will be present in the output.
Suppress	Removes WSS output.

- 7 Check the **Enable Banner Display** check box to display alarms and warnings on the on-screen display (e.g., TV monitor).
- 8 Click **Apply**.

Viewing the Video Status

The **Video Status** area displays the current video settings, and the encoding, bit rate, FPS and aspect ratio of the incoming signal. The fields are read-only. The following table describes the video status information displayed:

Video Status	Description
Primary Video Output	Indicates the actual output video format (Auto, HD 720p, HD 1080i, or SD).
Standard Definition Output	Displays the actual standard definition format of the primary video output if the PV Output is set to SD.
Aspect Ratio	Displays the standard definition aspect ratio of your TV monitor.
Wide Screen Signalling	Displays the Wide Screen Signaling output mode.
Video Input Format	Displays the video encoding, format, and resolution of the received program.
Encoding Format	The input stream type of the received signal/program.
Bit Rate (Mbps)	Indicates the bit rate of the input video stream, in Mbps.
Frame Rate (fps)	Indicates the frame rate of the input video stream.
3:2 Pulldown	Indicates whether 3:2 pulldown is detected, was recently detected, or not detected in the input video stream (Yes, Recent, or No).

Setting up Captions

- 1 From the user interface of the D9859, choose **Audio & Video > Captions**. The Captions page is displayed.

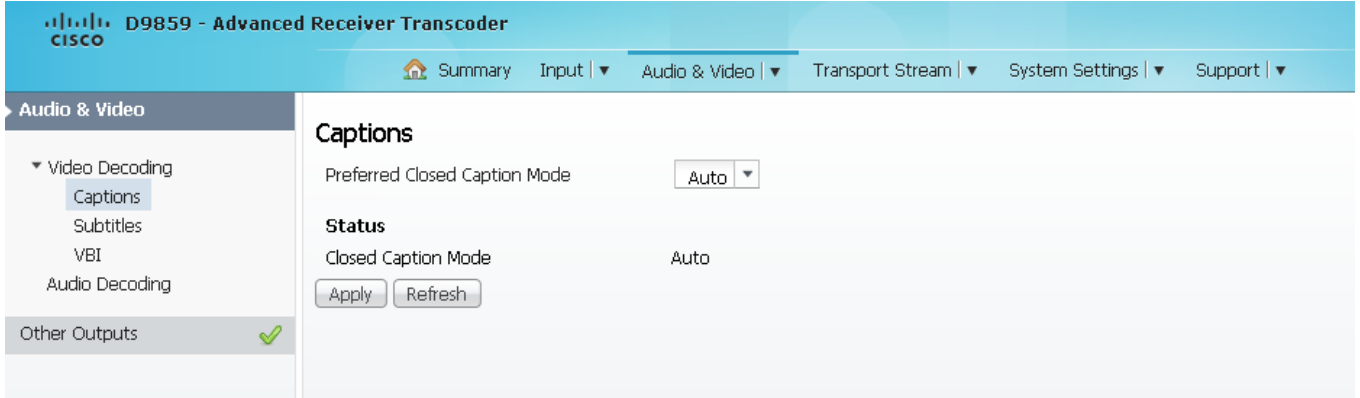

- 2 From the **Preferred Closed Caption Mode** drop-down list, choose the type of closed captioning to use if there are multiple available in the stream (Auto, SA Custom, EIA 708, Type 3, Type 4 SA, Type 4 ATSC, Reserved, or DVS 157). The default is Auto.
Note: SA Custom is not supported when telecine video coding is enabled.
- 3 The **Closed Caption Mode** in the **Status** area displays the actual closed caption mode in the output. This is read-only.
- 4 Click **Apply**.

Setting up Subtitles

- 1 From the user interface of the D9859, choose **Audio & Video > Subtitles**. The Subtitles page is displayed.

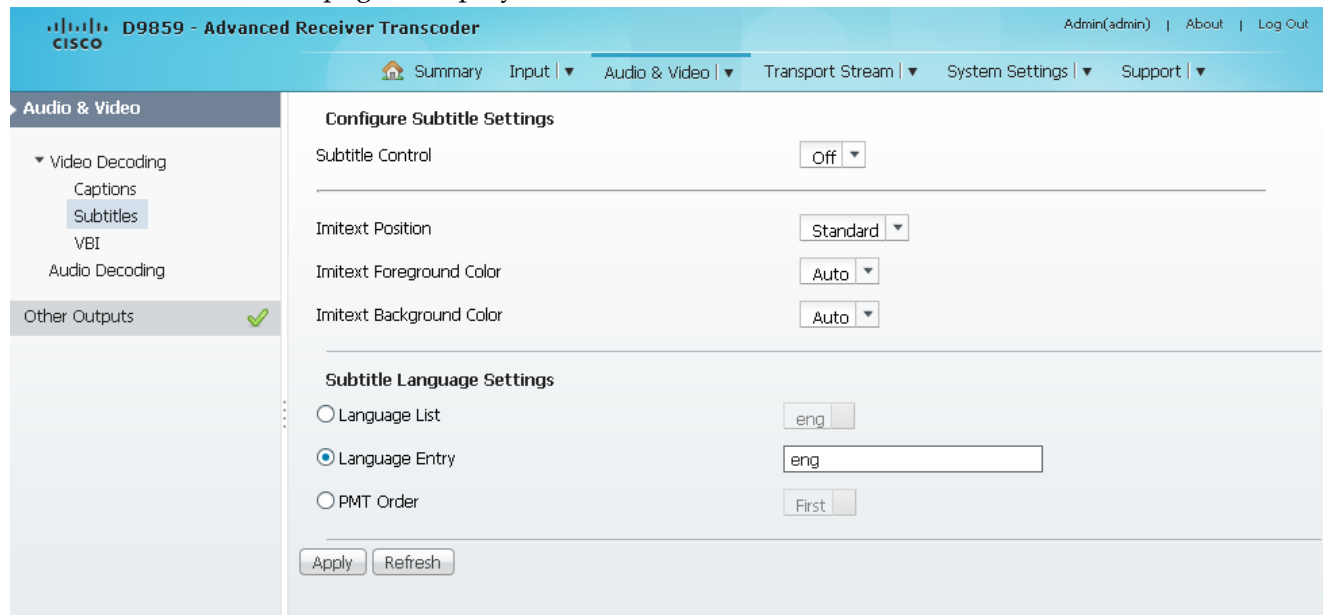

- 2 Select the **Subtitle Control** to use to display the program subtitles. The following table describes each of the available options:

Op Mode Selection	Description
Off	No subtitles are displayed.
On	Displays DVB or Imitext subtitles, if available.
DVB	Displays only DVB titles, if available. Otherwise, no subtitles are displayed.
Imitext	Displays only Imitext subtitles, if available. Otherwise, no subtitles are displayed.

- 3 From the **Imitext Position** drop-down list, choose the position of the on-screen subtitle text (Standard or Extended).
- 4 From the **Imitext Foreground Color** drop-down list, choose the color for Imitext subtitles. Auto displays text in the color transmitted by the subtitling equipment. Yellow and White overrides the color set by the uplink and display text in the selected color.
- 5 The **Imitext Background Color** sets the text background for Imitext subtitles. The following table identifies the affect each setting has on the displayed subtitle text:

BackGnd Option	Description
Auto	Uses the uplink subtitling equipment setting.

BackGnd Option	Description
Shadow	Applies an outline to the right side of each text character. No background box is applied to subtitles, i.e., text is visible directly on top of video.
Opaque	Applies a black box to each text character.
Semi	Applies a semi-transparent box to subtitle text.
None	No shadow or outline is applied to subtitle text.

- 6 In the **Subtitle Language Settings** area, click on the radio button of the input source for the subtitle language. The default is **Language List**. **Language Entry** and **PMT Order** are more applicable for advanced applications. The following table describes each of the available options and how to set them:

Select Language By Option	Description
Language List	Select the MPEG language to display from the available list. The following are the available options: ara (Arabic), btk (Batak (Indonesia), ben (Bengali), bul (Bulgarian), chi (Chinese), cze (Czech), dan (Danish), dut (Dutch), eng (English), fin (Finnish), fre (French), ger (German), gre (Greek), heb (Hebrew), hin (Hindi), hun (Hungarian), ice (Icelandic), ind (Indonesian), ita (Italian), jpn (Japanese), kor (Korean), may (Malay), mul (Multiple Languages), nor (Norwegian), per (Persian), pol (Polish), por (Portuguese), rum (Romanian), rus (Russian), san (Sanskrit), scc (Serbian), sin (Sinhalese), slo (Slovak), som (Somali), spa (Spanish), swe (Swedish), tai (Tai Other), tam (Tamil), tha (Thai), tur (Turkish), ukr (Ukrainian), or vie (Vietnamese)
Language Entry	Enter the three-character code provided by your uplink service provider (e.g., eng for English). The supported languages are according to ISO 639-2 Language Codes.
PMT Order	Select the subtitle PID entry to display (First to Eighth). This information is available from your uplink provider.

- 7 Click **Apply**.

Setting up VBI

- 1 From the user interface of the D9859, choose **Audio & Video > VBI**. The VBI page is displayed.

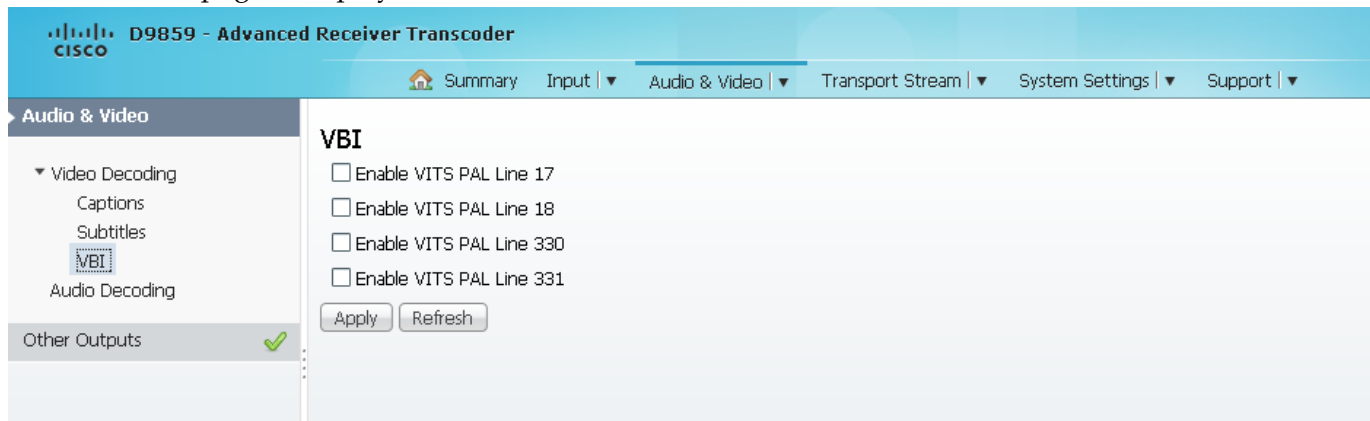

- 2 Check the **Enable VITS PAL Line 17, 18, 330, and/or 331** check boxes to enable the Vertical Interval Test Signal (VITS) on PAL Lines 17, 18, 330, and/or 331.
- 3 Click **Apply**.

Setting up Audio Parameters

- 1 From the user interface of the D9859, choose **Audio & Video > Audio Decoding**. The Audio Decoding page is displayed.

Audio Decoding

Audio Selection

Audio Decode	Select By	PMT Source	Language List	Manual Entry
1	PMT Order	AUD1	eng	eng
2	PMT Order	AUD2	eng	eng

Audio Setup

Audio Decode	Audio Mode	AC3 Compression	Left Attenuation	Right Attenuation
1	Stereo	RF Mode	0.0	0.0
2	Stereo	RF Mode	0.0	0.0

Audio Status

Audio	PID	Language	Format	Bit Rate (Kb...)	SFR	Buffer	DDP Mode	Dualmono Mode
1			None	0	0.0	0	OFF	OFF
2			None	0	0.0	0	OFF	OFF

Apply Refresh List Audio PIDs

- 2 The **Audio Selection** area allows you to select the audio PID for audio decoding. The D9859 supports two local audio devices.
 - a From the **Select By** drop-down list, choose the input source for Audio 1 or Audio 2.

Note: You cannot select PMT order for one audio and Language List or Language Entry for the other audio. For example, you cannot select PMT Order for Audio 1 and Language List for Audio 2.
 - b If **Language List** is selected, you must choose a language from the **Language List** column. If **Language Entry** is selected, you must a language code in the **Manual Entry** column. If the languages selected are different, the first PID with the matching language will play on the appropriate audio device (Audio 1 or Audio 2). If you select the same language for both Audio 1 and Audio 2, the PIDs are mapped as follows: the first matching language PID to Audio 1 and the second matching PID to Audio 2.

- c If **PMT Order** is selected, you must set the PMT order for each audio (None, AUD1 to AUD64). You cannot select the same PID for both audio devices. If you select the same instance of an audio PID for one of the audio devices, the other audio device PID instance will automatically increment by one. For example, Audio 1 is set to AUD1 and Audio 2 is set to AUD2. If you change Audio 1 source to AUD2, the Audio 2 source will automatically change to AUD3 to resolve the conflict.
- 3 There are two audio settings. The **Audio Setup** area allows you to configure the two balanced audio outputs on the rear panel (Audio 1 and Audio 2), known in the Web GUI as 1 and 2, respectively.
- a From the **Audio Mode** drop-down list, choose the output mixing.
Select Stereo (Left and Right are passed directly through to Left and Right), R-Mono (Right is passed to both the Left and Right), L-MONO (Left is passed to both the Left and Right), or Mixed (Left is passed to both the Left and Right, and Right is passed to both the Left and Right).
 - b From the **AC3 Compression** drop-down list, choose the mode to use if the output is compressed Dolby Digital audio. The selections are Line Mode, Custom 1, Custom 0 or RF Mode. RF Mode is recommended for analog cable modulators.
 - c From the **Left Attenuation** drop-down list, choose the volume adjustment for the Left audio channel. You can select a value in the range from -6.0 dB to +6.0 dB, in increments of 0.5 dB.
 - d From the **Right Attenuation** drop-down list, choose the volume adjustment for the Right audio channel. You can select a value in the range from -6.0 dB to +6.0 dB, in increments of 0.5 dB.
- 4 Click **Apply**.

Viewing the Audio Status and Audio PIDs

The **Audio Status** area displays the current audio settings. The following table describes the audio status information:

Audio Status	Description
Audio	Displays the current audio decoder status.
PID	Indicates the program PID number (1 to 8191).
Language	Indicates the language code.
Format	Indicates the format of the audio input stream.
Bit Rate (kbps)	Displays the bit rate of the audio input stream, in kbps.
SFR	Displays the sample rate of the input audio stream, in kHz (32, 44.1, or 48 KHz).
Buffer	Indicates the buffer level of the input audio stream, in bytes.

Audio Status	Description
DDP Mode	Displays the presence of Dolby Digital Plus frames within a Dolby Digital audio stream (ON or OFF).
Dualmono Mode	Indicates the presence of dual mono audio outputs in the audio stream (ON or OFF).

Click **List Audio PIDs** to view a list of all the current audio PIDs.

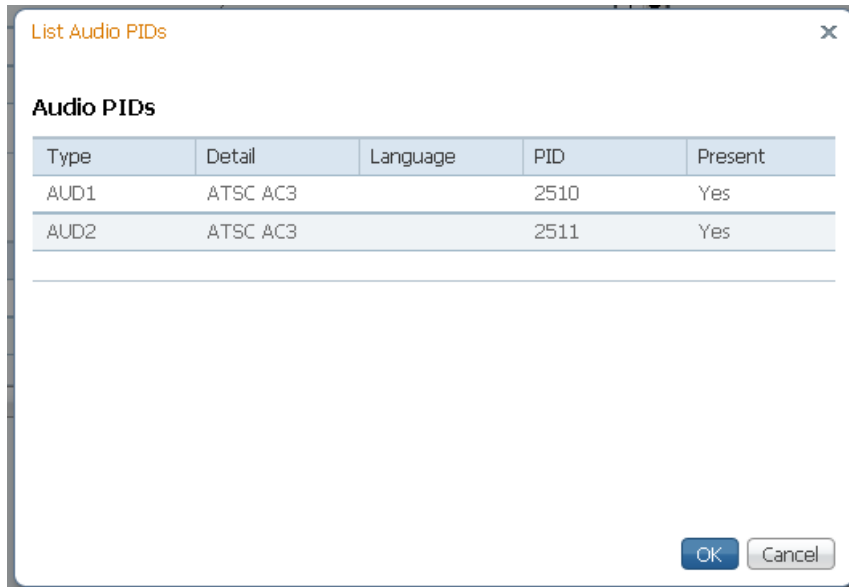

The following table describes the Audio PIDs information:

Audio Status	Description
Type	Displays the input audio source (AUD1 or AUD2)
Detail	Indicates any detail associated with the audio PID. The parameters are: MPG1 VID, MPG2 VID, 422 VID, H264 VID, HD VID, MPG4 VID, MPG AUD, MPG2 AUD, DVB AC3, DVB DDP, AAC AUD, HEAAC, AUD, MPG4 AUD, DBE AUD, DTS AUD, DVB TXT, DVB VBI, DVB SUBT, DVB ASYN, DVB SYNS, DVB SYND, DVB MPE, DVB DCAR, DVB OCAR, SA VBI, ATSC AC3, ATSC DDP, SA UTLD, SCTE DPI, SA HSD, SA CDDL, SA WBD, SA SUBT, ECM, EMM, PCR, or UNKNOWN.
Language	Displays the language code of the audio PID, if applicable.
PID	Indicates the audio PID number, in the range from 1 to 8192.
Present	Indicates whether the audio PID is present in the incoming stream (Yes or No).

Setting up Cueing Parameters

- 1 From the user interface of the D9859, choose **Audio & Video > Cueing**. The Cueing page is displayed.

The screenshot shows the Cisco D9859 Advanced Receiver Transcoder web interface. The page title is "D9859 - Advanced Receiver Transcoder". The navigation menu includes "Summary", "Input", "Audio & Video", "Transport Stream", "System Settings", and "Support". The left sidebar shows "Audio & Video" with a green checkmark and "Other Outputs" expanded to show "Cueing" selected. The main content area is titled "Cueing" and contains the following settings:

- Cueing Mode: Trigger
- Trigger polarity: High
- Cueing Tone Repeat Count: 3
- Tone Duration (ms): 40
- Silence Duration (ms): 40
- Relay Mode: Alarm
- Relay Trigger Bit: 1

There are "Apply" and "Refresh" buttons at the bottom of the settings area.

- 2 From the **Cueing Mode** drop-down list, choose whether the cueing output should be DTMF tones or trigger pins.
Tones are standard Dual-Tone Multi-Frequency (DTMF) tones. The tones are generated at the Cue Tone/Relay output on the rear panel of the transcoder. Trigger refers to open-collector pins which can be generated at the Cue Tone/Relay output on the rear panel of the transcoder.
- 3 If **Trigger** is selected as the **Cueing Mode**, choose the pin polarity from the **Trigger Polarity** drop-down list. Choose **High** for the pins to act as open or floating collectors on an active cueing signal and as ground on an inactive signal. Choose **Low** for the pins to act as ground on an active cueing signal and as open or floating collectors on an inactive signal.
- 4 If the **Cueing Mode** is set to **Tone**, set the number of consecutive tone sequences to be generated in the **Cueing Tone Repeat Count** field. Values greater than 1 are provided when a scenario demands repetition to ensure that the ad insertion equipment receives the signal. You can enter 1, 2, or 3. The default is 3.
- 5 If the **Cueing Mode** is set to **Tone**, enter the **Tone Duration** of each tone, in milliseconds, in the range from 0 to 80. The default is 40.
- 6 If the **Cueing Mode** is set to **Tone**, enter the **Silence Duration** of each silence between tones, in milliseconds. The duration is in the range from 0 to 80. The default is 40.
- 7 From the **Relay Mode** drop-down list, choose the relay mode that can be programmed to respond to an Alarm state, Warning state, or the state of one of the eight cue trigger pins. The response is generated at the Cue Tone/Relay output on the rear panel of the transcoder. The following table shows what the possible field settings are and their relationship to the transcoder output:

Chapter 5 Web GUI Setup and Monitoring

Relay Mode	Condition	Relay Contact	
		NC - C	C-NO
Alarm	Unit Power Off	Open	Close
	Alarm State	Open	Close
	No Alarm	Close	Open
Trigger	Active (selected in PNC)	Close	Open
	Inactive	Open	Close

- 8 If the **Relay Mode** is set to **Trigger**, choose the cue trigger bit/pin that will activate the relay from the **Relay Trigger Bit** drop-down list (1 to 8).
- 9 Click **Apply**.

Setting up Cue Tone Test

- 1 From the user interface of the D9859, choose **Audio & Video > Cue Tone Test**.
The Cue Tone Test page is displayed.

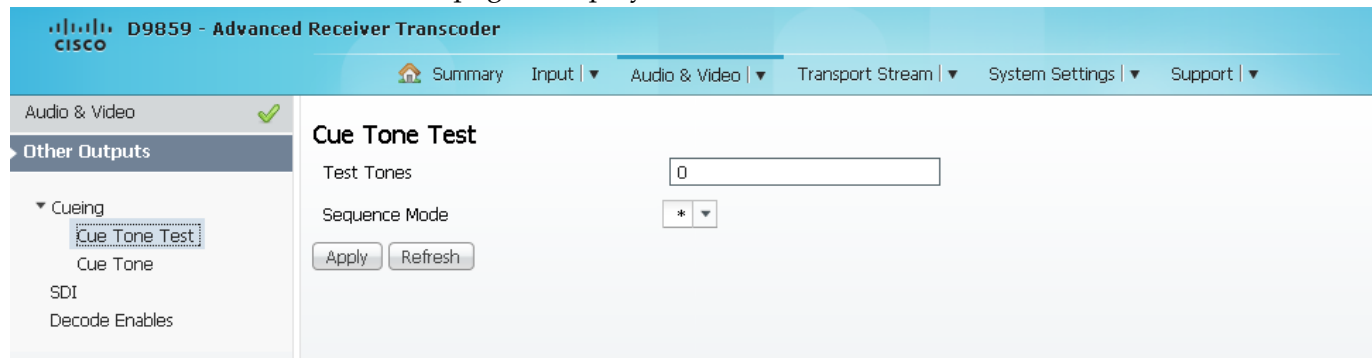

- 2 In the **Test Tones** field, specify the three digit tone sequence. You can enter a value between 000 and 999.
- 3 From the **Sequence Mode** drop-down list, choose the tone sequence mode. The following describes the available options:
 - * - Start tone only
 - # - End tone only
 - */# - Start and end tones. The end tone is signaled after waiting the time specified in Delay(sec).
- 4 Click **Apply**.

Setting up Cue Tones

- 1 From the user interface of the D9859, choose **Audio & Video > Cue Tone**. The Cue Tone page is displayed.

Sequence N...	Sequence State	Sequence Tones	Sequence Mode	Sequence Delay
1	Disable		*	1
2	Disable		*	1
3	Disable		*	1
4	Disable		*	1
5	Disable		*	1
6	Disable		*	1
7	Disable		*	1
8	Disable		*	1
9	Disable		*	1
10	Disable		*	1
11	Disable		*	1
12	Disable		*	1
13	Disable		*	1
14	Disable		*	1
15	Disable		*	1
16	Disable		*	1

- 2 The **Sequence Number** lists the tone sequences. The transcoder supports up to 16 tone sequences. You can configure the state, tones, mode, and delay for each tone sequence.
- 3 From the **Sequence State** drop-down list, choose to enable or disable the current tone sequence. When disabled, no cue tone is output.
- 4 In the **Sequence Tones** field, set the three digit tone sequence (1 to 999).
- 5 From the **Sequence Mode** drop-down list, choose the tone sequence mode.
Select * for start tone, # for the end tone, and */# for the start and end tones. The end tone is signaled after waiting the time specified in the **Sequence Delay** field.
- 6 If the **Sequence Mode** is set to */# (Start/Stop), set the sequence delay in the **Sequence Delay** field, in seconds, between the start and stop sequences. You can enter a value in the range from 1 to 255. The default is 30.
- 7 Click **Apply**.

Setting up Services

- 1 From the user interface of the D9859, choose **Audio & Video > Decode Enables**.
The Decode Enables page is displayed.

The screenshot shows the Cisco D9859 Advanced Receiver Transcoder web interface. The top navigation bar includes 'Summary', 'Input', 'Audio & Video', 'Transport Stream', 'System Settings', and 'Support'. The left sidebar shows 'Audio & Video' with a green checkmark, and 'Other Outputs' with a dropdown menu containing 'Cueing', 'Cue Tone Test', 'Cue Tone', 'SDI', and 'Decode Enables'. The main content area is titled 'Decode Enables' and contains a list of services with checkboxes. The 'Enable Decode Engine' checkbox is unchecked, while all other checkboxes are checked. At the bottom of the list are 'Apply' and 'Refresh' buttons.

Service	Checked
Enable Decode Engine	<input type="checkbox"/>
Video	<input checked="" type="checkbox"/>
Audio1	<input checked="" type="checkbox"/>
Audio2	<input checked="" type="checkbox"/>
Audio3	<input checked="" type="checkbox"/>
Audio4	<input checked="" type="checkbox"/>
VBI	<input checked="" type="checkbox"/>
Data	<input checked="" type="checkbox"/>
MPE1	<input checked="" type="checkbox"/>
MPE2	<input checked="" type="checkbox"/>
MPE3	<input checked="" type="checkbox"/>
MPE4	<input checked="" type="checkbox"/>
MPE5	<input checked="" type="checkbox"/>
STT	<input checked="" type="checkbox"/>
DPI	<input checked="" type="checkbox"/>

- 2 Check the services to be decoded by the transcoder. Check or uncheck **Enable Decode Engine** check box to select/de-select all the services in the list.
- 3 Click **Apply**.

Configuring Transport Stream Information

Configuring the ASI Output

- From the user interface of the D9859, choose **Transport Stream > ASI Output**. The ASI Outputs page is displayed.

Note: After you make any changes, a successfully updated (session open) message appears. The changes are displayed, but not saved. You must click **Apply** to save and apply the changes.

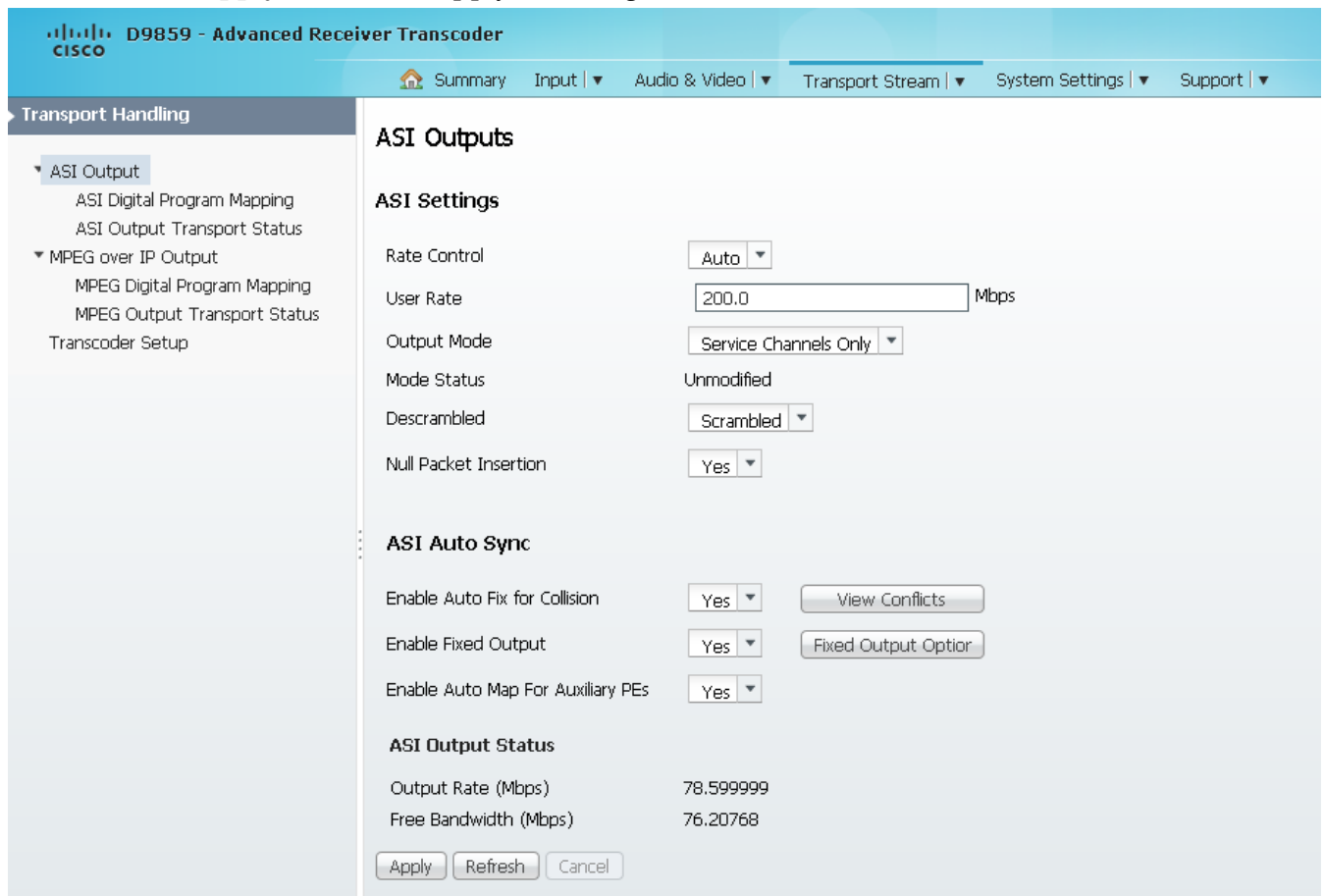

Note: Any changes made to the ASI DPM values will automatically change the **Mode Status** to **Edited by User**.

- From the **Rate Control** drop-down list, choose the output rate control. The following table describes the affect each of the settings has on the output bit rate:

Rate Control	Description
Auto	The output rate follows that set by the uplink. The output rate will be the same as the input rate (including all null packets). This means the output bit rate is determined automatically based on the input source symbol rate and FEC value.

Rate Control	Description
User	The output rate is specified by the User Rate field. It is determined by the user setting regardless of the input source.

- If the **Rate Control** is set to **User**, enter the maximum output bit rate in the **User Rate** field. This setting is used when the signal source is RF or ASI and allows you to set the output bit rate to a value expected by equipment connected to the ASI output.

You can enter a range from 0 to 206 Mbps.

Note: Output data may be lost if this bit rate is set to a value less than the actual signal bit rate.

- From the **Output Mode** drop-down list, choose the DPM output mode for the current output. With the exception of **No Output** and **Full DPM Control**, selecting a mode will configure the DPM settings to achieve the specified behavior. In this way, they act as DPM presets. The **Mode Status** is changed from **Unmodified** to **Edited by User**. We highly recommend that you use either one of these basic modes, or, for advanced setup, enter the DPM mapping before setting the **Output Mode**. The following table describes each mode:

Output Mode	Description
No Output	No ASI output will be generated and the ASI port will be disabled.
Passthrough	All PEs will be set to Pass and other DPM settings will also be set.
Service Channels Only	This is similar to Passthrough, except that only channels applied to program entries are available on the output.
MAP Passthrough	The output will be identical to the input, except that channels assigned to PEs and PIDs will be mapped using the DPM settings. If the input is tuned to a valid channel, the PEs are automatically set to Map. Otherwise, the PEs are automatically set to Drop . Note: If the PE is mapped, it uses the last saved output MAP configuration. The output map (for example, output channel PMT) does not change automatically if the input or channel number is changed.
MAP Service Channels Only	This is similar to MAP Passthrough, except that only channels applied to program entries are available on the output. If the input is tuned to a valid channel, the PEs are automatically set to Map. Otherwise, the PEs are automatically set to Drop . Note: If the PE is mapped, it uses the last valid input. The output map (for example, output channel PMT) does not change automatically if the input or channel number is changed.
Full DPM Control	The output will be generated according to the DPM settings on the ASI Digital Program Mapping page. This is a manual control setting.

Output Mode	Description
Transcoding	<p>The output will be generated using the DPM MAP settings, except that the DPM Action will be set to XCode and the Descrambled mode will be set to Descrambled. If the input is tuned to a valid channel, the PEs are automatically set to XCode. Otherwise, the PEs are automatically set to Drop.</p> <p>Note: If the PE is transcoded, it uses the last valid input. The output map (for example, output channel PMT) does not change automatically if the input or channel number is changed.</p>

A message appears to confirm that you want to resynchronize the output changes and PIDs to match the selected input programs. Click **Yes**.

If a conflict occurs and **Enable Auto Map for Collision** is set to **No**, a detailed list of all the conflicts is displayed in the **Output Channel and PID Conflicts** table when you click **View Conflicts**. You can then resolve the conflicts manually. If a conflict occurs and **Enable Auto Map for Collision** is set to **Yes**, a message that the conflicts will be fixed automatically and the **Output Channel and PID Conflicts** table is empty.

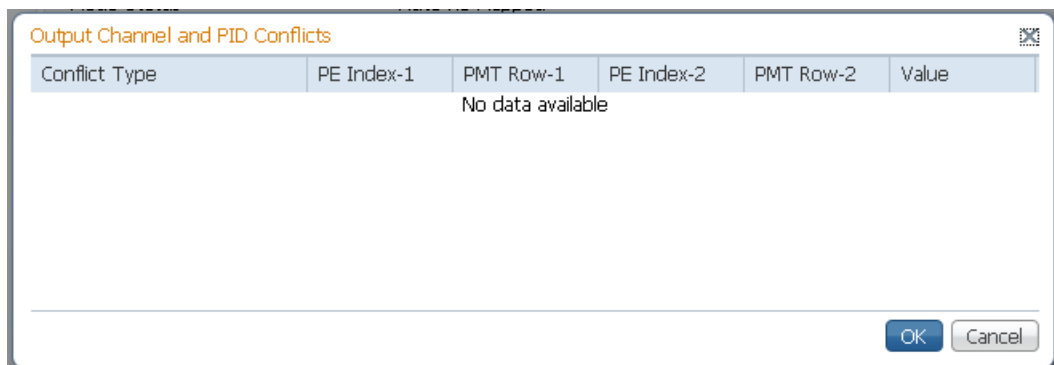

- For channel conflicts, the system will only automatically change the duplicated output channel numbers. If both PE actions are set to **Map** or **XCode**, the output channel number of the higher PE is changed. Otherwise, the output channel number of the mapped and transcoded PE is changed. The new channel number selected is the next channel number that does not appear in the current PAT or belong to any other PEs.
- For PID conflicts, the system will only automatically change the duplicated output PID numbers. If both PE actions are set to **Map** or **XCode**, the output PID number of the higher PE is changed. Otherwise, the output PID number of the mapped or transcoded PE is changed. For example, if the PMT PID of PE1 matches the ES PID of PE2, the ES PID of PE2 is changed. The new PID number selected is the next number that does not appear in the output of any PE and it is not in the current transport input.

Click **Apply** to save the resolved conflict changes.

- 5 The **Mode Status** field indicates the current DPM configuration change by a user after changing the **Output Mode**. The following is a list of possible statuses:

Mode Status	Description
Unmodified	No changes were made after setting a new Output Mode.
Edited by User	DPM changes were made.
Auto Re-Mapped	The output map changed automatically to fix the output channel or PID conflicts at the time of setup.
Changed by Uplink	DPM output changes were initiated by an encoder.

- 6 From the **Descrambled** drop-down list, choose whether the output will be descrambled if the input is scrambled. The following table describes the available options:

Descramble	Description
Scrambled	The output channel will remain scrambled even if the PE is authorized and can descramble the channel.
Descrambled	Descrambles the output channel, and passes in-the-clear channels.

- 7 Choose **Yes** to insert null packets into the output to maintain output at a constant bit rate from the **Null Packet Insertion** drop-down list. Otherwise, choose **No**.

Note: We recommend that you set the **Null Packet Insertion** to **Yes**, especially if the **Output Mode** is set to **Transcoding**.

- 8 Click **Apply**.

Setting Up the ASI Auto Synchronization Options

The **ASI Auto Sync** area allows you to configure the DPM without editing each output channel and PID separately.

- 1 In the ASI Outputs page (**Transport Stream > ASI Output**), refer to the **ASI Auto Sync** area.
- 2 From the **Enable Auto Fix for Collision** drop-down list, choose **Yes** for the DPM to resolve channel and PID collisions automatically on the transport outputs. New values are assigned to the parameters that caused the conflict. The new assigned values are not used by any incoming transport or other PE outputs. If a collision is detected, you can review the new changes and click **Apply** to accept the new changes.

Choose **No** and a detailed list of all the conflicts is displayed in the **Output Channel and PID Conflicts** table (click **View Conflicts**) when a conflict occurs. You can then resolve the conflicts manually.

- 3 From the **Enable Fixed Output** drop-down list, choose **Yes** for the DPM to assign new values for all the output channels and PIDs according to the Fixed Output Options table when you Resynchronize All. Click **Fixed Output Option** to configure the ASI Fixed Output Options:

- a From the **Use Input Channel Numbers** drop-down list, choose **Yes** to use the output channel. Otherwise, choose **No** (default) to use the first channel and channel offset assigned below.
 - i In the **First Channel Number** field, enter the first PE channel number to use. By default, the channel is set to 1.
 - ii In the **Channel Numbers Offset** field, enter the subsequent PE channel numbers. For example, if the First Channel Number is set to 100 and the Channel Numbers Offset is set to 10, then the first channel number is 100, and the second channel number is 110.
- b From the **Use Input PMT PID Numbers** drop-down list, choose **Yes** to use the input PMT PID number. Otherwise, choose **No** (default) to use the first PE PID number and PID offset number assigned below.
 - i In the **First Channel First ES PID Number** field, enter the first PE PMT PID number. The default is 1701.
 - ii In the **PMT PID Numbers Offset** field, enter the offset of the subsequent PE PMT PID numbers. For example, if the First Channel First ES PID Number is set to 1701 and the PMT PID Numbers Offset is set to 1, then the first PMT PID number is 1701, and the second PMT PID number is 1702.
- c From the **Use Input ES PID Numbers** drop-down list, choose **Yes** to use the input ES PID number. Otherwise, choose **No** (default) to use the first ES PID number and the ES PID offset number assigned below.
 - i In the **First Channel First ES PID Number** field, enter the first ES PID number. The default is 101.

- ii In the **First ES PID Numbers Offset** field, enter the offset of the first ES PID of subsequent channel numbers. For example, if the First ES PID Number is set to 101 and the ES PID Numbers Offset is set to 100, then the first ES PID number is 101, and the second ES PID number is 201.
 - d From the **Use Input PMT ES Stream Order** drop-down list, choose **Yes** to assign the ES PID according to the incoming PMT order. Otherwise, choose **No** to use the reserved PIDs defined below.
 - i In the **PCR, VID, AUD, SUBT, VBI, DPI, MPE, TTX, DATA, LSD, CDT, ETV** fields, enter the number of PIDs for the specified streams (PCR, VID, AUD, SUBT, VBI, DPI, MPE, TTX, DATA, LSD, CDT, ETV) in one channel.
 - e Click **OK**.
 - 4 From the **Enable Auto Map For Auxiliary PEs** drop-down list, choose **Yes** for the DPM to set the output actions for all the Auxiliary PEs to MAP when the **Output Mode** is set to **Transcode**. If the **Enable Fixed Table Output** is set to **Yes**, the output configuration for the auxiliary PEs is determined by the fixed output table options when you resynchronize the output channels and PIDs to match the input programs.

Note: The DPM resolves any output conflicts automatically, even if the **Enable Auto Fix for Collision** is set to **No**.
 - 5 Click **Apply**.

Viewing the ASI Output Status

The **ASI Output Status** area displays the current **Output Rate** (0 to 213 Mbps) and the available bit bandwidth (**Free Bandwidth**), in Mbps.

Configuring the DPM ASI Details

Note: The following procedure defines all the available fields. For a typical setup of the DPM, see *Typical set up for Digital Program Mapping (DPM)* (on page 210).

Note: After you make any changes, a successfully updated (session open) message appears. The changes are displayed, but not saved. You must click **Apply** to save and apply the changes.

- 1 From the user interface of the D9859, choose **Transport Stream > Digital Program Mapping**. The ASI Digital Program Mapping page is displayed.

The screenshot shows the Cisco D9859 Advanced Receiver Transcoder web interface. The main content area is titled "ASI Digital Program Mapping" and contains two sections: "DPM Program Entry Setup" and "DPM General Settings".

DPM Program Entry Setup

Program E...	Chl #	Name	Action	Output Chl#	PMT PID
<input type="radio"/> PE1	805	MMX2P6 D9034 ENC5	Map	1	901
<input type="radio"/> PE2	3		Drop	2	902
<input type="radio"/> PE3	1		Drop	9	903
<input type="radio"/> PE4	1		Drop	4	904
<input type="radio"/> PE5	1		Drop	5	905
<input type="radio"/> PE6	3		Drop	6	906
<input type="radio"/> PE7	3		Drop	7	907
<input type="radio"/> PE8	3		Drop	8	908
<input type="radio"/> P1A	805	MMX2P6 D9034 ENC5	Drop	9	909

DPM General Settings

Remapping Mode: Svc ID & PID
 Duplication Method: Pkt Copy
 Unreferenced Content: Drop
 Service ID Output: Valid Ch
 SI Regeneration Option: SA Std
 PSI Table Output Option: Ctl By Table
 PSI Regeneration Option: Always

Buttons: Apply, Refresh, Cancel, Copy to MOIP

- 2 For each DPM **Program Entry**, it displays the input channel number (**Chl #**) and channel **Name**.

There are eight channels (PE1 to PE8), with eight auxiliary channels (PE1A to PE8A). The auxiliary channels automatically tune to the corresponding PE channels. If the main PE is not transcoding, the auxiliary PE is dropped.

Note: Any changes made to the ASI DPM values will automatically change the **Mode Status** to **Edited by User** in the ASI Outputs page.

- 3 In the table, select the program entry you want to edit the **Action** setting.

In the **Action** drop-down list, choose the DPM program action for the PE (Pass, Map, Drop, or XCode). The auxiliary programs (P1A to P8A) cannot be set to **XCode**.

Click **Save**.

Configuring Transport Stream Information

If you want to configure an auxiliary PE, we highly recommend that you perform the following:

- From the **Enable Auto Map For Auxiliary PEs** drop-down list, choose **Yes** in the ASI Outputs page.
 - Set PxA to **Map**.
 - Click **Resynchronize All** to ensure that the inputs and outputs are the same.
- 4 Select the program entry you want to edit.
 - 5 Click **Edit**. The DPM PE PID MAP window opens.

Input Stream	Input PID	Action	Stream Type	Category	Instance	Output PID
PCR	2548	Map	0	PCR	1	101
VBI	206	Map	128	VBI	1	102
SUBT	610	Map	6	SUBT	1	103
AUD 1	2510	Map	129	AUD	1	104
AUD 2	2511	Map	129	AUD	2	105
VID	2548	Map	27	VID	1	101

- 6 In the **Output Channel #** field, enter the output channel number you want to map to the input channel (**Input Channel #**). This value is only used if the PE **Action** is set to **Map**. You can enter a range from 1 to 65535.
- 7 In the **Output PMT PID** field, enter the output PMT PID number you want to map to the Input PMT PID.
- 8 In the **PE PID MAP** area, you can select an existing PID mapping entry you want to modify or click **Add Row** to create a new entry.
- 9 The **Input Stream** indicates the input service that will be mapped by the current entry. The **Input PID** displays the input PID (1 to 8190) that will be mapped by the current entry. This is only used if the **Action** is set to Map.
- 10 From the **Action** drop-down list, choose the action to perform on the current PID. The **Drop** action is always performed, but the **Map** option is only applied if the PE **Action** is **Map** and the **Remapping Mode** is **Svc ID & PID** in the **DPM General Settings** area.

Action	Description
Drop	The service selected by the Category and Instance will be mapped to the specified PID. This is only applied if the PE action is Map and the Remapping Mode is Svc ID & PID.
Map	The service selected by the Category and Instance will be removed from the PMT and the output stream.

- 11 In the **Stream Type** field, enter a stream type to map within a PE to a specified PID (0 to 255).
- 12 From the **Category** drop-down list, choose the service to configure. If an input service matches this type and Instance, then the Action will be applied. This value is only used if the Action is set to Map. The categories are: UNKN, CDT, LSDT, DATA, TTX, MPE, DPI, VBI, SUBT, AUD, VID, PCR or INVL.
- 13 In the **Instance** field, enter the instance of the service specified by Category to configure (1 to 64). If an input service matches this type and instance, then the Action will be applied.
- 14 If **Action** is set to **Map**, enter the **Output PID** number (0 to 8192).
- 15 Click **Save**.
- 16 Click **OK**.

To remove a PID mapping, select the entry you want to remove and click **Delete**.

Synchronizing the Inputs

- 1 In the **DPM Program Entry Setup** table, each PE output can be synchronized to its input according to one of the four output modes. Select the program entry you want to synchronize and then click **Resynchronize** or click **Resynchronize All** to synchronize the inputs to the outputs according to the service assignments only. The Confirm Resynchronization window is displayed.

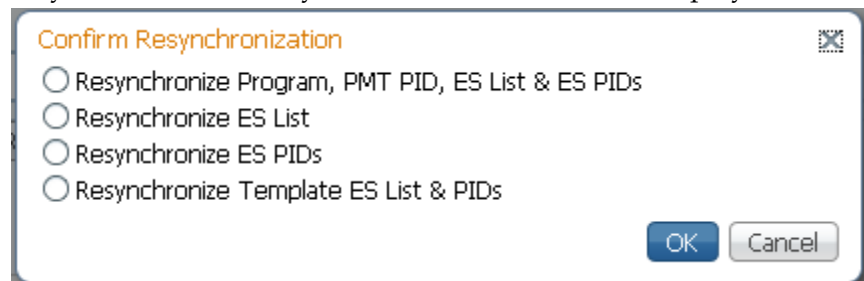

- 2 Check whether you want to synchronize the PE output according to the services and then the PIDs assigned to each service, services only, PIDs only, or to synchronize using a template.

Map Mode	Description
Resynchronize Program, PMT PID, ES List & ES PIDs	The transcoder will synchronize the PE output according to the services and then the PIDs assigned to each service.

Configuring Transport Stream Information

Map Mode	Description
Resynchronize ES List	The transcoder will synchronize the PE output according to the available input services only, and ignore the input to output service PID mapping.
Resynchronize ES PIDs	The transcoder will synchronize the PE output according to the input PIDs only, and ignore the service assignment categories/names.
Resynchronize Template ES List & PIDs	Allows you to preset the input to output mapping of a PE according to the preset template. This is helpful in pre-configuring any number of PEs for future use.

3 Click **OK**.

If a conflict occurs, a message that the conflicts will be fixed automatically and to preview the changes prior to saving is displayed. Click **View Conflicts** to view a detailed list of all the conflicts in the **Output Channel and PID Conflicts** window.

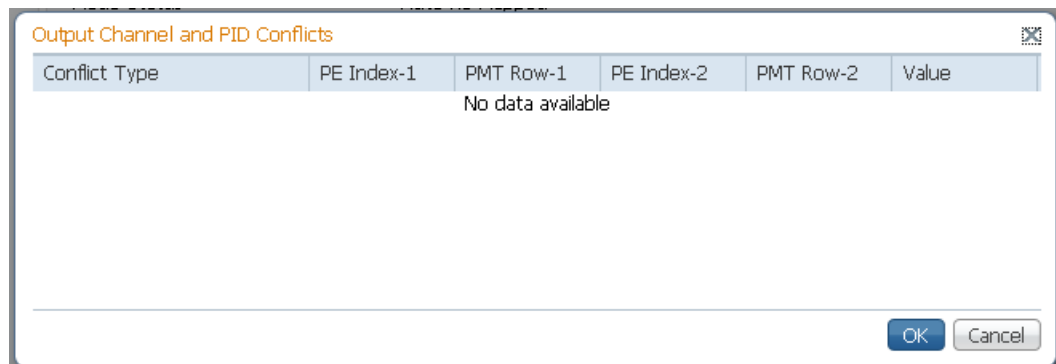

Conflict Type	PE Index-1	PMT Row-1	PE Index-2	PMT Row-2	Value
No data available					

- For channel conflicts, the system will only automatically change the duplicated output channel numbers. If both PE actions are set to **Map** or **XCode**, the output channel number of the higher PE is changed. Otherwise, the output channel number of the mapped and transcoded PE is changed. The new channel number selected is the next channel number that does not appear in the current PAT or belong to any other PEs.
- For PID conflicts, the system will only automatically change the duplicated output PID numbers. If both PE actions are set to **Map** or **XCode**, the output PID number of the higher PE is changed. Otherwise, the output PID number of the mapped or transcoded PE is changed. For example, if the PMT PID of PE1 matches the ES PID of PE2, the ES PID of PE2 is changed. The new PID number selected is the next number that does not appear in the output of any PE and it is not in the current transport input.

Click **Apply** to save the resolved conflict changes.

Configuring DPM General Settings

- 1 In the **DPM General Settings** area, you can configure ASI DPM transport stream settings.
- 2 From the **Remapping Mode** drop-down list, choose the DPM mapping mode for this output. The following table describes each mode:

Map Mode	Description
Svc ID	The elementary PIDs are not changed. Channels are remapped by changing their PSI references. When this mode is selected, PE detailed PID mapping in the PID menu are ignored.
Svc ID & PID	Channels and the elementary service PIDs can be mapped in the DPM PE PID MAP window.

- 3 From the **Duplication Method** drop-down list, choose the method on how to handle duplicate programs. This setting is only used if **Remapping Mode** is set to **Svc ID & PID**. The following table describes the each duplication method:

Duplic Mode	Description
PSI Remap	Every input PID can be mapped to only one output PID. If PID mapping conflicts exist, DPM will use the Precedence Rule to decide which output PID to use. All PMTs using the input PID will be updated to reference the output PID specified by the winner.
Pkt Copy	An input PID can be mapped to multiple output PIDs. The PID will be duplicated as many times as needed (up to a certain hardware limitation). Note: This may increase the output bandwidth of the stream.

Pkt Copy is recommended for most applications.

- 4 From the **Unreferenced Content** drop-down list, choose the action to use for unreferenced content. Unreferenced content is the remainder of the transport stream that is not filtered by the program entries. Select **Drop** (default) to drop all unreferenced content. Select **Pass** to pass all unreferenced content to the output unchanged.
- 5 From the **Service ID Output** drop-down list, choose whether the transcoder should always generate PSI tables for the Mapped PE even if the selected input channel is not available, or for only valid service channels/IDs. The following table describes each service ID:

Svc ID	Description
Valid Ch	Only transmits the PSI tables for the mapped program if the program exists on the input stream.
All Ch	Transmits the PSI tables for the mapped program even if the program does not exist in the input stream. All Ch is only valid if the PAT, NIT, SDT and PMT are set to Regenerate.

- If **PSI Table Output Option** is set to **Ctrl by Table**, select the regeneration rate for those PSI tables being regenerated in the **SI Regeneration Option** drop-down menu. This parameter is only used if **Remapping Control** is set to **None**. The following table describes each PSI rate:

PSI Rate	Description
Auto	Matches the generated PSI tables' output rate to the incoming rate.
MPEG Min	Transmits the generated PSI tables on the longest intervals that are allowed by MPEG standard.
SA Std	Transmits the generated PSI tables based on PowerVu standard intervals.

- From the **PSI Table Output Option** drop-down list, choose the action to perform on the PSI tables for the output stream. The table below describes each option.

PSI Options	Description
Pass All	Transmits the incoming PSI Tables as is; does not modify the content and rate. The SI Regeneration Option and table settings are ignored.
Drop All	Does not transmit any PSI Tables. The SI Regeneration Option and table settings are ignored.
Ctrl By Table	The operator can click Table Options to select the table specific output mode for each table.

- If **Ctrl By Table** is selected as the **PSI Table Output Option**, click **Table Options** to configure the DPM table options. The **DPM Table Options (ASI)** window is displayed.

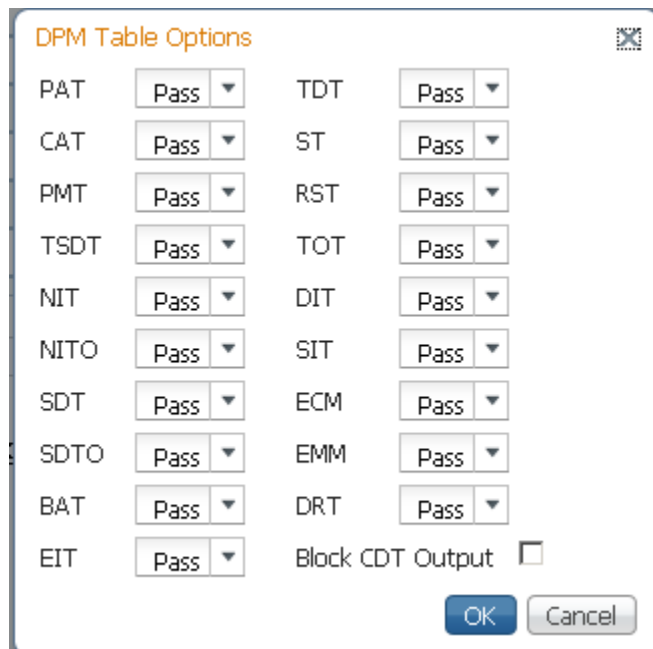

Choose the tables which will be passed, dropped, regenerated or passed with rate control (PwRC) from the ASI Output. For more information on the table options, see *PSI Table Settings* (on page 105).

The CDT is different from the other tables listed because the CDT is referred to within the PMT, rather than outside the PMT. Check the **Block CDT Output** check box to override the DPM PID map configuration for CDT PIDs and to always drop all CDTs. Otherwise, clear the **Block CDT Output** to permit the output of CDTs following the configured DPM PID map configuration and all other DPM constraints.

- 9 From the **PSI Regeneration Option** drop-down list, choose whether to regenerate the PSI tables to the output. Choose **Always** to regenerate all the tables or choose **As Needed** to only regenerate the tables if the content has changed.
- 10 Click **OK**.
- 11 Click **Apply**.
- 12 Click **Copy To MOIP** to copy all the DPM data from the ASI output to the MPEG over IP output.

Viewing the ASI Output Transport Status

From the user interface of the D9859, choose **Transport Stream > Output Transport Status** under **ASI Output**. The PID Output Status page is displayed.

The screenshot shows the 'PID Output Status' page in the D9859 Web GUI. The page title is 'PID Output Status' and it is under the 'Transport Stream > Output Transport Status' menu. The main content area displays a table titled 'Program Entry - Referenced PIDs' with the following data:

PE Index	Type	Input PID	Output PID	PCR	Output Scrambled	Input Received
1	SUBT	610	610	No	No	Yes
1	AUD	2500	2500	No	No	Yes
1	AUD	2503	2503	No	No	Yes
1	VID	2548	2548	No	No	Yes

Below the table, there are sections for 'Current DPM Collisions' and 'Output Channel and PID Conflicts'. The 'Output Channel and PID Conflicts' section shows a table with columns for Conflict Type, PE Index-1, PMT Row-1, PE Index-2, PMT Row-2, and Value. The current value is 'No data available'. There is a 'Refresh' button at the bottom of the main content area.

The **Program Entry - Referenced PIDs** table displays the specified PE ES PIDs information on the output.

The **Output Channel and PID Conflicts** table displays a list of conflicts when the DPM alarm is active.

Configuring the MPEGoIP Output

- 1 From the user interface of the D9859, choose **Transport Stream > MPEG over IP Output**. The MPEG over IP Output page is displayed.

The screenshot shows the Cisco D9859 Advanced Receiver Transcoder web interface. The main content area is titled "MPEG over IP Output" and has two tabs: "Main" (selected) and "Stream".

MPEG Over IP Settings

- Rate Control: User (dropdown)
- User Rate: 68.5 Mbps (input field)
- Output Mode: No Output (dropdown)
- Mode Status: Unmodified
- Descrambled: Descrambled (dropdown)
- Null Packet Insertion: Yes (dropdown)

Advanced PCR Controls

- Start Ethernet Frame on PCR: No (dropdown)

Output Port Selection

- Port Selection: None (dropdown)
- IP Version: IPv4 (dropdown)

MoIP Auto Sync

- Enable Auto Fix for Collision: Yes (dropdown) [View Conflicts button]
- Enable Fixed Output: No (dropdown) [Fixed Output Options button]
- Enable Auto Map For Auxiliary PEs: No (dropdown)

Limits

- Maximum Transport Packets / Ethernet Frame: 7 (input field)
- Minimum Packets / Second: 0 (input field)

MoIP Output Status

Critical MoIP Engine Error	No	Combined User Rate (Mbps)	0.0
MoIP TS Overflow	No	Actual Rate - Control Port (Mbps)	0.0
		Actual Rate - Data Port (Mbps)	0.0

Buttons: Apply, Refresh, Cancel

Stream Details: Note: Consult [IP Unicast Routing page](#) for the list of installed routes.

Bottom navigation: Input Setup, Channel Selection, Video Setup, Audio Setup, Settings File, Service Actions. Status: 0 Alarms, 2 Warnings, 153 Clear.

Note: Any changes made to the MOIP DPM values will automatically change the **Mode Status** to **Edited by User**.

- 2 From the **Rate Control** drop-down list, choose the DPM output rate control. The following table describes the affect each of the settings has on the output bit rate:

Rate Control	Description
Auto	The output rate follows that set by the uplink. This setting can be used if the signal source is ASI. If Null Packet Insertion is set to Yes , the output bit rate is the same as the input rate (including all the null packets). If Null Packet Insertion is set to No , the output rate is equal to the payload rate of the transport stream to be encapsulated, and in most cases, it will be lower than the overall input rate.
User	The output rate is specified by the User Rate field. It is determined by the user setting regardless of the input source. Null packets are always inserted when the configured output bit rate is higher than the payload rate of the transport stream to be encapsulated.

- 3 In the **User Rate** field, enter the output user rate, which is only used if **Rate Control** is set to **User**. If the output bit rate is less than the input, the output data will be partially or completely lost.

Note: Output data will be partially lost if the user-selected bit rate is set to a value that is less than the actual signal bit rate. This allows you to set the output bit rate to a value expected by equipment connected to the MPEGoIP output. You can enter a range from 0 to 206 Mbps.

- 4 From the **Output Mode** drop-down list, choose the DPM output mode. With the exception of **No Output** and **Full DPM Control**, choosing a mode will configure the DPM settings to achieve the specified behavior. In this way, they act as DPM presets. The **Mode Status** is changed from **Unmodified** to **Edited by User**. It is highly recommended to use either one of these basic modes, or, for advanced setup, enter the DPM mapping before setting the **Output Mode**. The following table describes each mode:

Output Mode	Description
No Output	No MPEGoIP output will be generated.
Passthrough	All PEs will be set to Pass and other DPM settings will also be set.
Service Channels Only	Only service channels will be output.
MAP Passthrough	The output will be identical to the input, except that channels assigned to PEs and PIDs will be mapped using the DPM settings. If the input is tuned to a valid channel, the PEs are automatically set to Map. Otherwise, the PEs are automatically set to Drop . Note: If the PE is mapped, it uses the last saved output MAP configuration. The output map (for example, output channel PMT) does not change automatically if the input or channel number is changed.

Output Mode	Description
MAP Service Channels Only	This is similar to MAP Passthrough, except that only channels applied to program entries are available on the output. If the input is tuned to a valid channel, the PEs are automatically set to Map. Otherwise, the PEs are automatically set to Drop . Note: If the PE is mapped, it uses the last valid input. The output map (for example, output channel PMT) does not change automatically if the input or channel number is changed.
Full DPM Control	The output will be generated according to the DPM settings on the MPEG Digital Program Mapping page. This is a manual control setting.
Transcoding	The output will be generated using the DPM default settings, except that the DPM Action will be set to XCode and the Descrambled mode will be set to Descrambled. If the input is tuned to a valid channel, the PEs are automatically set to XCode. Otherwise, the PEs are automatically set to Drop . Note: If the PE is transcoded, it uses the last valid input. The output map (for example, output channel PMT) does not change automatically if the input or channel number is changed.

A message appears to confirm that you want to resynchronize the output changes and PIDs to match the selected input programs. Click **Yes**.

If a conflict occurs and **Enable Auto Map for Collision** is set to **No**, a detailed list of all the conflicts is displayed in the **Output Channel and PID Conflicts** table when you click **View Conflicts**. You can then resolve the conflicts manually. If a conflict occurs and **Enable Auto Map for Collision** is set to **Yes**, a message that the conflicts will be fixed automatically and the **Output Channel and PID Conflicts** table is empty.

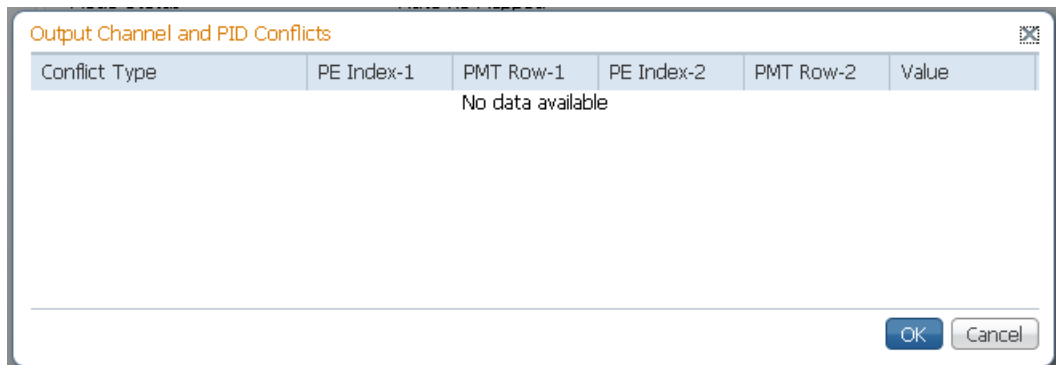

- For channel conflicts, the system will only automatically change the duplicated output channel numbers. If both PE actions are set to **Map** or **XCode**, the output channel number of the higher PE is changed. Otherwise, the output channel number of the mapped and transcoded PE is changed. The new channel number selected is the next channel number that does not appear in the current PAT or belong to any other PEs.

- For PID conflicts, the system will only automatically change the duplicated output PID numbers. If both PE actions are set to **Map** or **XCode**, the output PID number of the higher PE is changed. Otherwise, the output PID number of the mapped or transcoded PE is changed. For example, if the PMT PID of PE1 matches the ES PID of PE2, the ES PID of PE2 is changed. The new PID number selected is the next number that does not appear in the output of any PE and it is not in the current transport input.

Click **Apply** to save the resolved conflict changes.

- 5 The **Mode Status** indicates the current DPM configuration change by a user after changing the **Output Mode**. The following is a list of possible statuses:

Mode Status	Description
Unmodified	No changes were made after setting a new Output Mode.
Edited by User	DPM changes were.
Auto Re-Mapped	Output map changed automatically to fix the output channel or PID conflicts at the time of setup.
Changed by Uplink	DPM output changes were initiated by an encoder.

- 6 From the **Descrambled** drop-down list, choose whether the transcoder should scramble the output even if it is authorized to receive the channel. The default is Descrambled.

Descramble Mode	Description
Scrambled	Scrambles the output channel even if the PE is authorized and can descramble the channel.
Descrambled	Descrambles the output channel, and passes in-the-clear channels.

- 7 Choose **Yes** to insert null packets in the output stream from the **Null Packet Insertion** drop-down list. Otherwise, Choose **No**. Null packets are always inserted if the **Rate Control** is set to **User** and the configured output bit rate is higher than the payload rate of the transport stream to be encapsulated.

Note: We recommend that you set the **Null Packet Insertion** to **Yes**, especially if the **Output Mode** is set to **Transcoding**.

- 8 In the **SAP Multicast IP Address** field, set the Session Announcement Protocol destination IP address. This is the IP address where the SAP announcements are sent, if required.

Note: We do not recommend you to change the default IP address (224.2.127.54).

- 9 In the **SAP Destination UDP Port** field, set the SAP destination port number (1 to 65534). This is the UDP port where the SAP announcements are sent, if required.

Note: We do not recommend you to change the default SAP port 9875.

- 10 From the **Start Ethernet Frame on PCR** drop-down list, choose whether to always transmit a new Ethernet Packet when a new Program Clock Reference (PCR) arrives (Yes or No).

- 11 From the **Port Selection** drop-down list, choose the output mode (None, Control Port, or Data Port). Choose **Control Port** to always output data on the Management port. Choose **Data Port** to always output data on the Data port. Choose **None** to disable the MPEGoIP interface.
- 12 The **IP Version** field displays the IP protocol. Only IPv4 is currently supported.
- 13 Click **Apply**.

Setting Up the MPEG over IP Auto Synchronization Options

The **MoIP Auto Sync** area allows you to configure the DPM without editing each output channel and PID separately.

- 1 In the MPEG over IP Output page (**Transport Stream > MPEG over IP Output**), refer to the **MoIP Auto Sync** area.
- 2 From the **Enable Auto Fix for Collision** drop-down list, choose **Yes** for the DPM to resolve channel and PID collisions automatically on the transport outputs. New values are assigned to the parameters that caused the conflict. The new assigned values are not used by any incoming transport or other PE outputs. If a collision is detected, you can review the new changes and click **Apply** to accept the new changes.

Choose **No** and a detailed list of all the conflicts is displayed in the **Output Channel and PID Conflicts** table (click **View Conflicts**) when a conflict occurs. You can then resolve the conflicts manually.

- 3 From the **Enable Fixed Output** drop-down list, choose **Yes** for the DPM to assign new values for all the output channels and PIDs according to the Fixed Output Options table when you Resynchronize All. Click **Fixed Output Options** to configure the MoIP Fixed Output Options:

MoIP Fixed Output Options

Use Input Channel Numbers	<input type="text" value="No"/>	Use Input PMT ES Stream Order	<input type="text" value="Yes"/>
First Channel Number	<input type="text" value="1"/>	Number of PIDs Reserved For:	
Channel Numbers Offset	<input type="text" value="1"/>	PCR	<input type="text" value="1"/>
<hr/>		VID	<input type="text" value="1"/>
Use Input PMT PID Numbers	<input type="text" value="No"/>	AUD	<input type="text" value="8"/>
First Channel First ES PID Number	<input type="text" value="901"/>	SUBT	<input type="text" value="8"/>
PMT PID Numbers Offset	<input type="text" value="1"/>	VBI	<input type="text" value="2"/>
<hr/>		DPI	<input type="text" value="2"/>
Use Input ES PID Numbers	<input type="text" value="No"/>	MPE	<input type="text" value="5"/>
First Channel First ES PID Number	<input type="text" value="101"/>	TTX	<input type="text" value="1"/>
First ES PID Numbers Offset	<input type="text" value="100"/>	DATA	<input type="text" value="1"/>
		LSD	<input type="text" value="1"/>
		CDT	<input type="text" value="4"/>
		ETV	<input type="text" value="4"/>

- a From the **Use Input Channel Numbers** drop-down list, choose **Yes** to use the input channel numbers. Otherwise, set to **No** (default) to use the first channel and channel offset assigned below.
 - i In the **First Channel Number** field, set the first PE channel number to use. By default, the channel is set to 1.
 - ii In the **Channel Numbers Offset** field, set the subsequent PE channel numbers. For example, if the First Channel Number is set to 100 and the Channel Numbers Offset is set to 10, then the first channel number is 100, and the second channel number is 110.
 - b From the **Use Input PMT PID Numbers** drop-down list, choose **Yes** to use the input PMT PID number. Otherwise, choose **No** (default) to use the first PE PID number and PID offset number assigned below.
 - i In the **First Channel First ES PID Number** field, set the first PE PMT PID number. The default is 1701.
 - ii In the **PMT PID Numbers Offset** field, set the offset of the subsequent PE PMT PID numbers. For example, if the First Channel First ES PID Number is set to 1701 and the PMT PID Numbers Offset is set to 1, then the first PMT PID number is 1701, and the second PMT PID number is 1702.
 - c From the **Use Input ES PID Numbers** drop-down list, choose **Yes** to use the input ES PID number. Otherwise, set to **No** (default) to use the first ES PID number and the ES PID offset number assigned below.
 - i In the **First Channel First ES PID Number** field, set the first ES PID number. The default is 101.
 - ii In the **First ES PID Numbers Offset** field, set the offset of the subsequent ES PID numbers. For example, if the First ES PID Number is set to 101 and the ES PID Numbers Offset is set to 100, then the first ES PID number is 101, and the second ES PID number is 201.
 - d From the **Use Input PMT ES Stream Order** drop-down list, choose **Yes** to assign the ES PID according to the incoming PMT order. Otherwise, set to **No** to use the reserved PIDs defined below.
 - i In the **PCR, VID, AUD, SUBT, VBI, DPI, MPE, TTX, DATA, LSD, CDT, ETV** fields, enter the number of PIDs for the specified streams (PCR, VID, AUD, SUBT, VBI, DPI, MPE, TTX, DATA, LSD, CDT, ETV) in one channel.
 - e Click **OK**.
- 4 From the **Enable Auto Map For Auxiliary PEs** drop-down list, choose **Yes** for the DPM to set the output actions for all the auxiliary PEs to **MAP** when the **Output Mode** is set to **Transcode**. If the **Enable Fixed Table Output** is set to **Yes**, the output configuration for the auxiliary PEs is determined by the fixed output table options when you resynchronize the output channels and PIDs to match the input programs.

Note: The DPM resolves any output conflicts automatically, even if the **Enable Auto Fix for Collision** is set to **No**.

- 5 Click **Apply**.

Setting the Maximum and Minimum Transport Packets

The maximum and minimum transport packets are set in the **Limits** area of the MPEG over IP Output page.

- 1 In the **Maximum Transport Packets/Ethernet Frame** field, enter the maximum number of transport packets per IP packet (1 to 7).
- 2 In the **Minimum number Packets/Second** field, enter the minimum number of transport packets per IP packet. You can enter 0 or 2 to 1000.

Configuring MPEG over IP Streams

- 1 In the MPEG over IP Output page (**Transport Stream > MPEG over IP Output**), click **Stream**. The MPEG over IP Output Stream page is displayed.

The screenshot shows the Cisco D9859 Advanced Receiver Transcoder web interface. The main content area is titled "MPEG over IP Output" and has a "Stream" tab selected. Below the tab is an "Edit" button and a table with the following data:

Stream	Bitrate (Mbps)	Encapsulation	Destination IP	Destination UDP Port
<input type="radio"/> MPTS	68.5	UDP	225.1.1.1	49152

Below the table is an "Advanced" section with a "Stream Details" button and a note: "Note: Consult [IP Unicast Routing page](#) for the list of installed routes." At the bottom of the main content area is a "MoIP Output Status" section with the following data:

MoIP Output Status	Value	MoIP Output Status	Value
Critical MoIP Engine Error	No	Combined User Rate (Mbps)	0.0
MoIP TS Overflow	No	Actual Rate - Control Port (Mbps)	0.0
		Actual Rate - Data Port (Mbps)	0.0

At the bottom of the page, there are buttons for "Apply", "Refresh", and "Cancel". The footer of the interface shows "© 2008-2013 Cisco Systems Inc. All rights reserved" and a status bar with "0 Alarms", "1 Warnings", and "154 Clear".

The following table describes the stream information:

Stream Details	Description
Stream	Type of stream (MPTS).
Bitrate (Mbps)	This is the bit rate of the stream, in Mbps.
Encapsulation	Selects the transport protocol to use for the output stream (UDP or RTP).
Destination IP	Enter the unicast (valid host IP only) or multicast destination IP address.
Destination UDP Port	This selects the destination port number (1 to 65534). Note: If you selected RTP for Encapsulation , you must select an even destination port number.

- 2 To modify the stream information, select the stream and click **Edit**.
- 3 Make the necessary changes and click **Save**.
- 4 To configure MPTS advanced settings, select the stream and click **Advanced**.

The following table describes the MPTS advanced settings:

Advanced Settings	Description
Traffic Class	Sets the quality of service (0 to 255).
Time to Live (Max #hops)	This sets the hop limit of the packet's lifespan (0 to 255).
Source UDP Port	This sets the source UDP port number (0 to 65535). Note: Set the Source UDP Port to 0 to use the default UDP port (49162).
Announce Type	Select RFC 2327 to send the Session Announcement Protocol (SAP) messages according to the RFC 2327 standard. Otherwise, select None to not send SAP messages.
Announce Title Source	Select User String to use the SAP string as the channel name, defined in the Announce User's Title below. Otherwise, select SDT channel to use the SDT string as the channel name.
Announce User's Title	If User String is selected as the Announce Title Source , enter the SAP identifier (ID)/string, up to 31 characters.

- 5 Click **OK**.

Viewing Stream Details

To view the stream details, click **Stream Details** in the MPEG over IP Output **Main** or **Stream** page. The following Stream Status table is displayed.

PE	Control Port	Data Port	Content Overflow	Link Overflow
1	Stopped	Stopped	No	No

The **Stream Status** table displays the status of the streams for the control and data ports.

Viewing the MPEG over IP Output Status

The **MOIP Output Status** area (MPEG over IP Output Main and Stream pages) displays the current output bit rates for the control port and data port (0 to 206 Mbps), the configured user rate, MPEG over IP TS overflow status, and whether there are critical MPEG over IP engine errors.

MoIP Output Status

Critical MoIP Engine Error	No	Combined User Rate (Mbps)	120.0
MoIP TS Overflow	No	Actual Rate - Control Port (Mbps)	0.0
		Actual Rate - Data Port (Mbps)	0.0

Apply Refresh Cancel

Configuring the DPM MPEGoIP Output Details

Note: The following procedure defines all the available fields. For a typical setup of the DPM, see *Typical set up for Digital Program Mapping (DPM)* (on page 210).

Note: After you make any changes, a successfully updated (session open) message appears. The changes are displayed, but not saved. You must click **Apply** to save and apply the changes.

- 1 From the user interface of the D9859, choose **Transport Stream > Digital Program Mapping** under **MPEG over IP Output**. The MPEGoIP Digital Program Mapping page is displayed.

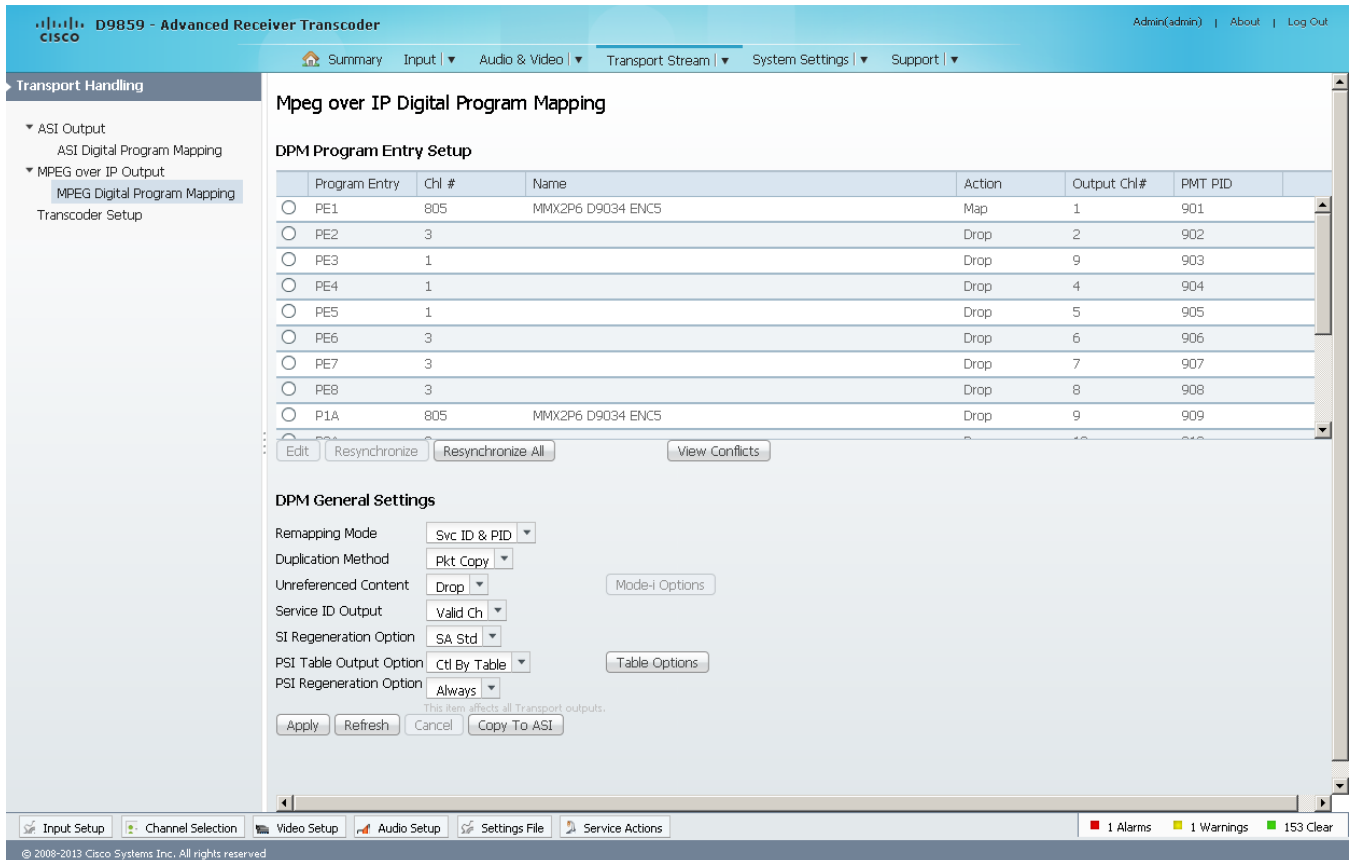

- 2 For each **DPM Program Entry**, it displays the input channel number (**Chl #**) and channel **Name**.

There are eight channels (PE1 to PE8), with eight auxiliary channels (PE1A to PE8A). The auxiliary channels automatically tune to the corresponding PE channels. If the PE is not transcoded, the auxiliary PE is dropped.

Note: Any changes made to the MOIP DPM values will automatically changes the **Mode Status** to **Edited by User** in the MPEG over IP Output page.

- 3 Click the radio button of the program entry you want to edit.

If you want to configure an auxiliary PE, it is highly recommended that you perform the following:

- From the **Enable Auto Map For Auxiliary PEs** drop-down list, choose **Yes** in the ASI Outputs page.
- Set PxA to **Map**.
- Click **Resynchronize All** to ensure that the inputs and outputs are the same.

- 4 From the **Action** drop-down list, choose the DPM program action for the PE (Pass, Map, or Drop). The default is **Pass**.

- Click **Edit**. The DPM PE PID MAP window opens.

- In the **Output Channel Number** field, enter the output channel number you want to map to the input channel (**Input Channel #**). This value is only used if the PE **Action** was set to Map. You can enter a range from 1 to 65535.
- In the **Output PMT PID** field, enter the output PMT PID number you want to map to the Input PMT PID.
- In the **PE PID MAP** area, you can select an existing PID mapping entry you want to modify or click **Add Row** to create a new entry.
- The **Input Stream** indicates the input program stream category/service type. The **Input PID** displays the input program PID (1 to 8190). It is only used if the PID Action is set to Map.
- From the **Action** drop-down list, choose the DPM action for the PID associated with the PE.

Action	Description
Drop	Removes the service and its associated PMT reference from the transport output.
Map	Provides the flexibility to define all the outgoing PID numbers for a PE, including those not currently on transmission.

- In the **Stream Type** field, enter the stream type to map within a PE to a specified PID (0 to 255).
- From the **Category** drop-down list, choose the output program stream category or service type. This value is only used if the Action is set to Map. The categories are: UNKN, CDT, LSDT, DATA, TTX, MPE, DPI, VBI, SUBT, AUD, VID, PCR or INVL.
- In the **Instance** and **Output PID** fields, enter the output stream instance (1 to 64) and the output program PID (0 to 8192).

- 14 To remove a PID mapping, click the radio button of the entry you want to remove and click **Delete**.
- 15 Click **OK**.
- 16 In the **DPM Program Entry Setup** area, each PE output can be synchronized to its input according to one of the four output modes. Click the radio button of the program entry you want to synchronize and then click **Resynchronize** or click **Resynchronize All** to synchronize all the listed PE outputs to its inputs. The **Confirm Resynchronization** window is displayed.

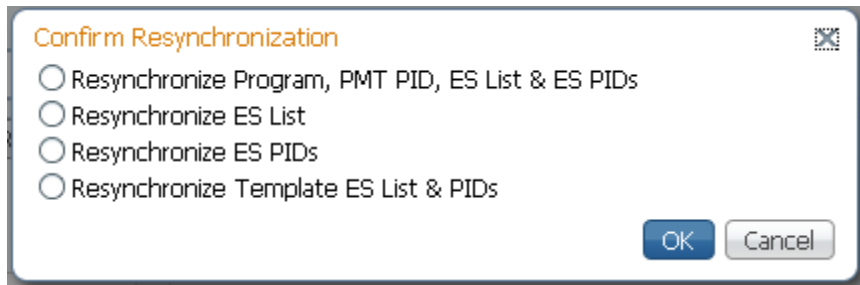

- 17 Select whether you want to synchronize services and PIDs, services only, PIDs only, or to synchronize using a template.

Map Mode	Description
Resynchronize Program, PMT PID, ES List & ES PIDs	The transcoder will synchronize the PE output according to the services and then the PIDs assigned to each service.
Resynchronize ES List	The transcoder will synchronize the PE output according to the available input services only, and ignore the input to output service PID mapping.
Resynchronize ES PIDs	The transcoder will synchronize the PE output according to the input PIDs only, and ignore the service assignment categories/names.
Resynchronize Template ES List & PIDs	Allows you to preset the input to output mapping of a PE according to the preset template. This is helpful in pre-configuring any number of PEs for future use.

- 18 Click **OK**.

If a conflict occurs, a message that the conflicts will be fixed automatically and to preview the changes prior to saving is displayed. Click **View Conflicts** to view a detailed list of all the conflicts in the **Output Channel and PID Conflicts** window.

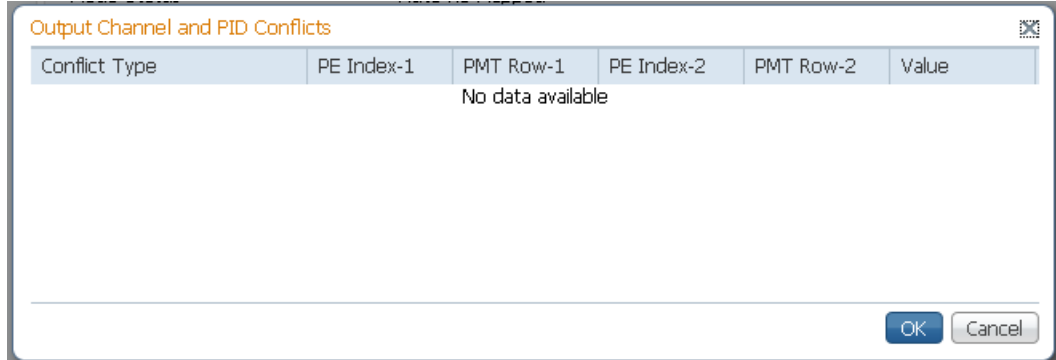

- For channel conflicts, the system will only automatically change the duplicated output channel numbers. If both PE actions are set to **Map** or **XCode**, the output channel number of the higher PE is changed. Otherwise, the output channel number of the mapped and transcoded PE is changed. The new channel number selected is the next channel number that does not appear in the current PAT or belong to any other PEs.
- For PID conflicts, the system will only automatically change the duplicated output PID numbers. If both PE actions are set to **Map** or **XCode**, the output PID number of the higher PE is changed. Otherwise, the output PID number of the mapped or transcoded PE is changed. For example, if the PMT PID of PE1 matches the ES PID of PE2, the ES PID of PE2 is changed. The new PID number selected is the next number that does not appear in the output of any PE and it is not in the current transport input.

Click **Apply** to save the resolved conflict changes.

Setting the DPM General Settings

- 1 In the **DPM General Settings** area, you can configure MPEGoIP DPM transport stream settings.
- 2 From the Remapping Mode drop-down list, choose the DPM map mode. The following table describes each mode:

Map Mode	Description
Svc ID	The elementary PIDs are not changed. Channels are remapped by changing their PSI references. When this mode is selected, PE detailed PID mapping cannot be edited.
Svc ID & PID	Channels and the elementary service PIDs can be mapped.

- 3 From the **Duplication Method** drop-down list, choose the duplication method of the DPM program, which modifies the PSI to duplicate a program and its content. This parameter is only used if Remapping Mode is set to Svc ID & PID. The following table describes the each duplication method:

Duplic Mode	Description
PSI Remap	Every input PID can be mapped to one output PID. If PID mapping conflicts exist, DPM will use the Precedence Rule to decide which output PID to use. All PMTs using the input PID will be updated to reference the output PID specified by the winner.
Pkt Copy	An input PID can be mapped to multiple output PIDs. The PID will be duplicated as many times as needed (up to a certain hardware limitation).

Pkt Copy is recommended for most applications.

- 4 Select the DPM action to use for **Unreferenced Content**. Unreferenced content is the remainder of the transport that is not filtered by the program entries. Select Drop (default) to drop all unreferenced content. Select Pass to pass all unreferenced content to the output unchanged.
- 5 From the **Service ID Output** drop-down list, choose whether the transcoder should always generate PSI tables for the Mapped PE even if the selected input channel is not available, or for only valid service channels/IDs. The following table describes each service ID:

Svc ID	Description
Valid Ch	Only transmits the PSI tables for the mapped program if the program exists on the input stream.
All Ch	Transmits the PSI tables for the mapped program even if the program does not exist in the input stream. All Ch is only valid if the PAT, NIT, SDT and PMT are set to Regenerate.

- 6 From the **SI Regeneration Option** drop-down list, choose the SI regeneration option that applies the PowerVu rates (consistent with the uplink). This parameter is only used if Remapping Control is set to None. The following table describes each PSI rate:

PSI Rate	Description
Auto	Matches the generated PSI tables' output rate as the incoming rate.
MPEG Min	Transmits the generated PSI tables on the longest intervals that are allowed by MPEG standard.
SA Std	Transmits the generated PSI tables based on PowerVu standard intervals.

- 7 From the **PSI Table Output Option** drop-down list, choose which PSI tables to include in the program/output stream. The following table describes each option:

PSI Options	Description
Pass All	Transmits the incoming PSI Tables as is; does not modify the content and rate.
Drop All	Does not transmit any PSI Tables.
Ctl By Table	The operator can click Table Options to select the output mode for each table. The default table selections will be all pass, and only with CDT dropped.

- 8 From the **PSI Regeneration Option** drop-down list, choose whether to regenerate the PSI tables. You can select Always or As Needed (only if the content has changed).
- 9 If Ctl By Table was selected as the **PSI Table Output Option**, click **Table Options** to configure the DPM table options. The DPM Table Options (MOIP) window is displayed.

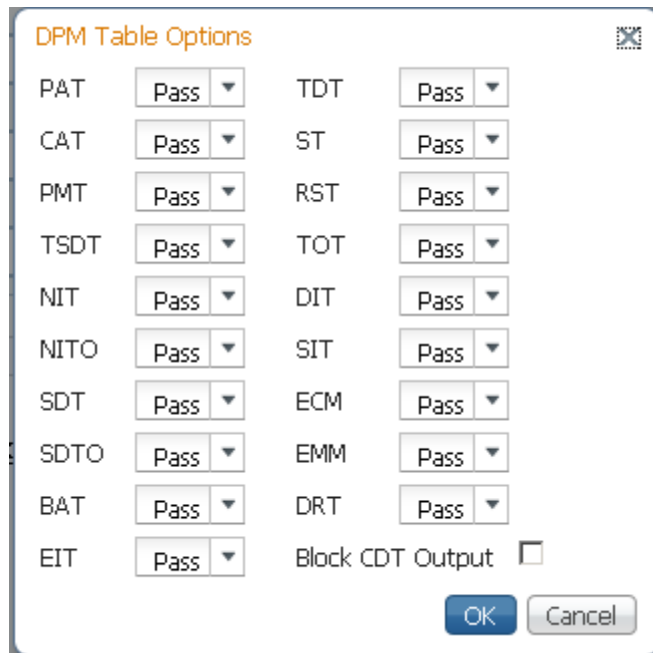

- 10 Choose the tables which will be passed, dropped, regenerated or passed with rate control (PwRC) from the ASI Output. For more information on the table options, see *PSI Table Settings* (on page 105).

The CDT is different from the other tables listed because the CDT is referred to within the PMT, rather than outside the PMT. Check the **Block CDT Output** check box to override the DPM PID map configuration for CDT PIDs and to always drop all CDTs. Otherwise, uncheck the **Block CDT Output** to permit the output of CDTs following the configured DPM PID map configuration and all other DPM constraints.

- 11 Click **OK**.
- 12 Click **Apply**.
- 13 Click **Copy To ASI** to copy all the DPM data from the MPEG over IP output to the ASI output.

Viewing the MPEG Output Transport Status

From the user interface of the D9859, choose **Transport Stream > Output Transport Status** under **MPEG over IP Output**. The PID Output Status page is displayed.

The screenshot shows the Cisco D9859 Web GUI interface. The main content area is titled "PID Output Status". Below this title is a section for "Program Entry - Referenced PIDs" which contains a table with the following data:

PE Index	Type	Input PID	Output PID	PCR	Output Scrambled	Input Recieved
1	VBI	0	102	No	No	No
1	SUBT	0	103	No	No	No
1	AUD	0	104	No	No	No
1	AUD	0	105	No	No	No
1	VID	2548	101	Yes	No	Yes

Below the table is a section for "Current DPM Collisions" and another for "Output Channel and PID Conflicts". The "Output Channel and PID Conflicts" table is currently empty, displaying "No data available".

At the bottom of the page, there is a status bar showing "0 Alarms", "1 Warnings", and "154 Clear".

The **Program Entry - Referenced PIDs** table displays the specified PE ES PIDs information on the output.

The **Output Channel and PID Conflicts** table displays a list of conflicts when the DPM alarm is active.

Typical set up for Digital Program Mapping (DPM)

- 1 Verify that you are receiving a valid signal and that you have set up the channels that you want to pass, drop, or map.
- 2 From the user interface of the D9859, choose **Transport Stream > ASI Output** or **MPEG over IP Output**.
- 3 From the **Output Mode** drop-down list, choose **Full DPM Control**.

- 4 If necessary, select the **Descrambled** mode according to whether the program is to be scrambled or descrambled for downstream viewing or monitoring.
- 5 Click **Apply**.
- 6 Choose **Transport Stream > Digital Program Mapping for ASI Output** or **MPEG over IP Output**. The ASI or MPEGoIP Digital Program Mapping page is displayed.
- 7 In the DPM Program Entry Setup, click **Resynchronize All** and select **Resynchronize Program, PMT PID, ES List & ES PIDs** and click **OK**. This copies the input services PIDs to the remapped output service PIDs.
- 8 In the **DPM Program Entry Setup** table, select the PE containing the channel you want to configure and click **Edit**. The DPM PE PID MAP window is displayed.
- 9 From the **Action** drop-down list for an input stream, choose **Drop** or **Map**.
- 10 Configure the input to output channel mapping from the **Category** drop-down list. Video and PCR can be output on the same PID or different PIDs. If output on the same PID, they will appear identical to the input.
- 11 Click **Save**.
- 12 Click **OK**.
- 13 In the **DPM General Settings** section, set the following parameters:

Parameter	Description
Remapping Mode	Svc ID & PID
Duplication Method	Pkt Copy
Unreferenced Content	Drop
Service ID Output	Valid Ch/All Ch
PSI Table Output Option	Ctl By Table
PSI Regeneration Option	Always/As Needed

- 14 Click **Table Options**. The DPM Table Options (ASI) window is displayed.
- 15 Set the following parameters:

Parameter	Description
PAT	Regen
CAT	Regen
PMT	Regen
TSDT	Drop
NIT	Regen or Drop
NITO	Drop
SDT	Regen

Chapter 5 Web GUI Setup and Monitoring

Parameter	Description
SDTO	Drop
BAT	Drop
EIT	Drop
TDT	Pass
RST	Pass
TOT	Pass
DIT	Pass
SIT	Pass
ECM	Drop
EMM	Drop
DRT	Drop

- 16 Check the **Block CDT Output** check box.
- 17 Click **OK**.
- 18 Click **Apply**.

Setting up Default Settings for the Transcoder

- 1 From the user interface of the D9859, choose **Transport Stream > Transcoder Setup**. The Transcoder Setup page is displayed.

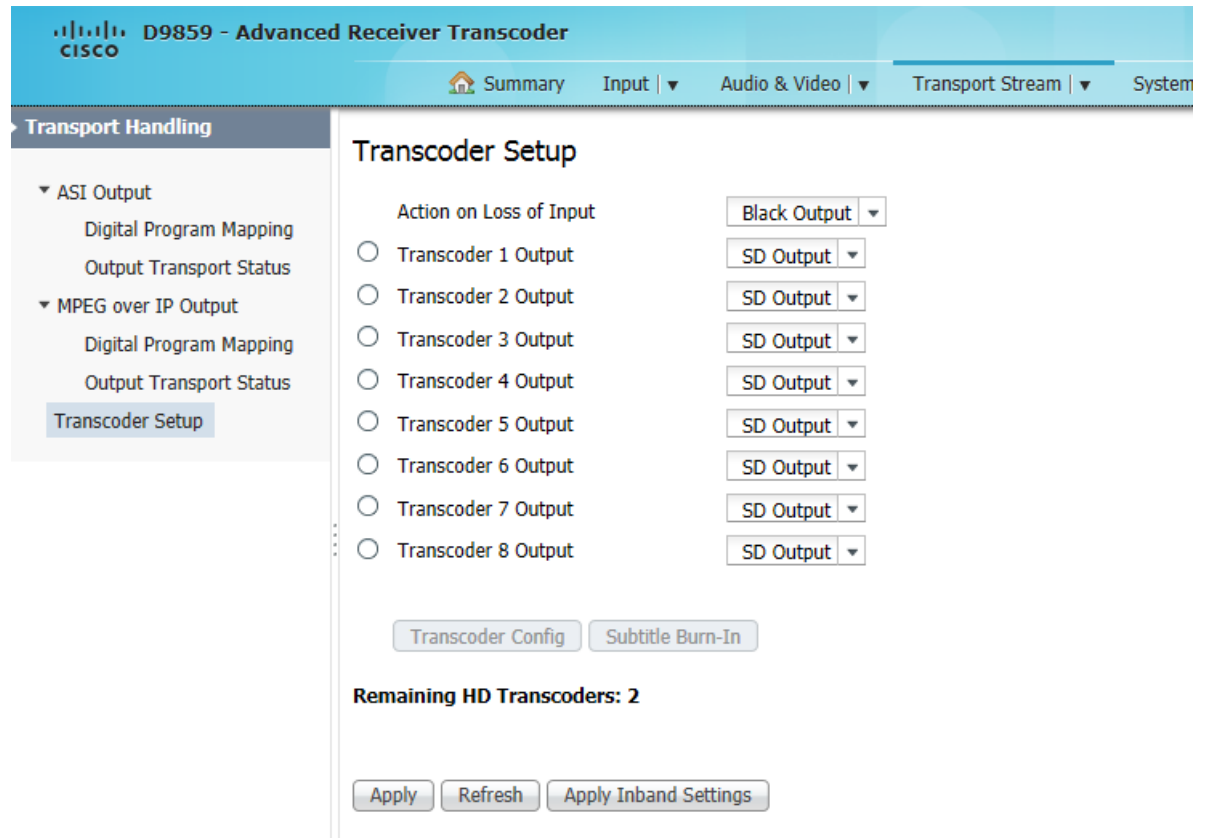

Note: Subtitle Burn-In is not supported.

- 2 From the **Action on Loss of Input** drop-down list, choose the transcoder action on loss of input, which is the action that the transcoder takes when there is a loss of input signal (No Output or Black Output).
- 3 Click the **Transcoder 1 Output** to **Transcoder 8 Output** radio buttons to select the transcode channel video mode. The selections are Auto, HD Output, and SD Output.

Setting	Description
Auto	Leaves the input video format and resolution unchanged. That is, SD in - SD out, HD in - HD out.

Setting	Description
SD Output	Down-converts from HD to SD when receiving an HD input signal. SD horizontal resolution will follow the HRes parameter set in the SD Settings column of the Transcoder Settings window (click Transcoder Config).
HD Output	Up-converts from SD to HD1080i when receiving an SD input signal. HD horizontal resolution will follow the HRes parameter set in the HD Settings column of the Transcoder Settings window (click Transcoder Config).

- The **Remaining Transcoders** field displays the remaining HD or SD licenses available to transcode on the unit. The number of resources available is updated automatically when you choose **HD Output** or **SD Output** as the **Transcoder Output**.

Configuring Transcoder Settings

Select the channel you want to configure settings and click **Transcoder Config**. The Transcoder Settings window is displayed.

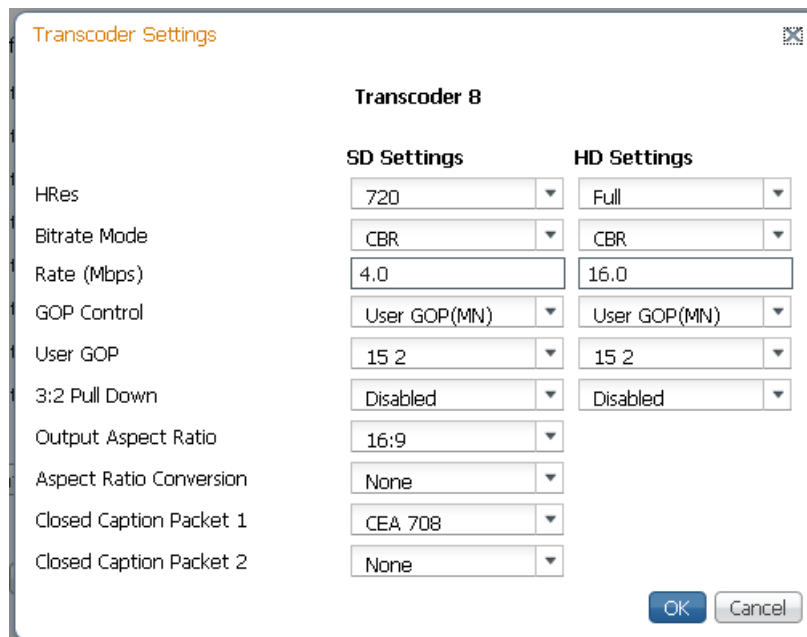

If the selected channel is set to HD Output, proceed as follows:

- In the **HD Settings** column, choose the transcode channel HD horizontal output video resolution from the **HRes** drop-down list. You can select Full or 3/4. The following table displays the settings:

Configuring Transport Stream Information

Setting	Description	
	Input Resolution	Output Resolution
Full	1080i	1920
3/4	1080i	1440
Full	720p	1280
3/4	720p	960

- 2 From the **Bitrate Mode** drop-down list, choose the transcode channel output bitrate mode. You can select VBR or CBR.
- 3 In the **Rate** field, enter the HD rate that sets the transcode channel output bit rate when HD MPEG-4/AVC to HD MPEG-2 transcoding is selected. The range is from 8 to 25 Mb/s in 400 b/s increments.
- 4 From the **GOP Control** drop-down list, choose the Transcode Group of Pictures (GOP) format. The options are User Gop (MN) or I Frame Sync.
- 5 From the **User GOP** drop-down list, choose the transcode manual GOP format value. The transcoder attempts to reuse information from the encoded bit stream to improve the video quality of the transcoded stream. Amongst others, if the incoming GOP structure is similar to that of an MPEG-2, it will reuse the frame allocations from the incoming stream as long as GOP Control is set to I Frame Sync. If the downstream transcoder does not support altering GOP structures, set the GOP Control setting to User GOP (MN). This will also require the setting of the GOP structure which is given as two numbers, where the first is the length of the GOP and the second is the number of B-pictures per sub-GOP. The supported GOP structures are 1.0, 12.2, 15.2, 24.2 and 30.2.
- 6 From the **3:2 Pulldown** drop-down list, choose **Enabled** or **Disabled** to enable or disable the 3:2 Pulldown.
- 7 Click **OK**.

If the select channel is set to SD Output, proceed as follows:

- 1 In the **SD Settings** area, select the transcode channel SD horizontal output video resolution from the **HRes** drop-down list. The parameters are 352, 480, 528, 544, 704 or 720.
- 2 From the **Bitrate Mode** drop-down list, choose the transcode channel output bitrate mode. You can select VBR or CBR.
- 3 In the **Rate (Mbps)** field, enter the transcode channel output bit rate when HD to SD transcoding is selected for the output channel. You can enter a range from 2 to 15 Mb/s, in 400 b/s increments.
- 4 From the **GOP Control** drop-down list, choose the Transcode Group of Pictures (GOP) format. The options are User Gop (MN) or I Frame Sync.

- 5 From the **User GOP** drop-down list, choose the transcode manual GOP format value. The transcoder attempts to reuse information from the encoded bit stream to improve the video quality of the transcoded stream. Amongst others, if the incoming GOP structure is similar to that of an MPEG-2, it will reuse the frame allocations from the incoming stream as long as GOP Control is set to I Frame Sync. If the downstream transcoder does not support altering GOP structures, set the GOP Control setting to User GOP (MN). This will also require the setting of the GOP structure which is given as two numbers, where the first is the length of the GOP and the second is the number of B-pictures per sub-GOP. The supported GOP structures are 1.0, 12.2, 15.2, 24.2 and 30.2.
- 6 From the **3:2 Pulldown** drop-down list, choose Enabled or Disabled to enable or disable the 3:2 Pulldown.
- 7 From the **Output Aspect Ratio** drop-down list, choose the aspect ratio for the SD transcode output channel. The options are 4:3 and 16:9 (wide aspect ratio). The default is 4:3. Set it to the corresponding value.
- 8 From the **Aspect Ratio Conversion** drop-down list, choose the SD transcode channel aspect ratio conversion. This is the conversion that the transcoder will perform on the output signal for the picture to be displayed correctly (i.e., to correspond to the aspect ratio of your TV) on your TV, based on your selection. The options are: Auto, None, 16:9 L/B (letter box), 4:3 CCO, 14:9, 4:3 P/B (pillar box), 16:9 SCALE, or Auto AFD (Auto setting using Active Format Descriptor). The default is set to Auto.
- 9 From the **Closed Caption Packet 1** and **Closed Caption Packet 2** drop-down lists, choose the order to output the closed caption packets on the transcoded SD output. The options are None, SCTE-20, or CEA 708.
- 10 Click **OK**.

Applying Inband Settings

Note: The Apply Inband Settings is not supported in the current release. You can apply the inband settings using the front panel. For more information, see *Inband* (on page 112).

Configuring Transport Stream Information

- 1 Click **Apply Inband Setting** to apply the uplink parameters for transcoding, such as bit rate, GOP and resolution, to the local transcoder settings for the selected program entry. This is only supported with an uplink that uses uplink transcoding controls for the user address of the selected program entry. The Apply Inband Settings window is displayed.

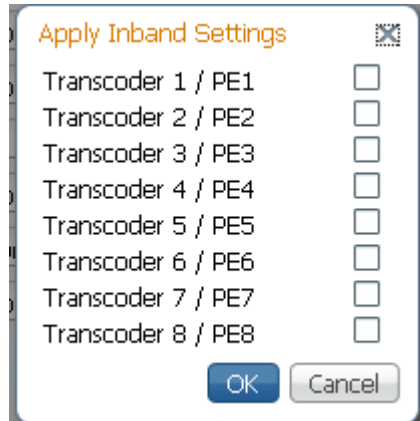

- 2 Check a transcoder/program entry check box.
- 3 Click **OK**.

Configuring System Settings

Viewing the System Identification

- 1 From the user interface of the D9859, choose **System Settings > System**. The Identification page is displayed.

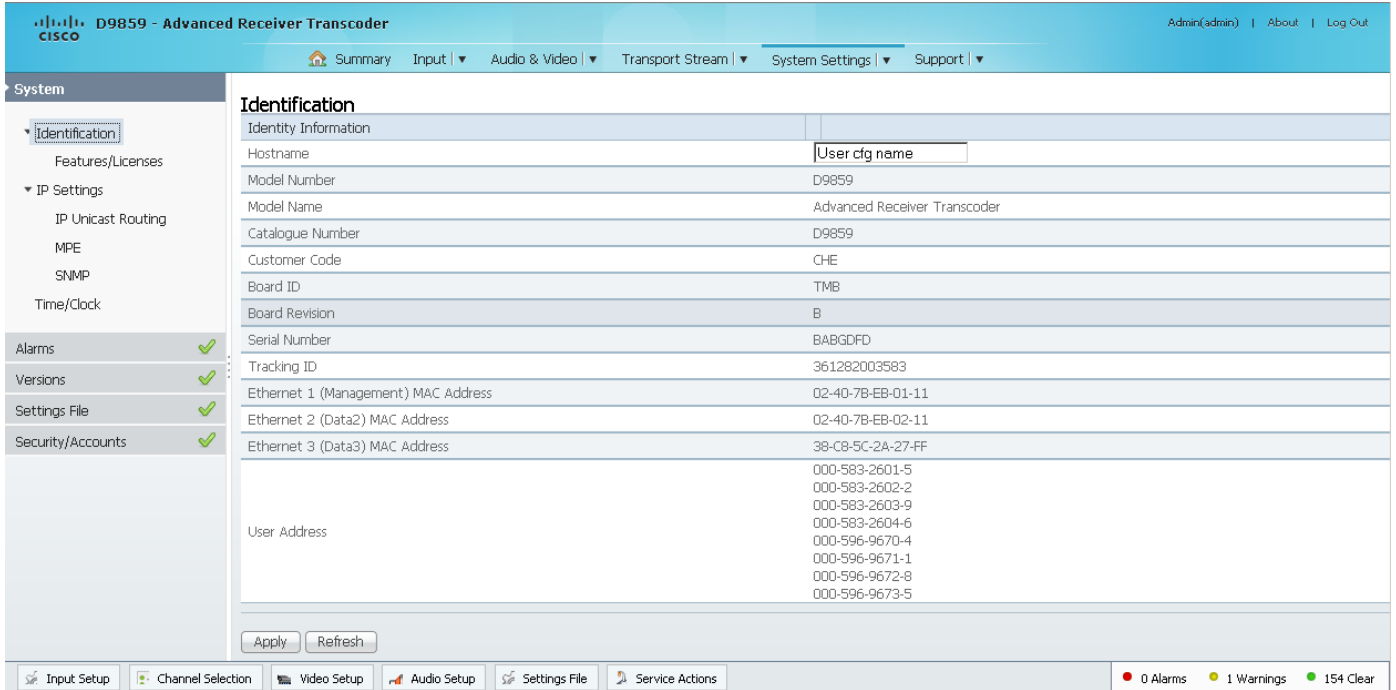

- 2 The System Identification page displays the parameters associated with the D9859 system, such as serial number, model number, and user addresses.
- 3 You may optionally change the **Hostname** (device name) and click **Apply**.

Viewing Hardware Features and Base License Information

From the user interface of the D9859, choose **System Settings > Identification > Features/Licenses**. The Features/Licenses page is displayed.

The screenshot shows the Cisco D9859 Advanced Receiver Transcoder web interface. The breadcrumb navigation is **System Settings > Identification > Features/Licenses**. The left sidebar shows the navigation menu with **Features/Licenses** selected under the **Identification** section. The main content area is titled **Features/Licenses** and contains two tables.

Hardware Features

Feature	Present (Stuffed)
SDI	No
MPOIP	Yes
Eth Filter	No
Number of SAT	0
Dolby-E	No
SFN	No

Feature License Summary

Feature	Enabled
HD Transcode License C...	8
SD Transcode License C...	0

The **Hardware Features** area displays the hardware options installed in the current D9859 Advanced Receiver Transcoder. For example, it indicates whether the transcoder is equipped with an SDI output and the number of transcoding paths.

The **Feature License Summary** area displays the total number of PEs for HD and/or SD transcode. The **HD Transcode License Count** displays the number of program entries that can transcode both SD and HD. The **SD Transcode License Count** displays the number of program entries that can transcode SD only.

For example, a fully licensed D9859 Advanced Receiver Transcoder (with additional 6 SD and 7 HD upgrades) is displayed as follows:

HD Transcode License Count: 8

SD Transcode License Count: 0

Note: If an asterisk (*) appears next to the license count, it indicates that the unit is currently processing a license file.

Setting up IP Information

- 1 From the user interface of the D9859, choose **System Settings > IP Settings**. The IP Settings page is displayed.

The screenshot shows the Cisco D9859 Advanced Receiver Transcoder web GUI. The main content area is titled "IP Settings" and contains several sections:

- IP Settings Table:**

Port ID	Destination IP Address	Mask	Gateway Address	PHY Mode
<input type="radio"/> control	10.85.162.86	22	10.85.160.1	Auto
<input type="radio"/> data	192.131.244.20	24	192.131.244.254	Auto
<input type="radio"/> Statmux	192.168.0.100	24	192.168.0.254	Auto
- Protocol Control:**
 - Telnet:
 - SSH:
 - HTTP:
 - Syslog:
 - Syslog Server IP Address:
 - SNMP:
 - Idle Timeout (seconds):
 - Syslog Server Port:
- Redundancy Control:**
 - Mode:
 - Direction:
 - Delay Forward (ms):
 - Delay Back (seconds):
- Redundancy Status Table:**

Ports In Use	Change Reason	Change Date & Time
None	Setup+Link	2007/02/09 10:00:01
- Link Status Table:**

Port ID	Link Status	Link Speed	Link Duplex	Link Crossover
1	Link Up	1 Gbps	Full	MDI
2	Link Down	N/A	N/A	N/A

At the bottom of the page, there are "Apply" and "Refresh" buttons. The status bar at the very bottom shows "0 Alarms", "2 Warnings", and "153 Clear".

Note: The D9859 transcoder is a single data port unit. The **Redundancy Control** and **Redundancy Status** sections are not supported.

- 2 In the IP Settings table, you can set the parameters for communicating with other equipment via the Ethernet Data and Management ports for IP applications and upgrading application software.
- 3 Click the **control** or **data** radio button to edit the control or data settings and set the IPv4 **Destination IP Address** for the interface. The address is 12 digits in length (###.###.###.###). The **Statmux** port is not supported.
- 4 Set the number of CIDR (Classless Inter-Domain Routing) bits in the network **Mask** (8 to 30).

- 5 In the **Gateway Address** field, enter the gateway IP address on the Network, used to expose the transcoder to a WAN. The IP Address, IP Mask, and Gateway Address should be changed together, that is, as a group. The following table shows the most commonly used Subnet mask values to enter for a chosen IP address mask, which will depend on the size of your network.

Mask	Subnet Mask
8	255.0.0.0
16	255.255.0.0
24	255.255.255.0

- 6 From the **PHY Mode** drop-down list, choose the speed and duplex type of the interface. Choose **Auto** for PHY to negotiate speed and duplex with other devices on the network, or select 10 HD (half-duplex), 10 FD (full-duplex), 100 HD, 100 FD, or 1000 FD to lock into a fixed mode. Otherwise, choose **N/A**. The default is **Auto**.
- 7 Click **Save**.

Protocol Control Settings

The **Protocol Control** area allows you to control remote access protocols to the IRD (Telnet, SSH, HTTP, HTTPS (via HTTP secure setting), and SNMP).

- 1 From the **Telnet, SSH, HTTP, and SNMP** drop-down list, choose **Enable** (default) to allow Telnet, Secure Shell, HTTP, and/or SNMP connections. Otherwise, choose **Disable**.

The following lists the associated port numbers for each protocol:

Protocol	Port Number
Telnet	TCP port #23
SSH	TCP port #22
HTTP	TCP port #80
HTTPS (via HTTP secure setting)	TCP port #443
SNMP	UDP port #161

For information on accessing TCP/IP services, see *Accessing TCP and UDP Services* (on page 74).

The HTTP has an additional **Secure** setting for an encrypted access to the webserver (HTTPS).

- a From the **HTTP** drop-down list, choose **Secure**. A confirmation message that you will be logged out automatically is displayed.

- b Click **OK** to confirm. It will reconfigure the device and the next time you log in, you will be accessing the encrypted version (HTTPS). A untrusted connection warning message is displayed (first time only). The following is an example:

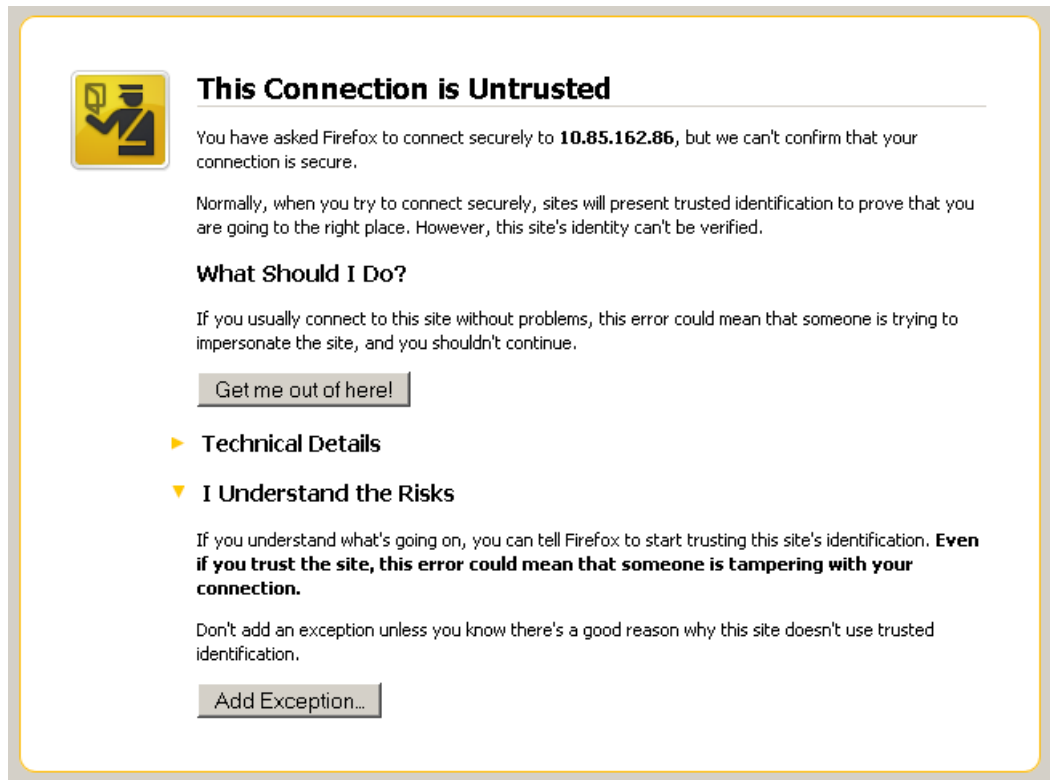

- c Add the current address as an exception and you can access the D9859 web GUI.

Note: The HTTPS is displayed in the IP address to denote that it is a secure access. The following is an example:



- 2 In the **Idle Timeout (seconds)** field, enter the number of seconds before the session for all the enabled protocols will timeout due to inactivity.
- 3 Click **Apply**.

System Logs

From the Syslog drop-down list, choose the logging protocol to use (**Syslog TCP** or **Syslog UDP**). The **Legacy** option is used by Cisco customer support only. Choose **Disable** to disable system logging.

If **Syslog TCP** or **Syslog UDP** is selected, set the IP address of the server in the **Syslog Server IP Address** field and the server UDP or TCP port number in the **Syslog Server Port** field. The address is 12 digits in length (**###.###.###.###**), in the range from 0 to 255.

We highly recommended that you use the following syslog servers:

- Syslog-ng - Balabit for Linux (<http://www.balabit.com/network-security/syslog-ng/opensource-logging-system>)
- Syslog Watcher - SnmpSoft for Windows (<http://www.snmpsoft.com/downloads.html>)

The following is an example of a syslog:

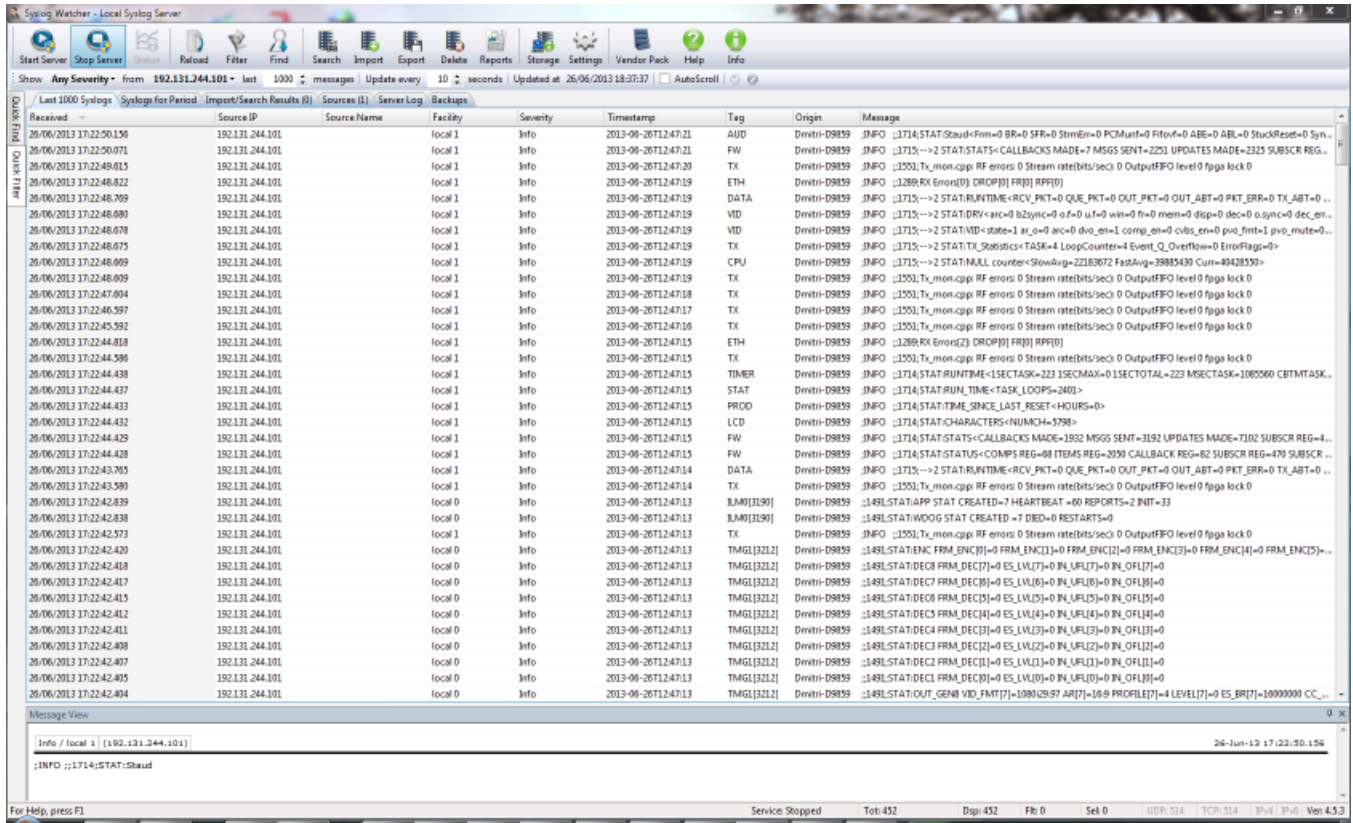

Viewing the Link Status

The Link Status table displays the port information, such as the status, speed, duplex and crossover. Port 1 is the management port and port 2 is the data port.

Setting up IP Routing Information

- 1 From the user interface of the D9859, choose **System Settings > IP Settings > IP Unicast Routing**. The IP Unicast Routing page is displayed.

The screenshot shows the Cisco D9859 Advanced Receiver Transcoder web GUI. The main content area is titled "IP Unicast Routing". Under "RIP", there is a dropdown menu set to "Enable". Below that is the "Static Unicast Routing" section, which contains a table with columns for "Destination IP Address", "Mask", "Gateway Address", "Port 1", and "Port 2". The table is currently empty with the text "No data available". Below this is the "Installed Unicast Routes" section, which contains a table with columns for "Port ID", "Destination IP Address", "Mask", "Gateway Address", "MTU", "Hops", and "TTL (ms)". The table contains three rows of data:

Port ID	Destination IP Address	Mask	Gateway Address	MTU	Hops	TTL (ms)
1	0.0.0.0	0	10.85.160.1	1500	255	0
1	10.85.160.0	22	10.85.162.86	1500	0	0
3	169.254.0.0	16	169.254.10.1	1500	0	0

At the bottom of the "Installed Unicast Routes" section, there are "Apply" and "Refresh" buttons. The bottom status bar shows "1 Alarms", "1 Warnings", and "153 Clear".

- 2 From the **RIP** drop-down list, choose **Enable** to enable the Routing Information Protocol (RIP). Otherwise, choose **Disable**. This is a standard protocol for automatic unicast route discovery. If enabled, the routing information is displayed in the **Installed Unicast Routes** table.
- 3 Click **Apply**.
- 4 In the **Static Unicast Routing** table, you can set the static unicast routing information used to by MPEGoIP and MPE outputs to send data packets. It can also be used to find hosts behind a router (for example, an FTP server, a syslog server, or an NTP server).

To add a unicast route:

- a Click **Add Row**.
- b In the **Destination IP Address** field, enter the IP address that sets the destination for the unicast route. You can enter up to 12 characters (for example, 155.128.100.200).
- c In the **Mask** field, enter the number of CIDR (Classless Inter-Domain Routing) bits in the network mask (8 to 30).

- d In the **Gateway Address** field, enter the gateway IP address on the Network, used to expose the transcoder to a WAN. The following table shows the most commonly used Subnet mask values to enter for a chosen IP address mask, which will depend on the size of your network.

Mask	Subnet Mask
8	255.0.0.0
16	255.255.0.0
24	255.255.255.0

- e Check the **Port 1** and/or **Port 2** check box. The management port is port 1 and the data port is port 2.
- f Click **Save**. The routing information is displayed in the **Installed Unicast Routes** table. If the configured routing information has an inactive port, then the routing information is not displayed in the **Installed Unicast Routes** table.

Configuring the MPE Settings

- 1 From the user interface of the D9859, choose **System Settings > IP Settings > MPE**. The MPE page is displayed.

The screenshot shows the Cisco D9859 Advanced Receiver Transcoder web GUI. The main content area is titled "MPE". Under "MPE Data Filter Mode", there is a dropdown menu currently set to "Fwd Filtered". Below this is a section titled "Static Multicast Filtering" which includes a table of "Multicast Filter Addresses". The table has five rows, each with a radio button and an IP address: 224.1.1.1, 224.254.245.233, 225.1.1.1, 225.2.2.2, and 225.3.3.3. Below the table is a note: "Note: Consult [IP Unicast Routing page](#) for the list of installed routes." At the bottom of the table are "Apply" and "Refresh" buttons.

- 2 From the **MPE Data Filter Mode** drop-down list, choose whether the MPE data is forwarded to the network (Forward None, Forward All, or Forward Filtered). Choose **Forward None** to not forward MPE data to the network. Choose **Forward All** to forward all the MPE data to the network. Choose **Forward Filtered** to only forward the MPE data from the defined Static Multicast Filtering table below to the network. For more information on configuring the Static Multicast Filtering table, see *To Add a Static Multicast Filtering* (on page 227).
Note: The transcoder supports up to a maximum of 10 Mbps throughput when forwarding 1500 byte packets.
- 3 Click **Apply**.

To Add a Static Multicast Filtering

- 1 Click **Add Row** in the Static Multicast Filtering table.

Static Multicast Filtering

Edit Delete Add Row

Multicast Filter Addresses
<input type="radio"/> 225.1.1.1
<input type="radio"/> 225.2.2.2
<input type="radio"/> 225.3.3.3
<input type="radio"/> 225.4.4.4
<input checked="" type="radio"/> <input type="text"/>

Save Cancel

Note: Consult [IP Unicast Routing page](#) for the list of installed routes.

- 2 Type the IP Address that sets the destination for multicast MPE data, in the range from 224.0.0.0 to 239.255.255.255.
Note: If **MPE Data Filter Mode** is set to **Forward All** or **Forward Filtered**, all the unicast MPE data will be forwarded, regardless of the Static Multicast Filtering table.
- 3 Click **Save**.

To edit/delete an existing multicast filter address, select the address entry by clicking on the radio button. Click **Edit** and make the necessary changes, or click **Delete** to remove the address from the Static Multicast Filtering list.

Setting up SNMP Information and Trap Destinations

- 1 From the user interface of the D9859, choose **System Settings > IP Settings > SNMP**. The SNMP page is displayed.

The screenshot shows the web interface for the D9859 Advanced Receiver Transcoder. The main navigation bar includes 'Summary', 'Input', 'Audio & Video', 'Transport Stream', 'System Settings', and 'Support'. The left sidebar shows a tree view with 'System' expanded, containing 'Identification', 'Features/Licenses', 'IP Settings', 'IP Unicast Routing', 'MPE', 'SNMP', and 'Time/Clock'. The 'SNMP' section is active, showing fields for 'Read Only Community String', 'Read Write Community String', 'System Name' (sysname), 'System Location' (Toronto), and 'System Contact' (416-321-xxxx). Below this is the 'Trap Destination Configuration' table with columns 'Trap Destination IP Address' and 'Community String'. A single row is present with IP '192.131.244.2' and a community string of asterisks. Buttons for 'Apply' and 'Refresh' are at the bottom.

- 2 In the **Read Community String** and the **Write Community String** fields, enter public (default) or custom string. Set the password to read/write data from a device and to display diagnostic traps/alarms. This is used when communicating with a device within an SNMP environment. To set a custom community string, enter an alphanumeric character string up to 31 alphanumeric characters in length identifying the password for the device.
Note: The community string is case-sensitive.
- 3 In the **System Name**, **System Location**, and **System Contact** fields, enter the information of the D9859 transcoder. The system information is sent to the MIB browser, if applicable. The MIB Browser is a third party software used to manage SNMP requests. For more information, contact Cisco Services.
- 4 Click **Apply**.

To Add a Trap Destination

- 1 Click **Add Row** in the Trap Destination Configuration area.

This close-up shows the 'Trap Destination Configuration' table. It has two columns: 'Trap Destination IP Address' and 'Community String'. The first row contains the IP '192.131.244.2' and a community string of asterisks. A second row is being added, with the IP field selected. Buttons for 'Edit', 'Delete', 'Add Row', 'Save', and 'Cancel' are visible at the bottom of the table.

- 2 In the **Trap Destination IP Address** field, enter the IP address that sets the destination for SNMP trap messages for system events (fault messages). You can enter up to 12 characters.

- 3 In the **Community String** field, enter the community string for the trap destination (IP Address entered above).
Enter public or custom string. The default is public. You can enter a string up to 35 characters.
- 4 To edit/delete an existing trap destination, select the trap destination entry by clicking on the radio button. Click **Edit** and make the necessary changes, or click **Delete** to remove the address from the Trap Destination Configuration list.
- 5 Click **Save**.

Configuring Time/Clock Settings

- 1 From the user interface of the D9859, choose **System Settings > Time/Clock**. The Time/Clock page is displayed.

The screenshot shows the Cisco D9859 Advanced Receiver Transcoder web GUI. The top navigation bar includes 'Summary', 'Input', 'Audio & Video', 'Transport Stream', 'System Settings', and 'Support'. The left sidebar shows a tree view with 'Time/Clock' selected. The main content area is titled 'Time/Clock' and contains the following settings:

- Date Format:** A drop-down menu set to 'YYYY_MM_DD'. To its right, 'Current TDT Time/Date' is displayed as '2013/06/24 20:56:26'.
- Time Format:** A drop-down menu set to '24Hr'.
- GMT Time Offset:** A drop-down menu set to '+05:30'.
- Enable NTP Time Service:** An unchecked checkbox.
- NTP Server Address:** A text input field containing '0.0.0.0'. Below it are 'Apply' and 'Refresh' buttons.
- Current NTP Time/Date:** Displayed as '2000/01/01 00:00:00'.

- 2 From the **Date Format** drop-down list, choose the date format of the transcoder. The following formats are supported: YYYY_MM_DD, DD_MM_YYYY, MM_DD_YYYY.
- 3 From the **Time Format** drop-down list, choose the time format of the transcoder. Current time information is normally broadcast as part of the transmitted digital signal. It is broadcast as GMT (Greenwich Mean Time) with date information in Modified Julian Date format. The following formats are supported: 24Hr, 24 Hr SuspendZero (the leading zero is dropped from the time), 12Hr, 12Hr SuspendZero (the leading zero is dropped from the time).
- 4 From the **GMT Offset** drop-down list, choose the GMT offset. The local time is displayed using a time zone (GMT offset). If your local time is not GMT, you must set this time setting in the range from -12.0 to +12.0 hours in 0.5 hour increments.
- 5 The **Current TDT Time/Date** displays the current TDT (Time and Date Table) date and time received from the DVB stream. This is displayed as local time.
- 6 Check the **Enable NTP Time Service** check box to periodically request NTP (Network Time Protocol) timestamps from the NTP server (NTP server address set below) and to synchronize its system (i.e., non-DVB related) time with the NTP server. This is displayed as local time.
- 7 In the **NTP Server Address** field, enter the IP address of the NTP server. If the NTP server address is not set (0.0.0.0), the unit will not attempt to connect to the server.
- 8 The **Current NTP Time/Date** field displays the current time if the unit receives a valid reply from the NTP server (adjusted to local time zone).
- 9 Click **Apply**.

Viewing the Alarm/Warning Status

From the user interface of the D9859, choose **System Settings > Status**. The Alarm Status page is displayed.

The screenshot shows the Cisco D9859 - Advanced Receiver Transcoder user interface. The top navigation bar includes 'Summary', 'Input', 'Audio & Video', 'Transport Stream', 'System Settings', and 'Support'. The left sidebar shows 'System' (checked), 'Alarms', 'Versions', 'Settings File', and 'Security/Accounts'. The main content area is titled 'Status' and contains a 'Fault Summary' table and an 'Alarm / Warning Status' table.

Type	Number Active
Alarms	1
Warnings	1

Type	Name	Text	Set Since
Alarm	PE 1: Loss o...	Loss of input...	2013/06/24 13:31:59
Warning	Ethernet Po...	Link is down.	2013/06/24 13:26:59

The Status page displays all the active event messages for the D9859 system. The **Fault Summary** table displays the **Type** of message (alarm or warning) and the number of alarms and warnings that have an active status (**Number Active**).

The following table shows the **Alarm/Warning Status** table information:

Status	Description
Type	Shows whether it is an alarm or a warning message.
Name	Name of the alarm or warning. For more information on alarm messages, refer to <i>D9859 Transcoder Alarm Messages</i> (on page 260).
Text	Content of the message.
Set Since	Date and time of the alarm or warning.

Click **Clear Alarms/Warnings** to clear all the messages in the Alarm/Warning Status table.

Setting up Alarms and Warnings

To Set Up Alarms

- 1 From the user interface of the D9859, choose **System Settings > Setup**. The Alarm Setup page is displayed.

The screenshot shows the Cisco D9859 Advanced Receiver Transcoder web interface. The main content area is titled "Alarm Setup" and contains the following elements:

- Checkboxes:
 - Enable Alarm/Warning Front Panel Reminder
 - Enable Video Cutoff on Alarm Condition
- Table of Alarm Settings:

Alarm Name	Enable/Disable	Trap	Relay
ASI Out Muted	Yes	Yes	Yes
App Loading Error	Yes	Yes	Yes
BOOT PRI	Yes	Yes	Yes
BOOT SEC	Yes	Yes	Yes
DB Corrupted	Yes	Yes	Yes
DB NVS	Yes	Yes	Yes
DL Comms Fault	Yes	Yes	Yes
DL Version Mismatch	Yes	Yes	Yes
DL Write/Erase Fault	Yes	Yes	Yes
Decoder Processor Start	Yes	Yes	Yes
Digital Program Mapping	Yes	Yes	Yes
ECCFPGA TempAlm	Yes	Yes	Yes
ECCFan	Yes	Yes	Yes
ECCTXBEncTempAlm	Yes	Yes	Yes
ECCTXBFPGA TempAlm	Yes	Yes	Yes
ECCTempAlm	Yes	Yes	Yes
FPGA status	Yes	Yes	Yes
LEC Timeout	Yes	Yes	Yes
LMI setup	Yes	Yes	Yes
LNB PS	Yes	Yes	Yes
- Buttons: "Apply" and "Refresh".
- Links: "Alarm Setup" and "Warning Setup".
- Status Bar: Shows "1 Alarms", "1 Warnings", and "153 Clear".

- 2 Check the **Enable Alarm/Warning Front Panel Reminder** check box and the highest priority alarm flashes on the LCD display for a two-second interval every 10 seconds. The alarm will continue to flash periodically until it is either cleared or the **Enable Alarm/Warning Front Panel Reminder** is unchecked.
- 3 Check the **Enable Video Cutoff on Alarm Condition** check box to cut off the video output if any enabled alarm is active on the transcoder. When video is cut off, there will be no horizontal or vertical synchronization on the output. This is useful for downstream redundancy switching by detecting a loss of video signal.
- 4 Click the **Trap Configuration** link to view and/or modify SNMP trap destinations. The link will open the SNMP page. For more information, see *Setting up SNMP Information and Trap Destinations* (on page 228).
- 5 The **Alarm Setup** area displays a list of the alarm/fault messages. For more information on alarm messages, refer to *D9859 Transcoder Alarm Messages* (on page 260).

- From the **Enable/Disable** drop-down list, choose **Yes** and the alarm message will be reported. Choose **No** and the alarm is disabled and the Relay and Trap settings are ignored.

Note: The **Enable/Disable** drop-down list must be set to Yes for the Relay and Trap settings to be functional.

- If current alarm is enabled, set **Trap** to Yes and the SNMP trap message will be sent when the alarm is set or cleared.

Note: No is a read only value that indicates the setting is Yes, but is currently being suppressed because the alarm is disabled (Enb is set to No).

- If current alarm is enabled, choose **Yes** from the **Relay** drop-down list for the rear panel alarm relay to be triggered when the alarm is set or cleared.

Note: No is a read only value that indicates the setting is Yes, but is currently being suppressed because the alarm is disabled (Enb is set to No).

- Click **Apply**.

To Set Up Warnings

Proceed as follows to set up the warning parameters:

- From the Alarm Setup page, click on the **Warning Setup** link at the bottom left hand corner of the page. The Warning Setup page is displayed.

Alarm Name	Enable/Disable	Trap	Relay
ASI TS Over...	Yes	Yes	No
BackupFail	Yes	Yes	No
BackupState	Yes	Yes	No
CAT timeou...	Yes	Yes	No
DRT timeou...	Yes	Yes	No
ECCPPGATE...	Yes	Yes	No
ECCTXBenc...	Yes	Yes	No

- Check the **Enable Alarm/Warning Front Panel Reminder** check box and the warning flashes on the LCD display for a two-second interval every 10 seconds. The warning will continue to flash periodically until it is either cleared or the **Enable Alarm/Warning Front Panel Reminder** is unchecked.
- The **Warning Setup** area displays a list of the warning messages. For more information on warning messages, refer to *D9859 Transcoder Alarm Messages* (on page 260).

Chapter 5 Web GUI Setup and Monitoring

- 4 From the **Enable/Disable** drop-down list, choose **Yes** and the warning message will be reported. Choose **No** and the warning is disabled and the Relay and Trap settings are ignored.

Note: The **Enable/Disable** drop-down list must be set to **Yes** for the Relay and Trap settings to be functional.

- 5 If current warning is enabled, choose **Yes** from the **Trap** drop-down list and the SNMP trap message will be sent when the warning is set or cleared.

Note: No is a read only value that indicates the setting is **Yes**, but is currently being suppressed because the warning is disabled (Enb is set to **No**).

- 6 If current warning is enabled, set **Relay** to **Yes** for the rear panel alarm relay to be triggered when the warning is set or cleared.

Note: No is a read only value that indicates the setting is **Yes**, but is currently being suppressed because the warning is disabled (Enb is set to **No**).

- 7 Click **Apply**.

Viewing Alarm/Warning History

From the user interface of the D9859, choose **System Settings > History**. The Alarm History page is displayed.

Note: The Alarm History page is also access by choosing **Support > Alarm History**.

The screenshot shows the Cisco D9859 - Advanced Receiver Transcoder web interface. The top navigation bar includes 'Summary', 'Input', 'Audio & Video', 'Transport Stream', 'System Settings', and 'Support'. The left sidebar has 'Logs' expanded, showing 'Diagnostic Logs', 'Usage Counters', 'Fans & Temperatures', and 'Alarm History' (selected). The main content area is titled 'Alarm History' and contains a table with the following data:

Type	Name	Text	Set Date ...	Cleared Date & Time
Warning	Transcode...	Fault cleared	2013/07/...	2013/07/12 22:28:13
Warning	ASI TS Ov...	ASI Outpu...	2013/07/...	2013/07/12 22:28:31
Warning	Transcode...	Fault cleared	2013/07/...	2013/07/12 22:28:18
Alarm	PE 1: Loss...	Fault reset.	2013/07/...	2013/07/12 22:28:19
Alarm	Shutdown...	User requ...	2013/07/...	
Alarm	Param Sto...	DB Popula...	2013/07/...	2013/07/12 22:29:20
Warning	Ethernet ...	Link is do...	2013/07/...	
Alarm	System St...	Auto rese...	2013/07/...	2013/07/12 22:29:21
Alarm	Signal Stat...	Signal is lo...	2013/07/...	2013/07/12 22:29:28
Warning	Xcode Vid...	Fault cleared	2013/07/...	2013/07/12 22:33:49
Warning	Xcode Vid...	Fault cleared	2013/07/...	2013/07/12 22:33:50
Warning	Transport ...	Continuity...	2013/07/...	2013/07/12 23:05:33
Warning	Transport ...	Continuity...	2013/07/...	2013/07/12 23:48:12
Alarm	Transcode...	Transcode...	2013/07/...	2013/07/12 23:54:40
Warning	Ethernet ...	Link is do...	2013/07/...	

At the bottom of the table are three buttons: 'Refresh', 'Clear Alarm/Warning History', and 'Export'.

The Alarm and Warning History page displays all the past system event messages and their set and cleared dates and times. For more information on the alarm messages, refer to *D9859 Transcoder Alarm Messages* (on page 260).

Click **Clear Alarms/Warnings History** to clear all the messages in the Fault History table. Click **Export** to export the alarm history to a .csv file. The File Download dialog is displayed. Click **Save** to save the file to your local drive.

Viewing Version Information

From the user interface of the D9859, choose **System Settings > Versions**. The Versions page is displayed.

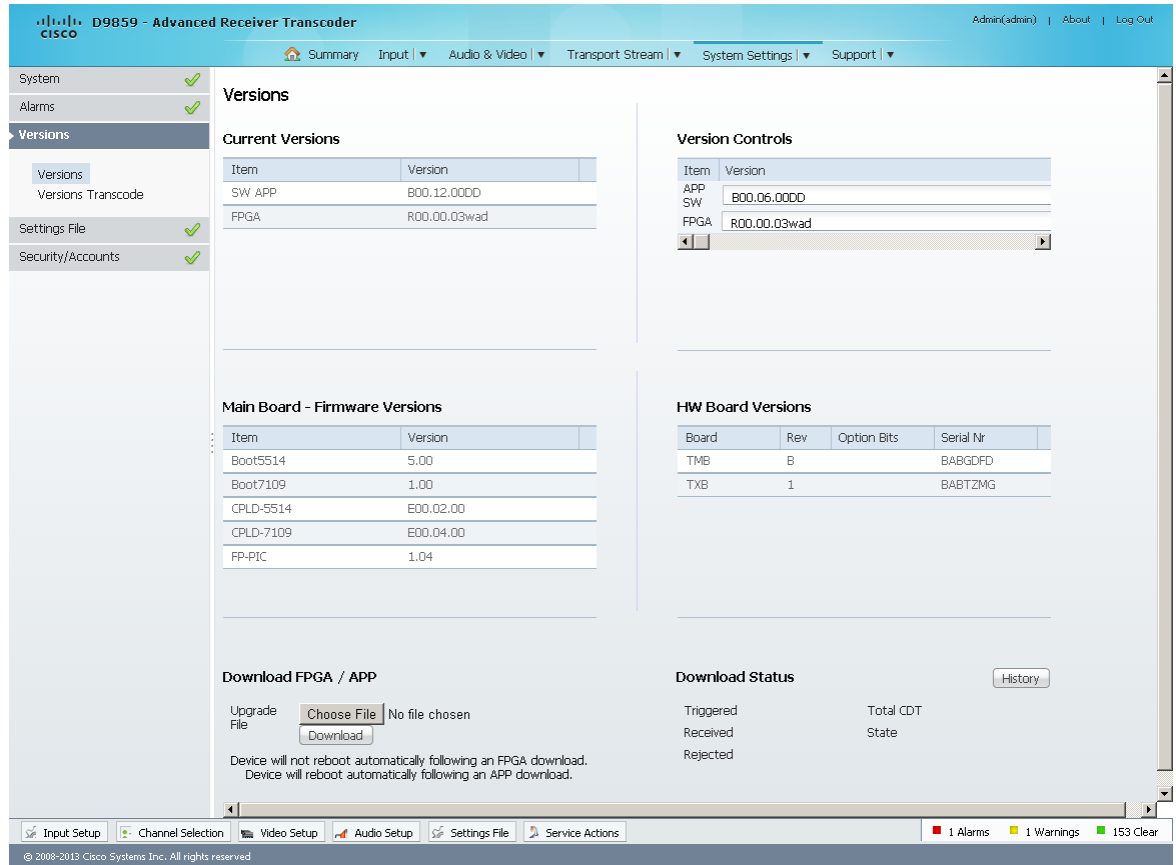

The **Current Versions** area displays the currently running loaded application version and the current limit for the Field Programmable Gate Array (FPGA) version number. In the **Version Controls** section, in the first drop-down list (**SW APP**), you can choose a different application version number to load. In the second drop-down list (**FPGA**), you can choose a different FPGA version number to load. The Selected Version window is displayed. Click **Select & Reboot** to load the selected application and reboot the transcoder. Click **Erase** to remove the selected application version. You will be prompted to continue or not. Click **OK** to continue the deletion.

The **Main Board - Firmware Versions** area displays the following version information:

Firmware Version	Description
Boot5514/Boot7109	Software boot-loader version that initializes and configures the STi5514/STi7109 device on the TMB (main) board. This is the master controller for the D9859 transcoder.

CPLD-5514/CPLD-7109	Software Configurable Programmable Logic Device version attached to the STi5514/STi7109.
FP-PIC	Front panel controller version for the D9859 transcoder.

The **HW Board Versions** table displays the revisions, option bits, and serial numbers of the main board (**TMB**) and the transcoder board (**TXB**).

In the **Download FPGA/APP** area, click **Choose File** to select the new version of FPGA or the D9859 Advanced Receiver Transcoder’s software application. The Open dialog opens. Select the upgrade file and click **Open**. Click **Download** to download the selected upgrade file. File formats that can be downloaded include application CDTs and FPGA CDTs.

Note: For application downloads, once the download is complete, the D9859 transcoder will reboot automatically. For FPGA downloads, you must click **Reboot Receiver** in the Service Actions page (**Support > Service Actions**) to manually reboot the D9859 transcoder and complete the download. This is to facilitate the typical case in which the user intends to flash the FPGA file (no auto reboot) followed by an APP download (auto reboot).

The **Download Status** area displays the current status of the downloads. Click **History** and the Download History window is displayed.

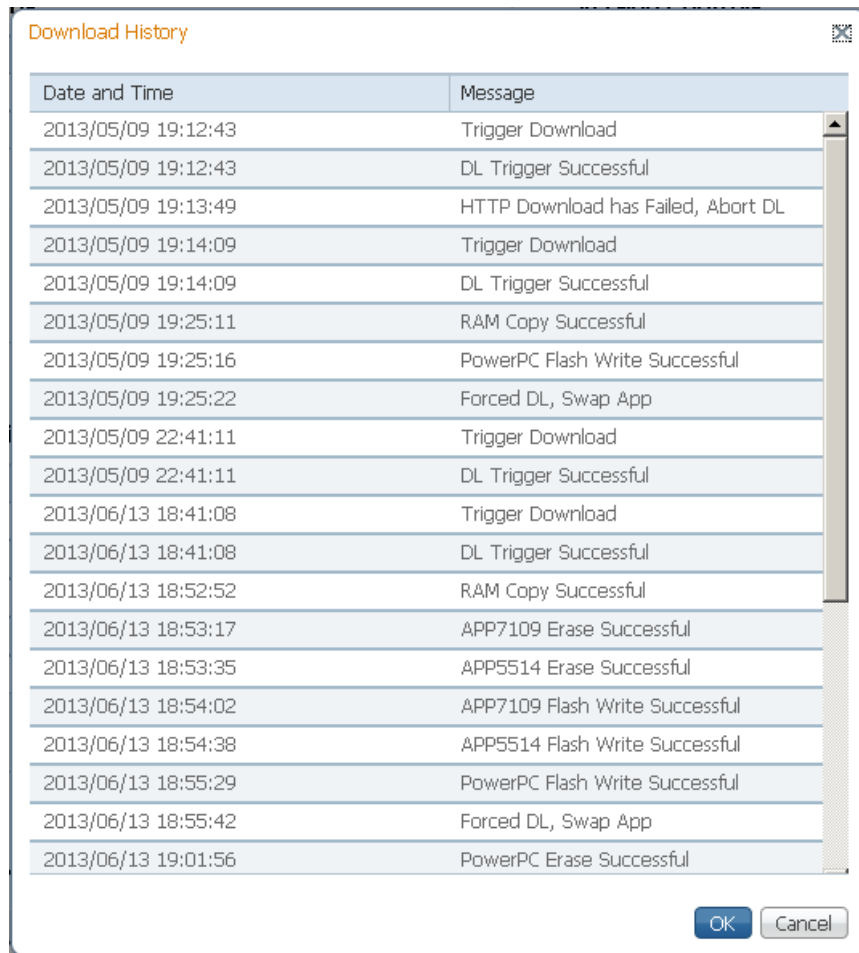

The screenshot shows a window titled "Download History" with a table of events. The table has two columns: "Date and Time" and "Message". The events are listed in chronological order from top to bottom. At the bottom of the window, there are "OK" and "Cancel" buttons.

Date and Time	Message
2013/05/09 19:12:43	Trigger Download
2013/05/09 19:12:43	DL Trigger Successful
2013/05/09 19:13:49	HTTP Download has Failed, Abort DL
2013/05/09 19:14:09	Trigger Download
2013/05/09 19:14:09	DL Trigger Successful
2013/05/09 19:25:11	RAM Copy Successful
2013/05/09 19:25:16	PowerPC Flash Write Successful
2013/05/09 19:25:22	Forced DL, Swap App
2013/05/09 22:41:11	Trigger Download
2013/05/09 22:41:11	DL Trigger Successful
2013/06/13 18:41:08	Trigger Download
2013/06/13 18:41:08	DL Trigger Successful
2013/06/13 18:52:52	RAM Copy Successful
2013/06/13 18:53:17	APP7109 Erase Successful
2013/06/13 18:53:35	APP5514 Erase Successful
2013/06/13 18:54:02	APP7109 Flash Write Successful
2013/06/13 18:54:38	APP5514 Flash Write Successful
2013/06/13 18:55:29	PowerPC Flash Write Successful
2013/06/13 18:55:42	Forced DL, Swap App
2013/06/13 19:01:56	PowerPC Erase Successful

Verifying Software and FPGA Integrity Hash Digest

You can generate the hash digest to verify the integrity of the software and FPGA versions running on the D9859 transcoder. The current and official Cisco D9859 transcoder hash values are published in the D9859 release note. For more information, see *Release Notes for the Cisco D9859 Advanced Receiver Transcoder*. If the generated hash digest values do not match the official list, contact Cisco Services.

To start a communication session with the transcoder, use a utility such as Tera Term Pro or PuTTY. For more information on starting a Telnet or SSH session, see *Starting a Telnet/SSH Session* (on page 30).

- 1 At the admin prompt, type **hash** and press **Enter**. The hash digest for the D9859 is listed. The following is an example:

```
(bits/sec): 80377520 OutputFIFO level 0 fpga lock 0lr
admin>hash
Calculating SHA-1 Hash, Please wait...
D9859:
App5514: 12ae29da 8ee4dd3a aac32cac d902c835 faf39673 Version: B00.14.00DD
App7109: 7b32186a 8ba54d9d fb7045da 789607fb eb980a86 Version: B00.14.00DD
Fpga7109: 38c26e33 12ed3ae0 0308eeb5 bb2c5ca3 a29b3a0d Version: R00.00.03wad

RC=CMD_OK, OK
CS=OK
admin>
```

- 2 Verify the hash digest values with the values listed in the appropriate D9859 release note. If the values do not match, contact Cisco Services.

Viewing Transcoder Version Information

From the user interface of the D9859, choose **System Settings > Versions Transcode**. The Versions Transcode page is displayed.

The screenshot shows the 'Versions Transcode' page in the D9859 web interface. The page is divided into two main sections: 'Transcode - Firmware Versions' and 'Transcode - Software Versions'. The 'Firmware Versions' section contains a table with columns 'Item' and 'Versions'. The 'Software Versions' section contains a table with columns 'Item' and 'Versions'. The interface also includes a navigation menu on the left and a status bar at the bottom.

Item	Versions
Transcoder Board Rev	1
Transcoder Board SN	BABTZMG
FPGA	R00.00.01
Power Sequencer	2.3.4.0000
Transcoder	Pomelo + P20.0 raw
MDL	1.0.10
MCL	0.90.0

Board	Rev	Option Bits	Serial Nr
TMB	B		BABGDFD
TXB	1		BABTZMG

Item	Versions
TXB1G-MAIN Version	V00.00.48
TXB1G-MAIN Base Version	V00.00.48
BOOT	U-Boot 2012.07-IPVS-R01.0 (Jan
angstrom-libc-fixup-hack	1.0-r0.1
base-files	3.0.14-r88.20.1
base-passwd	3.5.20-r3.3.1
bash	3.2-r8.1
boost-serialization	1.38.0-r1.1
burke-feed-configs	1.0-r10.6.1
burke-version	1:2010.12-MVP-debug-20130615-r5
busybox	1.13.2-r22.1.1.2.1

Chapter 5 Web GUI Setup and Monitoring

The **Transcode - Firmware Versions** table displays the version numbers applicable to the Transcoder printed circuit board.

Menu Item	Description
Transcoder Board Rev	Displays the Printed Circuit Board (PCB) revision of the transcoder board.
MCL	Indicates the hardware initialization version number for the transcoder devices on the transcoder board.
MDL	Displays the software version number that provides software access to the transcoder devices.
Transcoder	Displays the version of the firmware performing the transcode.
Power Sequencer	Indicates the firmware version running on the power-sequencer, a chip that controls power-up and power-down of multiple power supplies.
FPGA	Indicates the Field Programmable Gate Array (FPGA) version number.
Transcoder Board SN	Indicates the serial number that is uniquely assigned to the transcoder board.

The **HW Board Versions** table displays the revisions, option bits, and serial numbers of the main board (**TMB**) and the transcoder board (**TXB**).

The **Transcode - Software Versions** table lists all the software packages used for the D9859 transcoder. For more information on the software versions, contact Cisco customer support.

Setting up Import/Export File Information

- 1 From the user interface of the D9859, choose **System Settings > Import/Export File**. The Import/Export File page is displayed.

The screenshot shows the user interface for the D9859 - Advanced Receiver Transcoder. The top navigation bar includes 'Summary', 'Input', 'Audio & Video', 'Transport Stream', 'System Settings', and 'Support'. The left sidebar shows a menu with 'System', 'Alarms', 'Versions', 'Settings File', and 'Security/Accounts'. The 'Settings File' section is expanded, showing 'Import/Export File' and 'Import/Export FTP'. The main content area is titled 'Import / Export File' and contains the following sections:

- Device Settings File Transfer:** Two radio buttons are present: 'Export Device Settings & Transport Network Information' (selected) and 'Export User Device Settings Only'. An 'Export' button is located to the right of the first radio button.
- Settings File:** A 'Choose File' button is followed by the text 'No file chosen'. Below it is an 'Import' button.
- Settings File Backup History:** A table with two columns: 'Last Backup File Name' and 'Backup Time Stamp'. The backup time stamp is '2013/05/25 08:01:02'.
- Settings File Restore History:** A table with two columns: 'Last Restored File Name' and 'Restore Time Stamp'. The restore time stamp is '2013/03/01 02:15:32'.
- Settings File Operation History:** A table with three rows: 'Operation Status' (Pass), 'Detailed Operation Status' (Idle), and 'Percent Completed' (0%). A progress bar is shown next to the 'Percent Completed' value.

In the **Device Settings File Transfer** area, you can export and/or import device settings and transport network information.

- 2 Click the **Export Device Settings & Transport Network Information** radio button and click **Export** to download device settings and transport network information as a file to the designated file folder.
- 3 Click the **Export User Device Settings only** radio button and click **Export** to download user settings as a file to the designated file folder.
- 4 In the **Settings File** area, click **Browse**. The Choose File dialog opens. Navigate to the appropriate folder and select the file with a *.bkp* file extension and click **Open**. Click **Import**.

Viewing the Backup/Restore Status

The following table displays the Settings File Backup/Restore/Operation History information:

Status	Description
Last Backup File Name	Name of the file to use.
Backup Time Stamp	Date and time of the last successful backup file saved.
Last Restored File Name	Name of the last file that was restored.
Restore Time Stamp	Date and time of the last successful restore.
Operation Status	Status of the current backup operation (InProgress, Pass, or Fail).
Detailed Operation Status	Detailed processing step for tracking backup progress.
Percentage Complete	Percentage of backup function completed.

Setting up Import/Export FTP Information

- 1 From the user interface of the D9859, choose **System Settings > Import/Export FTP**. The Import/Export FTP page is displayed.

The screenshot shows the Cisco D9859 Advanced Receiver Transcoder web interface. The top navigation bar includes 'Summary', 'Input', 'Audio & Video', 'Transport Stream', 'System Settings', and 'Support'. The left sidebar shows 'Settings File' selected, with 'Import/Export FTP' highlighted. The main content area is titled 'Import / Export FTP' and contains the following configuration fields:

- Settings Filename: file name
- FTP Server IP Address: 192.168.0.100
- FTP User Name: (empty)
- FTP Password: (masked with dots)
- FTP Port Number: 21

Below the fields are two radio buttons: 'Export Device Settings & Transport Network Information' (unselected) and 'Export User Device Settings Only' (selected). There are 'Apply', 'Refresh', 'Export', and 'Import' buttons.

At the bottom, there are three history tables:

Settings File Backup History		Settings File Restore History	
Last Backup File Name	backup file name	Last Restored File Name	restore file name
Backup Time Stamp	2007/09/01 00:00:00	Restore Time Stamp	2007/09/01 00:00:00

Settings File Operation History	
Operation Status	Pass
Detailed Operation Status	Idle
Percent Completed	0%

- 2 The **Configure Offline FTP Settings File Transfer** area has backup and restore controls.
Note: You must have access to an FTP Server (WinFTP) on a network or a local PC before you can setup backup/restore controls.
- 3 In the **Settings Filename** field, enter the file name of the backup/restore file. You can enter up to 119 characters.
- 4 In the **FTP Server IP Address** field, enter the IP address of the FTP server used to restore the backup/restore file.
- 5 In the **FTP User Name** and **FTP Password** fields, enter the username and password to access the FTP server.
Note: The FTP Password is not retained in the transcoder. You must re-enter the password before initiating the backup or restore operation.
- 6 In the **FTP Port Number** field, enter the port number of the FTP server used to store the backup/restore file. You can enter a port number in the range from 1 to 65535.

Chapter 5 Web GUI Setup and Monitoring

- 7 Click the **Export Device Settings & Transport Network Information** radio button to save user settings and tuning information to the backup file. Select **Export User Device Settings Only** to save user settings to the backup file.
- 8 Click **Export** to save the settings to a backup file. Click **Import** to retrieve the last backed up file.

Viewing the Backup/Restore Status

The following table displays the Settings File Backup/Restore/Operation History information:

Status	Description
Last Backup File Name	Name of the file to use.
Backup Time Stamp	Date and time of the last successful backup file saved.
Last Restored File Name	Name of the last file that was restored.
Restore Time Stamp	Date and time of the last successful restore.
Operation Status	Status of the current backup operation (InProgress, Pass, or Fail).
Detailed Operation Status	Detailed processing step for tracking backup progress.
Percentage Complete	Percentage of backup function completed.

Managing D9859 Web GUI Accounts

You can define up to 10 usernames/passwords for login use via web GUI session on the D9859 transcoder.

When a user tries to login, the user is required to provide a username and a password. The user is granted access only if this username/password pair exists in the authentication table.

The factory preset "Admin" account has Admin privileges and is allowed to add new users, delete users, change usernames, and modify its own passwords. Users with non-Admin privileges (for example, User and Guest) are only allowed to modify their own passwords.

To Change the User Login Passwords

- 1 From the user interface of the D9859, choose **System Settings > Account Management**. The Account Management page is displayed.

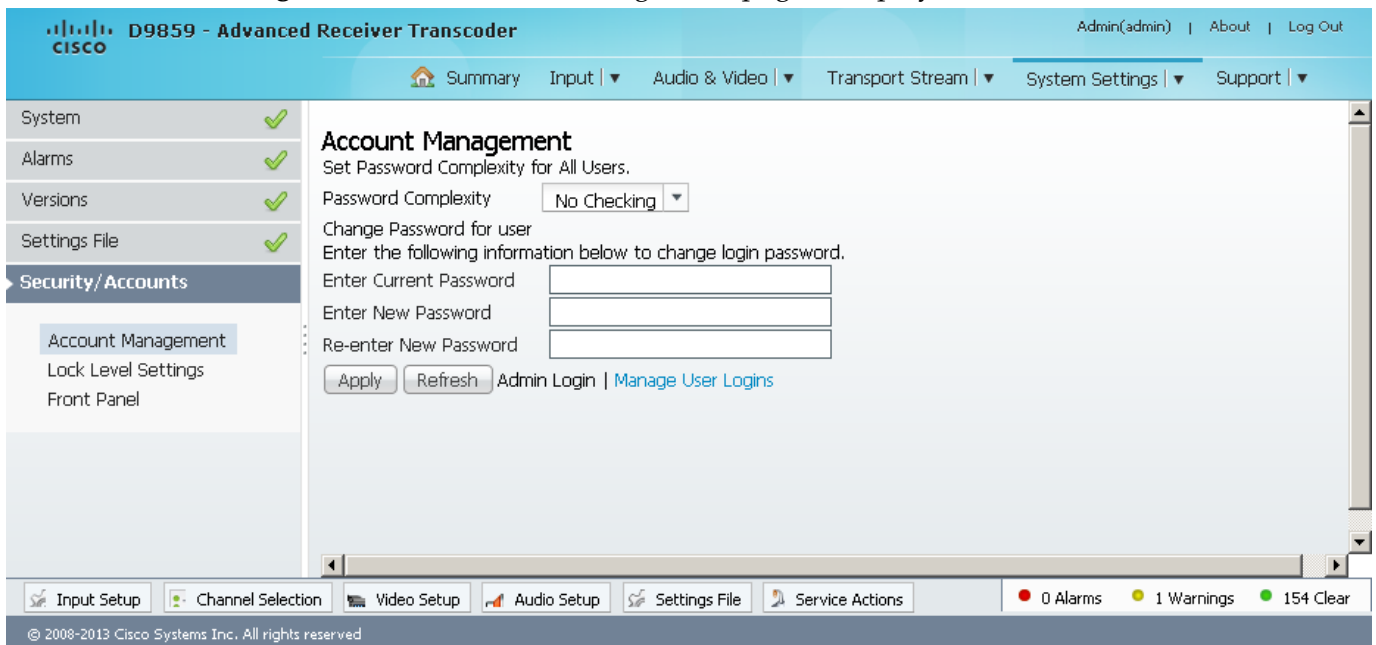

To configure the password complexity for all users:

Note: This feature is only available to a user with Admin privileges only.

- 2 From the **Password Complexity** drop-down list, choose the complexity of the password (No Checking, Minimal Checking, Full Complexity Checking). Any changes take effect immediately, and do not require the use of the **Apply** button.

The following describes the rules for each level:

Password Complexity	Description
No Checking	There are no restrictions on passwords. Note: A minimum of one character is required.
Minimal Checking	A password must comply with the following requirements: <ul style="list-style-type: none"> ■ It cannot contain username or reversed username. ■ It cannot contain any of the following strings: cisco, sciatl, ocsic, ltaics, atlsci, iclta, or any string achieved by full or partial capitalization of letters. ■ No letter is repeated more than three times in a row. ■ Must contain a minimum of four characters.
Full Complexity Checking	A password must comply with the following requirements: <ul style="list-style-type: none"> ■ It cannot contain username or reversed username. ■ It cannot contain any of the following strings: cisco, sciatl, ocsic, ltaics, atlsci, iclta, or any string achieved by full or partial capitalization of letters. ■ No letter is repeated more than three times in a row. ■ Must contain a minimum of eight characters. ■ Must contain a minimum of three of the following types of characters: capital letters, small letters, digits, and special characters.

Note: The complexity level changes will only affect the new user accounts and password changes. It will not affect existing passwords. Any changes take effect immediately, and do not require the use of the **Apply** button.

To change your login password:

Note: You are allowed to only modify your own password.

- 3 The **Change Password for User** field displays the password for the current login.
- 4 In the **Enter Current Password** field, type the current login password.
- 5 In the **Enter New Password** field, type the new login password.
- 6 In the **Re-enter New Password** field, type the new login password again to confirm. Once the password change is successful, the user will be directed to the login screen to re-enter their username and password.

Note: The **Enter New Password** and **Re-enter New Password** should be identical. Each user, including the admin user, can only modify their own password.

- 7 Click **Apply**.

To Add a User Account

Note: This feature is available to a user with Admin privileges only.

- 1 From the Account Management page, click the **Manage User Logins** link. The Login Accounts page is displayed.

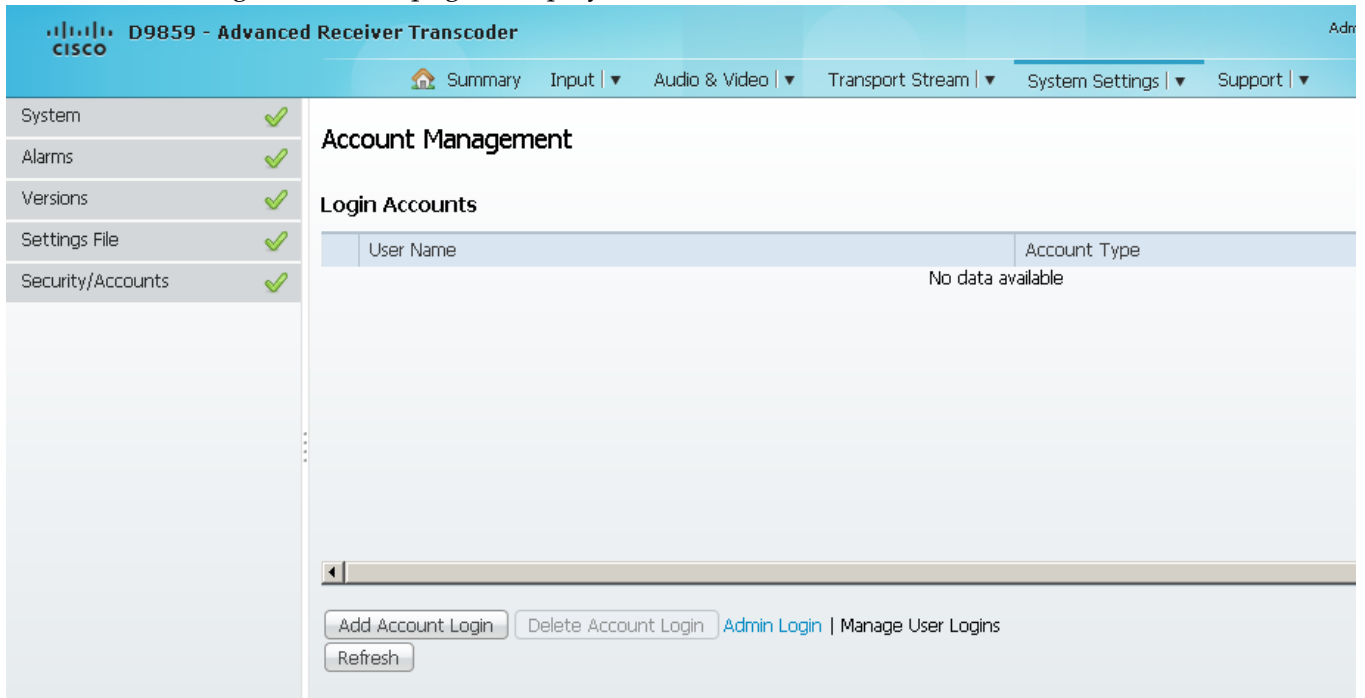

- 2 Click **Add Account Login** to create a new login account.

Note: You can create a maximum of 10 user accounts.

The Add Login Account window is displayed.

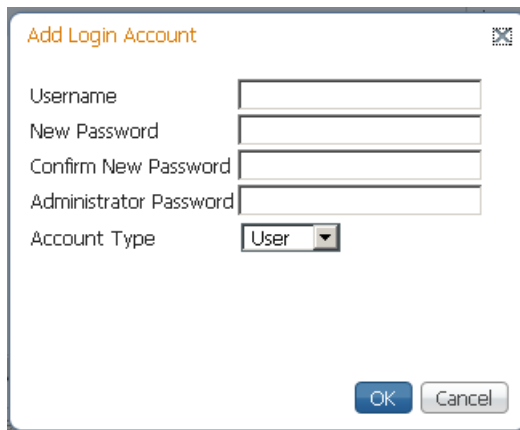

- 3 In the **Username** field, enter a user ID. The new username should not match any of the usernames already defined in the Logins Accounts table.

- 4 In the **New Password** field, enter a password to assign the user ID. The password must follow the rules configured in the **Set Password Complexity for All Users** parameter. For more information, see *To Change the User Login Passwords* (on page 245).
- 5 Enter the new password again to confirm in the **Confirm New Password** field.
Note: The New Password and Confirm New Password should be identical.
- 6 In the **Administrator Password** field, enter your Administrator password used to log on to the D9859 web GUI.
- 7 From the **Account Type** drop-down list, choose User, Admin, or Guest. The following table illustrates the different login types:

Account Type	Access
Guest	View settings only.
User	View and edit settings.
Admin	View, edit settings, and add/delete user accounts.

- 8 Click **OK**.

To Delete a User Account

Note: This feature is available to a user with Admin privileges only.

- 1 In the Login Accounts table, select the user you want to remove.
Note: if you do not have Admin privileges, NOT ALLOWED is displayed in the Login Accounts table.
- 2 Click **Delete Account Login**. The Delete Login Account window is displayed.

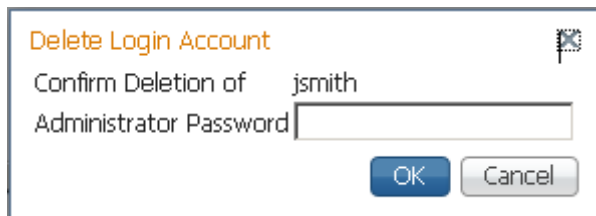

- 3 In the **Administrator Password** field, enter your administrator password to confirm the deletion.
- 4 Click **OK**. The selected user account is deleted.

Configuring Lock Level Settings

- 1 From the user interface of the D9859, choose **System Settings > Lock Level Settings**. The Lock Level Settings page is displayed.

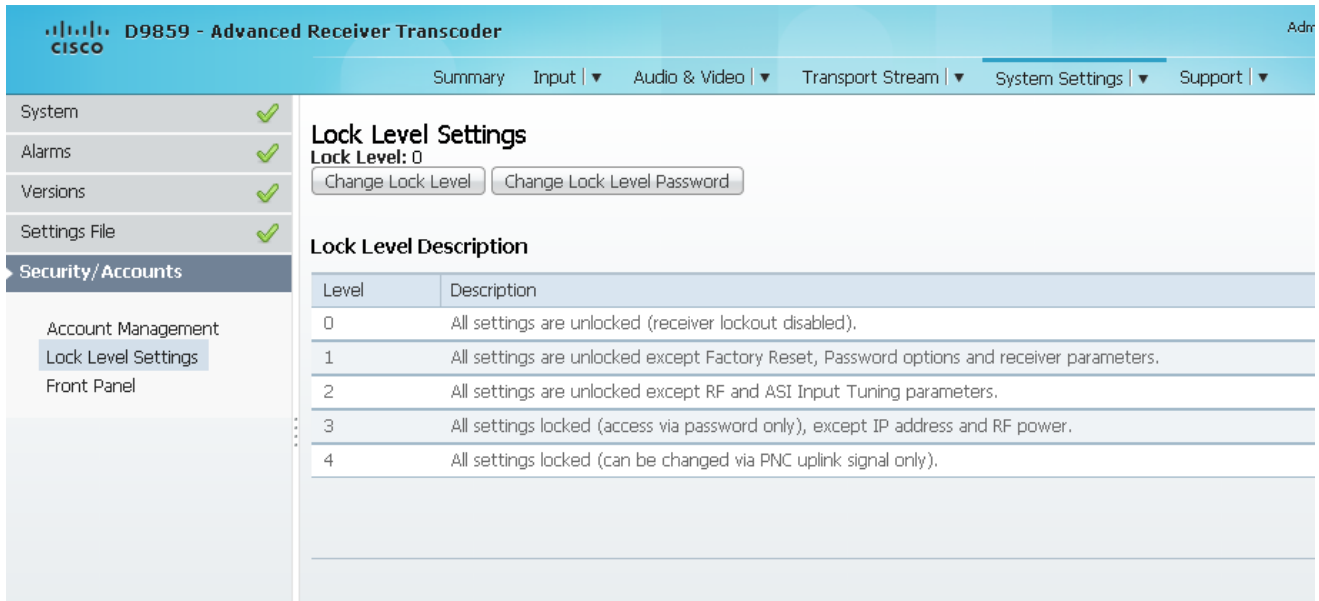

The screenshot shows the Cisco D9859 - Advanced Receiver Transcoder web interface. The top navigation bar includes 'Summary', 'Input', 'Audio & Video', 'Transport Stream', 'System Settings', and 'Support'. The left sidebar shows a menu with 'Security/Accounts' expanded, containing 'Account Management', 'Lock Level Settings', and 'Front Panel'. The main content area is titled 'Lock Level Settings' and shows 'Lock Level: 0'. There are two buttons: 'Change Lock Level' and 'Change Lock Level Password'. Below this is a table titled 'Lock Level Description' with the following content:

Level	Description
0	All settings are unlocked (receiver lockout disabled).
1	All settings are unlocked except Factory Reset, Password options and receiver parameters.
2	All settings are unlocked except RF and ASI Input Tuning parameters.
3	All settings locked (access via password only), except IP address and RF power.
4	All settings locked (can be changed via PNC uplink signal only).

- 2 Click **Change Lock Level** and the Change Lock Level window is displayed.

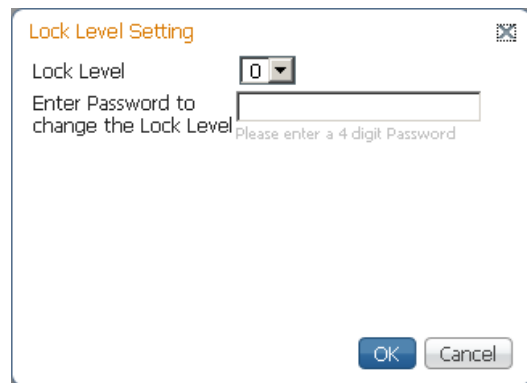

The screenshot shows a dialog box titled 'Lock Level Setting'. It contains a 'Lock Level' dropdown menu with '0' selected. Below it is a text input field with the label 'Enter Password to change the Lock Level'. A note below the password field says 'Please enter a 4 digit Password'. At the bottom of the dialog are 'OK' and 'Cancel' buttons.

- 3 From the **Lock Level** drop-down list, choose the lock level that restricts access and prevents unauthorized changes to the transcoder settings (0, 1, 2, 3, or 4). The default setting is 0.

Note: For details on the lock levels, see D9859 Transcoder Lock Levels.

- 4 In the **Enter Password to change the Lock Level** field, enter the password to change the lock level. Depending on the unit, the default password is 1234. For more information on the default password, contact Cisco Services.
- 5 Click **OK**.

If the incorrect lock level or password is entered, an error message appears at the top of the page.

Changing the Lock Level Password

A unique lock level password (4-digit password) protects the current transcoder settings against unauthorized changes. When changing the password, record and keep this number in a secure location. Depending on the unit, the default password is 1234. For more information on the default password, contact Cisco Services.

Important: Proceed with caution when changing the password as this operation cannot be undone. If the password is lost or is unavailable, contact Cisco customer support.

- 1 In the Lock Level Settings page, click **Change Lock Level Password**. The Change Lock Level Password window is displayed.

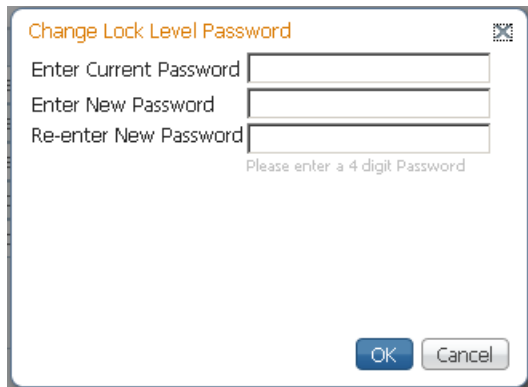

The screenshot shows a dialog box titled "Change Lock Level Password". It contains three text input fields: "Enter Current Password", "Enter New Password", and "Re-enter New Password". Below the "Re-enter New Password" field, there is a small text prompt: "Please enter a 4 digit Password". At the bottom of the dialog, there are two buttons: "OK" and "Cancel".

- 2 In the **Enter Current lock level Password** field, enter the current lock level password.
- 3 In the **Enter New Password** field, enter the new password, any number from 0 to 9.
- 4 In the **Re-enter New Password** field, re-enter the new password and click **OK**. A message appears informing you that the password was changed successfully.

Note: If the password is lost or is unavailable, contact Cisco Services.

Configuring Front Panel Settings

- 1 From the user interface of the D9859, choose **System Settings > Front Panel**. The Front Panel page is displayed.

The screenshot shows the Cisco D9859 Advanced Receiver Transcoder web interface. The top navigation bar includes 'Summary', 'Input', 'Audio & Video', 'Transport Stream', 'System Settings', and 'Support'. The left sidebar shows a menu with 'System', 'Alarms', 'Versions', 'Settings File', and 'Security/Accounts'. Under 'Security/Accounts', there are sub-items: 'Account Management', 'Lock Level Settings', and 'Front Panel'. The main content area is titled 'Front Panel' and contains the following settings:

- Enable Automatic Front Panel Keyboard Lock
- Keyboard Lock Timeout:
- Buttons: Apply, Refresh

- 2 Check the **Enable Automatic Front Panel Keyboard Lock** check box to enable the front panel keypad lock state.
- 3 In the **Keyboard Lock Timeout** field, enter the keypad lock timeout period. The lock timeout period takes effect when the keypad has not been touched (a key has not been pressed) when on the Main Menu for the set period. Avoid setting the period to a short duration when the keypad is used often. Enter a value in the range from 5 to 1800 seconds. The default is 60 seconds.
- 4 Click **Apply**.

Viewing Support Information

Viewing Contact Information

From the user interface of the D9859, choose **Support > Contact Information**. The Contact Information page is displayed.

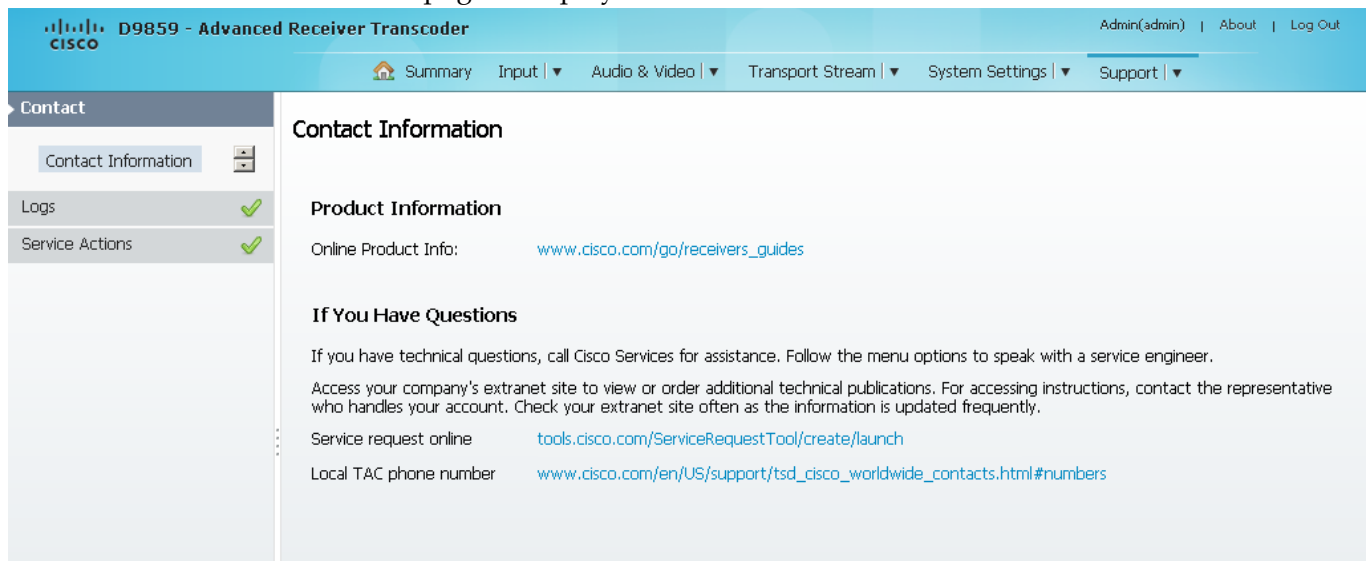

The Contact Information page displays all the Cisco customer support information.

Viewing Diagnostic Logs

From the user interface of the D9859, choose **Support > Diagnostic Logs**. The Diagnostic Logs page is displayed.

The screenshot displays the 'Diagnostic Logs' page in the Cisco D9859 Advanced Receiver Transcoder interface. The page title is 'D9859 - Advanced Receiver Transcoder' and the user is logged in as 'Admin(admin)'. The navigation menu includes 'Summary', 'Input', 'Audio & Video', 'Transport Stream', 'System Settings', and 'Support'. The left sidebar shows 'Logs' with sub-items: 'Diagnostic Logs', 'Usage Counters', 'Fans & Temperatures', and 'Alarm History'. The main content area is titled 'Diagnostic Logs' and contains a 'Log History' table. The table has two columns: 'Set Date a...' and 'Message'. The messages are as follows:

Set Date a...	Message
2013/06/1...	WDOG ;ASSERT ;;788 ;CONTROLLED SHUTDOWN
2013/06/1...	FW ;ASSERT ;;3788;Could not unsubscribe 0, bad handle or bad instance
2007/02/0...	LOG ;WARNING;;1660;827 old messages were lost while log output was inactive on this interface.
2007/02/0...	WDOG ;INFO ;;1194; Reset info: SW reset: 1, rc: 0x00000001, info: DL APP REBOOT, source: 5514
2007/02/0...	WDOG ;INFO ;;1182; Reset details: Code version: B00.11.00DD, Time: 2013-06-13 18:32:43 -> 2013-06-19 01:01:46
2007/02/0...	FW ;ASSERT ;;3309;-->2 Data item being subscribed to not found! instance:37 item:0
2007/02/0...	FW ;ASSERT ;;7188;-->2 Received msg 'SUBSCRIBE_TO_DATA' own:18 item:2023 nsh:131487 ud:131076 sn:0 p:0 FAILED...
2007/02/0...	FW ;ASSERT ;;3309;-->2 Data item being subscribed to not found! instance:37 item:0
2007/02/0...	FW ;ASSERT ;;7188;-->2 Received msg 'SUBSCRIBE_TO_DATA' own:18 item:2024 nsh:131488 ud:131076 sn:0 p:0 FAILED...
2007/02/0...	FW ;ASSERT ;;3309;-->2 Data item being subscribed to not found! instance:37 item:0
2007/02/0...	FW ;ASSERT ;;7188;-->2 Received msg 'SUBSCRIBE_TO_DATA' own:18 item:2025 nsh:131489 ud:131076 sn:0 p:0 FAILED...
2007/02/0...	FW ;ASSERT ;;3309;-->2 Data item being subscribed to not found! instance:37 item:0
2007/02/0...	FW ;ASSERT ;;7188;-->2 Received msg 'SUBSCRIBE_TO_DATA' own:18 item:2026 nsh:131490 ud:131076 sn:0 p:0 FAILED...
2007/02/0...	FW ;ASSERT ;;3309;-->2 Data item being subscribed to not found! instance:37 item:0
2007/02/0...	FW ;ASSERT ;;7188;-->2 Received msg 'SUBSCRIBE_TO_DATA' own:18 item:2027 nsh:131491 ud:131076 sn:0 p:0 FAILED...

At the bottom of the log history, there are 'Clear' and 'Export' buttons. The status bar at the bottom right shows '1 Alarms', '1 Warnings', and '153 Clear'. The footer of the page reads '© 2009-2013 Cisco Systems Inc. All rights reserved'.

The Diagnostic Logs page displays all the system log messages with their dates and times.

Click the arrow next to **Set Date and Time** column to sort by date and time.

Click **Export** to export the log history to a .csv file. The File Download dialog is displayed. Click **Save** to save the file to your local drive.

Click **Clear** to clear the log history.

Viewing the Usage Counters

From the user interface of the D9859, choose **Support > Usage Counters**. The Usage Counters page is displayed.

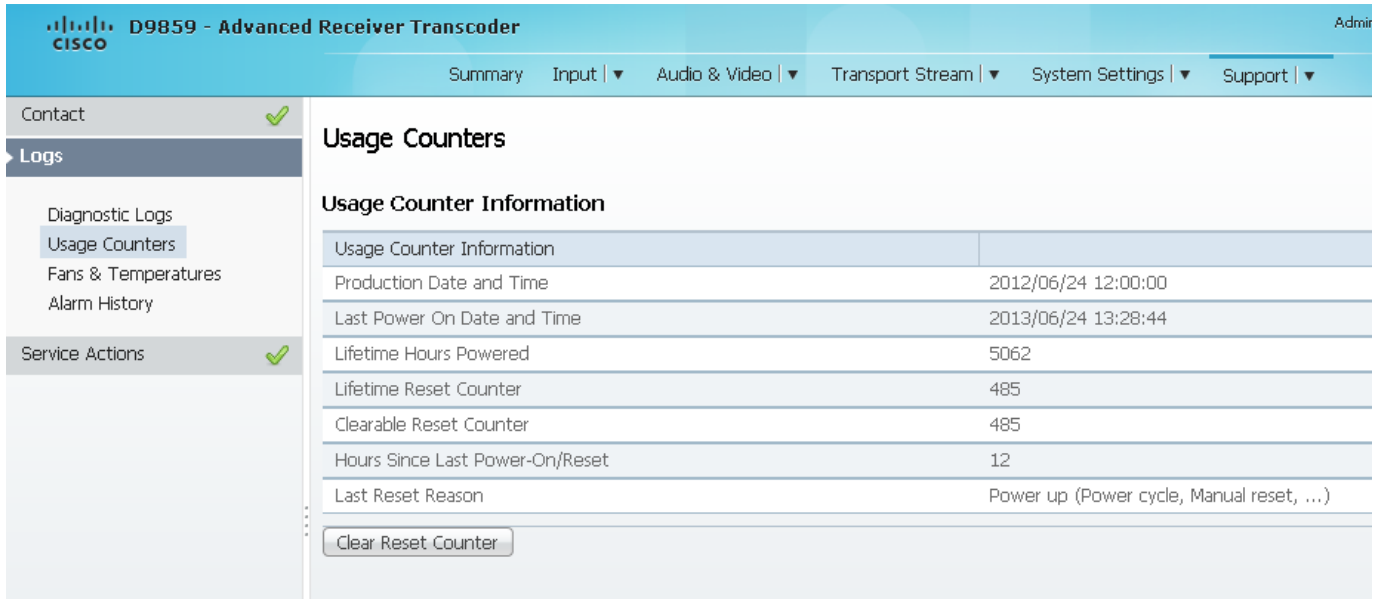

The following table describes the Usage Counter Information:

Device Status Information	Description
Production Date & Time	Displays the date and time when the transcoder was manufactured.
Last Power On Date and Time	Displays the date and time when the transcoder was powered up.
Lifetime Hours Powered	Displays the number of hours since the last power-on.
Lifetime Reset Counter	Displays the total number of times the transcoder has been restarted.
Clearable Reset Counter	Displays the number of restarts since the last time the restart counter was cleared. To clear or reset the Clearable Reset Count, click Clear Reset Counter .
Hours Since Last Powered-On/Reset	Displays the total number of hours that the transcoder has been operating since the last power-on or restart.
Last Reset Reason	Displays the reason for the last restart, i.e., power cycle or manual reset.

Click **Clear Reset Counter** to clear the **Clearable Reset Counter** field and it resets the counter back to 0.

Viewing Operating Fan Speeds and Board Temperatures

From the user interface of the D9859, choose **Support > Fans & Temperatures**. The Fans & Temperatures page is displayed.



Current	Maxim...	Average	Intake1	Intake2	FPGA ...	FPGA	FAN1	FAN2	FAN3	FAN4	FAN5	FAN6	FAN7
35.0	37.0	24.0	46.0°C	35.0°C	55.0°C	61.0°C	5520	5820	5640	5940	5700	5820	5820

The **Current** column displays the current operating temperature. The **Maximum** column displays the maximum operating temperature that has been reached. The **Average** column displays the average operating temperature. The values are displayed in Degrees Celsius.

The **FAN1** to **FAN7** columns display the current speed of the seven fans in the D9859 transcoder.

Viewing Alarm/Warning History

From the user interface of the D9859, choose **System Settings > History**. The Alarm History page is displayed.

Note: The Alarm History page is also access by choosing **Support > Alarm History**.

The screenshot shows the web interface for the D9859 - Advanced Receiver Transcoder. The top navigation bar includes links for Summary, Input, Audio & Video, Transport Stream, System Settings, and Support. The left sidebar shows a menu with options like Contact, Logs, Diagnostic Logs, Usage Counters, Fans & Temperatures, Alarm History (selected), and Service Actions. The main content area is titled "Alarm History" and contains a table of system event messages.

Type	Name	Text	Set Date ...	Cleared Date & Time
Warning	Transcode...	Fault cleared	2013/07/...	2013/07/12 22:28:13
Warning	ASI TS Ov...	ASI Outpu...	2013/07/...	2013/07/12 22:28:31
Warning	Transcode...	Fault cleared	2013/07/...	2013/07/12 22:28:18
Alarm	PE 1: Loss...	Fault reset.	2013/07/...	2013/07/12 22:28:19
Alarm	Shutdown...	User requ...	2013/07/...	
Alarm	Param Sto...	DB Popula...	2013/07/...	2013/07/12 22:29:20
Warning	Ethernet ...	Link is do...	2013/07/...	
Alarm	System St...	Auto rese...	2013/07/...	2013/07/12 22:29:21
Alarm	Signal Stat...	Signal is lo...	2013/07/...	2013/07/12 22:29:28
Warning	Xcode Vid...	Fault cleared	2013/07/...	2013/07/12 22:33:49
Warning	Xcode Vid...	Fault cleared	2013/07/...	2013/07/12 22:33:50
Warning	Transport ...	Continuity...	2013/07/...	2013/07/12 23:05:33
Warning	Transport ...	Continuity...	2013/07/...	2013/07/12 23:48:12
Alarm	Transcode...	Transcode...	2013/07/...	2013/07/12 23:54:40
Warning	Ethernet ...	Link is do...	2013/07/...	

At the bottom of the table, there are three buttons: Refresh, Clear Alarm/Warning History, and Export.

The Alarm and Warning History page displays all the past system event messages and their set and cleared dates and times. For more information on the alarm messages, refer to *D9859 Transcoder Alarm Messages* (on page 260).

Click **Clear Alarms/Warnings History** to clear all the messages in the Fault History table. Click **Export** to export the alarm history to a .csv file. The File Download dialog is displayed. Click **Save** to save the file to your local drive.

Loading a Software Version and License

From the user interface of the D9859, choose **Support > Service Actions**. The Service Actions page is displayed.

The screenshot shows the Cisco D9859 Advanced Receiver Transcoder web interface. The top navigation bar includes 'Summary', 'Input', 'Audio & Video', 'Transport Stream', 'System Settings', and 'Support'. The 'Support' menu is expanded, showing 'Service Actions' as the selected option. On the left sidebar, 'Service Actions' is also highlighted. The main content area is titled 'Service Actions' and contains several sections:

- Factory Reset** and **Reboot Receiver** buttons.
- Collect Debug Support Data** with an **Export** button.
- S/W Version** section with a dropdown menu showing 'B00.06.00DD', a **Select & Reboot** button, and an **Erase** button.
- Download APP** section with an **Upgrade File** label, a **Choose File** button (showing 'No file chosen'), and a **Download** button.

Below the 'Download APP' section, there is a note: 'Device will not reboot automatically following an FPGA download. Device will reboot automatically following an APP download.'

The **Collect Debug Support Data Export** is used by Cisco Services only. Click **Export** to create and save a diagnostics file.

Note: We recommend that you collect the debug support data prior to contacting Cisco Services for any D9859 issues.

The **S/W Version** drop-down list allows you to select/load a different application version to your transcoder. Click **Select & Reboot** to load the selected application version and reboot the transcoder. Click **Erase** to remove the selected application version. You will be prompted to continue or not. Press **OK** to continue the deletion.

Click **Factory Reset** to perform a reset of transcoder settings back to the factory set (default) values. A warning message prompts you to confirm the operation. Click **OK** to continue or **No** to cancel the operation.

Click **Reboot Receiver** to reboot the transcoder. You will be prompted to verify the operation. Click **Yes** to reboot the transcoder or **No** to cancel the operation.

Downloading the Software Application

In the **Download APP** area, click **Choose File** to select the new version of FPGA or the D9859 Advanced Receiver Transcoder's software application. The Open dialog opens. Select the upgrade file and click **Open**. Click **Download** to download the selected upgrade file. File formats that can be downloaded include Application CDTs and FPGA CDTs.

During the upgrade, click **Return to Browser** (not recommended) to return to the web browser. The application download continues. It is not recommended to interrupt the upgrade during the application download. Click **Download Status Toggle** to move between updating the **Download Status** data on the **Versions** page and updating the download status on an external device.

Note: For application downloads, once the download is complete, the D9859 transcoder will reboot automatically. For FPGA downloads, you must click **Reboot Receiver** to manually reboot the D9859 transcoder and complete the download. This is to facilitate the typical case in which the user intends to flash the FPGA file (no auto reboot) followed by an APP download (auto reboot).

Note: If you are downloading an older version of the software application, it is recommended that you clear the browser cache prior to logging back in to the D9859 web GUI.

Downloading a Software License

If the unit is new from the factory, without any licenses loaded, it is recommended that you wait three minutes after you first boot up the unit before downloading a license file. If the unit has previously loaded licenses, it is recommended that you wait ten minutes after you boot up the unit before downloading a new license file.

In the **Download APP** area, click **Choose File** to select the software license file. The Open dialog opens. Select the license file and click **Open**. Click **Download** to download the selected license file. You must wait approximately 100 seconds before you can view the updated transcode license information. For more information on license information, see *Viewing Hardware Features and Base License Information* (on page 219).

6

Service and Maintenance

Overview

This chapter gives information to assist you in upgrading firmware to the D9859 Advanced Receiver Transcoder. It also describes how the status of the D9859 transcoder is communicated via front panel LEDs.

In This Chapter

- D9859 Transcoder Alarm Messages260
- Power Supply Replacement.....317

D9859 Transcoder Alarm Messages

The Alarm LED on the front panel indicates whether the unit has triggered an alarm or warning. A solid red signal for five seconds indicates a warning, and a flashing red signal indicates an alarm. For more information, see *About the Front Panel* (on page 34).

The status of the D9859 transcoder and its immediate surroundings is reported to the front panel in the form of messages and alarms. You can enable or disable messages in the Alarm/Warning settings.

The following table shows an alphabetical list of the available messages and their default alarm status. The Set Messages and Clear Messages are displayed in the Warning History when the messages are set or cleared respectively.

Note: Only alarm conditions can be used to trigger rear panel relays to control external alarm equipment. Warnings are not associated with relay operations.

It is recommended that you collect the debug support data prior to contacting Cisco customer support for any D9859 issues.

Alarms

Alarm	Message Type	Message	Cause/Remedy	Description	Severity	ID
PSB non-compliant	Set	PROD incomplete or PSB non-compliant	<p>Cause: Production Access Reset command was not issued after production programming was completed.</p> <p>Remedy: The Access Reset command should be issued by the user with PROD credentials if the device has not yet been shipped to the customer. Otherwise, the customer must reset credentials using the Front Panel.</p>	Device is in the WEAK state after production programming is complete.	Major	900

Alarm	Message Type	Message	Cause/Remedy	Description	Severity	ID
PSB non-compliant	Clear	PSB compliant	-	-	-	900
Pri Flash Fail	Set	Contact Customer Service (%s fail at %d)	Cause: FLASH driver operation %s (one of ERASE, WRITE, BLANK_CHECK or READ_WRITE) failed on the Primary (5514) FLASH offset %d. Remedy: Contact Cisco customer support.	The FLASH device hardware failed.	Major	910
Sec Flash Fail	Set	Contact Customer Service (%s fail at %d)	Cause: FLASH driver operation %s (one of ERASE, WRITE, BLANK_CHECK or READ_WRITE) failed on the Secondary (7109) FLASH offset %d. Remedy: Contact Cisco customer support.	The FLASH device hardware failed.	Major	920
Trans 1 Flash Fail	Set	Contact Customer Service (%s fail at %d)	Cause: FLASH driver operation %s (one of ERASE, WRITE, BLANK_CHECK or READ_WRITE) failed on the Transcoder 1 (Sat1) FLASH offset %d. Remedy: Contact Cisco customer support.	The FLASH device hardware failed.	Major	930

Chapter 6 Service and Maintenance

Alarm	Message Type	Message	Cause/Remedy	Description	Severity	ID
Trans 2 Flash Fail	Set	Contact Customer Service (%s fail at %d)	Cause: FLASH driver operation %s (one of ERASE, WRITE, BLANK_CHECK or READ_WRITE) failed on the Transcoder 2 (Sat2) FLASH offset %d. Remedy: Contact Cisco customer support.	The FLASH device hardware failed.	Major	940
Settings Lost	Set	Stored configuration incomplete. Contact Customer Service.	Cause: Corrupted database record was found while populating the DBR partition. Remedy: Contact Cisco customer support.	The settings database detects corruption.	Major	950
App Startup Fault	Set	<Version> Failed to start	Cause: Errors during software startup. Remedy: The unit will revert back to the previous version within ten minutes. If the problem persists, contact Cisco customer support.	An attempt to start <version> has failed.	Major	960
Signal Status	Set	ASI Signal - No Content	Cause: Loss of ASI/RF lock. Loss of Transport data. Invalid frequency parameters. External to IRD. Remedy: Check tuning parameters and ASI/RF cables.	ASI Link Locked, but no TS content.	Minor	1000

Alarm	Message Type	Message	Cause/Remedy	Description	Severity	ID
Signal Status	Set	RF Signal - No Content	Cause: Loss of ASI/RF lock. Loss of Transport data. Invalid frequency parameters. External to IRD. Remedy: Check tuning parameters and ASI/RF cables.	RF Tuner locked, but no TS content.	Minor	1000
Signal Status	Set	Signal is lost	Cause: Loss of ASI/RF lock. Loss of Transport data. Invalid frequency parameters. External to IRD. Remedy: Check tuning parameters and ASI/RF cables.	Loss of signal	Minor	1000
Signal Status	Set	Tuning Parameters Invalid	Cause: Loss of ASI/RF lock. Loss of Transport data. Invalid frequency parameters. External to IRD. Remedy: Check tuning parameters and ASI/RF cables.	One of the tuning parameters is invalid	Minor	1000
Signal Status	Clear	Signal is locked	-	Signal OK	Minor	1000
Signal Status	Clear	Tuning Parameters Valid	-	Tuning parameters are valid	Minor	1000
Transcoder Status	Set	Transcode Not Started: Restart Timeout	Cause: Possible hardware or software fault. Remedy: Clear all alarms, reset the unit, and notify Cisco customer support if the problem persists.	No response was received from the transcoder during the boot process.	Major	1500

Chapter 6 Service and Maintenance

Alarm	Message Type	Message	Cause/Remedy	Description	Severity	ID
Transcoder Status	Set	Transcode Not Started: FPGA failed to load	Cause: Possible hardware or software fault. Remedy: Clear all alarms, reset the unit, and notify Cisco customer support if the problem persists.	Unable to load or execute the transcoder FPGA software.	Major	1500
Transcoder Status	Set	Transcode Not Started: FPGA version mismatch	Cause: Possible hardware or software fault. Remedy: Clear all alarms, reset the unit, and notify Cisco customer support if the problem persists.	Transcoder FPGA software version does not match the hardware version.	Major	1500
Transcoder Status	Set	Transcode Not Started: Decoder failed to load	Cause: Possible hardware or software fault. Remedy: Clear all alarms, reset the unit, and notify Cisco customer support if the problem persists.	Unable to load or execute the decoder software.	Major	1500
Transcoder Status	Set	Transcode Not Started: Encoder failed to load	Cause: Possible hardware or software fault. Remedy: Clear all alarms, reset the unit, and notify Cisco customer support if the problem persists.	Unable to load or execute the encoder software.	Major	1500

Alarm	Message Type	Message	Cause/Remedy	Description	Severity	ID
Transcoder Status	Set	Transcode Not Started: Invalid production information	Cause: Possible hardware or software fault. Remedy: Clear all alarms, reset the unit, and notify Cisco customer support if the problem persists.	Transcoder production information is corrupted.	Major	1500
Transcoder Status	Set	Transcode Not Started: Communication Failure	Cause: Possible hardware or software fault. Remedy: Clear all alarms, reset the unit, and notify Cisco customer support if the problem persists.	There was an error establishing connection with the transcoder.	Major	1500
Transcoder Status	Set	Transcoder Not Detected	Cause: Possible hardware or software fault. Remedy: Clear all alarms, reset the unit, and notify Cisco customer support if the problem persists.	Messages were not received from Transcode on boot.	Major	1500
Transcoder Status	Set	Lost Contact With Transcoder	Cause: Transcoder resetting. Possible hardware or software fault. Remedy: Clear all alarms, reset the unit, and notify Cisco customer support if the problem persists.	Messages were not received from Transcoder after it previously received messages.	Major	1500
Transcoder Status	Clear	Transcoder Started	-	-	Major	1500

Chapter 6 Service and Maintenance

Alarm	Message Type	Message	Cause/Remedy	Description	Severity	ID
Transcoder Verification	Set	POST reported errors	Cause: Possible hardware issue. Remedy: Clear all alarms, reset the unit, and notify Cisco customer support if the problem persists.	The transcoder power-on self-test reported errors.	Major	1600
Transcoder Verification	Set	POST data unavailable	Cause: Possible hardware issue. Remedy: Clear all alarms, reset the unit, and notify Cisco customer support if the problem persists.	The transcoder was unable to read the results of the power-on self-test.	Major	1600
Transcoder Verification	Set	Application checksum failed	Cause: Possible hardware issue. Remedy: Clear all alarms, reset the unit, and notify Cisco customer support if the problem persists.	The transcoder software failed verification.	Major	1600
TEB State	Set	Error state	Cause: There is a transcoder board error. Remedy: Clear all alarms, reset the unit, and notify Cisco customer support if the problem persists.	The transcoder board is in an error state.	Major	2000
TEB State	Set	TEB Application mismatch	Cause: There is a transcoder board error. Remedy: Clear all alarms, reset the unit, and notify Cisco customer support if the problem persists.	Application version mismatch between the transcoder board and the main board.	Major	2000
TEB State	Clear	Fault cleared	-	-	Major	2000

Alarm	Message Type	Message	Cause/Remedy	Description	Severity	ID
PE n: ISE Not Auth	Set	Channel is not authorized	<p>Cause: The channel is unauthorized for the current program.</p> <p>Remedy: Contact your (uplink) service provider to determine whether you are authorized to receive the current program.</p>	Program unauthorized because the tier bits do not match.	Minor	3000 4000 5000 6000 7000 8000 9000 10000 10009-10032
PE n: ISE Not Auth	Set	Channel requires an authorization key	<p>Cause: The channel is unauthorized for the current program.</p> <p>Remedy: Contact your (uplink) service provider to determine whether you are authorized to receive the current program.</p>	Program is unauthorized because the unit does not have an authorization key.	Minor	3000 4000 5000 6000 7000 8000 9000 10000 10009-10032
PE n: ISE Not Auth	Set	Channel is blacked out	<p>Cause: The channel is unauthorized for the current program.</p> <p>Remedy: Contact your (uplink) service provider to determine whether you are authorized to receive the current program.</p>	Program is unauthorized because at a minimum, it needs to match one blackout code.	Minor	3000 4000 5000 6000 7000 8000 9000 10000 10009-10032

Chapter 6 Service and Maintenance

Alarm	Message Type	Message	Cause/Remedy	Description	Severity	ID
PE n: ISE Not Auth	Set	Channel uses an unknown CA system	<p>Cause: Conditional access not supported.</p> <p>Remedy: Contact your (uplink) service provider to determine whether you are authorized to receive the current program at this time.</p>	Non-SA conditional access system.	Minor	3000 4000 5000 6000 7000 8000 9000 10000 10009-10032
PE n: ISE Not Auth	Set	Channel authorization refused	<p>Cause: Conditional access not supported.</p> <p>Remedy: Contact your (uplink) service provider to determine whether you are authorized to receive the current program at this time.</p>	There is mismatch in the Conditional access.	Minor	3000 4000 5000 6000 7000 8000 9000 10000 10009-10032
PE n: ISE Not Auth	Set	Channel requires an IRD with CA support	<p>Cause: Conditional access not supported.</p> <p>Remedy: Contact your (uplink) service provider to determine whether you are authorized to receive the current program at this time.</p>	Conditional access is not supported.	Minor	3000 4000 5000 6000 7000 8000 9000 10000 10009-10032
PE n: ISE Not Auth	Set	Channel requires the PE to have an ISE	<p>Cause: Hardware issue.</p> <p>Remedy: Clear alarms, reset unit, and notify Cisco customer support if problem persists.</p>	Hardware issue.	Minor	3000 4000 5000 6000 7000 8000 9000 10000 10009-10032

Alarm	Message Type	Message	Cause/Remedy	Description	Severity	ID
PE n: ISE Not Auth	Set	Channel Unavailable - LEC timeout	Cause: Uplink configuration issue. Remedy: Contact your (uplink) service provider to determine whether the LEC GDS data is being provided in the stream.	Uplink configuration issue.	Minor	3000 4000 5000 6000 7000 8000 9000 10000 10009-10032
PE n: ISE Not Auth	Clear	Fault Reset	-	-	Minor	3000 4000 5000 6000 7000 8000 9000 10000 10009-10032
PE n: ISE Not Auth	Clear	Channel is authorized	-	-	Minor	3000 4000 5000 6000 7000 8000 9000 10000 10009-10032
PE n: Loss of Input	Set	Loss of input detected	Cause: Loss of input. Remedy: Ensure input has a valid stream.	Loss of input.	Minor	11000 12000 13000 14000 15000 16000 17000 18000 18009-18032

Chapter 6 Service and Maintenance

Alarm	Message Type	Message	Cause/Remedy	Description	Severity	ID
PE n: Loss of Input	Clear	Fault reset	-	-	Minor	11000 12000 13000 14000 15000 16000 17000 18000 18009-18032
Digital Program Mapping	Set	PID Collision	Cause: Uplink settings may have changed since setting up the unit. Please check your DPM settings. Remedy: Correct the DPM settings. Check the uplink to find the appropriate system settings.	Two source service PIDs are being mapped to the same output PID. This will cause data corruption in the stream.	Minor	19000
Digital Program Mapping	Set	Program Collision	Cause: Uplink settings may have changed since setting up the unit. Please check your DPM settings. Remedy: Correct the DPM settings. Check the uplink to find the appropriate system settings.	Two source channel numbers are being mapped/ passed to the same channel number in the output.	Minor	19000
Digital Program Mapping	Set	Mode-i PMT out of range	Cause: Uplink settings may have changed since setting up the unit. Please check your DPM settings. Remedy: Correct the DPM settings. Check the uplink to find the appropriate system settings.	PMT PID to be used for Mode-i is outside of valid MPEG PID range.	Major	19000

Alarm	Message Type	Message	Cause/Remedy	Description	Severity	ID
Digital Program Mapping	Clear	Digital Program Mapping - OK	-	-	Major	19000
Transcoding Status	Set	Transcoding Halted: SW version mismatch	Cause: Possible hardware or software issue. Remedy: Reselect desired application, clear alarms, reset the unit, notify Cisco customer support if problem persists.	Unexpected software version running on transcoder	Minor	19500
Transcoding Status	Set	Transcoding Halted: Transcoder out of sync	Cause: Possible hardware or software issue. Remedy: Reselect desired application, clear alarms, reset the unit, notify Cisco customer support if problem persists.	Transcoder software in unexpected state.	Minor	19500
Transcoding Status	Clear	Transcoding operational	-	-	Minor	19500
Shutdown Event	Set	DL APP REBOOT	Cause: User request requires reboot or internal system error. Remedy: If it is an internal system error fault, clear alarms, reset the unit, notify Cisco customer support if the problem persists.	New application downloaded, system requires reboot.	Major	20000

Chapter 6 Service and Maintenance

Alarm	Message Type	Message	Cause/Remedy	Description	Severity	ID
Shutdown Event	Set	User requested FPGA change	<p>Cause: User request requires reboot or internal system error.</p> <p>Remedy: If it is an internal system error fault, clear alarms, reset the unit, notify Cisco customer support if the problem persists.</p>	Runnable FPGA change requires reboot.	Major	20000
Shutdown Event	Set	User requested APP change	<p>Cause: User request requires reboot or internal system error.</p> <p>Remedy: If it is an internal system error fault, clear alarms, reset the unit, notify Cisco customer support if the problem persists.</p>	Runnable application change requires reboot.	Major	20000
Shutdown Event	Set	User requested factory reset	<p>Cause: User request requires reboot or internal system error.</p> <p>Remedy: If it is an internal system error fault, clear alarms, reset the unit, notify Cisco customer support if the problem persists.</p>	Factory reset requires reboot.	Major	20000

Alarm	Message Type	Message	Cause/Remedy	Description	Severity	ID
Shutdown Event	Set	User requested reboot	<p>Cause: User request requires reboot or internal system error.</p> <p>Remedy: If it is an internal system error fault, clear alarms, reset the unit, notify Cisco customer support if the problem persists.</p>	User reboot request.	Major	20000
Shutdown Event	Set	User requested service restore	<p>Cause: User request requires reboot or internal system error.</p> <p>Remedy: If it is an internal system error fault, clear alarms, reset the unit, notify Cisco customer support if the problem persists.</p>	Restore operation required restart	Major	20000
Shutdown Event	Set	PRODUCTION - Protect Flash	<p>Cause: User request requires reboot or internal system error.</p> <p>Remedy: If it is an internal system error fault, clear alarms, reset the unit, notify Cisco customer support if the problem persists.</p>	Reboot after production tables removed.	Major	20000
Shutdown Event	Set	I2C Failure	<p>Cause: Possible software/hardware issue.</p> <p>Remedy: Clear alarms, reset unit, notify Cisco customer support if problem persists.</p>	Internal system error.	Major	20000

Chapter 6 Service and Maintenance

Alarm	Message Type	Message	Cause/Remedy	Description	Severity	ID
Shutdown Event	Set	WDOG: FPGA not loaded	<p>Cause: Possible software/hardware issue.</p> <p>Remedy: Clear alarms, reset unit, notify Cisco customer support if problem persists.</p>	FPGA has not been loaded.	Major	20000
Shutdown Event	Set	osal_SetDataFor AllTasks	<p>Cause: Possible software issue.</p> <p>Remedy: Clear alarms, reset unit, notify Cisco customer support if problem persists.</p>	Application initialization error.	Major	20000
Shutdown Event	Set	aw_LoadFaultList	<p>Cause: Possible software issue.</p> <p>Remedy: Clear alarms, reset unit, notify Cisco customer support if problem persists.</p>	Application initialization error.	Major	20000
Shutdown Event	Set	osal_Init	<p>Cause: Possible software issue.</p> <p>Remedy: Clear alarms, reset unit, notify Cisco customer support if problem persists.</p>	Application initialization error.	Major	20000
Shutdown Event	Set	NVS FLASH mounted	<p>Cause: Possible software issue.</p> <p>Remedy: Clear alarms, reset unit, notify Cisco customer support if problem persists.</p>	Application initialization error.	Major	20000

Alarm	Message Type	Message	Cause/Remedy	Description	Severity	ID
Shutdown Event	Set	DB_Table_Cl::populateNvsRecords	Cause: Possible software issue. Remedy: Clear alarms, reset unit, notify Cisco customer support if problem persists.	Application initialization error.	Major	20000
Shutdown Event	Set	STAPI_Init	Cause: Possible software issue. Remedy: Clear alarms, reset unit, notify Cisco customer support if problem persists.	Application initialization error.	Major	20000
Shutdown Event	Set	dprm startup	Cause: Possible software issue. Remedy: Clear alarms, reset unit, notify Cisco customer support if problem persists.	Application initialization error.	Major	20000
Shutdown Event	Set	dprm clear startup	Cause: Possible software issue. Remedy: Clear alarms, reset unit, notify Cisco customer support if problem persists.	Application initialization error.	Major	20000
Shutdown Event	Set	DB_Array32_Cl init failed	Cause: Possible software issue. Remedy: Clear alarms, reset unit, notify Cisco customer support if problem persists.	Application initialization error.	Major	20000

Chapter 6 Service and Maintenance

Alarm	Message Type	Message	Cause/Remedy	Description	Severity	ID
Shutdown Event	Set	DB_FlagArray32_Cl init failed	Cause: Possible software issue. Remedy: Clear alarms, reset unit, notify Cisco customer support if problem persists.	Application initialization error.	Major	20000
Shutdown Event	Set	Wrong DB Item detected: item = AAA, table = BBB	Cause: Possible software issue. Remedy: Clear alarms, reset unit, notify Cisco customer support if problem persists.	Application initialization error.	Major	20000
Shutdown Event	Set	DB_Item_Cl::add Item() failed	Cause: Possible software issue. Remedy: Clear alarms, reset unit, notify Cisco customer support if problem persists.	Application initialization error.	Major	20000
Shutdown Event	Set	Memory allocation error on DB table construction	Cause: Possible software issue. Remedy: Clear alarms, reset unit, notify Cisco customer support if problem persists.	Application initialization error.	Major	20000
Shutdown Event	Set	DB_Table_Cl::addTable() failed	Cause: Possible software issue. Remedy: Clear alarms, reset unit, notify Cisco customer support if problem persists.	Application initialization error.	Major	20000

Alarm	Message Type	Message	Cause/Remedy	Description	Severity	ID
Shutdown Event	Set	DB_Table_Cl::addItem() failed: too many DB Items	Cause: Possible software issue. Remedy: Clear alarms, reset unit, notify Cisco customer support if problem persists.	Application initialization error.	Major	20000
Shutdown Event	Set	DBT Init Failed: AAA	Cause: Possible software issue. Remedy: Clear alarms, reset unit, notify Cisco customer support if problem persists.	Application initialization error.	Major	20000
Shutdown Event	Set	Framework Registration Error	Cause: Possible software issue. Remedy: Clear alarms, reset unit, notify Cisco customer support if problem persists.	Application initialization error.	Major	20000
Shutdown Event	Set	7109 exception! Code = X, Address = Y, Task = Z	Cause: Possible software issue. Remedy: Clear alarms, reset unit, notify Cisco customer support if problem persists.	Application initialization error.	Major	20000
Shutdown Event	Set	Memory Error: AAA, Phase X	Cause: Possible software issue. Remedy: Clear alarms, reset unit, notify Cisco customer support if problem persists.	Application initialization error.	Major	20000

Chapter 6 Service and Maintenance

Alarm	Message Type	Message	Cause/Remedy	Description	Severity	ID
Shutdown Event	Set	Time Control object creation failed	Cause: Possible software issue. Remedy: Clear alarms, reset unit, notify Cisco customer support if problem persists.	Application initialization error.	Major	20000
Shutdown Event	Set	Wrong UIC Item detected: item = AAA, table BBB	Cause: Possible software issue. Remedy: Clear alarms, reset unit, notify Cisco customer support if problem persists.	Application initialization error.	Major	20000
Shutdown Event	Set	Memory allocation error on UIC table construction	Cause: Possible software issue. Remedy: Clear alarms, reset unit, notify Cisco customer support if problem persists.	Application initialization error.	Major	20000
Shutdown Event	Set	Error adding UIC table(AAA)	Cause: Possible software issue. Remedy: Clear alarms, reset unit, notify Cisco customer support if problem persists.	Application initialization error.	Major	20000
Shutdown Event	Set	HTTP - http_init4() FAILED to create partition	Cause: Possible software issue. Remedy: Clear alarms, reset unit, notify Cisco customer support if problem persists.	Application initialization error.	Major	20000

Alarm	Message Type	Message	Cause/Remedy	Description	Severity	ID
Shutdown Event	Set	http_init4: FAILED to allocate scratch buffer	Cause: Possible software issue. Remedy: Clear alarms, reset unit, notify Cisco customer support if problem persists.	Application initialization error.	Major	20000
Shutdown Event	Set	HTTP - http_init4() FAILED to allocate memory from AVMEM Partition	Cause: Possible software issue. Remedy: Clear alarms, reset unit, notify Cisco customer support if problem persists.	Application initialization error.	Major	20000
Shutdown Event	Set	UD - ud_init_phase_4() FAILED to allocate memory from System Partition	Cause: Possible software issue. Remedy: Clear alarms, reset unit, notify Cisco customer support if problem persists.	Application initialization error.	Major	20000
Shutdown Event	Set	UD - ud_init_phase_4() FAILED to create partition	Cause: Possible software issue. Remedy: Clear alarms, reset unit, notify Cisco customer support if problem persists.	Application initialization error.	Major	20000
Shutdown Event	Set	'-- COMPONENT 'AAA' FAILED TO INIT IN PHASE X, rc=NNN	Cause: Possible software issue. Remedy: Clear alarms, reset unit, notify Cisco customer support if problem persists.	Application initialization error.	Major	20000

Chapter 6 Service and Maintenance

Alarm	Message Type	Message	Cause/Remedy	Description	Severity	ID
Shutdown Event	Set	VBI DB creation failed	Cause: Possible software issue. Remedy: Clear alarms, reset unit, notify Cisco customer support if problem persists.	Application initialization error.	Major	20000
Shutdown Event	Set	VBI DB allocation failed	Cause: Possible software issue. Remedy: Clear alarms, reset unit, notify Cisco customer support if problem persists.	Application initialization error.	Major	20000
Shutdown Event	Set	VBI Status DB creation failed	Cause: Possible software issue. Remedy: Clear alarms, reset unit, notify Cisco customer support if problem persists.	Application initialization error.	Major	20000
Shutdown Event	Set	VBI Status DB allocation failed	Cause: Possible software issue. Remedy: Clear alarms, reset unit, notify Cisco customer support if problem persists.	Application initialization error.	Major	20000
Shutdown Event	Set	UIC_ENUM_CL given invalid ENUM_ST: item = AAA, table = BBB, problem with primary: X	Cause: Possible software issue. Remedy: Clear alarms, reset unit, notify Cisco customer support if problem persists.	Application initialization error.	Major	20000

Alarm	Message Type	Message	Cause/Remedy	Description	Severity	ID
Shutdown Event	Set	FW: Memory or List Full	Cause: Possible software issue. Remedy: Clear alarms, reset unit, notify Cisco customer support if problem persists.	Internal system error.	Major	20000
Shutdown Event	Set	Framework Registration Error	Cause: Possible software issue. Remedy: Clear alarms, reset unit, notify Cisco customer support if problem persists.	Internal system error.	Major	20000
Shutdown Event	Set	Watchdog 'AAA' has expired	Cause: Possible software issue. Remedy: Clear alarms, reset unit, notify Cisco customer support if problem persists.	Software detected an error in operation.	Major	20000
System Startup	Set	System Startup	Cause: The unit has started up and it indicates an expected or unexpected reset. Remedy: If a startup was unexpected, check for last reset cause. Notify Cisco customer support if problem persists.	Indicates that the decoder has started up. This alarm will clear itself after one second.	Major	20100

Chapter 6 Service and Maintenance

Alarm	Message Type	Message	Cause/Remedy	Description	Severity	ID
SMI Setup	Set	Phase lock error on SMI SDRAM	Cause: Hardware Issue. Remedy: Clear alarms, reset the unit, and notify Cisco customer support if the problem persists.	SDRAM on SMI bus not working.	Major	21000
SMI Setup	Set	SMI SDRAM exhaust test failed	Cause: Hardware Issue. Remedy: Clear alarms, reset the unit, and notify Cisco customer support if the problem persists.	SDRAM on SMI bus not working.	Major	21000
SMI Setup	Clear	SMI SDRAM setup successful		SDRAM on SMI Bus OK.	Major	21000
SMI Setup	Clear	SMI SDRAM exhaust test passed		SDRAM on SMI Bus OK.	Major	21000
LMI setup	Set	LMI SDRAM exhaust test failed	Cause: Hardware issue. Remedy: Clear alarms, reset the unit, and notify Cisco customer support if the problem persists.	DDR RAM on LMI bus not working.	Major	22000
LMI setup	Clear	LMI Video SDRAM exhaust test passed		DDR RAM on LMI bus OK.	Major	22000
Param Storage	Set	DB NVS flushing ignored	Cause: Hardware issue. Remedy: Clear alarms, reset the unit, and notify Cisco customer support if the problem persists.	Non-volatile storage system failed to update fully.	Major	23000

Alarm	Message Type	Message	Cause/Remedy	Description	Severity	ID
Param Storage	Set	RAM flush to NVS failed	Cause: Hardware issue. Remedy: Clear alarms, reset the unit, and notify Cisco customer support if the problem persists.	Non-volatile storage system failed to update fully.	Major	23000
Param Storage	Set	DB Factory Reset in progress	Cause: Standard operation. Remedy: Clear alarms, reset the unit, and notify Cisco customer support if the problem persists.	Non-volatile storage system operation in progress.	Major	23000
Param Storage	Set	DB Total Reset in progress	Cause: Standard operation. Remedy: Clear alarms, reset the unit, and notify Cisco customer support if the problem persists.	Non-volatile storage system operation in progress.	Major	23000
Param Storage	Set	DB NVS flush in progress	Cause: Standard operation. Remedy: Clear alarms, reset the unit, and notify Cisco customer support if the problem persists.	Non-volatile storage system operation in progress.	Major	23000
Param Storage	Set	DB Populate in progress	Cause: Standard operation. Remedy: Clear alarms, reset the unit, and notify Cisco customer support if the problem persists.	Non-volatile storage system operation in progress.	Major	23000

Chapter 6 Service and Maintenance

Alarm	Message Type	Message	Cause/Remedy	Description	Severity	ID
Param Storage	Set	DB Factory Reset failed	Cause: Hardware issue. Remedy: Clear alarms, reset the unit, and notify Cisco customer support if the problem persists.	Non-volatile storage system failed during operation.	Major	23000
Param Storage	Set	DB Total Reset failed	Cause: Hardware issue. Remedy: Clear alarms, reset the unit, and notify Cisco customer support if the problem persists.	Non-volatile storage system failed during operation.	Major	23000
Param Storage	Set	DB Populate failed	Cause: Hardware issue. Remedy: Clear alarms, reset the unit, and notify Cisco customer support if the problem persists.	Non-volatile storage system failed during operation.	Major	23000
Param Storage	Set	DB NVS flush failed	Cause: Hardware issue. Remedy: Clear alarms, reset the unit, and notify Cisco customer support if the problem persists.	Non-volatile storage system failed during operation.	Major	23000
Param Storage	Clear	DB flushing completed	-	Successful NVS update.	Major	23000
Param Storage	Clear	DB Factory Reset completed	-	Non-volatile storage system operation successful	Major	23000
Param Storage	Clear	DB Total Reset completed	-	Non-volatile storage system operation successful	Major	23000

Alarm	Message Type	Message	Cause/Remedy	Description	Severity	ID
Param Storage	Clear	DB NVS flush completed	-	Non-volatile storage system operation successful	Major	23000
Param Storage	Clear	DB Populate completed	-	Non-volatile storage system operation successful	Major	23000
Flash Storage	Set	RECORD: init failed	Cause: Hardware issue. Remedy: Clear alarms, reset the unit, and notify Cisco customer support if the problem persists.	Non-volatile storage system corrupted. Possible loss of configuration.	Major	24000
Flash Storage	Set	RECORD MANAGER: Record contents check error, erasing all	Cause: Hardware issue. Remedy: Clear alarms, reset the unit, and notify Cisco customer support if the problem persists.	NVS Corruption, and loss of configuration data	Major	24000
Flash Storage	Set	RECORD: sector setup check error, erasing sector	Cause: Hardware issue. Remedy: Clear alarms, reset the unit, and notify Cisco customer support if the problem persists.	NVS Corruption, and loss of sector data	Major	24000
Flash Storage	Clear	RECORD: init done	-	-	Major	24000

Chapter 6 Service and Maintenance

Alarm	Message Type	Message	Cause/Remedy	Description	Severity	ID
LNB PS	Set	LNBPS: No Load	Cause: Possible wiring or hardware issue. Remedy: Clear alarms, reset the unit, and notify Cisco customer support if the problem persists.	LNB power overload	Minor	25000
LNB PS	Set	LNBPS: Over Temperature	Cause: Possible wiring or hardware issue. Remedy: Clear alarms, reset the unit, and notify Cisco customer support if the problem persists.	LNB power overload	Minor	25000
LNB PS	Set	LNBPS: Over Loaded	Cause: Possible wiring or hardware issue. Remedy: Clear alarms, reset the unit, and notify Cisco customer support if the problem persists.	LNB power overload	Minor	25000
LNB PS	Set	LNBPS: Short Circuit	Cause: Possible wiring or hardware issue. Remedy: Clear alarms, reset the unit, and notify Cisco customer support if the problem persists.	LNB power overload	Minor	25000
LNB PS	Clear	LNBPS: Normal	-	LNB power OK	Minor	25000
LNB PS	Clear	LNBPS: Disabled	-	-	Minor	25000
LNB PS	Clear	LNBPS: Off	-	-	Minor	25000

Alarm	Message Type	Message	Cause/Remedy	Description	Severity	ID
Flash Sector Error	Set	Check setting. Counted %d events on %s. See User Manual	<p>Cause: A sector on FLASH %s (Pri, Sec,Trans 1 or Trans 2) was found corrupted on power-up, which was not a result of an interrupted erase. The problem happened %d times on this FLASH, during a lifetime.</p> <p>Remedy: Check if the desired application is sunning and if the settings are valid.</p>	FLASH recovered after unexpected corruption.	Minor	25500
Signal Quality	Set	Audio Muted due to RF noise	<p>Cause: RF Signal quality is poor due to interference or signal level issues.</p> <p>Remedy: Check RF settings, re-aim dish, and add signal amplifier.</p>	Signal is locked but BER is beyond Audio muting threshold.	Minor	26000
Signal Quality	Set	Unstable RF Signal	<p>Cause: RF Signal quality is poor due to interference or signal level issues.</p> <p>Remedy: Check RF settings, re-aim dish, and add signal amplifier.</p>	Signal lock status is toggling frequently.	Minor	26000
Signal Quality	Set	Poor Quality RF Signal	<p>Cause: RF Signal quality is poor due to interference or signal level issues.</p> <p>Remedy: Check RF settings, re-aim dish, and add signal amplifier.</p>	Signal is locked but BER is beyond muting threshold.	Minor	26000

Chapter 6 Service and Maintenance

Alarm	Message Type	Message	Cause/Remedy	Description	Severity	ID
Signal Quality	Clear	Signal Quality Fault Cleared	-	-	Minor	26000
Signal Quality	Clear	Audio Unmuted	-	-	Minor	26000
Transport Processing	Set	PTI lockup	Cause: Possible software issue. Remedy: Clear alarms, reset unit, and notify Cisco customer support if problem persists.	Programmable transport input module stopped processing any data packet.	Minor	27000
Transport Processing	Clear	PTI running	-	-	Minor	27000
Version Mismatch	Set	Version Mismatch between 5514/7109	Cause: The App5514 version does not match the App7109 version. Remedy: Download code with identical App5514 and App7109 versions.	Version mismatch between code running 5514 and 7109 versions.	Major	27400
DL: TEB Comms Failure	Set	Intra-processor comms failure	Cause: Transcoder board issue. Remedy: Clear alarms, reset the unit, and notify Cisco customer support if problem persists.	Internal communication failure.	Major	27500
DL:NVS Flash Failure	Set	APP5514 Flash Write Failed	Cause: Possible hardware or software issue. Remedy: Clear alarms, reset unit, and notify Cisco customer support if problem persists.	Failed to read or write flash memory	Major	27600

Alarm	Message Type	Message	Cause/Remedy	Description	Severity	ID
DL:NVS Flash Failure	Set	APP/SAT7109/PC CRC/Write has Failed	Cause: Possible hardware or software issue. Remedy: Clear alarms, reset unit, and notify Cisco customer support if problem persists.	Failed to read or write flash memory	Major	27600
Temperature Alarm	Set	Temperature over Alarm threshold	Cause: Room temperature too high, or air flow is blocked. Remedy: Check openings on front and rear panels for blockage. Lower room temperature or improve air flow to device.	Temperature is above safe operating range.	Major	28000
Temperature Alarm	Clear	Temperature normal	-	Temperature is within the safe operating range.	Major	28000
Fan	Set	Fan RPM Alarm	Cause: Hardware issue. Remedy: Unit should be returned to Cisco customer support as soon as possible.	Fan RPM out of normal operating range.	Major	29000
Fan	Clear	Fans Operational	-	-	Major	29000

Chapter 6 Service and Maintenance

Alarm	Message Type	Message	Cause/Remedy	Description	Severity	ID
FPGA Temperature Alarm	Set	Temperature over Alarm threshold	Cause: Room temperature too high, or air flow is blocked. Remedy: Check openings on front and rear panels for blockage. Lower room temperature or improve air flow to device.	FPGA temperature is above safe operating range.	Major	30000
FPGA Temperature Alarm	Clear	Temperature normal	-	FPGA temperature is within the safe operating range.	Major	30000
TXB FPGA Temper. Alarm	Set	Temperature over Alarm threshold	Cause: Room temperature too high, or air flow is blocked. Remedy: Check the openings on the front and rear panels for blockage, assess the room temperature. Lower the room temperature or improve air flow to the device.	The transcoder board FPGA temperature is above the safe operating range.	Major	31100
TXB FPGA Temper. Alarm	Clear	Temperature normal		The transcoder board FPGA temperature is within the safe operating range.	Major	31100

Alarm	Message Type	Message	Cause/Remedy	Description	Severity	ID
TXB ENC Temper. Alarm	Set	Temperature over Alarm threshold	<p>Cause: Room temperature too high, or air flow is restricted.</p> <p>Remedy: Check the openings on front and rear panels for blockage, assess the room temperature. Lower the room temperature or improve air flow to the device.</p>	The transcoder board encoder temperature is above safe operating range.	Major	33100
TXB ENC Temper. Alarm	Clear	Temperature normal	-	The transcoder board encoder temperature is within the safe operating range.	Major	33100
ASI Out Status	Set	ASI Overflow. Output Muted. Reduce content.	<p>Cause: Uplink settings may have changed since setup of the unit. Variable Bit Rate/Statmuxed streams may be in use.</p> <p>Remedy: Increase the output rate, drop unreferenced content in DPM Options, and/or drop programs not needed for downstream devices. Contact your (uplink) service provider to verify the expected bit rate settings.</p>	Current transport rate exceeds configured rate for ASI output. Output has been muted to protect downstream devices.	Minor	34000
ASI Out Status	Clear	ASI Output Restored	-	-	Minor	34000

Chapter 6 Service and Maintenance

Alarm	Message Type	Message	Cause/Remedy	Description	Severity	ID
MPoIP Status	Set	MPEGoIP Overflow. Output Muted. Reduce content.	Cause: Uplink settings may have changed since the setup of the unit. Variable Bit Rate/Statmuxed streams may be in use. Remedy: Increase output rate, drop unreferenced content in DPM Options, drop programs not needed for downstream devices. Contact uplink to verify expected bit rate settings.	Current transport rate exceeds configured rate for MPEG over IP output. The output has been muted to protect the downstream devices.	Minor	35000
MPoIP Status	Clear	MPEGoIP Output Restored	-	-	Minor	35000
Boot Host	Set	KB not accessible	Cause: Hardware issue Remedy: Clear alarms, reset unit, and notify Cisco customer support if the problem persists.	KB is not detected by Boot code.	Major	36000
Boot Host	Set	LCD not connected	Cause: Hardware issue Remedy: Clear alarms, reset unit, and notify Cisco customer support if the problem persists.	LCD is not detected by Boot code.	Major	36000

Alarm	Message Type	Message	Cause/Remedy	Description	Severity	ID
Boot Host	Set	FLASH Not Found	Cause: Hardware issue Remedy: Clear alarms, reset unit, and notify Cisco customer support if the problem persists.	Flash memory not detected.	Major	36000
Boot Host	Set	EMI SDRAM Test Failed	Cause: Hardware issue Remedy: Clear alarms, reset unit, and notify Cisco customer support if the problem persists.	RAM Failure - memory testing failed.	Major	36000
Boot Host	Set	BOOT Invalid	Cause: Hardware issue Remedy: Clear alarms, reset unit, and notify Cisco customer support if the problem persists.	Boot SW cannot be read from memory correctly.	Major	36000
Boot Host	Set	APP Invalid	Cause: Hardware issue Remedy: Clear alarms, reset unit, and notify Cisco customer support if the problem persists.	Application SW cannot be read from memory correctly.	Major	36000
Boot Host	Clear	BOOT passed	-	-	Major	36000
Boot Secondary	Set	BOOT Invalid	Cause: Hardware issue. Remedy: Clear alarms, reset the unit, and notify Cisco customer support if the problem persists.	Boot SW cannot be read from memory correctly.	Major	37000

Chapter 6 Service and Maintenance

Alarm	Message Type	Message	Cause/Remedy	Description	Severity	ID
Boot Secondary	Set	FPGA Invalid	Cause: Hardware issue. Remedy: Clear alarms, reset the unit, and notify Cisco customer support if the problem persists.	FPGA Image cannot be read from memory correctly.	Major	37000
Boot Secondary	Set	APP Invalid	Cause: Hardware issue. Remedy: Clear alarms, reset the unit, and notify Cisco customer support if the problem persists.	Application SW cannot be read from memory correctly.	Major	37000
Boot Secondary	Clear	BOOT passed	-	-	Major	37000
Decoder Processor Start	Set	DB Startup failed	Cause: Hardware issue. Remedy: Clear alarms, reset the unit, and notify Cisco customer support if the problem persists.	Transfer of operational parameters to secondary processor failed.	Major	38000
Decoder Processor Start	Set	App Transfer Fail	Cause: Hardware issue. Remedy: Clear alarms, reset the unit, and notify Cisco customer support if the problem persists.	Transfer of Application software to second processor was not correctly completed.	Major	38000
Decoder Processor Start	Set	No Response	Cause: Hardware issue. Remedy: Clear alarms, reset the unit, and notify Cisco customer support if the problem persists.	Secondary processor not responding.	Major	38000

Alarm	Message Type	Message	Cause/Remedy	Description	Severity	ID
Decoder Processor Start	Set	Synchronization Failure	Cause: Hardware issue. Remedy: Clear alarms, reset the unit, and notify Cisco customer support if the problem persists.	Communication with secondary processor failing.	Major	38000
Decoder Processor Start	Clear	Boot passed	-	-	Major	38000
LEC Timeout	Set	LEC Table Missing/timeout: channels currently unavailable	Cause: Possible LEC Server or Uplink issue. Remedy: Check LEC Server setup and uplink configuration for GDS PID setup. Clear alarm and notify Cisco customer support if the problem persists.	ECT Table is not received in the GDS stream.	Major	38500
LEC Timeout	Clear	LEC received	-	-	Major	38500
FPGA status	Set	FPGA Init failed to go high	Cause: Hardware issue. Remedy: Clear alarms, reset the unit, notify Cisco customer support if the problem persists.	FPGA setup failure or the FPGA binary identity does not match the FPGA registers.	Major	39000
FPGA status	Set	FPGA Init and Done failed to go low	Cause: Hardware issue. Remedy: Clear alarms, reset the unit, notify Cisco customer support if the problem persists.	FPGA setup failure or the FPGA binary identity does not match the FPGA registers.	Major	39000

Chapter 6 Service and Maintenance

Alarm	Message Type	Message	Cause/Remedy	Description	Severity	ID
FPGA status	Set	FPGA Init went LOW (CRC error)	Cause: Hardware issue. Remedy: Clear alarms, reset the unit, notify Cisco customer support if the problem persists.	FPGA setup failure or the FPGA binary identity does not match the FPGA registers.	Major	39000
FPGA status	Set	FPGA Done failed to go high	Cause: Hardware issue. Remedy: Clear alarms, reset the unit, notify Cisco customer support if the problem persists.	FPGA setup failure or the FPGA binary identity does not match the FPGA registers.	Major	39000
FPGA status	Set	SW ver outside upper or lower limit	Cause: Hardware issue. Remedy: Clear alarms, reset the unit, notify Cisco customer support if the problem persists.	FPGA setup failure or the FPGA binary identity does not match the FPGA registers.	Major	39000
FPGA status	Set	FPGA ID does not match FPGA DESIGNATION	Cause: Hardware issue. Remedy: Clear alarms, reset the unit, notify Cisco customer support if the problem persists.	FPGA setup failure or the FPGA binary identity does not match the FPGA registers.	Major	39000
FPGA status	Set	FPGA ID does not match HW FPGA ID	Cause: Hardware issue. Remedy: Clear alarms, reset the unit, notify Cisco customer support if the problem persists.	FPGA setup failure or the FPGA binary identity does not match the FPGA registers.	Major	39000
FPGA status	Clear	FPGA loaded successfully and reset	-	-	Major	39000

Alarm	Message Type	Message	Cause/Remedy	Description	Severity	ID
PE <n>: CA System Error	Set	No PowerVU support	Cause: The current channel assigned to this Program Entry is scrambled using an unsupported CA System. Remedy: Check to ensure that the proper channel is assigned to this Program Entry.	CA System present in the currently selected channel cannot be descrambled due to no PowerVU ISE support.	Minor	93000-93031
PE <n>: CA System Error	Set	No Matching CAM	Cause: The current channel assigned to this Program Entry is scrambled using an unsupported CA System. Remedy: Check to ensure that the proper channel is assigned to this Program Entry.	CA System present in the currently selected channel cannot be descrambled due to no PowerVU ISE support.	Minor	93000-93031
PE <n>: CA System Error	Clear	Fault cleared	-	-	Minor	93000-93031
Xcode License Fault	Set	Working transcoders are fewer than the licenses	Cause: Possible hardware failure. Remedy: Contact Cisco customer support.	The number of working transcoders are fewer than the number of licenses provisioned	Major	93106
Xcode License Fault	Clear	Transcoder working	-	-	Major	93106

Chapter 6 Service and Maintenance

Alarm	Message Type	Message	Cause/Remedy	Description	Severity	ID
Xcode Load Status	Set	Failed on PE(s): x,y,z	Cause: Transcoder chip is not functional. This is a possible hardware issue. Remedy: Reboot the unit. If the issue is intermittent, the condition may be cleared by the reboot.	The software is unable to initialize the transcoder chip.	Major	94008
Xcode Load Status	Clear	Fault cleared	-	-	Major	94008
Transcoder Reset	Set	Failed on PE(s): x,y,z	Cause: Transcoder chip is not functional. This is a possible hardware issue. Remedy: Reboot the unit. If the issue is intermittent, the condition may be cleared by the reboot.	The software is unable to initialize the transcoder chip	Major	94010
Transcoder Reset	Clear	Fault cleared	-	-	Major	94010
Transcoder Firmware	Set	Failure to load or Init Transcoder firmware	Cause: Possible problem with the transcoder. Remedy: Power-cycle the unit. If the problem persists or occurs frequently, contact Cisco customer support.	Attempt to load or re-load the transcoder firmware has not been successful and the transcoded output will not be present.	Major	94011
Transcoder Firmware	Clear	Load and Init Completed	-	-	Major	94011

Alarm	Message Type	Message	Cause/Remedy	Description	Severity	ID
Disaster Declared	Set	Disaster declared	Cause: One or more of the following is detected: RF lock loss, unstable RF signal, and/or transport loss (RF locked, but no transport stream packet received) Remedy: A valid signal.	A disaster is detected.	Major	98000
Disaster Declared	Reset	No disaster	-	Disaster recovery feature is cleared with a valid signal.	Major	98000

Warnings

Warning	Message Type	Message	Cause/Remedy	Description	ID
Transcoding Condition	Set	Transcoding Error: Decoder timeout	Cause: Possible software issue. Remedy: Clear alarms, reset the unit, and notify Cisco customer support if the problem persists.	The transcoder has lost connection with the decoder.	39500
Transcoding Condition	Set	Transcoding Error: Encoder	Cause: Possible software issue. Remedy: Clear alarms, reset the unit, and notify Cisco customer support if the problem persists.	The transcoder encoder encountered an error.	39500
Transcoding Condition	Set	Transcoding Error: Encoder timeout	Cause: Possible software issue. Remedy: Clear alarms, reset the unit, and notify Cisco customer support if the problem persists.	The transcoder has lost connection with the encoder.	39500

Chapter 6 Service and Maintenance

Warning	Message Type	Message	Cause/Remedy	Description	ID
Transcoding Condition	Set	Transcoding configuration error: timeout	Cause: Possible software issue. Remedy: Clear alarms, reset the unit, and notify Cisco customer support if the problem persists.	No response was received from the transcoder to configuration message.	39500
Transcoding Condition	Set	Transcoding configuration error: socket error	Cause: Possible software issue. Remedy: Clear alarms, reset the unit, and notify Cisco customer support if the problem persists.	Unable to send the configuration to the transcoder.	39500
Transcoding Condition	Set	Transcoding retrieve error: refused	Cause: Possible software issue. Remedy: Clear alarms, reset the unit, and notify Cisco customer support if the problem persists.	The transcoder refused to return requested information.	39500
Transcoding Condition	Set	Transcoding cmd msg error: refused	Cause: Possible software issue. Remedy: Clear alarms, reset the unit, and notify Cisco customer support if the problem persists.	The transcoder refused a given command.	39500
Transcoding Condition	Set	Transcoding config error: refused	Cause: Configuration may have an invalid parameter, or possible software issue. The transcoder refused the configuration. Remedy: Check configuration, clear alarms, reset the unit, and notify Cisco customer support if problem persists.	The transcoder refused the configuration.	39500
Transcoding Condition	Clear	Transcoding cmd msg operational	-	-	39500
Transcoding Condition	Clear	Transcoding retrieve operational	-	-	39500

Warning	Message Type	Message	Cause/Remedy	Description	ID
Transcoding Condition	Clear	Transcoding config operational	-	-	39500
Transcoding Condition	Clear	Transcoding operational	-	-	39500
ASI TS Overflow	Set	ASI Output Overflow	<p>Cause: Uplink settings may have changed since setting up the unit. Variable bit rate or statmuxed streams may be in use.</p> <p>Remedy: Increase the output rate, drop unreferenced content in DPM Options, and drop the programs that are not needed for downstream devices. Contact your (uplink) service provider to verify the expected bit rate settings.</p>	The output rate is higher than level set by the user.	40000
ASI TS Overflow	Clear	ASI Output Overflow Cleared	-	-	40000
Transport Error	Set	Continuity Count Error	<p>Cause: Possible uplink or signal issue.</p> <p>Remedy: Clear warnings, reset the unit, and notify Cisco customer support if the problem persists.</p>	Transport packet continuity count jumped. Possible packet loss.	42000
Transport Error	Set	Buffer Overflow	<p>Cause: Possible uplink or signal issue.</p> <p>Remedy: Clear warnings, reset the unit, and notify Cisco customer support if the problem persists.</p>	The transport stream is faster than the maximum buffer or the decode engines are having difficulty handling the data sent to them.	42000

Chapter 6 Service and Maintenance

Warning	Message Type	Message	Cause/Remedy	Description	ID
Transport Error	Set	Transport Error Indicator	<p>Cause: Possible uplink or signal issue.</p> <p>Remedy: Clear warnings, reset the unit, and notify Cisco customer support if the problem persists.</p>	Transport packets are marked as "errored" upstream of the decoder.	42000
Transport Error	Set	Transport Rate Error: FPGA Overflow	<p>Cause: Uplink settings may have changed since setting up the unit.</p> <p>Remedy: Increase the output rate, drop unreferenced content in DPM Options, and/or drop programs not needed for downstream devices. Contact your (uplink) service provider to verify the expected bit rate settings.</p>	The output rate is higher than level set by the user.	42000
Transport Error	Clear	Continuity Count Error Cleared	-	Trap expires after 30 seconds.	42000
Transport Error	Clear	Buffer Overflow Cleared	-	Trap expires after 30 seconds.	42000
Transport Error	Clear	Transport Error Indicator Cleared	-	Trap expires after 30 seconds.	42000
Transport Error	Clear	Transport Rate Error: FPGA Overflow Cleared	-	Trap expires after 30 seconds.	42000
Video Format Mismatch	Set	Video format mismatch	-	Video Format Mismatch.	43000
Video Format Mismatch	Clear	Video format match	-	-	43000

Warning	Message Type	Message	Cause/Remedy	Description	ID
Temperature Warning	Set	Temperature over Warning threshold	Cause: Room temperature too high, or air flow is blocked. Remedy: Check openings on front and rear panels for blockage. Lower the room temperature or improve air flow to the device.	Temperature is above normal operating range.	44000
Temperature Warning	Clear	Temperature normal	-	Temperature is within the normal operating range.	44000
FPGA Temperature Warning	Set	Temperature over Warning threshold	Cause: Room temperature is too high, or air flow is blocked. Remedy: Check the openings on front and rear panels for blockage. Lower the room temperature or improve air flow to the device.	FPGA temperature is above normal operating range.	45000
FPGA Temperature Warning	Clear	Temperature normal	-	FPGA temperature is within the normal operating range.	45000
TXB FPGA Temper. Warning	Set	Temperature over Warning threshold	Cause: Room temperature too high, or air flow is restricted. Remedy: Check openings on front and rear panels for blockage, assess room temperature. Lower room temperature or improve air flow to device.	TXB FPGA temperature is above normal operating range.	46000
TXB FPGA Temper. Warning	Clear	Temperature normal	-	TXB FPGA temperature is within the normal operating range.	46000

Chapter 6 Service and Maintenance

Warning	Message Type	Message	Cause/Remedy	Description	ID
TXB ENC Temper. Warning	Set	Temperature over Warning threshold	Cause: Room temperature too high, or air flow is restricted. Remedy: Check openings on front and rear panels for blockage, assess room temperature. Lower room temperature or improve air flow to device.	TXB encoder temperature is above normal operating range.	46000
TXB ENC Temper. Warning	Clear	Temperature normal	-	TXB encoder temperature is within the normal operating range.	46000
VBI Data	Set	2nd VBI PID attempt to write same line	Cause: Uplink configuration issue. Remedy: Contact uplink to verify expected VBI settings.	Conflicting VBI data on second VBI PID.	49000
VBI Data	Clear	Line Collision Cleared	-	-	49000
TDT timeout #	Set	TDT timed out	Cause: Uplink is not sending or is sending intermittently. Remedy: Clear warning. If the problem persists, determine if uplink is sending the current SI information table. Disable the warning if not using the table.	Time Date Table was never received.	50000
TDT timeout #	Set	TDT is lost	Cause: Uplink is not sending or is sending intermittently. Remedy: Clear warning. If the problem persists, determine if uplink is sending the current SI information table. Disable the warning if not using the table.	No longer receiving Time Date.	50000
TDT timeout #	Clear	TDT fault cleared	-	-	50000

Warning	Message Type	Message	Cause/Remedy	Description	ID
SDT timeout #	Set	SDT # timed out	<p>Cause: Uplink is not sending or is sending intermittently.</p> <p>Remedy: Clear warning. If the problem persists, determine if uplink is sending the current SI information table. Disable the warning if not using the table.</p>	Service Description Table was never received.	51000 52000 53000 54000 55000 56000 57000 58000
SDT timeout #	Set	SDT # is lost	<p>Cause: Uplink is not sending or is sending intermittently.</p> <p>Remedy: Clear warning. If the problem persists, determine if uplink is sending the current SI information table. Disable the warning if not using the table.</p>	No longer receiving Service Description.	51000 52000 53000 54000 55000 56000 57000 58000
SDT timeout #	Clear	SDT fault cleared	-	-	51000 52000 53000 54000 55000 56000 57000 58000
PMT timeout #	Set	PMT # timed out	<p>Cause: Uplink is not sending or is sending intermittently.</p> <p>Remedy: Clear warning. If the problem persists, determine if uplink is sending the current SI information table. Disable the warning if not using the table.</p>	Program Mapping Table was never received.	59000 60000 61000 62000 63000 64000 65000 66000 66009-66032

Chapter 6 Service and Maintenance

Warning	Message Type	Message	Cause/Remedy	Description	ID
PMT timeout #	Set	PMT # is lost	<p>Cause: Uplink is not sending or is sending intermittently.</p> <p>Remedy: Clear warning. If the problem persists, determine if uplink is sending the current SI information table. Disable the warning if not using the table.</p>	No longer receiving Program Mapping Table.	59000 60000 61000 62000 63000 64000 65000 66000 66009-66032
PMT timeout #	Clear	PMT fault cleared	-	-	59000 60000 61000 62000 63000 64000 65000 66000 66009-66032
PAT timeout #	Set	PAT # timed out	<p>Cause: Uplink is not sending or is sending intermittently.</p> <p>Remedy: Clear warning. If the problem persists, determine if uplink is sending the current SI information table. Disable the warning if not using the table.</p>	Program Association Table was never received.	67000 68000 69000 70000 71000 72000 73000 74000
PAT timeout #	Set	PAT # is lost	<p>Cause: Uplink is not sending or is sending intermittently.</p> <p>Remedy: Clear warning. If the problem persists, determine if uplink is sending the current SI information table. Disable the warning if not using the table.</p>	No longer receiving Program Association Table.	67000 68000 69000 70000 71000 72000 73000 74000

Warning	Message Type	Message	Cause/Remedy	Description	ID
PAT timeout #	Clear	PAT fault cleared	-	-	67000 68000 69000 70000 71000 72000 73000 74000
NIT timeout #	Set	NIT timed out	Cause: Uplink is not sending or is sending intermittently. Remedy: Clear warning. If the problem persists, determine if uplink is sending the current SI information table. Disable the warning if not using the table.	Network Information Table was never received.	75000
NIT timeout #	Set	NIT is lost	Cause: Uplink is not sending or is sending intermittently. Remedy: Clear warning. If the problem persists, determine if uplink is sending the current SI information table. Disable the warning if not using the table.	No longer receiving Network Information Table.	75000
NIT timeout #	Clear	NIT fault cleared	-	-	75000
CAT timeout #	Set	CAT timed out	Cause: Uplink is not sending or is sending intermittently. Remedy: Clear warning. If the problem persists, determine if uplink is sending the current SI information table. Disable the warning if not using the table.	Conditional Access Table was never received.	76000

Chapter 6 Service and Maintenance

Warning	Message Type	Message	Cause/Remedy	Description	ID
CAT timeout #	Set	CAT is lost	<p>Cause: Uplink is not sending or is sending intermittently.</p> <p>Remedy: Clear warning. If the problem persists, determine if uplink is sending the current SI information table. Disable the warning if not using the table.</p>	No longer receiving Conditional Access Table.	76000
CAT timeout #	Clear	CAT fault cleared	-	-	76000
DRT timeout #	Set	DRT # timed out	<p>Cause: Uplink is not sending or is sending intermittently.</p> <p>Remedy: Clear warning. If the problem persists, determine if uplink is sending the current SI information table. Disable the warning if not using the table.</p>	Disaster Recovery Table was never received.	77000
DRT timeout #	Set	DRT # is lost	<p>Cause: Uplink is not sending or is sending intermittently.</p> <p>Remedy: Clear warning. If the problem persists, determine if uplink is sending the current SI information table. Disable the warning if not using the table.</p>	No longer receiving Disaster Recovery Table.	77000
DRT timeout #	Clear	DRT fault cleared	-	-	77000
MCT Timeout #	Set	MCT # timed out	<p>Cause: Uplink is not sending or is sending intermittently.</p> <p>Remedy: Clear warning. If the problem persists, determine if uplink is sending the current SI information table. Disable the warning if not using the table.</p>	Inband Control Table was never received.	77100

Warning	Message Type	Message	Cause/Remedy	Description	ID
MCT Timeout #	Set	MCT # is lost	<p>Cause: Uplink is not sending or is sending intermittently.</p> <p>Remedy: Clear warning. If the problem persists, determine if uplink is sending the current SI information table. Disable the warning if not using the table.</p>	No longer receiving Inband Control Table.	77100
MCT Timeout #	Clear	MCT fault cleared	-	-	77100
ECT Timeout #	Set	ECT # timed out	<p>Cause: Uplink is not sending or is sending intermittently.</p> <p>Remedy: Clear warning. If the problem persists, determine if uplink is sending the current SI information table. Disable the warning if not using the table.</p>	Event Control Table was never received.	77200
ECT Timeout #	Set	ECT # is lost	<p>Cause: Uplink is not sending or is sending intermittently.</p> <p>Remedy: Clear warning. If the problem persists, determine if uplink is sending the current SI information table. Disable the warning if not using the table.</p>	No longer receiving Event Control Table.	77200
ECT Timeout #	Clear	ECT fault cleared	-	-	77200
Memory Usage Host	Set	Excessive (stack/partition) memory usage	<p>Cause: Possible software issue.</p> <p>Remedy: Clear warnings, reset the unit, and notify Cisco customer support if the problem persists.</p>	SW exceeding allowable memory usage.	78000
Memory Usage Host	Clear	Normal (stack/partition) memory usage	-	-	78000

Chapter 6 Service and Maintenance

Warning	Message Type	Message	Cause/Remedy	Description	ID
Memory Usage Secondary	Set	Excessive (stack/partition) memory usage	Cause: Possible software issue. Remedy: Clear warnings, reset the unit, and notify Cisco customer support if the problem persists.	Software exceeding allowable memory usage.	79000
Memory Usage Secondary	Clear	Normal (stack/partition) memory usage	-	-	79000
FPGA Code Version	Set	FPGA newer than SW, Supported=AAA, Running=BBB	Cause: FPGA version is incompatible with the software. Remedy: Select alternate FPGA, software versions, reset unit, notify Cisco customer support if problem persists.	FPGA version is incompatible with currently operating software. You may encounter operational difficulties	80000
FPGA Code Version	Clear	FPGA code ver OK	-	-	80000
Ethernet Port <n>	Set	Link is down	Cause: No ethernet cable connected, faulty cabling, multiple devices sharing MAC address on same IP segment, or possible HW issue. Remedy: Check cabling, check MAC addresses, clear warnings, reset the unit, and notify Cisco customer support if the problem persists.	Ethernet MAC PHY device is attempting to reconnect to external devices.	81000 82000 83000
Ethernet PHY n	Clear	Connection OK	-	-	81000 82000 83000
FW: Resource Use Host	Set	Memory or List Near Full	Cause: Possible software issue. Remedy: Clear warnings, reset the unit, and notify Cisco customer support if the problem persists.	Software exceeding allowable usage of internal constructs.	86000

Warning	Message Type	Message	Cause/Remedy	Description	ID
FW: Resource Use Host	Clear	Normal Level	-	-	86000
FW: Resource Use Second	Set	Memory or List Near Full	Cause: Possible software issue. Remedy: Clear warnings, reset the unit, and notify Cisco customer support if the problem persists.	Software exceeding allowable usage of internal constructs.	87000
FW: Resource Use Second	Clear	Normal Level	-	-	87000
Backup Failure Reason	Set	FTP Failed	Cause: FTP settings or the server may not be configured correctly. Remedy: Verify the FTP server configuration and permissions. Verify that FTP settings on the unit. Verify that the server is reachable from the client (such as configuring firewalls or network settings). Retry the Backup operation.	FTP failed to connect to server or transfer file.	89000
Backup Failure Reason	Set	Internal Error	Cause: Possible software issue. Remedy: Clear warnings, reset the unit, notify Cisco customer support if problem persists.	Backup ran out of memory or other internal error.	89000

Chapter 6 Service and Maintenance

Warning	Message Type	Message	Cause/Remedy	Description	ID
Restore Failure Reason	Set	FTP Failed	<p>Cause: FTP settings or the server may not be configured correctly.</p> <p>Remedy: Verify the FTP server configuration and permissions. Verify that FTP settings on the unit. Verify that the server is reachable from the client (such as configuring firewalls or network settings). Retry the Import operation.</p>	FTP failed to connect to server or transfer file.	89100
Restore Failure Reason	Set	Not Accepted	<p>Cause: Import file is either for a different product or the structure was not compatible with this unit.</p> <p>Remedy: Verify that the correct import file is being used and was created by this product. Verify that the file structure has not been corrupted. If the problem persists, notify Cisco customer support.</p>	Import file was rejected and import did not occur.	89100
Restore Failure Reason	Set	Bad Content	<p>Cause: Import file may be corrupted, or from a different version of application software.</p> <p>Remedy: Verify that the correct import file is being used and was created by this product. Verify that the file structure has not been corrupted. If the problem persists, notify Cisco customer support.</p>	Item in import file is not valid for this software and import did not occur.	89100

Warning	Message Type	Message	Cause/Remedy	Description	ID
Hardware Platform	Set	Non-matching HW Platform. APP: <D9859 D9854/58/24>, HW: <TMB2 HDR/TMB/HDR 2>	Cause: Non-matching App was loaded through either CDT download or FLASH programming. Remedy: Replace the non-matching App and then reboot the IRD.	D9859 App running on D9854/58/24 platform or vice versa.	94000
Hardware Platform	Clear	Matching Hardware Platform detected.	-	-	94000
Xcode Video Buf Oflw	Set	PE(s): x;y;z	Cause: Video buffer overflow reported when the transcoding chip outputs more data that the path is capable of handling. The limitation is a combined bit rate of all transcoding paths and all delayed paths, and it is when this combined bit rate is above 203.04Mbps. Remedy: Verify that the configured overall bit rate for 8 transcoders does not exceed the FPGA path limitation.	Transcoder board FPGA reports buffer overflow on video PID path.	94004
Xcode Video Buf Oflw	Clear	Fault cleared	-	-	94004
Xcode Delay Buf Oflw	Set	PE(s): x;y;z	Cause: Delay path buffer overflow reported when the transcoding chip outputs more data than the path is capable of handling. Remedy: Verify that the configured overall bit rate for 8 transcoders does not exceed the FPGA path limitation.	Transcoder board FPGA reports buffer overflow on delayed PID path.	94006
Xcode Delay Buf Oflw	Clear	Fault cleared	-	-	94006

Chapter 6 Service and Maintenance

Warning	Message Type	Message	Cause/Remedy	Description	ID
Xcode Delay Pkt Drop	Set	PE(s): x;y;z	Cause: Possible misconfiguration of delay value. The packet delay is caused by arriving too early and it cannot be held in the buffer, or it arrived too late on the delay path. This is a software issue.	Transcoder board FPGA reports packet dropped on delayed PID path.	94007
Xcode Delay Pkt Drop	Clear	Fault cleared	-	-	94007
Transcoder Input	Set	Unsupported Video Format	Cause: Input stream configuration is incorrect. Remedy: Request a compatible stream format from your uplink provider.	Video format of one of the channels is not supported by this decoder.	94009
Transcoder Input	Set	Unsupported Aspect Ratio	Cause: Input stream configuration is incorrect. Remedy: Request a compatible stream format from your uplink provider.	Video format of one of the channels is not supported by this decoder.	94009
Transcoder Input	Set	Unsupported Video Profile or level	Cause: Input stream configuration is incorrect. Remedy: Request a compatible stream format from your uplink provider.	Video format of one of the channels is not supported by this decoder.	94009
Transcoder Input	Set	Input Underflow	Cause: Possible transcoder firmware error. Remedy: If problem persists, contact Cisco customer support.	Internal transcoder buffer overflow or underflow. Errors will be seen in the transcoded output.	94009

Warning	Message Type	Message	Cause/Remedy	Description	ID
Transcoder Input	Set	Input Overflow	Cause: Possible transcoder firmware error. Remedy: If problem persists, contact Cisco customer support.	Internal transcoder buffer overflow or underflow. Errors will be seen in the transcoded output.	94009
Transcoder Input	Set	Output Underflow	Cause: Possible transcoder firmware error. Remedy: If problem persists, contact Cisco customer support.	Internal transcoder buffer overflow or underflow. Errors will be seen in the transcoded output.	94009
Transcoder Input	Set	Output Overflow	Cause: Possible transcoder firmware error. Remedy: If problem persists, contact Cisco customer support.	Internal transcoder buffer overflow or underflow. Errors will be seen in the transcoded output.	94009
Transcoder Input	Clear	problems cleared	-	Transcoding is working properly.	94009
Transcoder Quality	Set	Low Intra and Inter scores	Cause: Possible transcoder firmware error. Remedy: If problem persists, contact Cisco customer support.	Transcoded video quality is degraded and artifacts may be seen in the transcoded video.	94012
Transcoder Quality	Set	Throttling fault	Cause: Possible transcoder firmware error. Remedy: If problem persists, contact Cisco customer support.	Transcoded video quality is degraded and artifacts may be seen in the transcoded video.	94012
Transcoder Quality	Clear	Quality Restored	-	-	94012

Chapter 6 Service and Maintenance

Warning	Message Type	Message	Cause/Remedy	Description	ID
XCode Config Mismatch	Set	Configuration Mismatch Fault	<p>Cause: Configuration or software issue. Also seen temporarily on channel changes or changes in the video source format.</p> <p>Remedy: If problem persists, contact Cisco customer support.</p>	Transcoder is generating video in a format that does not match the user's selection.	94013
XCode Config Mismatch	Clear	Mismatch Resolved	-	-	94013

Power Supply Replacement

There are no user-serviceable parts in the D9859 transcoder power supply. If the power supply requires replacement, contact your service provider or Cisco for information on how to return the unit for repair.

7

Customer Information

If You Have Questions

If you have technical questions, call Cisco Services for assistance. Follow the menu options to speak with a service engineer.

Access your company's extranet site to view or order additional technical publications. For accessing instructions, contact the representative who handles your account. Check your extranet site often as the information is updated frequently.

A

Technical Specifications

Introduction

This appendix contains the technical specifications for the D9859 Advanced Receiver Transcoder.

Note: The technical specifications are subject to change without prior notice.

In This Appendix

■ L-Band Input and Processing	322
■ Video Inputs/Outputs and Processing	326
■ Transport Stream Outputs.....	331
■ Control, Management and Data Interfaces	333
■ Power and General Specifications	335

L-Band Input and Processing

General

Parameter	Specification
System	MPEG-2/DVB Compatible EN 300 421, EN 300 468
Demodulation	DVB-S QPSK, DVB-S2 QPSK and 8PSK
Number of RF Inputs	4 (only one active at a time)

LNB LO Stability

DVB-S and DVB-S2

Symbol Rate	Stability
1 to 4.99 MSymbols/s	$\leq \pm 125$ kHz
5.0 to 9.99 MSymbols/s	$\leq \pm 1.0$ MHz
10.0 to 45 MSymbols/s	$\leq \pm 3.0$ MHz

Parameter	Specification
LNB Phase Noise Requirement	-35 dBc/Hz at $dF = 100$ Hz -53 dBc/Hz at $dF = 1$ kHz -76 dBc/Hz at $dF = 10$ kHz -96 dBc/Hz at $dF = 100$ kHz -106 dBc/Hz at $dF = 1$ MHz -117 dBc/Hz at $dF = 10$ MHz

LNB Power and Control

Parameter	Specification
Voltage (RF1 only, RF2 to RF4 do not have LNB supply)	13 V Vertical/circular right, 18 V Horizontal/circular left Off
Current	400 mA maximum LNB Alarms: No load - 6 mA Overload - 360 mA minimum

DVB-S/DVB-S2

DVB-S/DVB-S2 Satellite Receiver

Parameter	Specification
L-Band Input	
Number of Inputs	4 (one active at a time)
Input Connector Type	F-type, female, 75 ohms
Input Impedance	75 ohms
Return Loss	> 10 dB
Isolation Between Inputs	> 40 dB
L-band Frequency	950 to 2150 MHz
Tuning Step Size	1 MHz
Receive Spectrum Sense	Normal and Inverted
L-Band Power	
Input Power Level per Carrier	-25 to -65 dBm (full transponder power)
DVB-S Modulation (EN 300 421)	
Modulation	QPSK
Convolutional FEC Rates	1/2, 2/3, 3/4, 5/6, 7/8
Symbol Rate Range	1.0 to 45 MSymbols/s

Appendix A
Technical Specifications

Parameter	Specification
Eb/No (C/N) Ratio	See DVB-S2 Satellite Receiver Input, DVB-S Eb/No (C/N) Ratio Table
DVB-S2 Modulation (EN 302 307)	
Modulation	QPSK, 8PSK
Pilots On/Off	Pilots On
QPSK LDPC FEC Rates	1/2, 3/5, 2/3, 3/4, 4/5, 5/6, 8/9, 9/10
8PSK LDPC FEC Rates	3/5, 2/3, 3/4, 5/6, 8/9, 9/10
LDPC FEC Frame Length	Normal
Symbol Rate Range	1 to 30 Ms/s
Maximum Channel Bit Rate	90 Mb/s
Maximum User Bit Rate	78.55 Mb/s

DVB-S Eb/No (C/N) Ratio

Convolutional FEC Rate	Eb/No Ratio (dB) in Linear Channel and IF Loop configuration	C/N at DVB Threshold (BW = Symbol Rate)
1/2	4.5	4.1
2/3	5.0	5.9
3/4	5.5	6.9
5/6	6.0	7.9
7/8	6.4	8.5

$$C/N = Eb/No + 10 \log (2 \times FEC \times 188/204)$$

The D9859 transcoder displays the C/N Ratio.

DVB-S2 Error Rate Performance Es/No (C/N) Ratio

Mode	Simulated Es/No (dB) for FEC Frame length = 64,800	Typical Performance (dB) in Linear Channel and IF Loop configuration
QPSK 1/2	1.00	1.2
QPSK 3/5	2.23	2.4
QPSK 2/3	3.10	3.2
QPSK 3/4	4.03	4.2

L-Band Input and Processing

Mode	Simulated E_s/N_0 (dB) for FEC Frame length = 64,800	Typical Performance (dB) in Linear Channel and IF Loop configuration
QPSK 4/5	4.68	4.8
QPSK 5/6	5.18	5.3
QPSK 8/9	6.20	6.4
QPSK 9/10	6.42	6.6
8PSK 3/5	5.50	5.8
8PSK 2/3	6.62	6.8
8PSK 3/4	7.91	8.1
8PSK 5/6	9.35	9.6
8PSK 8/9	10.69	10.9
8PSK 9/10	10.98	11.3

Video Inputs/Outputs and Processing

General

Parameter	Specification
System	MPEG-2/DVB Compatible EN 300 421, EN 300 468

Video Inputs

Item	Specification
Transcoder Channel Inputs	
HD Video Input	
Number of Channels	1
Compression Format	MPEG-2 and MPEG-4 part 10
V Resolutions	1080, 720
Horizontal Video Resolutions	1080i: 1920, 1440 720p: 1280, 960
Bit Rate	3 Mb/s to 20 Mb/s Main Profile 3 Mb/s to 25 Mb/s High Profile
Connector	BNC, 75 ohms

Video Outputs

Item	Specification
Transcoder Channel Outputs	
HD Video Output	
Number of Channels	1
Compression Format	MPEG-2
Vertical Resolutions	Same as input.
Horizontal Resolutions	1080i: 1920, 1440 720p: 1280, 960

Item	Specification
Bit Rate	10 to 25 Mb/s

Analog SD Video Output

Item	Test Signal	Specification CVBS1	Specification CVBS2
Number of Channels		One SD source program	One SD source program
Video Decompression		MPEG-2 4:2:0	MPEG-2 4:2:0
Output Impedance		75 Ω	75 Ω
525 Line			
Bar level	NTC-7 comp	700 mV ± 7 mV (± 1%)	700 mV ± 35 mV (± 5%)
Line Time Distortion	VITS17	≤ 1%	≤ 1%
Bar Tilt	NTC-7 comp	< 0.5%	< 0.5%
Sync Level	NTC-7 comp	40 IRE ± 0.5 IRE	40 IRE ± 2.0 IRE
DC Offset	NTC-7 comp	± 100 mV	± 100 mV
Chrominance-to-Luminance Gain Inequality	NTC-7 comp	100 ± 5%	100 ± 5%
Chrominance-to-Luminance Phase Inequality	NTC-7 comp	< 20 ns	< 20 ns
K factor K 2T	NTC-7 comp	< 1%	< 1%
Jitter		< 5 ns	< 5 ns
Frequency Response	FCC multi-burst	0.5 MHz, 0 dB 1.25 MHz, 0 dB ± 0.2 dB 2 MHz, 0 dB ± 0.2 dB 3 MHz, 0 dB ± 0.3 dB 3.58 MHz, 0 dB ± 0.3 dB 4.1 MHz, 0 dB ± 0.3 dB	0.5 MHz, 0 dB 1.25 MHz, 0 dB ± 0.2 dB 2 MHz, 0 dB ± 0.2 dB 3 MHz, 0 dB ± 0.3 dB 3.58 MHz, 0 dB ± 0.3 dB 4.1 MHz, 0 dB ± 0.3 dB
Differential Gain	NTC-7 comp	< 3.0%	< 3.0%

Appendix A
Technical Specifications

Item	Test Signal	Specification CVBS1	Specification CVBS2
Differential Phase	NTC-7 comp	< 3°	< 3°
Luminance Non-linearity		< 5%	< 5%
Line Time Distortion	NTC-7 comp	≤ 1%	≤ 1%
Weighted Signal Video-to-Noise	50% Grey Field	≤ -70 dB rms	≤ -70 dB rms
Weighted Signal Video-to-Noise	Luminance Ramp	≤ -55 dB rms	≤ -55 dB rms
Return Loss		DC to 10 MHz, > 30 dB	DC to 10 MHz, > 30 dB
625 Line			
Bar level	VITS17	700 mV ± 7 mV (± 1%)	700 mV ± 35 mV (± 5%)
Line Time Distortion	VITS17	≤ 1%	≤ 1%
Bar Tilt	VITS17	< 0.5%	< 0.5%
Sync Level	VITS17	300 mV ± 3 mV	300 mV ± 15 mV
DC Offset	VITS17	± 100 mV	± 100 mV
Chrominance-to-Luminance Gain Inequality	Colour Bars	100 ± 5%	100 ± 5%
Chrominance-to-Luminance Phase Inequality	Colour Bars	< 20 ns	< 20 ns
K factor K 2T	VITS17	< 1%	< 1%
Jitter		< 5 ns	< 5 ns
Frequency Response	VITS18	0.5 MHz, 0 dB 1 MHz, 0 dB ± 0.2 dB 2 MHz, 0 dB ± 0.3 dB 4 MHz, 0 dB ± 0.3 dB 4.8 MHz, +0 dB, -0.5 dB	0.5 MHz, 0 dB 1 MHz, 0 dB ± 0.2 dB 2 MHz, 0 dB ± 0.2 dB 4 MHz, 0 dB ± 0.3 dB 4.8 MHz, +0 dB, -0.5 dB
Differential Gain	VITS330	< 3.0%	< 3.0%
Differential Phase	VITS330	< 3°	< 3°

Item	Test Signal	Specification CVBS1	Specification CVBS2
Luminance Non-linearity	VITS17	< 5%	< 5%
Weighted Signal Video-to-Noise	50% Grey Field	≤ -70 dB rms	≤ -70 dB rms
Weighted Signal Video-to-Noise	Luminance Ramp	≤ -55 dB rms	≤ -55 dB rms
Return Loss		DC to 10 MHz, > 30 dB	DC to 10 MHz, > 30 dB

Audio Inputs/Outputs

Analog SD Video Output, CVBS1 and CVBS2 for monitoring

Item	Specification
Number of Channels	One down-converted source HD program
Video Decompression Type	MPEG-2 4:2:0
Output Level	1.0 V _{pp} ± 5%
Output Impedance	75 ohms

Analog Audio Inputs

Item	Specification
Number of Channels	2
Audio Decompression	MPEG or Dolby Digital and Dolby Digital Plus

Analog Audio Outputs

Item	Specification
Number of Channels	2 stereo pairs or 4 mono channels
Audio Decompression	MPEG or Dolby Digital

Appendix A
Technical Specifications

VBI Data Input/Output

Item	Specification
Transmission Format	EIA-708 and EIA-608

Transport Stream Outputs

ASI Output

Item	Specification
Number of outputs	3 (mirrored)
Type of connector	75 ohms BNC
Output impedance	75 ohms according to EN 50083-9
Data amplitude	800 mV peak-peak \pm 10% according to EN 50083-9
Return loss	> 17 dB, 27 to 270 MHz
Transport stream data rate	1 to 120 Mbit/s
ASI transmission rate	270 MBaud \pm 100 ppm
Transport stream formats	According to EN 50083-9 188 bytes structure Burst or packet format

MPEGoIP Output

Item	Specification
Number of outputs	1
Type of connector	RJ-45, 10/100/1000 BASE-T
Output modes	UDP RAW, RTP
IP Addressing	Multicast, Unicast
TS Streaming	MPTS
TS Bit Rate	1 to 120 Mbps
MPEGoIP bit rate	Up to 206 Mbps

MPE Output

Item	Specification
Number of Outputs	1

Appendix A
Technical Specifications

Item	Specification
Type of connector	RJ-45, 10/100/1000 BASE-T
Output modes	IPv4 datagrams
IP Addressing	Multicast, Unicast
TS Input	up to 5 PIDs
Bit Rate	up to 10 Mbps (for 1500 byte packets)

Control, Management and Data Interfaces

Ethernet Management Interface

Item	Specification
Number of connectors	1
Type of connector	Eight-pin RJ-45
Ethernet type	10/100/1000BASE-T
Required setup	IP address, default gateway and subnet mask

Ethernet Data Interface

Item	Specification
Number of connectors	1
Type of connector	Eight-pin RJ-45
Ethernet type	10/100/1000BASE-T
Required setup	IP address, default gateway and subnet mask

RS-232 Data Interface

Item	Specification
Connector type	9-pin sub-D female
Data rates	RS-232 asynchronous data at selectable rates up to 38.4 kb/s: 300, 1200, 2400, 4800, 9600, 19,200, 38,400 b/s

Alarm Interface

Item	Specification
Number of outputs	3, each having one set of contacts closed and one set open during normal operation. Alarms are signaled by reversing the polarity of the two contact sets.

Appendix A
Technical Specifications

Item	Specification
Type of connector	Terminal block
Max. voltage	≤ 30 V AC, ≤ 30 V DC
Max. current	≤ 1 A

Contact Closure Interface

Item	Specification
Connector type	9-pin sub-D female
Minimum duration of event guaranteed to be detected	250 ms, 1 frame period, e.g., for 1080i/25 Hz, 40 ms for DPI applications
Max. on generator impedance	100 ohms
Min. off generator impedance	100 kilohms

Power and General Specifications

General

Item	Specification
LCD	2 lines of 40 characters, backlit LCD.
Keypad	Arrow keys, 0 to 9, SELECT, MENU, INFO, ADV, MAP, APPLY and NAV keys.
LEDs	Green LED for Signal status. Red LED for Alarm indication.

Power

AC Power Connector

Item	Specification
Type of connector	IEC 320 style C14 appliance receptable
AC input	100 to 240 V AC, 50/60 Hz
Power	125 W max.
Power Quality	ANSI/IEEE Std C62.41.1-2002

Power

To operate the transcoder, you must connect it to an AC power source.

 **WARNING:**
 Make sure that at least one end of the power cable(s) remains easily accessible for unplugging, if you need to switch off the unit. For example: Ensure that the socket outlet is installed near the product.

 **WARNING:**
 To avoid electrical shock, connect the three-prong plug on this product to an earth-grounded three-pin socket outlet only.

Mechanical

Item	Specification
Height	1 RU (1.75 in.) (4.4 cm)
Width	19.0 in. (48.3 cm)
Depth	20.5 in. (52.1 cm)
Weight	16 lb (7.2 kg)

Environment

Item	Specification
Storage	
General	The product is within the original packaging.
Humidity	5 - 95% non-condensing
Temperature	-20 - +70°C (-4 to 158°F)
Operation	
Humidity (non-condensing)	95% humidity is valid up to 40°C 91% humidity is valid up to 45°C 70% humidity is valid up to 50°C
Temperature	0°C - +50°C (32°F to 122°F)
Altitude	
Operating	10,000 ft. (3048 m) max.
Non-operating	30,000 ft. (9144 m) max.

B

Default Settings and Lock Levels

Introduction

This appendix lists the factory default settings and the lock levels for the D9859 transcoder.

In This Appendix

- Factory Default Settings and Lock Levels338
- DPM Default Settings for Different Output Modes351

Factory Default Settings and Lock Levels

The D9859 Advanced Receiver Transcoder is factory configured with default settings unless you have requested a custom factory configuration.

The following table lists the lock levels available for protecting your transcoder and its settings against unauthorized use or modification:

Level	Description
0	All settings are unlocked (transcoder lockout disabled)
1	All settings are unlocked except Factory Reset, Password options and transcoder parameters.
2	All settings are unlocked except RF and ASI Input Tuning parameters.
3	All settings locked (access via password only), except IP address and RF power.
4	All settings locked (can be changed via PNC uplink signal only)

If a change made to the current Lock Level setting is not saved, the previously saved setting is restored.

Note: The user cannot select NONE as a Lock Level.

Administration

Parameter	Default	Lock Level
Lock Level	0	3
Password	1234	3
Old Pwd, New Pwd, Confirm Pwd	N/A	0
Factory Reset	N/A	0
Clear FWD Tables	N/A	0
KB Lock	Disable	2
KB Lock Timeout	60	2
LCD Contrast	30	2
DL Mode	Always	2
Type	None	N/A
Bank	App 5514	N/A

Factory Default Settings and Lock Levels

Parameter	Default	Lock Level
Date Format	YYY_MM_DD	2
Time Format	24 Hr	2
GMT Off	+05.30	2
Reboot	N/A	2

ASI Input

Parameter	Default	Lock Level
ASI Active	No	1
Tune Mode	Basic	1
CA Ctl	STD	1
Select	UserCfg	1

RF Input

Parameter	Default	Lock Level
RFx Active	RF1 is Act, RF2 to RF4 is No	1
Tune Mode	Basic	1
CA Ctl	Std	1
Select	UserCfg	1
LO1 (GHz)	5.15	1
LO2 (GHz)	0.0	1
Crossover (GHz)	0.0	1
OrbPos	0.0	1
E/W	NA	1
Pol	H (horizontal)	1
Freq (GHz)	3.449	1
Sym Rate	28.3465 MS/s	1
FEC	Auto	1
LNB Type	C-Band	1
Modulation	DVB-S	1

Appendix B
Default Settings and Lock Levels

Parameter	Default	Lock Level
Roll-off	.35	1
InputIQ	Auto	1
NetID	1	1
LNB Power	Off	3
22kHz	Off	1

Tune Mode

Parameter	Default	Lock Level
Service List Mode	Rigorous	1
Frequency Tuning	NIT	1
BAT	No	1
NIT	Yes	1
SDT	Yes	1
PAT	Yes	1

Disaster Recovery

Global

Parameter	Default	Lock Level
D/R Enable	Yes	1
Signal Loss Timer	120	1
Signal Lock Timer	30	1
Verify Timer	60	1

Backup Channel

The default is 0 and the lock level is 1.

Transport

Parameter	Default	Lock Level
Active	No	1

Factory Default Settings and Lock Levels

Parameter	Default	Lock Level
Input	RF1	1
NetId	1	1
Freq (GHz)	3.4	1
SymRate	2	1
FEC	Auto	1
Modulation	DVB-S	1
Rolloff	0.35	1

IP

Note: A factory reset does not change the IP settings.

Parameter	Default	Lock Level
Port ID	1	3
V4/V6	IPv4	N/A
IP Address	192.131.244.6	3
Mask	24	3
Gateway	255.255.255.0	3
Phy Mode	Auto	3
MAC Address	00:00:00:00:00:00	N/A
SNMP Read Community String	public	3
SNMP Write Community String	public	3
Password Complexity	Full Complexity Checking	N/A
SNTP Server	0.0.0.0	3
SNTP Enable	No	3
Reset Credentials	N/A	0

Appendix B
Default Settings and Lock Levels

Trap Destinations

Parameter	Default	Lock Level
Trap IP Address	0.0.0.0	2
Trap Community String	public	2

Protocols

Parameter	Default	Lock Level
Telnet	Disable	3
SSH	Disable	3
HTTP	Enable	3
SNMP	Disable	3
MPE	Fwd All	3
Syslog	Disable	3
Syslog Server	0.0.0.0	3
Port	514	3

Video

Parameter	Default	Lock Level
PV Format	SD	2
SD Format	Auto	2
Alarm Video Cutoff	Disable	2
OSD Messages	Enable	2
TV A/R	4:3	2
Convert	None	2
WSS Mode	Passthrough	2
Enable Banner Display (Web GUI only)	Enable	2

Audio

Parameter	Default	Lock Level
Stereo/Mono	Stereo	2
AC3 Compression	RF Mode	2
Left (dB)	0	2
Right (dB)	0	2
Select Language By	PMT Order	2
Language List	eng	2
PMT Source	AUD1 for Audio 1 and AUD2 for Audio 2	2
Entry	eng	2

Captions

Parameter	Default	Lock Level
Preferred Mode	Auto	2

VBI

Parameter	Default	Lock Level
WSS Mode	Passthrough	2
WSS Stat	Undefined	N/A
VITS PAL Line 17, 18, 330, 331	Disable	2

Subtitles

Parameter	Default	Lock Level
Op Mode	Off	2
Select Language By	Language Entry	2
Language List	eng	2

Appendix B
Default Settings and Lock Levels

Parameter	Default	Lock Level
PMT Order	First	2
Entry	eng	2
Imitext Position	Standard	2
ForeGnd	Auto	2
BackGnd	Auto	2

Decode

Parameter	Default	Lock Level
Decoder	N/A	2
Enabled	Yes	2

Note: By default, all the decode services are enabled.

Cueing

Parameter	Default	Lock Level
Cueing Mode	Trigger	4
Trigger Polarity	High	4
Repeat	3	4
Tone (ms)	40	4
Silence (ms)	40	4
Seq#	1	4
State	Disable	4
Tones	0	4
Mode	*	4
Delay (sec)	1	4
Relay Mode	Alarm	4
Cue Trigger Bit	1	4

TS Out - ASI

Parameter	Default	Lock Level
Name	ASI	N/A
Rate Control	User	2
User Rate	68.5 Mbps	2
Output Mode	No Output	2
Descramble Mode	Descrambled	2
Insert Null Packet	Yes	2
Auto Map	Yes	N/A
Auto Map Aux	No	N/A

TS Out - MOIP

Parameter	Default	Lock Level
Name	MOIP	N/A
Rate Control	User	2
User Rate	0	2
Output Mode	No Output	2
Descrambled Mode	Descrambled	2
Insert Null Packet	Yes	2
Auto Map	Yes	N/A
Auto Map Aux	No	N/A

MOIP Streams

Parameter	Default	Lock Level
User Rate	68.5 Mbps	2
Intf Mode	None	2
TS/IP	7	2
PCR@IP Start	No	2
MOIP	UDP	2

Appendix B
Default Settings and Lock Levels

Parameter	Default	Lock Level
Min IP/s	0	2
TOS	0	2
TTL	64	2
DestAddr	225.1.1.1	2
UDPPort	49152	2
SrcPort	0	2
Send SAP	None	2
SAP Address	224.2.127.25	2
SAP Port	9875	2
SAP ID	User String	2
SAP User Str	Cisco Default SAP1	2

DPM - ASI/MOIP

Parameter	Default	Lock Level
PE	PE1	N/A
Act	Drop	2
StType	N/A	2
OutCh	0	2
PMT	8191	2
OType	UNKN	2
In	N/A	2
PID	0	2
Map Mode	SVC ID & PID	2
Duplic Mode	Pkt Copy	2
Unref	Drop	2
PSI Options	Drop All	2
PSI Rate	SA Std	2
Service ID	Valid Ch	2
PAT	Pass	2

Factory Default Settings and Lock Levels

Parameter	Default	Lock Level
CAT	Pass	2
PMT	Pass	2
TSDT	Pass	2
NIT	Pass	2
NITO	Pass	2
SDT	Pass	2
SDTO	Pass	2
BAT	Pass	2
EIT	Pass	2
TDT	Pass	2
RST	Pass	2
TOT	Pass	2
DIT	Pass	2
SIT	Pass	2
ECM	Pass	2
EMM	Pass	2
DRT	Pass	2
CDT	Pass	2

Transcode

Parameter	Default	Lock Level
PE	PE1	N/A
Video Mode	HD Output	0
HD HRes	Full	0
SD HRes	720	0
HD/SD B/R Mode	CBR	0
HD Bitrate	16 Mb/s	0
SD Bitrate	4.0 Mb/s	0
HD/SD GOP Control	User GOP (MN)	0
HD/SD User GOP (MN)	15 2	0

Appendix B
Default Settings and Lock Levels

Parameter	Default	Lock Level
HD/SD 3:2 Pulldown	Disabled	0
SD Aspect Ratio	16:9	0
SD AR Conv	None	0
CC Pkt1	CEA 708	0
CC Pkt2	None	0
LOI Action	Black Output	2

Inband

Parameter	Default	Lock Level
PE	PE1	N/A
Apply Inband	No	0

Options

Parameter	Default	Lock Level
Output	1	N/A
Fixed Output	No	N/A
Use Inp Chan	No	N/A
Start	1	N/A
Step	1	N/A
Use Inp PMT	No	N/A
Start	1701	N/A
Step	1	N/A
Use Inp PIDs	No	N/A
Start	101	N/A
Step	100	N/A
Use Inp Ord	Yes	N/A
PCR	1	N/A
VID	1	N/A
AUD	8	N/A

Factory Default Settings and Lock Levels

Parameter	Default	Lock Level
SUBT	8	N/A
VBI	2	N/A
DPI	2	N/A
MPE	5	N/A
TTX	1	N/A
DATA	1	N/A
LSD	1	N/A
CDT	4	N/A
ETV	4	N/A

Alarm/Warning

Parameter	Default	Lock Level
FP Alarm Reminder	Enable	2
Alarm Vid Cutoff	Disable	2
Enb	N/A	2
Rly	N/A	2
Trp	N/A	2

Noise Cutoff

Parameter	Default	Lock Level
Trnsprt (DVB-S/DVB-S2 Marg) Cutoff	0.0	2
Trnsprt (DVB-S/DVB-S2 Marg) Restore	0.1	2
Audio (DVB-S/DVB-S2 Marg) Cutoff	0.0	2
Audio (DVB-S/DVB-S2 Marg) Restore	0.1	2
Muting Control	Enable	2
Restore Defaults	N/A	2

Appendix B
Default Settings and Lock Levels

Import/Export (Web GUI only)

Parameter	Default	Lock Level
Settings File Name	file name	3
FTP Server IP Address	192.168.0.100	3
FTP Port Number	21	3
FTP User Name	user	3
FTP Password	USER	3

DPM Default Settings for Different Output Modes

The DPM parameters are preset to default settings for each DPM Output Mode.

The default settings for particular Output modes have been preset to optimize the output when either PID mapping or transcoding is required. If the DPM parameters are changed to values which switch the transcoder to Full DPM Control, the transcoder may enter a condition where conflicts in the settings may occur, which may require manual manipulation of the DPM or output parameters to obtain the desired output.

The fields labeled “Any” in the table below, are not used, in which case, the Output Mode will not change if the parameter is changed. However, if you change any of the other parameters listed in the table for the MAP or Transcoding output modes, the Output Mode will change to Full DPM Control.

Output Mode	No Output	Passthrough	Service Chans Only	MAP Passthrough	MAP Svc Chans Only	Full DPM Control	Transcoding
Rate Control	Any (unchanged)	Any (unchanged)	Any (unchanged)	Any (unchanged)	Any (unchanged)	Any (unchanged)	Any (unchanged)
User Rate	Any (unchanged)	Any (unchanged)	Any (unchanged)	Any (unchanged)	Any (unchanged)	Any (unchanged)	Any (unchanged)
Descramble Mode	Any (unchanged)	Any (unchanged)	Any (unchanged)	Any (unchanged)	Any (unchanged)	Any (unchanged)	Descrambled
Regenerate	Any (unchanged)	Any (unchanged)	Any (unchanged)	Any (unchanged)	Any (unchanged)	Any (unchanged)	Any (unchanged)
Insert Null Packet	Any (unchanged)	Any (unchanged)	Any (unchanged)	Any (unchanged)	Any (unchanged)	Any (unchanged)	Any (unchanged)
Map Mode	Any (not used)	Svc ID	Svc ID	Svc Id & PID	Svc ID & PID	Actual Value	Svc ID & PID
Duplic Mode	Any (not used)	PSI Remap	PSI Remap	Pkt Copy	Pkt Copy	Actual Value	Pkt Copy
Unref	Drop	Pass	Drop	Pass	Drop	Actual Value	Drop
PSI Options	Drop	Ctl By Table	Ctl By Table	Ctl By Table	Ctl By Table	Actual Value	Ctl By Table
PSI Rate	Any (not used)	SA Std	SA Std	SA Std	SA Std	Actual Value	SA Std
Svc ID	Any (not used)	Valid Ch	Valid Ch	Valid Ch	Valid Ch	Actual Value	Valid Ch
PAT	Not Displayed	Pass	Regen	Regen	Regen	Actual Value	Regen

Appendix B
Default Settings and Lock Levels

Output Mode	No Output Displayed	Passthrough	Service Chans Only	MAP Passthrough	MAP Svc Chans Only	Full DPM Control	Transcoding
CAT	Not Displayed	If Descramble Mode is set to Descrambled, it is set to Regen; otherwise, it is set to Pass	If Descramble Mode is set to Descrambled, it is set to Regen; otherwise, it is set to Pass	If Descramble Mode is set to Descrambled, it is set to Regen; otherwise, it is set to Pass	If Descramble Mode is set to Descrambled, it is set to Regen; otherwise, it is set to Pass	Actual Value	Regen
PMT	Not Displayed	If Descramble Mode is set to Descrambled, it is set to Regen; otherwise, it is set to Pass	If Descramble Mode is set to Descrambled, it is set to Regen; otherwise, it is set to Pass	Regen	Regen	Actual Value	Regen
TSDT	Not Displayed	Pass	Pass	Pass	Pass	Actual Value	Pass
NIT	Not Displayed	Pass	Regen	Regen	Regen	Actual Value	Regen
NITO	Not Displayed	Pass	PwRc	PwRc	PwRc	Actual Value	Drop
SDT	Not Displayed	If Descramble Mode is set to Descrambled, it is set to Regen; otherwise, it is set to Pass	Regen	Regen	Regen	Actual Value	Regen
SDTO	Not Displayed	If Descramble Mode is set to Descrambled, it is set to Regen; otherwise, it is set to Pass	PwRc	PwRc	PwRc	Actual Value	Drop

DPM Default Settings for Different Output Modes

Output Mode	No Output	Passthrough	Service Chans Only	MAP Passthrough	MAP Svc Chans Only	Full DPM Control	Transcoding
BAT	Not Displayed	If Descramble Mode is set to Descrambled, it is set to PwRC; otherwise, it is set to Pass	PwRC	PwRC	PwRC	Actual Value	Drop
EIT	Not Displayed	Pass	Pass	Pass	Pass	Actual Value	Drop
TDT	Not Displayed	Pass	Pass	Pass	Pass	Actual Value	Pass
RST	Not Displayed	Pass	Pass	Pass	Pass	Actual Value	Pass
TOT	Not Displayed	Pass	Pass	Pass	Pass	Actual Value	Pass
DIT	Not Displayed	Pass	Pass	Pass	Pass	Actual Value	Pass
SIT	Not Displayed	Pass	Pass	Pass	Pass	Actual Value	Pass
ECM	Not Displayed	Pass	Pass	Pass	Pass	Actual Value	Drop
EMM	Not Displayed	Pass	Pass	Pass	Pass	Actual Value	Drop
DRT	Not Displayed	Pass	Pass	Pass	Pass	Actual Value	Drop
CDT	Not Displayed	Pass	Pass	Pass	Pass	Actual Value	Drop
PE Action (all PEs)	Drop	Pass	Pass	Map	Map	Actual Value	Transcode

C

Compliance

Introduction

This appendix contains the compliance information for the D9859 Advanced Receiver Transcoder.

In This Appendix

- Applicable Standards and Notices356
- Declaration of Conformity358

Applicable Standards and Notices

Safety

The D9859 Advanced Receiver Transcoder has been approved for safety by the Standards Council of Canada and the OHSA (NRTL) Accredited Testing Laboratory to the following standards:

CAN/CSA 60065-03 + Am1 +Am2 - Audio, Video and Similar Electronic Apparatus - Safety Requirements.

UL Std No. 60065-03 (2012) - Audio, Video and Similar Electronic Apparatus - Safety Requirements.

Also, this product is being evaluated under the IECEE CB scheme to the following international standard:

IEC 60065:2001 (Seventh Edition) + A1:2005 + A2:2010 including the National requirements of AR, AT, AU, BE, CA, CH, CN, CZ, ES, DE, DK, FI, FR, GB, HU, IE, SI, IT, JP, KR, MY, NL, NO, PL, SE, SG, SI, SK, SV, US, UA and Group Differences as posted at the following IECEE CB Website:

<http://members.iecee.org/iecee/ieceemembers.nsf>.

ESD

Electrostatic Discharge (ESD) results from the static electricity buildup on the human body and other objects. This static discharge can degrade components and cause failures.

Take the following precautions against electrostatic discharge.

Use an anti-static bench mat and a wrist strap or ankle strap designed to safely ground ESD potentials through a resistive element.

Keep components in their anti-static packaging until installed.

Avoid touching electronic components when installing a module.

Electromagnetic Compatibility Regulatory Requirements

Ethernet cables should be of single-shielded or double-shielded type. Coaxial cables should be of the double-braided shielded type. Where this equipment is subject to USA FCC and/or Industry Canada rules, the following statements apply:

FCC Notices

This equipment has been tested and found to comply with the limits for a Class B digital device pursuant to Part 15 of the FCC rules. These limits are designed to provide reasonable protection against harmful interference when operated in a residential installation. This equipment generates, uses and can radiate radio frequency energy, and if not installed and used in accordance with the instructions supplied in this manual may cause harmful interference to radio communications. However, there is no guarantee that interference will not occur in a particular installation. If this equipment does cause harmful interference to radio or television reception (which can be determined by turning the equipment off and on), the user is encouraged to try to correct the interference by one or more of the following measures:

- 1 Reorient or relocate the television receiving antenna.
- 2 Increase the separation between the equipment and the receiver.
- 3 Connect the equipment to an AC outlet on a circuit different from that to which the receiver is connected.
- 4 Contact your dealer/ reseller or an experienced radio/ TV technician for help.

The user may find the booklet "Interference handbook" prepared by the Federal Communications Commission helpful. This booklet is available from the U.S. Government Printing Office, Washington, DC 20402, stock no. 004-000-00450-7.

Shielded cables should be used to interconnect this device with any other/peripheral equipment (i.e., data sources, terminals, monitors, etc.) to ensure compliance with Class B limits. Failure to do so may result in radio or TV interference. Cables should be of braided shield construction with metal end shells.

Industry Canada Notice

This digital apparatus does not exceed the limits for Class B radio noise emissions from digital apparatus as set out in the radio interference regulations of the Industry Canada.

Le present appareil numerique n'émet pas de bruits radioélectriques qui dépassent les limites applicables aux appareils numériques de Class B prescrites dans le règlement sur le brouillage radioélectrique édicté par Industrie Canada.

Unauthorized Modifications

The manufacturer is not responsible for any radio or TV interference resulting from unauthorized modifications made to this equipment. It is the responsibility of the user to correct such interference at his own expense.

Declaration of Conformity



DECLARATION OF CONFORMITY with regard to the Directives 2006/95/EC (LVD), 2004/108/EC (EMC) and 2011/65/EU (RoHS)

Cisco Systems Inc & all its affiliates
Headquarters:
170 West Tasman Drive
San Jose, CA 95134 - USA

Declare under our sole responsibility that the product,
Brand name: Cisco
Model number: D9859
Model name: Advanced Receiver Transcoder

Fulfills the essential requirements of the Directives 2006/95/EC, 2004/108/EC and 2011/65/EU.

With regard to the Directives 2006/95/EC and 2004/108/EC, and 2011/65/EU the following standards were applied:

Number and Date of Issue	Title of Standard
EN 60065:2002 +A1:2006 +A11:2008+A2:2010 +A12: 2011	- Audio, video and similar electronic apparatus – Safety requirements
EN 55022:2010, Class B	- Limits and Methods of Measurement of Radio Interference Characteristics of Information Technology Devices
EN 55024:2010	- Information technology equipment - Immunity characteristics - Limits and methods of measurement
EN 61000-3-2:2006 +A2:2009	- Electromagnetic Compatibility - Part 3: Limits Section 2: Limits for Harmonic Current Emissions (Equipment Input Current less than 16A per phase)
EN 50581: 2012	Technical documentation for the assessment of electrical and electronic products with respect to the restriction of hazardous substances

The product carries the CE Mark, which was first affixed in 2013:

Date & Place of Issue: 10 April 2014, Scarborough, ON, Canada



Signature(s):
Steven Lawrence
Product Compliance Specialist
Cisco Systems Canada Co.
100 Middlefield Rd.
Scarborough ON M1S4M8
Canada

EU Authorized Representative:

Edgard Vangeel
Cisco Systems Belgium
De Kleetsaan, 6 A
B 1831 Diegem - Belgium

...cont

D9859_Cisco_DMN_EU_DOC3

cont...

Additional Information:

Product ID's (PIDS) Subject to this Declaration:

D9859-ATP-IRU

D9859-ATP-IRU=

D9859-GEN-IRU

D9859-GEN-IRU=

Index

A

- About Menu • 124
- About the Front Panel • 34
- Accessing TCP and UDP Services • 74
- Adding a New User • 31
- Administration • 338
- Administrator User Privileges • 30
- Alarm Interface • 333
- Alarm/Warning • 349
- Alarms • 260
- Alarms/Warnings • 129
- Analog Audio Inputs • 329
- Analog Audio Outputs • 329
- Analog SD Video Output • 327
- Analog SD Video Output, CVBS1 and CVBS2 for monitoring • 329
- Applicable Standards and Notices • 356
- Applying Inband Settings • 216
- ASI Input • 62, 339
- ASI Output • 331
- ASI/MOIP • 100
- Aspect Ratio Conversions • 79
- Assigning a Program Channel to a PE (Program Entry) • 15
- Assigning Program to the Program Entry • 41
- Audio • 81, 343
- Audio Inputs/Outputs • 329

B

- Backup Channel • 123
- Backup Channel Status • 54
- Backup Transport • 123
- Backup Transport Status • 54

C

- Captions • 83, 343
- Changing a Password (allowed by all Users) • 32
- Changing a Username • 32
- Changing the Lock Level Password • 250
- Changing the Relay Mode for Alarm Monitoring • 27

- Channel Authorization Status • 39
- Configuring DPM General Settings • 192
- Configuring MPEG over IP Streams • 201
- Configuring Open-collector Outputs • 29
- Configuring System Settings • 218
- Configuring the ASI Output • 182
- Configuring the Disaster Recovery Settings • 154
- Configuring the DPM MPEGoIP Output Details • 203
- Configuring the MPE Settings • 226
- Configuring the MPEGoIP Output • 195
- Configuring Transcoder Settings • 214
- Configuring Transport Stream Information • 182
- Connecting an External Alarm System • 27
- Connecting the AC Power to the D9859 Transcoder • 22
- Connecting the ASI Input • 25
- Connecting the ASI Outputs • 27
- Connecting the Balanced Audio Output • 25
- Connecting the Composite Video Output • 25
- Connecting the Cue Tone Interface • 29
- Connecting the Cue Tone/Cue Trigger Interface • 28
- Connecting the Cue Trigger Interface • 29
- Connecting the Ethernet Management Interface • 26
- Connecting the Input/Output Signals • 25
- Connecting the IP TS Output • 26
- Connecting the RF Inputs • 25
- Connecting the RS-232 Data Interface • 28
- Connecting the Transcoder to Other Equipment • 11
- Connecting the Video Outputs • 25
- Connector for the Video Output • 25
- Contact Closure Interface • 334
- Control, Management and Data Interfaces • 333
- Cooling • 21
- Cueing • 89, 344
- Customer Information • 319

D

D9859 Advanced Receiver Transcoder • 2
 D9859 Menus • 138
 D9859 Summary Overview • 135
 D9859 Transcoder Alarm Messages • 260
 D9859 Web GUI Environment • 140
 Declaration of Conformity • 358
 Decode • 87, 344
 Deleting a Program from the Program Entry • 42
 Deleting a User • 31
 Diagnostics Menu • 129
 Digital Program Distribution • 2
 Disaster Recovery • 6, 340
 Downloading a Software License • 258
 Downloading the Software Application • 258
 DPM - ASI/MOIP • 346
 DPM - Global • 100
 DPM Default Settings for Different Output Modes • 351
 DVB-ASI Outputs • 4
 DVB-S Eb/No (C/N) Ratio • 324
 DVB-S/DVB-S2 • 323
 DVB-S2 Error Rate Performance Es/No (C/N) Ratio • 324

E

Environment • 336
 Ethernet Data Interface • 333
 Ethernet Management Interface • 333

F

Factory Default Settings and Lock Levels • 338
 Front Panel LEDs • 34
 Front Panel Operation • 33

G

General • 124, 322, 326, 335
 Global • 122
 Global Status • 52, 54
 Grounding • 21

H

Health Monitor • 132

I

Import/Export (Web GUI only) • 350
 Inband • 112, 348
 Installation • 19
 Installing the D9859 Transcoder • 21

Introduction • 1
 IP • 69, 341

K

Key Features • 2
 Keypad • 34

L

L-Band Input and Processing • 322
 LCD • 34
 LCD Panel • 39
 LCD Symbol • 40
 Licenses • 125
 Link Status • 52
 LNB LO Stability • 322
 LNB Power and Control • 323
 Locking/Unlocking the Front Panel • 38
 Logging On to the Web GUI • 134
 Logs • 129

M

Main Menu • 43
 Main Structure • 39
 Main Versions • 126
 Maintenance of EMC Compliance • 10
 Mechanical • 336
 MOIP • 94
 MOIP Streams • 97, 345
 Mounting the D9859 Transcoder to a Rack • 21
 MPE Output • 5, 331
 MPEGoIP Output • 4, 331

N

Navigation/Selection Keypad • 35
 Noise Cutoff • 349

O

Options • 348

P

PID Map Menu • 104
 Power • 335
 Power and General Specifications • 335
 Power Connection • 20
 Power On • 131
 Power Supply Replacement • 317
 Printing the List of Users • 32
 Program PIDs • 50
 Program Status • 50
 Protocol Control Settings • 221

Protocols • 73, 342

PSI - Channels • 130

PSI - Frequency Plan • 130

PSI - Tables • 131

PSI Table Settings • 105

Q

Quick Setup - Read Me First! • 9

Quick Setup Instructions for RF Acquisition • 13

R

Rack Mounted • 21

Re-Acquire • 68

Rear Connector Panel • 23

Redundancy • 75

Redundancy Status • 52

Resetting the Login Credentials • 32

RF Input • 339

RF1, RF2, RF3, RF4 (RFx) Input • 63

RS-232 Data Connector Pin Allocation • 28

RS-232 Data Interface • 333

S

Service and Maintenance • 259

Setting Admin User Privileges via a Telnet/SSH Connection • 30

Setting the DPM General Settings • 207

Setting the DPM Mode • 17

Setting the Maximum and Minimum Transport Packets • 201

Setting up Audio and Video Information • 168

Setting up Default Settings for the Transcoder • 213

Setting Up Digital Program Mapping (DPM) • 106

Setting up for Network Connection • 12

Setting up Import/Export FTP Information • 243

Setting up Input Information • 141

Setting Up the ASI Auto Synchronization Options • 185

Setting up the ASI Output • 16

Setting Up the MPEG over IP Auto Synchronization Options • 199

Setting up the RF Input • 141

Setting up the Video Parameters • 168

Setting Up Transcoding • 112

Setup Menu • 56

Alarm/Warning • 117

DR • 121

IP • 68

Noise Cutoffs • 119

Software Update • 3

Starting a Telnet/SSH Session • 30

Startup Screen • 39

Status Menu • 44

General • 45

Services • 46

TS Input • 47

TS Output • 52

Status Menu - DR • 53

Status Menu - IP • 52

Stream Status • 53

Structure • 44

Subtitles • 85, 343

Synchronizing Output Services • 108

Synchronizing the Inputs • 190

System Logs • 222

T

To Add a Static Multicast Filtering • 227

To Add a Trap Destination • 228

To Add a User Account • 247

To Change the User Login Passwords • 245

To Delete a User Account • 248

To Set Up Warnings • 233

Transcode • 110, 347

Transcoder Hardware Versions • 128

Transcoder Software Versions • 128

Transport Stream Outputs • 4, 331

Trap Destinations • 342

Traps • 72

TS Out - ASI • 91, 345

TS Out - DPM • 99

TS Out - MOIP • 345

TS Out - Options • 113

TS Out - Transcode • 109

TS Output Options • 113

Tune Mode • 67, 340

Typical set up for Digital Program Mapping (DPM) • 210

V

VBI • 84, 343

VBI Data Input/Output • 330

Verifying Software and FPGA Integrity Hash Digest • 238

Versions Menu • 126

Index

- Video • 77, 342
- Video Inputs • 326
- Video Inputs/Outputs and Processing • 326
- Video Outputs • 326
- Viewing Contact Information • 252
- Viewing Stream Details • 203
- Viewing Support Information • 252
- Viewing the ASI Output Status • 187
- Viewing the ASI Output Transport Status • 194
- Viewing the Disaster Recovery Status • 157
- Viewing the Link Status • 223
- Viewing the MPEG Output Transport Status • 210
- Viewing the MPEG over IP Output Status • 203
- Viewing the System Identification • 218
- Viewing Transcoder Version Information • 239
- VITC • 84
- VITS • 84

W

- Warnings • 299
- Web GUI Setup and Monitoring • 133
- Window Buttons • 140
- WSS • 84



Americas Headquarters

Cisco Systems, Inc.
170 West Tasman Drive
San Jose, CA 95134-1706
USA

<http://www.cisco.com>
Tel: 408 526-4000
800 553-6387
Fax: 408 527-0883

This document includes various trademarks of Cisco Systems, Inc. Please see the Notices section of this document for a list of the Cisco Systems, Inc. trademarks used in this document.

Product and service availability are subject to change without notice.

© 2014 Cisco and/or its affiliates. All rights reserved.
April 2014

Part Number OL-31980-01