

Bissell®

AEROSWIFT USER GUIDE



1009 SERIES

IMPORTANT SAFETY INSTRUCTIONS

READ ALL INSTRUCTIONS BEFORE USING YOUR UPRIGHT VACUUM.

Always connect to a polarized outlet (one slot is wider than the other). Unplug from outlet when not in use and before conducting maintenance. When using an electrical appliance, basic precautions should be observed, including the following:

WARNING

TO REDUCE THE RISK OF FIRE, ELECTRIC SHOCK, OR INJURY:

- » Always connect to a polarized outlet (one slot is wider than the other). Do not modify the polarized plug to fit a non-polarized outlet or extension cord.
- » Do not leave vacuum cleaner when it is plugged in. Unplug from outlet when not in use and before servicing.
- » Do not use outdoors or on wet surfaces.
- » Do not allow to be used as a toy. Close attention is necessary when used by or near children.
- » Do not use for any purpose other than described in this User's Guide. Use only manufacturer's recommended attachments.
- » Do not use with damaged cord or plug. If appliance is not working as it should, has been dropped, damaged, left outdoors, or dropped into water, have it repaired at an authorized service center.
- » Do not pull or carry by cord, use cord as a handle, close a door on cord, or pull cord around sharp edges or corners. Do not run appliance over cord. Keep cord away from heated surfaces.
- » Do not unplug by pulling on cord. To unplug, grasp the plug, not the cord.
- » Do not handle plug or vacuum cleaner with wet hands.
- » Do not put any object into openings. Do not use with any opening blocked; keep openings free of dust, lint, hair, and anything that may reduce air flow.
- » Keep hair, loose clothing, fingers, and all parts of body away from openings and moving parts.
- » Turn off all controls before plugging or unplugging vacuum cleaner.
- » Use extra care when cleaning on stairs.
- » Do not use to pick up flammable or combustible materials (lighter fluid, gasoline, kerosine, etc.) or use in areas where they may be present.
- » Do not use vacuum cleaner in an enclosed space filled with vapors given off by oil base paint, paint thinner, some moth proofing substances, flammable dust, or other explosive or toxic vapors.
- » Do not use to pick up toxic material (chlorine bleach, ammonia, drain cleaner, etc.).
- » Do not pick up anything that is burning or smoking, such as cigarettes, matches, or hot ashes.
- » Do not use without filters in place.
- » Do not pick up hard or sharp objects such as glass, nails, screws, coins, etc.
- » Use only on dry, indoor surfaces.
- » Keep appliance on a level surface.
- » Do not carry the vacuum cleaner while it is running.
- » Unplug before connecting or disconnecting the Turbobrush® Tool

SAVE THESE INSTRUCTIONS FOR FUTURE USE

This model is for household use only.

THIS APPLIANCE HAS A POLARIZED PLUG

To reduce the risk of electric shock, this appliance has a polarized plug (one blade is wider than the other). This plug will fit in a polarized outlet only one way. If the plug does not fit fully in the outlet, reverse the plug. If it still does not fit, contact a qualified electrician to install a proper outlet. Do not change the plug in any way.

Thanks for buying a BISSELL vacuum

We're glad you purchased a BISSELL vacuum. Everything we know about floor care went into the design and construction of this complete, high-tech home cleaning system.

Your BISSELL vacuum is well made, and we back it with a limited two-year warranty. We also stand behind it with a knowledgeable, dedicated Consumer Care department, so, should you ever have a problem, you'll receive fast, considerate assistance.

My great-grandfather invented the floor sweeper in 1876. Today, BISSELL is a global leader in the design, manufacture, and service of high quality homecare products like your BISSELL vacuum.

Thanks again, from all of us
at BISSELL.

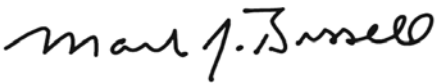

Mark J. Bissell
Chairman & CEO

Safety Instructions.....	2
Product View.....	4
Assembly	5-6
Operations	6-7
Maintenance & Care	8-12
Troubleshooting	13
Replacement Parts	14
Warranty.....	15
Consumer Care.....	16
Product Registration.....	16

Product View



- 1 Quick Release Handle
- 2 TurboBrush® Tool
- 3 Crevice Tool
- 4 Tank Release Button
- 5 Stretch Hose
- 6 Carry Handle

- 7 Extension Tool
- 8 Power Cord
- 9 Bottom Empty Dirt Bin
- 10 Filter Tray
- 11 Height Adjustment Knob
- 12 Quick Release Handle Lever

- 13 Combination Dusting/
Upholstery Tool
- 14 Hose Wand Base
- 15 Power Foot Pedal
- 16 Handle Release Lever

<p>⚠ WARNING Plastic film can be dangerous. To avoid danger of suffocation, keep away from babies and children.</p>	<p>⚠ WARNING Do not plug in your vacuum cleaner until you are familiar with all instructions and operating procedures.</p>	<p>⚠ WARNING To reduce the risk of electric shock, turn power switch off and disconnect polarized plug from electrical outlet before performing maintenance or troubleshooting checks.</p>
--	---	---

Febreze and related trademarks are owned by The Procter & Gamble Company, Cincinnati, Ohio and used under license by BISSELL Homecare, Inc.

Assembly

No tools required! Remove all protective plastic before assembly and operating.



Attach Quick Release Handle to Base

1. Locate vacuum handle and remove the protective plastic overwrap.

NOTE: The plastic wrap will easily slide off the handle by removing the TurboBrush® Tool Clip.

2. With the Quick Release Lever in upright position - slide handle into base and push the lever down to lock handle into place.

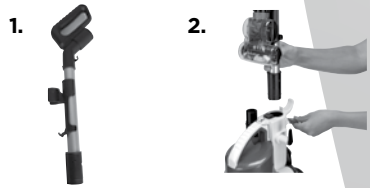

Attach TurboBrush® Tool to Handle Clip

1. Locate the TurboBrush® Tool in the box and remove the protective plastic wrap.

2. Snap the TurboBrush® Tool Clip to the handle.

3. Line up the back of the TurboBrush® to the bottom of the clip - the top of the brush opening will rest over the bottom of the clip.

4. With the lower tool in position, push the top of the tool handle into the upper clip to secure.

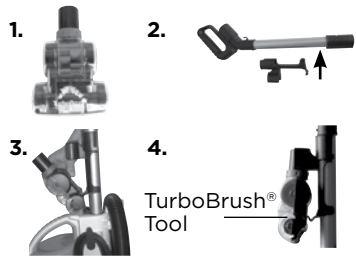

Attach Vacuum Hose and Secure Tools

1. Insert the end of the hose into the hose connector at the foot base inlet opening. Wrap the hose around the upper hose clip.

Note: Check that the tabbed end of the hose is connected and secured to the upper suction inlet. The vacuum will not operate properly unless the both hose ends are secure.

2. Check that the crevice tool is inserted into the extension wand in the storage post on the side of the vacuum.

3. Place the combo dusting/upholstery brush on the storage post located on the back of the unit under the wand release lever.

4. Wrap power cord around the cord wraps for storage.

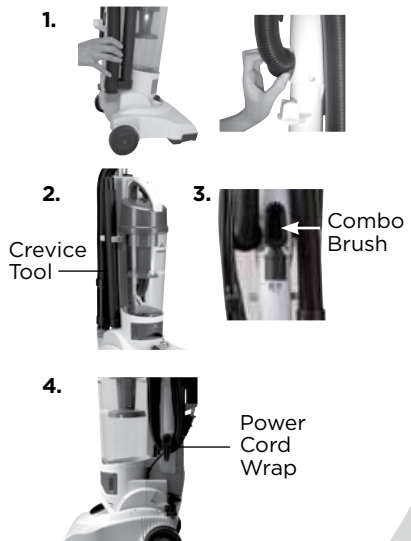

Assembly

Febreze® Foam Filter Option

Your vacuum comes with a standard foam filter (yellow) located in the lower filter tray. A separate Febreze® foam filter (black) is also packed in the box protected by a plastic bag. Replace the standard yellow foam filter with the Febreze® foam filter to eliminate odors and freshen as you vacuum.

NOTICE: Both foam filters are washable. Overtime, the Febreze® filter will begin to lose scent strength after use and washing. Reference the maintenance section for instructions on washing and replacing filters.

WARNING

Do not operate cleaner with damp or wet filters or without vacuum bags and all filters in place.



Filter

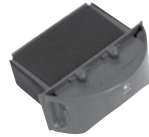

Filter Tray

Operations

Power Cord and Power Button:

1. To use your vacuum, remove the cord and plug into an electrical outlet. For quick cord access, rotate upper hook 180° and remove the cord. Rotate it back to store.
2. The power button pedal is located on lower back of the unit next to the handle release pedal.

Floor Cleaning

1. Press POWER button pedal located at the base of the unit to start cleaning.
2. Press handle release lever with your foot to start floor cleaning mode. Handle release pedal lever is located next to POWER button pedal.
3. To clean under low furniture, press the handle release pedal lever again to lower the handle.

NOTICE: The floor brush will continue to rotate in upright position. To prevent carpet damage, do not lean on the vacuum or let the power foot tilt forward.

2.

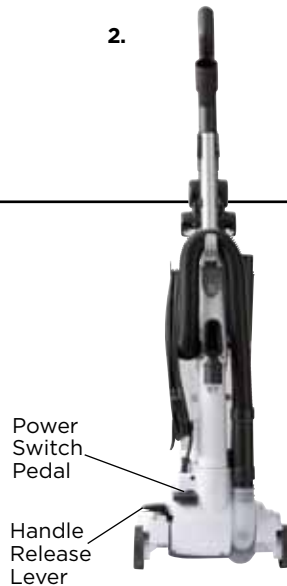

Operations

5 Height Adjustments

Turn the height adjustment dial on the front of the power foot to match your cleaning needs. The graphics around the dial indicate the appropriate setting for cleaning bare floor to high pile carpet. Turn the dial to the center for medium pile carpet.

NOTE: If difficult to push, adjust to highest setting.



Above Floor Cleaning

Long Reach Cleaning

Ideal for cleaning areas with 5- to 10-foot required reach.

1. In upright position, lift the Quick Release Lever on the back of the vacuum to slide the Quick Release Handle out of the base.

2. Remove the hose from the hose wand base and connect to the open inlet at the handle.

3. Connect desired tool to the end of the wand for cleaning different above floor surfaces.

a. Extension Wand: connect with a desired tool for a farther reach.

b. Crevice Tool: use in tight, narrow spaces.

c. TurboBrush® Tool: use air-driven power brush to clean areas such as stairs, furniture, and other areas too small to clean in floor cleaning mode.

d. Combo Dusting/Upholstery Brush: use dusting brush to clean delicate surfaces; slide dusting brush off to clean upholstery and other hard surfaces.

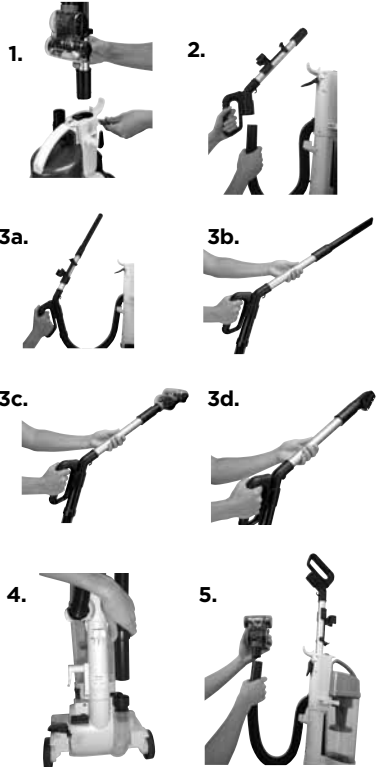

Short Reach Cleaning

Ideal for cleaning areas with below 5-foot required reach.

4. In upright position remove the hose from the hose wand base.

5. Attached desired tool to the end of the hose.

NOTICE:

The brush will continue to rotate at the same speed at all settings.

NOTICE:

Refer to maintenance section if you observe a loss in suction performance while in floor cleaning mode.

Maintenance & Care

Quick Tips

To maximize your cleaning performance and extend the life of your vacuum, it is important that you empty your dirt bin and clean your filters frequently.

1. Empty the dirt container when debris reaches the “full” line. For best performance, empty after each use.
2. Check the foam filter located in lower filter tray and clear out any dirt and debris before vacuuming. Wash with cold water or replace as needed.
3. Check rotating brush and belt for wear and tear at least once a month.

Empty Dirt Bin:

The dirt bin should be emptied before debris reaches the “full” line. The dirt bin is designed with a bottom empty release for less mess emptying.

1. Unplug the vacuum from electrical outlet.
2. Push the tank release button located on the front of the base of the unit above the carrying handle.
3. Grasp the carrying handle and carry the dirt bin to a garbage/waste bin.
4. With the dirt bin over a garbage/waste bin, push the empty release button located on the lower backside of the dirt bin to release the dirt.

NOTE: It may be necessary to gently tap the side of the bin against the garbage/waste bin to knock out any dirt or debris in the upper portion of the dirt bin.

5. When empty, close the bottom lid and it will lock into place.
6. Connect the dirt bin back onto the vacuum by fitting the bottom of the dirt bin into the vacuum base and then line up the carrying handle to fit under the dirt bin release tab. The handle will snap into place to secure.

NOTE: Make sure the power cord does not interfere with connecting the dirt bin back into base.

WARNING

To reduce the risk of electric shock, turn power switch off and disconnect polarized plug from electrical outlet before performing maintenance or troubleshooting checks.

2.



4.



5.



6.



Maintenance & Care

Cleaning Upper Tank and Inner Cyclone

After emptying the dirt bin, if there still is dirt and debris in the upper tank, you can easily clean the upper tank with these simple steps.

1. Before cleaning upper tank, empty all loose dirt and debris using the bottom empty push button feature.
2. Remove upper tank by grasping carrying handle and base of dirt bin and sliding to unlock position. Use the graphics on the back of the dirt bin below the suction inlet to guide you in direction to unlock and lock.
3. Pull the upper tank out of the dirt bin.
4. Grasp the inner cyclone and twist to the left until the locking tabs stop the rotation. Pull down from the upper tank to remove and clean. Wipe out the inside of the upper tank and inner cyclone with a damp cloth moistened with water or a mild cleaning solution.

NOTE: The inner cyclone may be washed using a mild detergent; it must be completely dry before reassembling or damage to your unit may result. Do not clean in dishwasher.

5. There is a rubber seal surrounding the cyclone base and the cap. Check to make sure there is no ripping or damage to the seal. Do not remove the seal. If damaged, call BISSELL Consumer Care for replacement.
6. Once cleaning is complete, replace the inner cyclone by sliding into the upper tank housing. Line up the tabs in the upper tank and rotate to the right until the locking tabs stop the rotation.
7. Position the upper tank onto the dirt bin by lining up the arrow on the upper tank with the unlock graphic on the dirt bin. Twist the upper tank to line the arrow graphic with the lock graphic on the dirt bin.
8. Connect the dirt bin back onto vacuum base.

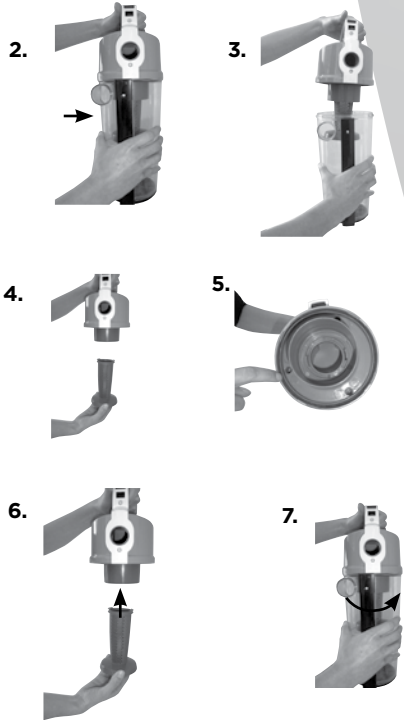

WARNING

To reduce the risk of electric shock, turn power switch off and disconnect polarized plug from electrical outlet before performing maintenance or troubleshooting checks.

Maintenance & Care

Clearing Clogs

Low suction or poor pickup may be due to a clog in the vacuum cleaner. If you notice a change in the sound of the motor, check for clogs.

1. Turn power button off and unplug vacuum from electrical outlet.
2. Empty dirt bin and check the upper tank for build up or clogs. Refer to cleaning upper tank and inner cyclone section.
3. Check for clogs in the hose by removing the hose from the upper hose inlet and base.
 - a. Grasp the hose collar tabs and turn hose to the left and slide out.
 - b. Remove the hose from the base of the unit and pull out of lower suction inlet.
 - c. Straighten the hose and unclog with a long, narrow object such as a broom handle.
 - d. Reconnect the tabbed hose collar to the upper suction inlet by pressing tabs to insert and release tabs and rotate until locked. Connect the lower hose back into the lower base before operating.

NOTE: If removing the hose from the upper hose inlet is difficult, remove the power cord from the upper cord wrap along with the dusting brush for easy access.

4. With the hose removed from the lower hose inlet, check for clogs in the base hose connector.
 - a. If you notice a clog, remove the extension tools from the storage post and remove the screw in the lower hose base connector with a Phillips screwdriver.
 - b. Slide the lower hose collar up out of the tabs and straighten the hose to unclog. Use a long object to reach in and unclog.
 - c. Connect the lower hose collar by lining up the tab grooves with the base and pushing down. Replace the screw back into the base to secure.

WARNING

To reduce the risk of electric shock, turn power switch off and disconnect polarized plug from electrical outlet before performing maintenance or troubleshooting checks.

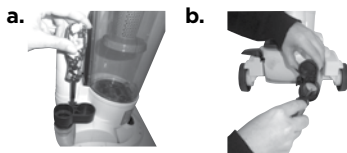
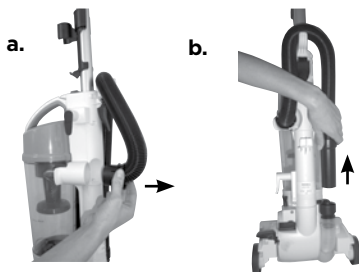

Check rotating floor brush and drive belt

Check your vacuum's rotating floor brush and drive belt regularly for wear or damage. Remove any strings, hair and carpet fibers that may wrap around the brush. This type of debris may reduce cleaning performance on carpet. Remove any debris that accumulates under the brush cover.

Maintenance & Care

Check Rotating Floor Brush

1. Unplug the vacuum from electrical outlet.
2. Recline the handle into lowest position and turn the vacuum over so bottom side is facing up. Remove dirt bin to avoid any damage to the bin and easier access to the floor brush.
3. Remove the 3 screws in the brush cover using a Phillips screwdriver. Lift up and remove the brush cover to access brush roll.
4. Grasp the rotating brush at both ends at lift out.
5. Clear strings, hair and other debris from the brush, brush cover, motor pulley and drive belt areas.
6. Check the drive belt for wear, cuts or stressed areas. If you see no visible damage, keep the belt connected to motor pulley. If belt is damaged, refer to replace drive belt section.
7. With drive belt connected to motor pulley, pull the belt over the brush roll and position the floor brush into the brush cover ends. Rotate the brush end opposite of the belt to line up with the brush cover tab. The brush end closest to the belt will slide in the tab without needing to rotate.
8. Replace brush cover and secure with the 3 screws.

WARNING

To reduce the risk of injury from moving parts, turn off vacuum cleaner and disconnect Power Plug from electrical outlet.

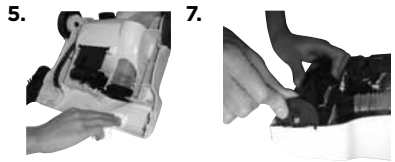
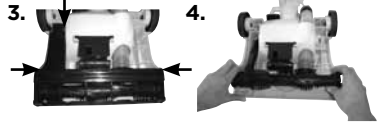

Maintenance & Care

Replace drive belt

1. Unplug the vacuum from electrical outlet.
2. With rotating brush removed (follow steps from check rotating brush section), grasp old drive belt and remove from motor pulley. If difficult to remove from pulley, use scissors to cut and remove belt.
3. Place the new drive belt over motor pulley and loop other end over rotating floor brush in the space between bristles.

NOTE: The space between the motor pulley and the foot covering is tight. Slide the thin side of the belt down between the motor pulley and foot covering and work with your fingers to position under the motor pulley.

4. With drive belt connected to motor pulley, pull the belt over the brush roll and position the floor brush into the brush cover ends. Rotate the brush end opposite of the belt to line up with the brush cover tab. The brush end closest to the belt will slide in the tab without needing to rotate.
5. Replace brush cover and secure with the 3 screws.

Check and clean filter

The vacuum comes with a standard foam filter (yellow) located in the filter tray. A Febreze® foam filter (black) is packed into the box in a protective plastic bag. Replace the standard filter with the Febreze® foam filter to eliminate odors and freshen as you vacuum.

1. Unplug the vacuum from electrical outlet.
2. The foam filter is located in the slide out filter tray underneath the dirt bin. It is recommended to check the filter regularly and remove any dirt or debris build up in the tray after or before use.
3. Both the standard yellow foam filter and the Febreze® (black) foam filter are washable. Hand wash in cold water with mild detergent. Rinse well and air dry thoroughly before replacing.

NOTICE: Overtime with use and washing, you will begin to notice a loss of scent strength as you vacuum with the Febreze® filter. Even with loss in scent, if there is no wear to the foam, the filter will continue to work effectively by protecting the motor from dirt particles. Contact BISSELL Consumer Care to order replacement filters.

⚠️ WARNING

To reduce the risk of electric shock, turn power switch off and disconnect polarized plug from electrical outlet before performing maintenance or troubleshooting checks.

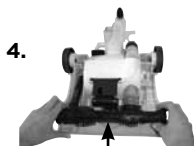

⚠️ WARNING

Do not operate cleaner with damp or wet filters or without vacuum bags and all filters in place.



Troubleshooting

WARNING

To reduce the risk of electric shock, turn power switch off and disconnect polarized plug from electrical outlet before performing maintenance or troubleshooting checks.

Problem	Possible causes	Remedies
Vacuum cleaner won't turn on	Power cord not plugged in	Check electrical plug
	Blown fuse/tripped breaker	Check/replace fuse or reset breaker
	Damaged cord	Contact a BISSELL authorized service center for repair or replacement
Vacuum cleaner won't pick up	Clog in hose or elsewhere in vacuum	Follow instructions on page 10 for clearing clogs
	Dirty filter	Check and clean or replace foam filter - see page 12
	Dirt container is full	Empty dirt container
	Hose not attached properly	Grasp quick reach handle and firmly push hose wand onto the hose wand base
	Dirt container or upper tank not installed properly	Position correctly and lock in place
Tool won't pick up	Clog in hose or elsewhere in vacuum	Follow instructions on page 10 for clearing clogs
	Dirty filter	Check and clean or replace foam filter - see page 12
	Dirt container is full	Empty dirt container
Visible dirt escaping from cleaner	Dirt container full	Empty dirt container

Please do not return this product to the store.















Other maintenance or service not included in the manual should be performed by an authorized service representative.

Thank you for selecting a BISSELL product.

For any questions or concerns, BISSELL is happy to be of service. Contact us directly at 1-800-237-7691.

Replacement Parts

These items are available for your **BISSELL AeroSwift Compact Vacuum**.
Call 1-800-237-7691 or visit www.bissell.com

PART #	PART NAME		PART #	PART NAME	
160-0293	Quick Release Handle		203-1429	TurboBrush® Tool	
160-0294	TurboBrush® Tool Handle Clip		160-0296	Extension Wand	
160-0297	Crevice Tool		160-0298	Combo Dusting/Upholstery Tool	
160-0304	Standard Foam Filter (yellow)		160-0305	Febreze® Foam Filter (black)	
160-0295	Hose		160-0318	Floor Brush	
160-0319	Drive Belt		160-0314	Dirt Bin Assembly	

Warranty

This warranty gives you specific legal rights, and you may also have other rights which may vary from state to state. If you need additional instruction regarding this warranty or have questions regarding what it may cover, please contact BISSELL Consumer Care by E-mail, telephone, or regular mail as described below.

Limited Two-Year Warranty

Subject to the *EXCEPTIONS AND EXCLUSIONS identified below, upon receipt of the product BISSELL will repair or replace (with new or remanufactured components or products), at BISSELL's option, free of charge from the date of purchase by the original purchaser, for two years any defective or malfunctioning part.

See information below on "If your BISSELL product should require service".

This warranty applies to product used for personal, and not commercial or rental service. This warranty does not apply to fans or routine maintenance components such as filters, belts, or brushes. Damage or malfunction caused by negligence, abuse, neglect, unauthorized repair, or any other use not in accordance with the User's Guide is not covered.

BISSELL IS NOT LIABLE FOR INCIDENTAL OR CONSEQUENTIAL DAMAGES OF ANY NATURE ASSOCIATED WITH THE USE OF THIS PRODUCT. BISSELL'S LIABILITY WILL NOT EXCEED THE PURCHASE PRICE OF THE PRODUCT.

Some states do not allow the exclusion or limitation of incidental or consequential damages, so the above limitation or exclusion may not apply to you.

*EXCEPTIONS AND EXCLUSIONS FROM THE TERMS OF THE LIMITED WARRANTY

THIS WARRANTY IS EXCLUSIVE AND IN LIEU OF ANY OTHER WARRANTIES EITHER ORAL OR WRITTEN. ANY IMPLIED WARRANTIES WHICH MAY ARISE BY OPERATION OF LAW, INCLUDING THE IMPLIED WARRANTIES OF MERCHANTABILITY AND FITNESS FOR A PARTICULAR PURPOSE, ARE LIMITED TO THE TWO YEAR DURATION FROM THE DATE OF PURCHASE AS DESCRIBED ABOVE.

Some states do not allow limitations on how long an implied warranty last so the above limitation may not apply to you.

NOTE: Please keep your original sales receipt. It provides proof of date of purchase in the event of a warranty claim.

Service

If your BISSELL product should require service:

Visit BISSELL.com or contact BISSELL Consumer Care to locate a BISSELL Authorized Service Center in your area.

If you need information about repairs or replacement parts, or if you have questions about your warranty, contact BISSELL Consumer Care.

Website or E-mail:

www.BISSELL.com

Or Call:

BISSELL Consumer Care
1-800-237-7691

Monday - Friday 8am - 10pm ET

Saturday 9am - 8pm ET

Sunday 10am - 7pm ET

Or Write:

BISSELL Homecare, Inc.

PO Box 3606

Grand Rapids, MI 49501

ATTN: Consumer Care

Register your product today!

Registering is quick, easy and offers you benefits over the lifetime of your product.

You'll receive:

BISSELL Rewards Points

Automatically earn points for discounts and free shipping on future purchases.

Faster Service

Supplying your information now saves you time should you need to contact us with questions regarding your product.

Product Support Reminders and Alerts

We'll contact you with any important product maintenance reminders and alerts.

Special Promotions

Optional: Register your email to receive notice of offers, contests, cleaning tips and more!

Visit www.BISSELL.com/registration now!

BISSELL Consumer Care

For information about repairs or replacement parts, or questions about your warranty:

Call:

BISSELL Consumer Care
1-800-237-7691

Monday - Friday 8 am - 10 pm ET
Saturday 9 am - 8 pm ET
Sunday 10am - 7pm ET

Write:

BISSELL Homecare, Inc.
PO Box 3606
Grand Rapids MI 49501
ATTN: Consumer Care

Visit the BISSELL website: www.BISSELL.com

When contacting BISSELL, have model number of cleaner available.

Please record your Model Number: _____

Please record your Purchase Date: _____

NOTE: Please keep your original sales receipt. It provides proof of purchase date in the event of a warranty claim. See Warranty on page 15 for details.



©2015 BISSELL Homecare, Inc.
Grand Rapids, Michigan
All rights reserved. Printed in China
Part Number 160-0238 Rev 12/12
Visit our website at: www.BISSELL.com