

**AFG3000 Series
Arbitrary Function Generators
Quick Start User Manual**



077-0957-02

Tektronix

**AFG3000 Series
Arbitrary Function Generators
Quick Start User Manual**

Copyright © Tektronix. All rights reserved. Licensed software products are owned by Tektronix or its subsidiaries or suppliers, and are protected by national copyright laws and international treaty provisions.

Tektronix products are covered by U.S. and foreign patents, issued and pending. Information in this publication supersedes that in all previously published material. Specifications and price change privileges reserved.

TEKTRONIX and TEK are registered trademarks of Tektronix, Inc.

Additional trademark statements can be added here.

Contacting Tektronix

Tektronix, Inc.
14150 SW Karl Braun Drive
P.O. Box 500
Beaverton, OR 97077
USA

For product information, sales, service, and technical support:

- In North America, call 1-800-833-9200.
- Worldwide, visit www.tek.com to find contacts in your area.

Table of Contents

Environmental considerations	v
General safety summary	vi
Preface	viii
Where to find more information.....	viii
Conventions used in this manual.....	viii
Getting started.....	1
General features.....	1
Before installation	3
Operating requirements	3
Standard accessories.....	4
Optional accessories.....	5
Cleaning	5
Power the instrument on and off	6
Change instrument settings at power-on	7
Erase instrument setups and waveforms from memory.....	8
Perform instrument self test and self calibration	8
Select a local language	10
Protect your instrument from misuse	11
Floating ground	13
Protect your DUT.....	14
Update your instrument firmware.....	15
Connect to a network.....	17
Equivalent output circuits	21
Overheat protection (AFG3011 / 3011C Only).....	23
Instrument interface, front panel, and rear panel.....	24
Front panel overview.....	24
Parts of the screen interface	25
View button.....	26
Shortcut buttons.....	28
Default setup.....	29
Select waveform.....	30
Select Run Mode.....	34
Adjust waveform parameters	35
Channel select (dual-channel model only).....	37
Output ON/OFF.....	38
Rear panel	39
Operating basics	41
Quick tutorial: How to select a waveform and adjust parameters.....	41
Quick tutorial: How to generate a sine waveform	41
Quick tutorial: Instrument help system	44

Generate a pulse waveform	45
Save/Recall arbitrary waveforms	47
Generate an arbitrary waveform	48
Modify an arbitrary waveform (Edit Menu)	49
Generate noise/DC	53
Generate a burst waveform	54
Sweep a waveform	55
Modulate a Waveform.....	58
Trigger Out	63
Adjusting Parameters of Two Channel Signals (dual-channel models only).....	65
Set up Load Impedance	68
Invert Waveform Polarity	69
Add Noise	70
Add Signal (AFG3100 and AFG3200 Series).....	71
Generating a Differential Signal	72
External Reference Clock.....	74
Synchronous Operation	75
USB flash drive.....	77
Utility Menu.....	78
Save/Recall Instrument Setup	80
Saving a Screen Image	81
Using the Security Menu.....	81
ArbExpress	84
Application Examples.....	91
Lissajous Patterns.....	91
Measurement of Filter Characteristics.....	92
Motor Speed Control by Pulse-Width Modulation.....	92
Carrier Null (Frequency Modulation)	93

List of Figures

Figure 1: Fuse and fuse adapter..... 12

List of Tables

Table i: Supported products	viii
Table 1: General features for regular and B models	1
Table 2: General features for C models	2
Table 3: Standard accessories	4
Table 4: Optional accessories	5

Environmental Considerations

This section provides information about the environmental impact of the product.

Product End-of-Life Handling

Observe the following guidelines when recycling an instrument or component:

Equipment recycling. Production of this equipment required the extraction and use of natural resources. The equipment may contain substances that could be harmful to the environment or human health if improperly handled at the product's end of life. To avoid release of such substances into the environment and to reduce the use of natural resources, we encourage you to recycle this product in an appropriate system that will ensure that most of the materials are reused or recycled appropriately.



This symbol indicates that this product complies with the applicable European Union requirements according to Directives 2002/96/EC and 2006/66/EC on waste electrical and electronic equipment (WEEE) and batteries. For information about recycling options, check the Support/Service section of the Tektronix Web site (www.tek.com).

Restriction of Hazardous Substances

This product is classified as Monitoring and Control equipment, and is outside the scope of the 2002/95/EC RoHS Directive.

General safety summary

Review the following safety precautions to avoid injury and prevent damage to this product or any products connected to it.

To avoid potential hazards, use this product only as specified.

Only qualified personnel should perform service procedures.

While using this product, you may need to access other parts of a larger system. Read the safety sections of the other component manuals for warnings and cautions related to operating the system.

To avoid fire or personal injury

Use proper power cord. Use only the power cord specified for this product and certified for the country of use.

Ground the product. This product is grounded through the grounding conductor of the power cord. To avoid electric shock, the grounding conductor must be connected to earth ground. Before making connections to the input or output terminals of the product, ensure that the product is properly grounded.

Observe all terminal ratings. To avoid fire or shock hazard, observe all ratings and markings on the product. Consult the product manual for further ratings information before making connections to the product.

Do not apply a potential to any terminal, including the common terminal, that exceeds the maximum rating of that terminal.

Power disconnect. The power cord disconnects the product from the power source. Do not block the power cord; it must remain accessible to the user at all times.

Do not operate without covers. Do not operate this product with covers or panels removed.

Do not operate with suspected failures. If you suspect that there is damage to this product, have it inspected by qualified service personnel.

Avoid exposed circuitry. Do not touch exposed connections and components when power is present.

Do not operate in wet/damp conditions.

Do not operate in an explosive atmosphere.

Keep product surfaces clean and dry.

Provide proper ventilation. Refer to the manual's installation instructions for details on installing the product so it has proper ventilation.

Terms in this manual These terms may appear in this manual:



WARNING. *Warning statements identify conditions or practices that could result in injury or loss of life.*

CAUTION. *Caution statements identify conditions or practices that could result in damage to this product or other property.*

Symbols and terms on the product

These terms may appear on the product:

- DANGER indicates an injury hazard immediately accessible as you read the marking.
- WARNING indicates an injury hazard not immediately accessible as you read the marking.
- CAUTION indicates a hazard to property including the product.

The following symbols may appear on the product:



Preface





This manual describes the installation and operation of Tektronix AFG3000 Series Arbitrary Function Generators along with basic operations and concepts. The following instruments are supported by this manual:



Table i: Supported products

AFG3011	AFG3021B	AFG3011C
AFG3101	AFG3022B	AFG3021C
AFG3102		AFG3022C
AFG3251		AFG3051C
AFG3252		AFG3052C
		AFG3101C
		AFG3102C
		AFG3251C
		AFG3252C

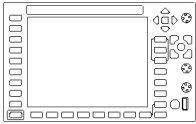
Where to find more information

The following table lists related documentation available for your instrument. The documentation is available on the Tektronix Web site (www.tek.com/downloads).

Item	Purpose	Location
Safety and Compliance Instructions	Safety, compliance, and basic power information	 WWW.Tektronix.com
Quick Start User Manual	Unpacking, Installation, Tutorials, Operation, and Overviews	 WWW.Tektronix.com
Built-in Help	UI Help and Operation	
Programmer Manual	Menu Structures, User Interface, and Programming Information	 WWW.Tektronix.com
Service Manual	Self-service and Performance test	 WWW.Tektronix.com

Item	Purpose	Location
Technical Reference	Specifications and performance verification procedures	 WWW.Tektronix.com
ArbExpress Software CD	Waveform creation Import waveforms from oscilloscope or PC	 +  WWW.Tektronix.com

NOTE. Please see the printed *Safety and Compliance Instructions* that were shipped with your instrument for general safety summary, EMC compliance, and safety compliance information.

Conventions used in this manual

The following icons are used throughout this manual.

Front panel power



Connect power

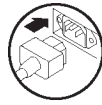

Network

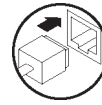

USB

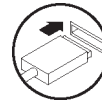

The soft keys along the right side of the display are called *bezel buttons* in this manual. In other documents, they may also be called *option buttons* or *side-menu buttons*.

Getting started

General features

Each AFG3000 Series Arbitrary Function Generators offers the functionality of three generators in one:

- 10 MHz to 240 MHz Function Generator
- 5 MHz to 120 MHz Pulse Generator
- 14-bit Arbitrary Waveform Generator

The following tables describe some of the general features of your instrument. An “X” means the feature is included with the model.

Table 1: General features for regular and B models

Feature	AFG3011	AFG3021B/ AFG3022B	AFG3101/ AFG3102		AFG3251/ AFG3252	
Channel	1	1/2	1/2		1/2	
Sine	10 MHz	25 MHz	100 MHz		240 MHz	
Pulse	5 MHz	12.5 MHz	50 MHz		120 MHz	
Memory	2 to 131,072	2 to 131,072	2 to 16,384	>16,384 to 131,072	2 to 16,384	>16,384 to 131,072
Sampling Rate	250 MS/s	250 MS/s	1 GS/s	250 MS/s	2 GS/s	250 MS/s
Amplitude	20 Vp-p	10 Vp-p	10 Vp-p		5 Vp-p	
Display	Color	Monochrome/ Color	Color		Color	
Interface	USB, LAN, GPIB	USB, LAN, GPIB	USB, LAN, GPIB		USB, LAN, GPIB	
Ground isolation	X	X	X		X	
Synchronous operation	X	X	X		X	
Context-sensitive Help system	X	X	X		X	
ArbExpress® Software	X	X	X		X	

Table 2: General features for C models

Feature	AFG3011C	AFG3021C/ AFG3022C	AFG3051C/ AFG3052C	AFG3101C / AFG3102C	AFG3251C / AFG3252C		
Channel	1	1 / 2	1 / 2	1 / 2	1 / 2		
Sine	10 MHz	25 MHz	50 MHz	100 MHz	240 MHz		
Pulse	5 MHz	25 MHz	40 MHz	50 MHz	120 MHz		
Memory	2 to 131,072	2 to 131,072	2 to 131,072	2 to 16,384	>16,384 to 131,072	2 to 16,384	>16,384 to 131,072
Sampling Rate	250 MS/s	250 MS/s	1 GS/s	1 GS/s	250 MS/s	2 GS/s	250 MS/s
Amplitude	20 Vp-p	10 Vp-p	10 Vp-p	10 Vp-p	5 Vp-p		
Display	Color	Color	Color	Color	Color		
Interface	USB, LAN, GPIB	USB, LAN, GPIB	USB, LAN, GPIB	USB, LAN, GPIB	USB, LAN, GPIB		
Ground isolation	X	X	X	X	X		
Synchronous operation	X	X	X	X	X		
Context-sensitive Help system	X	X	X	X	X		
ArbExpress® Software	X	X	X	X	X		

Before installation

Inspect the instrument carton for external damage. If the carton is damaged, notify the carrier.

Remove the instrument from its package and check that it has not been damaged in transit. Verify that the carton contains the instrument and its standard accessories.

Operating requirements

Environmental

- Place the instrument on a cart or bench, observing clearance requirements:
 - Sides: 50 mm (2 in)
 - Rear: 50 mm (2 in)
- Before operating, ensure that the ambient temperature is between 0 °C to +50 °C (+32 °F to +122 °F).

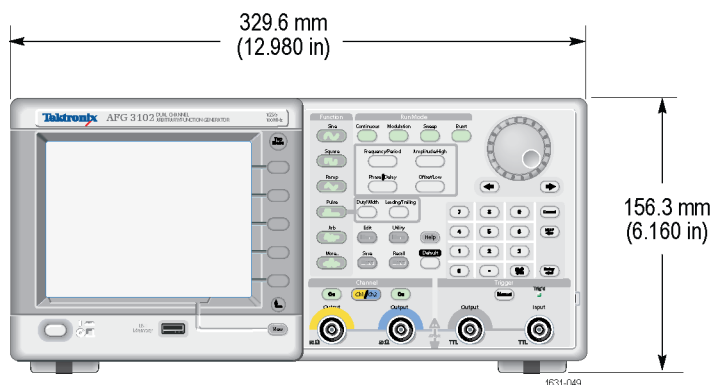

CAUTION. To ensure proper cooling, keep both sides of the instrument clear of obstructions.

Power Supply Requirements

WARNING. To reduce the risk of fire and shock, ensure that the mains supply voltage fluctuations do not exceed 10% of the operating voltage range.

Requirement	AFG3000 series / AFG3000B series / AFG3000C series
Source Voltage and Frequency	100 V to 240 V, 47 Hz to 63 Hz; or 115 V, 360 Hz to 440 Hz
Power Consumption	Less than 120 W

Standard accessories

Unpack the instrument and check that you received all items listed as Standard Accessories. Check the Tektronix Web site (www.tek.com) for the most current information.

Table 3: Standard accessories

Description	Tektronix part number
AFG3000 Series Arbitrary Function Generators Safety and Compliance Instructions	071-3244-xx
AFG3000 Series Arbitrary Function Generators Programmer Manual	077-0743-xx
AFG3000 Series Arbitrary Function Generators Service Manual	077-0744-xx
AFG3000 Series Arbitrary Function Generators Specifications and Performance Verification Manual	077-0691-XX
ArbExpress (Application Software for Tektronix Arbitrary Function Generators) Software CD	063-3763-xx
Power cord	
North America (Option A0)	161-0066-00
Universal Euro (Option A1)	161-0066-09
United Kingdom (Option A2)	161-0066-10
Australia (Option A3)	161-0066-13
Switzerland (Option A5)	161-0154-00
Japan (Option A6)	161-0298-00
China (Option A10)	161-0304-00
India (Option A11)	161-0400-00
Brazil (A12)	161-0357-00
No power cord or AC adapter (Option A99)	- - -

¹ These manuals contain a language overlay for the front panel controls.

Optional accessories

The following optional accessories are recommended for your instrument:

Table 4: Optional accessories

Description	Tektronix part number
50 Ω BNC cable, double-shielded, 91 cm (36 in)	012-0482-XX
50 Ω BNC cable, double-shielded, 250 cm (98 in)	012-1256-XX
GPIB interface cable, double-shielded, 200 cm (79 in)	012-0991-XX
Rackmount kit	RM3100
Fuse adapter (BNC-P to BNC-R)	013-0345-XX
0.125 fuse set (contains three fuses)	159-0454-XX

NOTE. To ensure the EMC compliance listed in the Specifications, connect only high quality shielded cables to this instrument. High quality shielded cables typically are braid and foil types that have low-impedance connection to shielded connectors at both ends.

Cleaning

Inspect the instrument as often as operating conditions require. To clean the exterior surface, perform the following steps:

1. Remove loose dust on the outside of the instrument with a lint-free cloth. Use care to avoid scratching the display.
2. Use a soft cloth dampened with water to clean the instrument. Use an aqueous solution of 75% isopropyl alcohol for more efficient cleaning.

CAUTION. To avoid damage to the surface of the instrument, do not use any abrasive or chemical cleaning agents.

CAUTION. Avoid getting moisture inside the unit during external cleaning. Use only enough cleaning solution to dampen the cloth or swab.

Power the instrument on and off

The following procedures show you how to apply power to the instrument and turn it on and off.

Power on

1. Insert the AC power cord into the power receptacle on the rear panel.

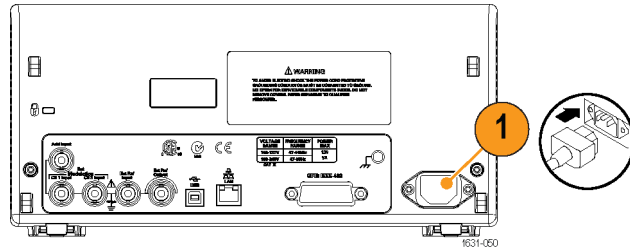

2. Push the front-panel power button to power on the instrument.
Wait until the front-panel display shows that the instrument has passed all power-on self tests before using the instrument.

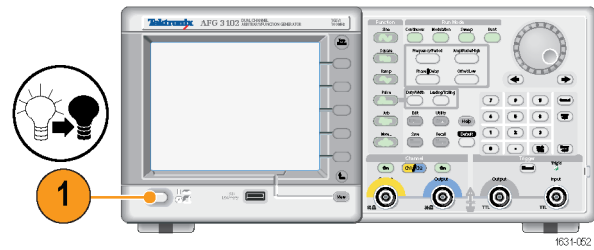

Power off

1. Push the front-panel power button to power off the instrument.



Change instrument settings at power-on

The default settings are restored when you power on the instrument. You can change the power-on settings to the last powered-off settings from the Utility menu using the following procedure.

NOTE. You can restore the instrument to its default settings at any time by pushing the front-panel Default button.

1. Push the front-panel Utility button.
2. Push the System bezel button.

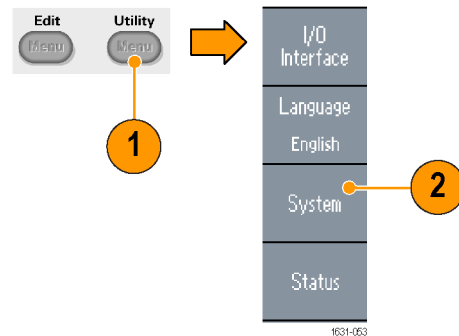

3. Push the Power On bezel button to select from the following the power on settings.

- **Default** restores the default settings when the instrument is powered on.
- **Last** restores the same settings as when the instrument was last powered off.

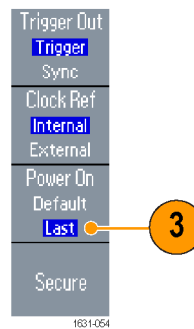

Erase instrument setups and waveforms from memory

You can also erase all instrument setups and waveforms from the instrument internal memory using the following procedure.

NOTE. You can restore the instrument to its default settings at any time without erasing memory by pushing the front-panel Default button.

1. Push the front-panel Utility button.
2. Push the System bezel button.

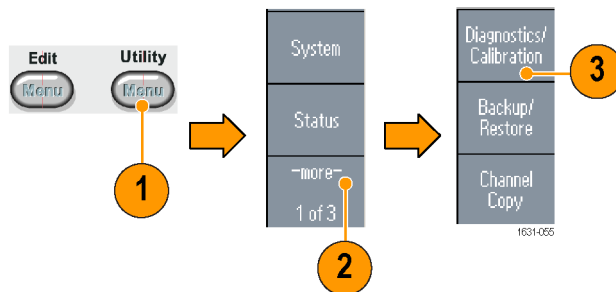

3. Push the Secure bezel button.
4. Push the **OK** bezel button to erase all setups and waveforms stored in internal memory, or push the **Cancel** bezel button to cancel the operation.

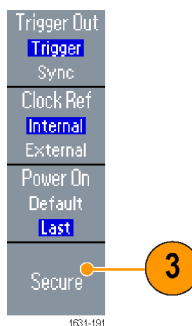

Perform instrument self test and self calibration

The instrument performs a limited set of hardware tests at power-on. You can also perform the following manual diagnostics and/or self calibration using the Utility menu:

- **Diagnostics (Self test):** Perform the self test to verify that your instrument is operating correctly.
- **Calibration (Self calibration):** The self calibration mainly checks DC accuracy using the internal calibration routines.

NOTE. If you need to verify that the instrument meets the warranted specifications, do the complete set of performance verification procedures provided in the *Specifications and Performance Verification manual*.

1. Push the front-panel Utility button.
2. Push the -more- bezel button.
3. Push the Diagnostics/Calibration bezel button.

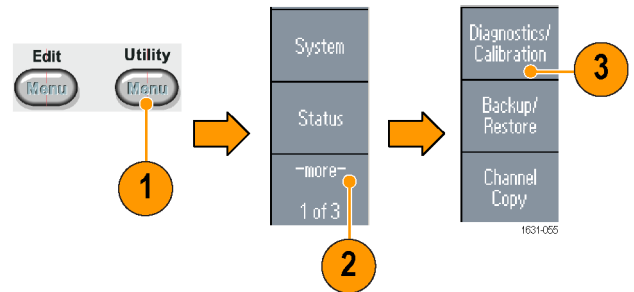

4. To execute the instrument diagnostics, push the Execute Diagnostics bezel button.
To execute self calibration, push the Execute Calibration bezel button.
5. If Diagnostics completes without any errors, the message "PASSED" is displayed.

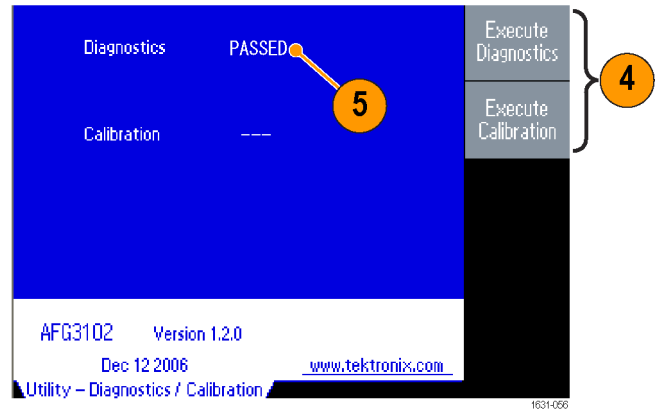

CAUTION. Do not power off the instrument while executing self calibration. If the power is turned off during self calibration, data stored in the internal memory may be lost.

Quick Tips

- Before executing self calibration, ensure that the ambient temperature is between +20 °C and +30 °C (+68 °F to +86 °F). Allow a 20 minute warm-up period before executing self calibration.
- Disconnect all the cables from the instrument when you perform self test or self calibration.
- Perform self calibration at least once a year to maintain DC accuracy. It is recommended that the self calibration should be performed along with a periodic check.

Select a local language

You can select the language you want displayed on the instrument screen.

1. Push the front-panel Utility button.

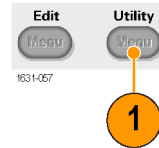

2. Push the Language bezel button.

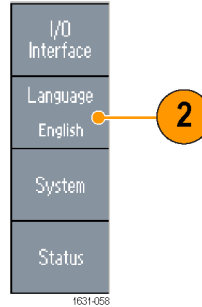

3. Select the desired language.

You can select from English, French, German, Japanese, Korean, Simple Chinese, Traditional Chinese, and Russian.

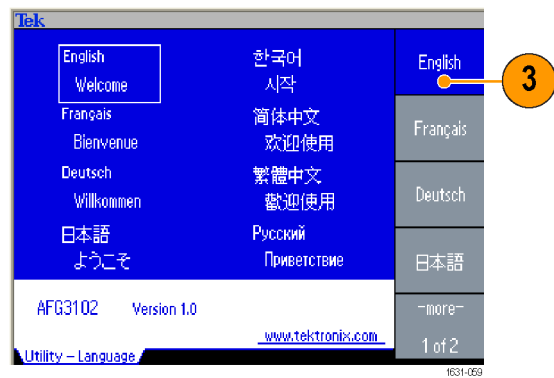

Quick Tips

- When you power on the instrument for the first time, English is selected by default. After you select a desired language, all the bezel menus, pop-up messages, and built-in help are displayed in the specified language. The main display area is not translated.
- Use the front-panel overlay that corresponds to each local language.

Protect your instrument from misuse

Check input and output connectors

1. Locate the output connectors on the front panel. The image shown here shows the outputs.
2. Locate the input connector on the front panel. Some instrument models have more than one input.

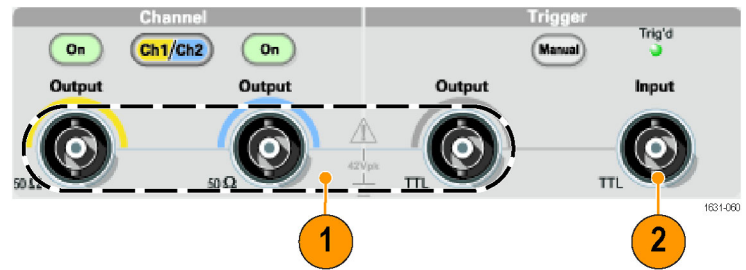

NOTE. When connecting a cable, be sure to distinguish the input connector from the output connectors to avoid making the wrong connection.

The instrument input and output connectors are floating inputs/outputs.



WARNING. To avoid personal injury due to electric shock, do not apply voltages in excess of 42 V_{pk} to any BNC connector ground or to the chassis ground.

CAUTION. Do not short output pins or apply external voltages to Output connectors. The instrument may be damaged.

CAUTION. Do not apply excessive inputs over +5 V to Trigger Input connector. The instrument may be damaged.

Use fuse adapter

The instrument will be damaged if a large DC or AC voltage is applied to the output or input connectors. To protect the output circuits, a fuse adapter is provided as an optional accessory. When the instrument is used by students or other inexperienced users, always attach the fuse adapter to the output connectors to avoid damage. (See page 5, *Optional accessories*.)

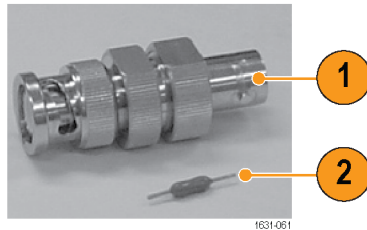

Figure 1: Fuse and fuse adapter

1. Fuse adapter
2. Fuse

Floating ground

Since the common (input and output channel common) of the arbitrary function generator is electrically isolated from the chassis ground (the instrument chassis and ground line of the AC connector), you can make a floating connection between the instrument and other equipment.

All the signal output connectors are connected to the common ground, and the remote interface connector is connected to the chassis ground.



WARNING. To prevent electrical shock, use this product so that the sum of the floating voltage and the output voltage of the instrument does not exceed 42 V_{pk}. Do not touch the center of the BNC while the equipment is in use.

CAUTION. The maximum rated voltage between the chassis ground and common ground is 42 V_{p-p} (DC + peak AC). When the potential voltage between the chassis ground and common ground goes over 42 V_{p-p}, the internal protective circuit will be activated to protect the circuits. However, higher voltage may cause the internal circuits in the instrument to be damaged.

When a potential voltage exists between the chassis ground and common ground, a short circuit from output to ground causes the instrument internal fuse to open and the output is stopped. If the fuse opens, you need to contact your local Tektronix Service Support.

When a potential voltage exists between the common ground and chassis ground, short-circuiting between them may lead to excessive current flow and the internal or external circuits may be damaged.

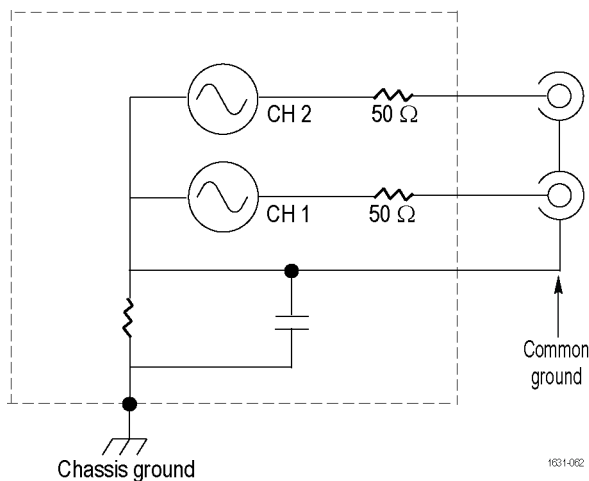

Protect your DUT

Use care when you connect the instrument Channel Output to your DUT (device under test). To avoid damage to your DUT, the following preventive measures are provided. Follow these steps to set the limit values for high level and low level.

1. Push the front-panel Top Menu button. The Output Menu is displayed at the bottom of the bezel menu. Select Output Menu.
2. In this example, High Limit is set to 5.000 V, and Low Limit is set to -5.000 V.

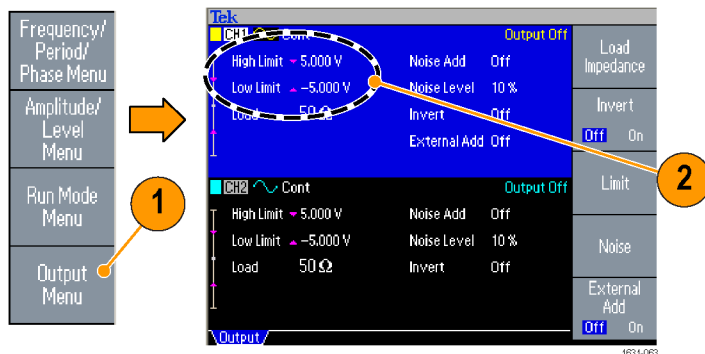

3. Push the Limit bezel button.
4. Select High Limit. Use numeric keys or the general purpose knob to enter a value. Enter 50 mV for High Limit, and -50 mV for Low Limit.

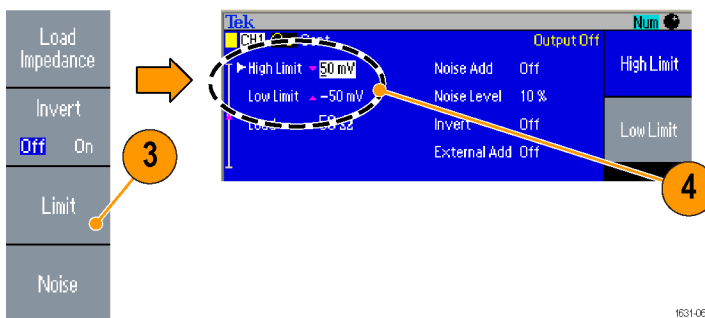

5. Push the front-panel Sine button to display the waveform parameter. Confirm that High and Low voltage levels were changed. You cannot enter any values greater than 50 mV for High level.

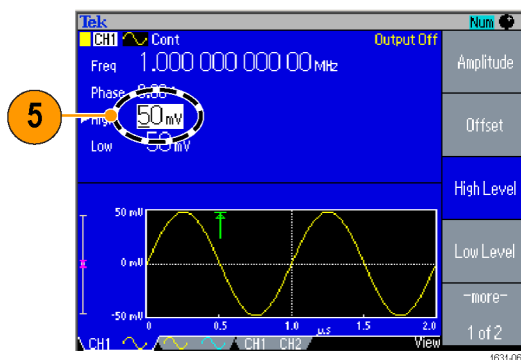

NOTE. When you set limit values using Output Menu, a level indicator is displayed at left end of graph area.

Update your instrument firmware

You can use the front-panel USB flash drive connector to update your instrument firmware.

CAUTION. *Updating your instrument firmware is a sensitive operation which may damage your instrument if you do not follow all instructions carefully. To prevent damage to the instrument, do not remove the USB flash drive or power off the instrument during the update process.*

NOTE. *The screen images of the following procedure are provided as an example. The actual screen display may be different depending on your instrument configuration.*

1. Push the front-panel Utility button to display the Utility menu.
Version information is displayed on the screen. Confirm the firmware version of your instrument.

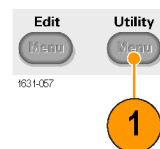

2. Visit www.tektronix.com, and check if Tektronix offers a newer firmware version. Download the compressed zip file with the most current firmware to your PC.

Unzip the downloaded file and copy the file to the root directory of your USB flash drive device.



3. Insert the USB flash drive device into the front-panel USB connector and check that you have saved the file to the root directory of the USB flash drive device.

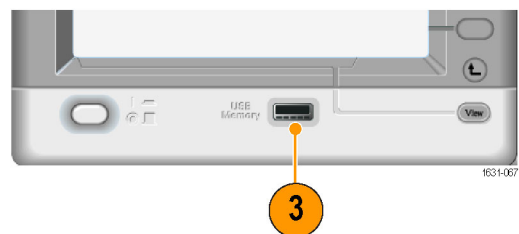

4. Push the -more- bezel button twice in the Utility menu.
5. The third page of the Utility menu is displayed. Select Firmware Update.

NOTE. If the USB flash drive is not inserted, the Firmware Update bezel button is disabled.

NOTE. If Access Protection is on, the Firmware Update bezel button is disabled. You can read more about access protection. (See page 81.)

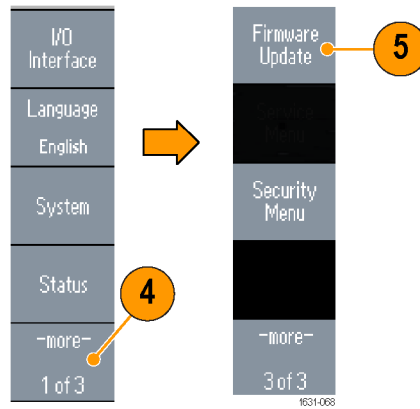

6. Select the downloaded firmware file by rotating the general purpose knob, and then push the Execute bezel button.

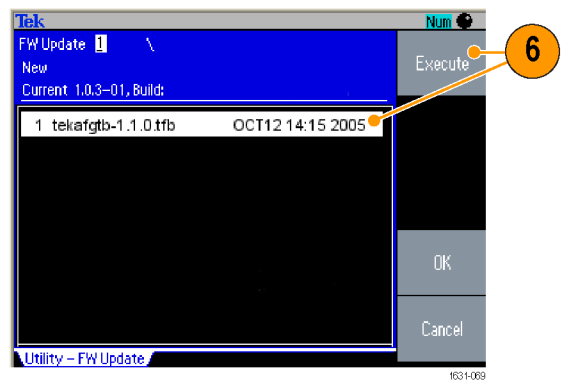

7. Follow the on-screen instructions.
8. Check that the clock symbol at the top right of the screen indicates the update process is in progress.

CAUTION. A firmware update usually takes approximately two minutes. Do not remove the USB flash drive during the update process.

CAUTION. If you accidentally removed the USB flash drive during the update process, do not power off the instrument. Repeat the installation process from step 3.

9. Wait until the instrument displays "Operation completed".
10. Push OK.

CAUTION. If "Operation completed" is not displayed, do not power off the instrument. Repeat the installation process from step 2 using a different type of USB flash drive device.

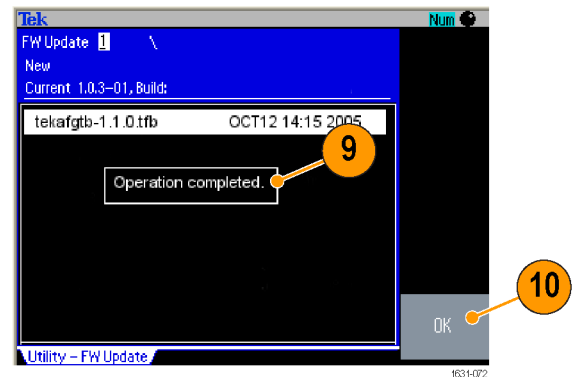

11. Remove the USB flash drive from the front-panel USB connector.
12. Power the instrument off and then back on.

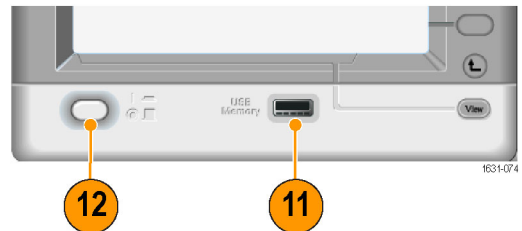

13. Push the front-panel Utility button to display the Utility menu.
Confirm that the firmware has been updated.

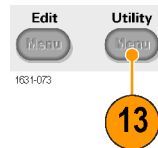

NOTE. You can protect access to firmware update using the Security menu.

Connect to a network

The AFG3000 series arbitrary function generator communication interface allows you to communicate with or remotely control your instrument. You can use a USB, Ethernet, or GPIB interface.

USB Interface

The USB interface requires no front panel or bezel menu operations to set up. Use a USB cable to connect your instrument to a PC.

Ethernet Setup

To connect your instrument to a network, you must first obtain information from your network administrator. The procedure for entering the Ethernet network parameters depends on your network configuration. If your network supports DHCP (Dynamic Host Configuration Protocol), follow these steps:

1. Connect a LAN cable to the LAN port on the rear panel.

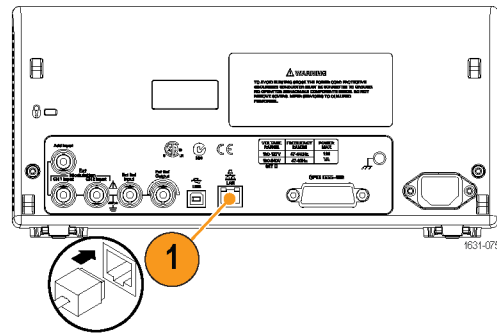

2. Push the front-panel Utility button.

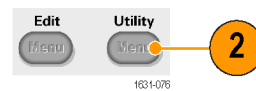

3. Push the I/O Interface > Ethernet bezel buttons.

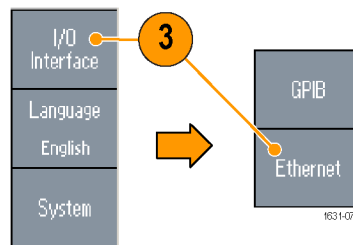

4. The Ethernet Network Settings menu is displayed. By selecting the DHCP On, the instrument can set its network address automatically through DHCP.

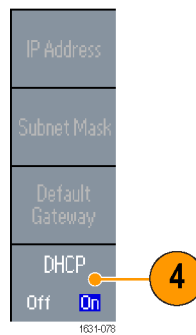

If you cannot establish communication by setting DHCP On, you need to set up an IP Address manually and a Subnet Mask if necessary. Follow these steps:

5. Display the Ethernet Network Settings menu and select DHCP Off.
6. Push the IP Address bezel button to enter an IP address. You need to contact your network administrator to get the IP address to use.
7. Push the Subnet Mask bezel button to enter a Subnet Mask. Ask your network administrator whether a subnet mask is required.
8. Push the Default Gateway bezel button to enter a gateway address. Ask your network administrator for the gateway address.

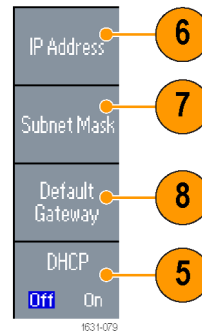

GPIB Setup

To set the instrument GPIB interface, follow these steps:

1. Connect a GPIB cable to the rear panel GPIB port.

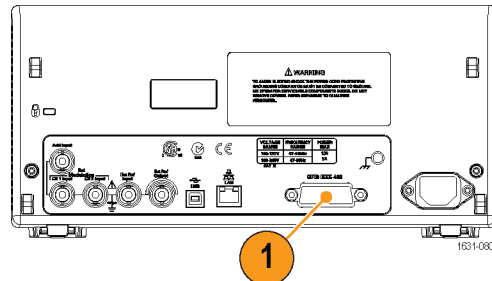

2. Push the front-panel Utility button.

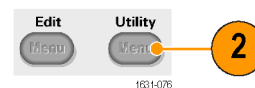

3. Push the I/O Interface > GPIB bezel buttons.

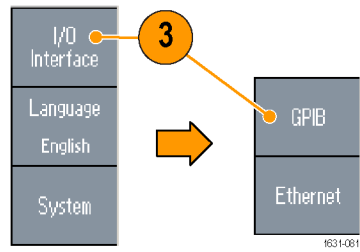

4. Push the Address bezel button to assign a unique address to the instrument.

The GPIB address defines a unique address for the instrument. Each device connected to the GPIB bus must have a unique GPIB address. The GPIB address must be from 0 to 30.

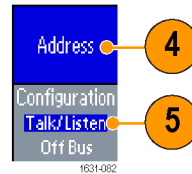

5. Push the Configuration bezel button to toggle the instrument bus communications on and off.

- Talk/Listen - Select this mode to remotely control the instrument from an external host computer.
- Off Bus - Select this mode to disconnect the instrument from the GPIB bus.

Quick Tip

- Refer to the AFG3000 Series Arbitrary Function Generators Programmer Manual for information on remote control commands.

Equivalent output circuits

The following illustrations show the equivalent output circuits for the AFG3000 series instruments:

1. AFG3011 / 3011C

- Output signals do not exceed ± 20 V when the $>50 \Omega$ load impedance is used.

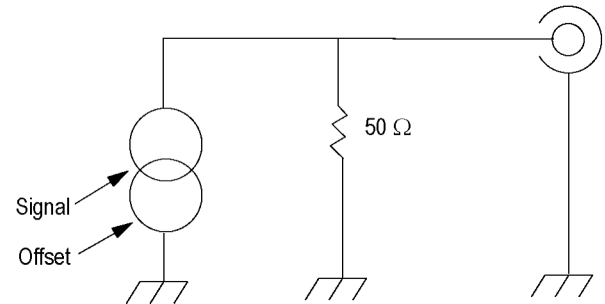

2. AFG3021B / 3021C / AFG3022B / 3022C / 3051C / 3052C

- Amplitude and offset of the output signals are not affected by load impedance.

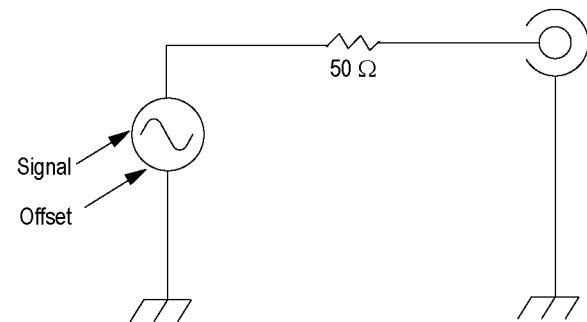

3. AFG3101 / 3101C / 3102 / 3102C

- Output signals do not exceed ± 10 V when the $>50 \Omega$ load impedance is used.
- Voltage over the maximum level is clipped.
- Amplitude and offset are affected when you change the load impedance. The maximum and minimum levels do not exceed ± 10 V, respectively.

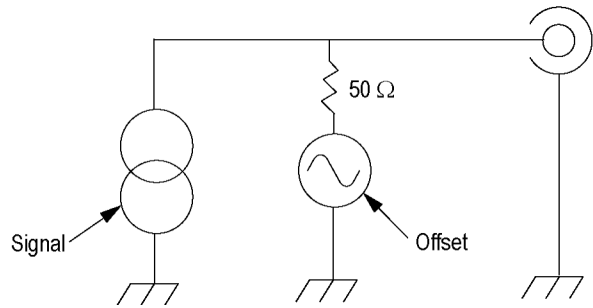

4. AFG3251 / 3251C / 3252 / 3252C

- Output signals do not exceed ± 10 V when the $>50 \Omega$ load impedance is used.

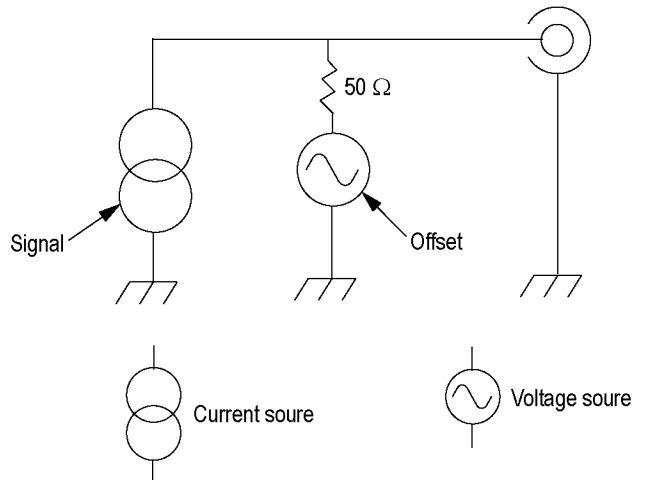

The following table shows the output window (maximum and minimum levels) for sine waveform when you change the load impedance (L). Load impedance will affect the output window.

	L = 50 Ω	L = High Z
AFG3011 / 3011C		
Maximum level	10 V -10 V (20 Vp-p)	20 V -20 V (40 Vp-p)
Minimum level (Maximum amplitude)		
AFG3021B / 3021C / 3022B / 3022C / 3051C / 3052C		
Maximum level	5 V -5 V (10 Vp-p)	10 V -10 V (20 Vp-p)
Minimum level (Maximum amplitude)		
AFG3101 / 3101C / 3102 / 3102C		
Maximum level	10 V -10 V (10 Vp-p)	10 V -10 V (20 Vp-p)
Minimum level (Maximum amplitude)		
AFG3251 / 3251C / 3252 / 3252C		
Maximum level	5 V -5 V (5 Vp-p)	10 V -10 V (10 Vp-p)
Minimum level (Maximum amplitude)		

Overheat Protection (AFG3011 / 3011C Only)

The instrument internal temperature is monitored in the AFG3011 and AFG3011C. A warning message will appear if the internal temperature reaches a threshold level, and signal output will automatically turn off. If the warning message appears, check for the following conditions:

- The ambient temperature requirement is being met.
- The required cooling clearance is being met.
- The instrument fan is working properly.

Instrument interface, front panel, and rear panel

Front panel overview

The front panel is divided into easy-to-use functional areas. This section provides you with a quick overview of the front panel controls and the screen interface. The following figure shows the front panel of the dual-channel model.

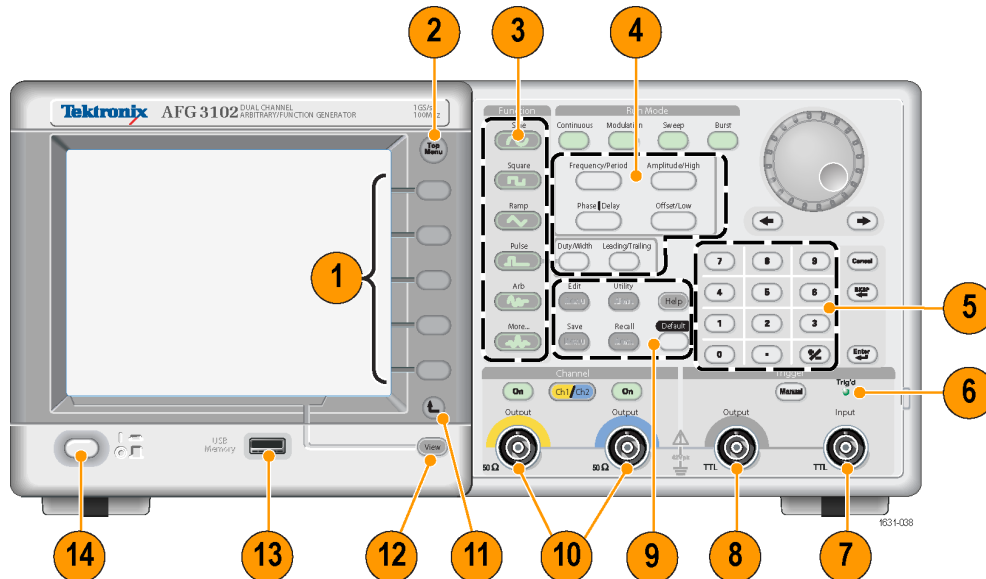

1. Bezel menu buttons
2. Top menu button
3. Function buttons
4. Shortcut buttons
5. Numeric keypad
6. Triggered LED is lit when the instrument receives an internal or external trigger
7. Trigger input connector
8. Trigger output connector
9. Menu buttons
10. CH 1 and CH 2 output connectors
11. Return to previous menu button
12. View button
13. USB connector
14. Power on/off switch

Lock or unlock the front panel controls

If you need to lock the front panel controls, use the following remote command:

- `SYSTem:KLOCK[:STATe]`

To unlock the front panel without using a remote command, push the front-panel Cancel button twice.

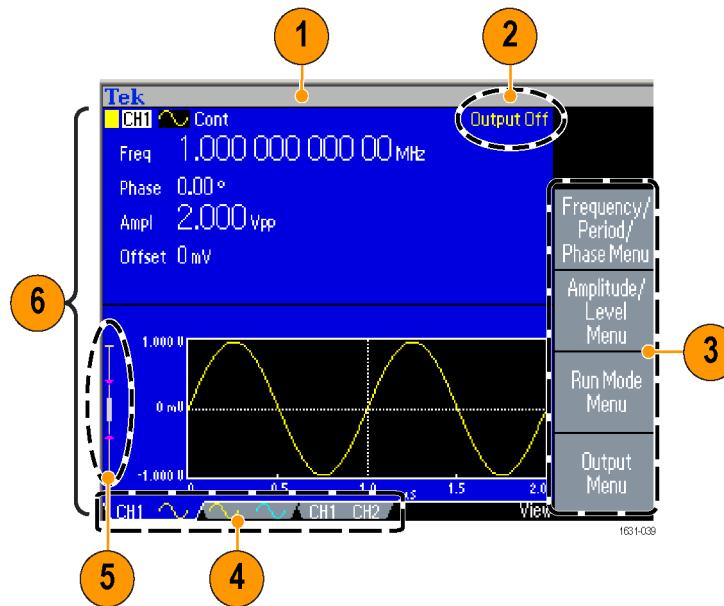
Parts of the screen interface

1. Message display area. A message that monitors hardware status such as clock or trigger is displayed in this area.

2. Output status. If the output is set to disable, Output Off message is displayed in this area. When you push the front panel channel output button to enable the output, the message will disappear.

3. Bezel menu. When you push a front panel button, the instrument displays the corresponding menu on the right side of the screen. The menu shows the options that are available when you push the unlabeled bezel buttons directly to the right of the screen. (Some documentation may also refer to the bezel buttons as option buttons, side-menu buttons, or soft keys.)

4. Channel tabs. Alternate between channels being used.

5. Level meter. Amplitude level is displayed. The following figure describes the level meter.

6. Main display area and View tab. Pushing the front-panel View button toggles through the view format of the main display area. The view tabs correspond with the current view format. The instrument can display three different screen formats.

1. Shows maximum amplitude level of your instrument.
2. Shows the range of high limit and low limit set by the user.
3. Shows the amplitude level that is currently selected.

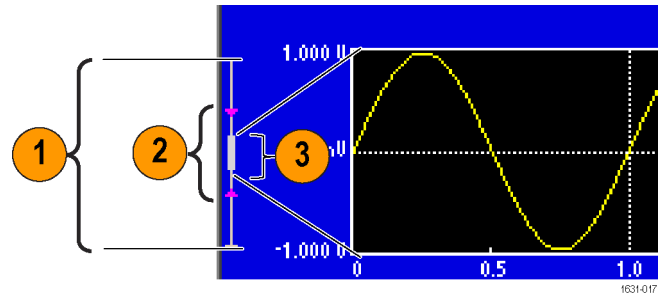

View button

The instrument provides the following three screen view formats:

- Waveform parameter and graph display
- Graph comparison
- Waveform parameter comparison

1. To change the screen display format, push the front-panel View button.

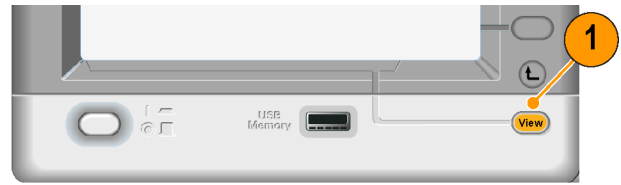

2. The first format provides the single channel waveform parameters and graph display. (Dual-channel model only): You can toggle the CH1 and CH2 information by pushing the channel select button.

When you push the View button once, the view format is changed to the graph comparison format.

Push the View button again to display the third format. This view provides the channel parameter comparison.

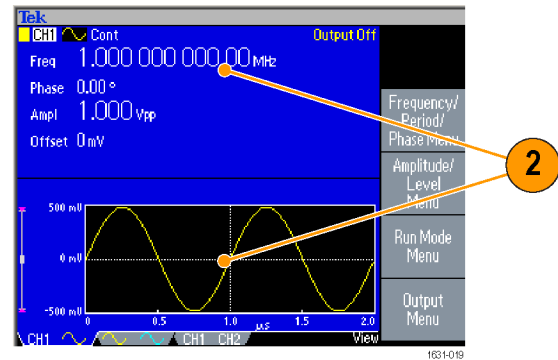

Quick Tips

- If the instrument is currently in the Save, Recall, Utility, Help, or Output menu, pushing the View button will have no effect.
- When the instrument is in the Edit menu, pushing the View button will toggle between Edit text and graphical views. This is the only function of the single-channel model view button.

Shortcut buttons

Shortcut buttons are provided for experienced users. The shortcut buttons allow you to select a setup parameter and enter a numeric value using the front panel controls. By using the shortcut buttons, you can select a waveform parameter without using any bezel menu selection.

1. Shortcut buttons are located below the Run Mode buttons on the front panel.
In this example, use pulse waveform.

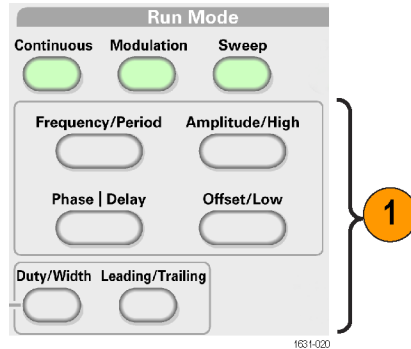

2. If you push the Amplitude/High shortcut button once, Amplitude becomes active.

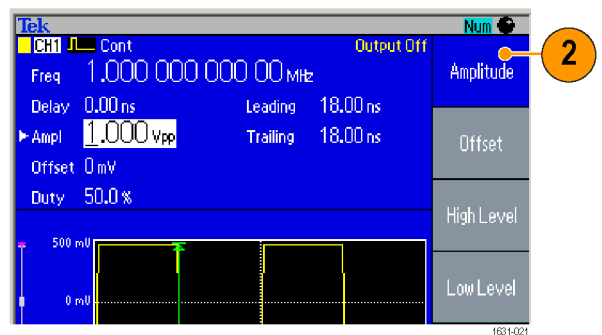

3. If you push the Amplitude/High shortcut button again, High Level becomes active.
You can also set parameters for Frequency/Period, Offset/Low, Duty/Width, or Leading/Trailing in the same way.

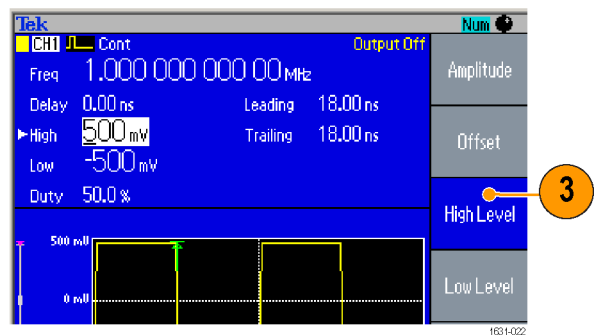

Quick Tips

- If you push the Phase | Delay shortcut button, Delay becomes active. Pushing Phase | Delay again will have no effect, because there is no phase parameter in the pulse parameter menu.
- The Duty/Width and Leading/Trailing shortcut buttons are functional only when the instrument is in the pulse parameter menu.

Default Setup

When you want to restore the instrument settings to the default values, use the front-panel Default button.

1. Push the front-panel Default button.



2. A confirmation pop-up message appears on the screen.
Push OK to recall the default settings.
Push Cancel to cancel the recall.

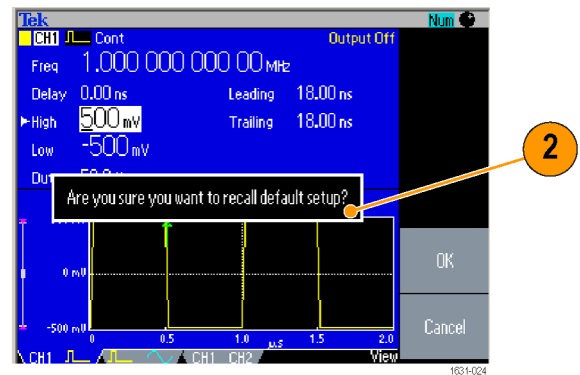

3. If you select OK, the instrument displays a 1 MHz frequency, 1 Vp-p amplitude sine waveform as the default setup.

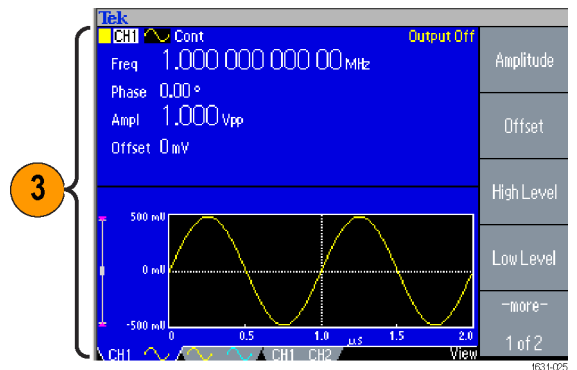

Quick Tips

- The AFG3000 Series Arbitrary Function Generators Programmer Manual describes the default setup settings in detail. This manual is available at www.tek.com/downloads.
- The front-panel Default button does not reset the following settings:
 - Language option
 - Power-on settings
 - System related settings (display contrast, screen saver, click tone, and beeper)
 - Saved setups and arbitrary waveform data
 - Calibration data
 - GPIB and Ethernet setups
 - Access protection

Select Waveform

The instrument can provide 12 standard waveforms (Sine, Square, Ramp, Pulse, Sin(x)/x, Noise, DC, Gaussian, Lorentz, Exponential Rise, Exponential Decay, and Haversine). The instrument can also provide user-defined arbitrary waveforms. You can create, edit, and save your custom waveforms.

You can also create modulated waveforms using the Run Mode Modulation menus. The following table shows the combination of modulation type and the shape of the output waveform.

The following matrix shows which waveforms are allowed with each run mode.

Run Mode	Sine, Square, Ramp, Arb, Sin(x)/x, Gaussian, Lorentz, Exponential Rise, Exponential Decay, Haversine	Pulse	Noise, DC
Continuous	√	√	√
Modulation			
AM	√		
FM	√		
PM	√		
FSK	√		
PWM		√	
Sweep	√		
Burst	√	√	

NOTE. When the instrument outputs an Arb waveform, V_{p-p} of instrument setup indicates the V_{p-p} value of normalized waveform data.

When the instrument outputs Sin(x)/x, Gaussian, Lorentz, Exponential Rise, Exponential Decay, or Haversine, V_{p-p} is defined as twice the value of 0 to peak value.

To select an output waveform, follow these steps:

1. To select a continuous sine waveform, push the front-panel Sine button and then push the Continuous button.
2. You can directly select one of four standard waveforms from the front-panel Function buttons.
3. To select an arbitrary waveform, push the Arb button.
4. To select other standard waveforms such as Sin(x)/x, Noise, DC, or Gaussian, push the More... button, and then push the top bezel button.

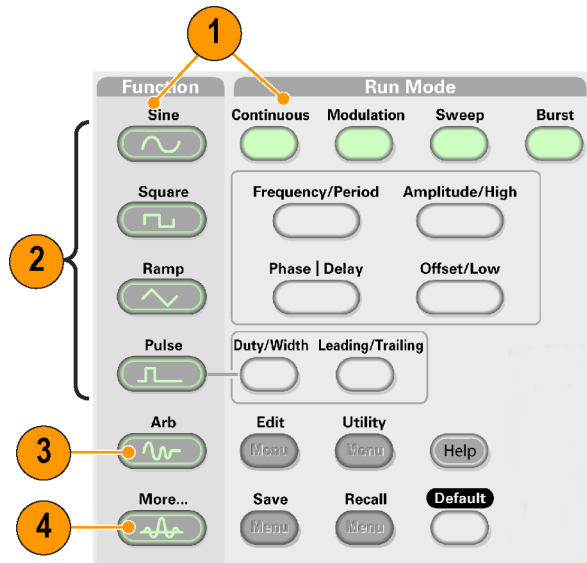

5. These are waveform examples of Sin(x)/x and Noise.

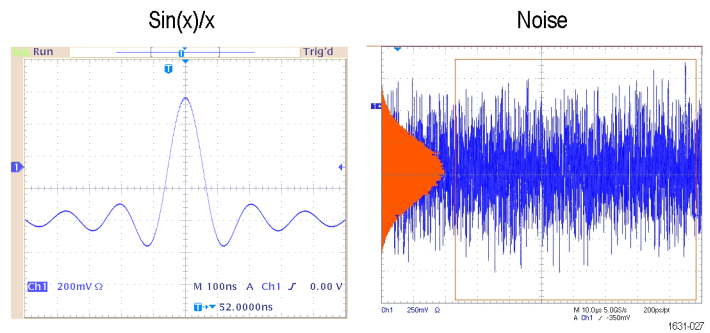

6. These are waveform examples of DC and Gaussian.

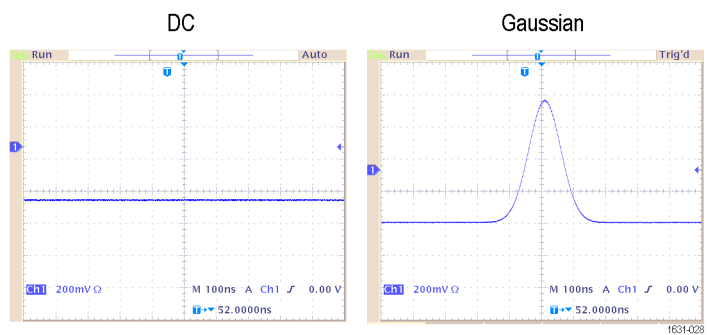

7. These are waveform examples of Lorentz and Haversine.

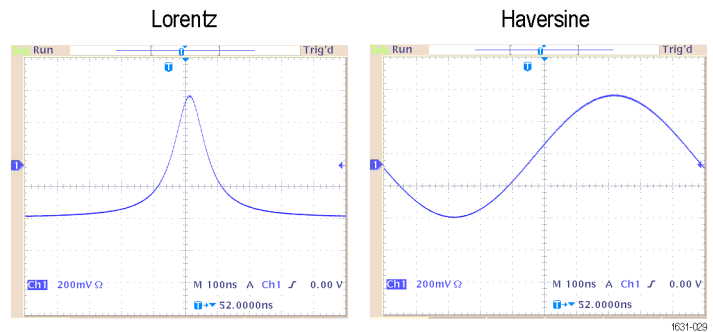

8. These are waveform examples of Exponential Rise and Exponential Decay.

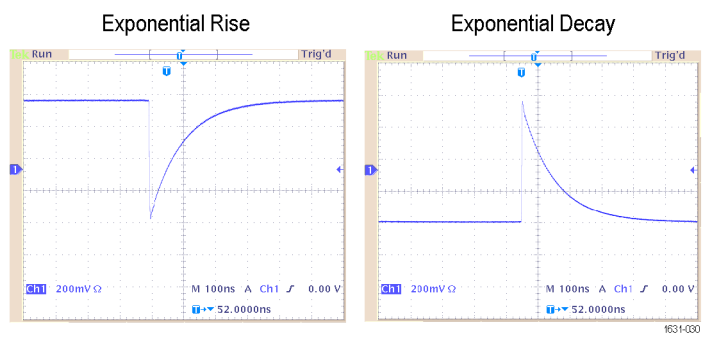

Select Run Mode

Push one of the four Run Mode buttons to select the instrument signal output method.

1. The default Run Mode is Continuous.

You can read more about changing waveform parameters. (See page 35.)

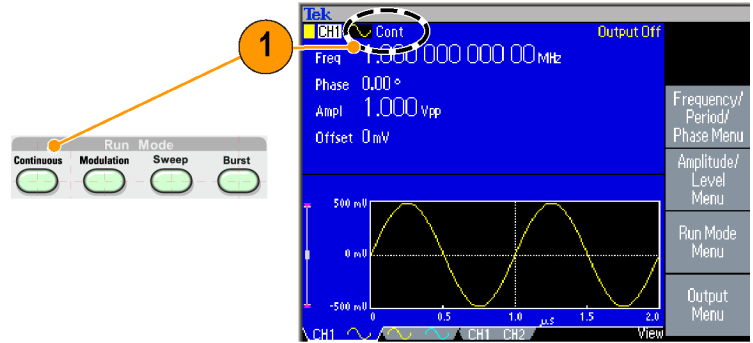

2. To select a modulated waveform, push the Modulation button.

You can read more about modulating waveforms. (See page 58, *Modulate a Waveform.*)

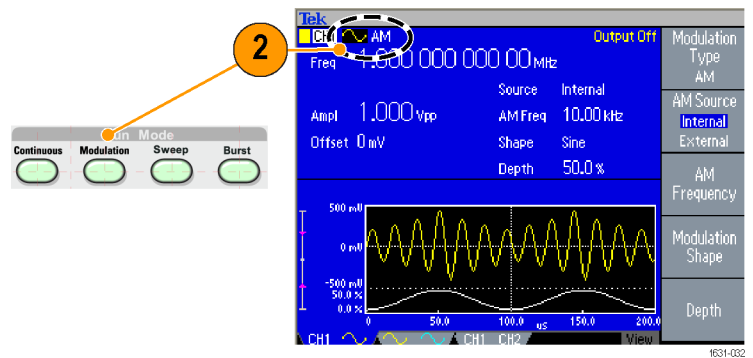

- To select a sweep waveform, push the Sweep button.

You can read more about sweeping waveforms. (See page 55.)

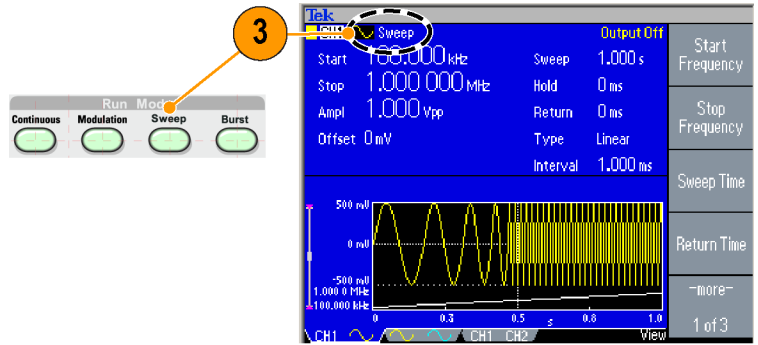

- To select a burst waveform, push the Burst button.

You can read more about Burst mode. (See page 54.)

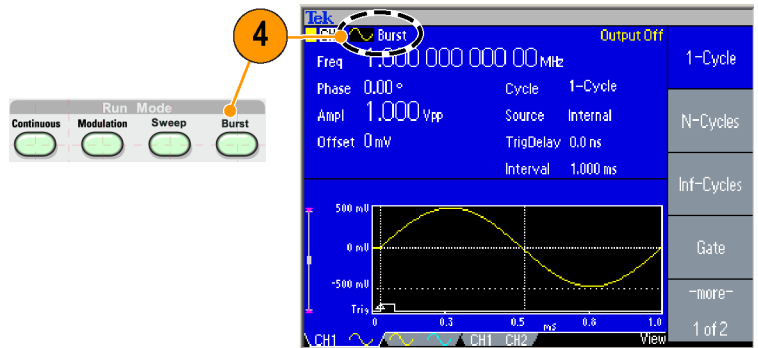

Adjust Waveform Parameters

When you turn on your instrument, the default output signal is a 1 MHz sine waveform with an amplitude of 1 Vp-p. In the following example, you can change the frequency and amplitude of the original output signal.

- Push the front-panel Default button to display the default output signal.



- To change frequency, push the front-panel Frequency/Period shortcut button.

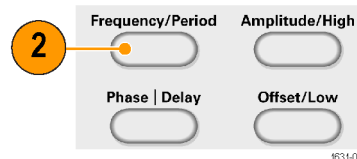

3. Frequency is now active. You can change the value using the keypad and Units bezel menu, or you can change the value with the general purpose knob.
4. Push the Frequency/Period shortcut button again to toggle the parameter to Period.

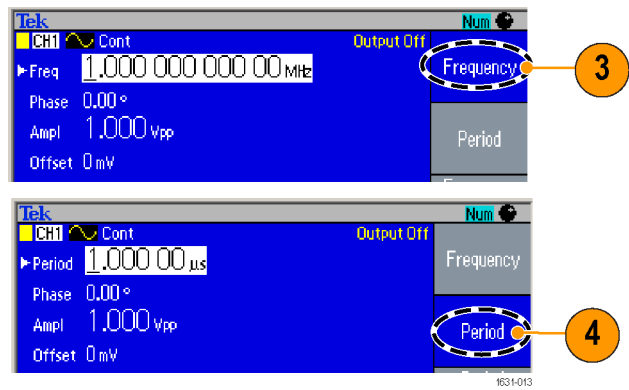

5. Next, change amplitude. Push the Amplitude/High shortcut button.

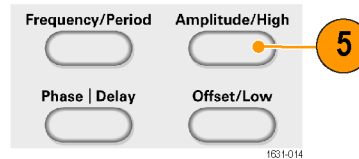

6. Amplitude is now active. You can change the value using the keypad and Units bezel menu, or you can change the value using the general purpose knob.
7. Push the Amplitude/High shortcut button again to toggle the parameter to High Level. You can change the values of Phase and Offset in the same way.

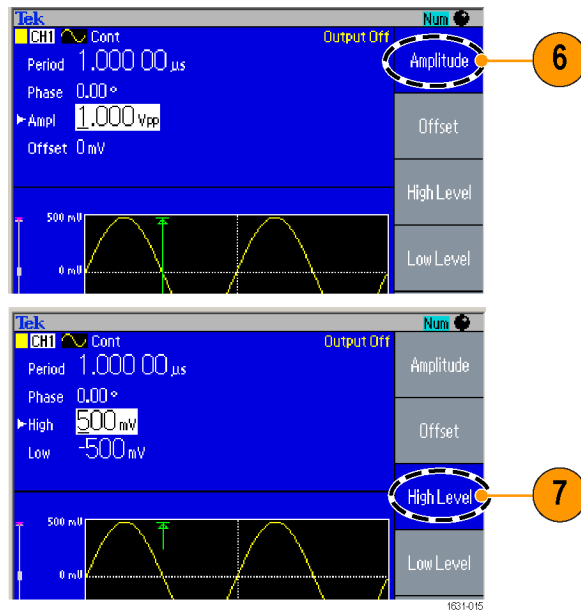

8. To change the amplitude units, push the -more- bezel button to display the second page.
9. Push the Units bezel button to display units selection bezel menu. By default, Vp-p is selected.

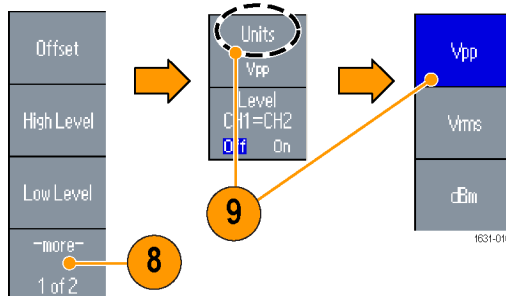

Quick Tip The following conversion table shows the relationship between Vp-p, Vrms, and dBm.

V _{p-p}	V _{rms}	dBm
20.00 Vp-p	7.07 Vrms	+30.00 dBm
10.00 Vp-p	3.54 Vrms	+23.98 dBm
2.828 Vp-p	1.00 Vrms	+13.01 dBm
2.000 Vp-p	707 mVrms	+10.00 dBm
1.414 Vp-p	500 mVrms	+6.99 dBm
632 mVp-p	224 mVrms	0.00 dBm
283 mVp-p	100 mVrms	-6.99 dBm
200 mVp-p	70.7 mVrms	-10.00 dBm
10.0 mVp-p	3.54 mVrms	-36.02 dBm

Channel Select (dual-channel model only)

1. Push the front-panel Channel Select button to control the screen display. You can toggle between the two channels.

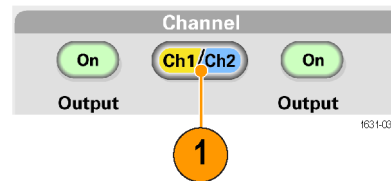

NOTE. If you push the Channel Select button while you are in the Utility, Save, Recall, or Help menu, the screen display returns to the previous view. The channels do not toggle.

Output ON/OFF

1. To enable signal output, push the front-panel Channel Output On button. The button is lit with an LED when it is in the On state.

You can configure the signal with the outputs off. This will allow you to minimize the chance of sending a problematic signal to a DUT.

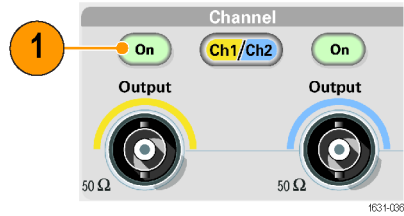

2. (Dual-channel model only) You can turn on or off the signal output for channel 1 and channel 2 independently.

You can enable one of the two channels or enable both of the two channels at any time.

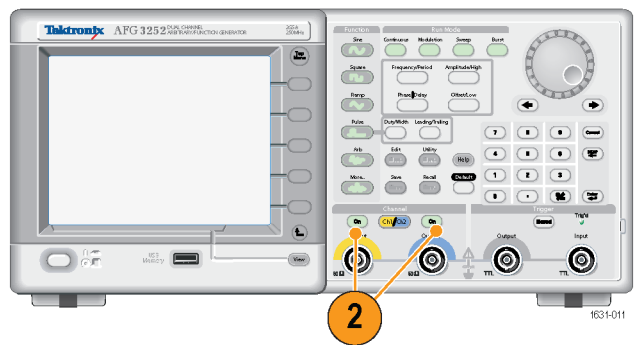

Rear Panel

The following illustration shows the rear panel connectors for the instrument.

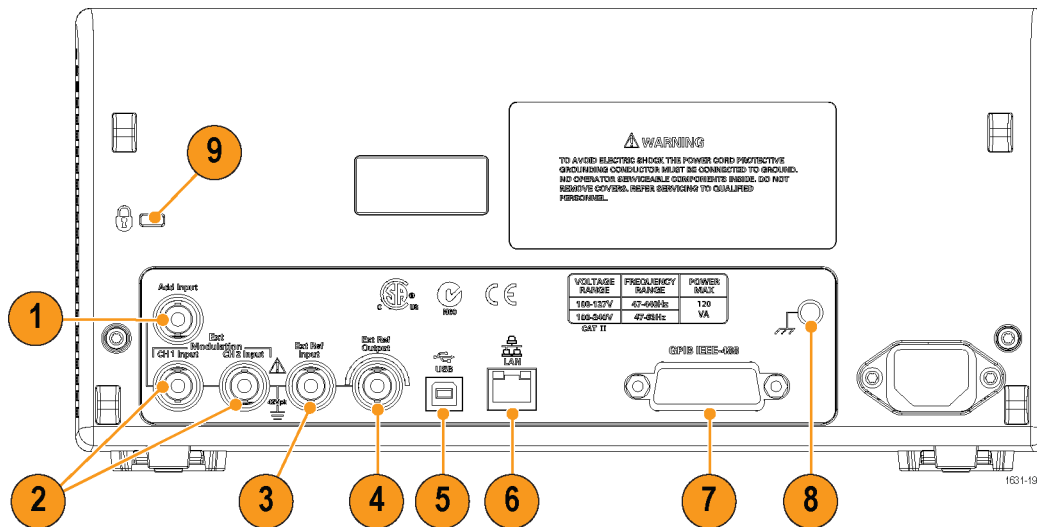

1. **ADD INPUT:** The ADD INPUT connector is provided with AFG3101 / 3101C / 3102 / 3102C / 3251 / 3252 / 3252C. This connector lets you add an external signal to the CH1 output signal.
2. **EXT MODULATION INPUT (CH1 and CH2):** The CH1 INPUT and CH2 INPUT are independent. The signal input level of these connectors controls modulation parameters.
3. **EXT REF INPUT:** This is a BNC connector for the external reference input. When you want to synchronize multiple AFG3000 series arbitrary function generators, or synchronize your arbitrary function generator and another instrument, use the external reference input connector.
4. **EXT REF OUTPUT:** This is a BNC connector for the external reference output. When you want to synchronize multiple AFG3000 series arbitrary function generators, or synchronize your arbitrary function generator and another instrument, use the external reference output connector.
5. **USB:** Used to connect a USB controller. (Type B)
6. **LAN:** Used to connect the instrument to a network. Connect a 10BASE-T or 100BASE-T cable here.
7. **GPIB:** Used to control the instrument through GPIB commands.
8. **Chassis Ground Screw:** The chassis ground screw is used to ground the instrument. Use a unified coarse screw (#6-32, 6.35 mm length or less).
9. **Security Slot:** Use a standard laptop computer security cable to secure your instrument to your location.

Operating basics

Quick tutorial: How to select a waveform and adjust parameters

If you are a beginning user, you can follow the steps described here to get acquainted with how to select a waveform and adjust waveform parameters.

1. Press the power button to turn on the instrument.
2. Connect the CH1 Output of the instrument to the oscilloscope input with a BNC cable.
3. Select a waveform.
4. Enable the signal output.
5. Observe a waveform displayed on the oscilloscope screen.
6. Use the front-panel shortcut buttons on the instrument to select a waveform parameter.
7. Select Frequency as a parameter to be changed.
8. Change the frequency value using the numeric keys.
9. Change the waveform parameters using the general purpose knob and the arrow keys.

Quick tutorial: How to generate a sine waveform

If you are a beginning user, you can follow the steps described here to learn how to generate a continuous sine waveform.

1. Connect the power cord, and then push the front-panel power on/off switch to turn on the instrument.
2. Connect a BNC cable from the CH1 Output of arbitrary function generator to an oscilloscope input connector.
3. Push the front-panel Sine button, and then push the Continuous button to select a waveform.

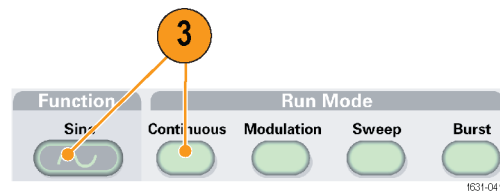
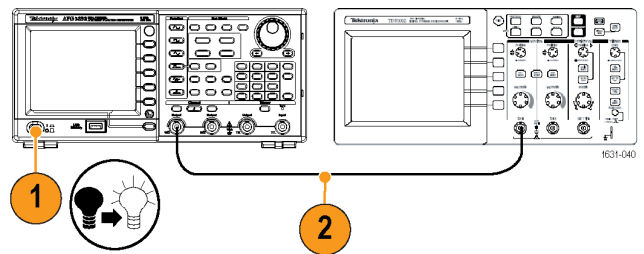

4. Push the front-panel CH1 Output On button to enable the output.

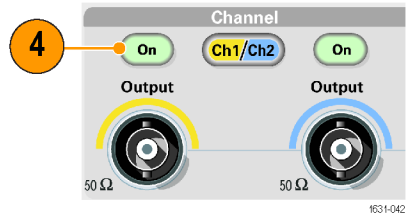

5. Use the oscilloscope auto-scaling function to display the sine waveform on the screen.

If the instrument outputs a default sine waveform, you can manually set the oscilloscope as follows:

- 0.5 μ s/div
- 200 mV/div

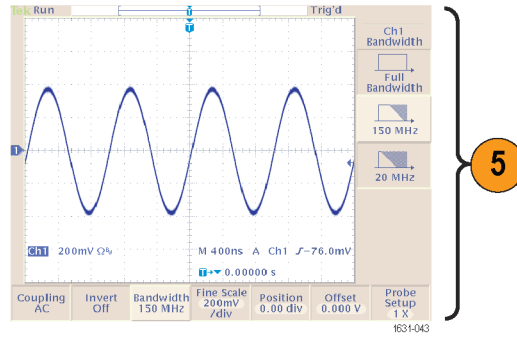

6. To change the frequency, push the front-panel Frequency/Period shortcut button.

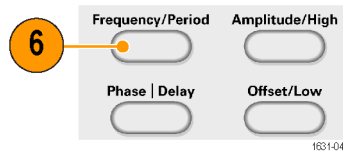

7. The Frequency/Period/Phase Menu is displayed and Freq is selected. You can now change the frequency value.

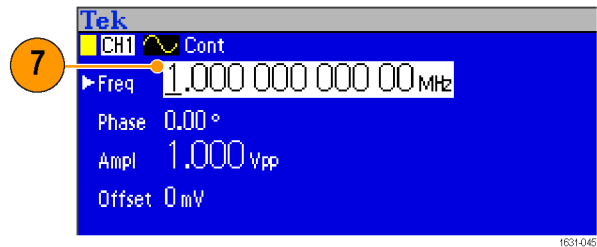

8. To change the frequency value, use the keypad and Units bezel buttons.

For example, if you enter a value "2" using the keypad, the bezel menus will automatically change to Units.

After entering the frequency value, push the Units bezel button or the front-panel Enter button to complete the entry.

You can change the Amplitude, Phase, and Offset values in the same way.

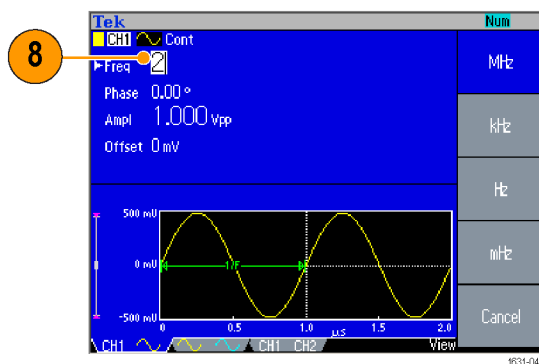

9. You can also change the frequency value using the general purpose knob and the arrow keys.

To increase the value, turn the knob clockwise.

To change a specific digit, select it by pushing the arrow keys. Then change it by turning the knob.

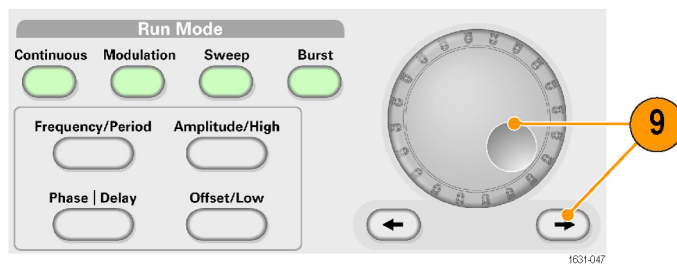

Quick Tips

- Use the front-panel shortcut buttons to quickly select a waveform parameter.
- You can also specify a waveform parameter by using bezel menu selection. This method does not use the front-panel shortcut buttons.
- When you specify a waveform parameter using the shortcut buttons or bezel menu selection, an active parameter is displayed in green in the graph area.

Quick tutorial: Instrument help system

The instrument help system allows you to access information about specific menu items and instrument functions when you need help. You can access and navigate this help system using front-panel buttons and knobs, and following on-screen instructions as they appear. The individual help topics may contain links to other topics, as well. These can be accessed by following the on-screen instructions.

How to access the instrument help system

You can follow the steps described here to access the instrument help system.

1. Push the front-panel Help button to display the help screen.
2. Turn the general purpose knob to move the highlight from one link to another.
3. Push the Show Topic bezel button to display the topic corresponding to the highlighted link.
4. Push the Index bezel button to display an Index page.
5. Push the Exit bezel button or any front-panel button to remove the Help text from the screen and return to the graphic or parameter display.

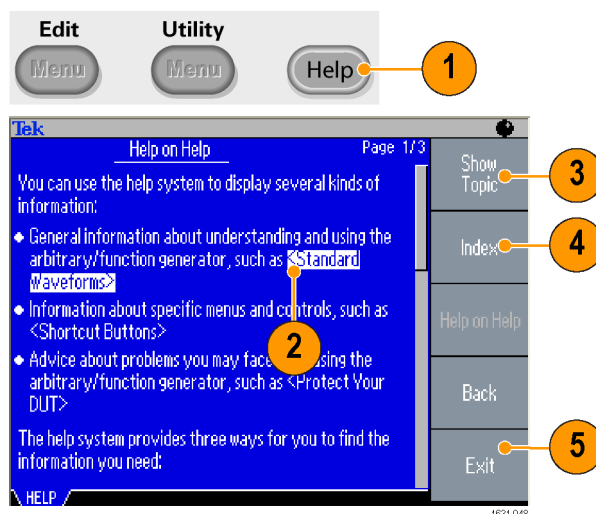

Ways to access and navigate the instrument help system

- Push the Help button to display information (topic) about the last menu displayed on the screen.
- Turn the general purpose knob to move from page to page within a displayed topic.
- Push the Index bezel button to view the Help index page.
- Push the Page Up or Page Down bezel buttons to search for the index page that contains the topic you want to view.
- Turn the general purpose knob to highlight a help topic in the index.
- Push the Show Topic bezel button to display the topic from the index page.
- Push the Utility button and then the Language bezel button to choose the language in which you want the Help topics, bezel menus, and on-screen messages to appear.

Generate a Pulse Waveform

1. Push the front-panel Pulse button to display the Pulse screen.
2. Push the Frequency/Period shortcut button to select Frequency or Period.

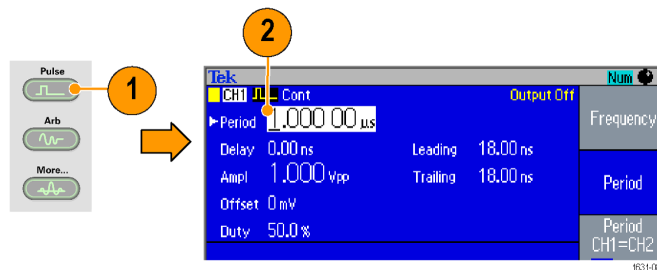

3. Push the Duty/Width shortcut button to toggle between Duty and Width.
4. Push the Leading/Trailing shortcut button to toggle the parameters for Leading Edge and Trailing Edge.

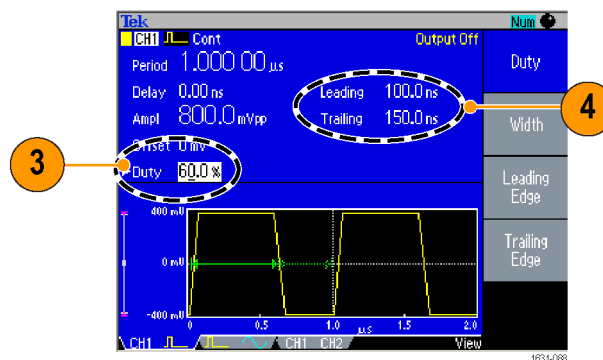

5. You can set the lead delay by pushing the Phase | Delay shortcut button to display the lead delay setting screen and adjusting the parameter as needed. You can also select Lead Delay from the bezel menu.

Pulse waveform formulas

The following formulas are applied to leading edge time, trailing edge time, pulse period, and pulse width of pulse waveforms.

t_{Edge} (Leading Edge Time)

t_{Edge} (Trailing Edge Time)

Maximum leading edge time. This value is the minimum of the three in each instance.

If runMode = Continuous:

$$\text{Temp1} = 0.8 * 2.0 * \text{width} - \text{tEdge};$$

$$\text{Temp2} = (\text{period} - \text{width}) * 0.8 * 2.0 - \text{tEdge};$$

$$\text{Temp3} = 0.625 * \text{period}.$$

Else:

$$\text{Temp1} = 0.8 * 2.0 * \text{width} - \text{tEdge};$$

$$\text{Temp2} = (\text{period} - \text{leadDelay} - \text{width}) * 0.8 * 2.0 - \text{tEdge};$$

$$\text{Temp3} = 0.625 * \text{period}.$$

Maximum trailing edge time. This value is the minimum of the three in each instance.

If runMode = Continuous:

$$\text{Temp1} = 0.8 * 2.0 * \text{width} - \text{lEdge};$$

$$\text{Temp2} = (\text{period} - \text{width}) * 0.8 * 2.0 - \text{lEdge};$$

$$\text{Temp3} = 0.625 * \text{period}.$$

Else:

$$\text{Temp1} = 0.8 * 2.0 * \text{width} - \text{lEdge};$$

$$\text{Temp2} = (\text{period} - \text{leadDelay} - \text{width}) * 0.8 * 2.0 - \text{lEdge};$$

$$\text{Temp3} = 0.625 * \text{period}.$$

Save/Recall arbitrary waveforms

You can save up to four arbitrary waveforms in the instrument internal memory. To save more waveforms, use a USB flash drive

1. To recall or save an arbitrary waveform, push the front-panel Edit button to display the Edit menu.

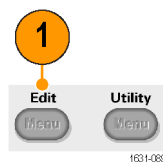

2. Select Read from... to recall an arbitrary waveform.
3. The Read Waveform page is displayed.

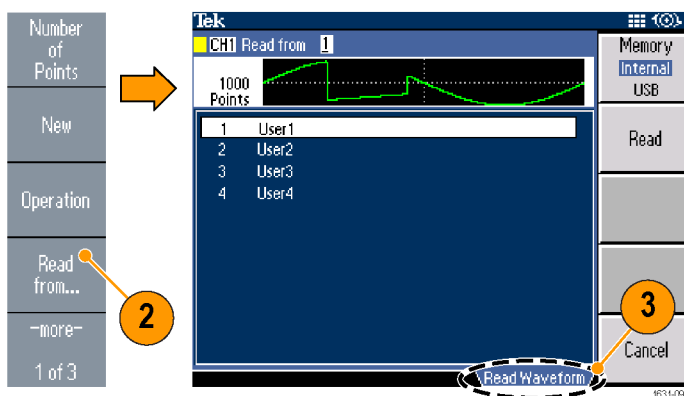

4. To save waveforms, select Write to... to display the Write Waveform page.
5. If you save a waveform to a USB flash drive a file with the extension TFW is saved.

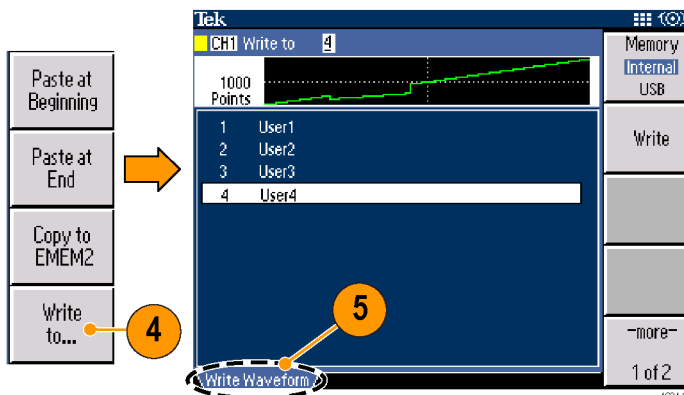

6. You can also recall waveforms by pushing the front-panel Arb > Arb Waveform Menu bezel buttons.

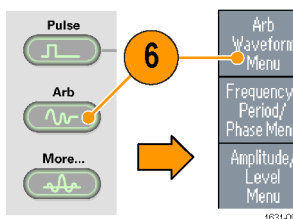

Quick Tips

- Push the -more- bezel button in the Write to... submenu to display the Lock/Unlock and the Erase menu.
- The Lock/Unlock function allows you to lock the file against accidental overwrite.

Generate an Arbitrary Waveform

The instrument can output an arbitrary waveform that is stored in the internal memory or a USB flash drive

1. Push the front-panel Arb button.
2. Push the Arb Waveform Menu bezel button.

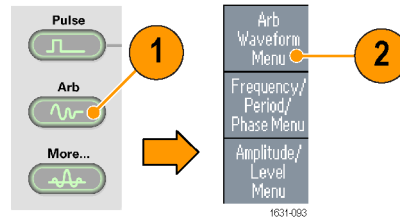

3. The Arb Waveform Menu is displayed. You can now browse a list of waveform files in the internal memory or USB flash drive

Select Internal. You can specify a file from the following:

- User 1, User 2, User 3, or User 4
- Edit Memory 1 or Edit Memory 2

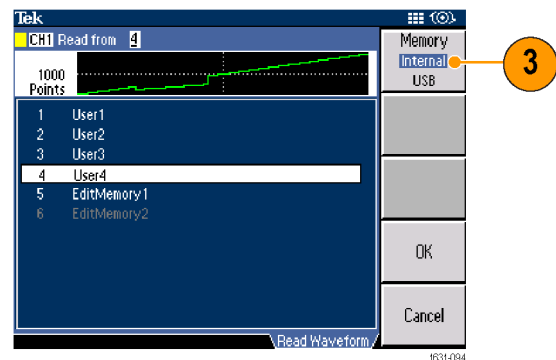

NOTE. *Edit Memory 2 is only available on dual-channel instruments. Edit Memory 1 relates to Channel 1 and Edit Memory 2 relates to Channel 2.*

Use the front panel general purpose knob to scroll the files, then select a file and push OK.

Quick Tips

- File names are displayed only in English characters. If you use non-English characters to name a file, these characters are replaced by Roman symbols such as #, \$, %.
- Use the Write to... bezel menu in the Edit menu to copy a waveform file on the USB flash drive to the internal memory.

Modify an Arbitrary Waveform (Edit Menu)

To modify an arbitrary waveform, use the Edit Menu. The Edit Menu supports several waveform edit functions and provides import or storage of edited waveform data. Dual-channel model instruments have two edit memories (Edit Memory 1 and Edit Memory 2). The Edit Menu also supports copying waveform data between these two memories.

1. Push the front-panel Edit button to display the Edit Menu.

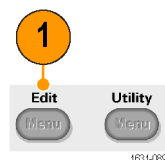

2. Select Number of Points to set the number of waveform points to be edited.
3. Select New to write a standard waveform to Edit memory. The written waveform has the number of points specified by Number of Points. One of five waveform types (Sine, Square, Ramp, Pulse, and Noise) can be selected.
4. Select Operation to display the Operations submenu.
5. Select Read from... to specify a memory location of waveform data from Internal or USB.

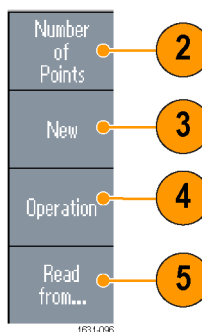

6. Push Operation to display the Operations submenu.
 - Push Line to display the Line edit submenu.
 - Push Data to display the Data Point edit submenu.
 - Push Cut to display the Cut Data Points submenu.

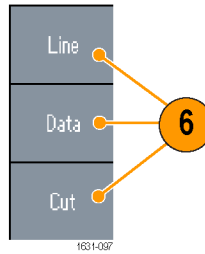

7. Select Paste at Beginning to append a waveform at the beginning of the edit waveform.
Select Paste at End to append a waveform at the end of the edit waveform.
8. Select Copy to EMEM1/EMEM2 to copy waveform data between Edit Memory 1 and Edit Memory 2. (This menu item is only available on dual-channel instruments.)
9. Select Write to... to display a submenu to write waveform data to.

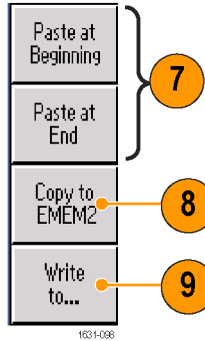

Arbitrary Waveform Edit Example 1

The following example shows how to use the Line edit function. Paste a ramp waveform before sine waveform:

1. Select Number of Points to set the number of waveform points to 1000 points.
2. Select New and then select Sine. Save this waveform to User1.

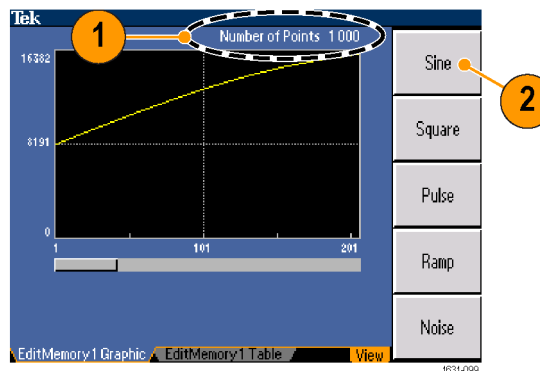

3. Next, create a 500 point ramp waveform.
4. Select Operation and select Line. Do the following line edit:

- X1: 1, Y1: 8191
- X2: 250, Y2: 16382

Push Execute. Once again, select Line from Operation and perform the following line edit:

- X1: 251, Y1: 16382
- X2: 500, Y2: 8191

5. Push Execute. Save this waveform to User2.

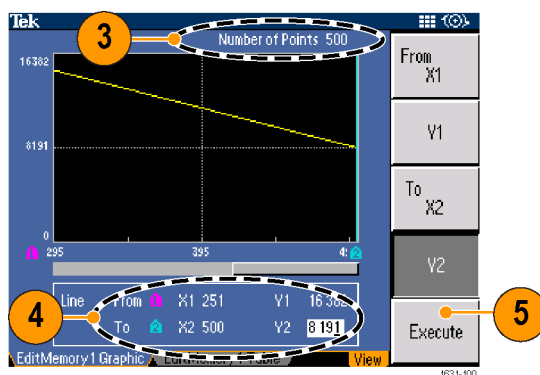

6. Next, paste a waveform. Push Read from... and select User1.
7. Push Paste at Beginning. Select User2 waveform and then select Paste.
8. The waveform shown here is created.

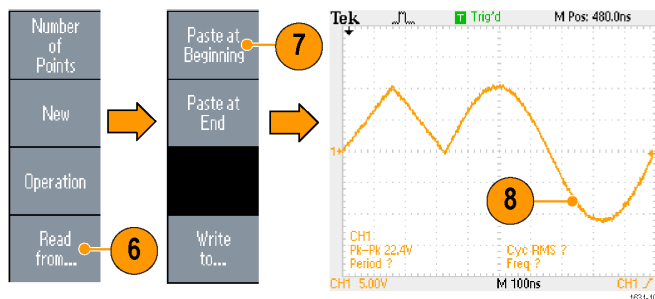

Arbitrary Waveform Edit Example 2

The following example shows how to edit a waveform by data point. In this example, you can add a noise spike to the sine waveform.

1. Push Read from... and select User1.
2. Push the front-panel View button to change the screen to Table display.

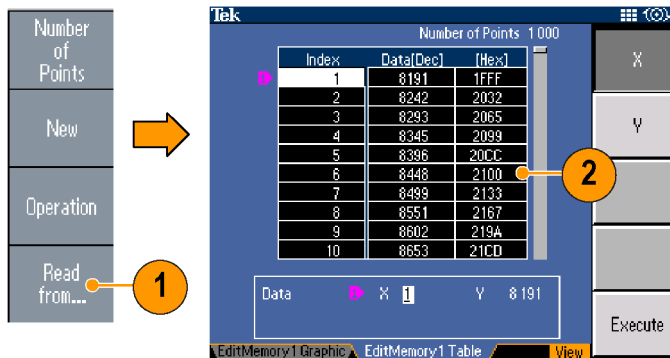

3. Push Operation and select Data.
4. Perform the following data point edit:
 - X: 250, Y: 8191
 - X: 251, Y: 8191
 - X: 750, Y: 8191
 - X: 751, Y: 8191

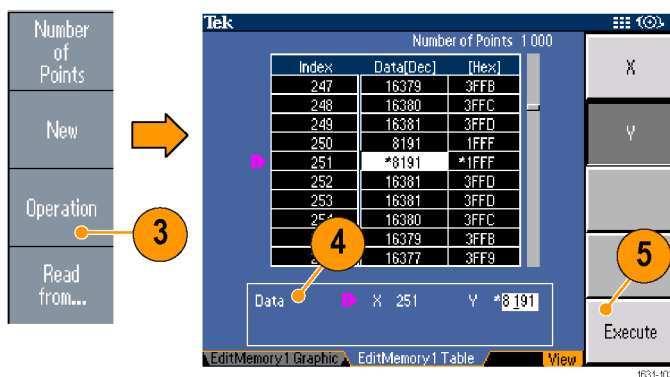

5. After each data edit, push Execute to implement the edit operation. Save this waveform to User3.

6. This is an example of an oscilloscope screen for the User3 waveform.

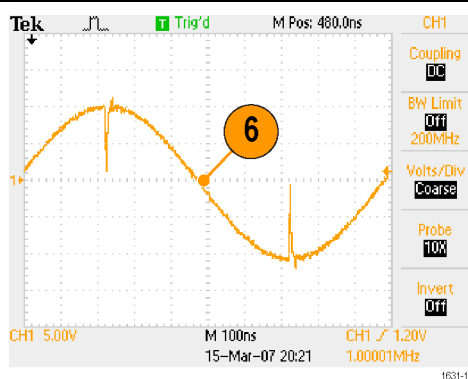

Quick Tips

- If you edit arbitrary waveform data in Edit Memory 1 or 2 while the instrument generates a waveform from edited Edit Memory, the edited data will be automatically reflected to the generated waveform from the corresponding channel.
- Push the front-panel View button in the Edit Menu to toggle between edit texts and graphical views.
- Push the front-panel Channel Select button to toggle between the Edit Memory 1 and Edit Memory 2 menus.

Generate Noise/DC

1. Push the front-panel More... button.
2. Push the More Waveform Menu bezel button.

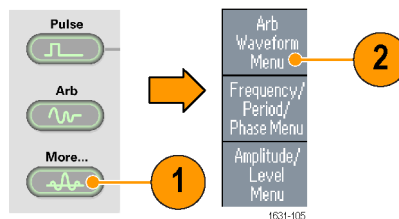

3. Select Noise.
4. You can set waveform parameters for Noise. This is a sample of Gaussian Noise displayed on an oscilloscope screen.

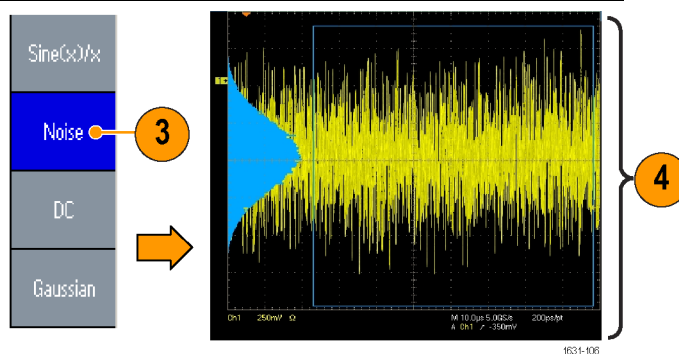

5. Push DC to display DC parameters.

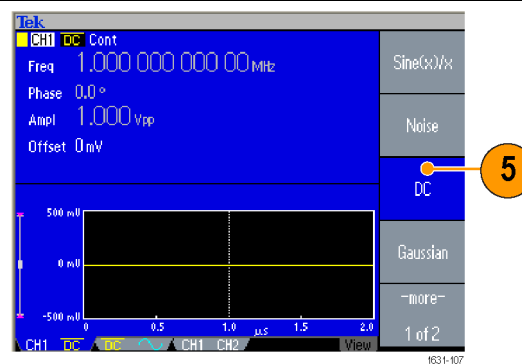

Quick Tip ■ You cannot modulate or sweep noise or a DC waveform.

Generate a Burst Waveform

The instrument can output a burst using standard waveforms such as sine, square, ramp, and pulse, or arbitrary waveforms. The instrument allows you to use the following two types of burst modes:

Triggered Burst Mode. A specified number (burst count) of waveform cycles are output when the instrument receives a trigger input from the internal trigger source, an external trigger source, a remote command, or the Manual Trigger button.

Gated Burst Mode. The instrument outputs a continuous waveform when an effective gate signal is applied externally, when the Manual Trigger button is depressed, when a remote command is applied, or during 50% of the selected internal trigger interval.

To Generate a Triggered Burst Waveform

The following example describes how to generate a double pulse using the burst mode.

1. Select Pulse as an output waveform and then push the front-panel Burst button.
2. Confirm that 1-Cycle, N-Cycles, or Inf-Cycles is selected, which means triggered burst mode is enabled.
To generate double pulse, set the burst count (N-Cycles) to 2.

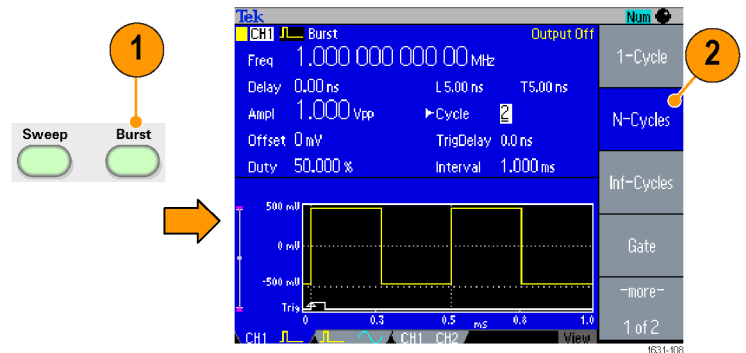

3. This is an example of double pulse.
4. This waveform is a trigger output signal.

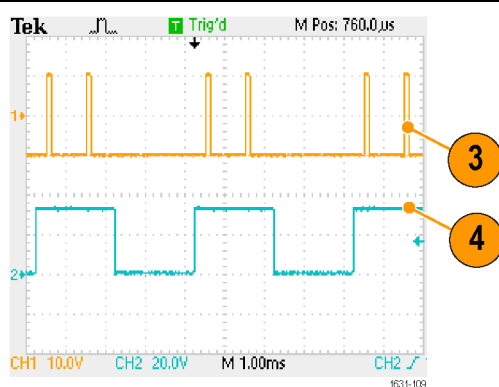

To Generate a Gated Burst Waveform

In the gated burst mode, the output is enabled or disabled based on the internal gate signal or an external signal applied to the front-panel Trigger Input connector. While the gate signal is true or the front-panel Manual Trigger button is pushed in, the instrument outputs a continuous waveform.

1. Push the front-panel Burst button to display the burst menu.
2. Select Gate.

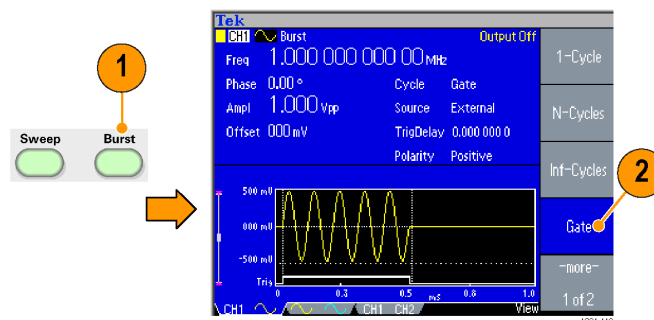

3. This is a sample oscilloscope screen. The top waveform is a trigger output signal.
4. This is a gated waveform sample.

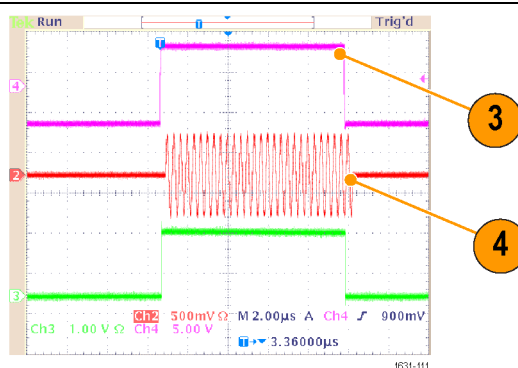

Quick Tips

- The instrument provides the following three trigger sources for Burst mode:
 - Internal or external trigger signal
 - Manual trigger
 - Remote command
- Once Gate is selected, burst count parameters are ignored.

Sweep a Waveform

The Sweep outputs a waveform with the output signal frequency varying linearly or logarithmically.

You can set the following parameters for Sweep:

- Start frequency
- Stop frequency
- Sweep time

- Return time
- Center frequency
- Frequency span
- Hold time

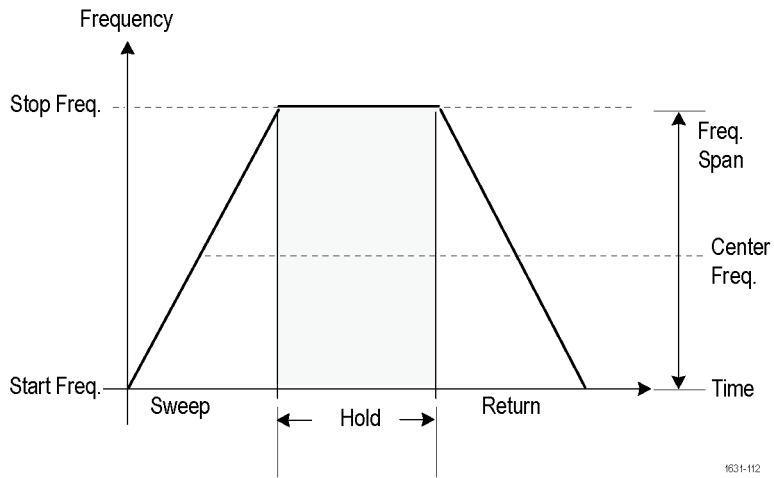

1. Select a waveform and then push the front-panel Sweep button.

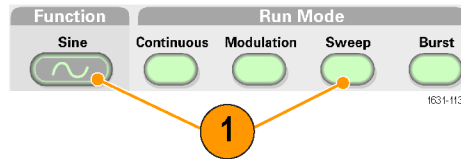

2. You can specify the start frequency, stop frequency, sweep time and return time from the sweep menu.

Return Time represents the amount of time from Stop Frequency to Start Frequency.

Push the -more- button to display the second sweep menu.

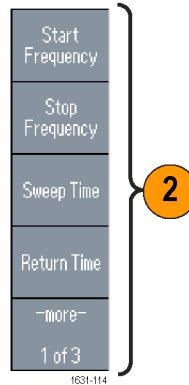

- In this page, you can set the parameters for center frequency, frequency span, hold time and select the sweep type.

Hold time represents the amount of time that the frequency must remain stable after reaching the stop frequency.

Push the -more- button to display the second sweep menu.

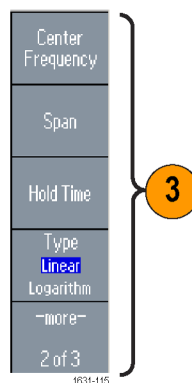

- In this page, you can select the sweep mode (Repeat or Trigger) and trigger source.

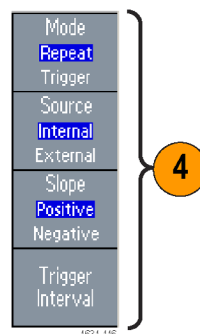

- This is a sample oscilloscope screen. The top is a sample of a sweep waveform.
- This is a trigger output signal.

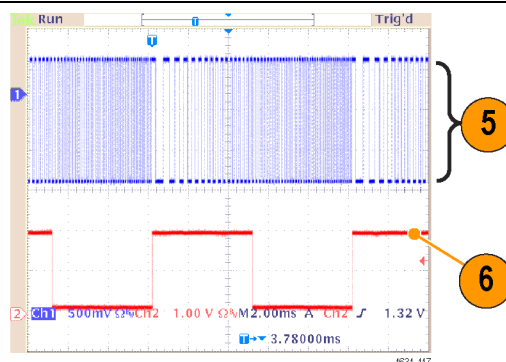

Quick Tips

- For frequency sweep, you can select a sine, square, ramp, or arbitrary waveform. Pulse, DC, and Noise waveforms cannot be selected.
- Once the sweep is selected, the frequency is swept from the sweep start to the sweep stop frequencies.
- If a start frequency is lower than a stop frequency, the instrument sweeps from the low frequency to the high frequency.

- If a start frequency is higher than a stop frequency, the instrument sweeps from the high frequency to the low frequency.
- If you want to return to the Sweep menu after selecting other menus, push the front-panel Sweep button again.

Modulate a Waveform

To Output an AM Waveform

1. Select a waveform and then push the front-panel Modulation button.

In this example, use sine waveform as an output waveform (carrier waveform).

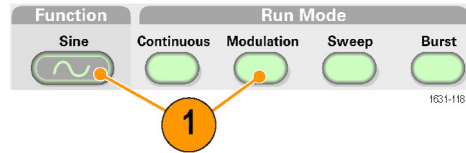

2. Push the top bezel button to display the modulation selection menu.

Select AM as the modulation type.

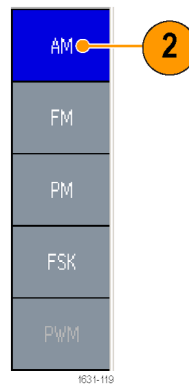

3. Select modulation source.
4. Set modulation frequency.
5. Select modulation shape.
6. Set modulation depth.

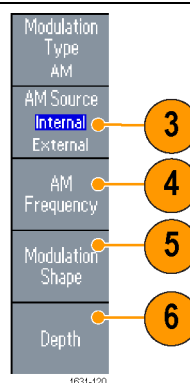

7. This is an example amplitude modulation waveform displayed on an oscilloscope screen.

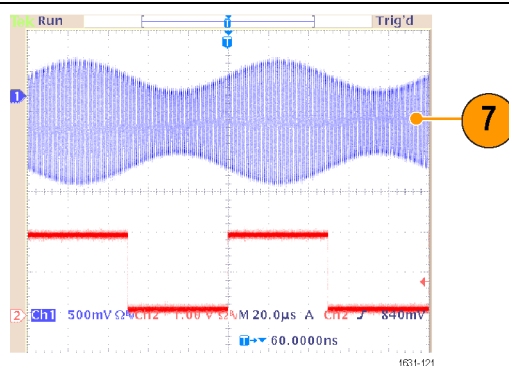

Quick Tips

- You can output frequency modulation or phase modulation waveforms in the same way.
- You cannot select Pulse, Noise, or DC as a carrier waveform.
- You can select an internal or external signal as an AM source. If you select an external source and set the modulation depth to 120%, the output will be at the maximum amplitude when a $\pm 1 V_{p-p}$ signal is applied to the rear panel EXT MODULATION INPUT connector.
- You can select a modulation shape from the internal memory or USB flash drive
- The following equations show the output amplitude of AM, FM, and PM modulation (in this example, sine waveform is used for carrier waveform and modulation waveform):

$$\text{AM: Output}(V_{p-p}) = \frac{A}{2.2} \left(1 + \frac{M}{100} \sin(2\pi f_m t) \right) \sin(2\pi f_c t)$$

$$\text{FM: Output}(V_{p-p}) = A \sin(2\pi (f_c + D \sin(2\pi f_m t)) t)$$

$$\text{PM: Output}(V_{p-p}) = A \sin(2\pi f_c t + 2\pi \frac{P}{360} \sin(2\pi f_m t))$$

Carrier amplitude	A [V_{p-p}]
Carrier frequency	fc [Hz]
Modulation frequency	fm [Hz]
Time	t [sec]
AM Modulation depth	M [%]
FM Deviation	D [Hz]
PM Deviation	P [degree]

- The following table shows relationship between modulation depth and maximum amplitude for AM modulation waveform (internal modulation source is selected):

Depth	Maximum amplitude
120%	A (V _{p-p})
100%	A (V _{p-p}) * 0.909
50%	A (V _{p-p}) * 0.682
0%	A (V _{p-p}) * 0.455

To Output an FSK Waveform

Frequency Shift Keying modulation is a modulation technique that shifts the output signal frequency between two frequencies: the carrier frequency and Hop frequency.

1. Follow the steps described in the To Output an AM Waveform procedure to display the modulation type selection submenu. (See page 69, *Modulate a Waveform.*)

In this example, select FSK as the modulation type.

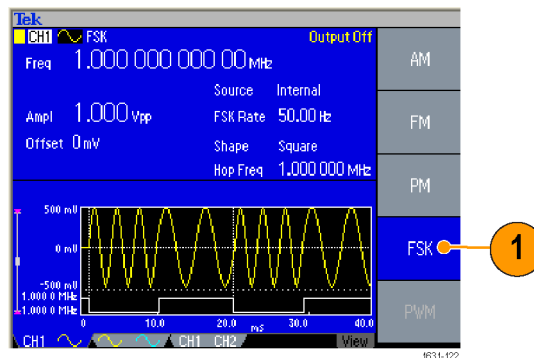

2. The FSK parameter setting screen is displayed. Select Internal or External as FSK source.
3. If you select Internal, you can set the FSK Rate. If you select External, the FSK Rate is ignored.
4. Set Hop Frequency. Carrier waveform frequency shifts to the Hop frequency with the specified FSK rate, and then returns to the original frequency.

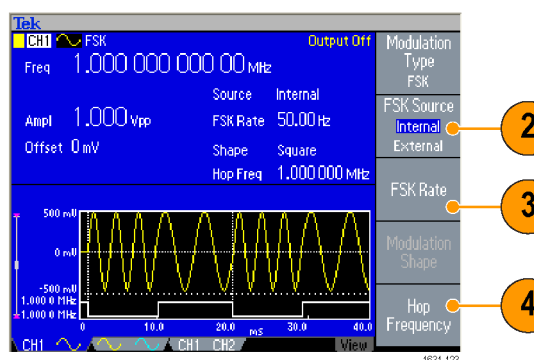

- Quick Tip** ■ The AFG3000 series instruments generate a phase continuous FSK signal.

To Output a PWM Waveform

Follow these steps to output a PWM waveform.

1. Push the front-panel Pulse button, and then push the Pulse Parameter Menu bezel button to display the pulse parameter setting screen.

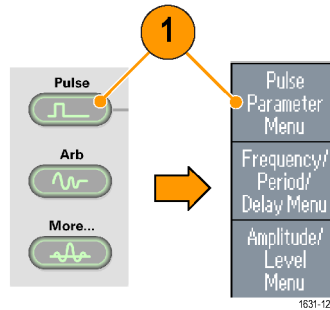

2. Push the front-panel Modulation button to display the PWM parameter setting screen. Select the PWM source.
3. Set the PWM frequency.
4. Select the Modulation Shape.
5. Set the Deviation (pulse width deviation).

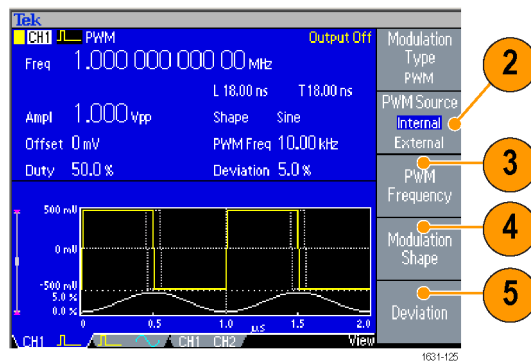

- Quick Tip** ■ See an application example of pulse-width modulation. (See page 94, *Motor Speed Control by Pulse-Width Modulation.*)

Trigger Out

The Trigger Output signal of the instrument is linked to the run mode and function selected in CH1 if your instrument is a dual-channel model.

1. Connect the front-panel Trigger Output connector and the external trigger input connector of the oscilloscopes. The Trigger Output connector provides the trigger signal for oscilloscopes.

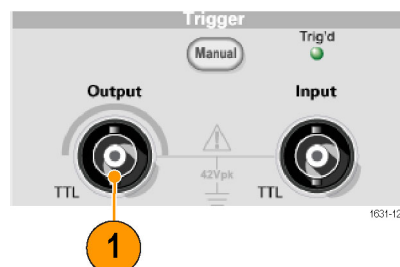

2. Continuous mode: The trigger output is a square waveform and the rising edge at the start of each waveform period. When an output frequency is higher than 4.9 MHz, some restrictions are applied. See the Quick Tips below.

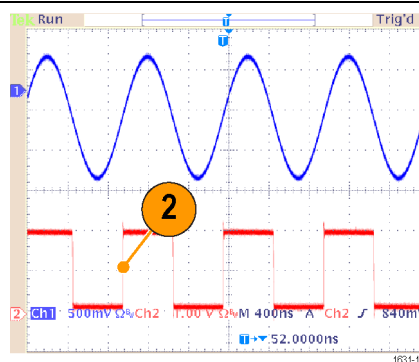

3. Sweep mode: When the Repeat or Trigger sweep mode and internal trigger source are selected, the trigger output is a square waveform and the rising edge at the start of each sweep.

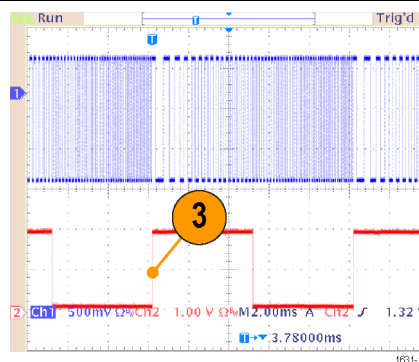

4. Modulation mode: When an internal modulation source is selected, the trigger output is a square waveform of the same frequency as the modulating signal. When an external modulation source is selected, the trigger output is disabled.

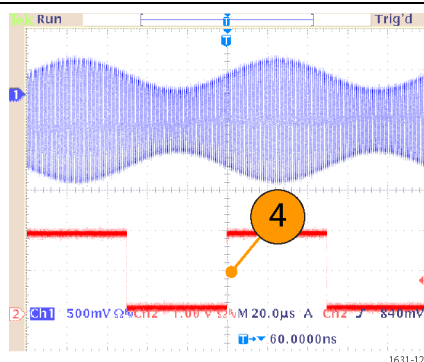

5. Burst Mode: When an internal trigger source is selected, the trigger output is a square waveform and the rising edge at the start of each burst period. When an external trigger source is selected, the trigger output is high during the time the trigger input is high.

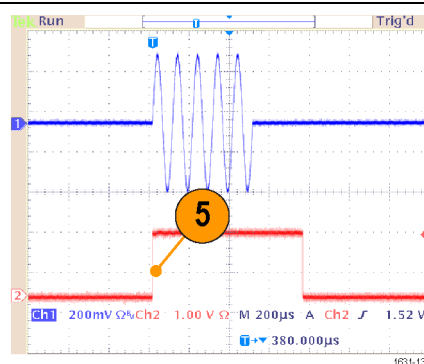

- Quick Tips**
- When a setting frequency of an output waveform is higher than 4.9 MHz, a divided frequency that is lower than 4.9 MHz is output from the Trigger Out. See the table below:

Set frequency of output waveform (MHz)	Trigger output frequency (MHz)
~4.900 000 000 00	Fs
4.900 000 000 01 to 14.700 000 000 0	Fs/3
14.700 000 000 1 to 24.500 000 000 0	Fs/5
24.500 000 000 1 to 34.300 000 000 0	Fs/7
34.300 000 000 1 to 44.100 000 000 0	Fs/9
44.100 000 000 1 to 50.000 000 000 0	Fs/11
50.000 000 000 1 ~	No signal

NOTE. The Trigger Out signal cannot be output when the instrument outputs a continuous signal higher than 50 MHz.

NOTE. When the instrument outputs a modulation waveform, Trigger Output signal cannot be output if you select External as the modulation source.

Adjusting parameters of two channel signals (dual-channel models only)

Phase The AFG3000 series uses phase continuous method to change frequency. When you change the frequency of a channel, it will affect the phase relationship between the two channels.

For example, the instrument is generating a 5 MHz sine waveform for both CH1 and CH2 and the phase is adjusted between the two channels. If you change the CH2 frequency to 10 MHz and then return it to 5 MHz, the CH2 phase does not return to its initial condition. To adjust the phase relationship between the two channels, you need to stop signal generation and restart it. The instrument provides a function called "Align Phase" to adjust the phase relationship.

1. In this example, a 5 MHz continuous sine waveform is used. Confirm that both phases are set to 0 degrees.

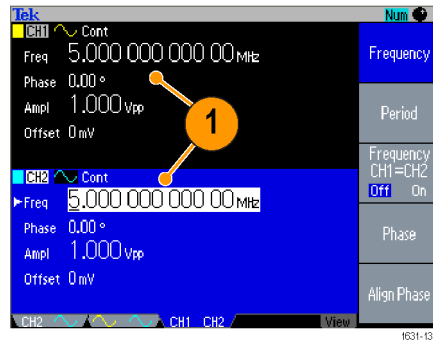

2. Change the CH1 frequency to 10 MHz, and then back to 5 MHz. In this state, the CH2 phase does not return to its initial condition.

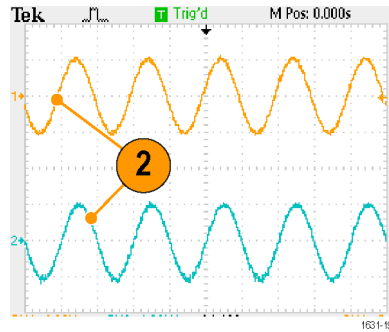

3. To align the phase of two channel signals, push the Align Phase bezel button.
4. When you push the Align Phase button, the instrument will stop the signal generation, adjust the phases of both channels, and automatically restart the signal generation.

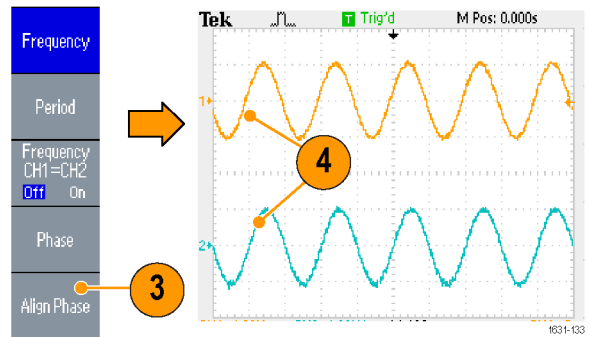

Amplitude To set the CH1 amplitude and CH2 amplitude to the same level, follow these steps:

1. Push the front-panel Amplitude/High shortcut button.
2. Push the -more- bezel button.

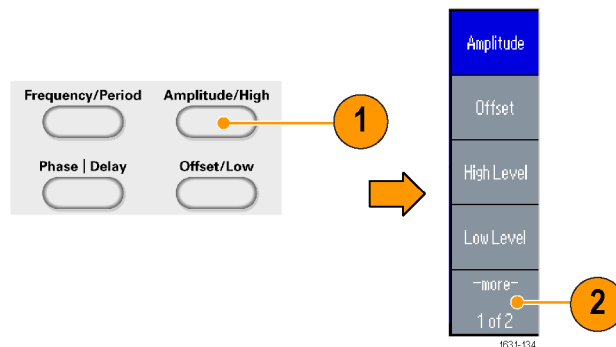

3. Page two of Amplitude/Level Menu is displayed. You can set the CH1 and CH2 amplitude to the same level by selecting On in the second bezel menu from the top.

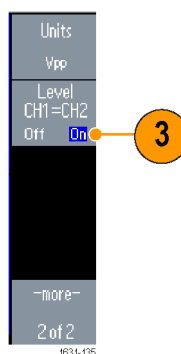

Frequency (Period) To set the CH1 frequency and CH2 frequency to the same value, follow these steps:

1. Push the front-panel Frequency/Period shortcut button to display the Frequency/Period Parameter Menu.
2. You can set the CH1 and CH2 frequency to the same value by selecting On in the third bezel menu from the top.

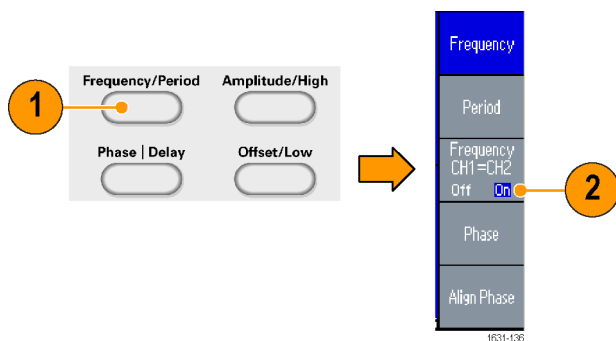

Set up Load Impedance

The output impedance of the AFG3000 series is 50 Ω. If you connect a load other than 50 Ω, the displayed Amplitude, Offset, and High/Low values are different from the output voltage. To make the displayed values same as output voltage, you need to set load impedance. To set the load impedance, use the Output menu.

1. Push the front-panel Top Menu button, and then push the Output Menu bezel button. The Output Menu is displayed.
2. Push Load Impedance to display the Load Impedance submenu.

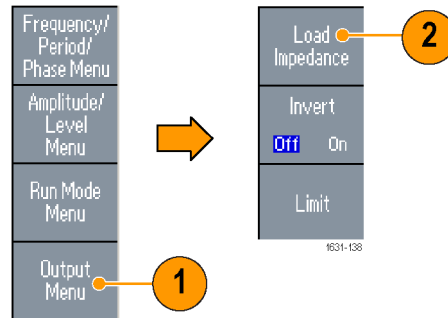

3. To adjust the load impedance, select Load.
4. You can set the load impedance to any value from 1 Ω to 10 kΩ.
5. When the load impedance is set to other than 50 Ω, the set value is displayed in the output status.

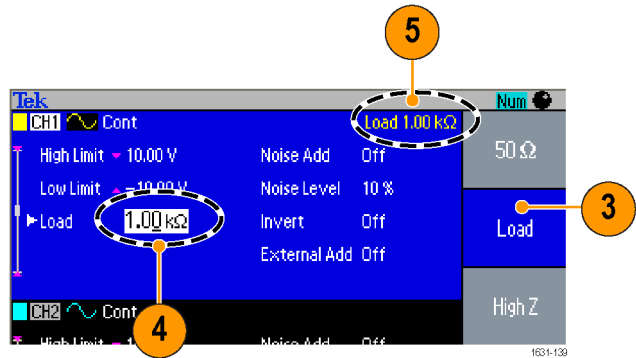

Quick Tips

- The load impedance is applied to the amplitude, offset, and high/low level settings.
- When dBm is specified for output amplitude units, the amplitude units setting is automatically changed to Vpp if you select high impedance.

Invert Waveform Polarity

To invert a waveform polarity, use the Output menu. The following example shows how to get a differential signal using the invert function of dual channel model:

1. Select the CH1 waveform.
2. Push the front-panel Frequency/Period button.
3. Push the Frequency bezel button to set the CH1 frequency.
4. Select the third bezel button from the top to set the two channel frequencies to the same value.

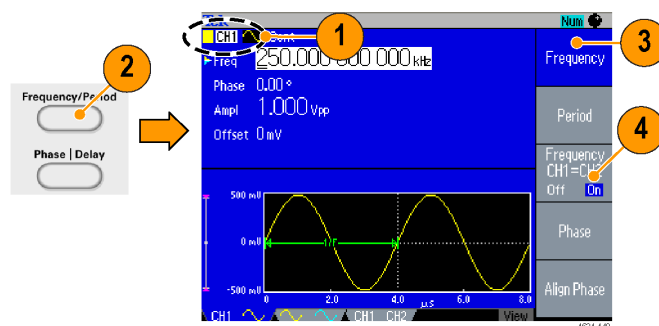

5. Push the front-panel Channel Select button to select CH2.
6. Push the Output Menu > Invert bezel buttons to invert the CH2 waveform.

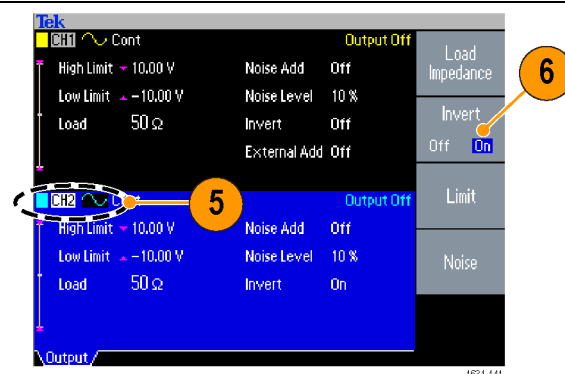

7. Push the front-panel CH1 Output On button to enable the output.
8. You can get a differential signal.

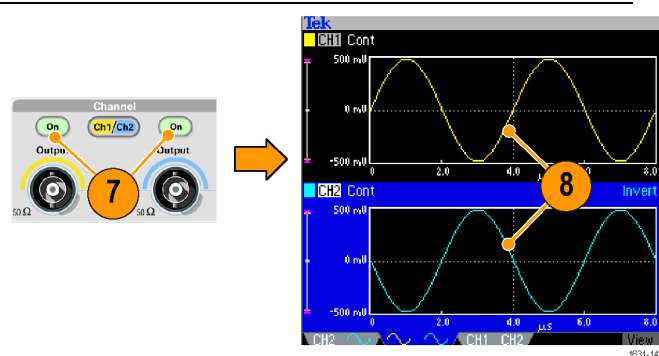

Add Noise

To add the internal noise signal to a waveform, use the Output menu.

1. Push the front-panel Sine > Continuous buttons to display the Sine waveform screen in this example.

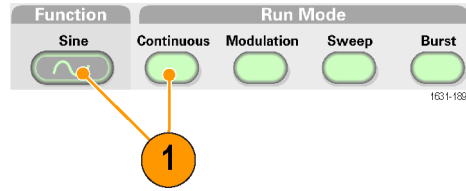

2. Follow the steps described in the previous pages to display the Output Menu. (See page 80.) To add noise to a sine waveform, push Noise.

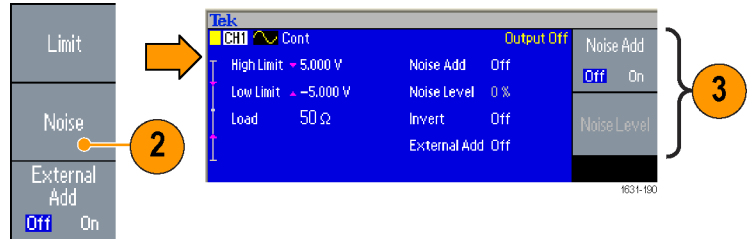

3. The Noise Add submenu is displayed. Push Noise Add to select On.

4. To adjust the noise level, push Noise Level. Use the general purpose knob or the numeric pad to enter the value.

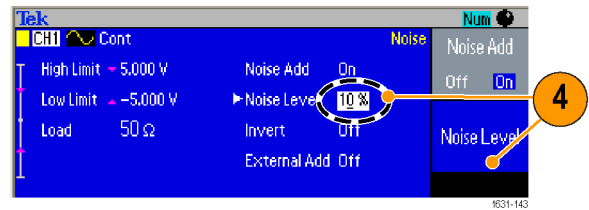

5. This is a waveform before adding noise.

6. This is a waveform after adding noise. To avoid overflow by noise addition, the amplitude of the output signal is automatically halved.

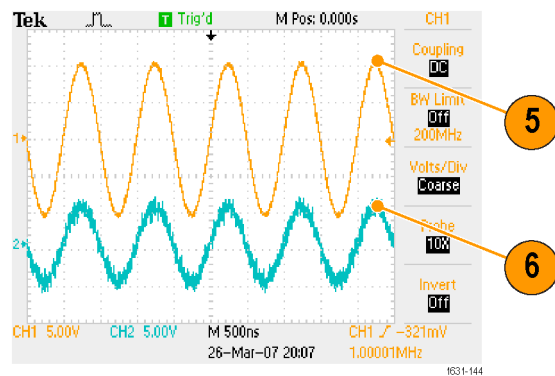

- Quick Tips**
- An internal noise generator (digital) is used to add noise.
 - CH1 and CH2 noise signals are non-correlating.
 - The Output Status is changed from Output Off to Noise when you push the front-panel Channel Output button to enable the output.

NOTE. When you set Noise Add to On, the amplitude of output signal is reduced to 50%.

Add signal (AFG3100 and AFG3200 Series)

The AFG3101 / 3101C / 3102 / 3102C and AFG3251 / 3251C / 3252 / 3252C rear panel ADD INPUT connector allows you to add an external signal to the CH1 output signal.

1. Connect an external signal source to the rear panel ADD INPUT connector.

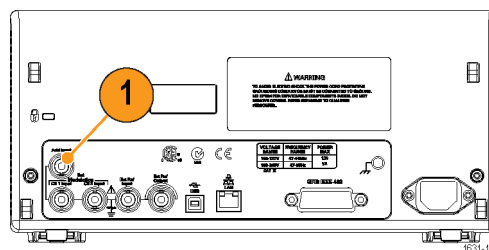

2. Push the front-panel Top Menu button, and then push the Output Menu bezel button.
3. Push External Add to select On.

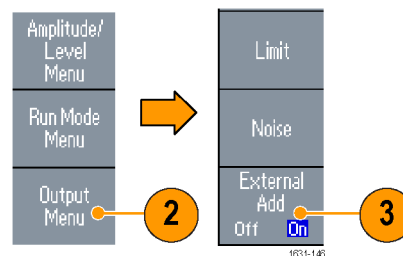

4. The following is an example of adding noise as an external signal. The upper waveform is an external signal.
5. The bottom waveform is a square waveform before adding external signal.

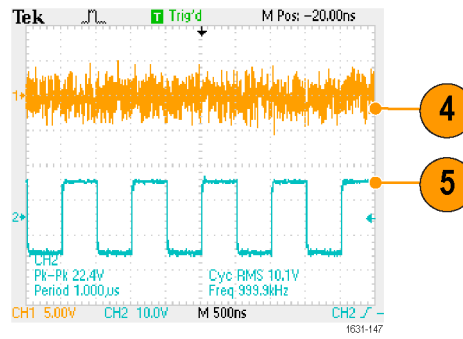

6. This is an example of square waveform after adding external signal (noise).

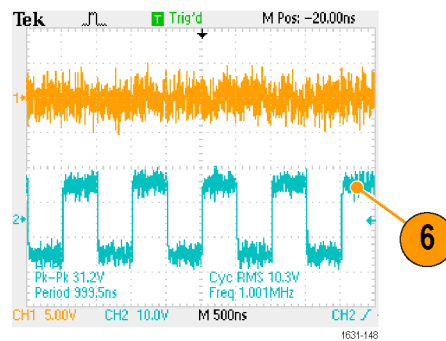

Quick Tip ■ The Output Status is changed from Output Off to Ext Add when you push the front-panel CH1 Output button to enable the output.

Generating a Differential Signal

A dual-channel instrument can be used to generate a differential signal by programming CH2 to output the complement of CH1. The CH2 settings can be configured conveniently by using the CH1 Complement function.

1. After setting the CH1 waveform parameters, push the front-panel Channel select button to select CH2.

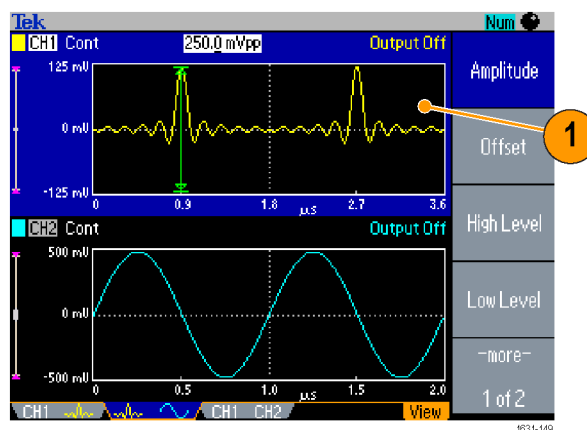

2. Push the front-panel Top Menu button, and then push the Output Menu bezel button.
3. Push the CH1 Complement bezel button.

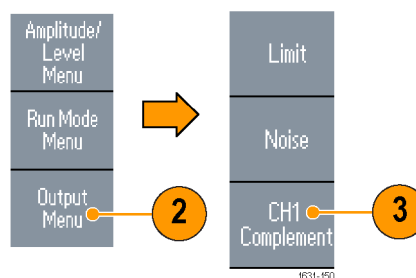

4. The CH2 wave shape and timing parameters are copied from CH1, and the CH2 amplitude settings are inverted from CH1.

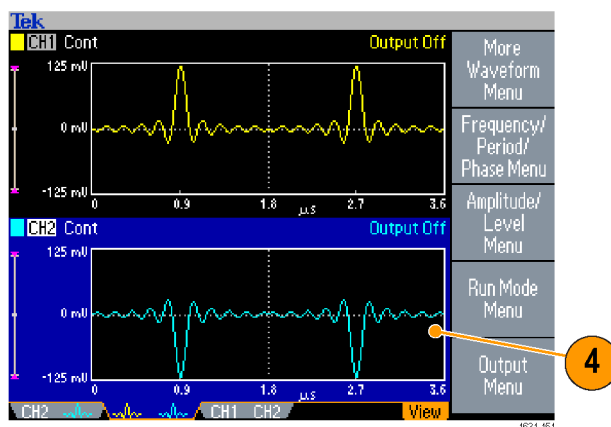

NOTE. When CH1 is selected in the AFG310x or AFG325x series instrument, the instrument displays External Add Off/On in the Output menu.

External Reference Clock

1. The external reference input (EXT REF INPUT) and the external reference output (EXT REF OUTPUT) connectors are provided on the AFG3000 series rear panel.

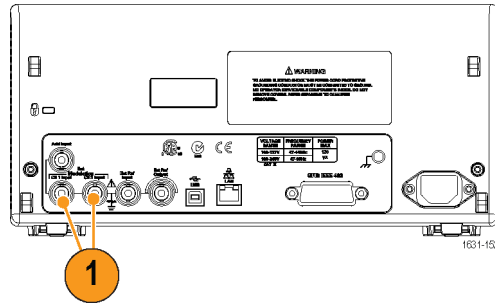

2. The instrument can use the internal or external signal as a reference signal.
To select a reference signal, push the front-panel Utility button and then push the System bezel button.

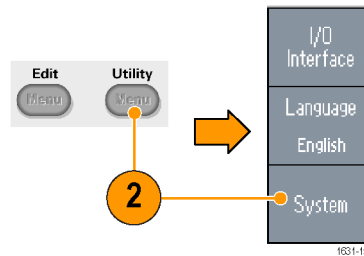

3. Push the Clock Ref bezel menu button to toggle between Internal and External.

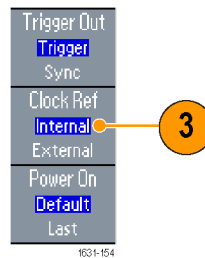

Quick Tips

- The external reference Input and Output connectors are used for synchronizing multiple AFG3000 series instruments.
- The instrument can use the internal source or an external source as a reference signal. When the internal reference is activated, a 10 MHz reference signal is output on the rear panel EXT REF OUT connector. This output signal synchronizes other devices to the instrument.
- When the external reference input is activated, the rear panel EXT REF INPUT connector is used as the input for an external reference signal. The instrument is synchronized by this external reference signal.
- The EXT REF OUTPUT connector is not provided on the AFG3021, AFG3022, AFG3051, or AFG3052.

Synchronous Operation

To synchronize multiple arbitrary function generators, use the Utility menu. Some documentation may also refer to the synchronous operation as master-slave operation.

1. Use a BNC cable to connect the front-panel Trigger Output of one instrument (master) to the Trigger Input of another unit (slave).

The master unit sends a trigger signal to the slave unit.

2. Connect the rear panel EXT REF OUT (master) and EXT REF IN (slave) with another BNC cable.

The master clock and the slave clock are synchronized.

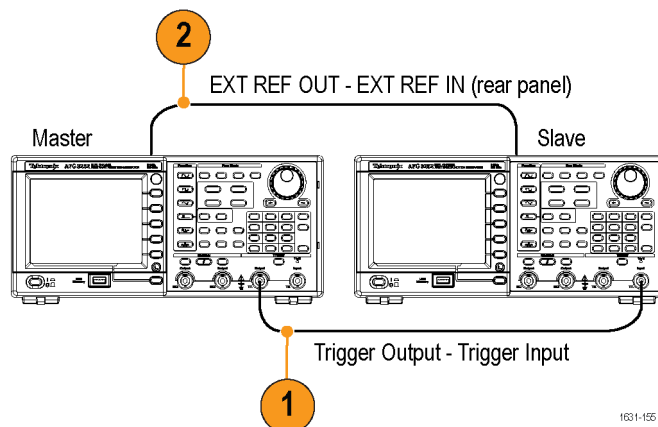

1631-155

3. Push the front-panel Utility button of the master unit to display the System menu.

4. Sets the following:

- Trigger Out - Sync
- Clock Ref - Internal

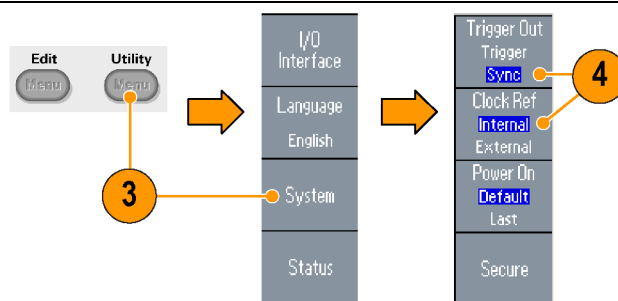

1631-156

5. Set the slave instrument: Display the System menu, and then push the Clock Ref bezel button to select External.

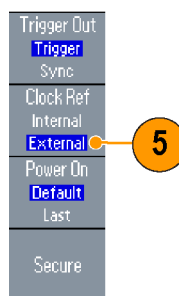

1631-157

- Select Burst as the Run Mode for both the master and the slave instrument.

To synchronize two instruments, you must stop running output signals once before triggering using the Burst mode.

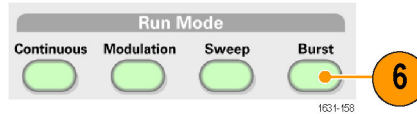

- Select the trigger source of the slave unit.

Push the -more- bezel button in the Burst mode to display the second page.

- Push the Source bezel button to select External.

Confirm that Internal is selected in the master and External is selected in the slave for Source.

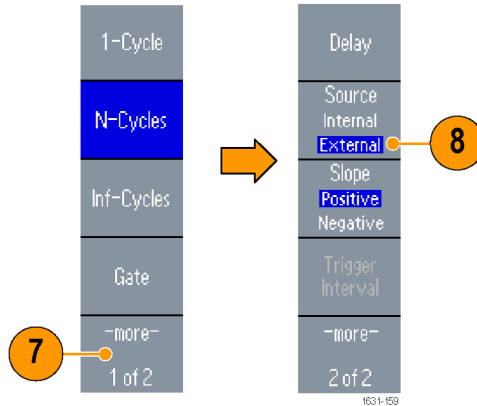

- This screen shows signal outputs by master-slave operation. The top waveform is the signal of the master unit.

- When one meter long cables are used, the slave signal delay approximately 40 ns.

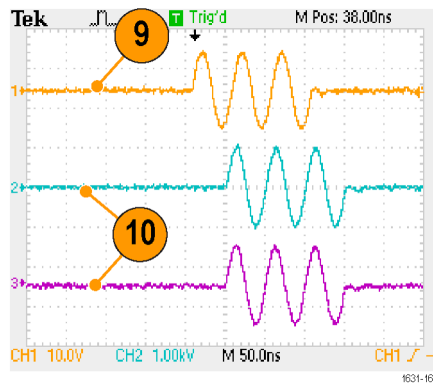

- To make the delay between the master and slave 0 (zero), set the Delay of the master unit.

- The screen shows waveforms after setting the delay to the master unit. The top waveform is master and the two bottom waveforms are slaves.

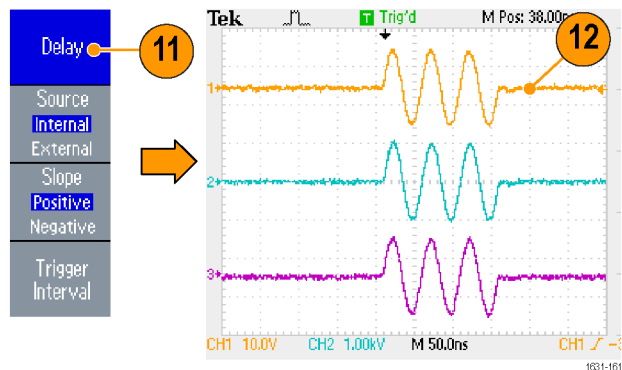

- Quick Tip**
- To output continuous waveforms by synchronous operation, select External as the trigger source for the master unit to stop signal generation. Select Inf-Cycles as the burst count for both master and slave units. Change the trigger source of the master unit to Internal to restart the signal generation.

USB flash drive

A USB flash drive connector is provided with all the Tektronix AFG3000 Series Arbitrary Function Generators to allow you to perform the following tasks:

- Save or recall user-defined waveforms to or from a USB flash drive,
- Save or recall setups to or from files on a USB flash drive,
- Update your instrument firmware,
- Save a screen image,

CAUTION. *When you attach a USB flash drive to the instrument, a caution message appears on the screen. Do not remove the USB flash drive until the message disappears.*

If you remove the USB flash drive while this caution message is displayed, it may cause damage to the instrument.

Read more about saving/recalling user-defined waveforms. (See page 47, *Save/Recall Arbitrary Waveforms*.) Read more about saving/recalling instrument setups. (See page 80, *Save/Recall Instrument Setup*.) Read more about updating your instrument. (See page 15, *Update your instrument firmware*.)

- Quick Tips**
- Use a USB flash drive with cross section smaller than 20 mm x 12 mm to connect to the AFG3000 series front-panel USB connector. To connect a larger USB flash drive, use an extension cable.
 - The AFG3000 series instruments support USB flash drives with a FAT12, FAT16, or FAT32 file systems.

NOTE. *Emissions may exceed the specification limit if a USB cable is placed in the front-panel USB flash drive connector. Use only appropriate USB flash drive devices.*

Utility Menu

Push the front-panel Utility button to display the Utility menu. The Utility menu provides access to utilities used by the instrument such as I/O interface, system related menus, diagnostics/calibration, and local language preferences.

1. Push the front-panel Utility button to display the Utility menu.
2. I/O interface. (See page 17.)
3. Language selection. (See page 10.)
4. For "System related menus. (See page 78 steps 6 and 10.)"
5. Push the Status bezel button to display the instrument status.

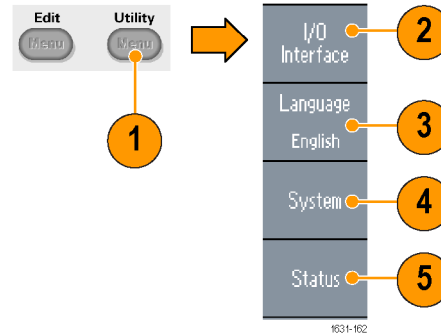

Push the System bezel button to display the System submenu.

6. Trigger Out. (See page 63.)
7. Reference Clock. (See page 74.)
8. You can select the instrument power-on settings.
9. Executing the Secure function will erase all data except the MAC Address, calibration data, and the instrument serial number.



10. Push the -more- button to display the second page. Push Contrast to adjust the screen contrast.
11. Push Screen Saver to toggle the screen saver Off and On.
12. Push Click Tone to toggle the click tone Off and On.
13. Push Beeper to toggle the beep sound Off and On.



14. Push the previous menu arrow button located beneath the bezel buttons to return to the previous menu. Push the -more- button to display the second page.

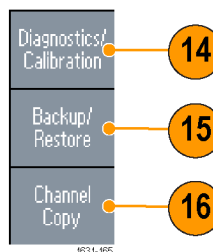

15. For Backup/Restore, see step 17.
16. You can copy the waveform parameter of one channel to another channel.

17. Push the Backup/Restore bezel button to display the Backup/Restore submenu.

In this menu, you can back up a waveform data from internal memory to a USB flash drive or restore a waveform data from a USB flash drive to internal memory.

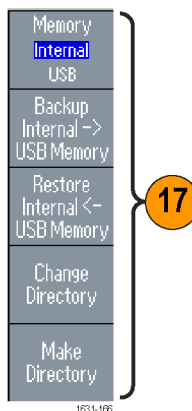

18. Return to the Utility main menu. Push the -more-bezel button to display the third page. On this page, you can execute the instrument firmware update. (See page 15, *Update your instrument firmware.*)

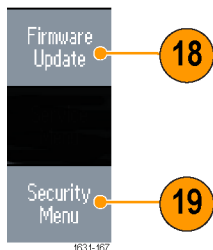

19. Security Menu. (See page 81, *Using the Security Menu.*)

Save/Recall Instrument Setup

You can save setups of the instrument as files in the internal memory or in an external USB flash drive. You can recall the stored setups from a file in the internal memory or in a USB flash drive.

1. Push the front-panel Save button to display the Save Menu.
2. To specify a memory location, select Internal or USB. In this example, select USB. Use the general purpose knob to scroll files. Push Save to save a setting.

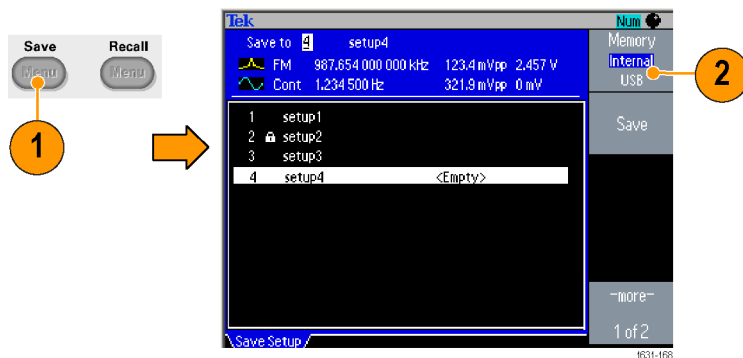

3. You can save a setup as a new file if you specify USB. Push Save As.
4. You can enter a file name in this screen. Use the general purpose knob to select a character. Push the Enter Character bezel button or the front-panel Enter key to enter the character.

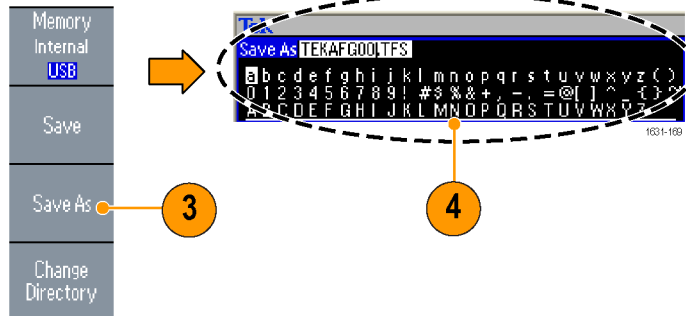

5. To recall a setup, push the front-panel Recall button.
6. Select a memory location (Internal or USB), and then push the Recall bezel button.

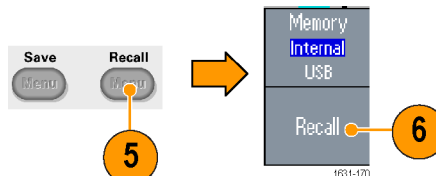

Quick Tips

- You can lock a setup file to avoid accidental overwrite. When a memory location is locked, a lock key icon will appear on the screen. To lock or unlock a setup file, push the Lock/Unlock bezel button.
- To erase a file, push the Erase bezel button.
- Output state is Off by default after reading a setup file.
- If you save a setup to a USB flash drive, a file with the extension TFS is saved.

Saving a Screen Image

You can save a screen image of the instrument to a USB flash drive. Do the following steps:

1. Insert a USB flash drive to the front-panel USB connector.

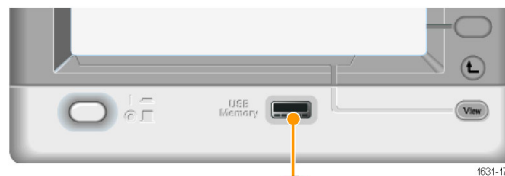

2. Set the display to show the screen you want to save as an image. Then simultaneously push the two arrow keys underneath the rotary knob on the front panel.

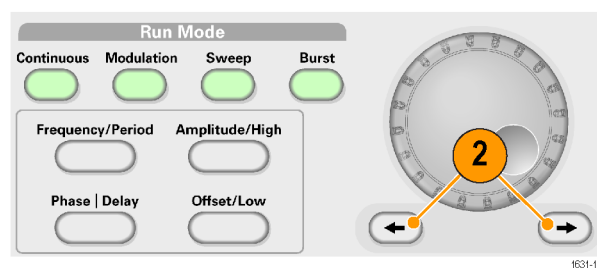

3. A message appears on the screen, indicating that the screen image was saved.
4. Push OK.

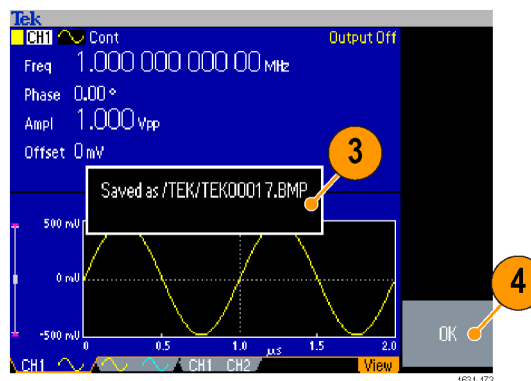

Quick Tips

- Image files are saved in a folder named "TEK" on the USB flash drive.
- Image files are saved as .BMP format. The instrument gives all files created by the instrument the default name TEK00nnn.BMP, where nnn is a placeholder for an automatic number sequence from 000 to 999.

Using the Security Menu

Use the Security menu to limit access to the following menus:

- Firmware update
- Service menu (refer to the service manual for information about the service menu).

Access Protection

The access protection is set to Off by default. To turn the access protection on, do the following steps:

1. Push the front-panel Utility button to display the Utility menu, and then push the -more- bezel button twice.
2. Select Security Menu.

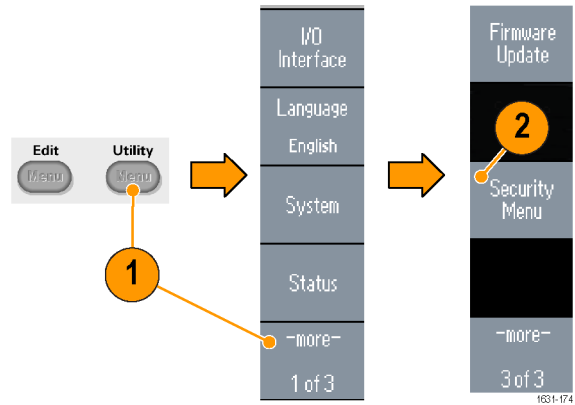

3. Select Access Protection to display the password input page.
4. Enter your password. Use the general purpose knob to select the characters and push the Enter Character bezel button after each selection.

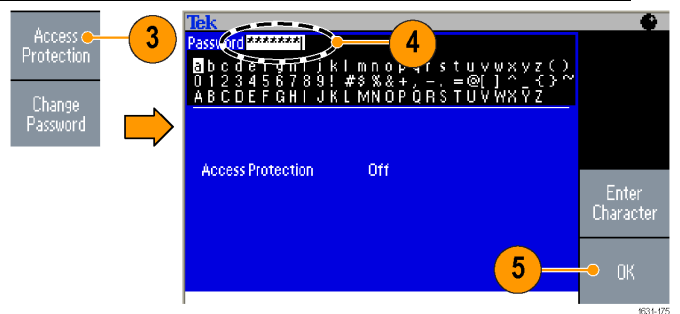

As you enter the characters of your password, they are displayed as a series of asterisks (*****) on the password input page.

If no specific password has been previously defined, use the default password DEFAULT.

5. Select OK to turn the access protection on.

NOTE. When Access Protection is on, the Change Password bezel button is disabled.

Changing the password Before the password is changed for the first time, the default password is DEFAULT. To change the password, do the following steps:

1. Select Security Menu from the Utility menu.
2. If the Access Protection is set to On, turn it off using the Access Protection menu. Otherwise, skip to step 3.

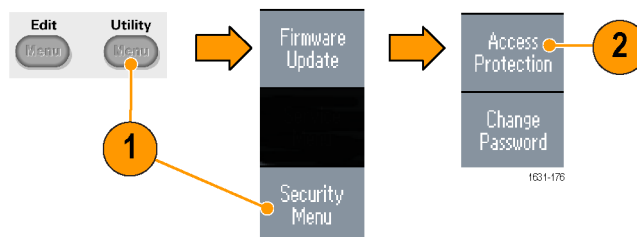

3. Select Change Password to display the password input page.
4. Enter your current password.
Use the general purpose knob to select the characters and push the Enter Character bezel button after each selection. Then select OK to display the New Password input page.

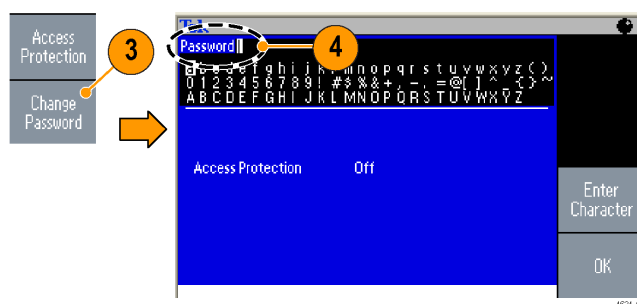

5. Enter a new password.
As you enter the characters of your new password, they are displayed on the screen. Check carefully to ensure you are entering the desired characters.
6. Select OK to activate the new password.

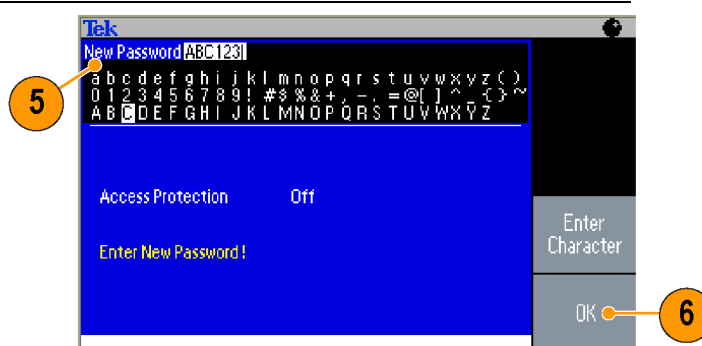

NOTE. A password must have at least four characters, and not more than 12 characters.

Quick Tip

- Use the front-panel general purpose knob to select a character when you enter a password, and then push the Enter Character bezel button. You can also use the front-panel numeric keypad and the Enter button.

NOTE. To activate or deactivate the access protection, you must enter the password you set. If you forget the password, you must return the instrument to Tektronix to reset the password.

ArbExpress

ArbExpress is a Windows-based software for creating and editing waveforms for Tektronix AWG and AFG instruments. With ArbExpress, you can quickly and conveniently create the desired waveforms and send them to the instrument.

The following table and list describe the system requirements and general features.

System requirements

OS Supported	Windows XP Professional or Windows 2000 or Windows 98/Me or Windows NT or Windows 7 (32-bit only)
Minimum PC Requirements	Pentium III 800 MHz and higher 256 MB RAM 300 MB free hard disk Microsoft Internet Explorer 5.01 and higher .NET Framework 1.1 Redistributable 800 x 600 Display resolution
TekVISA	Version 3.3.4.6 and above

- Create waveforms from standard waveform templates
- Modify and transfer waveforms to perform DUT level tests
- Directly import waveforms from Tektronix oscilloscopes
- Send waveforms to AWG/AFG instruments directly from ArbExpress or MATLAB
- Math operations on waveforms

NOTE. You can use ArbExpress to transfer waveform data to the instrument. When you transfer waveform data (.tfw file), any part of the waveform outside of allowed limits in the AFG3000 series will be automatically converted to be within the allowed range.

The following pages contain the screen interface and basic operating procedures for using ArbExpress. For more information on ArbExpress, refer to the ArbExpress online help.

Screen interface

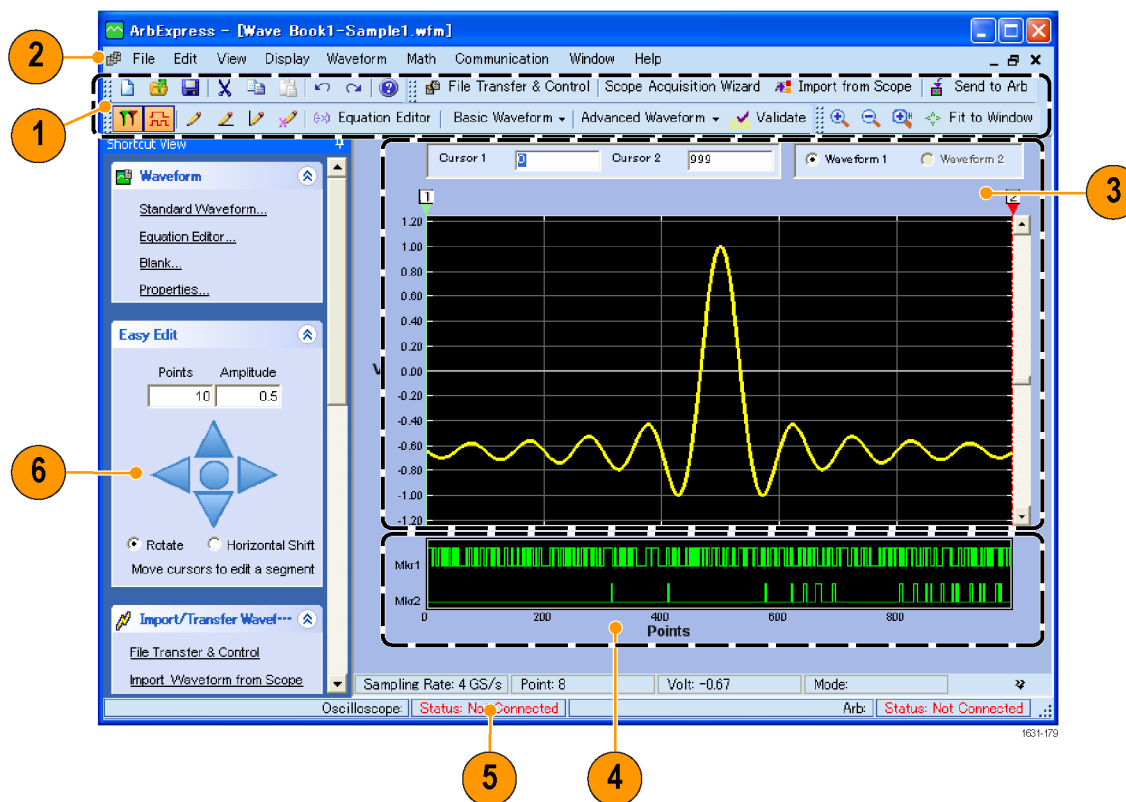

Item	Description
1	Menu bar: The menu bar provides access to the application functions. When you select a menu item, the application displays the associated dialog box or the menu selection causes an immediate action.
2	Toolbar: The toolbar buttons provide instant access to most features without having to navigate through several menus.
3	Waveform display area: When you create or open a waveform, it will be displayed in this area.
4	Marker area: Marker patterns appear in this area. You can toggle the display of markers by selecting Display > Marker from the menu bar.
5	Status bar: The status bar, located below the waveform and marker display, shows information about the application and the waveform.
6	Shortcut View: The Shortcut view occupies the left part of the display. Use the Shortcut view to quickly access various functions provided by the application. Refer to the ArbExpress online help for more information.

Basic operations The following steps explain basic waveform creation and other useful functions that are available with ArbExpress.

1. To create a new waveform, use the File menu.
2. Blank sheet opens a blank sheet in the window with a 1024 point waveform length. You can change the number of points using Properties... from the Waveform menu.

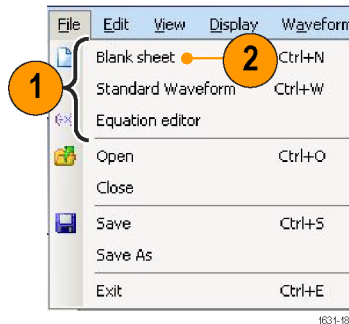

3. Use the Standard Waveform dialog box to create any of the standard waveforms that are available. Use Settings to select a desired waveform and instrument type.
4. Use Vertical to set the waveform vertical parameters.
5. Use Horizontal to set the waveform horizontal parameters.
6. Click Preview to view the waveform.

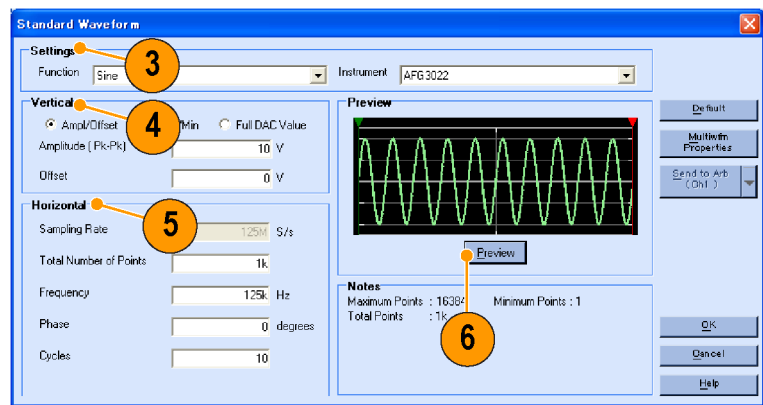

7. You can also use the Equation Editor to create a waveform. The application provides a set of sample equations that you can directly use or modify.
8. Use Command List to select the commands, functions, units, and operations.
9. Use Preview to view the waveform after the equation is compiled.

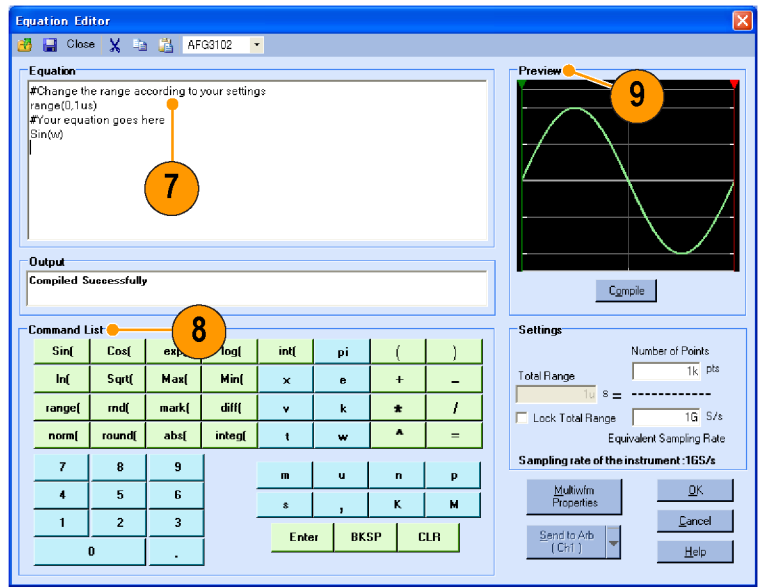

10. You can also use a waveform math tool.
From the Math menu, select Waveform Math... to display the Waveform Math dialog box.
11. Select a math source from Waveform Library. Select Noise in this example.
12. Calculation results are displayed in the Resultant Waveform pane. This is an example of adding noise to a square waveform.

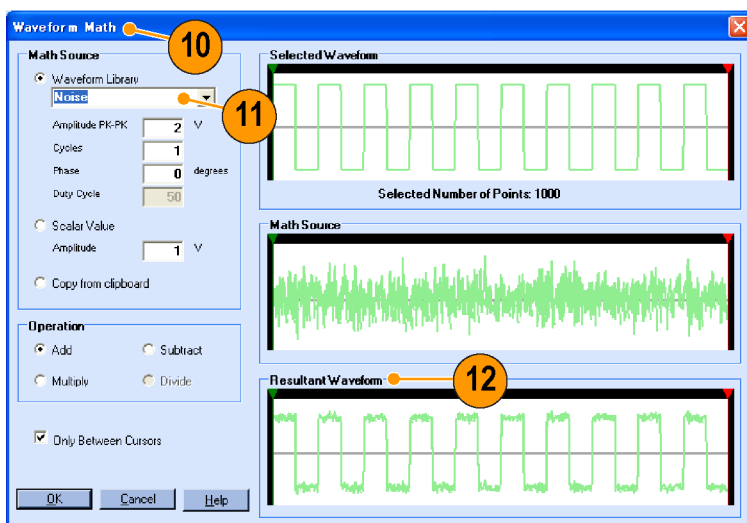

1631-183

13. You can remotely control Tektronix AWG/AFG instruments using ArbExpress.
From the Communication menu, select AWG/AFG File Transfer & Control... to display the dialog box.
14. Connected instruments are listed on the Arb List.
15. The Instrument Control pane appears only when an instrument is connected, otherwise it is hidden.

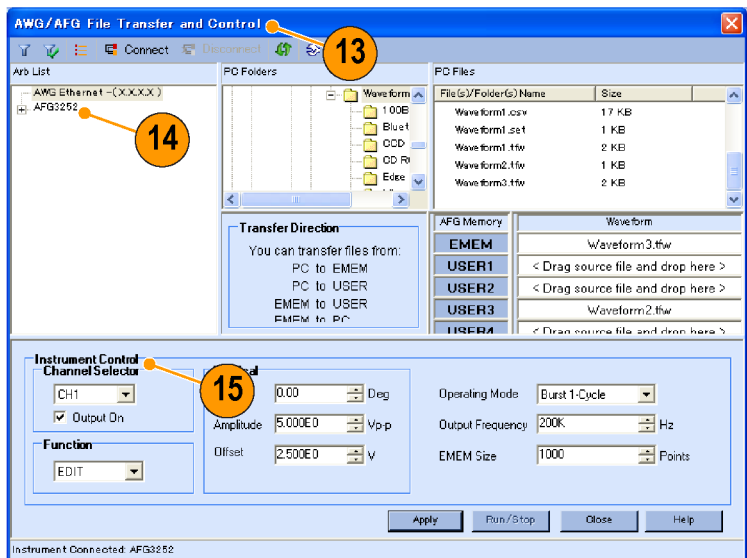

1631-184

Using CSV format waveform data

ArbExpress allows you to convert a CSV (Comma Separated Value) format file, which is created by Microsoft Excel, to waveform data that is compatible with the instrument.

1. Create a CSV file to use with ArbExpress.
2. Enter point or time to this column.
3. Enter data to this column.

When you open a CSV file, a dialog box may appear to confirm the CSV file format.

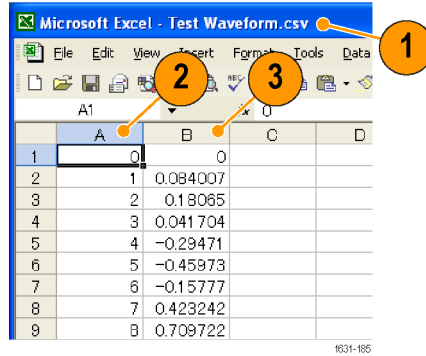

4. This is an example of ArbExpress waveform display area after recalling CSV data.



5. Save the waveform as the .tflv format.
Copy the waveform data to a USB flash drive and load the waveform in the arbitrary function generator.

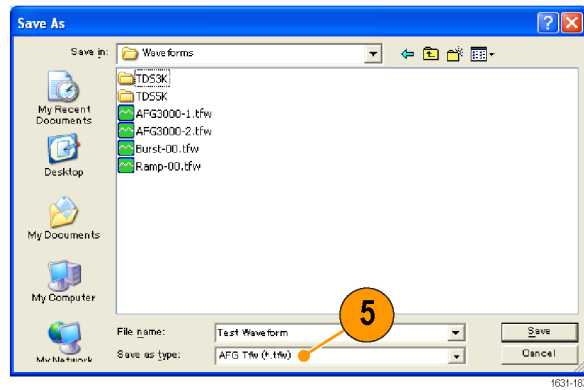

6. The AFG3000 series instrument outputs recalled waveform data. This is an example of the oscilloscope screen.

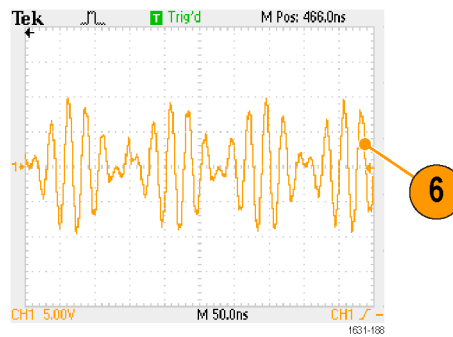

Application Examples

This section contains a series of application examples. These simplified examples highlight the features of the instrument and give you ideas for using it to solve your own test problems.

Lissajous Patterns

Use your AFG3000 series dual-channel model to create a Lissajous pattern and observe the waveforms with an oscilloscope.

1. Connect the CH1 and CH2 Outputs of the dual-channel instrument and the CH1 and CH2 Inputs of an oscilloscope with BNC cables. Set the waveform parameters as follows:

- Sine (Continuos)
- Amplitude: 1 V
- CH1 Frequency: 400 kHz
- CH2 Frequency: 500 kHz



2. Set the oscilloscope display format to XY. Adjust the amplitude so that the waveform is shown in the graticule. A Lissajous pattern is displayed.

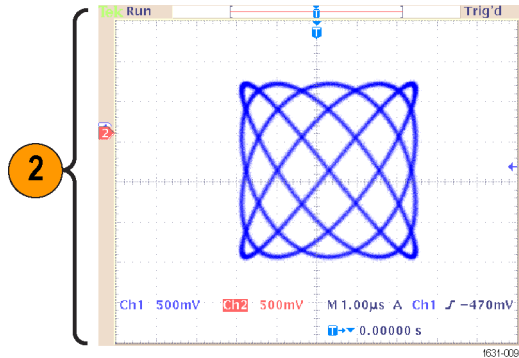

3. Use the general purpose knob on the instrument to change the phase of CH1 or CH2. Observe that the Lissajous pattern changes shape.

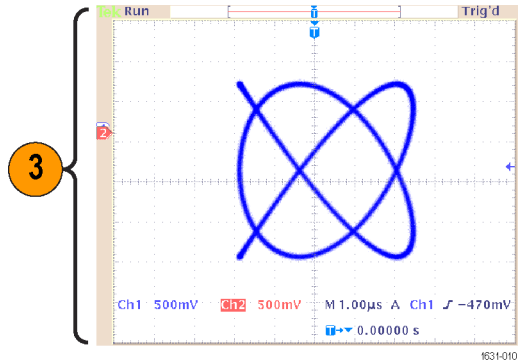

Measurement of Filter Characteristics

Use the instrument sweep function to observe the frequency characteristics of the 50 Ω filter.

1. Connect the CH1 output of the instrument and an oscilloscope CH1 input with a BNC cable.
2. Connect the Trigger Output of the instrument and the external trigger input connector of an oscilloscope.
Set the oscilloscope input impedance to 50 Ω .

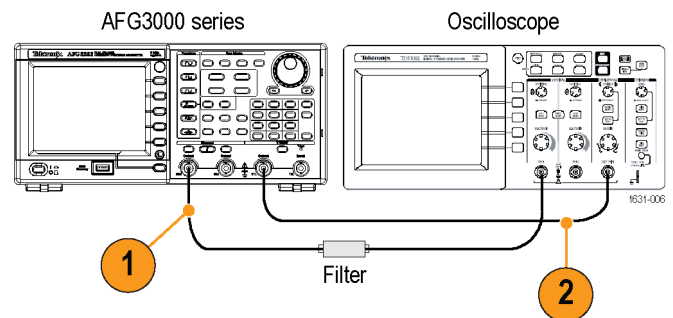

3. Select Sweep from Run Mode of the instrument and set the start frequency, stop frequency, and sweep time so that the waveform is shown in the graticule.
You can measure the frequency characteristics of the filter by sweep time and the oscilloscope time base.

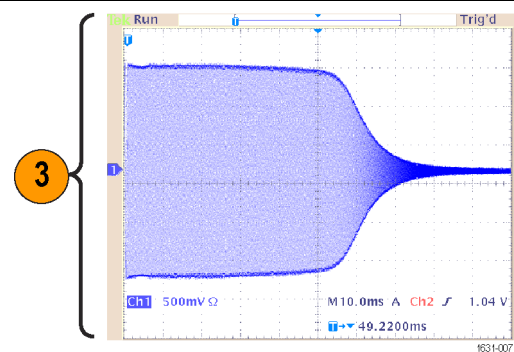

Motor Speed Control by Pulse-Width Modulation

Pulse-width modulation is used for controlling the speed of a DC motor or the luminance of an LED (Light Emitting Diode). Use the instrument PWM function to control the DC motor speed.

1. Connect the instrument output and a DUT using a BNC-to-alligator clip adapter.

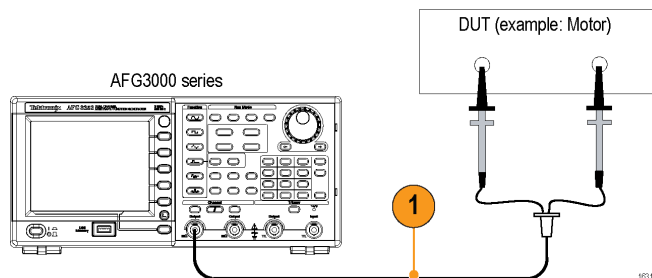

2. Select Pulse as an output waveform and then select PWM as a modulation type.
Set the frequency to approximately 100 kHz.

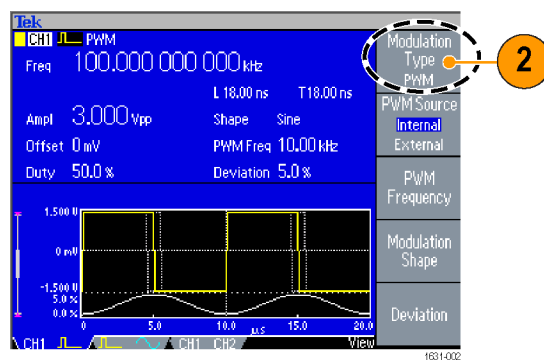

3. Connect the output to an oscilloscope. Confirm that a pulse-width modulation waveform is displayed on the oscilloscope screen.
Select Pulse Duty and change the duty rate. Observe that the motor speed changes if you change the duty rate.

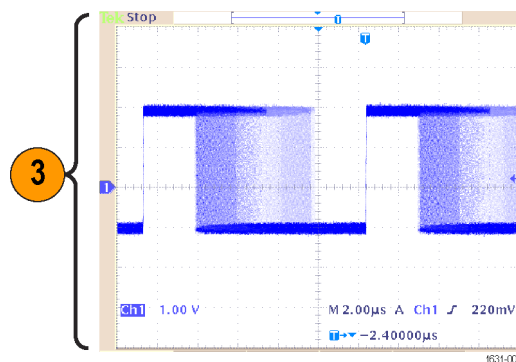

Carrier Null (Frequency Modulation)

Use the instrument and spectrum analyzer to observe a carrier waveform of frequency modulation.

1. Select Sine as an output waveform and then select FM as the modulation type.
2. Set the waveform parameters as follows:
 - Carrier frequency: 1 MHz
 - Modulation frequency: 2 kHz

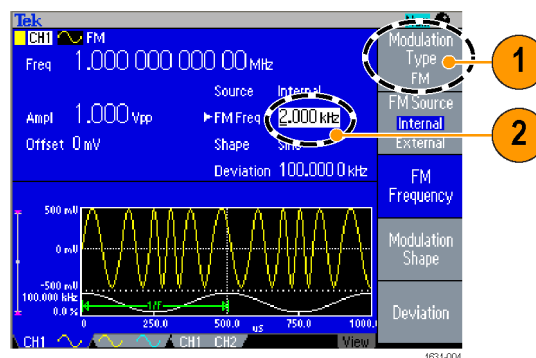

3. Change Deviation.
 - Set the deviation to 4.8096 kHz. It makes the carrier waveform null.
 - Confirm that the carrier null can be observed on the spectrum analyzer.

