

# **Agricultural Industry Advanced Vehicle Technology: Benchmark Study for Reduction in Petroleum Use**

Roger Hoy  
Rodney Rohrer  
Adam Liska  
Joe Luck  
Loren Isom  
Deepak Keshwani

September 2014



The INL is a U.S. Department of Energy National Laboratory  
operated by Battelle Energy Alliance

**DISCLAIMER**

This information was prepared as an account of work sponsored by an agency of the U.S. Government. Neither the U.S. Government nor any agency thereof, nor any of their employees, makes any warranty, expressed or implied, or assumes any legal liability or responsibility for the accuracy, completeness, or usefulness, of any information, apparatus, product, or process disclosed, or represents that its use would not infringe privately owned rights. References herein to any specific commercial product, process, or service by trade name, trade mark, manufacturer, or otherwise, does not necessarily constitute or imply its endorsement, recommendation, or favoring by the U.S. Government or any agency thereof. The views and opinions of authors expressed herein do not necessarily state or reflect those of the U.S. Government or any agency thereof.

# **Agricultural Industry Advanced Vehicle Technology: Benchmark Study for Reduction in Petroleum Use**

**Roger Hoy<sup>1</sup>  
Rodney Rohrer<sup>1</sup>  
Adam Liska<sup>1</sup>  
Joe Luck<sup>1</sup>  
Loren Isom<sup>1</sup>  
Deepak Keshwani<sup>1</sup>**

**1 University of Nebraska – Lincoln, Department of Biological Systems Engineering, Nebraska  
Tractor Test Laboratory**

**September 2014**

**Idaho National Laboratory  
Idaho Falls, Idaho 83415**

**<http://www.inl.gov>**

**Prepared for the  
U.S. Department of Energy  
Office of Nuclear Energy  
Under DOE Idaho Operations Office  
Contract DE-AC07-05ID14517**

# CONTENTS

ACRONYMS .....	v
1. FARM DIESEL USE IN THE UNITED STATES .....	1
2. TRACTOR DIESEL EFFICIENCY—PRIMARY FUEL USE.....	4
2.1 Tractor Mechanics .....	4
2.1.1 Engine .....	6
2.1.2 Waste Heat Recovery .....	7
2.1.3 Powertrain .....	8
2.1.4 Remote Power (Hydraulic, Mechanical, Electric) .....	12
2.1.5 Tires and Tire Pressure .....	18
3. IMPLEMENT OPERATIONS—SECONDARY FUEL USE .....	20
4. ALTERNATIVE FUELS .....	22
4.1 Biofuels .....	22
4.1.1 Biodiesel .....	22
4.1.2 Ethanol .....	23
4.2 Hydrogen.....	25
4.3 Natural Gas Substitution in Tractors .....	25
4.3.1 Natural Gas-Fueled Tractors .....	25
4.3.2 Natural Gas Resources and Prices .....	26
4.3.3 Natural Gas Infrastructure: Refueling Sites and Fuel Storage .....	27
4.3.4 Trends in Heavy Trucks: Diesel Substitution with Natural Gas .....	27
5. FARMING SYSTEMS—SECONDARY FUEL USE .....	28
5.1 Cultural Practices .....	28
5.1.1 Equipment Selection and Operations Management.....	28
5.1.2 Tillage Considerations .....	29
5.2 Precision Agriculture and Machinery Automation.....	31
5.2.1 Guidance and Automatic Section Control Technologies.....	31
5.2.2 Variable Rate Application of Crop Inputs .....	31
5.2.3 Precision Tillage .....	32
5.2.4 Robotics and Autonomous Machinery .....	33
6. CONCLUSIONS AND RECOMMENDATIONS* .....	34
7. REFERENCES .....	36

## FIGURES

1.	Historical United States diesel consumption. “Farm” includes all diesel use on the farm and “Off-Highway” includes forestry, construction, and industrial .....	1
2.	Estimated diesel use by harvested crop in 2010 for reduced tillage: A) harvested area by crop and B) estimated diesel use by crop. Note: “other crops” consists of 28 individual crops .....	2
3.	Cropping cycle and diesel use per operation for corn with mulch tillage practice .....	2
4.	Farm diesel use and harvested acres 1993 through 2010.....	2
5.	Cost per acre for crop inputs.....	3
6.	Annual, average, specific, volumetric fuel consumption for power take-off and drawbar power for diesel tractors .....	4
7.	Annual, average, specific, volumetric fuel consumption for power take-off power by power take-off power level for diesel tractors .....	5
8.	Annual, average, specific, volumetric fuel consumption for drawbar power by drawbar power level for diesel tractors.....	5
9.	Discrepancy between existing performance tests (black) and probable in-field load distributions (red) .....	6
10.	Prototype waste heat recovery system developed by Behr .....	8
11.	Belarus 3023 tractor with electro-mechanical powertrain .....	10
12.	Rigitrac EWD120 tractor with electric powertrain.....	10
13.	ZF TERRA+ starter generator in combination with the continuously variable S-Matic transaxle.....	11
14.	AGCO ElectRoGator 1386.....	11
15.	Energy losses in mobile load sensing hydraulic application .....	13
16.	Pressure flow curve, single pump, dual function.....	14
17.	ZF TERRA+ electrification schematic .....	15
18.	Trailer with electrically powered traction axle .....	16
19.	Electric pump drive (top) and UX eSpray components schematic (bottom).....	17
20.	John Deere patent for round baler with electrically driven roller .....	18

21.	John Deere patent for electrically driven threshing cylinder.....	18
22.	Galileo wheel with accordion-shape sidewall design.....	20
23.	Diesel use by operation for combines and tractors with implements .....	21
24.	United States biodiesel production .....	23
25.	New Holland’s NH2 hydrogen-powered tractor.....	25
26.	Natural gas tractors: a. Profi 4135, dedicated natural gas; b. retrofit dual fuel; and c. Valtra T133, dual fuel production hybrid.....	26
27.	Trends in tillage practices in the United States.....	30
28.	Diesel use by crop and tillage practice .....	30
29.	SPIRIT tractor.....	33
30.	Travel path for two grain carts (blue and black) overlaid on yield map for 120-acre corn field.....	34

## TABLES

1.	Specifications for tractors fueled by natural gas, biogas, and diesel .....	26
2.	Estimated U.S. diesel consumption by crop in 201 .....	29

## ACRONYMS

ASC	automatic section control
CNG	compressed natural gas
CVT	continuously variable transmissions
GPS	global positioning system
LNG	liquid natural gas
NG	natural gas
NTTL	Nebraska Tractor Test Laboratory
OECD	Organization for Economic Cooperation and Development
PTO	power take-off
VRA	variable rate application

# Agricultural Industry Advanced Vehicle Technology: Benchmark Study for Reduction in Petroleum Use

## 1. FARM DIESEL USE IN THE UNITED STATES

Diesel use on farms in the United States has remained relatively constant since 1985, decreasing slightly in 2009, which may be attributed to price increases and the economic recession (Figure 1). During this time, the United States' harvested area also has remained relatively constant at roughly 300 million acres. In 2010, farm diesel use was 5.4% of the total United States diesel use. Crops accounting for an estimated 65% of United States farm diesel use include corn, soybean, wheat, hay, and alfalfa, respectively, based on harvested crop area and a recent analysis of estimated fuel use by crop (Figure 2).<sup>1</sup> Diesel use in these cropping systems primarily is from tillage, harvest, and various other operations (e.g., planting and spraying) (Figure 3). Diesel efficiency is markedly variable due to machinery types, conditions of operation (e.g., soil type and moisture), and operator variability. Farm diesel use per acre has slightly decreased in the last two decades (Figure 4) and diesel is now estimated to be less than 5% of farm costs per acre (Figure 5).

This report will explore current trends in increasing diesel efficiency in the farm sector. The report combines a survey of industry representatives, a review of literature, and data analysis to identify nascent technologies for increasing diesel efficiency.

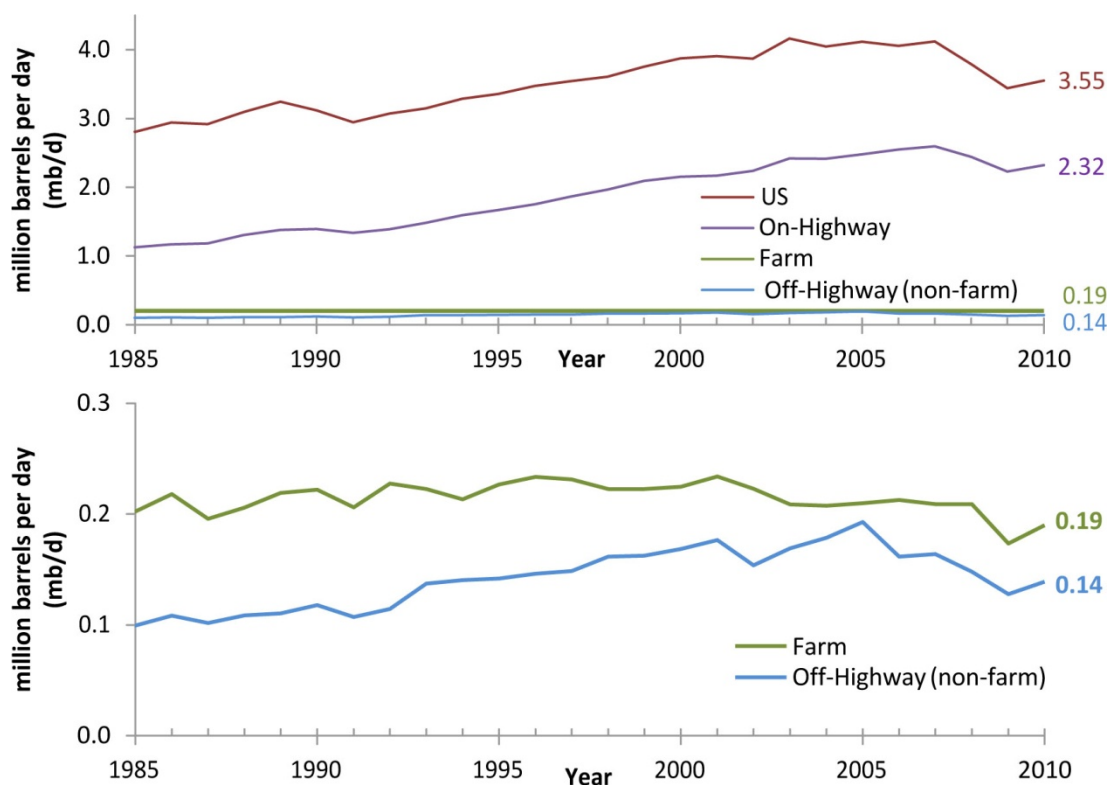

Figure 1. Historical United States diesel consumption. “Farm” includes all diesel use on the farm and “Off-Highway” includes forestry, construction, and industrial (source: DOE/EIA Annual Energy Review 2011 Table 5.15<sup>2</sup>).



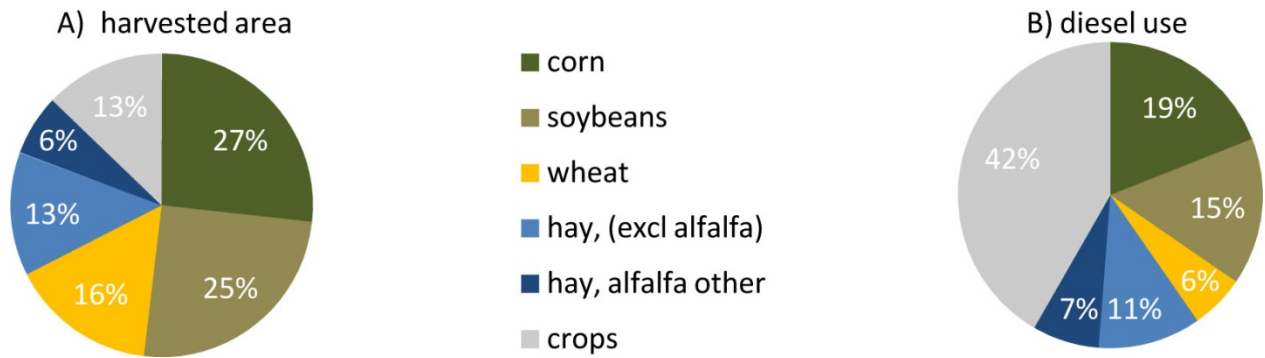

Figure 2. Estimated diesel use by harvested crop in 2010 for reduced tillage: A) harvested area by crop and B) estimated diesel use by crop. Note: “other crops” consists of 28 individual crops (source: data plotted from Table 2).

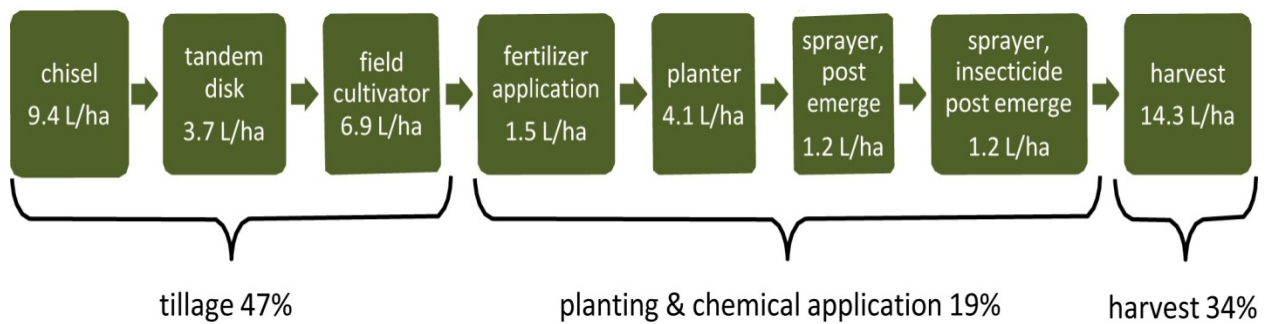

Figure 3. Cropping cycle and diesel use per operation for corn with mulch tillage practice.<sup>3</sup>

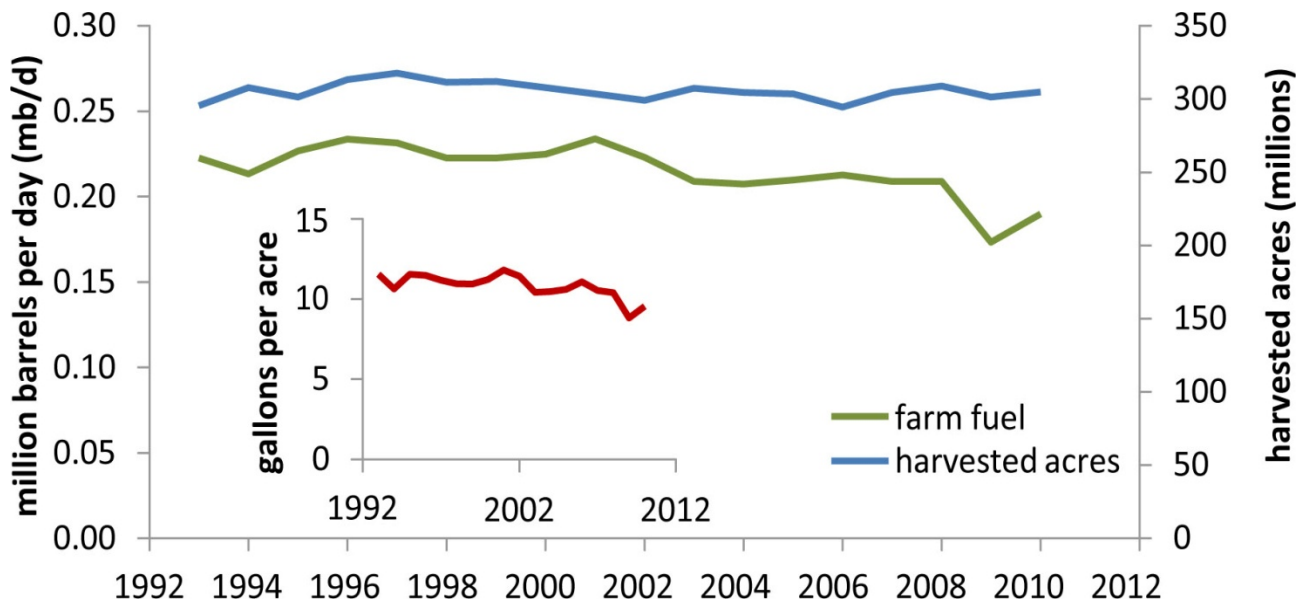

Figure 4. Farm diesel use and harvested acres 1993 through 2010 (source: fuel use data from U.S. Annual Energy Review 2011, harvested acreage data from USDA NASS).

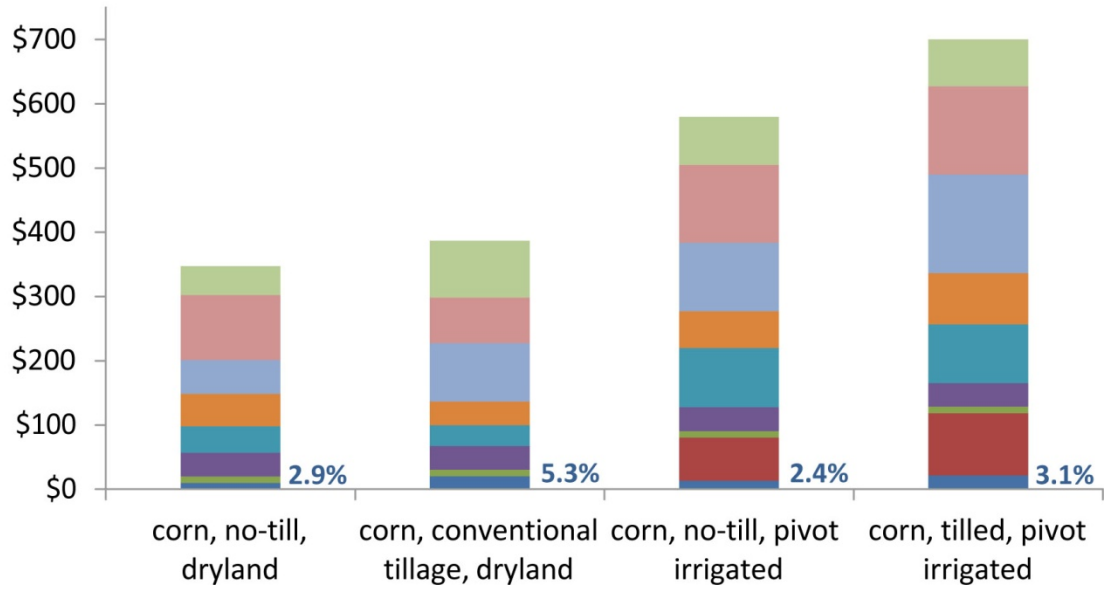
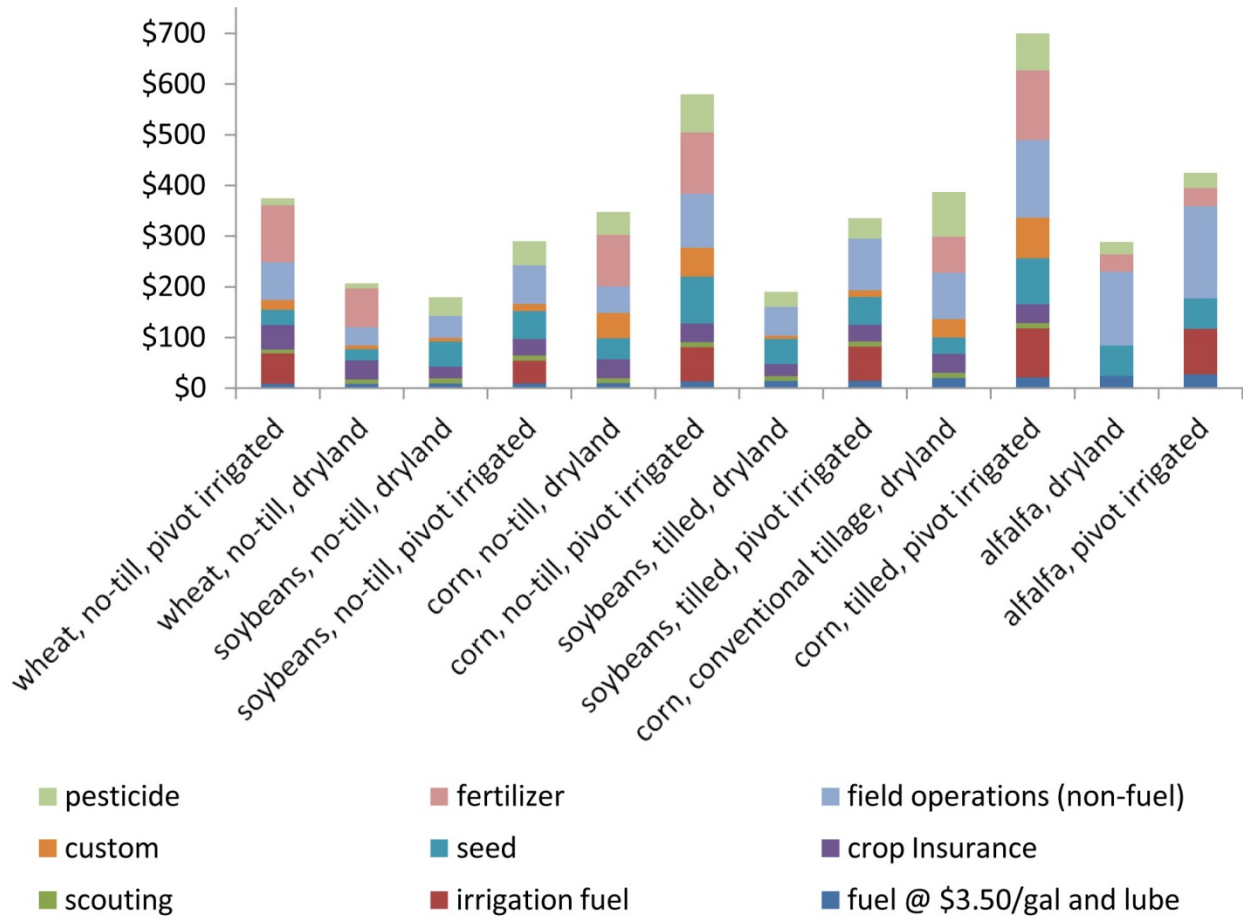

Figure 5. Cost per acre for crop inputs.<sup>4</sup> ([http://www.nass.usda.gov/Quick\\_Stats/](http://www.nass.usda.gov/Quick_Stats/))

## 2. TRACTOR DIESEL EFFICIENCY—PRIMARY FUEL USE

### 2.1 Tractor Mechanics

Although most mechanized agricultural operations include a tractor as a primary power unit, the tractor itself is not particularly useful without an implement attached. The implement has a task-specific design, which engages the soil or crop to carry out tillage, cultivation, harvest, and other operations. Most modern tractors provide power for implements via a drawbar, power take-off (PTO) shaft, and/or fluid power hydraulics. Much effort and focus has been directed at tractors because it is where the fuel is consumed to generate mechanical power. Innovations and efficiency improvements in tractor engines, powertrains, and auxiliary power systems have been ongoing since tractors were invented a century ago and significant gains have been realized.

Specific fuel consumption (horsepower hours per gallon [Hp-h/gal] or kilowatt-hours per liter [kWh/L-1] for tractors tested at the Nebraska Tractor Test Laboratory (NTTL) from 1958 to 2012 improved by 19.7% for PTO power and 23.4% for drawbar power when comparing data averaged over the last 5 years of this period versus the first 5 years of this period (Figure 6). It should be noted that trends based on NTTL data do not necessarily include all tractor models produced by industry (although for tractors sold in the United States, there would be few exceptions); and minimum tractor power requiring an official test has increased over the years to eliminate the necessity of testing small tractors not intended for use in commercial agriculture (e.g., garden tractors).

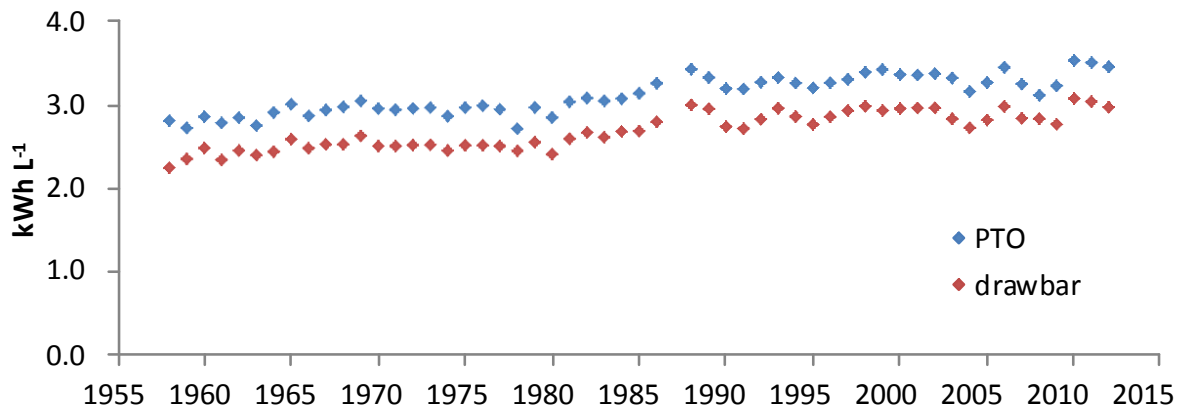

Figure 6. Annual, average, specific, volumetric fuel consumption for power take-off and drawbar power for diesel tractors (source: NTTL data).

Increased specific fuel consumption was observed in tractors with higher PTO power levels, which may be due to parasitic loads being a smaller fraction of gross power as power levels increase (Figures 7 and 8). Reasons for the overall trend in improved specific fuel consumption for PTO and drawbar operations are not well documented, but contributions include improvements in engine and powertrain efficiency, fuel systems, turbocharging, manufacturing (e.g., tighter tolerances, advanced materials, etc.), fuel and lubricants, reduction in parasitic loads (e.g., variable fans, closed center hydraulics, etc.), tire design (e.g., bias vs. radial tires), and machine setup and operation (e.g., optimal ballasting, shift-up-throttle-back, etc.). It should be noted that some high-power tractors are intended primarily for high draft drawbar applications and the PTO may be designed to transmit only a portion of available engine power; therefore, specific fuel consumption for PTO power may be skewed because it does not reflect full engine power efficiency.

Standard test procedures (such as Organization for Economic Cooperation and Development [OECD] Code 2, “Standard Code for the Official Testing of Agricultural and Forestry Tractor Performance”) are used to characterize tractor performance; however, they do not evaluate efficiency for in-field operations

where loads can vary significantly (due to differences in implement design, operator style, and crop, field, and soil characteristics) and have a combination of simultaneous power demands (e.g., drawbar, PTO, and hydraulic). An example of an engine torque curve and associated load points, as measured with OECD Code 2 procedures, along with a theoretical load distribution, is shown (Figure 9). The actual distribution of loads for typical agricultural tractor operations is not known. Idle time is thought to be 20 to 30% of tractor run time and many processes do not require sustained operation at full load. Remaining operations are a variety of partial loads that are not captured in existing test procedures. If actual load distributions were known, advanced test procedures could be developed to better evaluate loads and related efficiencies that are more representative of in-field operations.

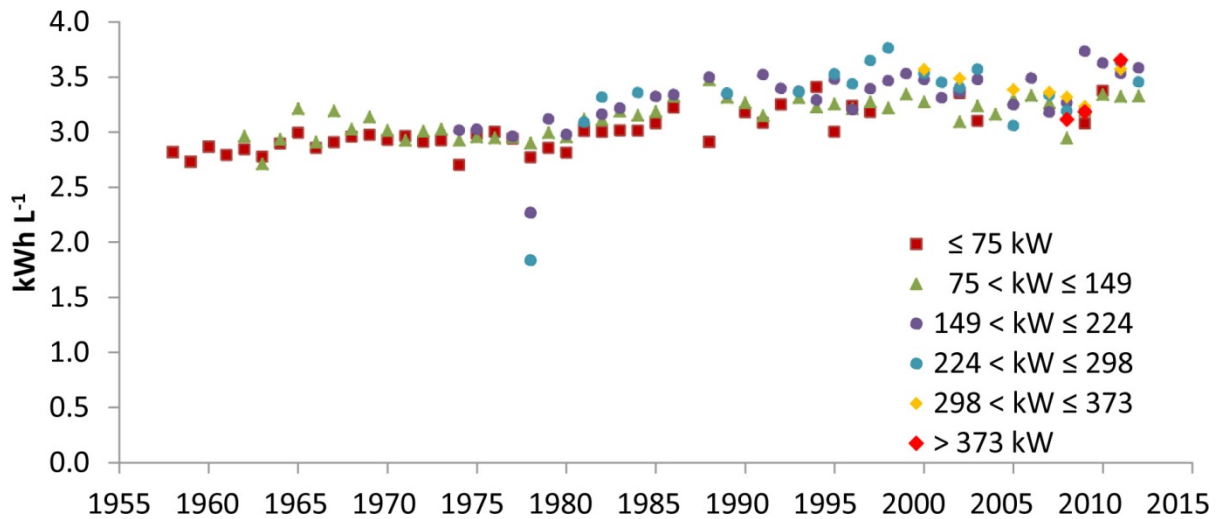

Figure 7. Annual, average, specific, volumetric fuel consumption for power take-off power by power take-off power level for diesel tractors (source: NTTL data).

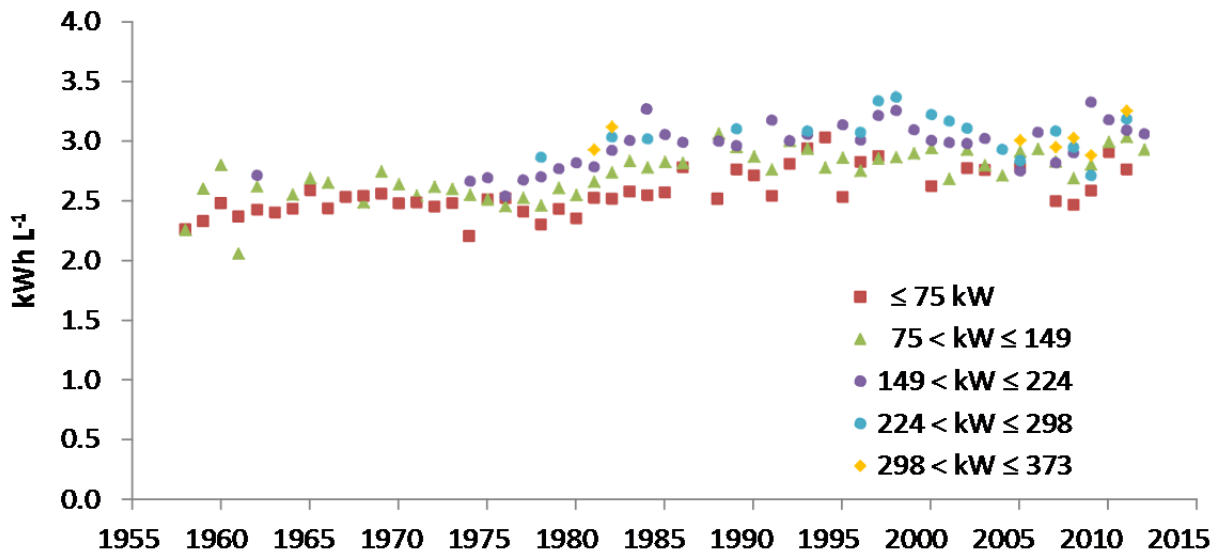

Figure 8. Annual, average, specific, volumetric fuel consumption for drawbar power by drawbar power level for diesel tractors (source: NTTL data).

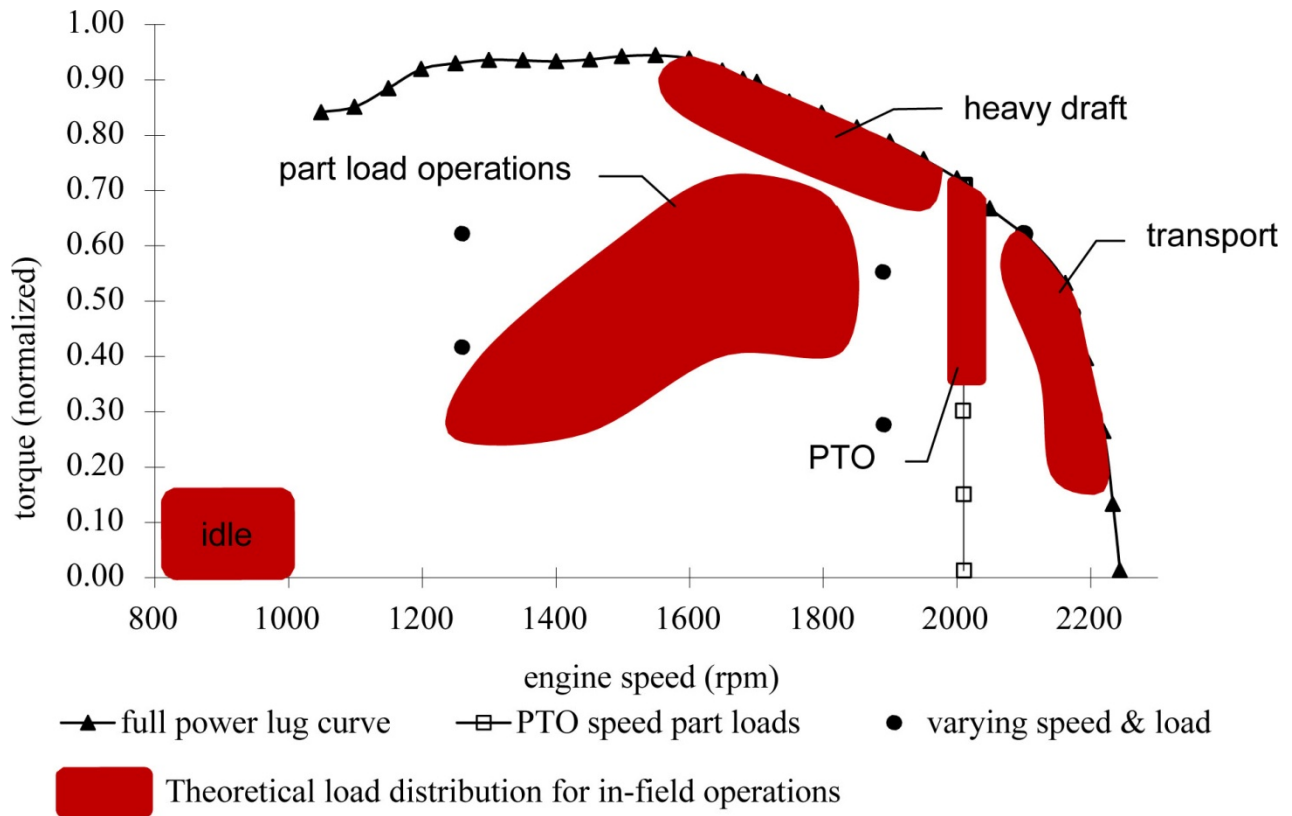

Figure 9. Discrepancy between existing performance tests (black) and probable in-field load distributions (red).

The following subsections describe the innovations still under development that are intended to further improve machine efficiency.

### 2.1.1 Engine

Nearly all modern tractors used in commercial agriculture are powered with diesel fuel. Although fuel economy is important to engine and machinery manufacturers, much effort and resources in recent years have been dedicated to meeting exhaust emissions regulations. Engine calibrations have been optimized to reduce exhaust pollutants in accordance with U.S. Environmental Protection Agency emissions tiers. This was accomplished through several means, including in-cylinder combustion optimization and exhaust gas recirculation, but did not include exhaust aftertreatment (e.g., U.S. Environmental Protection Agency Tiers 1 through 3). With the addition of exhaust aftertreatment systems for the Tier 4 interim stage, some engines require diesel exhaust fluid to catalyze pollutants in the aftertreatment system (e.g., urea), while other aftertreatment systems inject diesel fuel into the exhaust stream to regenerate a diesel particulate filter that traps particulate matter.

Some manufacturers claim as much as 5% greater fuel efficiency for their Tier 4 interim engines than that of the Tier 3 models.<sup>5,6</sup> Yet when evaluating fuel efficiency, variations in exhaust aftertreatment systems should be considered due to trade-offs between consumption of diesel and diesel exhaust fluid.

With the development of hybrid machines and electric powertrains, some manufacturers are implementing electrically powered, variable speed water pumps to reduce coolant flow, with the intent of saving energy and fuel when full coolant flow is not needed. An alternate design has been researched and demonstrated a 1.7% improvement in fuel economy for a clutched, two-speed water pump (standard drive speed and 65% of that speed) with a planet gear drive and 4% improvement in fuel economy for a

clutched on/off water pump when compared to a conventional belt-driven water pump. These designs were evaluated on a chassis dynamometer with a test vehicle using the New European Driving Cycle. While the effect of these clutched water pump designs is expected to be similar to an electric water pump with regard to improved cooling system performance, Shin et al. (2013) argues that inefficiencies in the conversion of energy between mechanical and electrical systems would hinder the efficiency of an electric water pump.<sup>7</sup>

Engines can spend a notable amount of time at idle. A report of on-highway, heavy-duty diesel engines cites a near doubling of fuel consumption for an increase from 600/750 rpm to 1,000 rpm.<sup>8</sup> Advanced engine controls are being introduced to reduce fuel consumption by lowering engine idle speeds and even shutting the engine off during extended idle periods. Examples of these strategies are cited in this report and are found in existing patent applications that show intentions of further development in these strategies.<sup>9</sup>

Some efficiency gains are the result of changes in machine set up and operation. Proper maintenance (e.g., clean filters and correct lubricants), adjustments (e.g., proper tire pressure), and ballasting (e.g., appropriate weight distribution for the conditions) affect fuel efficiency. One study suggests that maintaining clean fuel and air filters can provide an average fuel savings of slightly more than 100 gallons annually for a farm tractor.<sup>10</sup>

Cooling fans can be a significant parasitic load. Therefore, many modern tractors use variable speed or variable pitch fans that continually adjust to only provide the cooling needed and avoid unnecessary parasitic loads. However, if the radiator is not clean, the fan is not effective and coolant temperature remains high; therefore, this commands a higher fan speed. One cooling fan manufacturer reports, “A marginal increase in fan speed of 600 rpm due to a clogged radiator leads to a doubling of necessary fan drive power. If the fan drive power rises from 9.5 to 19 kW, the resulting fuel consumption increases to about 0.92 gph (3.5 liters per hour).”<sup>11</sup> Simply maintaining a clean radiator can have a direct impact on fuel consumption.

### **2.1.2 Waste Heat Recovery**

Air conditioning systems powered by waste heat from engine exhaust gas and exhaust gas recirculation coolers have been studied and are claimed to be capable of reducing fuel use and engine idling.<sup>12</sup> ClimateWell’s Verdacc heat-driven air conditioning system is advertised to be available for new vehicle designs and retrofit for existing vehicles. According to their claims, this technology “makes it possible to reduce fuel cost used for cabin comfort by up to 90%.”<sup>13</sup>

A patent filing exists regarding a device for recovering energy from an engine’s exhaust stream with an electric machine that may consist of a generator or motor/generator that may be part of a turbo charger. The recovered energy may be stored for later use or used directly to power the engine or machine functions, therefore improving the overall fuel efficiency of the system.<sup>14</sup>

Behr has demonstrated a prototype waste heat recovery system that showed up to 5.2% efficiency improvement on a test rig. Their system (shown schematically in Figure 10) is conceptually similar to a small steam engine that converts thermal energy from engine exhaust into mechanical power that can be used directly or stored for later use. Efficiency gains were highest for the steady-state portion of their long-haul truck test cycle.<sup>15</sup> For agricultural operations, these energy recovery and efficiency gains for steady-state operation may lend themselves to applications such as tillage with sustained heavy draft loads.

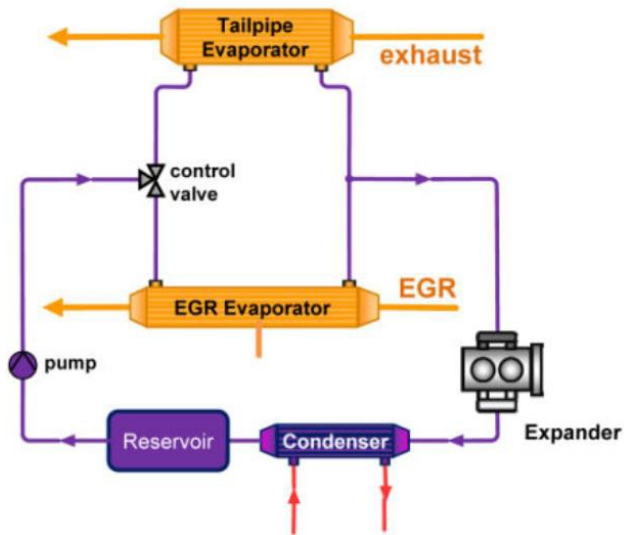

Figure 10. Prototype waste heat recovery system developed by Behr.<sup>15</sup>

### 2.1.3 Powertrain

Traditional discrete gear transmissions provide a number of manually selected gears for low-speed, high-draft field operations and for high-speed, low-load transport operations. While these transmissions provide an adequate range of operation for typical farm activities, their manual operation and sometimes large step ratios can force the engine to be operated at suboptimal speeds with respect to efficiency.

Shift-up-throttle-back operation is known as an effective way to improve fuel efficiency. Procedures used by NTTL (based on OECD Code 2) include a reduced engine speed sequence at various drawbar loads that demonstrates the benefits of shift-up-throttle-back operation. For a load case of 75% pull at maximum drawbar power, shift-up-throttle-back operation typically results in 5 to 15% reduction in fuel consumption, while still producing the same drawbar power. For a load case of 50% pull at maximum drawbar power, shift-up-throttle-back operation typically results in 15 to 30% reduction in fuel consumption, while still producing the same drawbar power.<sup>16</sup> Even though the benefit of shift-up-throttle-back operation is clear, it can be difficult for an operator to manage the throttle setting and gear selection for constantly changing loads during field operations.

As powertrain designs evolve, additional gears with smaller step ratios have been added to transmissions to narrow the required engine operating range. By properly matching the engine and powertrain, and with the aid of advanced controls, the engine can operate in a relatively narrow range at what is most efficient.

Many transmissions require pressurized oil for clutch actuation and lubrication. Although the minimum required oil pressure may be different for each set of clutches that are actuated and for the torque being transmitted at a given time, transmission oil systems often maintain the constant pressure required for worst-case loads. A portion of this oil may be directed through a pressure-reducing valve to lower the pressure for lubrication. Energy required to pressurize the portion of flow used for the low-pressure lubrication circuit may be converted to heat as the pressure is reduced. Additional energy may be lost if the cooling fan has to run faster to reject this additional heat from the cooling package. Some manufacturers have separated these circuits to avoid pressure drop and associated energy loss for the lubrication flow.<sup>17</sup> A patent exists for a strategy to regulate transmission charge pressure in order to reduce pressure when it is not needed; for example, regulating to high pressure for transport and regulating to low pressure for stationary operations when transmission clutches are not engaged.<sup>18</sup>



John Deere's 24-speed, dual-clutch transmission offered on their 6R series of tractors is expected to provide a "4 percent cut in fuel" or a savings of up to 10 grams of diesel per kWh compared to an infinitely variable transmission.<sup>19,20</sup> Although manual mode that allows the operator to select the desired gear is available, it is the enhanced controls of the automatic mode that leads to efficiency optimization. In automatic mode, the machine optimizes efficiency by selecting the appropriate gear to keep the engine in an efficient operating range for the desired speed and load.<sup>20</sup> John Deere is also implementing their e23 transmission on their 7R and 8R series tractors with 23 forward and 11 reverse speeds. Much like the 24-speed transmission described above, the e23 also offers a control feature that manages the transmission for best fuel economy by automatically shifting up and throttling back, while maintaining an operator-selected ground speed.<sup>21</sup>

As more gear ratios are added to the transmission and step ratios become smaller, the opportunity to maintain operation at peak engine efficiency can grow. This concept leads to the evolution of a step-less transmission with an infinite number of ratios. Infinitely or continuously variable transmissions (CVTs) allow the engine to work in a narrow, yet highly efficient, operating range, while still providing an adequate full range of speed and torque to the powertrain. A number of CVTs have been marketed and manufacturers are claiming notable fuel savings. Although mechanical transmission of power is more efficient, it is the continuous variable characteristic of hydraulic and electric powertrains and advanced and integrated engine controls that lead to overall improved system efficiency.

Several manufacturers have developed hydro-mechanical CVTs. A study by Howard has shown that for partial load conditions (i.e., loads below 76 to 81% of maximum drawbar power at respective speeds), a CVT was more fuel efficient than a discrete gear transmission operated at full throttle; however, it was less efficient for loads near maximum power. When a shift-up-throttle-back strategy was used, the gear transmission had significantly lower fuel consumption at power levels 37 to 52% of maximum drawbar power at respective speeds. Howard's study indicated that, in general, the CVT was more efficient than the full throttle operation of the gear transmission, but the gear transmission with shift-up-throttle-back operation was more efficient than CVT in the load and speed range tested. The gear transmission is inherently more efficient at transmitting power because it lacks certain parasitic losses that accompany the CVT; however, at the system and machine level, the CVT and system level controls can achieve efficiency improvements for some load conditions.<sup>22</sup>

CNH claims their Puma series tractor can achieve as much as a 25% reduction in fuel use when equipped with a CVT transmission and diesel saver auto productivity management. This integrated control system maintains an operator-selected working speed at the most efficient operating points by automatically adjusting the engine and transmission.<sup>23</sup>

Machine controls react to external loads, but cannot anticipate future loads. By the time an engine or powertrain system reacts to a load, the event may have passed and a new condition is present that requires the machine to operate in a different way for optimum efficiency and performance. In the future, global positioning system (GPS) technology may play a role in advanced powertrain controls for improved efficiency and performance. A patent for control of vehicular systems based on geo-referenced maps gives consideration to the idea that using geo-referenced data to anticipate operating conditions can improve efficiency and performance for tractors, combine harvesters, sprayers, and other agricultural machinery by preemptively adjusting transmission ratio, differential locks, and other machine settings prior to changes in slopes, crop conditions, and soil conditions. This concept also may be applied to hybrid systems where, for example, energy storage could be managed in anticipation of an upcoming downhill slope; energy currently stored can be used up prior to reaching the start of the downhill slope to free up storage capacity for energy that can be recovered while traveling down the slope.<sup>24</sup>

The following paragraphs discuss modern examples of electric CVTs.

The Belarus 3023 (Figure 11) tractor's electro-mechanical drivetrain, with a 300-hp engine powering a 220-kW generator, is claimed to have fuel consumption reduction of 15 to 20%.<sup>25</sup> Optional equipment



includes an electric cooling fan for the radiator, an electromechanical front PTO shaft that can operate at speeds independent of engine speed, and an autonomous electric power station for 172.5 kW of auxiliary power.<sup>26</sup>



Figure 11. Belarus 3023 tractor with electro-mechanical powertrain.<sup>27</sup>

The Rigitrac EWD120 tractor (Figure 12) (a project of the Technical University of Dresden and supported by Rigitrac Traktorenbau AG and other companies) includes independent electric wheel motors powered by a diesel-engine-driven generator. This generator can also provide electric power for external implements. Because of the CVT characteristic of the electric powertrain, the diesel engine always works in its “best fuel consumption map” and prototype documentation states that “the electric drive system has a higher efficiency than the conventional drivelines.”<sup>28</sup> Electric brakes and braking resistors allow braking energy to be converted to “useful heat” (however, no description is provided on how this recovered energy is utilized).<sup>29</sup> No advertised claims regarding improvements in fuel efficiency have been found, although one source stated “the transmission runs at 85% efficiency, compared with the 65 to 70% of the hydrostatic units used on Rigitrac’s standard machines.”<sup>30</sup>



Figure 12. Rigitrac EWD120 tractor with electric powertrain.<sup>28</sup>

An electric hybrid powertrain, called the ZF TERRA+, was developed by ZF Friedrichshafen AG for agricultural tractors and self-propelled harvesters (Figure 13). A starter generator module integrated into the transmission provides electric energy for auxiliary functions and implements.<sup>31</sup> With the addition of a battery, the ZF TERRA+ can become a hybrid system able to recover braking energy, provide short-term engine load relief, and allow the engine to work in a more efficient operating range; this system includes

an electric transmission-oil pump. This company claims that when used in a tractor “the optimum operation of electrified auxiliaries can achieve consumption benefits of about 5% on the average.”<sup>32</sup> According to ZF, the ZF TERRA+ can be used to power electric drives on implements with improved efficiency and has up to 10% more power available when compared to conventional hydraulic drives.<sup>33</sup>

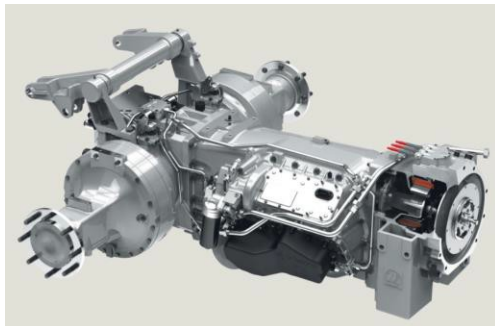

Figure 13. ZF TERRA+ starter generator in combination with the continuously variable S-Matic transaxle.<sup>34</sup>

A patent application for a “Tractor with Hybrid Power System” outlines a concept for a diesel-over-electric powertrain that includes energy recovery with battery storage. The concept also includes provisions for electrically powered variable speed PTO and an electrically powered hydraulic pump. The patent application stated that simulations of this hybrid system show 5 to 20% fuel savings, depending on the type of implement used with the tractor.<sup>35</sup>

AGCO has developed a prototype, electrically powered, high-clearance sprayer that is claimed to deliver 35% more power to the ground than its conventional counterpart with the same engine. AGCO says the experimental ElectrRoGator1386 electric sprayer (Figure 14) has 36% higher torque, 6% more power, 20% better fuel efficiency, and better performance than their conventional 1386 sprayer. On the prototype, braking energy is dissipated as heat through resistor grids, but work is being done to recover and store this energy for use by other machine functions. AGCO indicates that combine harvesters also are good candidates for electric drive technology because they can benefit from the improved efficiency and independent control of multiple machine functions.<sup>36</sup>



Figure 14. AGCO ElectrRoGator 1386.<sup>36</sup>

Electric and hybrid powertrains have been developed for several models of off-road industrial and construction equipment introduced for sale. Equipment types include crawler dozers, wheeled loaders, and excavators.

Caterpillar’s D7E, a crawler dozer, introduced for sale in 2009, has a diesel-over-electric drivetrain for primary propulsion and electric accessories, including the AC compressor and water pump. Fuel

savings of 10 to 30% are being advertised, with some customers reporting larger savings in certain applications. Advertised claims also include 25% more material moved per liter of fuel. Fuel use can be reduced further on machines configured with an engine idle shutdown timer that can shut the engine off after a predetermined period of time at idle.<sup>37</sup>

John Deere is marketing a 644K hybrid electric wheeled loader with claims of up to 25% average reduction in fuel consumption (based on Deere's internal tests, including stockpiling, truck loading, and transport).<sup>38</sup> Although this machine does not have energy storage capability, the diesel-over-electric powertrain is capable of recovering energy that can reduce engine load and fuel consumption.<sup>39</sup>

Komatsu's H205-1 hybrid excavator is claimed to have fuel savings of 25 to 41%. Kinetic energy is captured during braking and is stored in an ultra-capacitor to be used for power assistance during the next machine cycle. Komatsu's literature suggests that the success of their hybrid system is due, in part, to the ability of ultra-capacitors to charge and discharge quickly for the high energy demand of the excavator, whereas battery storage would be too slow to be effective for this application.<sup>40</sup> In addition, Hyundai reportedly has been working with ultra-capacitors for hybrid excavator designs.<sup>41</sup>

Ricardo has developed a hybrid excavator demonstrator to show the benefits of their flywheel energy storage system and is claiming "10% fuel savings overall, with 30% fuel savings in some duty cycles." The composite flywheel, rotating at 60,000 rpm in a vacuum, can store 0.25 kW-h and deliver up to 28 Nm of torque. Ricardo is developing other flywheel storage models up to 1.25 kW-h. With 65% lower cost than battery hybrid systems and still delivering 80% of the fuel economy, the flywheel hybrid system may be a good fit for machines with low volume production.<sup>41</sup>

Caterpillar claims its 336E H hydraulic hybrid excavator uses up to 25% less fuel than a standard 336E, with up to 50% greater efficiency in terms of ton of material moved per gallon of fuel.<sup>42</sup> The hydraulic hybrid design captures braking energy in hydraulic accumulators that is used to accelerate the machine in subsequent machine cycles. In addition to the hydraulic hybrid design, contributions to fuel savings also come from advanced engine controls, including engine idle shutdown and on-demand engine power that reduces engine speed when less power is needed.<sup>43</sup>

A characteristic shared by these machines, which makes them good candidates for hybrid drive and energy recovery systems, is that they are cycling machines, meaning segments of their typical work cycle involve dissipation of kinetic energy during direction changes, braking/deceleration, lowering of implements, etc., to stage the machine for the next work cycle. Many agricultural field operations (e.g., tillage, planting, and harvesting) are primarily steady state with infrequent cycles; therefore, they have limited opportunity to recover kinetic energy. However, there may be potential for energy recovery strategies during braking/deceleration events for self-propelled chemical applicators or tractors used for transporting material.

#### **2.1.4 Remote Power (Hydraulic, Mechanical, Electric)**

Early tractors were essentially mechanical replacements for horses with the primary purpose of providing drawbar power to pull implements through the field. As tractors and other farm machinery evolved, tractors took on additional capabilities to provide other types of power and controls for implements. Early belt drives were eventually replaced with a PTO shaft. A PTO consists of a rotating shaft to transmit mechanical power from the tractor to the implement at a standard speed of 540 rpm or 1,000 rpm. Generally, PTOs operate at a fixed ratio of engine speed, although some modern tractors include an economy PTO mode that allows PTO operation at a reduced (but still fixed ratio of) engine speed for improved fuel efficiency. For example, PTO tests for a John Deere 5115M show fuel efficiency improvement of 7 to 24%, depending on load, when the PTO is operated on economy mode (i.e., 540 rpm PTO speed at 1,645 rpm engine speed) versus normal mode (i.e., 540 rpm PTO speed at 2,100 rpm engine speed).<sup>44</sup>

Patents exist for variable speed PTO drives that can provide constant speed PTO at reduced or varying engine speeds. The variable speed concept allows for shift-up-throttle-back transmission operation while still maintaining constant PTO speed and also enables controlling PTO speed as a ratio of ground speed, which may improve the efficiency of certain PTO-driven implement operations. If the tractor configuration is such that the hydraulic pump drives are downstream of the variable PTO drive, this can enable the tractor's hydraulic pump(s) to be driven at constant speed regardless of engine speed, therefore maintaining hydraulic system performance at reduced engine speed.<sup>45</sup> Another patent application describes the potential to use a similar variable speed PTO system; in this case, the PTO speed may be defined by GPS mapping and/or feedback from implements via ISO-bus with the goal of improving tractor and implement performance and efficiency.<sup>46</sup> Although PTOs have high power density and efficient mechanical power transfer, the rigid nature of the mechanical PTO shafts can also be difficult to package in new implement designs.

Hydraulic systems were later added to tractors to control basic implement functions (such as raising and lowering implements) and rotary power for functions (such as fans, augers, etc). Early hydraulic systems were quite simple, with fixed displacement pumps that operated a single function. As mobile fluid power systems evolved, they increased in complexity and also in capability and efficiency, with the ability to control multiple functions simultaneously at variable pressure and flow. Modern pressure and flow compensated hydraulics have high power density and variable control for multiple functions. A modern implement may have many hydraulic functions with simultaneous fluid power demands. A planter, for example, may have hydraulic functions for raising/lowering, folding for transport, folding markers, row unit down-pressure, vacuum fan motors, and fluid pumps.

A study by Oak Ridge National Laboratory and the National Fluid Power Association concluded that across all industry sectors (of which agriculture is the second largest segment comprising 21.2% of total fluid power component sales), fluid power system efficiencies range from less than 9% to as high as 60%, with an average efficiency of 22%. Considering cumulative losses (including the transfer of power from the engine to the hydraulic pump, pump efficiency, line losses, valve losses, etc.), typical mobile hydraulic systems have an overall efficiency of approximately 14% (Figure 15).<sup>47</sup>

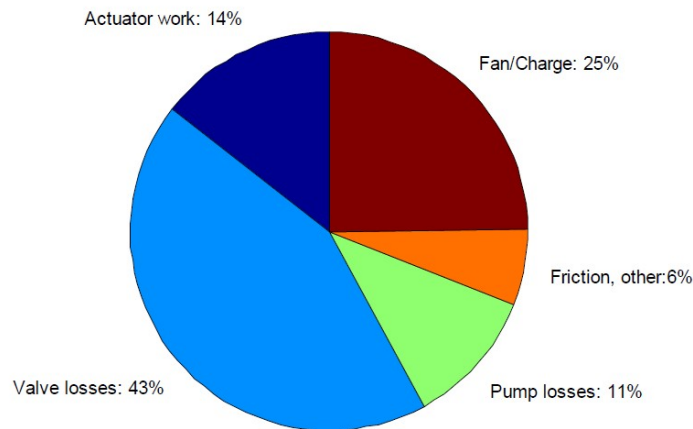

Figure 15. Energy losses in mobile load sensing hydraulic application.<sup>47</sup>

Typical modern hydraulic systems for mobile equipment have one or more hydraulically controlled variable displacement pumps to meet the demand of combined flow for all actuators in the system and the pressure demanded by the function requiring the highest pressure. While this satisfies requirements of the function with the highest pressure demand, pressure for other functions has to be reduced to a level required for each respective load. Reduction of pressure occurs when the fluid is throttled through control valves, which achieves the desired result of providing pressure and flow appropriate for each function. However, with the exception of the function operating at highest pressure, large energy losses occur due

to the pressure drop for the remaining loads (illustrated in Figure 16). Energy is lost as heat, which can drive additional energy consumption from a cooling fan if this heat is dissipated through the machine's cooling system. Additionally, this hydraulic system configuration does not lend itself to effective energy recovery schemes, such as recovering kinetic energy from braking or recovering potential energy as actuators are lowered.<sup>48</sup>

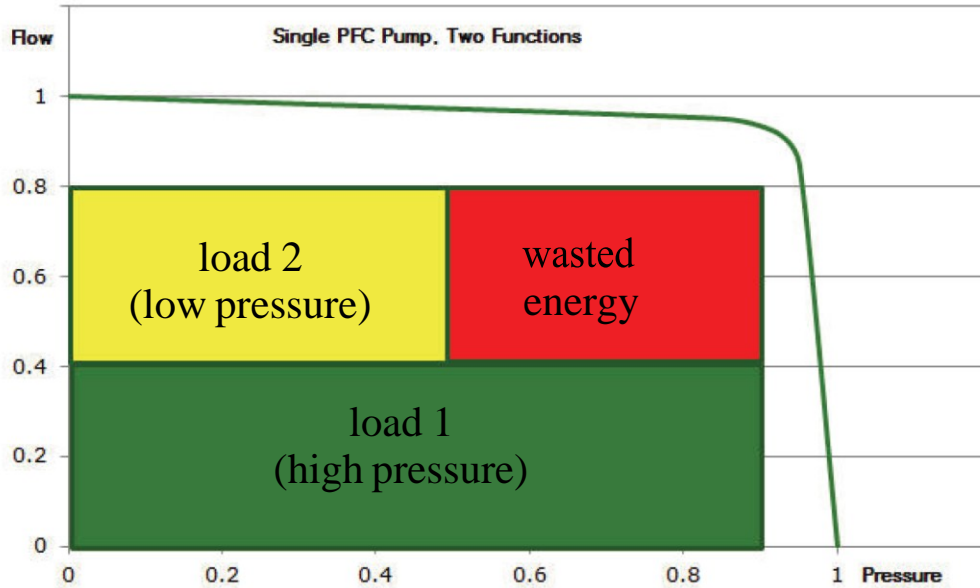

Figure 16. Pressure flow curve, single pump, dual function.<sup>51</sup>

Research at Purdue University's Maha Fluid Power Center includes work on high-efficiency mobile hydraulics. Significant fuel savings have been demonstrated on a hydraulic test bed machine that is being used to study throttle-less hydraulic actuation. Meter-less flow architecture allows flow from several smaller pumps to be paired with each individual actuator, thus eliminating the main control valve, which is the location of greatest energy loss (Figure 15). The only control element is the pump displacement. The unit automatically moves over-center to allow energy recovery. With this technology, hydraulic control valves are eliminated and control is achieved with displacement control or pump-controlled actuation instead. This technology is expected to provide fuel savings for multi-actuator machines used widely in construction, agricultural, and forestry industries, with significant fuel savings already demonstrated on the test bed. Additional work is planned for a hydraulic hybrid configuration with a goal of 50% fuel savings with no degradation of performance. This hydraulic actuation technology has been demonstrated on a wheel loader, where measurements showed 20% higher fuel efficiency. Independent side-by-side testing at a Caterpillar facility demonstrated 40% fuel savings over the standard machine.<sup>48</sup>

The digital displacement pump is another fluid power technology that shows promise for improving hydraulic system efficiency, especially for part load conditions. A developer of this technology is claiming that replacing proportional valves and load sensing pumps in traditional fluid power systems with this digital displacement technology can provide double digit energy savings for off-road vehicles.<sup>49</sup>

Hydraulic transformers for use with common pressure rail hydraulic systems also are under development with the hopes of overcoming inefficiencies of the current state-of-the-art load sensing systems and metering valves. This concept eliminates the throttling losses of metering valves and is expected to have higher efficiency at part load than that of a load sensing pump. Market readiness of this concept and its efficiency are not known.<sup>50</sup>



Although PTO and hydraulic power systems are well established and effective for today's applications, the search for more versatile and efficient power transfer continues. One alternative is electric power, which first debuted in 1954 on the Farmall Electrall tractor. The IH Farmall 450 had an integrated electric power generator that provided up to 10 kW of electric power for implements. Limited, in part, by availability of adequate electrical controls, the technology was not adopted at that time.<sup>51</sup>

A recent source suggests electric drives would be suitable and beneficial for 28 drives on modern agricultural machines, 45% of which currently use hydraulic power and 55% which are mechanically driven.<sup>52</sup> Electric power enables variable speeds control; therefore, functions can operate independently of engine speed and use only the power and energy needed for the given function. This tends to be more efficient than power transmission via a PTO shaft or hydraulics. Tractor accessories that can be electrically powered include the engine cooling fan, the air brake compressor, the air conditioner compressor, the engine water pump, and hydraulic pumps. The alternator and starter can be eliminated in some cases if onboard electric power is available from a starter generator.<sup>53</sup> ISOBUS, a communication protocol for controller networks on agricultural machinery, is a key enabler for advanced controls that take advantage of torque and speed control capabilities of these electric systems. ISOBUS can be for control of tractor-mounted accessories or communication and control between tractors and implements.

According to ZF, the ZF TERRA+ starter generator (described above) can be used to power electric drives on implements (shown schematically in Figure 17) with improved efficiency and up to 10% more power available when compared to conventional hydraulic drives. ZF also offers a 50-kW, PTO-driven generator as a retrofit to provide electric power for implements. This unit can provide various voltage output configurations for independent control of two 25-kW electric drives.<sup>33</sup>

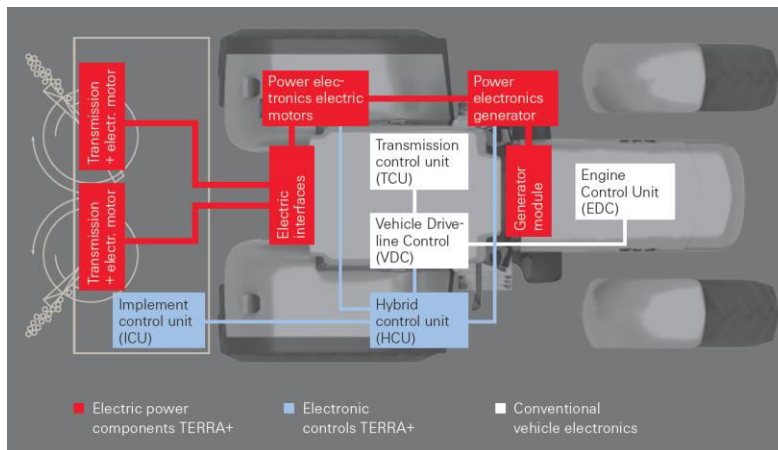

Figure 17. ZF TERRA+ electrification schematic.<sup>31</sup>

John Deere also has a design for mobile electric power, with two 7030E premium series tractors introduced in 2007 and another in 2011, the 6210RE, all of which are intended for the European market at this time. This is a more efficient alternative to PTO or hydraulic power transfer and can offer electric power for implements. The tractor can include outlets to power electric tools and other devices. Adoption of these tractors has been limited, in part, by the lack of availability of electrically powered implements. Another barrier to further implementation of electrically powered farm implements has been standardization of generator/implement voltage and electric connections for the tractor-implement interface. This is being evaluated by the Agricultural Industry Electronics Foundation, who is working to establish engineering standards for electrical components on farm equipment.<sup>54</sup> Replacing hydraulics with electric systems could displace petroleum-based fluid used in fluid power systems; however, power density for typical hydraulic systems ( $W/kg$  and  $W/m^3$ ) can be more than an order of magnitude greater than that of electric systems, making it difficult to transition to larger and heavier electric components needed to deliver the same performance.<sup>47</sup> “A comparison test with a John Deere 7530 Premium showed

that the 7530 E-Premium produced fuel savings of up to 13.8 percent when pulling a power harrow and 9.3 percent when pulling a trailer. In a DLG-PowerMix test, the 7530 E- Premium saved up to 5 percent compared to conventional tractors, including John Deere 7530 Premium, Deutz-Fahr Agrottron M 640, Fendt 820 Vario TMS, Case IH Puma 180, and New Holland T7040.”<sup>55</sup>

Fendt developed a concept tractor built from their 700 Series model that includes a 130-kW generator to power auxiliary functions on the tractor and provide electric power for implements.<sup>56</sup> The Fendt concept uses DC voltage, while John Deere is using AC power for implements. Standardization of electric power for implements will be important to getting this technology to market and to having compatibility with third party implement designs. A number of implement manufacturers have been investigating electrification of implements to improve efficiency and productivity. Like electrified tractors, electrified implements have been primarily developed in the European market. A survey of Austrian manufacturers showed the following characteristics for electric drives:<sup>52</sup>

<u>Advantages:</u>	<u>Disadvantages:</u>
Controllability	High mass
Easy torque and speed measurement	Space requirements
Possibility for fault finding	Cost efficient standard components currently not available
Ease of distribution of power	Robustness
High efficiency	Safety requirements
Overload capability	Interface problems
Low noise level	Storage technology

Fliegl Agrartechnik GmbH is touting electrically powered axles on trailers as a way of improving material handling/transport efficiency (as shown in Figure 18). Because of the design complexities and lack of adequate controls to adjust trailer ground speed to match that of the tractor, mechanical PTO power transfer to drive trailer axles has not been practical. Although these obstacles can be overcome with hydraulic power, it is a low efficiency alternative. Electrically driven trailer axles are easier to implement and are becoming practical with the introduction of power generators on tractors. This manufacturer claims that an electric system would be 65 to 75% efficient, compared to the 25 to 55% efficiency of a hydraulic system. Powered axles on trailers can allow a smaller tractor to transport a greater amount of weight, enabling the reduction of tractor ballast, which means energy is not expended in carrying an unproductive mass of ballast.<sup>57</sup>



Figure 18. Trailer with electrically powered traction axle.<sup>57</sup>

Kinze’s 4900 planter is available with electrically driven seed and insecticide metering for high-accuracy variable rate application of crop inputs. Other conventional drive options include hydraulic

or ground drive configurations.<sup>58</sup> The electric drive configuration is powered by a hydraulically driven generator mounted on the planter.<sup>59</sup> Although no claims were found regarding reduction in fuel use or improved efficiency, this is an example of the electrification of implements in the North American market, which currently does not offer tractors with onboard electric power. Kverneland Group (Norway) also has developed a variable rate precision seed drill, where each planting unit is controlled independently with electric motors.<sup>60</sup> Graham Equipment has developed an Electric Planter Drive kit to retrofit existing planters.<sup>61</sup>

Amazone has developed electric drives for precision seeding and a fully electric chemical applicator (Figure 19). Each major function on the UX eSpray trailed sprayer is powered independently with electric motors. Independent, fully variable control allows each function to be operated at optimum speed and load for the given conditions without being tied to tractor engine speed.<sup>62</sup>

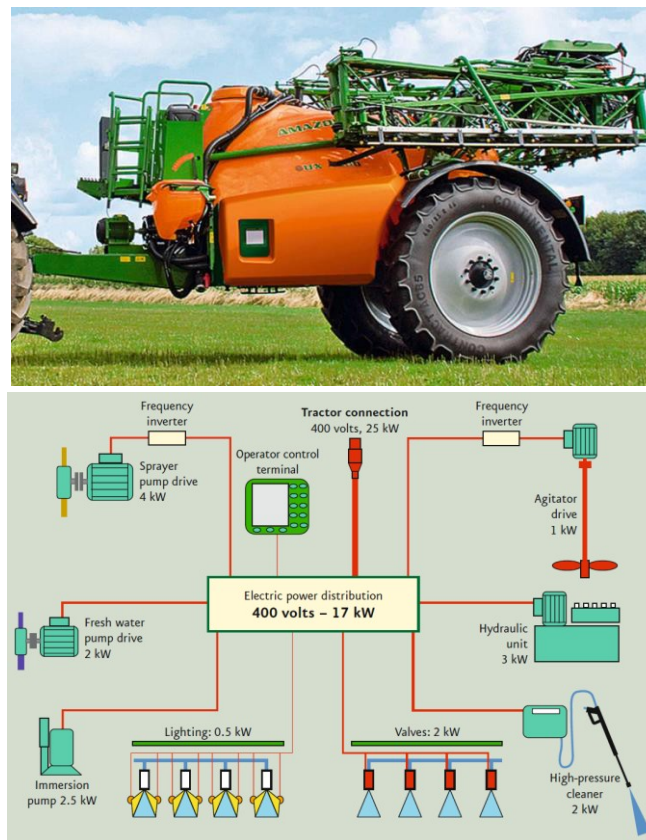

Figure 19. Electric pump drive (top) and UX eSpray components schematic (bottom).<sup>62</sup>

The “axis” spreader showed that an electric drive configuration was most efficient and had the best tractor/implement fuel economy when compared to two hydraulic drive configurations and one mechanical drive configuration on this same model spreader.<sup>64</sup>

One source reports that Claas is investigating the use of electric drives for self-propelled forage harvesters and combine harvesters.<sup>65</sup> Patent filings by other parties further indicate investigation of agricultural machinery electrification. A patent for an electrically powered hay baler claims energy savings by optimizing machine functions for crop conditions (Figure 20).<sup>66</sup> A patent exists for a combine harvester with integrated electric motors powering grain threshing and conveying functions, as well as drive wheels, but makes no claims on efficiency gains (Figure 21).<sup>67</sup>



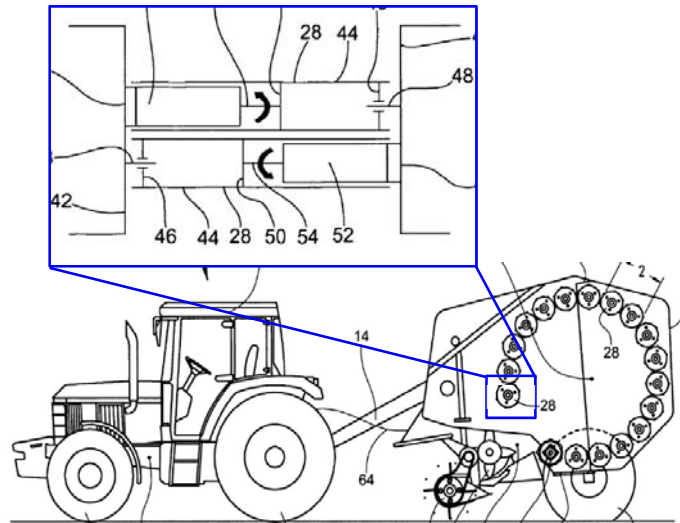

Figure 20. John Deere patent for round baler with electrically driven roller.<sup>66</sup>

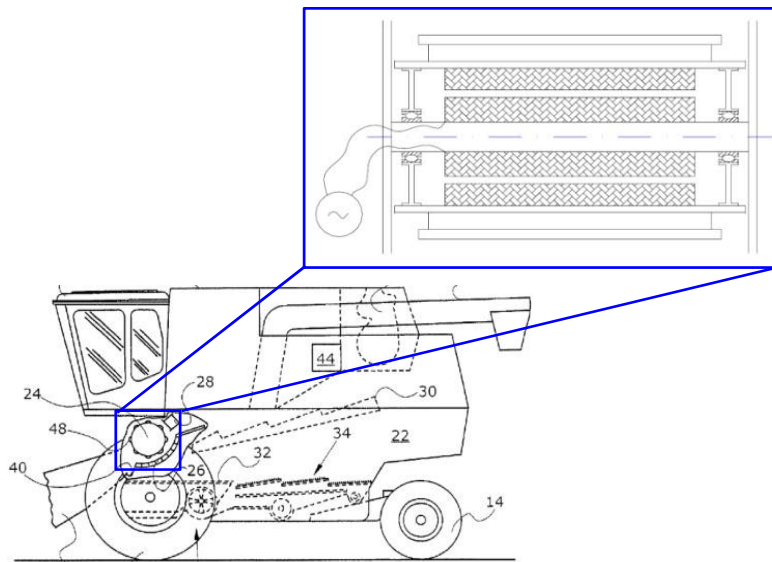

Figure 21. John Deere patent for electrically driven threshing cylinder.<sup>67</sup>

Electrification of implements has the potential for energy savings through more efficient power transfer and savings from the precision agriculture perspective through more efficient and effective application of seed and chemicals. Parallel development of electrified tractors and implements, along with standardization of electric power protocols and hardware, will be key to further development of electrification of mobile agricultural equipment.<sup>64</sup>

### 2.1.5 Tires and Tire Pressure

Since their first use on agricultural tractors in the 1930s, pneumatic tires have demonstrated significant benefits over steel wheels. A 1934 evaluation of steel wheels versus pneumatic tires on a WC Allis-Chalmers tractor showed a 45% fuel economy advantage for the rubber tires. Since that time, pneumatic tires have become the dominant traction device for agricultural tractors and implements. Early bias ply tires have been replaced in many applications with more efficient radial tires, with one source indicating radial tires have a 6 to 14% advantage in traction, fuel efficiency, and reduced wheel slippage over bias ply tires.<sup>68</sup>

Improvements in tire performance continue to be realized as tire technology evolves. Michelin is indicating up to 25% fuel saving for their new Ultraflex technology agricultural tires that operate at lower than standard pressures<sup>69</sup> (although the baseline for this comparison is not clear). Firestone is indicating as much as 4% fuel savings for tractor tires with their AD2 Advanced Deflection Design compared to standard equivalent-size radial tires.<sup>70</sup>

While tractors are primarily designed to operate off-road, ground conditions vary significantly. A tractor set up for optimum performance for tillage in sandy soil may have reduced efficiency when pulling a chemical applicator in heavy clay soils. Two variables on the tractor that affect this performance are tire pressure and ballast. Both parameters have been studied and show there is no single setting for all conditions. For example, proper ballast is achieved when the tractor has approximately 10% wheel slip when working on soil. Optimum ballast configuration changes as soil conditions and implement loads change. Performance related to tire pressure is similar, optimum tire pressure for one set of conditions is inefficient for others.

A field demonstration showed an 8% average fuel savings for a four-wheel-drive tractor when operating with recommended tire pressures versus overinflated tires. A mechanical front-wheel-drive tractor showed an 11% improvement in field capacity and 26% improvement in fuel efficiency using tire pressure recommendations when compared to overinflated tires. Although this field demonstration was not a scientific study, it clearly indicates potential fuel savings with proper tire pressure. An on-farm study, with self-reported data from four four-wheel-drive tractors doing fall tillage, showed 5.3 to 10.3% improvement in fuel efficiency for properly inflated tires versus overinflated tires.<sup>71</sup>

The effects of tire inflation pressure were studied for a tractor towing a trailer on paved roads. The test was repeated at several load levels with three different tire inflation pressures, each of which was within the recommended inflation pressure range indicated in the tractor operator's manual. Results clearly showed the benefits of having the correct tire pressure for the operating conditions, with up to 11.4% improvement in fuel economy (miles per gallon in this case) for the highest inflation pressure when compared to the lowest inflation pressure.<sup>72</sup> The scope of this study included only transport operations on paved roads; therefore, it did not have data showing the likely benefits of low inflation pressures for off-road farm operations.

A central tire inflation system marketed by Spicer claims to improve fuel efficiency by up to 3.3% and to increase tire life by up to 10%.<sup>73</sup> This system includes an on-board air compressor and pneumatic control unit to allow the operator to increase tire pressure for travel on hard surface roads and decrease tire pressure for work in softer soils.

Fendt is offering a factory-installed tire pressure regulating system on their 900 Vario series of tractors with claims of up to a 10% fuel savings. The system is also capable of adjusting tire pressure on the tractor and towed implements. Fendt indicates the system is capable of increasing tire pressure by one bar (14.5 psi) in 10 minutes and reducing by one bar (14.5 psi) in 2 minutes via command from an electronic operator interface in the cab.<sup>74</sup>

Patents for central tire inflation systems owned by major industry original equipment manufacturers (OEMs) indicate interest in these systems for series production. Existing patents include systems not only for tires on tractors and prime movers, but also for implements where inflation pressure may be managed based on predetermined soil maps and GPS position real-time or closed-loop control based on soil characteristics or dynamic axle loads measured in real-time.<sup>75</sup> Patents include combine harvesters where gross machine mass and tire loads change during operation as harvested material is accumulated in an onboard storage bin or with different headers.<sup>76</sup> This principle also could apply to chemical applicators where gross machine weight changes as the payload is dispersed.

Literature reviewed regarding central tire inflation systems suggested that, in addition to reduced fuel use and longer tire life, other benefits include increased crop production as a result of reduced soil

compaction, increased traction/reduced slippage, improved operator comfort, and improved stability when driving on hard surface roads.

A patent filing exists for a concept involving dynamically changing a vehicle's footprint during operation (described as a virtual-foot or v-foot). Similar to the central tire inflation systems, claimed benefits include improving fuel efficiency by reducing rolling resistance and reduced soil compaction by increasing ground contact area, but also improved stability. However, in this case, the premise is to change the shape of the ground contact patch by one of several means, including changing the shape, stiffness, volume, or other properties of wheels, tracks, or tires by using polymers, magneto-rheological or electro-rheological materials; changing gas pressure; changing a circular wheel into a generally triangular track; or changing the width of the ground-contacting elements. The virtual-foot concept can include closed loop control, based on geographic zones with desired vehicle characteristics based on topography or soil characteristics.<sup>77</sup> Although improved fuel efficiency is claimed, this claim is not quantified.

Galileo Wheel Ltd. has developed a tire with an “accordion-shaped” folding sidewall (Figure 22) that is claimed to allow change in footprint area while maintaining consistent ground pressure distribution and fuel savings through reduced rolling resistance and reduced slippage. At low tire pressures, the sidewall folds, as opposed to a standard tire, where the sidewall deforms and causes increased rolling resistance and generation of heat.<sup>78</sup>



Figure 22. Galileo wheel with accordion-shape sidewall design.<sup>78</sup>

There are clear benefits to having proper tire inflation pressures, but it is not clear if there is a net reduction in energy use when the energy to power an air compressor is included. Data comparing energy consumed by tire pressure management devices (e.g., air compressors and associated hardware) versus energy saved by having optimally inflated tires was not found.

### **3. IMPLEMENT OPERATIONS—SECONDARY FUEL USE**

Although tractors are seen as the primary energy users because that is where fuel is consumed, implements drive the energy required by the tractor. While it is certainly justified to expend effort and resources on improving tractor efficiency, a tractor's primary purpose is to provide power to implements where work is done on the soil or crop. By improving implement efficiency, a direct reduction in energy use is achieved. Tillage and harvesting operations typically have shown to require the most energy (Figure 23). Although research has focused on implement efficiency, reports related to engine, powertrain, and overall tractor efficiency are far more common.

Reports on tillage implements equipped with sweeps and rolling coulters indicated that the configuration of ground-engaging components could be arranged to reduce draft requirements by up to 45% during field tests;<sup>79</sup> note that this does not involve design changes to the ground engaging tools, but

simply changing their location and relative position on the implement frame. While it is not clear if this dramatic reduction in draft is achievable on a commercial scale or in all soil types; however, it does demonstrate potential for energy reduction requirements through optimization.

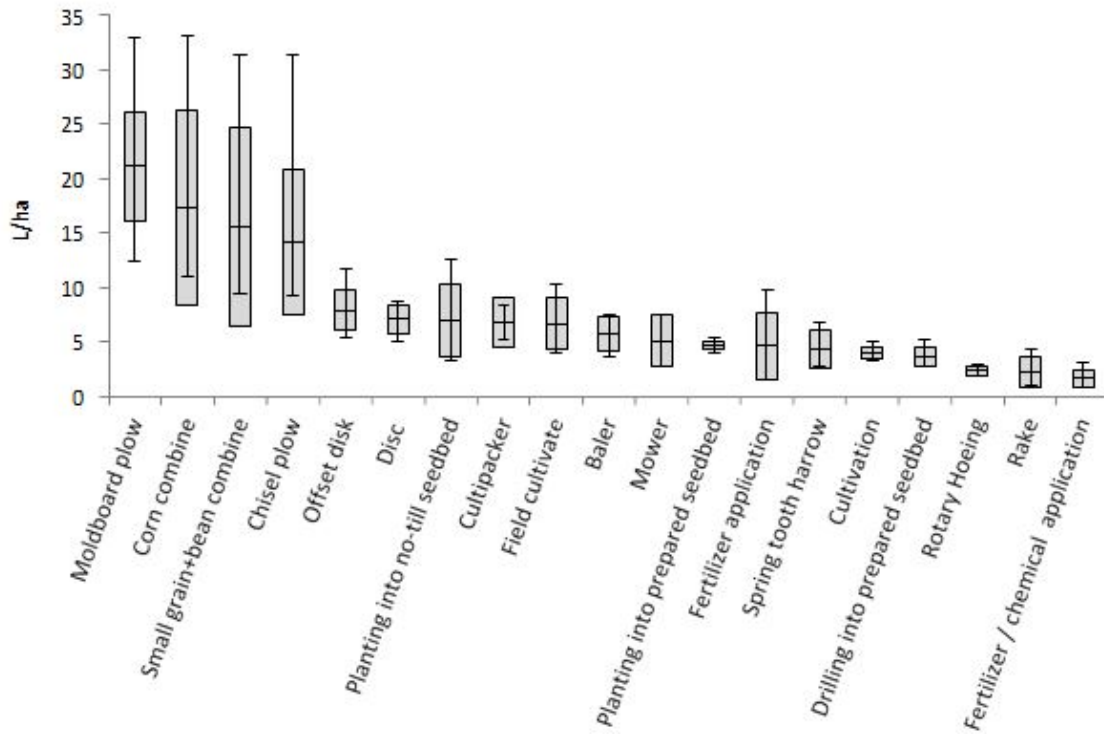

Figure 23. Diesel use by operation for combines and tractors with implements.<sup>1</sup>

Tractor and implement designs have evolved over time, becoming more productive and reliable; however, performance of the tractor-implement system has largely been determined by the skill and experience of the operator. With modern electronic controls being applied to this equipment, tractor-implement-automation is becoming feasible. Tractor-implement-automation via controller area network, using ISOBUS communication protocols, can allow an implement to dynamically request changes in tractor parameters. This has been demonstrated on the John Deere 6030 premium series tractors with a John Deere 864 round baler and with a Pöttinger Jumbo Loader Wagon, where the implements are allowed to request control of tractor parameters, including travel speed, acceleration rate, and hydraulic and PTO controls. In the case of tractor-implement-automation applied to the round baler, when the rate of material entering the baler changed, as detected by real-time sensors monitoring the volume of hay in the incoming windrow or by approximated PTO torque determined by the tractor, the baler requested changes in travel speed and the acceleration rate of the tractor to provide uniform flow rate into the baler. When the baler sensed the chamber was full, a request was sent to the tractor to stop and the bale was automatically tied. Once the tying operation was complete, hydraulic controls were requested to activate and eject the finished bale. Benefits included increased productivity, avoidance of plugging the baler, reduced idle time, and more consistent bales. At this time, only implements “certified” by the tractor manufacturer can request control of select tractor parameters, because some proprietary messages are used that are not specified in ISOBUS Class 3. ISOBUS Class 3 is the highest level of ISOBUS capability that allows the tractor electronic control unit to receive and execute commands that are sent from implement electronic control units. In the case of the John Deere 6R series tractors, tractor-implement-automation appears to be available in the European market; however, it is not yet available in North America.<sup>80</sup>

With no ability for an implement to control tractor hydraulics directly, some implement designs include auxiliary hydraulic valves installed on the implement itself, where they can be controlled locally. In this case, the tractor hydraulics may be active continuously so that fluid power is immediately available to the auxiliary valves to provide local control of implement functions. Maintaining continuous activation of the tractor hydraulics and throttling oil through a second set of valves can result in significant energy losses and heating of the oil. Additional parasitic losses may result if the tractor's cooling fan is required to run faster to cool the hydraulic oil. Better integration of tractor and implement controls may reduce these inefficiencies.

Improvements in combine efficiency include optimizing material flow through the threshing unit, reducing overall machine weight, and including advanced controls that adjust machine parameters to maximize operating efficiency.<sup>81,82</sup> Patents granted to major OEMs show that consideration has been given to the electrification of combine harvesters, but this has not yet shown up in the marketplace.<sup>67</sup>

## **4. ALTERNATIVE FUELS**

Displacing diesel with alternative fuels seems like an easy solution to reducing petroleum use; however, the availability of alternative fuels may not have significant impact on current petroleum use. In the OEM survey, availability of alternative fuels ranked as the highest barrier for alternative fuels to reducing petroleum consumption in off-road agricultural equipment systems. In the same survey, cost ranked highest as a barrier to further utilization of alternative fuels, closely followed by distribution and production, customer perception/acceptance, engine technology, and energy density (on-machine storage capacity) (see Appendix A). One OEM survey comment stated: "Indirect use of alternative fuels is a future consideration in order to satisfy customer needs for storage and energy density, cost, and infrastructure issues."

### **4.1 Biofuels**

#### **4.1.1 Biodiesel**

Biodiesel is readily used as a direct substitute for petroleum diesel fuel with no engine modifications required, which has allowed biodiesel to displace approximately 1 billion gallons of petroleum diesel annually in the United States since 2011. Biodiesel that meets industry specifications (ASTM 6751 for B100) can be included as a fuel additive to improve lubricity or as a blending component. Biodiesel and petroleum fuel blends that contain 5% or less biodiesel will meet the standard diesel fuel specification ASTM 975D. Fuel blends containing 6 to 20% biodiesel have a specific standard (ASTM 7467), but are less commonly used. Biodiesel (B100), meeting specification ASTM 6751, can be used as a standalone fuel, but this use is not typical and would primarily serve niche applications that specifically target the environmental benefits of a clean renewable fuel.

Biodiesel inclusion in agricultural diesel use is common and often promoted to the agricultural sector, which is the primary source for the feedstock (e.g., vegetable oils and animal fats) that are used to produce biodiesel. Agricultural OEMs support use of biodiesel fuel blends primarily at the 20% blend inclusion rate or lower. OEM support often includes factory fueling with 5% or 20% biodiesel fuel blends. Case IH and New Holland support biodiesel fuel use up to 100%.<sup>83</sup> However biodiesel represents a relatively small fraction of overall diesel consumption. Biodiesel production reached 1.8 billion gallons per year in 2013 (Figure 24), which represents approximately 3% of total diesel fuel consumption in the United States (55 billion gallons per year). Data for biodiesel use specifically in agricultural equipment are not available, but if one-third of the farm diesel fuel used contained 5% biodiesel, one-third contained 2% biodiesel, and the remaining third contained 0% biodiesel, the agricultural sector would be consuming approximately 70 million gallons of biodiesel or 3 to 6% of U.S. biodiesel production. This suggests the biodiesel industry could supply a greater fraction of biodiesel to the agricultural fuel sector if higher utilization rates were adopted.

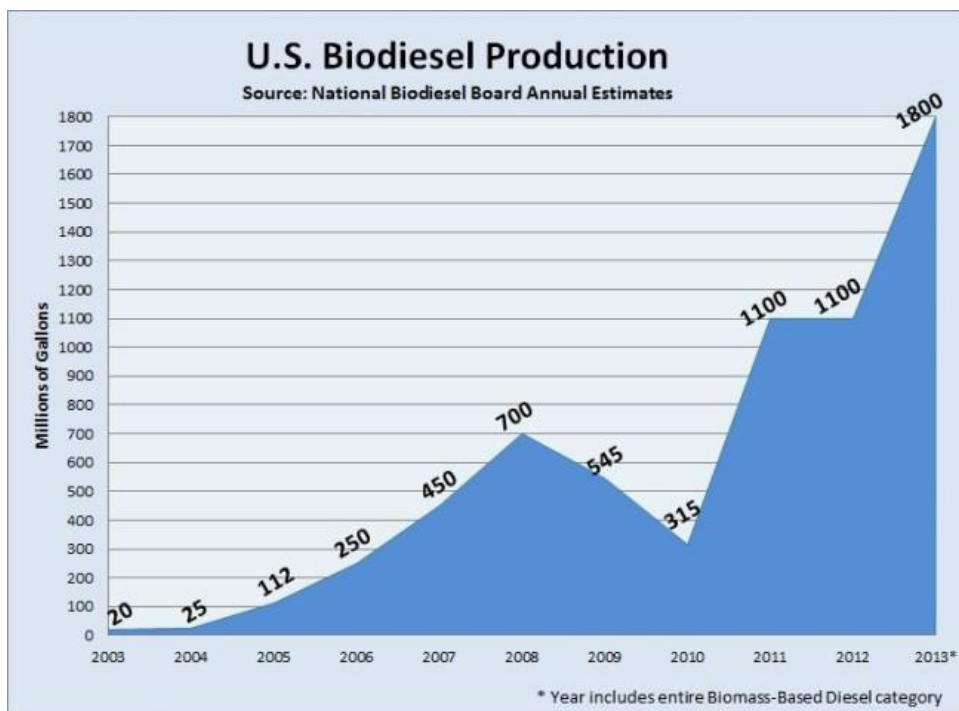

Figure 24. United States biodiesel production (source: National Biodiesel Board).

Despite biodiesel’s environmental attributes and lubricity-enhancing qualities, feedstock supply and cost limit extensive penetration into the petroleum diesel fuel market. New feedstock sources and processing techniques to produce biodiesel, or an alternative biomass-based diesel fuel, are being investigated; however, wide-scale commercial implementation is not likely in less than 5 to 10 years. Algal-based biodiesel production is a key example of this effort. If adapted at petroleum refinery scales, algal-based biodiesel could potentially be produced at levels matching diesel demands. However, this potential is limited by numerous challenges and obstacles that not only impact production costs but technical feasibility as well. These challenges and obstacles are well documented in general and scientific articles.<sup>84</sup>

#### 4.1.2 Ethanol

Ethanol, an oxygen-rich, high-octane fuel, is readily used as a direct substitute for petroleum gasoline fuel with currently adapted engine designs in the automobile industry. This has allowed ethanol to displace approximately 12 to 14 billion gallons of petroleum gasoline annually since 2010. The limited use of spark ignition engines and the associated volume of petroleum gasoline for off-road agriculture applications have limited inclusion of any significant ethanol volumes in agricultural production. However, some experimental and niche applications have been demonstrated.

The most notable approach has been ethanol-diesel fuel blends (i.e., E-diesel), which include additive packages that allow splash blending, typically between 10 to 15% ethanol inclusions. The National Renewable Energy Laboratory supported multiple studies addressing technical barriers and safety and performance assessments of E-diesel blends.<sup>85, 86</sup>

Potential advantages referenced include the following:

- Displacement of imported petroleum with a domestic and renewable resource
- Significant lowering of diesel particulate matter emissions
- Possible improvement in cold flow properties imparted by ethanol

- Possible improvement in fuel lubricity imparted by the emulsifier additives.

The main technical barriers referenced for commercialization include the following:

- Low flashpoint – E-diesel cannot be safely handled like conventional diesel; it must be handled like gasoline, which may necessitate some modifications to storage and handling equipment and equipment fuel systems
- Obtaining OEM warranty acceptance – a large body of test data acquired in close cooperation with OEMs will be necessary
- EPA fuel registration requirements – E-diesel would be required to undergo time-consuming and expensive emission and health effects testing.

Recommended actions to reduce safety risks include the following:

- Equipping all fuel storage tank vents and the vehicle tank vent and fill openings with flame arresters designed for use with ethanol
- Ensuring all fuel transfer processes, including vehicle fueling, incorporate effective vapor recovery systems
- Establishing an electrical ground connection between the vehicle and the fueling station fuel dispenser
- Ensuring the vehicle fuel tank level detectors are of an intrinsically safe design.

Adopting these modifications could allow the relative risk of E-diesel use to be comparable to that for gasoline and diesel fuel use in centrally fueled vehicle fleets. However, performance tests for E-diesel concluded a loss of maximum engine power was the most significant adverse performance effect, followed by possible fuel pump cavitation, causing fuel vaporization in injectors and potential fuel filter clogging. Recommended actions to address these possible adverse effects included the following:

- Increasing the capacity of the fuel injection pumps as necessary
- Installing an electric fuel pump at the vehicle fuel tank and restricting fuel return line flow
- Ensuring that all fuel handling systems and equipment engine fuel system components are of E-diesel compatible materials.

These challenges have limited adaptation of E-diesel, although ethanol or methanol utilization in compression ignition engines has not been abandoned completely. Research continues with dual fuel systems that deliver multiple fuels to the combustion chamber of the engine.<sup>87</sup> Preliminary research at the University of Nebraska indicates fumigation of ethanol in the air intake of a primarily diesel-fueled compression ignition engine will improve the engine's emission profile without reducing overall energy efficiency (Btu/hp-hr).<sup>88</sup> Imran reports alcohol fumigation leads to reduction in carbon dioxide up to 7.2%, nitrous oxides up to 20%, and particulate matter up to 57%, and that brake thermal efficiency decreases at low engine load and increases at higher engine load.<sup>89</sup>

Engine emission regulations, as with the use of ethanol for automobile transportation, may provide the best opportunity for ethanol to enter the off-road agricultural industry. As equipment is being designed to meet Tier 4 final emission regulations, some manufactures have explored the use of spark ignition engines that could utilize high-compression engines with high-octane fuel (such as ethanol) to provide a more cost-effective path to meet emission requirements.

Spark ignition engines for stationary applications (irrigation or other remote power requirements) have often been implemented to utilize the low-cost energy sources (\$/Btu) (such as locally available well field gas, natural gas from nearby pipeline distributions, and propane and ethanol when economical). Amerifuels, LLC is one example of agricultural producers' interest to use ethanol fuel produced from



their corn production.<sup>90</sup> The spark ignition engine and associated fuel delivery system allows producers to select the most economical fuel for the system. With the decline in natural gas prices since 2008, natural gas has typically been more economical.

Flex-fuel (ethanol and gasoline fuel blends) spark ignition engines have also been introduced for select niche application equipment such as John Deere's Flex Fuel ZTrak commercial lawn mower, but have not been introduced for equipment that uses significant quantities of fuel.

## 4.2 Hydrogen

Hydrogen fuel cells provide an alternative fuel option. The first fuel cell tractor was prototyped by Allis Chalmers in 1959 in their AC D-12 tractor chassis and was fueled with a mixture of gases, but primarily by propane. An electric motor powered by this fuel cell may have also made this the first electric drive tractor. Although Allis Chalmers reportedly noted that their tractor was twice as efficient as others of the period, this tractor did not make it to mainstream production.<sup>91</sup>

A modern hydrogen fuel cell-powered tractor has been developed by New Holland. Their NH2 working prototype (Figure 25), capable of 79 kW (106 hp), has independent electric motors for traction and implement power, allowing fully variable control to meet the demand.<sup>92,93</sup> Although this tractor uses no petroleum-based fuel and emits only water vapor, the availability of hydrogen fuel and the associated distribution infrastructure are significant barriers to widespread implementation of this technology.



Figure 25. New Holland's NH2 hydrogen-powered tractor.<sup>94</sup>

## 4.3 Natural Gas Substitution in Tractors

### 4.3.1 Natural Gas-Fueled Tractors

In 2010, natural gas was priced 42% less than diesel fuel per unit of energy and the pricing spread between the two fuels is expected to continue.<sup>95</sup> Two options exist for using natural gas (NG) in tractors for diesel replacement: (1) pure natural gas or (2) dual fuel systems. The NG needs to be utilized as either compressed natural gas (CNG) or liquefied natural gas (LNG).

The Steyr Profi 4135 tractor is a dedicated NG tractor reportedly scheduled for market launch in 2015 (Figure 26).<sup>96</sup> This tractor is equipped with a 3.0-L, four-cylinder engine capable of 100-kW rated power and 105-kW maximum power. With nine onboard fuel tanks, it can carry 300 L of NG or biogas. For comparison, a Steyr Profi 4130 is a similarly sized diesel tractor (four-cylinder engine with 97-kW rated power, 105-kW maximum power) with 176 L onboard diesel storage capacity.<sup>97</sup> The Profi 4135 would have an estimated run time of 49% of that expected for an equivalent diesel tractor and also would use 1.7 times the volume for CNG compared to diesel; this estimate is based on TUFFSHELL CNG tank specifications, where a 303-L CNG tank at 3,600 psi would store 86.7 L of diesel equivalent.<sup>98</sup> In the interest of maintaining high field efficiency, tractor operators prefer to have enough fuel on board to



allow a full day’s work without downtime for refueling. With this in mind, it may be difficult for the market to accept a 50% reduction in run time before refueling.

New Holland created a 135-hp methane-powered research tractor that can also run on diesel fuel. This tractor is being tested in Europe where on-farm production of biogas is available. The T6.140 Methane Power tractor can store 50 kg of compressed gas, which provides fuel for approximately half a workday, but can be supplemented with diesel fuel from a 15-L diesel tank.<sup>99</sup>

Dual system fuel consumption is typically split between 80 to 90% natural gas and 10 to 20% diesel, with diesel used primarily during ignition. Most dual-fuel systems are variable retrofitted hybrids that convert older machinery (Figure 26) and users suggest improved fuel economy compared to conventional diesel use.<sup>100</sup> Most retrofits are performed by local companies or farm operators.

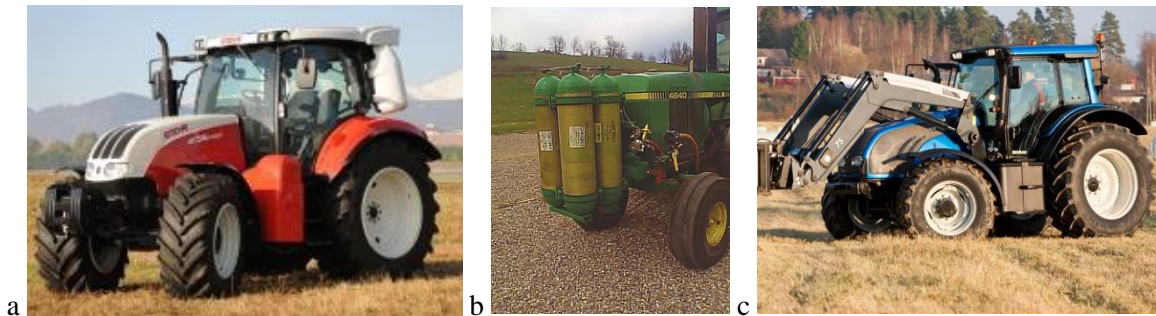

Figure 26. Natural gas tractors: a. Profi 4135, dedicated natural gas; b. retrofit dual fuel; and c. Valtra T133, dual fuel production hybrid.

Valtra produces the T133 that runs entirely on diesel or as a dual-fuel system with 83% NG and 17% diesel (Figure 26).<sup>101</sup> The T133 has a maximum power of 104 kW and a maximum torque of 580 Nm in either configuration. The T133 is estimated to reduce fuel costs by 10 to 40%. A comparable diesel tractor is the John Deere 6140D, which has a maximum power of 104 kW and a max torque of 574 Nm<sup>102</sup> (see Table1).

Table 1. Specifications for tractors fueled by natural gas, biogas, and diesel.

Tractor	Steyr Profi 4135, natural gas	Valtra T133, diesel	Valtra T133, biogas	Deere 6140D, diesel
Max Power (kW)	105	104	104	104
Max Torque (Nm)	542	580	580	574
Diesel/gas ratio (%)	0%/100%	100%/0%	17%/83%	100%/0 %

### 4.3.2 Natural Gas Resources and Prices

Production of U.S. NG in 2011 was estimated to be 23,000 billion cubic feet, while U.S. consumption totaled 24,369 billion cubic feet.<sup>103</sup> A relatively small portion of total use (i.e., 33 billion cubic feet) was used for all vehicle transportation. The average nominal cost for NG in the transportation sector during 2010 was \$6.25 per thousand cubic feet. Based on the typical energy density of NG at 1,050 Btu per cubic foot<sup>104</sup>, transportation NG cost \$5.95 per MBtu in 2010, compared to average residential NG at \$10.29 per MBtu in 2011. Based on the typical energy density of diesel (139,000 Btu per gallon)<sup>104</sup> diesel costs were \$27.63 per MBtu of energy, assuming an average on-highway diesel cost of \$3.84 per gallon. Thus, direct cost of NG is about 20% of diesel per unit energy, but use of CNG and LNG both require an additional cost to compress.

Total diesel fuel production and consumption in the United States is expected to increase 18% by 2020 and 23% by 2040.<sup>105</sup> Transportation NG is expected to increase 100% by 2020 and by 2,500% by 2040, where 0.52% of diesel is currently offset by NG with projections of 0.88% in 2020 and 11% in 2040. Increases in NG use are expected primarily in trucking and fleet vehicles, which can more effectively use the limited NG refueling infrastructure.<sup>106</sup>

### **4.3.3 Natural Gas Infrastructure: Refueling Sites and Fuel Storage**

There are two significant barriers to developing NG infrastructure: safety and cost.<sup>95</sup> Diesel is a liquid at typical atmospheric conditions and no special precautions are needed to prevent fuel loss. Storage systems for NG must be exceptionally sealed to prevent fuel loss. The related necessary safety precautions also increase the overall cost of storage both on vehicles and at refueling sites.

In the United States in 2013, there were 585 CNG and 32 LNG public refueling locations, mostly in California.<sup>107</sup> By comparison, there are over 157,000 gasoline stations in the United States.<sup>108</sup> There are some private NG stations operated by municipal fleets and trucking industries, which increase the total number of CNG and LNG stations to approximately 1,000.<sup>109</sup> Another possibility is to use home refueling units connected to existing NG lines.<sup>110</sup>

Refueling sites need to consider tank pressure, ambient temperature, and refueling rate when designing a station.<sup>111</sup> There are two options to refuel CNG: fast fill and time fill. Fast fill NG stations operate under similar time intervals as gas stations, but require CNG under higher pressure (about 5,000 psi) and cost significantly more to implement. Time fill stations use smaller compressors (about 800 to 3,000 psi) and typically refuel vehicles overnight. Time fill stations are intended for fleets or home refueling units. From CNG, LNG can be produced onsite; however, it is usually delivered by a tanker truck. Operators of LNG must wear protective clothing during the refueling process because it is a super cooled fluid (-260° F).<sup>112</sup>

On vehicles, CNG is typically stored at 3,000 or 3,600 psi in tube-shaped steel cylinders.<sup>113</sup> The tanks can be mounted on the rear, top, or underside of the vehicles; the mounting location is more important on long distance vehicles where drag is a greater concern. In general, low-cost CNG storage technologies are needed to make CNG more viable. One such technology is the TUFFSHELL fuel tanks made of carbon-fiber composite materials from Lincoln Composites (Hexagon) a subsidiary of General Dynamics, which can provide a 70% weight reduction compared to typical steel cylinders.<sup>114</sup> These tanks are available in similar sizes to standard metal tanks and have operating pressures of 3,000 psi; 3,600 psi; 5,000 psi; and 10,000 psi.

For some vehicles, LNG can be used instead of CNG, but must be maintained at -260°F by leaking some fuel off the tank (LNG occupies 1/600th the volume of typical NG).<sup>115</sup> This process only works on vehicles that are being constantly driven (e.g., long-haul trucks), meaning it is impractical for farm operations.

### **4.3.4 Trends in Heavy Trucks: Diesel Substitution with Natural Gas**

Several companies have begun converting diesel-powered vehicle fleets to use CNG and LNG to improve fuel efficiency and save costs; these companies include the U.S. Postal Service, the United Parcel Service, and Walmart. Two primary industries are replacing diesel with NG: municipal vehicles and trucking fleets. Both of these operate on predictable pathways, minimizing the need for a vast refueling network.<sup>116</sup> Long distance trucking fleets can utilize LNG due to the fuel storage limitations of CNG, while CNG is easier to accommodate in municipal vehicles, which can refill as needed.

In 1979, the United States Postal Service began operating 54 CNG vehicles in five locations. The United States Postal Service now has over 43,000 alternative-fueled vehicles in their fleet, with over 7,000 NG-converted delivery vehicles.<sup>117</sup> The United Parcel Service began using NG in their fleet in 1989. Currently, the United Parcel Service operates over 2,600 alternative vehicles, with about

1,000 CNG and 112 LNG vehicles. As of April 23, 2013, the United Parcel Service announced plans to expand their LNG refueling network and add 700 new LNG vehicles by 2015.<sup>118</sup> Walmart has tested five LNG trucks since 2009 in California and plans to continue testing CNG trucks; however, they cite the lack of the refueling infrastructure as the primary challenge to further implementation.<sup>119</sup>

Over 140 cities have converted portions of their municipal diesel fleets to NG, including Lower Merion, PA and Tulsa, OK.<sup>120</sup> Lower Merion began converting school buses to CNG in 1995, with half of their 114 bus fleet using CNG as of February 16, 2013. The city plans to convert all buses to CNG when refueling sites become available. In 2010, Tulsa converted 63 of their 142 school buses to use CNG, with expected savings of \$750,000 once the entire fleet was converted.<sup>121</sup> Tulsa also converted 15 of their 60 city buses to CNG in 2011.<sup>122</sup>

Another alternative to diesel is dimethyl ether. Dimethyl ether does not require cryogenic temperatures and can be maintained at 75 psi, making it advantageous compared with CNG or LNG.<sup>123</sup> Oberon fuels launched the first facility to produce dimethyl ether in California, partnering with Volvo Trucks and Safeway Inc.<sup>124</sup>

The primary reasons NG is not being implemented on farms more extensively is the low energy density of the fuel and the lack of refueling infrastructure (this conclusion is consistent with the survey results shown in Appendix A). Technology for retrofitting existing tractors to use NG is available. Fuel storage technology is progressing with carbon-fiber tanks. Efforts to increase refueling networks and spread awareness about the savings NG provides can increase implementation.

## **5. FARMING SYSTEMS—SECONDARY FUEL USE**

### **5.1 Cultural Practices**

#### **5.1.1 Equipment Selection and Operations Management**

Well matched tractor and implement systems have greater operating efficiency. Often machinery matching is based on practical experience; however, analysis tools are available to aid in making machinery management decisions. For example, a spreadsheet for matching tractor and drawn implements was developed by Grisso et al., which, in addition to matching tractors and implements, can help optimize weight distribution and tire pressure, as well as compute estimated field capacity and fuel consumption.<sup>125</sup>

Real-time performance monitors are enabling operators to manage equipment for improved efficiency. The operator interface on some machinery includes indications of productivity (acres/hour) and/or fuel use (gallons/hour). These monitoring functions continue to evolve, with some systems providing indications of real-time efficiency. For example, an AGCO patent application for a field efficiency gauge describes a system where real-time field fuel efficiency is displayed for the operator, along with a comparison efficiency value the operator should try to achieve, and with indicators or alarms if the current value is less than the target efficiency. The comparison value could be based on historic values or a predetermined goal for the operator.<sup>126</sup>

Claas's telematics on implement system allows monitoring of tractor and implement system status and performance via ISOBUS. Onboard machine data are available to the operator and are transferred to a web server where it can be accessed from any location. Analysis of these data can provide insights to machine utilization, idle time, settings, location, capacity, and fuel consumption. This information can be used to optimize logistics, train and motivate operators, make full use of machine capacity, manage crop inputs, and optimize equipment efficiency.<sup>127</sup> Claas's CEMOS system for combine harvesters can be configured to automatically manage harvester functions for one of four strategies: maximum throughput, minimal fuel consumption, high grain quality, or optimum balance.<sup>128</sup>

As telematics products and services are being becoming increasingly available for agricultural machinery, farm management information systems are being developed to help farmers manage and

analyze these data to support business planning, records management, and equipment utilization. Claas' Farm Management System, Case IH's Advanced Farming System, and John Deere's FarmSight are examples.<sup>129</sup> Much of the emphasis from these telematics and data management systems is on improving efficiency of farm operations and related reduction in fuel use.

Controlled traffic farming is a crop production system in which permanent traffic lanes are used in crop fields. There are many potential agronomic benefits for doing this, but this practice has also been shown to reduce fuel use due to lower rolling resistance because machinery travels on firm soil in the traffic lanes, there is less pass-to-pass overlap, and there is reduced tillage draft due to the less compacted soil between travel lanes. Little information has been found on controlled traffic farming in the United States, but sources indicate notable energy savings where CTF has been used in other countries. One source indicates, "Energy savings of up to 70% have been recorded within particular cropping systems...pulling force reduction of 18% to 37% have been recorded depending on tillage depth... random trafficking can increase the power used for a given operation by around 100%."<sup>130</sup>

Strip tillage is another method of seed-bed preparation that is gaining popularity across the United States. Strip till involves cultivating only a strip of soil across a field where seed will later be planted; in many cases, nutrients also may be applied in the furrow, reducing the need for later applications. Between the tilled areas, the soil is left undisturbed, which offers several benefits, including elimination of energy (e.g., fuel) for cultivation in these locations. A 2006 document, prepared by University of Illinois Cooperative Extension, indicated that for typical cropping practices within the state, strip till would result in the lowest management strategy in terms of fuel consumption, using approximately 2.4 gallons per acre (the same as using a no-till system). Crop production practices using standard tillage and deep tillage resulted in fuel use estimates of 3.7 and 4.0 gallons per acre, respectively.<sup>131</sup>

### 5.1.2 Tillage Considerations

Dominant crops associated with diesel consumption in the United States include corn (19%), hay (18%), soybean (16%), wheat (6%), and 28 other crops (42%) (Table 2). Based on surveys by Crop Residue Management, conservation tillage accounted for about 40% of cropland tillage in the United States in 2004 (CTIC 2006), reduced tillage accounted for about 21%, and conventional tillage accounted for about 38% of cropland tillage practices in the same year (the sum of these practices is roughly equivalent to the reduced tillage scenario in Table 2). Nationwide trends in tillage practices for all cropland indicate that there has been a decline in the use of conventional and reduced tillage practices, with an increase in conservation tillage, particularly no-till (Figure 27).<sup>132</sup> Use of only no-till farming practices, instead of reduced-tillage scenarios, are estimated to be able to reduce on-farm diesel use for crop production by as much as 20%, based on analysis using the FEAT model (Table 2, Figure 28).

Table 2. Estimated U.S. diesel consumption by crop in 2013

	Harvested Area		Reduced Till – Diesel			No Till – Diesel		
	Hectacres, million	Area %	L/ha/yr <sup>2</sup>	L/yr <sup>3</sup> billion	Volume %	L/ha/yr <sup>2</sup>	L/yr <sup>3</sup> billion	Volume %
Corn	33	27	64	2.10	19	39	1.27	12
Soybeans	31	25	55	1.71	16	30	0.93	8
Wheat	19	16	33	0.64	6	7	0.14	1
Hay (excl alfalfa)	16	13	74	1.20	11	74	1.20	11
Hay, alfalfa	8	7	97	0.78	7	87	0.71	6
Other crops <sup>2</sup>	16	13	—	4.59	42	—	4.59	61
Total	123	100	—	11.02	100	—	8.84	100

1. Harvested area in 2010, U.S. Department of Agriculture NASS ([http://www.nass.usda.gov/Quick\\_Stats/](http://www.nass.usda.gov/Quick_Stats/)).
2. "Other crops" consists of 28 individual crops ([http://www.nass.usda.gov/Quick\\_Stats/](http://www.nass.usda.gov/Quick_Stats/)).
3. Diesel efficiencies are from the FEAT model. Total U.S. diesel use from U.S. Department of Energy; diesel use for each crop estimated by multiplying area by FEAT efficiencies and subtracted from total fuel use to estimate fuel use for other crops.

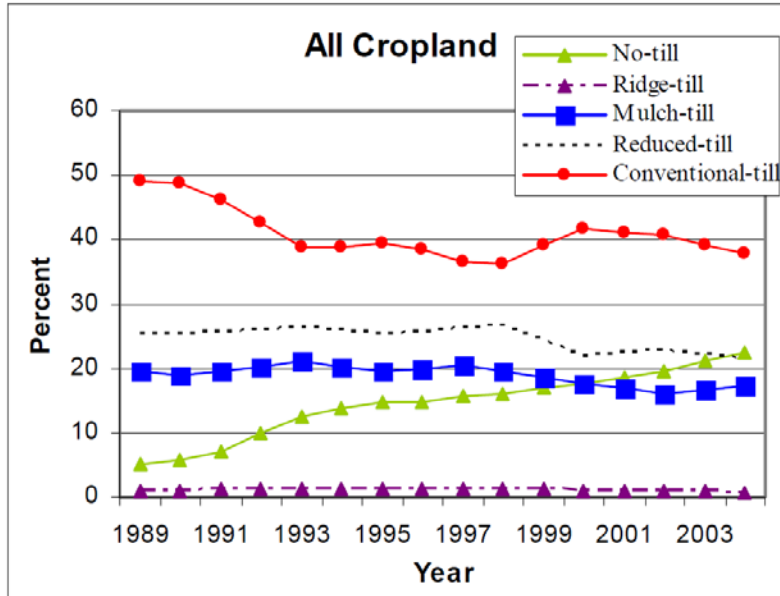

Figure 27. Trends in tillage practices in the United States.<sup>132</sup>

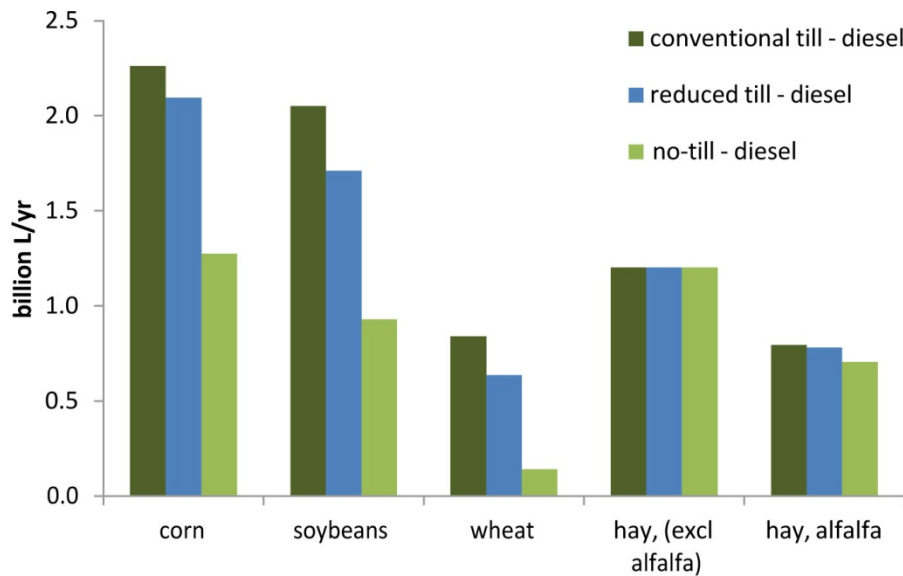

Figure 28. Diesel use by crop and tillage practice (source: data plotted from Table 2 and associated data).<sup>1</sup>

However, at least two factors limit the expansion of no-till: (1) where irrigation is used, furrow irrigation is dependent on the need for related tillage practices (while center pivot irrigation can support no-till expansion because tillage practices are not required), and (2) crop residue management considerations also tend to require some tillage, which further reduces the prevalence of practical implementation of no-till. Evaluation of changes in farming practices should also include consideration of indirect energy inputs and total net energy gains.<sup>133</sup>

## 5.2 Precision Agriculture and Machinery Automation

### 5.2.1 Guidance and Automatic Section Control Technologies

Precision agriculture covers a growing number of technologies and practices, including yield mapping, variable rate application of crop inputs, and machine guidance. Variable rate application allows crop inputs (e.g., seed, nutrients, pesticides, and water) to be optimized for local field conditions – reducing inputs in areas that cannot support increased yields and increasing inputs in areas that have more potential – rather than a uniform application across an entire field. While much emphasis is placed on the benefits of optimization of crop inputs and yields, improvement in equipment field efficiency and fuel use also can be realized by involving precision agriculture.

Fuel reduction, as a result of precision agricultural practices, comes primarily from improvement in field efficiency from reduced overlap. Machine guidance options in order of increasing precision include visual guidance via foam or disc markers, light bar, and autosteer. Benefits of machine guidance are influenced by operator skill and experience. GPS-based machine guidance reduces pass-to-pass overlap as machinery travels across a field. Not only does this reduce overlapping applications of crop inputs, it also improves field efficiency, saving time and fuel. Although the potential exists for economic and environmental benefits other than reduced fuel use, these benefits are not included in the scope of this report.

A U.S. Department of Agriculture NRCS publication reports that 16 million gallons of fuel, along with other crop inputs, would be saved if guidance systems were used on 10% of U.S. planted acres.<sup>134</sup> Another study surveyed North Dakota farmers regarding the use and benefits of GPS guidance. Farmers reported GPS guidance systems reduced fuel use by an average of 6.3% for operations, including tillage, planting, spraying, and harvesting.<sup>135</sup> An analysis using data collected on a farm in central Missouri concluded that using GPS guidance to reduce pass-to-pass overlap for fertilizer application in a corn/soybean cropping system would reduce fuel use by 0.11 to 0.14 gallons per acre (for fertilizer application only, suggesting additional benefits may be possible if this same machine guidance is used for other processes, including tillage and pesticide application). Energy saving benefits for application of various crop inputs depends on the power required for the application and swath width of the applicator, with narrower swath widths likely to show larger benefit from auto guidance, because pass-to-pass overlap is a larger percentage of swath width.<sup>136</sup>

Another GPS-based precision agriculture technology that may reduce over application of crop inputs is automatic section control (ASC) for application equipment. These systems can be utilized by nearly all field application implements, including planters, sprayers, and liquid or dry fertilizer equipment. ASC systems track the georeference position of field equipment during application and turn sections on or off depending on these recorded areas. This technology has become very beneficial for producers as the width of many pieces of equipment has continued to grow. ASC allows toolbars or booms to be divided into smaller subsections for automated control, reducing the need for operator intervention. In the case of spraying systems, ASC systems have been shown to reduce over application of pesticides by up to 6% over an entire farm, with some fields (depending on their size or complexity) seeing reductions of up to 20%.<sup>137</sup> While no known studies have been performed regarding the effects of ASC systems on fuel reduction, it does allow the use of equipment with larger widths (e.g., sprayers) and may reduce the number of passes across a field while maintaining product application accuracy. This could ultimately result in diesel reduction when considering time spent per field. In addition, reducing the need for delivery and manufacture of some products (e.g., seed, fertilizer, pesticides) may also decrease demand for fuel use per farm.

### 5.2.2 Variable Rate Application of Crop Inputs

Variable rate application (VRA) of crop inputs is a technology that many producers are hoping will improve their input use efficiency and profitability. Currently, VRA systems are used to control crop

inputs, including seed, nitrogen, micronutrients, water, and pesticides in combination with GPS and other sensor technologies. VRA management strategies using GPS are generally known as map-based technologies; others may not necessarily require the use of GPS and are referred to as sensor-based. While both systems are beginning to gain popularity across the United States, adoption has lagged behind when compared to more user friendly guidance and section control systems. For the most part, VRA systems require analysis and planning using software packages that are not popular amongst many in the industry, which has been a major barrier to adoption. In addition, few studies have been published that document savings from the use of these systems; however, benefits have been clearly shown in some instances.

On-farm fuel use has not been an effect studied during most VRA projects, because the goal of these systems is to maximize productivity across a field by optimizing the use of crop inputs. As with some previous examples, secondary fuel use could be reduced by minimizing the need for transport and application of crop inputs. However, emerging technologies for nutrient application may be able to reduce the use of diesel by applying multiple products separately. A recent report concluded that if nutrient and fuel savings were significant enough, the development of application technology for applying nitrogen, phosphorous, and potassium at one time in varying amounts may reduce passes across a field.<sup>138</sup>

Variable rate irrigation is another technology that could reduce on-farm energy demands when applying water to fields during the growing season. Enhanced spatial and temporal data management of irrigation systems utilizing variable rate irrigation could lead to savings in diesel-driven, center pivot systems and overall water use efficiency. Hedley et al. showed the potential for saving up to 19% of previously applied irrigation water through the use of variable rate irrigation; the benefits of pumping plant fuel reduction were not estimated.<sup>139</sup> The use of variable speed electric motors for driving irrigation well pumps would further reduce demands on petroleum by optimizing pumping energy efficiency when a variable rate irrigation system is used.

One of the primary examples of sensor-based VRA systems is crop canopy sensing for on-the-go nitrogen management. Popular systems from Ag Leader (OptRx system) and Trimble (Greenseeker) are improving nitrogen use efficiency across different parts of the United States, and further testing should highlight the ability of these systems to reduce nitrogen use within corn and wheat fields. As with other examples of VRA, these systems may further help to eliminate secondary fuel use by reducing the need for transport and application of fertilizers.

### **5.2.3 Precision Tillage**

Deep tillage is generally done to break up hard or impervious soil layers that can hinder crop growth. While not currently a standard practice on most farms, precision tillage, or site-specific deep tillage, is a method for reducing the tilled areas to those where soil compaction exceeds a certain index. A study by Fulton et al. found that by sampling critical cone indices across a field, locations where deep tillage should be performed were mapped.<sup>140</sup> By identifying a minimum threshold for deep tillage needs, a reduction in fuel consumption of 50% could be realized compared to deep tillage across the entire field. A later study was done to assess the feasibility of controlling tillage depth on-the-go. Inputs for the control system could be via an instrumented shank as a real-time sensor or tillage prescription maps (based on measured soil conductivity or cone penetrometer readings). Penetrometer data indicated that approximately 75% of the area tested did not require the full depth of tillage generally recommended for the local soils. This study concluded that variable rate tillage was practical with any of the input methods and energy savings of 42.8% and fuel savings of 28.4% could be achieved by adoption of variable depth tillage when compared to uniform-depth tillage.<sup>141</sup>

Another study using site-specific variable depth tillage showed reduction in energy use when compared to traditional uniform-depth tillage. In this study, soil properties were measured via the soil cone index and electro conductivity prior to tillage operations to establish predetermined tillage depths, based on a level of soil compaction in specific tillage zones. Results indicated potential fuel savings of 8



to 30%, depending on soil type when site-specific variable-depth tillage was used.<sup>142</sup> A similar study of uniform-deep tillage versus site-specific sub-soiling with three tillage depths showed a weighted average fuel savings of 24%.<sup>143</sup> The potential for fuel savings will change as proportions of soil compaction or hardpan vary by field and soil type, but avoiding deep tillage where it is not required shows clear benefits for fuel savings. Although site-specific tillage systems are not yet commercially available, several manufacturers have developed implements capable of on-the-go depth adjustment, which is seen as an incremental step toward commercially produced site-specific tillage systems.<sup>144</sup>

#### 5.2.4 Robotics and Autonomous Machinery

A prototype, fully autonomous tractor called the SPIRIT tractor (Figure 29), developed by Autonomous Tractor Corporation, is powered by two 202-hp diesel engines and uses electric motors to propel its rubber track system. This tractor was designed to work alone or in groups of up to 16 units, includes the capability for dynamic electric braking, and claims to increase fuel economy over conventional tractors<sup>145</sup>; however, no quantifiable information is provided. Autonomous Tractor Corporation has since turned their focus to developing implements that do not need a tractor, with the idea that conventional tractors will be replaced with multiple autonomous implements; the first that they are developing is an autonomous grain cart.<sup>146</sup>



Figure 29. SPIRIT tractor.<sup>147</sup>

Field shape and travel path can have a significant effect on total distance traveled, fuel use, overlap, misses, and crop inputs. A study on field efficiency and planned path operations using an 18-m (59-ft) sprayer reported that the average overlap was 20% of total area covered, with 7% attributed to lateral overlap and 13% to headland overlap. This study estimated a 16% potential reduction in distance traveled and associated fuel use by using an optimized pre-planned course.<sup>148</sup> The potential efficiency gain is likely to vary by implement type and width and with different field characteristics. Modern machine controls and GPS-guided steering systems capable of curved path operations are sure to make implementation of pre-planned paths feasible. Industry patents show evidence of development in this area, with optimization aimed at minimizing fuel use and machine operating costs.<sup>149</sup> Many models have been studied for applicability in this arena of agricultural productivity.<sup>150</sup> While automated path planning has been shown to reduce the time necessary to cover a particular field, a drawback to this method is that often other performance characteristics (e.g., application overlap) may suffer as a result of the selected path.<sup>151</sup>

An example of another opportunity for efficiency optimization using path planning and equipment logistics is harvest systems that include grain carts. Grain carts are used to improve field efficiency during harvest operations by allowing combine harvesters to unload on-the-go and maintain continuous operation. The grain cart operator chooses a travel path and staging location; therefore, the grain cart is immediately available when the combine is ready to unload to avoid making the combine stop and wait. The grain cart travel patterns recorded at several Midwest locations during corn harvest were studied in a



graduate research project to better understand grain cart logistics and identify opportunities for optimization.<sup>152</sup> Field, crop, and machinery characteristics were replicated in a simulation model that uses alternative grain cart logistics to minimize distance traveled while still maintaining uninterrupted harvester operation. The model uses logic that calls a grain cart to a harvester once the harvester is three-quarters full. If the grain cart is full after the most recent unloading event, it travels to the end of the field to unload into a waiting truck. If the grain cart has remaining capacity, it is staged in preparation for the next unloading event.

Two grain carts were used for harvest operations in the 120-acre field shown in Figure 30. Travel distance for both grain carts was 526,340 ft compared to the travel distance from the simulation model of 389,532 ft, a reduction of nearly 26 miles. Assuming an average fuel consumption of 10 gallons per hour, the reduction in distance travelled results in a fuel savings of nearly 42 gallons or about 0.35 gallons per acre. Using a diesel fuel price of \$4.00 per gallon, this is a savings of \$1.40 per acre for driving the grain cart more efficiently during harvest.

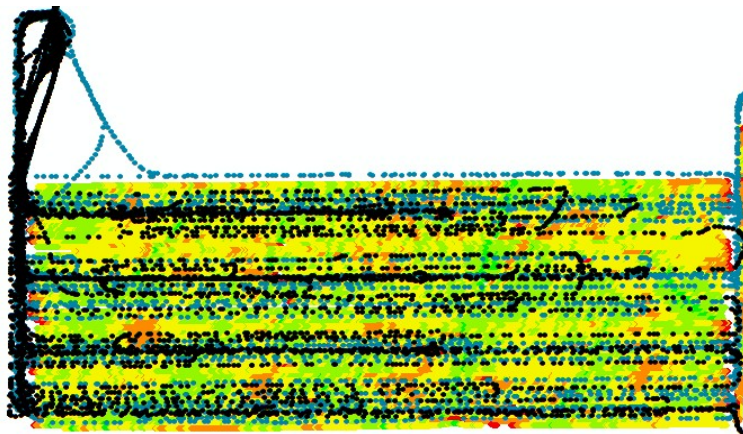

Figure 30. Travel path for two grain carts (blue and black) overlaid on yield map for 120-acre corn field.

As agricultural machinery moves closer toward full automation (e.g., Machine Sync from John Deere and the Kinze autonomous grain cart), further research into how these machines utilize path planning for fuel reduction would be of interest. Other examples of equipment moving in this direction are Fendt's Guide Connect system, where a "follower" tractor is led by a "leader" tractor during pass-to-pass operations.

In summary, precision agriculture technologies are continuing to advance our ability to control product and machinery during field operations. The ability to optimize the use of these systems will lead to improved crop input use efficiency in many cases. While not often studied, there is definite potential for many precision agriculture technologies to reduce primary and secondary on-farm fuel use. Modification of current studies and planning for future studies should be able to easily account for this reduction, in addition to documentation of other consequences and benefits.

## 6. CONCLUSIONS AND RECOMMENDATIONS\*

**Tractor Diesel Efficiency—Primary Fuel Use.** Gradual increases in fuel efficiency have been measured since 1958 (Figures 6 through 8). Equipment manufacturers have responded to customer needs by investing in improved efficiency, driven in part by high fuel prices, but an improved efficiency measurement practice is needed. Equipment manufacturers are pursuing efficiency improvements from single components to the farming system level. Many design concepts show promise at their respective levels and in a specific context. However, the effects at the machine and farming system level may not be captured with current industry standard test procedures designed for verifying manufacturer's claims (e.g., OECD Code 2). During a September 2013 meeting of the U.S. OECD coordinating committee,

OEM representatives reinforced the need for evolution of test procedures, with an example of evaluating tractors with CVT/ininitely variable transmission powertrains. Current tests evaluate performance at full-load and steady-state operating points, thus capturing the operating envelope of the tractor; however, current practice does not represent in-field operations, where loads often vary significantly with little sustained operation at full load. Current test procedures may show good efficiency for a traditional powertrain at full load, but may show low efficiency for a CVT/IVT powertrain under that same condition (Section 2.1.3). The inverse is likely true for part load conditions, which are likely more representative of in-field operations. Test procedures are more representative of field operations; comprised of simultaneous and varying draft, hydraulic, and PTO loads; are needed to better measure tractor efficiency; and offer customers and manufacturers the data needed to choose the most efficient equipment.

**Remote Power (Hydraulic).** Fluid power plays a key role in modern off road machinery and, although it offers high-power density, it has relatively low efficiency. With few alternatives capable of replacing the load capability and power density of fluid power, research to improve hydraulic system efficiency could result in a notable impact on fuel use (Section 2.1.4, Figure 15). More research is needed in this area.

**Remote Power (Electric).** The net benefits of electric power for implements (at the machinery system level) need to be quantified, relative to existing hydraulic and PTO drive systems (Section 2.1.4). Replacement of variable speed hydraulic motors with variable speed electric power may provide new opportunities for variable speed control to optimize energy savings.

**Tires and Tire Pressure.** Variable tire pressures have been shown to improve efficiency (Section 2.1.5). Research is needed to measure energy savings with dynamic tire pressure inflation under real-world conditions. There are clear benefits to having the correct tire pressure for the given conditions, but it should be determined whether a net reduction in energy use results if the energy required to compress the air is also considered.

**Implement Operations—Secondary Fuel Use.** Tractor fuel use is primarily dependent on the operation of implements (such as tillage and planting equipment). A direct reduction in energy use is achieved by improving implement efficiency or substituting implement types. Tillage and harvesting operations typically require the most energy (Figure 23). Yet, reports related to engine, powertrain, and tractor level efficiency are far more common than those regarding efficiency of implements and harvesters. The potential to increase efficiency exists for (1) selection and optimization of ground engaging tools to reduce draft, (2) improved power transfer to implements, and (3) in-field equipment utilization (Section 3). Little information has been found on harvester innovations related to petroleum reduction. More research is needed on diesel use associated with practical changes in implements and harvest equipment.

**Alternative Fuels.** Alternative fuels are limited on a national scale or in production volume (e.g., biodiesel, hydrogen) or have considerable constraints to implementation in off-road machinery, such as infrastructure, engine modifications, and energy density (e.g., natural gas, Section 4.2, and ethanol, Section 4.1). Evaluation of the implementation of natural gas, ethanol, or other alternative fuels in agricultural applications would be beneficial for petroleum reduction. As commercial options and advanced fuels become available, appropriate tests may be designed.

**Farming Systems—Secondary Fuel Use.** Research on the following topics and outreach to farmers and agricultural professionals is needed to ensure optimized practices are implemented effectively. These practices can include (1) operator behavior, (2) cultural practices (reduced tillage or no till), (3) best practices in maintenance, operation, equipment matching, and variable ballast configurations, (4) improved accessibility of available machinery performance and efficiency data (e.g., tractor test data are not easily understood by consumers and implement and harvester efficiency data are not available), and (5) an online database that can be queried by machine type, model, performance, and efficiency to inform consumers (e.g., Grisso's Spreadsheet for Matching Tractors and Drawn Implements<sup>125</sup>). Land

grant institutions are uniquely positioned to transfer research knowledge to farmers and agricultural professionals.

**Precision Agriculture and Machinery Automations.** Advanced machinery technologies related to application control systems (e.g., precision agriculture) have been researched extensively in recent years. The research focus for such technologies (e.g., guidance, automatic section control, or variable-rate application) has been primarily on improving crop input use efficiency, operational timeliness, and profitability, as well as reducing environmental impacts. Optimized path planning and in-field logistics can reduce fuel consumption. Robotics and autonomous vehicles are still being developed; however, advances made through research on these systems are furthering commercialization of automated equipment. For the most part, the ability of these systems to reduce petroleum use from primary or secondary perspectives has largely been ignored. Further research and comparisons on the performance of these technologies during field operations may highlight their capacity to provide benefits in terms of overall on-farm petroleum consumption.

**Industry Feedback Summary.** In industry, there is not a general consensus on successful approaches for improving farm diesel efficiency. At their September 2013 meeting, the U.S. OECD coordinating committee OEM representatives commented that they believe there is more potential for energy savings/efficiency improvements at the machinery system and work site level than at the machine or subsystem and component level. However, feedback from the OEM survey indicated that “innovations in primary power generation” ranked higher in relative potential for petroleum reduction than “improvements in equipment fleet management” and “field operation planning/optimization techniques,” which could include worksite planning, telematics, precision agriculture, machine-to-machine communication, and autonomous equipment technologies (Appendix A, survey question 5).

\* The intent of this review is to highlight emerging agricultural machinery methods and technologies that may lead to reduction in petroleum use. Machinery manufacturers are obviously reluctant to disclose information on technologies that are in development or detailed information on those that have recently been marketed. Various information sources (e.g., patent filings, advertising, trade magazine articles, and industry innovation awards) can provide insight on areas of research and development and technologies aimed at improving efficiency; yet it is difficult to quantify benefits for items seen as having potential on a commercial scale or to verify advertised claims. Potential benefits for different items described in this report are not necessarily additive. Items identified as having high potential for reduction of petroleum use need to be tested to quantify benefits. More extensive tests, data collection, and information also are needed to confidently evaluate the relative potentials of these various technologies to impact petroleum displacement.

## 7. REFERENCES

1. Camargo, G. G., M. R. Ryan, and T. L. Richard, 2012, “Farm Energy Analysis Tool,” Version 1.1, Pennsylvania State University, <http://www.ecologicalmodels.psu.edu/agroecology/feat/download.htm>, last accessed January 22, 2014.
2. “Annual Energy Review 2011,” 2011, DOE/EIA-0384, U.S. Energy Information Administration, <http://www.eia.gov/totalenergy/data/annual/pdf/aer.pdf>, last accessed January 22, 2014.
3. Natural Resources Conservation Service Energy Consumption Awareness Tool: Tillage, <http://ecat.sc.egov.usda.gov/>, accessed January 15, 2014.
4. Klein, R. and R. Wilson, 2013, “2013 Nebraska Crop Budgets,” University of Nebraska – Lincoln Extension, <http://cropwatch.unl.edu/web/economics/budgets>, last accessed January 22, 2014.

5. “Tier 4 Are You Ready?” Caterpillar Inc. 2011, [http://www.empire-cat.com/cm/uploadedFiles/Empire\\_Cat/Power\\_Systems/Emissions\\_Solutions/Empire\\_Tier4Mlr.pdf](http://www.empire-cat.com/cm/uploadedFiles/Empire_Cat/Power_Systems/Emissions_Solutions/Empire_Tier4Mlr.pdf), last accessed January 22, 2014.
6. “Meeting EPA 2012 Tier 4 Interim and EU Stage IIIB Emissions Customer FAQ (75-173 hp),” 2013, Bulletin 4087191, Cummins Inc., <http://cumminsengines.com/uploads/docs/4087191.pdf>, last accessed January 22, 2014.
7. Shin, Y. H., S. C. Kim, and M. S. Kim, 2013, “Use of Electromagnetic Clutch Water Pumps in Vehicle Engine Cooling Systems to Reduce Fuel Consumption,” *Energy* 57, 1: 624–631 <http://dx.doi.org/10.1016/j.energy.2013.04.073>, last accessed January 23, 2014.
8. Ashrafur Rahman, S. M., H. H. Masjuki, M. A. Kalam, M. J. Adebini, A. Sanjid, and H. Sajjad, 2013, “Impact of idling on fuel consumption and exhaust emissions and available idle-reduction technologies for diesel vehicles – A review,” *Energy Conversion and Management* 74: 171–182.
9. Baroni, M., E. Sereni, and F. Mancarella, 2013, “Engine control device for a work vehicle,” Patent Application WO2013079324 A1.
10. Schumacher, L. G., J. C., Frisby, and W. G. Hires, 1991, “Tractor PTO Horsepower, Filter Maintenance, and Tractor Engine Oil Analysis,” *American Society of Agricultural Engineers*.
11. Eauclaire-Kopier, M., 2010, “Strike that, reverse it,” *OEM Off-Highway Magazine*, <http://www.oemoffhighway.com/article/10208884/strike-that-reverse-it>, last accessed January 21, 2014.
12. Zhong, Y., K. L. Wert, and T. Fang, 2010, “An Adsorption Air-Conditioning System to Reduce Engine Emissions and Fuel Consumption for Heavy-Duty Vehicles,” International Refrigeration and Air Conditioning Conference, Paper 1100, <http://docs.lib.purdue.edu/iracc/1100>, last accessed January 22, 2014.
13. ClimateWell, “Heat-driven Air Conditioning for Trucks & Vehicles,” <http://www.climatewell.com/index.html#/applications/vehicles-ac>, last accessed January 22, 2014.
14. Perkins Engines Company Limited, 2013, “Control System for an Engine Assembly,” European Patent Application, EP 2639437 A1.
15. “Waste Heat Recovery By Behr Improves Fuel Economy For Long-haul Trucks,” 2012, SAE International, <http://www.sae.org/mags/sve/saewc/11184>, last accessed January 22, 2014.
16. Grisso, R., R. Pitman, J. V. Perumpral, D. Vaughan, G. T. Roberson, and R. M. Hoy, 2011, “Gear Up and Throttle Down to Save Fuel,” Virginia Cooperative Extension, Virginia Polytechnic Institute and State University.
17. “966M/972M Wheel Loaders,” AEHQ7171 (03-2014) Caterpillar 2014.
18. Laws, N. H., J. R. Copeland, J. J. Foxen, and A. W. Brandon, 2014, “Charge pressure reduction circuit for improved transmission efficiency,” U.S. Patent US8528684B2.
19. “Field Work Demonstrates John Deere Dual Clutch Transmission Benefits,” 2012, *Driveline News*, <http://drivelinenews.com/news/field-work-demonstrates-john-deere-dual-clutch-transmission-benefits/>, last accessed January 22, 2014.
20. “New 6R Series Tractors Offer More Power, Comfort, and Security,” 2011, John Deere News Releases and Information, [http://www.deere.com/wps/dcom/en\\_INT/our\\_company/news\\_and\\_media/press\\_releases/2011/sep/agri\\_6r.page](http://www.deere.com/wps/dcom/en_INT/our_company/news_and_media/press_releases/2011/sep/agri_6r.page), last accessed January 22, 2014.

21. “John Deere introduces new 7R and 8R Series tractors,” 2013, John Deere News Releases and Information.  
[https://www.deere.com/wps/dcom/en\\_INT/our\\_company/news\\_and\\_media/press\\_releases/2013/august/john\\_deere\\_introduces\\_new\\_7r\\_and\\_8r\\_series\\_tractors.page](https://www.deere.com/wps/dcom/en_INT/our_company/news_and_media/press_releases/2013/august/john_deere_introduces_new_7r_and_8r_series_tractors.page), last accessed March 24, 2014.
22. Howard, C., 2010, “Testing Fuel Efficiency of Tractors with both Continuously Variable and Standard Gear Transmissions,” University of Nebraska–Lincoln Digital Commons.
23. “Puma Series Tractors,” CNH America LLC, 2011,  
[http://160.220.151.125/en\\_us/Products/Tractors/Pages/puma-row-crop-tractors.aspx](http://160.220.151.125/en_us/Products/Tractors/Pages/puma-row-crop-tractors.aspx), last accessed January 22, 2014.
24. Watt, J. D., R. E. McMillen, G. E. Salzman, J. H. Orsborn, S. M. Faivre, J. G. Morrow, and P. J. Vogel, 1999, “Control of vehicular systems in response to anticipated conditions predicted using predetermined geo-referenced maps,” U.S. Patent US5995895A.
25. “Agritechnica: The electric age dawns,” 2009, Profi International,  
<https://www.profi.com/news/Agritechnica-The-electric-age-dawns-39144.html>, last accessed January 22, 2014.
26. “Belarus – 3023,” <http://www.belarus-tractor.com/en/main.aspx?guid=45893&mode=shortinfo>, last accessed January 22, 2014.
27. Eckelkamp, M., 2009, “Machinery Journal–Silver Awards at Agritechnica (Part 1),” AgWeb,  
[http://www.agweb.com/blog/Machinery\\_Journal\\_138/Silver\\_Awards\\_at\\_Agritechnica\\_\(Part\\_1\)\\_13738/](http://www.agweb.com/blog/Machinery_Journal_138/Silver_Awards_at_Agritechnica_(Part_1)_13738/), last accessed January 22, 2014.
28. Herlitzius, T. “Rigitrac EWD120,” Technische Universitat Dresden Department of Agricultural Systems Technology, [http://www.reo-it.de/Stammbaum\\_Daten/Rigitrac\\_EDW120\\_en.pdf](http://www.reo-it.de/Stammbaum_Daten/Rigitrac_EDW120_en.pdf), last accessed January 22, 2014.
29. “Research Project with the TU Dresden,” <http://www.reo.de/en/innovation/joint-research-project.html>, last accessed January 22, 2014.
30. Cousins, D., 2011, “Agritechnica 2011: Rigitrac Shows Novel Diesel-Electric Tractor,” *Farmers Weekly*, <http://www.fwi.co.uk/articles/19/11/2011/130162/agritechnica-2011-rigitrac-shows-novel-diesel-electric.htm#Udw72uIo71Q>, last accessed January 22, 2014.
31. “ZF drivelines for agricultural machines,”  
[http://www.zf.com/media/media/en/document/corporate\\_2/downloads\\_1/flyer\\_and\\_brochures/agricultural\\_machinery\\_flyer/broschuerelandmaschinen.pdf](http://www.zf.com/media/media/en/document/corporate_2/downloads_1/flyer_and_brochures/agricultural_machinery_flyer/broschuerelandmaschinen.pdf), last accessed January 22, 2014.
32. “ZF – Terra: Starter Generator System,” 2009, ZF Friedrichshafen AG,  
[http://www.zf.com/media/media/en/document/corporate\\_2/press\\_3/press\\_kits\\_1/agritechnica\\_2009\\_pressmappe\\_1/03\\_ZF-Terra\\_\\_Startergenerator\\_System.pdf](http://www.zf.com/media/media/en/document/corporate_2/press_3/press_kits_1/agritechnica_2009_pressmappe_1/03_ZF-Terra__Startergenerator_System.pdf), last accessed January 22, 2014.
33. “Combining Mechanical and Electric - ZF develops systems that move another step toward ag tractor electrification,” 2012, *Diesel Progress*, North American Edition, 34-35.
34. ZF Press Kit Agritechnica 2009 Press Images,  
[http://www.zf.com/corporate/en/press/media\\_service/press\\_kits/agritechnica\\_2009/Agritechnica\\_2009\\_Pressemappe.html](http://www.zf.com/corporate/en/press/media_service/press_kits/agritechnica_2009/Agritechnica_2009_Pressemappe.html), last accessed January 21, 2014.
35. Husson, G., M. Shute, and G. Menier, 2013, “Tractor with Hybrid Power System,” United States Patent Application Publication number US2013/0047753A1. 06.
36. Lyseng, R., 2010, “Behind the wheel of ElectRoGator 1386,” *The Western Producer*,  
<http://www.producer.com/2010/09/behind-the-wheel-of-electrogator-1386/>, last accessed January 21, 2014.

37. Caterpillar Inc., “D7E (U.S. Tier 4 Interim/EU Stage IIIB/Japan MLIT Step 4),” [http://www.cat.com/en\\_US/products/new/equipment/dozers/medium-dozers/18429156.html](http://www.cat.com/en_US/products/new/equipment/dozers/medium-dozers/18429156.html), last accessed January 21, 2014.
38. Flint, J., 2013, “644K hybrid features easy learning curve,” *Nebraska Farmer*.
39. John Deere 644K Hybrid Wheel Loader, [http://www.deere.com/wps/dcom/en\\_US/products/equipment/wheel\\_loaders/644k\\_hybrid/644k\\_hybrid.page](http://www.deere.com/wps/dcom/en_US/products/equipment/wheel_loaders/644k_hybrid/644k_hybrid.page), last accessed January 21, 2014.
40. Komatsu Hybrid: Best Performance Hybrid, <http://www.komatsu.com.au/AboutKomatsu/HybridTechnology/Pages/Performance.aspx>, last accessed January 21, 2014.
41. Morey, B. 2013, “Ricardo sees a future in flywheel hybrid excavators,” SAE International, <http://articles.sae.org/12282/>, last accessed January 21, 2014.
42. Stewart, L., 2012, “Caterpillar’s New Hydraulic Hybrid Excavator is 50%-Efficiency ‘Next Generation’,” <http://www.forconstructionpros.com/news/10815214/caterpillars-new-hydraulic-hybrid-excavator-is-50-efficiency-next-generation>, last accessed January 21, 2014.
43. Caterpillar, “Large Excavators - 336H Hybrid,” [http://www.cat.com/en\\_US/products/new/equipment/excavators/large-excavators/18378156.html](http://www.cat.com/en_US/products/new/equipment/excavators/large-excavators/18378156.html), last accessed January 21, 2014.
44. “Nebraska OECD Tractor Test 2038 – Summary 837 John Deere 5115M Diesel 16 Speed,” 2013, Nebraska Tractor Test Laboratory, University of Nebraska-Lincoln.
45. Rodeghiero, R. A., W. Stettler, G. Thompson, B. Klabunde, A. V. Skotnikov, and Deere & Company, 2004, “Transmission for power take-off,” U.S. Patent 6692395.
46. Huber, C., R. Morselli, J. Posselius, and CNH America LLC, 2012, “PTO transmission system in a work vehicle,” U.S. Patent Application Number 13/984,300.
47. Love, L. J., E. Lanke, and P. Alles, 2012, “Estimating the Impact (Energy, Emissions, and Economics) of the U.S. Fluid Power Industry,” Oak Ridge National Laboratory – UT-Battelle, ORNL/TM-2011/14.
48. Center for Compact and Efficient Fluid Power, “Mobile Heavy Equipment – High Efficiency Excavator (Test Bed 1).” <http://www.ccefp.org/research/testbeds/high-efficiency-excavator>, last accessed January 21, 2014.
49. “OFF-ROAD,” <http://www.artemisip.com/applications/off-road>, last accessed March 27, 2014.
50. van Malsen, R., P. Achten, and G. Vael, 2002, “Design of Dynamic and Efficient Hydraulic Systems Around a Simple Hydraulic Grid,” SAE 2002-01-1432, Society of Automotive Engineers.
51. Stoss, K., J. Sobotzik, B. Shi, and E. Kreis, 2013, “Tractor Power for Implement Operation - Mechanical, Hydraulic, and Electrical: an Overview,” 2013 Agricultural Equipment Technology Conference, American Society of Agricultural and Biological Engineers.
52. Karner, J., P. Heinrich, and F. Kogler, 2012, “Electric Drives in Agricultural Machinery,” International Conference of Agricultural Engineering CIGR-Ageng, [http://cigr.ageng2012.org/comunicaciones-online/htdocs/principal.php?seccion=index\\_posters](http://cigr.ageng2012.org/comunicaciones-online/htdocs/principal.php?seccion=index_posters), last accessed January 21, 2014.
53. Buning, E., 2010, “Electric drives in agricultural machinery - approach from the tractor side,” Club of Bologna, 21 Annual Meeting, [http://www.clubofbologna.org/ew/documents/knr\\_buning.pdf](http://www.clubofbologna.org/ew/documents/knr_buning.pdf), last accessed January 21, 2014.

54. Garvey, Scott, 2012, "Electric drive is on the horizon," <http://www.grainews.ca/2012/03/22/electric-drive-is-on-the-horizon/>, last accessed January 21, 2014.
55. Onnen, M., 2011, "Coming Soon- Tractor Electrification," *Resource Magazine* 18, 5: 16-17.
56. Partico, J., 2013, "Hybrids Are Here...Almost," PF-18, PF-20. *The Progressive Farmer*.
57. "Drive Axle PowerDriveElect - Transport concepts with drive axles over the course of time," Fliegl Agrartechnik, <http://www.fliegl-agrartechnik.de/index.cfm?cid=2234&documents.id=1591>, last accessed January 21, 2014.
58. Kinze 4900 Planter Literature, February 2013, <http://www.kinze.com/filesimages/Literature/4900.pdf>, last accessed January 21, 2014.
59. Mckelkamp, M., 2013, "Kinze's 4900 Series Electric Planter, 4000 Series Row Unit and Electric Meter," *Ag Web*, [http://www.agweb.com/article/kinzes\\_new\\_4900\\_series\\_planter\\_4000\\_series\\_row\\_unit\\_and\\_electric\\_meter/](http://www.agweb.com/article/kinzes_new_4900_series_planter_4000_series_row_unit_and_electric_meter/), last accessed January 21, 2014.
60. "Optima e-drive," Kverneland, <http://ien.kverneland.com/layout/set/print/Seeding-Equipment/Precision-Drills/Features/Optima-e-drive>, last accessed January 21, 2014.
61. Graham Electric Planter Drive, <http://www.grahamelectricplanter.com/>, last accessed June 19, 2014.
62. "UX eSpray trailed sprayer," 2010, GO for Innovation, Amazone, <http://info.amazone.de/DisplayInfo.aspx?id=14005>, last accessed January 21, 2014.
63. Agritica.com, 2007, "Electrically-powered Kuhn/Rauch fertilizer spreaders offer ultra-accurate application," [http://www.agritica.com/en/nieuws\\_bericht.php?hoofdcatid=8&berichtid=11705](http://www.agritica.com/en/nieuws_bericht.php?hoofdcatid=8&berichtid=11705).
64. Hahn, K., 2008, "High Voltage Electric Tractor-Implement Interface," *SAE International Journal of Commercial Vehicles* 1, 1: 383-391.
65. *Farmers Guardian Magazine*, 2011, "Agritechnica 2011: An electric revolution in the offing," <http://www.farmersguardian.com/shows-and-sales/events/agritechnica-2011-an-electric-revolution-in-the-offing/43086.article>, last accessed January 22, 2014.
66. Deere & Company, 2012, "Round baler with electrically driven roller," European Patent Specification, EP 2 352 858 B1.
67. Favache, S. and Deere & Company, 2002, "Harvesting Machine with Electrically Driven Material Conveyor and/or Material Processing Device," U.S. Patent Application Publication No. US 2002/0056262 A1. 16.
68. Brodbeck, K. N., 2004, "Choosing the Right Tire," ASAE Distinguished Lecture # 28, Agricultural Equipment Technology Conference, February 8 through 10, 2004, Louisville, Kentucky USA, ASAE Publication Number 913C0204, 1-13.
69. "Proof of Performance," Michelin Agricultural Tires, <http://www.michelinag.com/layout/set/print/content/view/full/1492>, last accessed January 21, 2014.
70. "Advanced Deflection Design," Firestone Farm Tires, <http://www.firestonead2.com/savings.php>.
71. Wood, R. K. and D. A. Mangione, 1994, "Tractive Benefits Of Properly Adjusted Inflation Pressures: Farmer Experiences," *Applied Engineering in Agriculture* 10, 1: 13-16.
72. Udompetaikul, V., S. K. Upadhyaya, and B. Vannucci, 2011, "The Effect Of Tire Inflation Pressure On Fuel Consumption Of An Agricultural Tractor Operating On Paved Roads," *Transactions of the ASABE* 54(1): 25-30, American Society Of Agricultural and Biological Engineers, ISSN 2151-0032.



73. DANA Spicer, “Central Tire Inflation System (CTIS) – Enhanced Mobility For Agricultural Vehicles,” 2011, <http://www.dana.com/wps/wcm/connect/dext2/dana/markets/off-highway/products/tire+pressure+management>, last accessed January 22, 2014.
74. “Fendt 900 Vario,” <http://www.kakkisagrifuture.com/pdfs/Fendt900Vario924-939.pdf>, last accessed January 22, 2014.
75. Wendte, K. W., CNH America LLC, 2007, “Tire Inflation System For Use With An Agricultural Implement,” U.S. Patent 7302837 B2 4.
76. Adams, B., G. W. Schmitz, and Case Corporation, 2000, “Automatic Central Tire Inflation System,” U.S. Patent 6144295. 7.
77. Anderson, N.W., 2013, “Vehicle Stability and Traction Through V-Foot Shape Change,” U.S. Patent Application Publication No. US 2013/0046446 A1.
78. “Galileo Wheel–Redesigning the Tire,” <http://www.galileowheel.com/>, last accessed January 23, 2014
79. Johnson, C. E., E. C. Burt, J. E. Morrison, A. C. Bailey, and T. R. Way, 2001, “Energy Reduction in Sweep Tillage Systems,” Paper Number: 01-1057, American Society of Agricultural Engineers.
80. von Hoyningen-Huene, M. and M. Baldinger, “Tractor-Implement-Automation and its application to a tractor- loader wagon combination,” [http://www.mcg.uni-bonn.de/proceedings/20\\_hoyningen.pdf](http://www.mcg.uni-bonn.de/proceedings/20_hoyningen.pdf), last accessed May 15, 2014.
81. EauClaire-Kopier, M., 2013, “Go with the energy flow,” OEM Off-Highway Magazine: 10-13.
82. “ASABE AE50 Outstanding Innovation Award 2013 - Cruise Pilot – Claas of America,” 2013, American Society of Agricultural and Biological Engineers, [http://www.asabe.org/media/126991/12-080\\_not\\_sure\\_of\\_photo\\_web.pdf](http://www.asabe.org/media/126991/12-080_not_sure_of_photo_web.pdf), last accessed January 22, 2014.
83. [http://www.biodiesel.org/docs/default-source/ffs-engine\\_manufacturers/oem-support-summary---july-2013.pdf?sfvrsn=6](http://www.biodiesel.org/docs/default-source/ffs-engine_manufacturers/oem-support-summary---july-2013.pdf?sfvrsn=6).
84. Hannon, M., J. Gimpel, M. Tran, B. Rasala, and S. Mayfield, 2010, “Biofuels from algae: challenges and potential,” *Biofuels* 1(5): 763-784. <http://www.ncbi.nlm.nih.gov/pmc/articles/PMC3152439/> Last accessed 26June2014.
85. McCormick, R. L. and R. Parish, 2001, “Technical barriers to the use of ethanol in diesel fuel,” milestone report to NREL/MP-540-32674.
86. Waterland, L. R., S. Venkatesh, and S. Unnasch, 2003, “Safety and Performance Assessment of Ethanol/Diesel Blends (E-Diesel),” Report to NREL/SR-540-34817.
87. Abu-Qudais, M., O. Haddad, and M. Qudaisat, 2000, “The effect of alcohol fumigation on diesel engine performance and emissions,” *Energy Conversion & Management* 41: 389-399.
88. Janousek, G., 2010, “Evaluation of ethanol and water introduction via fumigation on efficiency and emissions of a compression ignition engine using an atomization technique,” Digital Commons@University of Nebraska-Lincoln.
89. Imran A., M. Varman, H. H. Masjuki, and M. A. Kalan, 2013, “Review on alcohol fumigation on diesel engine: a viable alternative dual fuel technology for satisfactory engine performance and reduction of environment concerning emission,” *Renewable and Sustainable Energy Reviews* 26: 739-751.
90. Isom L., R. Weber, and M. Hanna, 2010, “Evaluation of biofuel driven irrigation pumps and/or electric generators for use during peak electricity demand,” University of Nebraska – Industrial

- Agricultural Products Center; Lincoln, NE,  
<http://www.ksre.ksu.edu/irrigate/OOW/P10/Isom10.pdf>, last accessed June 26, 2014.
91. Bowes, D., "Experimental Tractors—Tractor technology appears to have nearly hit its pinnacle of development," Yesterday's Tractor Co., <http://www.yesterdaystractors.com/articles/artint207.htm>, last accessed January 22, 2014.
  92. New Holland Agriculture, "NH2 Tractor," <http://agriculture.newholland.com/us/en/About-New-Holland/Innovation/Pages/NH2-Tractor.aspx>, last accessed January 22, 2014.
  93. "New Holland NH2 Hydrogene Powered Tractor," [http://agriculture.newholland.com/PublishingImages/cnhimg/we/Hydrogen/NH2\\_90014\\_INB.pdf](http://agriculture.newholland.com/PublishingImages/cnhimg/we/Hydrogen/NH2_90014_INB.pdf).
  94. New Holland NH2 Tractor graphics, [http://www.avto.info/Novosti/New\\_Holland\\_NH2\\_Hydrogen-Prvi\\_traktor\\_s\\_pogonom\\_na\\_vodik/](http://www.avto.info/Novosti/New_Holland_NH2_Hydrogen-Prvi_traktor_s_pogonom_na_vodik/), last accessed January 22, 2014.
  95. Lovins, A. B. and Rocky Mountain Institute, 2011, "Reinventing Fire: Bold Business Solutions for a New Energy Era," Chelsea Green, White River Junction, VT.
  96. Steyr Presents Dedicated Natural Gas Tractor, <http://www.ngvglobal.com/steyr-presents-dedicated-natural-gas-tractor-1130>, last accessed June 26, 2014.
  97. Steyr Profi tractor brochure, <http://www1.steyr-traktoren.com/Pages/en/Traktoren/Profi/Galerie-Downloads/Media-Gallery.aspx>, last accessed February 4, 2014.
  98. "TUFFSHELL Type 4 CNG tanks and ground storage," Hexagon Lincoln, <http://www.hexagonlincoln.com/downloads>, last accessed February 4, 2014.
  99. "New Holland Methane Power Tractor," [http://agriculture.newholland.com/ir/en/WNH/CEL/Pages/methane.aspx#gallery\[ImageZone\\_0\]/0/](http://agriculture.newholland.com/ir/en/WNH/CEL/Pages/methane.aspx#gallery[ImageZone_0]/0/), last accessed May 21, 2014.
  100. He Burns Natural Gas in Diesel Tractors, [http://www.farmshow.com/view\\_articles.php?a\\_id=1399](http://www.farmshow.com/view_articles.php?a_id=1399), last accessed June 26, 2014.
  101. Valtra presents a biogas tractor powered by a six-cylinder SCR engine, <http://www.valtra.us/news/5303.asp>.
  102. 6D Series Tractors, [http://www.deere.com/en\\_US/docs/html/brochures/publication.html?id=6a65d22c#29](http://www.deere.com/en_US/docs/html/brochures/publication.html?id=6a65d22c#29), last accessed June 26, 2014.
  103. Energy Information Administration, Annual Energy Review 2011, 2012, U.S. Department of Energy.
  104. Energy Content in Common Energy Sources, [http://www.engineeringtoolbox.com/energy-content-d\\_868.html](http://www.engineeringtoolbox.com/energy-content-d_868.html), last accessed June 26, 2014.
  105. Energy Information Administration, Annual Energy Outlook, 2013, U.S. Department of Energy.
  106. *World Energy Outlook 2012*, 2012, International Energy Agency.
  107. Natural Gas Fueling Station Locations, [http://www.afdc.energy.gov/fuels/natural\\_gas\\_locations.html](http://www.afdc.energy.gov/fuels/natural_gas_locations.html), last accessed June 26, 2014.
  108. Public Retail Gasoline Stations by Year, [http://www.afdc.energy.gov/data/tab/all/data\\_set/10333](http://www.afdc.energy.gov/data/tab/all/data_set/10333), last accessed June 26, 2014.
  109. NGVs for Consumers, [http://www.ngvc.org/about\\_ngv/for\\_consumers.html](http://www.ngvc.org/about_ngv/for_consumers.html), last accessed June 26, 2014.

110. Refueling Appliances, <http://www.impcoautomotive.com/index.php?pagename=fuelmaker>, last accessed June 26, 2014.
111. Compressed Natural Gas Fueling Stations, [http://www.afdc.energy.gov/fuels/natural\\_gas\\_cng\\_stations.html](http://www.afdc.energy.gov/fuels/natural_gas_cng_stations.html), last accessed June 26, 2014.
112. Natural Gas Fueling Infrastructure Development, [http://www.afdc.energy.gov/fuels/natural\\_gas\\_infrastructure.html](http://www.afdc.energy.gov/fuels/natural_gas_infrastructure.html), last accessed June 26, 2014.
113. CNG Tanks Online CNGARC58, <http://cngtanksonline.com/product/cngarc58/>, last accessed June 26, 2014.
114. TUFFSHELL® CNG Fuel Storage Overview, <http://hexagonlincoln.com/products/tuffshell-cng-fuel-tanks/>, last accessed June 26, 2014.
115. LNG Vehicles Are In It for the Long Haul, <http://members.questline.com/Article.aspx?articleID=20703&accountID=4813&nl=12190>.
116. Krupnick, A., 2010, *Energy, Greenhouse Gas, and Economic Implications of Natural Gas Truck*, National Energy Policy Institute.
117. Nation's Largest Alternative-Fuel Fleet Delivers the Goods for the U.S. Postal Service, [http://www.afdc.energy.gov/pdfs/usps\\_cs.pdf](http://www.afdc.energy.gov/pdfs/usps_cs.pdf), last accessed June 26, 2014.
118. LNG Fact Sheet, <http://pressroom.ups.com/Fact+Sheets/ci.LNG+Fact+Sheet.print>, last accessed June 26, 2014.
119. Walmart U.S. truck fleet, <http://www.walmartstores.com/sites/responsibility-report/2012/fleetImprovements.aspx>.
120. Natural Gas Vehicles Get High Marks, <http://www.ngvamerica.org/pdfs/marketplace/mp.marketingtools.p.8.pdf>, last accessed June 26, 2014.
121. Tulsa Public Schools Gives CNG Buses A Second Try, <http://www.newson6.com/story/13146178/tulsa-public-schools-gives-cng-buses-a-second-try>, last accessed June 26, 2014.
122. Tulsa Transit unveils CNG powered buses, [http://www.tulsaworld.com/article.aspx/Tulsa\\_Transit\\_unveils\\_CNG\\_powered\\_buses/20111014\\_11\\_a1\\_cutlin3039](http://www.tulsaworld.com/article.aspx/Tulsa_Transit_unveils_CNG_powered_buses/20111014_11_a1_cutlin3039).
123. "Volvo Trucks Commercializing DME-Fueled Trucks in North America," 2013, *OEM Off-Highway Magazine*, [http://www.oemoffhighway.com/press\\_release/10956748/volvo-trucks-commercializing-dme-fueled-trucks-in-north-america](http://www.oemoffhighway.com/press_release/10956748/volvo-trucks-commercializing-dme-fueled-trucks-in-north-america), last accessed January 21, 2014.
124. "Oberon Fuels Launching Fuel-Grade DME Facilities in June," 2013, *OEM Off-Highway Magazine*, [http://www.oemoffhighway.com/press\\_release/10959435/oberon-fuels-launching-fuel-grade-dme-facilities-in-june](http://www.oemoffhighway.com/press_release/10959435/oberon-fuels-launching-fuel-grade-dme-facilities-in-june), last accessed January 21, 2014.
125. Grisso, R. D., J. V. Perumpral, and F. M. Zoz, 2007, "Spreadsheet for Matching Tractors and Drawn Implements," *Applied Engineering in Agriculture*, 23(3): 259-265, American Society of Agricultural and Biological Systems Engineers, ISSN 0883-8542.
126. Clark, S. R., B. Nafziger, and D. Soldan, 2012, "Field Efficiency Gauge," U.S. Patent Application Publication No. US 2012/0274460 A1.
127. Claas, TONI - Telematics on Implements, [http://www.claas-agrosystems.com/fileadmin/AGROCOM\\_FILES/uploads/GB\\_TONI\\_111124.pdf](http://www.claas-agrosystems.com/fileadmin/AGROCOM_FILES/uploads/GB_TONI_111124.pdf), last accessed January 15, 2014.

128. Claas, CEMOS Automatic control system, <http://www.claasofamerica.com/product/channel/lexion-780-730/electronics-operation/ceмос>, last accessed January 16, 2014.
129. “What’s Next – A to Z of Ag Technology,” 2013, *Farm Industry News*, <http://farministrynews.com/datasheet/whats-next-z-ag-technology>, last accessed June 23, 2014.
130. Vermeulen, G. D., J. N. Tullbert, and W. C. T. Chamen, 2010, “Chapter 8 Controlled Traffic Farming,” *Soil Engineering, Soil Biology 20*, DOI 10.1007/978-3-642-03681-1\_8, 113-114.
131. University of Illinois Extension, 2006, “Farm economics facts and opinions: costs and fuel use for alternative tillage systems,” University of Illinois at Urbana-Champaign.
132. Osei, E., 2007, “Application of a Farm-Level Economic Simulation Model to Evaluate Tillage Practices,” ASABE Publication Number 701P0207.
133. Griffith, D. R. and S. D. Parsons, 1983, “Energy Requirements for Various Tillage-Planting Systems,” Purdue University Cooperative Extension Service, <http://www.extension.purdue.edu/extmedia/NCR/NCR-202-W.html>.
134. “Conservation Practices that Save - Precision Agriculture,” Natural Resources Conservation Service, 2006, [http://www.nrcs.usda.gov/wps/portal/nrcs/detailfull/national/energy/?cid=nrcs143\\_023632](http://www.nrcs.usda.gov/wps/portal/nrcs/detailfull/national/energy/?cid=nrcs143_023632), last accessed January 16, 2014.
135. Bora, G. C., J. F. Nowatzki, and D. C. Roberts, 2012, “Energy savings by adopting precision ag in rural USA,” *Energy, Sustainability and Society*, <http://www.energysustainsoc.com/content/pdf/2192-0567-2-22.pdf>, last accessed January 16, 2014.
136. Shannon, D. K. and C. E. Ellis, 2012, “Evaluating GPS Guidance Technologies for Energy Savings,” American Society of Agricultural and Biological Systems Engineers.
137. Luck, J. D., R. S. Zandonadi, B. D. Luck, and S. A. Shearer, 2010, “Reducing pesticide over-application with map-based automatic boom section control on agricultural sprayers,” *Trans. of the ASABE* 53(3): 685-690.
138. USDA NRCS, 2007, “Precision Agriculture: NRCS support for emerging technologies,” [http://www.nrcs.usda.gov/Internet/FSE\\_DOCUMENTS/stelprdb1043474.pdf](http://www.nrcs.usda.gov/Internet/FSE_DOCUMENTS/stelprdb1043474.pdf), last accessed June 15, 2014.
139. Hedley, C. B., I. J. Yule, M. P. Tuohy, and I. Vogeler, 2009, “Key Performance Indicators for Simulated Variable-Rate Irrigation of Variable Soils in Humid Regions,” *Trans. of the ASABE*. 52, 5: 1575-1584.
140. Fulton, J. P., L. G. Wells, S. A. Shearer, and R. I. Barnhisel, 1996, *Spatial Variation of Soil Physical Properties: A Precursor to Precision Tillage*, ASAE Paper No. 961002, International Meeting, Phoenix, Arizona.
141. Khalilian, A., Y. J. Han, R. B. Dodd, Mike J. Sullivan, S. Gorucu, and M. Keskin, 2002, “A Control System for Variable Depth Tillage,” ASAE Paper No. 021209, St. Joseph, Mich.
142. Alimardani, R., Y. Abbaspour-Gilandeh, A. Khalilian, A. Keyhani, and S. H. Sadati, 2007, “Energy Savings with Variable-Depth Tillage—A Precision Farming Practice,” *American-Eurasian Journal of Agricultural & Environmental Sciences* 2,4:442-447.
143. Raper, R. L., D. W. Reeves, J. N. Shaw, E. van Santen, and P. L. Mask, 2005, “Using Site-Specific Subsoiling to Minimize Draft and Optimize Corn Yields,” *Transactions of the ASAE*, 48, 6: 2047-2052.

144. Wehrspann, J., "Another Step Toward Site-Specific Tillage," *Farm Industry News*, <http://farministrynews.com/blog/another-step-toward-site-specific-tillage>, last accessed June 19, 2014.
145. "Features and Specifications," Autonomous Tractor Corporation, <http://www.autonomoustractor.com/features2.html>, last accessed May 12, 2014.
146. McMahon, K., 2013, "An Idea for Autonomous Implements," PF-7, *The Progressive Farmer*.
147. Hirsch, J., "This Tractor Drives Itself," *Modern Farmer*, <http://modernfarmer.com/2013/04/this-tractor-drives-itself/>, last accessed May 12, 2014.
148. Palmer, R. J., D. Wild, and K. Runtz, 2003, "Improving the Efficiency of Field Operations," *Biosystems Engineering*, 84, 3: 283-288, ISSN 1537-5110.
149. Kondekar, R., "Method and system for determining a planned path of a vehicle," Deere & Company, U.S. Patent Number US8498788B2.
150. Oksanen, T. and A. Visala, 2009, "Coverage path planning algorithms for agricultural field machines," *J. of Field Robotics*. 26, 8: 651-668.
151. Zandonadi, R. S, J. D. Luck, T. S. Stombaugh, M. P. Sama, and S. A. Shearer, 2011, "A computational tool for estimating off-target application areas in agricultural fields," *Trans. ASABE* 54, 1: 41-49.
152. Schardt, W. 2014, "Analysis and Validation of Grain and Biomass Harvesting Simulation Model," Master's Thesis, University of Nebraska-Lincoln, not yet published.

## **Appendix A,**

### **OEM Survey**

The Association of Equipment Manufacturers, on behalf of NTTL, administered a survey of OEMs. Survey participants were informed that this survey was part of a project for the Advanced Vehicle Testing Activity Program sponsored by the Department of Energy's Vehicles Technology Program and it was intended to identify component, system, machine, and cropping-system level information to identify areas with the highest potential for reduction in petroleum use in off-road agricultural machinery. Survey responses remain anonymous and represent status, position, views, and attitudes of the organization being surveyed, not necessarily those of the individual completing the survey. Survey responses are provided in this appendix.

**1) Your organization would be classified as which of the following with regard to off-road agricultural equipment (indicate all that apply):**

<b>Answer Options</b>	<b>Response Count*</b>
Manufacturer of self-propelled equipment (tractors, harvesters, sprayers, etc.)	13
Manufacturer of agricultural implements or attachments (tillage tools, planters, hay tools, etc.)	7
Manufacturer of engines and engine components	8
Manufacturer of powertrain components/systems	6
Manufacturer of hydraulic components/systems	3
Manufacturer of electronic components/systems	4
Manufacturer of machine control components/systems (including precision ag, GPS, etc.)	2
Manufacturer of maintenance and aftermarket components	3
Off-road ag machinery dealer or service	1
	<b>Answered question 27</b>
	<b>Skipped question 0</b>
<b>Other (please specify)</b>	

Off highway construction equipment – cranes

Manufacturer of access equipment and rough terrain forklifts

Manufacturer of off-highway cranes

Consulting firm representing global engine, equipment, and component manufacturers to comply with United States

Environmental Protection Agency and California ARB emission control requirements

Not involved in ag business; manufacturer of steel tubing

\* Note: Some survey respondents indicated multiple categories.



2) Indicate what your organization perceives to be the preference of your customers for increased fuel efficiency (gallons of fuel per acre) vs.

Answer Options	Improved Fuel Efficiency (gallons per acre)			Improved Productivity (acres per hour)			NA	Rating Average	Response Count
	1	2	3	4	5	6			
	0	1	3	5	2	2	10	4.1	23
								<i>Answered Question</i>	<b>23</b>
								<i>Skipped Question</i>	<b>4</b>

**Comments**

Fuel and productivity are both important to customers.

Customers want improved productivity with good fuel efficiency. They go hand-in-hand and not one or the other.

Our customers are looking for improvements during machine idling times and conservation during operations; customers expect both.

3) Rank each alternative fuel with regard to the potential your organization perceives for it to become a significant percentage of fuel used for off-road agriculture.

Answer Options	No Potential			High Potential			NA	Rating Average	Response Count
	1	2	3	4	5	6			
Biodiesel	0	0	2	0	7	6	2	5.1	17
Ethanol	1	2	3	3	5	1	2	3.8	17
Compressed natural gas	2	6	3	3	1	1	1	2.9	17
Liquefied natural gas	1	5	5	3	0	0	3	2.7	17
Dimethyl ether	3	5	3	3	0	0	3	2.4	17
Other	3	1	0	1	0	0	12	1.8	17
Hydrogen	7	4	2	0	0	0	4	1.6	17
								<i>Answered Question</i>	<b>17</b>
								<i>Skipped Question</i>	<b>10</b>

**Please specify other or include comments:**

Light fuel such as gasoline is appropriate for smaller equipment to offset complex exhaust aftertreatment systems needed for diesels.

Ethanol is a good complement to lighter fuels (such as gasoline) and its use results in reduced petroleum demand, lower emissions, and lowers environmental impact.

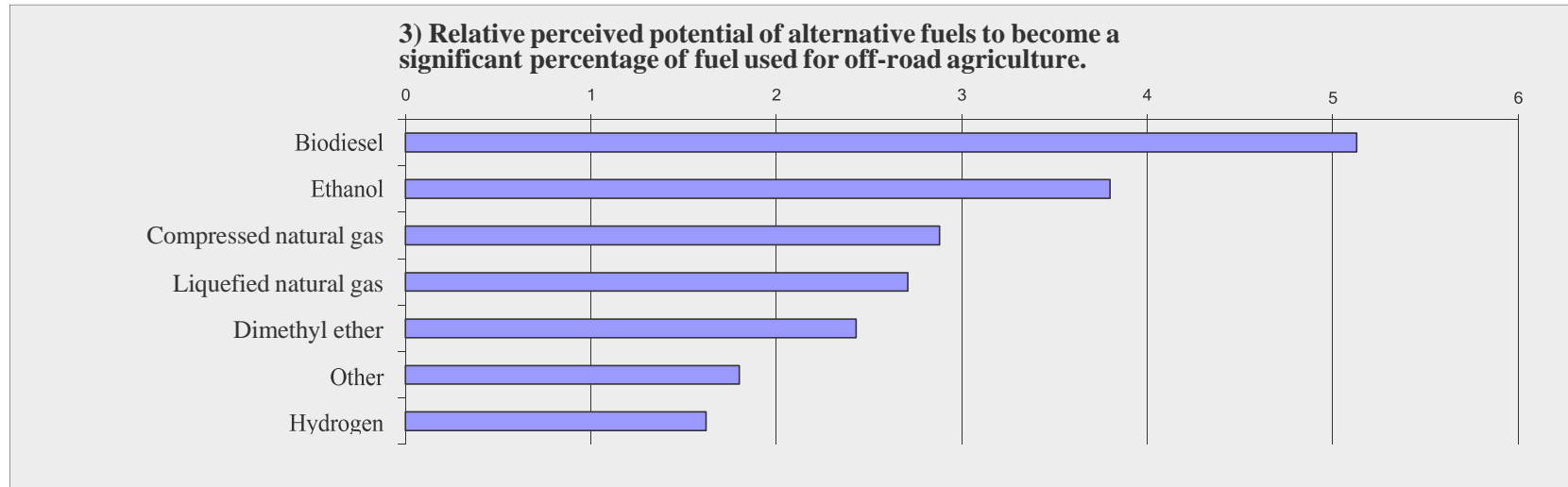

**4) For the following items, indicate their level of significance as barriers to further utilization of alternative fuels.**

Answer Options	Not Significant		Highly Significant				NA	Rating Average	Response Count
	1	2	3	4	5	6			
Cost	1	0	0	1	2	12	1	5.4	17
Production and distribution infrastructure (availability, portability, storage)	0	0	2	0	9	5	1	5.1	17
Customer perception/acceptance	0	0	0	5	5	6	1	5.1	17
Engine technology	1	0	0	4	3	8	1	5.0	17
On-machine storage capacity/fuel energy density	0	0	3	2	6	5	1	4.8	17
Environmental sustainability	0	3	4	3	4	2	1	3.9	17
Other	1	0	0	0	0	0	16	1.0	17
								<i>Answered Question</i>	<b>17</b>
								<i>Skipped Question</i>	<b>10</b>

**Please specify other or include comments:**

Indirect use of alternative fuels is a future consideration in order to satisfy customer needs for storage and energy density, cost and infrastructure issues.

**4) Relative significance as barriers to further utilization of alternative fuels.**



**5) Indicate the potential percent reduction in petroleum use for off-road agricultural machinery for each of the following:**

Answer Options	<1%	1-2%	2-5%	5-10%	10-20%	>20%	NA	Rating Average	Response Count
	1	2	3	4	5	6			
Innovations in primary power generation (engine and sub systems)	1	0	2	3	5	1	2	4.2	14
Innovations in powertrain (transmission, axles, CVT, electric drive, etc.)	1	1	4	3	3	0	2	3.5	14
Engine idle shutdown strategies	0	2	4	4	2	0	2	3.5	14
Alternative fuels	2	2	0	2	3	1	4	3.5	14
Cropping system practices/management (tillage practices, etc.)	0	3	3	2	2	0	4	3.3	14
Innovations in precision ag technologies (GPS guidance, variable rate, machine-to-machine communication, etc.)	1	0	7	4	0	0	2	3.2	14
Advanced operator training to improve equipment use efficiency (shift-up-throttle-back, reduce idle time. etc.)	0	4	2	6	0	0	2	3.2	14
Field operation planning/optimization techniques (improved field efficiency and equipment utilization)	1	1	5	5	0	0	2	3.2	14
Advancements in hydraulic power systems	2	0	8	1	0	1	2	3.0	14
Improvements in equipment fleet management (matching equipment sizes, telematics, etc.)	0	5	4	2	1	0	2	2.9	14
Advanced machine controls and system integration (tractor level and/or implement level)	1	3	5	1	1	0	3	2.8	14
Innovations in tires and/or tracks	2	2	5	3	0	0	2	2.8	14
On-machine energy recovery and storage (electric, hydraulic, mechanical)	2	3	3	4	0	0	2	2.8	14
Innovations in attachments and implements	0	5	4	2	0	0	3	2.7	14
Advancements in PTO power systems	3	1	5	0	1	0	4	2.5	14
Extended oil change intervals	3	4	4	1	0	0	2	2.3	14
Electrification of tractors and implements (for accessory or implement drives other than primary propulsion)	3	4	3	1	0	0	3	2.2	14
Active tire pressure management	5	1	4	1	0	0	3	2.1	14
Improved machine/component efficiencies via retrofit of existing equipment	2	7	1	0	0	0	4	1.9	14
Other	1	0	0	0	0	0	13	1.0	14
<i>Answered question</i>									<b>14</b>
<i>Skipped question</i>									<b>13</b>
<b>Please specify other or include comments:</b>									

Note that the categories above are not totally additive, some contribute to the same savings.

5) Relative potential reduction in petroleum use for off-road agricultural machinery.

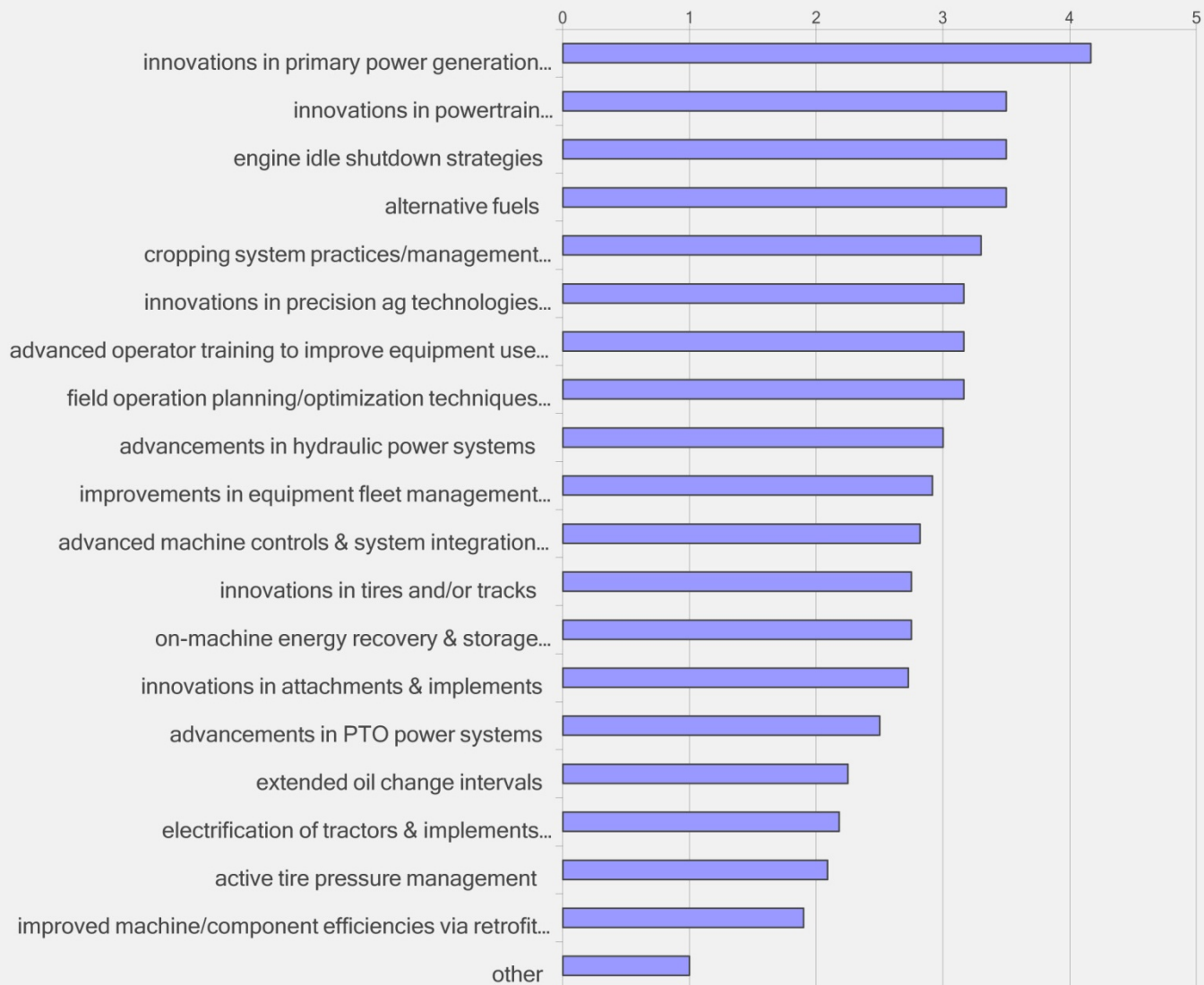

**6) For the following items, indicate their level of significance as barriers to reducing petroleum consumption in off-road agricultural equipment systems:**

Answer Options	Not Significant			Highly Significant			NA	Rating Average	Response Count
	1	2	3	4	5	6			
Availability of alternative fuels (local availability, distribution, portability, storage)	0	0	0	3	5	4	1	5.1	13
Customer perceptions and acceptance of new technology, alternative fuels	0	0	1	2	5	4	1	5.0	13
Regulatory factors	0	1	0	2	5	4	1	4.9	13
Total cost of ownership for high-efficiency machinery	0	0	3	1	4	4	1	4.8	13
Research funding	0	2	0	2	4	4	1	4.7	13
Physical resources for research and development (infrastructure/facilities, etc.)	0	0	2	3	5	2	1	4.6	13
Consumer cultural and behavioral attitudes and preferences (farming practices, etc.)	0	0	1	6	2	3	1	4.6	13
Fuel/petroleum prices	0	1	3	1	2	5	1	4.6	13
Manufacturing costs	0	2	0	2	5	3	1	4.6	13
Customer understanding of how to optimize equipment performance	0	1	1	3	5	2	1	4.5	13
On-machine energy storage capability (for hybrid technologies)	0	0	2	5	4	1	1	4.3	13
Ability of market forces to drive development of equipment that uses less petroleum	0	2	1	1	1	1	1	4.3	13
Product differentiation for global markets	1	1	3	1	2	4	1	4.2	13
Manufacturing capabilities and technologies	0	2	2	2	5	1	1	4.1	13
Theoretical design limits	1	0	3	4	3	1	1	3.9	13
Lack of adequate public-private partnerships (for technology research, educating consumers, etc.)	1	2	2	2	2	3	1	3.9	13
Consumers do not have adequate access to, or understanding of equipment efficiency information needed to select the most efficient equipment for their operation	0	2	3	4	2	1	1	3.8	13
Competent/qualified workforce	1	2	2	3	3	1	1	3.7	13
Wireless infrastructure for machine-to-machine communication	1	1	4	2	3	1	1	3.7	13
Current test procedures do not adequately measure ag machinery efficiency	1	1	2	2	2	0	5	3.4	13
Other	1	0	0	0	0	0	12	1.0	13

**Answered question 13**

**Skipped question 14**

**Please specify other or include comments:**

Use of lifecycle engineering and systems engineering should be applied to reduce overall fuel needed per unit of useful work performed. Note that lower petroleum consumed is not necessarily the lower environmental impact pathway.

6) Relative significance as barriers to reducing petroleum consumption in off-road agricultural equipment systems:

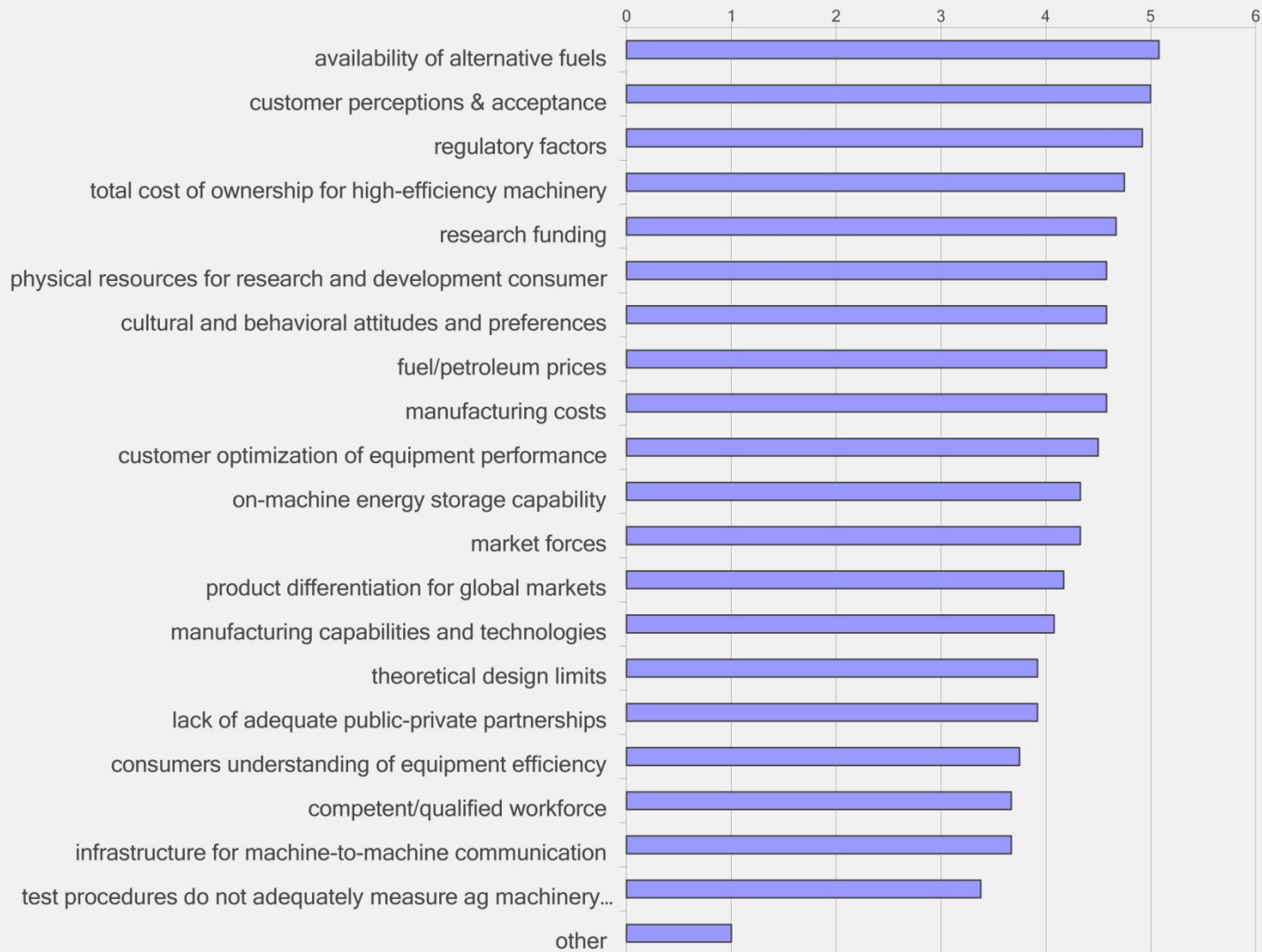



**7) Does your organization have data documenting typical equipment use patterns or equipment work cycles by equipment type (i.e., work cycle segment times, fuel consumption, power demands: PTO, hydraulic, and drawbar power requirements, productivity/throughput, etc.)?**

Answer Options	Yes	No	NA	Response Count
Tractor operations	6	3	4	13
Implement systems (tillage, planting, hay tools, etc.)	4	5	4	13
Self-propelled applicators (liquid or dry)	2	4	7	13
Self-propelled harvesters (combines, forage harvesters, etc.)	2	3	8	13
On-farm material handling (grain carts, hay/forage movers, grain)	1	5	7	13
Other	1	0	12	13
<i>Answered Question</i>				<b>13</b>
<i>Skipped Question</i>				<b>14</b>

**8) Please include general comments or list other technologies your organization feels may contribute to improving fuel efficiency for off-road agricultural machinery:**

Answer Options	Response Count
	1
<i>Answered Question</i>	
<b>1</b>	
<i>Skipped Question</i>	
<b>26</b>	

**Response text:**

Hybrid technologies