

# Pig keeping in the tropics

Agrodok 1 - Pig keeping in the tropics

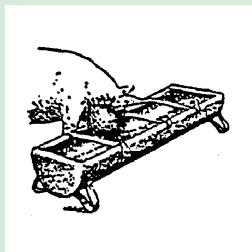
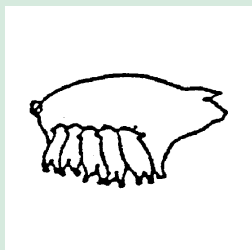

# **Agrodok 1**

## **Pig keeping in the tropics**

Dick Muys  
Geert Westenbrink

© Agromisa Foundation, Wageningen, 2004.

*All rights reserved. No part of this book may be reproduced in any form, by print, photocopy, microfilm or any other means, without written permission from the publisher.*

First edition in English: 1984

Third (revised) edition: 1998

Fourth edition: 2002

Fifth edition: 2004

Authors: Dick Muys, Geert Westenbrink

Editor: Rienke Nieuwenhuis

Illustrator: Barbera Oranje

Design: Janneke Reijnders

Translation: Mrs. M. Verheij and R. Corner

Printed by: Digigrafi, Wageningen, The Netherlands

ISBN: 90-77073-53-1

NUGI: 835

# Foreword

This revised edition has been made possible thanks to the contributions by Mr Arie Wingelaar and Mrs Marista da Silva of the IPC Livestock, the International Training Centre for Animal Husbandry in Barneveld, the Netherlands.

We also wish to thank the co-workers of Agromisa who have contributed their time and effort to this Agrodok: Mr Arno Overgraag, Agromisa's livestock specialist, offered important suggestions and contributions for improvements to this edition, whilst Barbera Oranje was responsible for the illustrations and Edwin Nuijten for the lay-out.

Rienke Nieuwenhuis, editor  
Wageningen 1998

# Contents

<b>1</b>	<b>Introduction</b>	<b>6</b>
<b>2</b>	<b>Pig keeping systems</b>	<b>9</b>
2.1	Free-range 'scavenging' pig keeping	9
2.2	Semi-intensive pig keeping	12
2.3	Small-scale intensive pig keeping	16
<b>3</b>	<b>Housing</b>	<b>19</b>
3.1	Climate	19
3.2	Technical requirements for good housing	22
3.3	Feeding and water troughs	26
3.4	Sizes of pens and runs	28
3.5	Housing the sow and her piglets	29
3.6	Housing fattening pigs	31
3.7	Using liquid manure and dung	31
<b>4</b>	<b>Pig breeding</b>	<b>33</b>
4.1	Managing the sows	33
4.2	Selecting and working the boar	36
4.3	The birth and care of the new-born piglets	38
4.4	Problems related to the birth	41
4.5	Rearing motherless piglets by hand	44
4.6	Looking after and weaning piglets	46
4.7	Record-keeping	48
<b>5</b>	<b>Fertility disorders</b>	<b>53</b>
5.1	Poor oestrus show in sows	53
5.2	Diseases leading to fertility disorders	54
<b>6</b>	<b>Pig feeding</b>	<b>56</b>
6.1	Introduction	56
6.2	Nutritional requirements	57
6.3	Sources of energy, protein, minerals and vitamins	58

6.4	Feeding in practice	59
6.5	Feeding pigs, from weaning onwards	60
6.6	Feeding a sow and her piglets	62
<b>7</b>	<b>Diseases, prevention and control</b>	<b>64</b>
7.1	Prevention by promoting natural resistance	65
7.2	Disease-causing organisms	66
7.3	The use of medicines	67
7.4	Parasitic diseases	70
7.5	Bacterial diseases	72
7.6	Viral diseases	74
7.7	Feed-related diseases	76
7.8	Sunstroke	76
	<b>Further reading</b>	<b>77</b>
	<b>Useful addresses</b>	<b>78</b>
	<b>Glossary</b>	<b>80</b>

# 1 Introduction

Pigs and pig keeping in one form or another can be found almost anywhere in the world. Especially of course in country areas it is common for communities to have pigs rooting and roaming freely around the dwellings, to be brought in one day as household needs require. Pig keeping enterprises are also to be found in and around towns and cities, and they play an important role in feeding urban populations.

This Agrodok looks at three typical pig-keeping systems:

- Free-range scavenging pig keeping:  
A more or less extensive system whose main purpose is to guarantee the household emergency fall-back funds, whilst also supplying it with a little meat from time to time, without any major investment of time or money. This domestic scale is very typical of small farmer mixed holdings.
- Semi-intensive pig keeping:  
A system differing from the above in that the animals are housed and more attention is paid to their health and feeding. Its aims remain those of domestic pig keeping, but given a modest amount of inputs, its production is higher.
- Intensive pig keeping:  
Which aims at producing meat for the market efficiently and profitably, usually with larger numbers of pigs. This type of system requires significant inputs of time and money, with careful calculation of the costs and the resulting benefits.

We will consider the main characteristics of each of these systems, the purposes they serve, and the methods employed, as well as noting their limits and the ways of improving them. There are of course any number of systems in pig keeping. The three models we describe give an idea of the options available and the developments possible to

make the transition from extensive to intensive management, with the points to watch out for.

This book is particularly written for those who may find themselves advising farmers involved in pig keeping. This does not mean that those who wish themselves to set up or make changes to an existing system will not profit from the information provided.

Anyone who is considering keeping pigs, or improving an existing system, must before anything else be clear about the situation on the ground, the resources available and the constraints, in order to decide on the type of system to introduce in practice.

Advisors will first try to identify the resources available to improve a system's productivity, working initially on the basis of a small number of animals and the means of production available locally. If this is successful, and there is sufficient demand, the system can be developed further. It must nevertheless be borne in mind that genuinely intensive pig farming requires major investment, and that there are great risks if such investment is not backed up with the necessary experience and technical knowledge.

It is therefore all the more important for farmers inexperienced but interested in this domain to establish their base progressively. They would be best advised starting up with a semi-intensive approach, concentrating above all on establishing good housing and proper feeding routines for a small group of healthy animals, taking proper advantage of all locally available resources.

### **Agrodok summary**

The three systems of pig keeping are presented in Chapter 2, with the various possibilities for improvement.

Chapter 3 looks at housing: why is this such an important element in the system, and what makes for good pig housing? It outlines the various parts of a piggery and deals with the installations required for feeding and farrowing. It also considers the housing requirements of the sow and her piglets, and of the fatteners.



Chapter 4 turns to the question of animal management, covering the management of the mother sows and the boar(s), the birth of the piglets and potential problems, the care of the piglets (including teeth-trimming and castration), and finally the important question of management records.

Chapter 5 takes a brief look at oestrus show and fertility disorders, whilst feeding is the main preoccupation of Chapter 6 - nutritional requirements, how to meet them, practical aspects of feeding and the feeding of sows nursing a litter.

Finally Chapter 7 concerns the main diseases that may unfortunately be encountered. Preventive measures are detailed, and a number of general remarks on the use of medicines are made. The symptoms of the diseases are described and indications are given of the treatment possible.

## 2 Pig keeping systems

### 2.1 Free-range 'scavenging' pig keeping

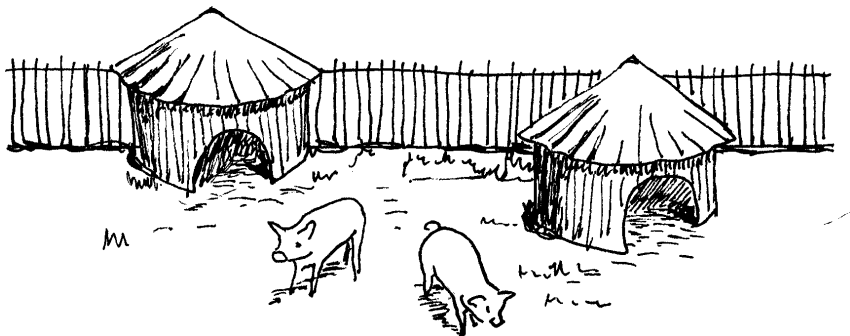

*Figure 1: Free-range pig keeping (after Holnes, 1991).*

#### **Main characteristics**

The main characteristic of this system is that the pigs move freely around the house and surroundings, scavenging and finding for themselves a large part of their food. Often the food they collect is supplemented with kitchen refuse or agricultural waste products.

Few or no arrangements are made to provide the pigs with shelter, and no money is invested in quality food or medical services.

Local breeds are commonly used, since they are more tolerant of low-quality feed and have a higher resistance to diseases. In general there is no attempt to improve production by selective breeding or any other means.

In some cases the pigs are not bred on the farm: piglets are brought in and are fattened during a season when food is plentiful, for sale at a later date.

#### **Production goals**

In most cases the pigs are not kept to provide meat for the household, nor as a regular source of cash income (if there is any cash income this comes from other activities). The importance of scavenging pigs is

rather as a 'savings account' or 'insurance policy' i.e. they are only sold when extra cash is needed (e.g. for buying seeds or fertiliser, at times of illness or family festivity, to pay school fees, to make up for a lost harvest etc.). In this way loans (with the associated problems of high interest rates and repayment) can be avoided.

Pigs can also play a specific role in social life, when at weddings and other festivities they are presented as gifts or offered as food.

### **Socio-economic aspects**

Traditionally pigs are often owned or kept by women (and/or children), with the result that any financial benefits usually go towards the needs of the household. It also has the effect of strengthening the women's economic position.

Keeping scavenging pigs requires a minimum amount of inputs. The financial risks involved in this system are small, with little money being invested and little time spent looking after the pigs.

### **Potential for improvement**

The main constraints with scavenging pigs are the high rates of piglet loss, and slow growth rates. Pigs kept in a free-range system will not grow quickly, because they expend a lot of energy in their scavenging activities. Worm infestation is also an important problem resulting in slower growth rates.

#### ➤ *Enclosing the pigs*

Enclosing your animals can lead to improved management. Keeping pigs together by fencing a piece of land may be difficult to introduce, but it is the first thing to do if you are aiming to bring piglet death rates down, reduce the energy lost in scavenging, and improve the health and growth rates of your pigs. To make a fence, strong wire netting is ideal, but you can also use local materials such as bamboo, thorny shrubs, tree trunks etc. The fence must be sufficiently dense that even the small piglets cannot escape.

Shade is essential. If there are no trees or other source of shade a small shelter must be provided (Figure 1). The animals can also

shelter there when it rains heavily. The structure can be as simple as four solid tree trunks with a roof on top.

Further improvements can be made by separating the animals into different groups according to their final purpose. Animals for fattening and not for breeding should be kept enclosed. For these animals rapid growth is important. By caring for them well, in a small clean pen if possible, higher growth rates are possible than for animals left to roam outside. Most of the breeding stock however can be left outside. The pregnant sows should be separated from the others just before farrowing and brought inside to deliver. With proper housing a greater number of piglets will thrive.

➤ *Feeding the pigs*

Providing scavenging pigs with extra feed will improve their growth. Root crops and almost any village refuse can be fed. If the pigs are enclosed, part of the land can be used for growing green fodder. At the same time there must always be an adequate supply of fresh drinking water available for them.

➤ *Prevention of worms*

Parasites pose a serious problem when keeping pigs outside, as the wet tropics provide ideal conditions for them. Worms are the most common parasites. A pig infected with worms will be in poor health and will grow very slowly. If the pigs are kept in an enclosure, measures must be taken to control the levels of worm infestation. This is explained in the next section (2.2).

## 2.2 Semi-intensive pig keeping

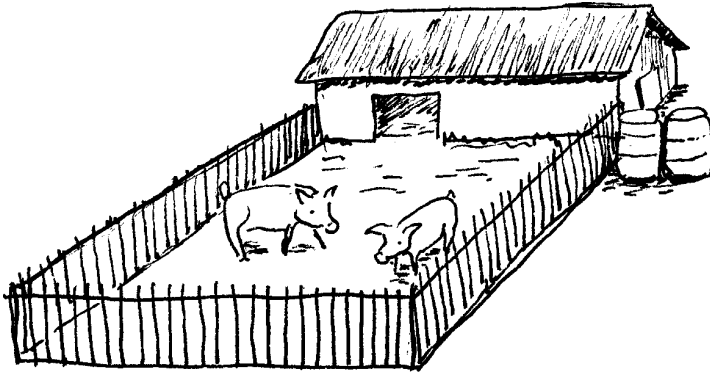

*Figure 2: Semi-intensive pig keeping (after Holnes, 1991).*

### **Main characteristics**

In semi-intensive systems pigs are confined to a limited space. This means that they cannot gather their own food and are completely dependent upon their keeper. Once or twice a day fresh water and fodder (usually kitchen refuse or agricultural waste) have to be brought to the pigs. This system of pig keeping opens up possibilities for improved feed and disease control, which in turn can result in faster growing and healthier pigs and/or in larger litters.

Apart from the economic reasons there are also some very practical reasons for keeping the animals tethered or enclosed. It prevents crops from being damaged by the pigs for example, and it reduces the risk of the pigs being stolen.

Although this system of pig keeping demands only low financial inputs, more time and effort needs to be spent on the pigs. More technical knowledge is also required.

### **Production goals**

In general the creation of a ‘savings account’ or ‘insurance policy’ remains the most important strategy underlying this form of pig

keeping. Nevertheless in areas close to urban centres or on main traffic routes for example, where it is possible to sell pigs more regularly, small-holders (often women) will have intensified their pig keeping by adopting the semi-intensive approach.

### **Socio-economic aspects**

The introduction of a commercial approach may have an impact on the balance of income earned within a family. The result is often to the detriment of the women and children. For if, traditionally, women were involved in pig keeping, it is often the men who get involved when the pigs become commercially interesting. This comes about because the extension services are often reluctant to work with women, and because the women themselves are often obliged to make applications to or through their menfolk for access to credit or land, or for help with construction work or farm-related book-keeping. This process leaves women less able to decide for themselves what will be done with the animals and the cash income earned; this reduces their independence.

### **Potential for improvement**

Improvements to semi-intensive systems are made by focusing attention on feeding and health care practices, and by selective breeding.

#### ➤ *Feeding*

A first and simple step can be taken by making sure that the available feedstuff is properly distributed. It is important that the best of the feedstuff be given to the pregnant and the nursing sows (who supply your future breeding stock), and also to the piglets that have just been weaned so that they get off to a good start in life.

A further improvement to be made is to raise the quality of the feed by adding to the basic ration. For this see Chapter 6, which deals with feeding issues. If additional feed has to be bought in, you should first consider whether the advantages really justify the cost. This will depend on several factors, such as the quality of your meat

and the price you finally obtain for it, and the total cost of bringing in and storing the feed.

➤ *Breeding*

A farmer can improve the quality of new stock by choosing the right animals to breed from (selective breeding). If nursing sows and their piglets are kept separate from the others, it will be easier to select the stronger piglets for breeding. The remaining piglets can be fattened for sale or for slaughter.

Once you have started separating out the best sows for breeding (see Paragraph 4.1), giving them good housing and proper attention, you have taken the essential steps towards improved breeding practice. And once this is achieved it could be worthwhile investing in a good boar to produce strong healthy litters. Buying a boar is a serious investment, as it involves a number of costs - travelling in search of a good animal, transport costs, purchase price... The costs can only be recovered if conditions on the farm allow.

The purchase of a boar is a project that a group of farmers may wish to undertake together. It is also very useful to exchange boars between neighbouring villages, in order to avoid the problems of in-breeding.

This level of management however demands more knowledge, experience and time, in the keeping of records for example or routine checks for heat etc. See Chapter 4 for more information on improving breeding.

➤ *Prevention of worms*

We mentioned above the problem of worm infestation in outdoor pigs. In fact the adult worms live and develop inside the pig, laying eggs which are excreted with the faeces onto the soil. Given the right temperature and humidity, larvae emerge from the eggs and will probably be eaten again by the grazing pig. These larvae can even penetrate into and cross the animal's skin. Once inside the pig, they grow into mature worms again and the cycle can start again.

The eggs and the larvae in the soil can die out after a while if sufficient time passes for them to dry out under the sun. As a result of this the risk of serious parasite build-up in the field can be reduced by regularly changing the grazing area. If possible the animals should be given a fresh piece of ground about every 14 days. In dry periods the animals can stay longer in the same field because the worms do not develop so quickly.

After a period of grazing the field should be left empty for a while to allow the larvae to die. In the wet season it is better to leave a field for about 2.5 to 3 months before re-using it; in the dry season when the larvae and eggs die more quickly, the field can be used again after 2 months. With this system, changing the enclosure every two weeks requires at least four different fields, which is expensive. If there is a shortage of land, in some areas a simple pigsty can be made to keep the pigs in during the wet season. By letting the pigs out in the dry season only, less land will be required. Animals kept outside will always be slightly contaminated with worms. Some infestation in older animals is not serious, as these animals usually have some natural resistance. Young piglets however are very vulnerable. To prevent young piglets from being infected directly after birth, the breeding sows should be wormed about 1 week before delivery (treatment which drives out all the worms). After worming, the sows should be washed to ensure that there are no worm eggs clinging to them. They should then be kept inside for delivery.

To prevent re-contamination, the pen should be properly cleaned every day. All this being done, the young piglets stand a good chance of being born into a worm-free environment. See Paragraph 7.4 for more information on this.

➤ *Use of pig manure*

It is a good idea to use the pig fields occasionally for crops, as the soil will have been fertilised by the pig manure. This will also clean out the parasites and after a year's cropping the soil should be completely clear again.



## 2.3 Small-scale intensive pig keeping

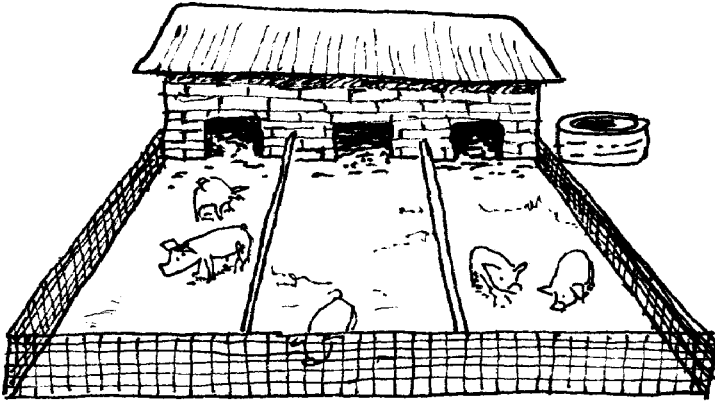

*Figure 3: Small-scale intensive pig keeping (after Holnes, 1991).*

### **Main characteristics**

The main characteristics of an intensive pig keeping system is that pigs are kept in complete confinement. Buildings are provided to keep fatteners, boars, sows, and sows with their litters separate. In this system housing amounts to much more than providing a simple shelter. Larger numbers of pigs may be kept and the pigs must be well managed because commercial commitments have been made. Know-how is required to make the right decisions at the right time. The following chapters in this book provide a lot of this know-how, because they concentrate on the management of small-scale intensive pig keeping.

High investments are required to provide improved buildings, and to buy in feeds and medicines. These are especially necessary if the change towards improved breeds is made.

In this system of pig keeping, kitchen refuse and agricultural waste products will generally not be sufficient to feed the animals, so certain feeds will have to be bought. Buying in extra feed to help the pig grow faster only makes sense if the animal can be marketed earlier than

usual or if heavier animals can be sold, thus earning much higher prices.

Local breeds are often considered to be a cause of low productivity (small litter sizes and slow growth rates). In general, however, these breeds are very well adapted to the local circumstances. Although 'improved' breeds have great potential they make high demands on feed quality and careful husbandry.

Intensive systems are aimed to provide a major source of income for a group or household. The animals no longer function as a savings account but are grown to be marketed. This means that regular access to the market is needed, which might imply dependence on a middleman.

### **Potential for improvement**

The improvement of small-scale intensive systems needs specialised know-how. Progress can be achieved particularly by paying attention to the animals' health and conditions. The stability of the project depends on a new approach to production, as the farmer has to be thinking more and more in terms of the market.

#### ➤ *Marketing*

To render the unit economically viable a completely different approach to keeping pigs is necessary. The animals have to be brought to market when conditions (prices, the pigs' condition etc.) are right. A strategy for optimum buying and selling has to be developed, taking into account the importance of regular transport and dependable sales outlets.

If there are problems or a catastrophe with the pigs (disease or accident for example), an extra financial input will have to be available to keep the unit in operation. This is not typical in traditional pig keeping.

#### ➤ *Technical knowledge*

A local extension service is important as a source of support and technical advice. Veterinary services should also be available when required.

To be able to manage the business correctly proper detailed records must be kept (see Paragraph 4.7).

➤ *Disease control*

If too many pigs are confined together there is a high risk of infection spreading quickly among the animals. For most diseases and infections the organisms causing the disease (bacteria, worms etc.) are found naturally in the animal's environment. A lot of locally bred pigs are infected but have enough natural resistance to stay alive and even to develop. This natural equilibrium can however very easily be disturbed, with the result that the pigs sicken or die. This can be due to changes in the season (in the wet season, parasites are often present in larger numbers), feed shortages (which weaken the animals) or changes in pig keeping routines.

Preventive measures aim at increasing the animals' resistance (for example by improving the quality of the feed) and they aim at reducing the sources of infection, e.g. by keeping a smaller number of animals in the same area or by improved hygiene (providing dry and clean housing, regularly moving the pens etc.). When large numbers of pigs are kept together medicines are sometimes necessary to prevent disease outbreaks. The most essential and powerful tool to combat disease however remains good hygiene.

By ensuring that the pen is always kept clean the chances of infection remain small, and a healthy pig will grow faster than an animal infected with disease. See Chapter 7 for the prevention and control of diseases.

## 3 Housing

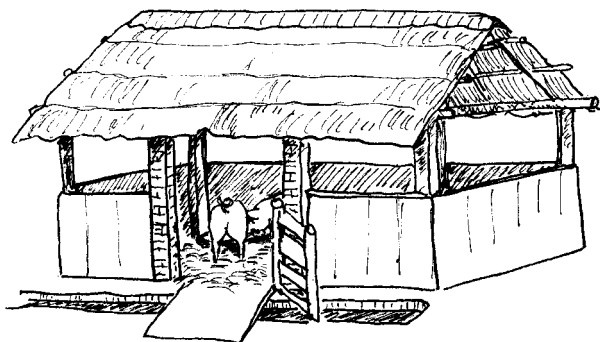

*Figure 4: Pig house (Barbera Oranje).*

In the preceding chapter we indicated that improved housing is an essential factor in the conversion to commercial pig keeping.

There are numerous advantages to keeping pigs inside:

- The animals spend their energy putting on body weight rather than on seeking food and shelter.
- The number of piglets surviving will rise if they are born in secure and healthy surroundings.
- Controlling the health of the pigs is easier if they are housed, since it is easier to maintain good hygiene.
- Feeding routines can be more carefully controlled.
- Manure can be easily collected and used for fertilising land.

In this chapter the necessity for, and the technical aspects of proper pig housing are explained.

### 3.1 Climate

The climate to which a pig is exposed is very important. If a pig is housed this can be controlled to a certain extent. Pigs are very sensitive to sudden changes in temperature. They cannot stand heavy

rain or drought. Strong sunlight is bad for them, as it causes their skin to dry out. Albino pigs especially cannot endure the sun because they have no pigment in the skin and they soon burn. This illustrates the necessity for shade. Pigs kept for optimal production should therefore be protected from climatic stress. This is only possible by ensuring that the animals are well housed.

The most important factor to consider in organising proper housing is temperature. A pig's body temperature can vary with the temperature of its surroundings and a steady body temperature is important for a proper growth rate.

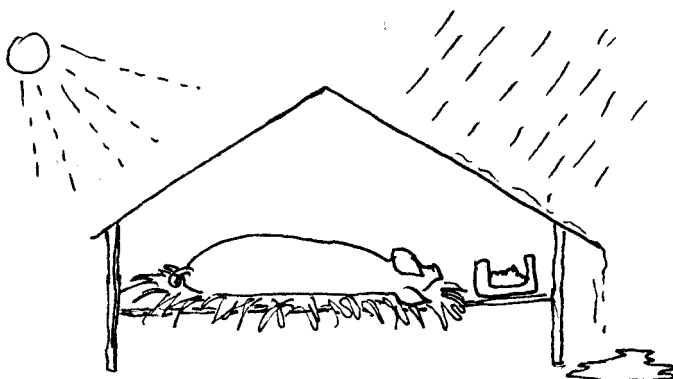

*Figure 5: Protection against climatic influences.*

### **Body temperature**

Every living animal produces heat, when converting its food for the requirements of growth. The more an animal eats, the faster it grows.... and the more heat it produces. Heat is also released when an animal is active (for example, when walking).

Warm-blooded animals (birds and mammals) can make use of some of this heat to keep their body temperature level. The normal internal body temperature of a pig is about 38.5°C. A healthy animal will automatically try to maintain this temperature. Any great deviation from this norm may lead to the animal's death, because all of its body processes are geared to work at this temperature.

A sick animal's temperature may rise to above 40°C if its temperature-regulating mechanism is disturbed. If a pig's temperature rises above 41°C it will die. The same applies if the temperature drops too much. Especially in the tropics animals generally produce more heat than they need to maintain their body at an ideal temperature. To avoid overheating they have to get rid of any superfluous heat in one way or the other.

### **Controlling body temperature**

One way of dissipating heat is to give off moisture by evaporation - 'sweating' is an example of this process. Pigs however do not have sweat glands and are therefore unable to do this.

Releasing heat by evaporating water from the skin is also possible if there are puddles and pools that the animals can lie and roll in. Moisture evaporates from the wet skin, releasing excess heat from the body. If the water is cooler than the body the body heat will be transmitted to the cooler surroundings. It cannot do any harm, therefore, to provide the animals with a pool of water, as long as the water is clean and not a health hazard. Pools are very important for improved breeds kept enclosed but are less important for indigenous (local) breeds. Good ventilation is also essential.

Evaporation can also take place through the mouth, and in very hot weather pigs can often be seen panting. This is because, by breathing more quickly, more air is exhaled through the mouth and other air channels, and in this way more water is evaporated.

If the animal is unable to get rid of excess heat in one way or another it will try to reduce its body temperature by producing less heat, that is to say, by eating less and therefore not growing so quickly. If it feels cold it will try to prevent further cooling by generating more heat, for example by exercising its muscles (shivering). This will use up its energy and its growth rate will fall.

The hide of an animal protects it from the outside world. One of its protective functions is to help regulate temperature changes, for it serves as an insulating layer between the internal organs and the outside. A cow has a very hairy coat, which is one of the ways it protects itself against the cold. A pig does not have much of an insulating layer of hair (or fur), but it can form a layer of fat underneath its skin.

Young piglets do not yet have such a layer to protect them, so in the first few days after birth temperature-regulating mechanisms do not function well. It is therefore important to ensure that the surroundings are sufficiently warm for the piglets. As the piglets get older they will need less heat.

### **Ideal temperatures for pigs**

The temperature at which optimum growth and food conversion is achieved differs with the weight of the pig:

- piglets one day old                      35°C
- piglets up to one week old            30°C
- piglets up to about 8 weeks old    20°C - 28°C
- animals up to 90 kg in weight      18°C - 22°C (or a little cooler)

## **3.2 Technical requirements for good housing**

The construction of pig pens and houses will depend to a certain extent upon the climate and local circumstances (e.g. numbers of pigs to be kept). Local conditions are also important, in terms, for example, of the construction site (waterlogged, exposed to wind...etc.) or the building materials and the skills available for the construction of the installations.

In hot, humid, or damp areas, breeze and shade are important factors. The buildings should be as open and airy as possible. The walls of the pens should be so constructed that the wind can pass freely through for good ventilation. In some areas animals should be protected

against periodic temperature drops by ensuring that any heat can be retained.

A few important requisites for the pen are:

- It should not be draughty.
- Bright sunshine and heavy rain should not be able to enter.
- There should be no great variation in temperature inside the pens.
- They should be easy to clean.
- Provision should be made for storing the manure, litter and run-off for later use.

A pen satisfying these requirements will make a major contribution to the good health of the herd, counting towards lower piglet mortality, faster growth and increased feeding efficiency. The most suitable housing for less intensive holdings in tropical regions consists of a walled and roofed pen with a yard or run (see Figure 6). Bedding material should be provided in the covered pen and the run should contain a trough and if possible sufficient space for a large water tank.

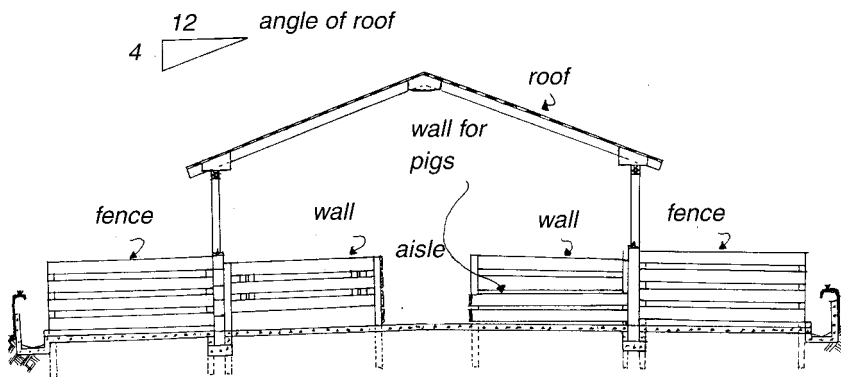

*Figure 6: Pen adapted to a tropical climate.*

When building a pen, care must be taken in choosing the site. In hot areas the site would benefit from the shade of a group of trees, as trees



absorb and screen a good deal of heat. The pen should be near a water supply, so that water is readily available for the animals, and it must be easily cleaned.

### **The roof**

The first essential is a roof, which can be made of various materials. The most practical approach is to use the same material as is used for the local roofing. A roof of leaves is a good insulator against heat and cold, but it has the disadvantage of rotting quickly. Corrugated iron or aluminium sheets covered with leaves would last longer but are more expensive. Other materials can be used, provided that they protect against rain and sun, heat and cold. If possible the roof should be constructed with its longest slope against the prevailing wind and rain. If an opening has been left between the walls and the roof (see Paragraph 3.5) there should be sufficient outside overhang to prevent the rain entering.

### **The floors and bedding**

The floor of the pen should be slightly raised above its surroundings to avoid puddling or flooding in wet weather. It is also advisable to slope the floor slightly, so that the pen is situated at a higher level than the run. This will allow the liquid manure to run off more easily. If a drain is fixed at the lowest part of the run the run-off and manure can be collected into a pit. Pig manure is a good fertiliser so it is important to collect it (see Paragraph 3.6).

The floor can be of compacted soil or loam; it should be kept hard and smooth so that it can be easily swept clean. The pigs can be ringed to stop them rooting in the soil. In Europe special pig rings (small pieces of iron) are sold, which are pinched into the upper part of the nose (snout) with a special tool. Wooden floors are not advisable because the crevices make them difficult to keep clean, and the pigs bite into them. Wood will rot when damp.

If cement is available a concrete floor is a possibility. The concrete should not be so rough that the animals can scratch themselves on it. A

floor that is too smooth is also dangerous, as the animals may slip and do themselves serious injury. To improve a floor that is either too rough or too smooth a few shovels of soil can be thrown into the pen every day after cleaning. This is not only a precaution against accidents, but it is also healthy, as the animals can take up valuable minerals from the soil (iron for example).

The disadvantage with concrete is that it is a bad insulator. In hot weather the animals can take advantage of this by lying on the cold concrete to cool themselves down, but in cold weather too much body heat will be lost and the younger animals will get too cold. In young animals this increases the risk of diseases like pneumonia for example. The coldness of the concrete can be reduced by seeing that the animals have bedding material in the pen. For young piglets put a cloth on the floor. For older pigs various materials can be used, such as rice straw, sawdust, dry leaves etc. As a precaution it is better not to use plants or seeds that may be poisonous. Pigs have a habit of finely chewing their bedding litter and will swallow part of it. This will not do any harm as long as the animal does not eat harmful plants. The leaves of the Wonder Oil Plant (*Ricinus communis*) for example should not be used. Its seeds are poisonous and could get amongst the leaves. Bedding material should be changed regularly to keep the pen clean and to avoid any parasite build-up. The mixture of bedding with dung and urine makes an excellent fertiliser for the fields, and is especially valuable if specially stored for transformation into compost.

### **The walls**

The construction of the walls depends again on the climate. In the tropics they should be left as open as possible for good ventilation. A low wall approximately 1 metre in height will suffice, with an opening between the wall and the roof. In windy areas, the roof (or ceiling) should not be too high, otherwise the pen will cool down too quickly in the strong winds. Completely open walls, made of wire netting for example, are seldom recommended, as pigs always like to shelter from wind and rain. In higher and colder areas the walls should be constructed in such a way that it is possible to close the walls of the

pen completely. In the daytime, when temperatures are higher, the top section of the walls can be opened, to be closed again towards evening to keep the warmth in. It should be possible completely to close the side exposed to the rain.

If the walls are made using traditional mud and wood techniques a protective row of hard wooden poles should line the inside. This will prevent the pig from digging into the earthen wall.

The walls can also be made of boards or bamboo poles. A row of small tree trunks will provide a simple wall, even if the wind can enter more or less freely, as long as part of it is closed with woodwork to allow a space for the animal to shelter.

Cement walls will be the most expensive but they are stronger and last longer. If the supply of cement is limited, it should be used in priority for the floor.

### 3.3 Feeding and water troughs

Feeding should be done outside if possible. The feed trough can be made of cement, iron, or hardwood. The trough should be long enough for all the animals in the pen to feed from it at the same time.

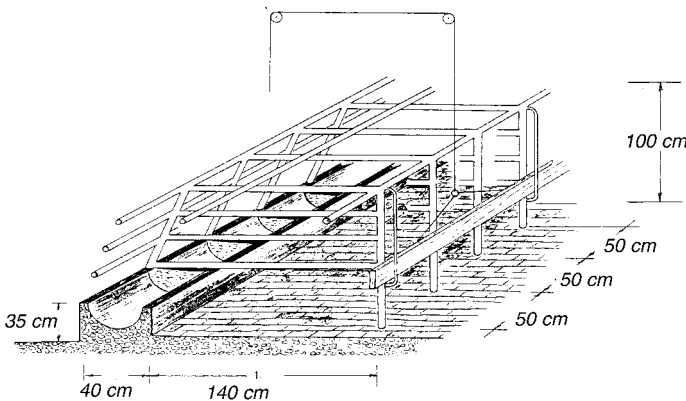
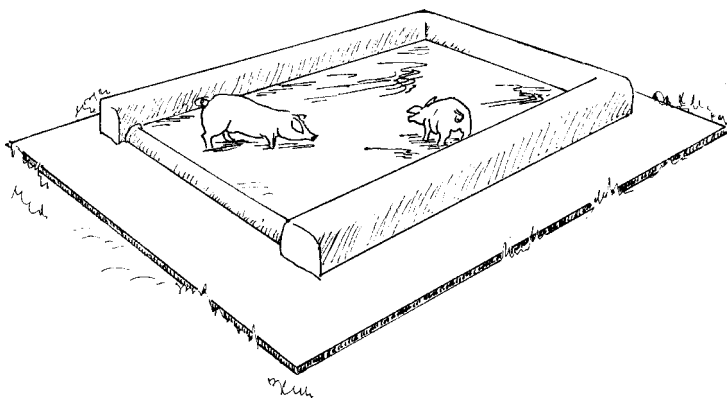

Figure 7: Separate feeding for pigs (from: Udo, 1985).

Animals of different sizes, older and young sows for instance, should not be kept in the same enclosure. It may happen that weaker animals are bitten and do not get enough to eat when feeding. The stronger animals will fatten at the expense of the others.

If for one reason or another animals of different age and size have to be kept together, precautions should be taken to ensure that they do not get in each other's way when feeding. This is possible by giving each animal or group of animals a separate feeding space, by enclosing them inside railed-off sections (see Figure 7). These sections will have to be closed from behind and can be of metal or wood (although wood wears out more quickly).

In very hot areas a water bath should be provided in the run for the animals to cool down in (see Figure 8). The bath should not be too deep: for older sows about 20 cm deep, for younger animals the water level can be adjusted accordingly. Care should be taken to prevent the young piglets from drowning.



*Figure 8: Water bath in a run (after Eusebio, 1987).*

The bath should be cleaned out regularly to prevent the development of parasites and diseases. Cement is the most suitable construction material, since a pit dug in the soil will quickly develop into an unmanageable mud bath.

### 3.4 Sizes of pens and runs

In Figures 9A and 9B an enclosure is shown suitable for all types of pig. If there is a run, the animals will get into the habit of going outside to excrete. This can be encouraged by ensuring that the covered pen is not too big. Provided that the doorway is wide enough, the inside area of the pen need not be very large.

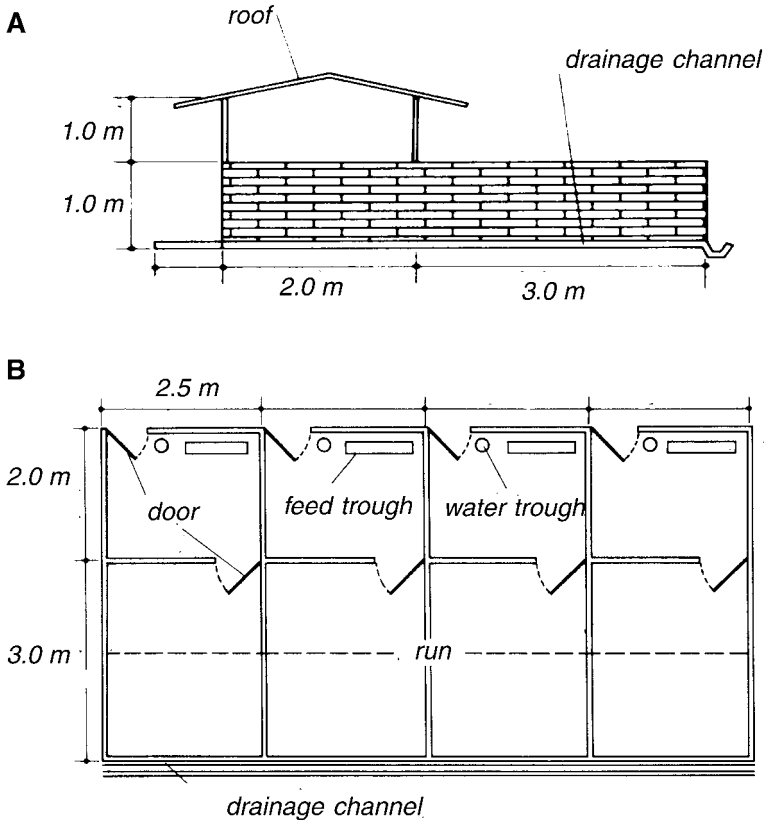

Figure 9: Pen and run for all types of pigs (A:side view; B:tot view)

A pen measuring 2 x 2.5 metres is adequate for a sow with a litter of piglets. If there is no run however, the sow and piglets will need an area of about 3 x 3 metres. The run should be 3 x 5 metres in size. It

should be larger if a water bath is installed and it must be well fenced, to make sure that the piglets do not escape. These dimensions are also suitable for housing 12 - 15 weaned piglets, or 10 fattening pigs, or 3 breeding pigs.

The pen in Figures 9A and 9B is suitable for all types of pig. It is a good idea to put the piglets in a separate corner where they can feed on their own away from the sow (see next Paragraph).

### **3.5 Housing the sow and her piglets**

As we have stated, young animals should be protected from cold directly after birth. Plentiful quantities of good dry bedding should be available to keep the piglets warm. If this does not suffice and you have the means, a heating lamp should be installed in a separate corner of the pen for the first few weeks.

The piglets should, if possible, be given a secure place of their own in the sow's pen, but at a small distance from her. This is because there is always the risk that the sow accidentally kills her piglets by lying heavily on them. To make it impossible for the sow to crush her piglets against the walls, inside the pen a horizontal rail should be installed parallel to each wall, 15 to 20 cm away from the walls and at a height of 15 to 20 cm from the floor.

#### **Farrowing crate**

Another solution to prevent piglets being crushed during and after birth is to use a farrowing crate, a sort of cage confining the sow and limiting her movement. The crate takes up a floor area of about 65 x 220 cm, and resembles a cage made of iron or wooden bars. There are doors at the front and back of the crate. Bars across the top prevent the sow from climbing out. The crate is installed in the pen and just next to it a warm spot is provided for the piglets, who thus remain in close contact with the mother but can move freely about and away from her as they please.

The dimensions of the farrowing crate depend on the average size of the sows. For smaller types the crate should measure about 50 x 150 cm, and for the larger commercial breeds 65 x 220 cm.

### Piglet boxes

Figure 10 illustrates a 'piglet-box'. This is a farrowing crate combined with a special 'creep' area where the piglets are kept warm. The box allows the piglets to crawl away from the sow to a bedded area on either side of her. After a few days the extra shutters can be removed, so that the piglets can run freely about the pen. This system has proved very successful; the piglets nearly always prefer the protective 'creep' rather than lying against the sow. The sow should be kept in the farrowing crate for about two weeks after farrowing.

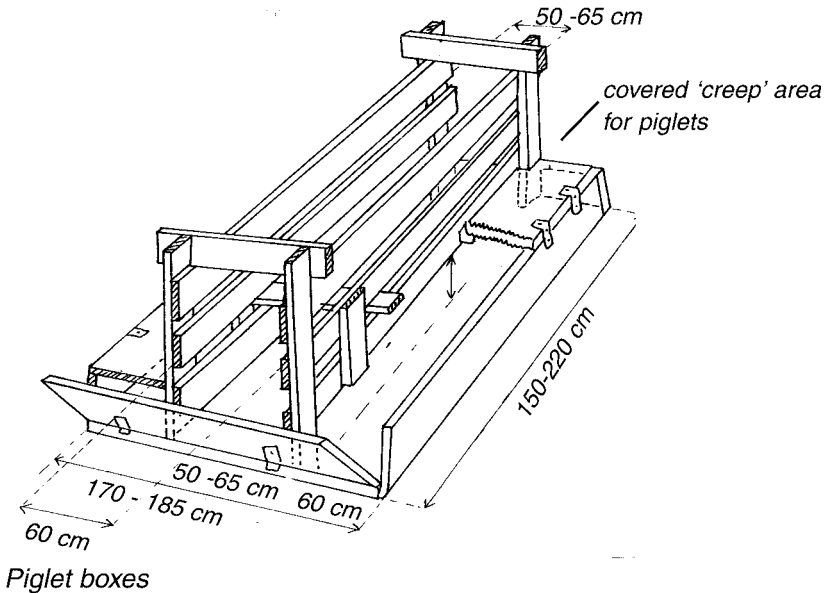

Figure 10: Farrowing crate with covered 'creep' area for piglets (from: Udo, 1985).

Before using the crate for the next sow it should be thoroughly cleaned. When the sow leaves the crate a warm place should be found for the piglets. This could be in a separate corner of the pen, where they can be introduced to a little feed. When the piglets reach a weight of 8 - 12 kg they can be weaned, that is to say, separated from the sow.

### **3.6 Housing fattening pigs**

Pens to be used for fattening pigs are less demanding. There should be no more than 10 fattening pigs in one pen, and a simple pen with a run will suffice (Figure 9). This also applies to the breeding animals and boars.

The breeding sows and boar can be allowed out on a fenced piece of land occasionally, as this is very good for their general condition. Their leg muscles will benefit and in rooting around they will find some of the essential elements that are sometimes lacking in the feed. This is more important for the breeding herd than for the fatteners; a fattener will never get old (slaughter) but a good breeding pig will be used for as long as possible.

The danger of parasite infection must be taken into account however when putting the animals out (see paragraph 7.4).

### **3.7 Using liquid manure and dung**

Pig urine and dung are good fertiliser for the land, so it is wise to make good use of them. Before using the dung it is best to let it decompose first by heaping it separately. Pigs enjoy chewing their litter and playing with it, so it is good to give them plenty of any kind of organic matter for this purpose. If they feel happy, their condition is better anyway, and the manure will be better too! Once the litter from the pens has been broken down by the pigs it should be left to rot for a while (in the shade), by being kept moist and turned occasionally, to approach compost quality.

Pig keeping can be combined with on-farm fish culture:- apart from being put on the land, the pig manure can be used to fertilise the



fishpond. The manure, or some of the rich run-off from the pens (not too much), will stimulate the growth of natural fishfood and water plants. This increases the food available for the fish who in turn grow faster. In addition, water plants such as *Ipomoea reptans* growing on the surface of the water grow more rapidly and provide excellent green fodder for pigs.

For further information on this combination see Agrodok No. 21, 'On-farm fish culture'.

## 4 Pig breeding

### 4.1 Managing the sows

Sows that are to be kept for breeding should be selected and separated from the litter at about 3 months of age. They should not be allowed to get too fat because this will create fertility problems. They should get a little exercise to remain in good condition.

Young sows are mature enough to conceive at about six months of age. They should not be served (mated) too early however as it is better to wait until they are fully grown. If they are well fed and healthy this will usually be at about eight or nine months. Mating too early will result in small litters, problems at birth, a loss of condition and poor growth of the sow.

Mating can only be successful during the sow's period 'on heat' ('oestrus'). Sexually mature, non-pregnant and non-lactating sows come on heat for two or three days about every three weeks. However if the boar is kept separate from the sows and gilts (young sows, not yet mated), as he should be, it may sometimes be difficult (but nevertheless essential) to recognise the heat (see below).

#### **Selecting sows for breeding**

When selecting the sows to be kept for breeding, the following points should be considered:

- They should have at least 12 normal teats.
- They should be the biggest and heaviest of the litter.
- They should have strong legs and walk well.
- Their parents should be good breeding animals capable of producing good litters at regular intervals.

#### **Recognising the heat**

Twice a day (in the morning and in the evening), a check should be made of the sow's oestrus condition. This should be done some time after feeding, preferably in the morning. Doubtful cases can be looked at again in the afternoon. Differences in breed and climatic variations in the tropics sometimes make it difficult to recognise oestrus. The

first sign is a redness and swelling of the vulva, which is more obvious in gilts than in sows. Another sign is that other sows in the pen start to mount the sow on heat.

The clearest indication is the reaction of the sow to the boar. If a boar is brought alongside the sow's pen, a sow on heat will advance towards the boar. They exhibit a typical ear display (especially noticeable in breeds with erect ears). If the sow does not react convincingly, then the boar should be let into the pen. The boar will nose the vulva and prod the sow in the belly and flank. If the sow accepts he will mount her. A good oestrus sow will stand rigid when mounted, with her back legs slightly apart (the so-called standing reflex).

Even without a boar, the standing reflex can be provoked in a good oestrus sow, although it is less easy with gilts. You should approach the sow quietly and prod her gently in the flank with your fist. Then press down gently with both hands on her back. If the sow allows this you can try to straddle the small of her back (see Figure 11). If the animal does not move from her position she is almost certainly on heat.

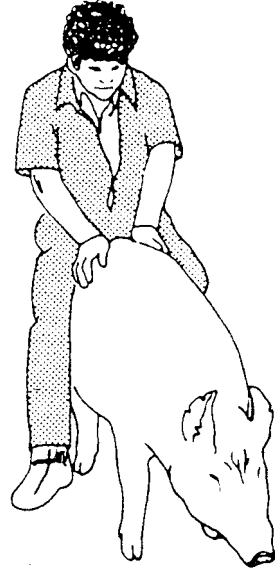

*Figure 11: The standing reflex*

Gilts coming on heat for their first time should not be served immediately. They are still too young and their bodies are not yet strong enough to carry and deliver a good litter. Gilts in good condition can be served for the first time after they have come on heat regularly a few times (keep records! see Paragraph 4.7). Let a young boar who is not too heavy do the job as gilts are too small for a heavy boar.

## **Timing the service**

In normal circumstances healthy sows and sufficiently mature gilts should be mated regularly (food supply and sows' condition permitting). Once a sow has farrowed she will not usually come on heat for some time (whilst she is still feeding the piglets). Most sows come on heat again in the week after weaning their litter. When they finally do, they are very fertile and should be served. They are full of energy and will conceive easily. The second heat is not as strong and the instinct to conceive will have decreased a lot. At the third heat a sow may not conceive at all and you might be left with a pig only good for slaughter. On top of that, if a heat passes without service, the animal has to be fed for a further three weeks until the next heat, without being productive.

Sows should not be served by the boar at the very beginning of their period on heat, nor at the end; this will result in small litters. There is an optimum period during the three-day heat for service. On intensive holdings, a sow is usually served 12 to 24 hours after the standing reflex has been provoked (without the boar). The standing reflex occurs when she is at the most fertile moment of her heat and it indicates the moment when she is most willing to accept the boar. One should always make sure that it is the first standing reflex of the heat, and this is only possible by regular thorough checking.

In very hot conditions especially the period of fertility is shorter and less obvious. If there is any doubt about the best moment, or if the heat was only detected after introducing the boar, it would be better to mate them twice after noticing the oestrus - preferably at the end of the first day and at the beginning of the second. If the heat is really doubtful then it would be better to postpone mating until the next heat.

Mating can take quite a long time, varying between 5 to 20 minutes. The animals should not be disturbed during the operation, but it is advisable to keep an eye on them. Heavy boars should not be used on lighter sows. Often a young boar is kept for the gilts and an older boar for the heavier sows.

Three weeks after mating, the oestrus should be extra carefully checked. If there is no sign of it then the sow is usually in-pig (pregnant).

### **Feeding**

In the weeks before mating gilts and sows should be well fed (protein-rich feed), as they must be fit and strong for mating. With good feeding the chances of producing a large litter increase.

In reality a sow feeding a litter is already being fed a protein-rich ration (see Paragraphs 6.5 and 6.6) and this should be continued until she has been served. After mating the ration can be reduced to the normal protein requirement (13 % - see Paragraph 6.5).

Later, in the final few weeks after pregnancy, she will need protein-rich food again, because the next litter of piglets will be developing fast inside her.

## **4.2 Selecting and working the boar**

### **Selecting the boar**

Selecting a boar is even more important than choosing your breeding sows. In choosing a breeding boar, the same factors should be taken into account as for the sows; this includes the presence of 12 nipples. Avoid choosing a boar too highly in-bred from your existing stock, as in-breeding will lead to reduced fertility, poor growth, and lower levels of disease resistance.

### **Managing the boar**

Young, healthy and well-developed boars should be mated for the first time when they are 8 to 10 months old. Their first sow should be of their own size or smaller. In the early stages the young boar should not serve more than 1 sow per week. The number of services can gradually be increased as indicated in table 1. If a boar mates more often than this, his health and productivity will suffer.

In hotter climates a single boar will suffice to serve between 5 and a maximum of 25 sows. It is nevertheless advisable to keep at least 2 boars, an older heavier boar for the bigger sows and a younger lighter one for the gilts. A boar should function well until about 5 to 6 years old. Once he gets older than this the younger boar should take his place and a new young boar be selected, or brought in, for the young sows.

*Table 1: Number of services of a boar in relation to its age.*

<b>Age of the boar</b>	<b>Services</b>	
8 - 10 months	Once per week	At this stage you should check that the boar serves properly and that the sows served by him are successfully inseminated.
18 months	Max. 3 times per week	
24 months or older	4 - 5 times per week	Boars need rest periods. There should be no more than 15 services per month. Older boars can occasionally be allowed to mate twice a day, but never more than 6 times a week, with a maximum of 20 times a month.

It is important to record the boar's activity and the results obtained, so that his performance can be assessed. The fertility of the boar is indicated by the size of the litters he produces and the percentage of sows in-pig after a first service (insemination rate). The information to record is:

- the date of the service;
- the identification (name or number) of the sow he has served;
- the date of farrowing (which will tell you if the sow was inseminated at the first service);
- the size of the litter.

In this way the performance of the boar can be compared with other boars and on the basis of this decisions about keeping or replacing him can be made. It is important to remember however that the quality of the sows also has an influence on litter size and insemination rates.

## **Feeding and housing the boar**

Boars should be kept neither too lean nor too fat. They need plenty of exercise. In very hot conditions or when suffering from fever, they can remain infertile for a long time. A boar that is ill should be rested for 1 to 2 months and be replaced by another for this period.

Boars should be housed in individual pens, for if they are kept with non-pregnant sows it becomes impossible to tell whether and when he has served the sows, and whether or not they are in-pig. It is therefore important to separate the boar from them.

## **4.3 The birth and care of the new-born piglets**

On average delivery will take place 115 days after conception (3 months, 3 weeks and 3 days). The sow will usually farrow during the night or evening. In the last 14 days of pregnancy the udder will increase in size. It feels firmer, and the nipples stand out more towards the end of the pregnancy. In gilts the udder begins to develop after two months of pregnancy.

### **Preparation measures**

About a week before the expected delivery date the sow should be put in a pen of her own, which should be disinfected first. Before going into the pen, she should be wormed and treated for lice and mange. She should be washed with soap and lukewarm water and then rinsed with a mild disinfectant. If there is any risk of disease for the new-born piglets the sow and the pen should again be washed and disinfected 2 days before farrowing.

If you are not using a farrowing crate the sow should have plenty of straw and litter to make a nest for the piglets. If she is in a crate you should make a nest of fine bedding material for them.

In (semi-)intensive units she should also be given plenty of litter. Avoid using very fine litter however, because the sow likes to chew her litter into small pieces, and if she is frustrated in this she will start to gnaw at the pen.

On the day of farrowing the sow should not be given her normal food but only laxative food (green fodder, for example) to ward off constipation (see Paragraph 4.4)

## **Birth**

About a day before the birth of the first piglet, the udder will start to look much redder. A white or clear fluid can now be extracted from some of the teats. The sow will be more lively, alert, restless and she may start to bite. She scrapes the floor with her forefeet and sweeps the straw bedding into a corner with her snout to make a nest.

Just before delivery, the udder will swell and the sow will calm down. The birth of the first piglet is preceded by a bloodstained fluid oozing from her vagina. In gilts the fluid may be released earlier. During the birth the piglets are still enclosed in a membrane which will usually break open as they are born. Piglets are born in the head-and-tail position. On average a piglet will appear every 15 to 20 minutes, but particularly small piglets may be born in very quick succession. Many piglets are born still attached to the umbilical cord. This can be left, as it usually soon breaks off on its own.

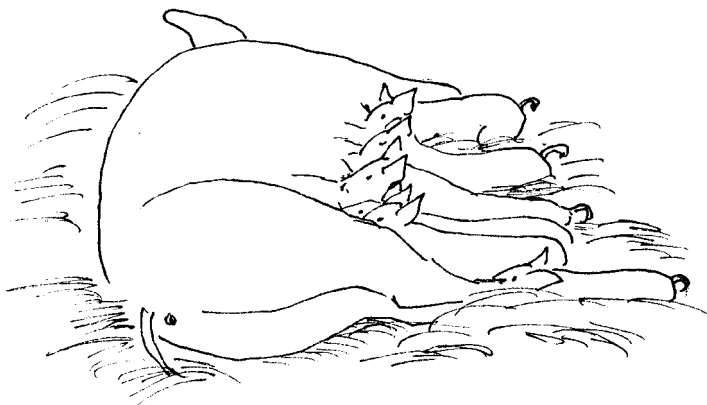

*Figure 12: The sow and the new-born piglets (Barbera Oranje).*

The sow may expel some of the afterbirth in between delivering each piglet, but the afterbirth is usually expelled all at once, 30 minutes or



an hour after the birth of the last piglet. The sow may suck blood from the afterbirth to build up her strength.

Piglets that are born premature (at 110 days or earlier) have parchment-like skin, which is often very red with no hair or only very short bristles. They may have misshapen claws, screwed-up eyes and difficulty in breathing. They stray through the pen trying to find the udder. Most of them will not survive. Normally about one pig in 20 is still-born. Older sows have a higher percentage of still-born piglets. Although there are normally very few complications at birth it is advisable to be at hand, problems which can occur during the birth are treated in Paragraph 4.4.

### **Care of the new born piglets**

A few minutes after the birth the umbilical cord may be pulled gently away or cut if necessary (to about 5 cm length). After the birth the navel of each piglet should be soaked in a cup of iodine solution to prevent inflammation and tetanus.

Each piglet should be rubbed carefully dry with a cloth and put onto the udder. Their groping and sucking will encourage the sow to farrow and to let down her milk, and it is important that the piglets immediately take advantage of the valuable colostrum that will protect them in the coming weeks against diseases (see Paragraph 4.5).

Piglets that have difficulty in breathing (weak irregular breathing) or that appear to have died can be helped by holding their hind legs up in the air. By pressing their chest (thorax) rhythmically their breathing can be stimulated. Pouring a little cold water over their head and chest can help, but the piglet should be dried off immediately afterwards.

In some cases, it may be necessary to trim the piglets' teeth to prevent them biting the udder. More information about this is given in Paragraph 4.6.

If the sow does not produce enough milk the piglets should be transferred to another sow if this is possible; otherwise they will have to be given extra food by hand (see Paragraph 4.5).

## **Anaemia**

Young piglets kept on concrete floors may quickly develop serious anaemia (a shortage of iron in the blood), because the sow's milk does not contain enough iron to cover the piglets' needs. After two or three weeks they become pale and their rate of growth drops. They may develop a fat neck.

Anaemia can be prevented from birth by putting a shovel of 'clean' iron-rich soil or compost into a corner of the pen every day. Clean soil is soil which has not been in contact with other pigs, so that there is no danger of worm contamination. The piglets can rummage around in it and take up some of the iron in the soil. Most of the red, brown and yellow soils in the tropics contain adequate iron. Piglets (0 - 3 days old) may be injected with an iron preparation, if available. Wood ash can also be put into the pen. This will not provide iron, but it does contain other important minerals.

## **4.4 Problems related to the birth**

Although there are normally very few complications at birth it is advisable to be at hand. If the whole process of delivery takes longer than 8 to 12 hours then there is something wrong. In particular the last piglets may be born in the membrane and will suffocate if they are not taken out. It is also true that sows do not pay much attention to their offspring until all the litter has been delivered. Piglets that waste no time in searching for milk may easily be crushed if the sow lies down again in the course of the farrowing. By being on hand to intervene in time this can be prevented.

A sow will not always accept human company whilst she is farrowing. Remain at a discreet distance and be ready to intervene if it appears really necessary.

### **Slow Delivery**

If the sow does not seem to be making any headway and delivery seems to be taking a long time, the first piglet may have to be helped

out by hand. For this the utmost hygiene is essential:- the sow's rear end should be thoroughly cleaned and even disinfected, as should the operator's hands. Grease the hand and the vagina with vegetable oil or Vaseline (avoid soap) and work the hand slowly into the vagina with a slight rotary movement. Simply by doing this it is possible that the sow will start her contractions and push the piglet out.

If this does not work the sow can be injected with 2 cc of oxytocin (not more), which is available on the market under different names. If this has no effect after an hour the piglet will have to be released manually, preferably by someone with a small hand which is clean and well lubricated. If still no progress is made another injection may be given.

If the piglet is really too big a caesarean operation is the only solution. If there is no vet at hand this may not be possible and the sow will have to be slaughtered. It is obviously preferable to try to prepare for such eventualities in advance.

### **Accidental killing of the piglets by the sow**

It is quite normal for sows to eat the afterbirth and any still-born piglets. Some sows, especially young gilts, can be aggressive towards their litters. The reason for this is not clear. During farrowing an inexperienced mother may become frightened by the new-born piglets; she may try to avoid them and start biting. If this happens the piglets should be put in a box and kept warm (possibly with a heating lamp). The mother will usually quieten down. If she doesn't she could be given some beer (1 or 2 bottles) after farrowing. If it is available a tranquilliser (or sedative) such as 'Stresnil' (2 mg/kg) can be injected. Some people maintain that it is by eating the afterbirth that the mother is encouraged to start on her piglets too.

### **The sow becomes ill after farrowing**

The most common disorder affecting sows after farrowing is an inflammation of the uterus (metritis) or of the udder (mastitis).

Sometimes they are found in combination. The sow appears dazed, refuses to get up and to eat, and is feverish.

➤ *metritis*

This is recognisable by a whitish-yellow and/or ill-smelling discharge from the vagina (although a small amount of reddish mucus is normal for a few days after the birth - it is not always very significant). At any sign of a bloodstained, ill-smelling liquid exuding from the vagina checks should be made to see if there are any piglets remaining inside. If so they must be released as described in the paragraph above on 'Slow delivery'.

➤ *mastitis*

In this case one or more of the udders may become hard and swollen, turning red to reddish-blue in colour. This usually starts at the back of the udder. Milk production drops rapidly and the piglets become hungry, starting to squeak and screech.

If the sow has a temperature of over 39.5 °C. she should be treated at once. As soon as possible she should be given a 5 cc injection of oxytocin (always read the label first) and an antibiotic (penicillin/streptomycin, (oxy)tetracyclin or chloramphenicol). If after 24 hours this treatment has no effect the treatment should be reviewed.

➤ *constipation*

It is normal for sows to stop eating shortly before farrowing. This can however bring on constipation and a constipated sow may become restless and neglect her new-born piglets.

Constipation can be eased by laxative foods (leafy greens , fruits etc.). Oil or lard can also be mixed with the food. If it persists castor oil (wonder oil) or Epsom salts can be given. The salts should be dissolved in a small quantity of water.

In order to prevent constipation before farrowing, one or two tablespoons of Epsom salts should be mixed with the feed each day and extra leafy green foods should be given.

The hungry piglets should be kept warm (lamp) and given additional feed of goat or cow's milk, or a sweetened bean meal porridge. In extreme cases the piglets should be put on another sow or artificially reared (see para. 4.5 below).

## **4.5 Rearing motherless piglets by hand**

If a sow dies shortly after farrowing the piglets will have to be reared by hand, or by another sow. Rearing piglets by hand is very time-consuming and often unsuccessful. It is far more effective to put the piglets on another sow that has recently farrowed (less than 3 days). This is usually more successful. Similarly, if a particular sow does not produce enough milk for her litter, some of her piglets can be transferred to another sow. If this does not work, or if you have no sow available, the piglets will have to be reared by hand.

Put the piglets into a clean preferably straw-filled pen and keep them warm. If possible hang a heat lamp in the pen at night and a thermometer. The ideal temperature at first is 30°C (day and night) coming down to 25°C after a fortnight. Throw some soil in a corner of the pen to prevent the animals from becoming anaemic.

### **Feeding orphan piglets**

It is essential that newly-born piglets receive colostrum straight after the birth to build up their natural resistance. Colostrum is the first milk that the sow produces after farrowing. If the sow dies whilst farrowing, the colostrum will have to be taken from another farrowing sow for the piglets. If they get no colostrum their chance of survival is very small.

Cow's or goat's milk can be given, perhaps sweetened with sugar or syrup, to piglets who have managed to obtain colostrum. The milk should not be diluted, as sow's milk is very concentrated. It should be warmed up to slightly above body temperature (37° - 40°C) in a pan lowered into a larger pan containing boiling water (bain-marie).

If a sow dies whilst farrowing her piglets will not have learnt to drink. The milk should be fed on a little spoon or in a feeding bottle. You will have to make sure they take it in.

Later the piglets can be taught to drink from a shallow trough by gently holding the snout in the milk. After every feed the bowl must be thoroughly cleaned, dried, and occasionally disinfected. To avoid indigestion the piglets should not be given too much at one time.

In order to encourage them to drink by themselves, boiled lukewarm water (about twice the quantity of a milk feed) should be put in the pen after the last feed of the day.

### **The feeding programme**

For the first two days the piglets should be fed at regular intervals 5 times a day, for about 10 minutes each time. On the third and on the fourth day they should be fed four times a day, and after that 3 times a day. After 14 days, increase the quantity of milk at each feed, but gradually decrease the number of feeds per day. Gradually change over to more solid feed, so that by the age of about three weeks they should be able to take regular feed. If no nutritious feed is available they should continue on milk for a while longer. The weaker brothers / sisters can be fed four times a day for a longer time. Table 2 serves as a guide.

The figures in the table are maximum quantities - it is better to give too little rather than too much feed. There should be a continuous supply of water available, which should be boiled to avoid any contamination.

*Table 2: Feeding programme for orphan piglets.*

<b>Day</b>	<b>Number of feeds</b>	<b>Quantity each time (ml)</b>
1	5	30
2	5	40-45
3	4	60
4	4	70
5-7	3	80-100
8-9	3	120
10-11	3	140
12-14	3	160

As soon as possible the orphan piglets should move onto regular food. This should be of good quality, protein-rich, and easily digestible. It should be remembered that, despite the amount of care they receive, hand-reared piglets will never grow as fast as those reared by a mother sow.

## 4.6 Looking after and weaning piglets

### Teeth trimming

If the piglets prove turbulent or aggressive, their tusk teeth should be trimmed. This will stop them fighting for the teats and aggravating the sow by biting them. Only the points of the teeth should be removed. If any more is removed there is a risk of damaging the mouth. In commercial units the points are filed off (Figure 13).

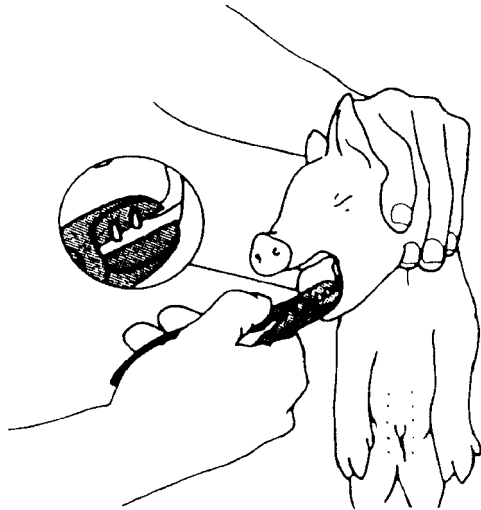
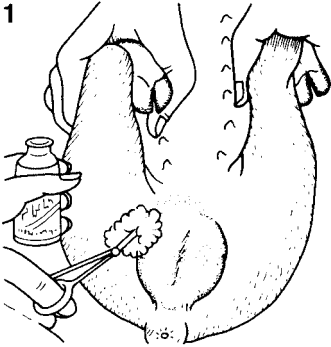

*Figure 13: Trimming the piglets' teeth.*

### Castration

Male piglets are castrated to prevent their meat from smelling strongly, and also to make sure that they are manageable when they become sexually mature. Castration should be done in the first two weeks of a piglet's life. The animals should be fit and healthy and if this is not the case it is better to postpone the operation.

To carry out the castration two people are needed, the person carrying out the small operation and an assistant to hold the piglet. The pen should be dry and very clean. The assistant takes the pig by the hind legs and holds it firmly between his/her legs, the piglet's head pointing



*The scrotum is first washed and wiped with an antiseptic.*

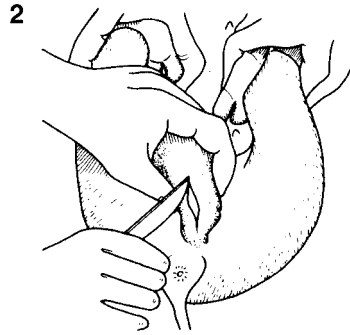

*One of the testicles is positioned against the skin and an incision is made, large enough to allow the ball to be eased out.*

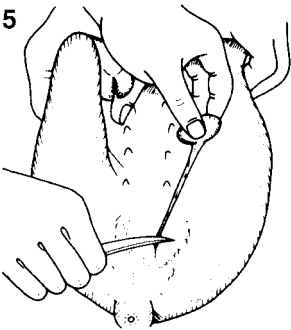
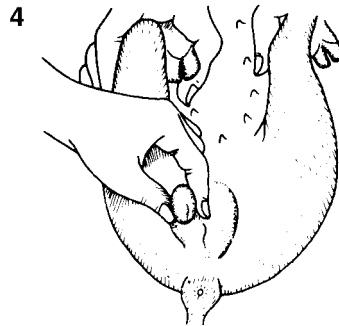
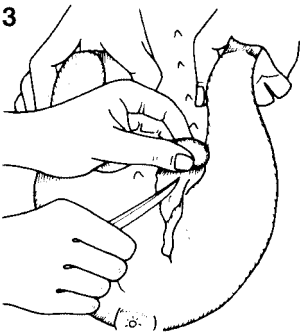

*The cord by which it is attached is then cut.*

**Figure 14: Castration of a young boar (after Eusebio, 1980).**



towards the ground. The other person has a very sharp knife that has been thoroughly cleaned with a disinfectant (Figure 14 shows the steps to follow).

Afterwards the wound should be washed thoroughly with a disinfectant.

The other testicle is treated in the same way.

### **Weaning the piglets**

Piglets should be weaned when they are about 8 weeks old. It is best to take the sow away from the piglets, rather than leaving her in the pen and removing the piglets. This is because piglets should not be perturbed by the loss of their familiar nest, and because the sow will come on heat again quicker. In the last few weeks the piglets should already have started getting used to eating from a trough alongside their mother, and now they should just continue doing so. They will need protein-rich feed as they will be growing fast (see Chapter 6).

At the age of 3 months new breeding sows or boars can be selected (see Paragraphs 4.1 and 4.2).

## **4.7 Record-keeping**

For those who intend to keep a number pigs for breeding purposes it is essential to have a good system of record-keeping. This will help to keep track of developments, make comparisons and take decisions on the management of the herd. It will also have a direct positive impact on daily management.

Good record-keeping means noting down simply and clearly all important details and events. It can also be used to provide and record information for future activities - it is important for example to calculate and note the next date for checking whether a sow is on heat or the date when she should farrow. Such information should be marked on a calendar, so that any necessary preparation can start well in advance (for example preparing the farrowing pen for the sow).

A good system of record-keeping requires little more than a notebook or exercise book and, using a few pages for each sow, noting down all the important events.

Relevant information to record would be for example:

➤ In the case of a breeding sow:

- The name of the sow
- The month and year of her birth
- Her parents' names

➤ Important events:

- Date of her first heat
- Date of 2nd heat
- Date of 3rd heat
- Date of mating, and name of the boar
- Result of the heat check 3 weeks after mating (did she come on heat again?)

If there are no signs of heat she must be in-pig, and the date of farrowing can be established (115 days after mating).

If she has come back on heat she will now have to be put to the boar again - Calculate the date when she might come back on heat (3 weeks after mating).

- Anticipated date of farrowing – mark this one in a calendar!
- The date for putting the sow in a farrowing pen (1 or 2 weeks before farrowing). Mark this in the calendar too!
- Actual date of farrowing
- Size of the litter, number of healthy piglets, and number of still-born piglets
- Number of piglets that have survived and have been successfully weaned (this gives an idea of the sow's mothering qualities)

➤ Other information to note:

- Dates of illness, nature of the problem and the treatment or medicines administered.
- Information on the piglets, e.g. vaccination information.

- If a piglet is selected for further breeding, such information should be transferred to the new page of records opened for that piglet in its new role as a breeding sow or boar.

Here is an example of a typical set of records:

Sow: Marianne.	Date of birth: April 1996 Parents: Sow Suzy and Boar Patrick
15th October 1996	first heat
7th November	2nd heat
29th November	3rd heat
30th Nov.	served by boar Hannibal
21st December	Check for heat. No signs (-), she is therefore in-pig Birth date can be established, that is 115 days after mating
25th March 1997	Expected farrowing, written in calendar
15th March	Separate Marianne from the others
18th March	Marianne has been wormed and washed
26th March	Farrowed: a litter of 4 boars and 3 sows, 1 piglet still-born (dead)
21st May	Weaning of the litter: 3 boars and 3 sows (one of the boars has died)

Paragraph 4.2 has suggested which records should be kept to monitor the boar's activities.

Using Table 3 the date of farrowing can be worked out, if the date of successful mating is known (date of mating + 114 days).

### Marking the pigs

Being able to identify the pigs is essential if records are to be kept and management activities planned. As long as you don't have large numbers of pigs there is no problem recognising them and no need to worry about marking them. However when there are so many pigs that they become difficult to distinguish it is time to introduce an identification system. Giving your animals names also helps, and it is easier to discuss them. They might even respond when you call them!

*Table 3: Farrowing table.*

Date of mating	Expected farrowing date	Date of mating	Expected farrowing date
Jan 1	Apr 26	Jul 5	Oct 28
Jan 6	May 1	Jul 10	Nov 2
Jan 11	May 6	Jul 15	Nov 7
Jan 16	May 11	Jul 20	Nov 12
Jan 21	May 16	Jul 25	Nov 17
Jan 26	May 21	Jul 30	Nov 22
Jan 31	May 26		
Feb 5	May 31	Aug 4	Nov 27
Feb 10	Jun 5	Aug 9	Dec 2
Feb 15	Jun 10	Aug 14	Dec 7
Feb 20	Jun 15	Aug 19	Dec 12
Feb 25	Jun 20	Aug 24	Dec 17
		Aug 29	Dec 22
Mar 2	Jun 25	Sep 3	Dec 27
Mar 7	Jun 30	Sep 8	Jan 1
Mar 12	Jul 5	Sep 13	Jan 6
Mar 17	Jul 10	Sep 18	Jan 11
Mar 22	Jul 15	Sep 23	Jan 16
Mar 27	Jul 20	Sep 28	Jan 21
Apr 1	Jul 25	Oct 3	Jan 26
Apr 6	Jul 30	Oct 8	Jan 31
Apr 11	Aug 4	Oct 13	Feb 5
Apr 16	Aug 9	Oct 18	Feb 10
Apr 21	Aug 14	Oct 23	Feb 15
Apr 26	Aug 19	Oct 28	Feb 20
May 1	Aug 24	Nov 2	Feb 25
May 6	Aug 29	Nov 7	Mar 2
May 11	Sep 3	Nov 12	Mar 7
May 16	Sep 8	Nov 17	Mar 12
May 21	Sep 13	Nov 22	Mar 17
May 26	Sep 18	Nov 27	Mar 22
May 31	Sep 23		
Jun 5	Sep 28	Dec 2	Mar 27
Jun 10	Oct 3	Dec 7	Apr 1
Jun 15	Oct 8	Dec 12	Apr 6
Jun 20	Oct 13	Dec 17	Apr 11
Jun 25	Oct 18	Dec 22	Apr 26
Jun 30	Oct 23	Dec 27	Apr 21
		Dec 31	Apr 26

There are various methods of physically marking animals, but in this Agrodok we will only consider notching. We will not discuss eartagging because the use of eartags requires special equipment which is not easily available. All the animals should be marked when they are young.

➤ Notching

Notching involves cutting small pieces of skin out of the edges of the ears. By varying the pattern of the cuts you can individualise the animals for identification. This is a very cheap method requiring only a very sharp knife (disinfected, of course!). The disadvantages of the method are that it takes time ‘to read’ the patterns (or codes), and that problems can arise if the ears are damaged.

In Figure 15 an example of notching is shown. In this figure the codes used on large farms are shown. A value is assigned to each notch on each side of the ear. By adding up the values marked on the ear the sow’s number can be known. You can of course devise your own system of codes adapted to your particular circumstances.

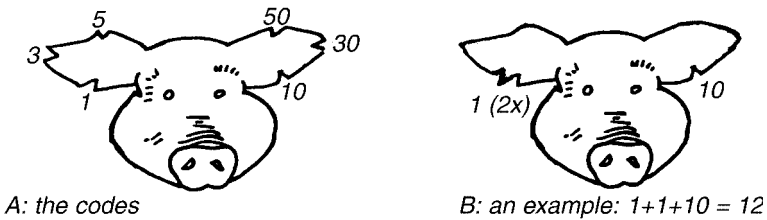

Figure 15: Notching and its codes (after Holnes, 1991).

# 5 Fertility disorders

## 5.1 Poor oestrus show in sows

It sometimes happens that sows do not come on heat at the expected time. Gilts should normally come on heat at 6 to 8 months of age, and sows should do so within one or two weeks of weaning their litter. If there seems to be no heat, it may just be that the heat has passed unnoticed. But it may also be a problem related to the health and condition of the animal, or a genetic problem passed down from the parents. Gilts that do not come on heat should be replaced. When selecting females for breeding, those that have a long and easily detectable oestrus period should be kept.

If a mother sow does not come on heat within 14 days of weaning, there are various possible causes:

- The suckling period has been too long - the shorter the period, the quicker she will come on heat again.
- She is in poor condition.
- She has been receiving low quality or too little feed (her ration should be increased, not decreased after weaning).
- Very high local temperatures ( $> 35\text{ }^{\circ}\text{C}$ ).
- A lack of light in her pen.

Oestrus can be brought on by:

- Taking the sow away from the piglets during weaning, rather than removing the piglets.
- Putting the sow in a pen next to the boar after weaning.
- Bringing her into contact with the boar regularly after weaning.

If these measures don't succeed a hormone preparation PG600 is sometimes available that can be tried. This should be done in consultation with the vet or the livestock extension service.

It occasionally happens that a sow thought to be pregnant (i.e. no heats noticed after mating) does not finally deliver. In this case a problem

may have occurred after mating, resulting in her infertility or a miscarriage. This sow should be culled.

## **5.2 Diseases leading to fertility disorders**

Brucellosis and leptospirosis (described below) can both result in the sow miscarrying. Miscarriage (or abortion) is a termination of the pregnancy before its proper term, with the foetus and the placenta being rejected. Some sows eat this up very quickly with the result that the abortion occurs without being noticed.

The diseases are not the only causes of miscarriage. Sometimes completely healthy animals will abort for inexplicable reasons. This occurs very rarely however with relatively few cases reported every year. More alarming is the occurrence at the same time of several cases on a single farm. This would indicate a disease-related problem which could spread rapidly amongst the animals and to other farms.

If several miscarriages occur together the cause may be one of the diseases mentioned here, or swine fever or swine erysipelas which are covered in paragraph 7.5 below. As soon as possible the vet or the livestock authorities should be warned.

### ➤ *Contagious abortion (Brucellosis)*

Brucellosis in pigs is not caused in the same way as in cows, sheep and goats. An outbreak can result in sudden abortion by pregnant sows, followed by temporary or permanent infertility. The sows may abort at any stage in their pregnancy. Some animals may become crippled (inflammation of the joints) and boars may develop an inflammation of the scrotum, with swelling and pain.

There is no treatment for this. The disease may disappear after a while, but it often reappears. In most cases the whole herd will have to be slaughtered (and this is required by law in some countries). The entire holding should be cleaned and disinfected. For at least two months no pigs should be allowed on the site. New animals should be blood-tested by the veterinary service.

Prevention: an infected animal brought in from outside (such as a boar) is usually the cause (the disease can be transmitted by mating). If the sow is mated off the farm she may return with the disease. One should be very cautious when bringing outside animals onto the site. The disease can also be transmitted to humans!

➤ *Weil's Disease (Leptospirosis)*

This disease is marked by sudden abortion by a number of sows, usually towards the end of their pregnancy. The piglets are often different in size, as they have died in the womb at various stages of the pregnancy. Sometimes very weak piglets are born at the normal time. After the abortion there is no loss of fertility in the sows and the disease dies out on its own accord within a few months.

During a leptospirosis epidemic abortions can be prevented if all the pregnant sows are given two injections of dihydrostreptomycine in doses of 25 mg per kg. body weight, with an interval of one week in between each injection.

➤ *Smedi virus*

Infection by the Smedi virus (PARVO) is very similar to infection by Weil's disease. Recently bought gilts in particular (who have not developed any resistance to the viruses present on the holding) may deliver a number of still-born piglets. These are often full-term or even overdue, but they will have died at different stages of the pregnancy, and will therefore vary in size. Once exposed to the disease the animals develop a resistance to it and future breeding can take place normally (such gilts should not be culled!).



# 6 Pig feeding

## 6.1 Introduction

Pigs are in general not particular about their food, which can be of both animal and vegetable origin. Although they accept most foods, this does not imply that the quality of their food is not important. Pigs won't thrive on grazing and fibrous feed alone.

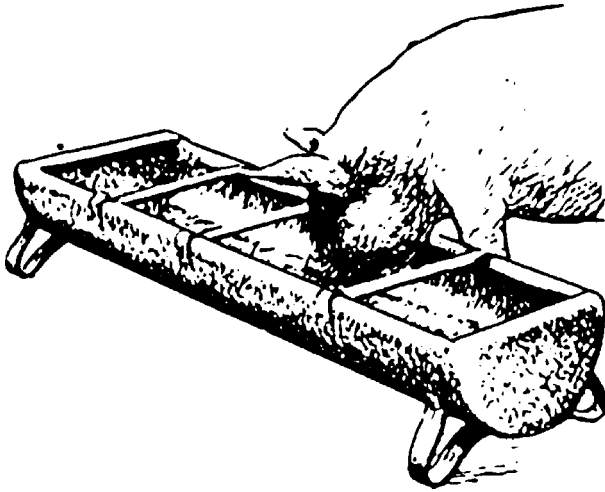

*Figure 16: A feeding pig (from: Udo, 1985).*

It is perhaps unfortunate that pigs share the same tastes and requirements as humans. This means that they are in direct competition with them for important parts of their production: the cereals, roots and tubers, milk and milk products. Only local circumstances can determine to what extent such competition is acceptable. In resource-poor areas the advantages of using cereals for example as pig food should be considered very carefully. Normally pigs will have to make do with feed that is not directly useful to man, and with waste products. This includes agro-industrial by-products (bran, molasses etc.), kitchen waste, and garden or agricultural refuse.

## 6.2 Nutritional requirements

There are a number of essentials to be provided through the normal rations:

### ➤ *Dry matter*

Pigs like all animals need to fill their stomach and intestine with a certain amount of bulk, normally indicated in terms of dry matter. The maximum that pigs in the tropics can eat is about 5 kg dry matter per day (the lactating sows usually).

### ➤ *Energy*

A pig needs energy in its food in order to:

- Maintain its body temperature and normal body processes (e.g. digestion).
- Remain active and mobile.
- Develop and put on weight.
- Maintain its reproductive capacities: a healthy sex drive, strength to nourish the foetus and to produce milk...

Starchy and fatty foods are the best sources of energy (see next paragraph). The body also converts starch into body fat and, if given sufficient good protein, into meat.

### ➤ *Protein*

Protein is necessary for physical development - growth, breeding and milk production. Protein quality is as important as quantity. Some protein of animal origin should be included if possible.

### ➤ *Minerals and vitamins*

These play an important role. The minerals calcium and phosphorous are very important, but trace elements such as copper, zinc, iron etc. are also needed in small quantities. For optimum production (growth, breeding, lactation) a good vitamin supply is essential.

## **6.3 Sources of energy, protein, minerals and vitamins**

### **Energy sources**

Starchy products such as root and cereal crops are the cheapest sources of energy. Oils and fats contain a great deal of energy but are more expensive. If necessary proteins can be used as an energy source but they are very expensive.

Cereals, legumes (which also contain a lot of protein), tuber and root crops are rich sources of energy. Agro-industrial by-products can play an important part in feeding pigs (flour milling waste, waste oil and fats etc.). Young green fodder and kitchen waste can also provide energy.

Sugar is a very good source. It is richer and can be obtained and fed in its unpurified form as molasses. Molasses should be used with care however, as it moulds and ferments very quickly. If given in large quantities it can cause diarrhoea. Molasses is a useful additive to make unpalatable food more appetising as it consists of 50% sugar!

### **Protein sources**

Here again not only the quantity but also the quality is important. The quality is determined by the origin of the protein. Protein of animal origin (milk, meat, fish...) is with few exceptions of high quality. Vegetable protein is less rich but there is a lot of variation in the large group of vegetable proteins. Soya protein is of high quality, pulses good, and cereal protein of moderate quality.

Good protein sources are: pulses, young green fodder, animal waste products, and kitchen waste containing soya, cotton, peanut and lupin seed (sweet lupin).

The protein content of the feed is so important because pigs have no other source of protein (For cows, buffalo, sheep and goats protein quality is less important, because various processes take place in the

stomach to produce protein or to increase the quality of the protein in the food received.).

### **Vitamin and mineral sources**

In a varied diet the vitamin supply will normally be adequate, but if no animal protein is fed vitamin B12 levels may suffer. To balance the diet a shovelful of cow, buffalo, sheep and goat dung (ruminating animals) should be put into the pen every day. This type of dung contains all the B-vitamins.

Where vitamin compounds (with calcium and phosphorous) are available a dose of 50 - 100 gm per animal per day is advisable (pigs above 15 kg). Boiling tubers and kitchen waste in seawater can also satisfy mineral requirements (with the exception of phosphorous) economically.

## **6.4 Feeding in practice**

### **Fat**

Fat levels in foodstuffs can vary considerably but there is rarely any danger of deficiency. If the feed contains too much fat this may cause diarrhoea. The fat in the feed has an impact on the quality of the pork produced. Products with an oily fat, such as maize and rice, will give a tender pork. Those whose fat stays firm even at high temperatures (copra for example) will give a compact bacon quality. For preservation purposes this is important, as the firmer the pork is, the longer it can be kept. In general, the fat level of typical feeds is low.

### **Fibrous food**

Pigs, in contrast to cows and other ruminants, prefer fodder that is low in fibrous tissue. They have difficulty in digesting crude fibre, whilst ruminants have a composite stomach in which fibrous tissue can be broken down easily.

The amount of crude fibre varies considerably in different foods. Young green feeds, tubers and roots are low in crude fibre, as are

many cereals and seeds. Animal products contain less than 20%. The amount of crude fibre in a growing plant increases as it gets older however. Pigs can therefore still digest young green fodder whilst older plants are more difficult. Stalky fibrous plants are therefore poorly converted by pigs. Hay and straw is most unsuitable, although they will eat it in time of need. Hay and straw can serve to keep older animals alive, but not for physical development, growth and reproduction.

### **Dung consumption**

In difficult circumstances pigs will eat their own excrement. This is because they find bacteria in the dung which are digestible and rich in vitamins. This behaviour is therefore a way of increasing their nutrient intake.

### **Liquids**

Water or other liquids (milk etc.) should be available in plentiful quantities, as pigs not receiving enough liquid will react by reducing their intake of nutrients.

### **Food hygiene**

Feed troughs must be emptied if the food is not eaten and must be regularly disinfected, since mouldy or rotting food will lead to diarrhoea which can be fatal to young pigs.

## **6.5 Feeding pigs, from weaning onwards**

The remarks in this section apply to holdings where most of the feed is produced locally. In areas where manufactured feeds can be bought these may be preferable if the farmer can afford it.

Pigs in general need a ration with a minimum protein content of at least 13%.
---

Nevertheless:

- Piglets that have just been weaned need protein-rich feed (20% protein) because they need a good start in life and are growing fast. At about 3 months of age this can be reduced to 13%.
- Sows and gilts who are pregnant need extra protein in the final stages of their pregnancy, because at this time the unborn piglets are developing very fast.
- A sow suckling her litter needs a lot of energy-rich food (see Paragraph 6.3) to be able to produce enough milk.
- A young breeding boar will not need extra nutrition, because, to build up his strength correctly, it is important that his development is not forced.

### **The protein ration**

The foods mentioned in paragraph 6.3 need to be combined to achieve the right protein level in the daily ration.

Peas, beans, lentils, china beans, vetches contain about 20% protein, orobus and chick pea about 16%; sweet lupins (boil!) and soya beans about 30%; shelled groundnuts contain 24% protein.

Cereals and cereal waste will not provide more than 10% protein.

Tuber and root crops are usually very poor in protein and must be supplemented with protein rich feed (e.g. soya, animal or fish meal or milkproducts).

In order to prepare a normal protein ration at 13% we will have to mix 1 part of beans (20%) with 2 parts of cereals (10%).

If young green fodder (vegetable leaves etc.) is available, 3/4 kg peas/beans or 1/2 to 3/4 kg soybean cake or cotton cake per day will suffice if plenty of other (less nutritious) feed is given.

If milk or milk products, animal or fish meal are available they should be fed in priority to the lactating sows and their piglets. Piglets recently weaned can also be given some for the first weeks after weaning.

If a pig is fed 1 kg of a 20% protein mixture every day the rest of the feed can be composed of feed less rich in protein. If a 30% protein level is possible then 750 gram of the mix is enough, and with 40% level 500 gram would suffice. These mixtures have to be supplemented continually with other feedstuff, according to the animal's energy needs.

It is advisable also to add 0.3 kg of minerals to every 10 kg feed mixture.

### **Some elementary precautions**

Soya beans should be cooked before use, and shelled groundnuts must be checked for mould before being used in the pig feed. If you are not sure of the origin or quality of certain foodstuffs, or if there is a danger that they may be poisonous you should either discard or at least cook or boil them. Many poisonous agents cannot support very high temperatures.

Cotton seeds, safflower seeds, and cabbage seeds are dangerous for pigs and should not be fed. Safflower cake can be fed but is sometimes poisonous - feed in small quantities and observe the pigs carefully.

## **6.6 Feeding a sow and her piglets**

If sows are fed properly (not forgetting the water!), they will be able to suckle their litter for 6 - 8 weeks. Any longer would not be advisable as they will lose too much weight. During lactation sows should be given extra feed: approximately ½ kg meal per piglet per day, in addition to a ration of 1 kg meal (20% protein), with other feed.

At the age of 3 - 4 weeks piglets pass through a difficult stage. They need more milk than their mother can produce and the supply of iron with which they were born is almost used up. They should be given easily digestible food (watery cereal porridge) until they start to join

the sow eating from the trough. The sow should be kept away from the piglets' feed. Ideally the piglets should get a little animal protein (18%). Also some young green fodder is very healthy for these piglets.

To supplement the iron deficiency a shovelful of soil should be put into the pen every day. In intensive systems iron-injections are often given whilst in free-range systems piglets get iron from the soil. Wood ash provides other minerals.



## 7 Diseases, prevention and control

Local breeds are often resistant to diseases. The main problem with keeping any sort of pig in free-range or semi-intensive systems is not disease but disabling infestation by worms or other parasites.

It is in intensive pig keeping systems that disease is a greater risk, because many animals are kept together in a small space. Infectious diseases spread easily and quickly among the animals. In intensive systems commercial breeds are often used and these tend to be less resistant to disease.

Intensive pig production is a financial undertaking. Diseases can lead to production shortfalls (slower growth rates or loss of animals) and a loss of income for the farmer. In these circumstances it is essential to treat the animals, as long as the costs of treatment do not exceed the loss of income expected.

In free-range and semi-intensive systems farmers do not generally have funds to spend on medical treatment. It is also possible that the pigs are not their only source of income. In such cases a drop in production may be viewed as less important, and farmers may wish to calculate whether the benefits of saving the sick animal and protecting the others justify the cost of treatment.

In terms of prevention, if there is a high risk of an infectious disease occurring, animals can be vaccinated to reduce the risk of losing them all if a disease breaks out.

Whatever the circumstances, if at all possible, the advice of a vet should be sought if there is disease on the holding. Despite all preventive efforts, treatment with medicines may be the only solution remaining.

## 7.1 Prevention by promoting natural resistance

Many diseases and health-related problems in animals can be linked to a loss of natural resistance as a result of feeding problems, a lack of hygiene, or sudden changes in their environment (e.g. temperature, humidity).

Many problems can be prevented by taking the following measures:

- Ensure that the pigs receive sufficient nutritious food.
- Provide shelter from the sun and the rain.
- Regularly move the animals into different enclosures and relocate their shelters.
- Provide good housing, draught- and dust-free, where temperatures are neither too high nor too low, and do not overcrowd.
- Combat anaemia (shortage of iron) by putting iron-rich soil in the pen daily.
- Maintain good hygiene in the pens and feeding equipment (keep them dry and clean).
- Be very careful when bringing new animals onto the holding from outside, as they may be carrying disease.
- Vaccinate the animals if you know there is risk of infectious disease.

Prevention is better than cure. Not only are sick animals less productive, but modern remedies are difficult to obtain or even unavailable in the tropics. They are often very expensive. For this reason particular attention must be paid to the health of the piglets, who are very vulnerable to disease, and whose early months lay the foundations for their ability to resist later on (To a certain extent the loss of some piglets has to be seen as inevitable. In the Netherlands for example a piglet death rate of 15 - 20 out of every hundred is considered acceptable.).

### **Spread of disease by infection**

At any outbreak of disease it is essential to ensure that the disease is not passed on to healthy animals on the footwear, clothing, tools etc.

of those working with the pigs. Even insects, wild animals and earthworms can transmit disease. Therefore take precautionary measures:

- Give the sick animal a separate pen.
- Do not let people into the stable (they might have pigs at home and carry germs away with them).
- After contact with a sick animal never touch other animals without first having washed your hands and changed your clothes and footwear.

The pen should be continually cleaned with disinfectant or sodium hydroxide (NaOH, 5%). Whenever pigs are sent to slaughter their housing should be disinfected before new pigs are brought in. Any animals dying of a disease should be burnt to prevent further contamination.

Even the meat of healthy pigs may be contaminated with germs. It is therefore important always to boil or to roast meat very thoroughly before eating it.

## **7.2 Disease-causing organisms**

Diseases are caused by specific types of organisms. Consequently to treat a particular disease you have to know which organism is involved and choose the appropriate medicine. A medicine badly chosen is money wasted. The principle types of organism responsible for diseases are:

### ➤ *Bacteria*

Very small and invisible to the naked eye. Antibiotics can kill bacteria, but if antibiotics are not properly used the bacteria can become resistant to them (see Paragraph 7.3 below).

➤ *Viruses*

Also very small, invisible even with a microscope! Virus diseases are difficult to treat and there are relatively few medicines available. Antibiotics are sometimes effective and there are vaccinations available in some cases for preventive treatment.

➤ *Parasites*

These are small animals living on or inside the pig, such as various types of worms, ticks, lice, fleas etc... Hygiene is an important factor in their prevention. Treatment varies with each type of parasite.

Sometimes diseases are caused by a combination of harmful organisms. Pneumonia is an example, which can be caused by bacteria or viruses (and usually by both at the same time), and also by parasites (lung worms and intestinal worms that have found their way into the lungs). Paragraph 7.6 describes pneumonia in more detail.

In Paragraphs 7.4 to 7.8 different diseases are considered, presented in the following groups:

- parasitic diseases (Paragraph 7.4)
- bacterial diseases (Paragraph 7.5)
- viral diseases (Paragraph 7.6)
- feed-related diseases (Paragraph 7.7)
- other diseases (Paragraph 7.8)

Before proceeding to consider the diseases individually, some critical remarks on the use of medicines need to be made.

## **7.3 The use of medicines**

### **Treatment for natural parasites**

The routine use of medicines against parasites (e.g. worms) or bacteria is common. The intention is to kill or greatly reduce in number the organisms causing disease or weakness in the animal. These

organisms nevertheless remain present in the animal's surroundings and represent a potential source of reinfection. This often implies that, if no special hygienic measures are taken, repeated treatment with wormers or other medicines becomes necessary. These repeated treatments reduce the natural resistance of the animals. Eventually damage by parasites can actually be much worse under repeated treatment than in circumstances where the animals are not treated (for financial or other reasons) and are obliged to rely on their natural resistance to their environment.

It is therefore important, before using these medicines, first to assess the losses one is likely to suffer as a result of disease or infection. Secondly the likelihood of the treatment being properly applied and succeeding (without inefficient repetitions) must be assessed.

In some cases it is considered useful to treat animals only occasionally, in specific situations. For example one might choose to treat all animals arriving on the holding and not yet accustomed to the new environment, as well as pregnant sows preparatory to farrowing (worming), and any animals weakened for some reason and whose resistance is low.

### **Resistance to medicines**

All disease-causing organisms are capable of developing resistance to medicines. They do so when medicines are used in the wrong doses, or too often, or without respecting the treatment times.

### **Antibiotics**

Antibiotics are very useful medicines but they must be properly used.

- The body of a healthy animal harbours many useful bacteria; those for example in its intestines have the role of helping the animal to digest its food. Antibiotics however are devised to kill all bacteria without discrimination. Unfortunately therefore when an animal is treated with antibiotics its good bacteria are also killed. Consequently, although the antibiotics may effectively arrest the

disease, they may also weaken the general condition of the animal. For this reason give your animal all possible attention when it is being treated! (If you are able to, feed yoghurt to encourage the renewal of the useful intestinal bacteria.)

- A treatment with antibiotics always takes a few days and a course of treatment must be carried out to the very end. If this is not done the disease will hit back again. There is a great temptation to break the treatment off earlier, because it is nearly always the case that the benefits of the antibiotic are to be seen shortly after starting the treatment, and the medicines are expensive. But don't be mistaken, for ending the treatment early can leave the animal even more severely ill, and the medicines (and the money) will have been wasted.
- The meat of an animal recently treated with antibiotics must not be eaten or sold. The antibiotics enter the meat and will affect the health of the people eating it, who will get diarrhoea. If an animal is destined for slaughter you must decide whether it is useful to treat it with antibiotics, and judge the best time to slaughter it so that it can be sold with the meat untainted.

There are often local medicines (medicinal plants) or treatments in use which have been developed over many years. Do not neglect these traditional practices, some of which have been shown to be successful, whilst not being as expensive and difficult to obtain as modern medicines. Medicines that are used for human beings can also be effective on pigs, as pigs and human beings have similar digestive systems.

Products such as DDT have very dangerous side-effects for man and animals and should on no account be used.
---

## 7.4 Parasitic diseases

### Intestinal parasites (worms)

Worms are one of the most serious threats to pig keeping; there are more than 30 types affecting the intestines. The most important of these are the intestinal roundworm, the lung worm, the kidney worm, the stomach worm, and the tape worm. Infection occurs when the worms' eggs are eaten during the pig's foraging for food; the eggs are microscopically small and are present in the soil, in the dung of worm-infested pigs, in the vegetation at the bottom of ditches, wherever pigs are to be found. In Paragraph 2.2 we described the importance of field rotation as a measure of worm prevention in semi-intensive systems. In intensive systems prevention is achieved by ensuring excellent hygiene.

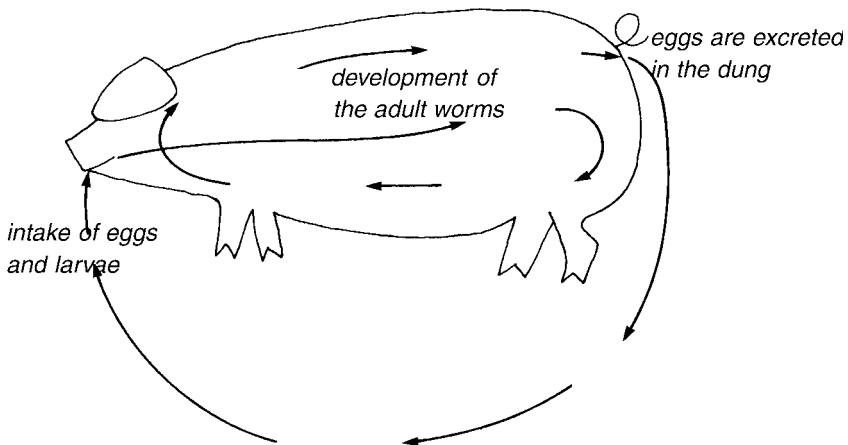

*Figure 17: Life cycle of the intestinal roundworm (from: Holnes, 1991).*

Breeding sows kept outside will always be slightly contaminated with worms, but some infestation in older animals is not serious, as these animals usually have a measure of resistance. Young piglets however are very vulnerable. To prevent the young piglets from being infected directly after birth the sow should be wormed about 1 week before

delivery (treatment which drives out all the worms). She should then be kept inside for delivery. To prevent re-infestation the pen should be well cleaned every day. After worming, the sows should be washed to ensure that there are no worm eggs clinging to them. All this being done the young piglets have a good chance of being born into a worm-free environment.

Good wormers (medicines for expelling the worms) to be mixed with the feed are chenopodium oil, sodium fluoride, piperazine preparations, A-gard and thiabendazole 0,1%.

### **Lung worms**

General hygienic precautions are necessary in controlling this condition. Typically the infected animals cough when they are made to move around and they grow poorly. Riperol (or Levamisole) injections are used in treatment, but are probably difficult to obtain in many places.

### **Mange**

This is a skin-irritation caused by small external mites such as the small grass louse. They provoke severe itching and irritation, with the skin between the legs, around the eyes, ears and neck being principally affected. Treatment involves the removal of scales and dirt with soap and water and a stiff brush. Afterwards the pig should be washed with calcium sulphide or Lindane. Repeat this treatment several times.

Although Lindane is effective against mange and against other parasites of the skin, it is very toxic and dangerous to humans! Its use is prohibited in the Netherlands.

Smearing with coconut oil can be an effective control in cases of light contamination.

### **Lice**

These are blood suckers that also cause irritation of the skin. They can be kept away to a certain extent by planting a pole sturdily in the



ground at an angle of 45° with an old sack wound around it immersed in crude oil or used motor-oil.

The insecticide benzene hexachloride is a very effective remedy (0.1 - 0.25% solution) against lice.

### **Sand fleas**

The sand flea lives on plants and dry grass and passes from them to piglets in particular. The female fleas delve into the skin of the host to lay their eggs (usually between the claws and around the jaw). They should be removed from their breeding places in the skin without bursting the blisters, which are full of eggs. The best remedy is to clean out the breeding places and then smear them with disinfectant.

## **7.5 Bacterial diseases**

### **Enteritis or inflammation of the intestine**

This is a condition with a number of causes (a variety of micro-organisms or inappropriate feed). It is not possible here to describe them all at length. It is characterised by some of the following symptoms: a loss of energy and interest, a high temperature, a loss of appetite, diarrhoea (sometimes bloody), and weight loss. If the problem is food-related, starve the animal and give only clean water for one or two days. After that, gradually increase the feed to normal levels.

The cause of the problem may be a sudden change in diet, in which case the same procedure should be followed. There are a number of common intestinal problems worthy of mention:

- Clostridium enterotoxaemia
- This usually occurs in 1 - 5 days old piglets. There is no good treatment. The sows can be vaccinated, so that the piglets build up anti-bodies through the sows' milk. The piglets can also be given injections of ampi/amoxycilline.
- Transmissible gastro-enteritis (TGE)

- This can occur in pigs of all ages, resulting in watery soft diarrhoea. No treatment is possible.
- Dysentery (Doyle)
- Variable success can be had with one of the following medicines: tylosine, spiramycine, organic arsenic and dimetridazole preparations.
- Salmonellosis  
Neomycine can be given for 3 days (20 mg/kg of body weight per day)
- E. coli bacteria: Antibiotics are used - often Colistine.

### **Tetanus**

Tetanus bacteria can develop if a deep closed wound is received from rusty metal (standing on a rusty nail for example). The animals finally die as a result of severe cramps. There is no treatment.

### **Mastitis**

This affects the tissue of the udder and can result in permanent damage, with the result that breeding pigs can no longer be used. Infection can be avoided to a degree by good hygiene on the holding. If an udder inflammation is noticed, the milk should first be gently milked out before injecting an antibiotic into the muscles or the udder.

### **Anthrax**

This is dangerous both to humans and other animals. A blood-stained fluid will be seen coming from all the body openings. The infected animals are usually found dead in the field. The body should not be buried but burnt, as the germs can survive in the soil for years. Cattle should be kept out of all fields that have once been contaminated with anthrax.

### **Brucellosis (see also Paragraph 5.2)**

This causes abortion in female animals and infection of the reproductive organs in the male animal. Sterility may result. Although treatment with antibiotics is sometimes possible for females, it is better to dispose of infected animals. The boars should be carefully

controlled because the germs from the boar can be transmitted without the boar itself being ill.

### **Trypanosomiasis**

This is transmitted by the tsetse fly. The infected animals are feverish, lack appetite, and breathe very fast. Prevention is only possible by eradicating the fly from the region. Pig breeding is therefore almost impossible in tsetse areas.

## **7.6 Viral diseases**

### **Swine fever**

This is caused by a very infectious virus. In pigs the following symptoms may vary from almost imperceptible to very serious:

- The animal may be very ill for a few days with a high temperature and constipation, after which it recovers.
- The animal is seriously ill, runs a high temperature (between 41 - 42°C), with diarrhoea, an unsteady walk, possibly showing signs of bruising indicating bleeding under the skin (brown blemishes).

In addition to these symptoms pregnant sows may abort.

In piglets the following symptoms are found:

- Chronic cases show retarded growth and diarrhoea. The piglets lose colour and slowly die.
- In acute cases diseased piglets huddle together, pale, with diarrhoea and high temperature (41 - 42°C). They have an unsteady gait and may display brown blemishes on the belly.

It happens that one piglet in the litter will suddenly die (pale body with skin bleeding), whilst the rest of the pigs remain unaffected.

There is no treatment for this disease; only a preventative vaccination can reduce the danger. This vaccination (the so-called crystal violet vaccine) is first administered at the age of 8 to 10 weeks and to sows and boars twice a year thereafter.

## **African Swine Fever**

This is not the same disease as ordinary swine fever. The illness starts with a rapidly rising fever. Typically the animal will remain lively in the early stages, eating normally. About 36 to 48 hours before dying it becomes restless, stops eating, loses the use of its back legs and lies down a lot. It may sometimes have weepy eyes and a discharge (occasionally bloody) from its nose; it vomits. Its skin is often reddish-blue (especially on the legs).

There is no treatment and no vaccine for this disease.

## **Swine Erysipelas**

This disease is often confused with swine fever. To illustrate the differences the two diseases can be compared as in Table 4. Treatment is by penicillin injection and spot disease serum. It is not always effective.

*Table 4:*

<b>Swine erysipelas</b>	<b>Swine fever</b>
constipation or other soft dung	obvious diarrhoea
pink skin, often with intended bruising (you can put your thumb in the bruise)	pale skin, bruising, not intended
lack of appetite	often abnormal appetite
stiff, limping gait	weak, meandering gait
screeches hoarsely when roused	grunts
disease manifests itself in hot weather	disease can occur at any time of year
only one or few pigs ill in the herd	several pigs ill at the same time

## **Pneumonia**

Pneumonia may be caused by bacteria, viruses (usually by both at the same time) or parasites (lung worms and intestinal worms that have found their way into the lung). The condition is aggravated by keeping too many pigs in a small space, low temperatures, draughts, insufficient air humidity, and dusty surroundings. The illness is more common in the rainy season and at this time the pigs should have dry and draught-free conditions. The animals start coughing, especially after exertion and when roused, and they breathe with convulsions. Their growth is retarded. If viruses and bacteria are the cause,

treatment is by antibiotics (streptomycin - penicillin, tetracycline). Ripercol R or Ivermectine is used if there are lung worms involved.

## **7.7 Feed-related diseases**

### **Anaemia, or blood deficiency**

This is an important problem, especially for young piglets kept indoors. The piglets become very pale a few weeks after birth and their growth slows down. The cause is an iron deficiency in the mother's milk. This can be prevented by putting iron-rich soil (mud from the ditches, forest soil...) in the pen every day, giving the pigs something to root in. This soil should not have been in contact with pigs previously, as there should be no risk of it carrying worms. This should be done from the very first week. Very young pigs (0-3 days old) can be given an injection of iron-dextron if it is available (this is very common in (semi-)intensive systems).

Wood ash may also be put in the pen. Wood ash will not provide iron, but it provides other important minerals such as calcium and phosphorus which are important for the growth of the piglets' bones.

### **Constipation**

Constipated sows should have a 60 gm dose of linseed oil in the feed every day. If this does not help 60 gm of Epsom salts should be given and the sow should be made to take exercise.

## **7.8 Sunstroke**

If a pig gets sunstroke, bathe (only) its head in cold water. If possible give it some brandy or whisky with a teaspoon. Make sure it has shade.

## Further reading

Devendra, C., D. Thomas, M.A. Jabbar and H. Kudo, **Improvement of livestock production in crop-animal system in rainfed agroecological zones of South-East Asia**. 1997, 116 pp., ILRI (international Livestock Research Institute), Nairobi, Kenya. ISBN: 92-9146-031-1.

Harris D.L., **Multi-site pig production**. 2000, 280 pp., Iowa state University Press, Iowa, USA. ISBN: 813826993.

Hill, J and D.Sainsbury, **The health of pigs : Nutrition, housing and disease prevention**. 1995, 448 pp., Black well Sciences, oxford, UK. ISBN: 582061008.

Holness, D.H, **Pigs**, vol. 132, 1991, 150 pp., Macmillan press Ltd, Basingstoke, UK. ISBN: 0333523083.

Malcolmson, R.W.; Mastoris, S., **The English Pig: a history**. 1998, 192 pp., Hambledon, London, UK. ISBN: 1852851740.

Perez, R., **Feeding pigs in the tropics**. 1997, 185 pp., FAO, Rome. ISBN: 92-5-103924-0.

Porter, V., **A handbook to the breeds of the world**. , 1993, 256 pp., [S.I.] : Helm Information. ISBN: 1-873403-17-8.

Research Institute for pig Husbandry, **Applied Research in pig husbandry in the Netherlands**. 1991, 28 pp., Rosmalen: Research Institute for Pig Husbandry.

Serres, H., **Manual of pig production in the tropics**. 1992, 262 pp., CAB International, Wallingford, UK. ISBN: 851987842.

Straw, B.E.; D'Allaire S.; Mengeling, W. L. Diseases of swine. 1999, 1256 pp., Black well Sciences, oxford, UK. ISBN: 63205256.

Whittemore, C.T. The science and practice of pig production. 1998, 704 pp., Black well Sciences, oxford, UK. ISBN: 0632 0500861.

# Useful addresses

**FAO**, Food and Agricultural Organization.

The Food and Agriculture Organization of the United Nations leads international efforts to defeat hunger. Serving both developed and developing countries, FAO acts as a neutral forum where all nations meet as equals to negotiate agreements and debate policy. FAO is also a source of knowledge and information. We help developing countries and countries in transition modernize and improve agriculture, forestry and fisheries practices and ensure good nutrition for all.

Address: Viale delle terme di Caracalla, Rome, Italy

Telephone: (+39) 06 57051; Fax: (+39) 06 570 53152

E-mail: [FAO-HQ@fao.org](mailto:FAO-HQ@fao.org) ; web-site: [www.fao.org](http://www.fao.org)

**ILRI**, International Livestock Research Institute

ILRI helps the world's poor people build and protect their livestock-based assets so that these, not poverty, are passed on to the next generation.

PO.BOX 5689, Addis Ababa, Ethiopia

Telephone: + (251)-1 463 215; Fax: + (251)-1461 252

E-mail: [ILRI-Ethiopia@cgiar.org](mailto:ILRI-Ethiopia@cgiar.org) ; web-site [www.ilri.cgiar.org](http://www.ilri.cgiar.org)



**PTC+**, Practical Training Centre

PTC+ is an international training institute, which focuses on all the links in the production chain on plant and animal commodities, (agricultural) technology, (food) technology and natural areas.

Training programmes are practice-oriented and mix theory with practical classes. PTC+ offers “open entry” programmes, “tailor-made” programmes and consultancy. Programmes are offered in the Netherlands and/or at location.

It is the policy of PTC+ to search for partnerships and co-operation programmes with national and international institutions abroad.

PTC+ Head Office, P.O. Box 160, 6710 BD Ede, The Netherlands  
Tel.: +31 318 645700, Fax: +31 318 595869  
E-mail: [info@ptcplus.com](mailto:info@ptcplus.com) PTC+ ; web-site [www.ptcplus.com](http://www.ptcplus.com)

### **Animal science department, WUR**

Zodiac is the Animal science of the Wageningen University and research centre. The core-business of the department is scientific education and research in the area of animal sciences. The department aims to contribute to a sustainable animal husbandry, aquaculture and fisheries

Marijkeweg 40, , 6700 PG, Wageningen,  
Telephone: +31c 317 483952; Fax: +31 317 483962  
E-mail: [info@animalsciences.nl](mailto:info@animalsciences.nl) ; web-site: <http://www.zod.wau.nl/>

### **ITDG, Intermediate Technology Development Group**

ITDG helps people to use Technology in the fight against poverty.  
Bourton Hall, Bourton on Dunsmore, CV23 9QZ, Rugby,  
Warwickshire, United Kingdom  
E-mail: [infoserv@itdg.org.uk](mailto:infoserv@itdg.org.uk) ; web-site: <http://www.itdg.org/>

### **CABI, Common wealth Agricultural Bureaux**

P.O.Box 633, Icraft complex, , Nairobi, Kenya  
E-mail: [cabi-arc@cabi.org](mailto:cabi-arc@cabi.org) ; web-site [www.cabi.org](http://www.cabi.org)

### **DIO, Foundation for veterinary Medicine for development cooperation.**

The DIO foundation gives support and advice in the field of animal health and production to the poorer people of the world, irrespective of country of origin, beliefs or political interests. The main tool in our efforts is the Veterinary Information Service (V.I.S.), which is free to our target group. Furthermore, we try to help by giving advice on animal diseases and other veterinary issues. Secondly we want to promote awareness in The Netherlands of the importance of animal health in development co-operation. Our motto is: healthy animals, healthy people!

Yalelaan 17, 3584 CL, De Uithof, The Netherlands  
E-mail: [dio@dio@dio.nl](mailto:dio@dio@dio.nl) ; Web-site: [www.dio.nl](http://www.dio.nl)



# Glossary

Bacteria	Microscopic organisms found in all organic matter, and often the cause of disease in animals and human beings.
Boar	Male uncastrated pig.
Colostrum	The first milk produced by the sow after the birth of the piglets. It is rich in nutrients and anti-bodies against diseases, and is essential for new-born piglets.
Complete mixtures	Feed purchased and sufficiently balanced to be fed without any other feed (except water)
To Cull	Kill an unwanted animal.
Dry matter	The non-water content of feed: cereals for example consist of 20 - 30% water and 80 - 70% dry matter
To Farrow	Give birth.
Fatteners	Pigs destined for meat rather than being kept for breeding.
Foetus	The piglet in the womb of the sow before it is born; all parts of its body are recognisable.
Gilt	A young female pig that has never had piglets.
Heat	The period of about 3 days in which a sow is fertile and ready for mating (service).
In-breeding	Excessive breeding of males with females that are closely related, resulting in deteriorating quality of offspring.
In-pig	Pregnant.
Insemination	Impregnation, making pregnant.
Lactation	Milk production, suckling offspring
Litter	<i>Either</i> 1. Bedding material, straw etc..... <i>or</i> 2. The group of piglets produced by a sow.
Molasses	Dark syrup drained from sugar during refining, of great nutritive value.

Nucleus feed	A concentrated feed purchased to add to local feedstuff to raise the quality of the ration.
Oestrus	Period of excitement in female animals, the period the sow is prepared to meet the boar and able to become pregnant, also heat.
Oestrus show	The signs of a sow's period of fertility, or heat.
Parasite	Organisms that live at the expense of their host, another animal such as a pig. They live inside the body (e.g. worms) or on its skin (e.g. lice, fleas). They are often a cause of disease.
Placenta	The mass of tissue within the uterus by which the unborn animal is fed and which is expelled after the birth.
Ruminants	Animals (cows, goats, sheep...) with a complex stomach enabling them to digest grasses and other vegetal foodstuff.
To Serve/service	The act of mating or coupling.
Sow	Female pig.
Still-born	Born dead, lifeless.
Sucklings	The piglets when they are still dependent on the mother's milk.
Umbilical cord	The string that joins the piglet to the placenta while in the uterus.
Uterus	Organ in the female in which the unborn pig develops (also called womb).
Virus	Very small microscopic disease-causing organism smaller than bacteria.
Vulva	The opening of the female organs of reproduction.
To Wean	To end piglets' access to the mother's milk, whilst simultaneously accustoming them to solid food.
Womb	See Uterus.