



# 39G Air Handling Unit

Air flow: 2000~60000m<sup>3</sup>/h



## Turn To The Experts

Carrier is a leading global provider of innovative HVAC, refrigeration, fire, security and building automation technologies.

Supported by the iconic Carrier name, the company's portfolio includes industry-leading brands such as Carrier, Kidde, Edwards, LenelS2 and Automated Logic.

Carrier's businesses enable modern life, delivering efficiency, safety, security, comfort, productivity and sustainability across a wide range of residential, commercial and industrial applications.



In 1998, Time magazine named Dr. Carrier one of its 20 most influential builders and titans of the 20<sup>th</sup> century.



## Model Number Nomenclature

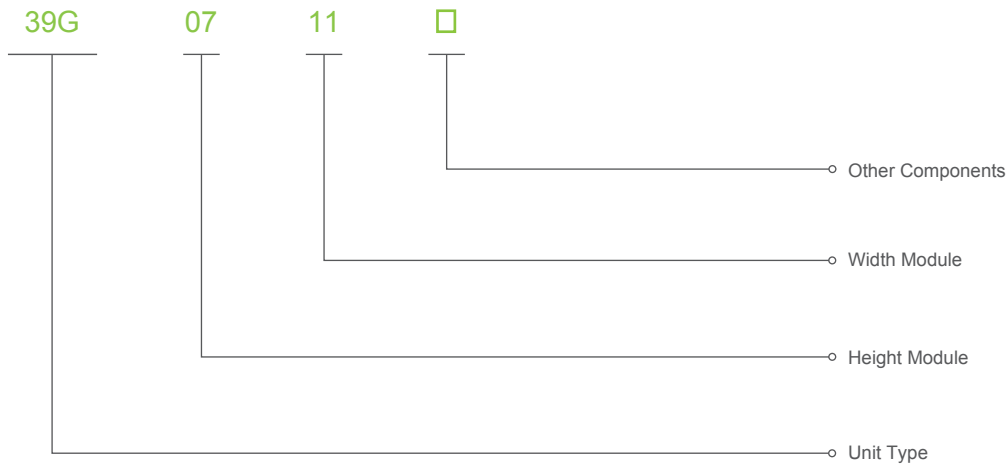

General rule of the height, width and length of a section or unit can be determined with the module concept:

- (1) Unit Height=Height Module×100+50+100(base)
- (2) Unit Width=Width Module×100+50

Example: 39G 0711

07 Height Module

Unit Height:  $7 \times 100 + 50 + 100(\text{base}) = 900\text{mm}$

11 Width Module

Unit Width:  $11 \times 100 + 50 = 1150\text{mm}$

## Unit orientation

Unit Orientation is determined by the location of the inlet and outlet pipes of the coil and the access panel while facing unit in the direction of air flow.

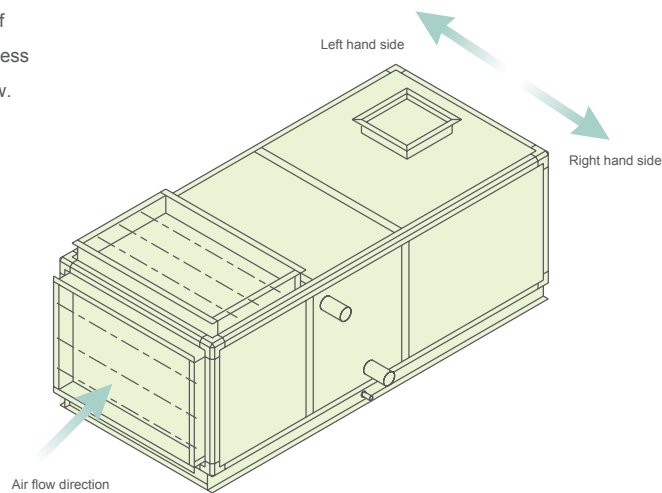

## Air Flow

39G: 2000~60000m<sup>3</sup>/h

## Double skin panel construction, excellent heat preservation

The thickness of PU casing panel is 25mm, with light weight, good rigidity and thermal conductivity coefficient  $\leq 0.022W/(m \cdot k)$ . Moreover, special insulation treatment is conducted at the inner parts of the frame and the middle frame strips to prevent the cold bridge effect. The use of high-quality color steel sheet and galvanized steel sheet in the double-skin metal panel ensures good fireproof and rust preventive performance of the unit.



## New sealing material minimizing air leakage

The unit casing is made up of panels, frame and sealing strips. The panels are connected accurately by adopting unique embedded abutting method. New type of sealing strips between the frame and the panels, and careful sealing design to all access panels and locations passing-through pipes ensure excellent air tightness of the unit, which completely complies with or exceeds the national standard GB/T14294-2008.



## Ingenious condensate drain pan

This design ensures to drain all the condensed water. The drain valve is arranged at the bottom of the coil return circuit, and this can discharge the seepers and avoid the frost cracking of the coil.

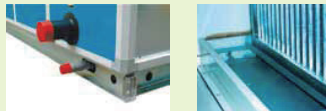

## Corrugated damper flexible to adjust

Fins are the "dual sine-wave" form and mechanically bonded with copper tubes, realizing excellent heat transfer efficiency. Hydrophilic aluminum foils may also be utilized to achieve better heat transfer performance. The standard coil header is constructed of steel and can also be customized with copper. Headers have drain and vent connections, so coil is drainable and has non air trapping circuits. The water in the coil must be discharged in winter to avoid the frost crack of the coil.

If the coil face air velocity is higher than 2.5m /s, a drift eliminator can be installed on the back of the coil to effectively isolate moisture in air.

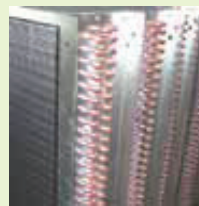

## Hot and cold water coils designed according to international standard

With manual or electric mode available, the corrugated linkage damper can be opened flexibly, and can also add an electric controller as required.

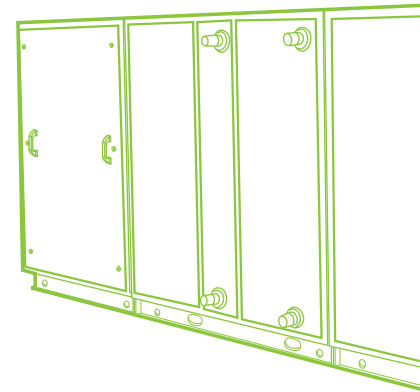

## The fan has the optimized forward or backward double-inlet centrifugal type with low noise and high efficiency

The fan impeller and pulley are statically and dynamically balanced, and the whole fan is calibrated through the operational vibration testing, making the fan to operate stably and smoothly. With the fan and motor assembly mounted on a common base with shock absorber and the fan outlet isolated from the casing by a flexible connection and completely separated from moving parts, the vibration is effectively isolated. Moreover, the forward or backward impeller may be selected according to the air pressure and volume.



Belt-driven Fan

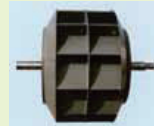

Backward Impeller



Forward Impeller

**AHRI CERTIFIED**  
www.ahridirectory.org

Air-Cooling and Air-Heating Coils  
AHRI Standard 410

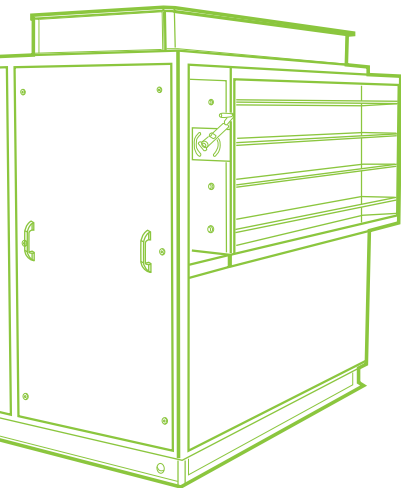

## Various filters available to meet different needs

Filters of various filtering levels are available ranging from primary filters (Panel type, efficiency: G4), to medium filters (Bag type, efficiency: F9), and to high filters (H13). And some special filters such as activated carbon filters, cartridge filters and destatic filters can also be provided.

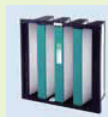

High efficiency Filter



Bag Filter



Panel Filter

## Modular design convenient to select

The width, height and length of the unit are proportionally increased with 100mm as module. Each air volume corresponds with a certain unit type. Modular products save raw material and control costs to the maximum extent. Standard modular products make modeling and manufacturing faster and more convenient.

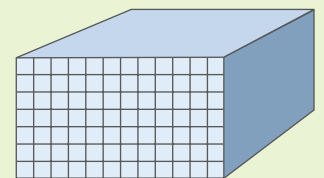

## Easy maintenance

All basic component parts are standard and interchangeable with competitive prices. The unit is designed to have removable panels on its one side, and the access panels are arranged in the necessary components, providing convenience for repair and maintenance of the fan, coil and filter. The coil is installed on the guide rail inside the drain pan, enabling easy maintenance, cleaning and removal.



## Quick Selection

Model	Rating air volume	Coil face	Air Volume (m <sup>3</sup> /h)			Inside Dimension of Damper	Unit Dimension (mm)	
	m <sup>3</sup> /h		Area (m <sup>2</sup> )	Face Velocity			Height	Width
		2.25m/s		2.5m/s	2.75m/s			
0608	2000	0.23	1863	2070	2277	676*322.5	650	850
0609	3000	0.32	2592	2880	3168	776*322.5	650	950
0711	4000	0.46	3726	4140	4554	976*322.5	750	1150
0811	5000	0.57	4617	5130	5643	976*322.5	850	1150
0912	6000	0.69	5589	6210	6831	1076*322.5	950	1250
0913	7000	0.76	6156	6840	7524	1176*480	950	1350
0914	8000	0.84	6804	7560	8316	1276*480	950	1450
1015	10000	1.06	8586	9540	10494	1376*480	1050	1550
1117	12000	1.31	10611	11790	12969	1576*480	1150	1750
1317	15000	1.68	13608	15120	16632	1576*480	1350	1750
1418	18000	1.90	15390	17100	18810	1676*637.5	1450	1850
1420	20000	2.14	17334	19260	21186	1876*637.5	1450	2050
1621	25000	2.62	21222	23580	25938	1976*637.5	1650	2150
1822	30000	3.26	26406	29340	32274	2076*795	1850	2250
1825	32000	3.75	30375	33750	37125	2376*795	1850	2550
2025	35000	4.04	32724	36360	39996	2376*795	2050	2550
2125	40000	4.33	35073	38970	42867	2376*952.5	2150	2550
2226	45000	4.82	39042	43380	47718	2476*952.5	2250	2650
2328	50000	5.39	43659	48510	53361	2676*952.5	2350	2850
2330	55000	5.81	47061	52290	57519	2876*952.5	2350	3050
2333	60000	6.44	52164	57960	63756	3176*952.5	2350	3350

Note: The unit height does not include the damper on top and the base of 100mm (0608~2333)  
Please refer Carrier AHU selection software for detail information.

## Software

### Computer Selection







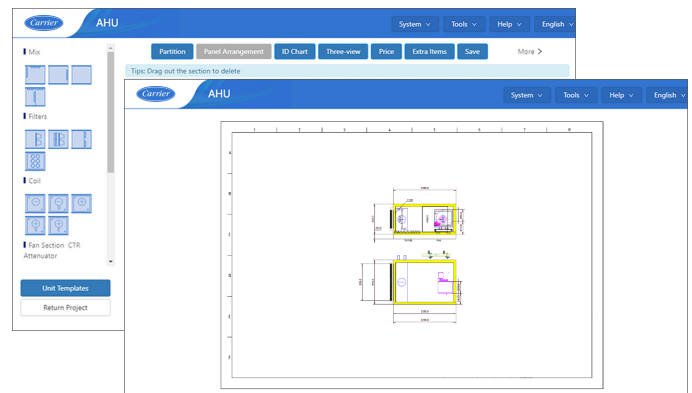











Our company provides the double-quick and accurate computer selection. We will get the reasonable and economic unit by working out the optimal function configuration to meet the customer's requirement.

### Functions & Features

- 🍃 Project Management
- 🍃 Modular Designer
- 🍃 Free Section Combining
- 🍃 Section & Option Configuration
- 🍃 Shipping Configuration
- 🍃 Performance Calculation
- 🍃 Quotation
- 🍃 Drawings & Tech Specification
- 🍃 Multilingual & Friendly Interface



## Standard Components

No.	Unit Section	Diagram	Section Length (M:Module)	Remark
1	Return/Mixing Chamber		(0608~0912) 5M (0913~1317) 6M (1418~1621) 8M (1822~2025) 9M (2125~2333) 11M	1. Could be used as access section 2. Could reduce the length of section suitably when the direction of in/out air is horizontal
2	Single Filter (panel/bag)		3/4/5/6/8/9M	Access section is recommended at upstream
3	Combined Filter		3/4/5/6/8/9M	For 0608~2333, the section length is 5M with drift eliminator and 6M without drift eliminator
4	Cooling Coil		5M or 6M	May be installed together with the cold water coil if the cooling coil does not include a film humidifier and a drift eliminator
5	Heating Coil		3M	Pay attention that the steam pressure could impact the heating capacity
6	Steam Heating Coil		3M	Pay attention to the power stage of control
7	Electric Heating Coil		3M	Pay attention that the steam pressure could impact the humidifier capacity
8	Steam Humidifier		6M	May be installed directly in the coils and drain pan, no additional space needed
9	Film Humidifier		0M	Could share the drift eliminator with cooling coil when it is installed next the coil.
10	Spray Humidifier		6M/8M	
11	Fan		Refer to fan table	Four discharge configurations available
12	Combined Mixing Chamber		(0608~0912) 10M (0913~1825) 12M (2025~2333) 18M	Could be used as access section
13	Attenuator		6M (1Level) 12M (2Level)	Access section is recommended at upstream
14	Supply Chamber		(0608~0912) 5M (0913~1317) 6M (1418~1621) 8M (1822~2025) 9M (2125~2333) 11M	
15	Plenum/Access		≥1M	The length can not be less than 5M, when it is used as access section.
16	High Efficiency Filter		≥8M	Already include the access section at upstream
17	Energy Recovery		6M/9M (Heat wheel)	Module of plate exchanger depends on unit model
18	Electrode Humidifier		6M	
19	Electrostatic Filter		4M	

## 39G Electric Heating Coil Selection

No.	Unit Model	Face Area	1 Row Heater	2 Row Heater	3 Row Heater
	Unit Size	(m <sup>2</sup> )	Power range (kW)	Power range (kW)	Power range (KW)
1	39G0608	0.21	< 4	4~8	8~12
2	39G0609	0.25	< 5	5~10	10~15
3	39G0711	0.42	< 7	7~14	14~21
4	39G0811	0.49	< 11	11~22	22~33
5	39G0912	0.65	< 13	13~26	26~39
6	39G0913	0.72	< 15	15~30	30~45
7	39G0914	0.80	< 17	17~34	34~51
8	39G1015	0.99	< 24	24~48	48~72
9	39G1117	1.29	< 28	28~56	56~84
10	39G1317	1.56	< 35	35~70	70~105
11	39G1418	1.83	< 38	38~76	76~114
12	39G1420	2.08	< 43	43~86	86~129
13	39G1621	2.55	< 45	45~90	90~135
14	39G1822	3.07	< 58	58~116	116~174
15	39G1825	3.56	< 70	70~140	140~210
16	39G2025	4.00	< 80	80~160	160~240
17	39G2125	4.21	< 90	90~180	180~270
18	39G2226	4.63	< 95	95~190	190~285
19	39G2328	5.29	< 100	100~200	200~300
20	39G2330	5.72	< 105	105~210	210~315
21	39G2333	6.36	< 120	120~240	240~360

Note: 1. Star connection is used for electric heater wiring. Multiple group control is acceptable with single group capability less than 30kW and power source of 380V/3 phase.

2. Minimum air velocity through the electric heating coil should be 2m/s.

3. When heating capacity can be reach by using 3-row electric heating coils, 3M casing should be used.

4. When heating capacity is more than capacity of 3-row electric heating coils, 6M casing and two electric heating coils are recommended.



## 39G Fan and Motor

Unit Size	Fan Model	Max. Motor Power (kW)	Max. Motor Model
39G0608	FC160 FC180	1.5	Y90
39G0609	FC180 FC200	2.2	Y100
39G0711	FC200 FC225	3.7	Y112
39G0811	FC225 FC/BC250	3.7	Y112
39G0912	FC/BC250 FC/BC280	5.5	Y132
39G0913	FC/BC280 FC/BC315	5.5	Y132
39G0914	FC/BC315 FC/BC355	7.5	Y132
39G1015	FC/BC355 FC/BC400	7.5	Y132
39G1117	FC/BC400 FC/BC450	11	Y160
39G1317	FC/BC400 FC/BC450	15	Y160
39G1418	FC/BC450 FC/BC500	15	Y160
39G1420	FC/BC500 FC/BC560	18.5	Y180
39G1621	FC/BC560 FC/BC630	18.5	Y180
39G1822	FC/BC560 FC/BC630	18.5	Y180
39G1825	FC/BC630 FC/BC710	30	Y200
39G2025	FC/BC630 FC/BC710	30	Y200
39G2125	FC/BC710 FC/BC800	30	Y200
39G2226	FC/BC710 FC/BC800	30	Y200
39G2328	FC/BC800 FC/BC900	37	Y225
39G2330	FC/BC800 FC/BC900	37	Y225
39G2333	FC/BC800 FC/BC900	45	Y225

Note: Please refer to the selection files for detailed fan motor specifications.

## 39G Coil Connections

Unit Size	A	B	ΦC	F
39G0608	750	357	1-1/2" MPT	212
39G0609	750	421	1-1/2" MPT	212
39G0711	850	472	2" MPT	218
39G0811	950	599	2" MPT	218
39G0912	1050	647	2-1/2" MPT	226
39G0913	1050	647	2-1/2" MPT	226
39G0914	1050	647	2-1/2" MPT	226
39G1015	1150	774	2-1/2" MPT	226
39G1117	1250	824	3" MPT	233
39G1317	1450	1078	3" MPT	233
39G1418	1550	1142	3" MPT	233
39G1420	1550	1142	3" MPT	233
39G1621	1750	1332	3" MPT	233
39G1822	1950	1586	3" MPT	233
39G1825	1950	1586	3" MPT	233

Unit Size	Coil Row	D	E	ΦC
39G0608~1825	2 Rows Hot Water	55	138	1-1/2" MPT
39G0608~1015	4 Rows	91	174	See above table
39G1117~1825	4 Rows	84	181	
39G0608~0609	6 Rows	63	201	
39G0711~0811	6 Rows	70	194	
39G0912~1015	6 Rows	77	187	
39G1117~1825	6 Rows	84	180	
39G0608~1825	8 Rows	84	226	

Unit Size	A	B	ΦC	F
39G2025	2150	951	3" MPT	233
39G2125	2250	1078	3" MPT	233
39G2226	2350	1205	3" MPT	233
39G2328	2450	1269	3" MPT	233
39G2330	2450	1269	3" MPT	233
39G2333	2450	1269	3" MPT	233

Unit Size	Coil Row	D1/D2	E1/E2	ΦC
39G2025~2333	2 Rows Hot Water	55	138	1-1/2" MPT
39G2025~2333	4 Rows	109	206	See above table
39G2025~2333	6 Rows	109	206	
39G2025~2333	8 Rows	88	226	

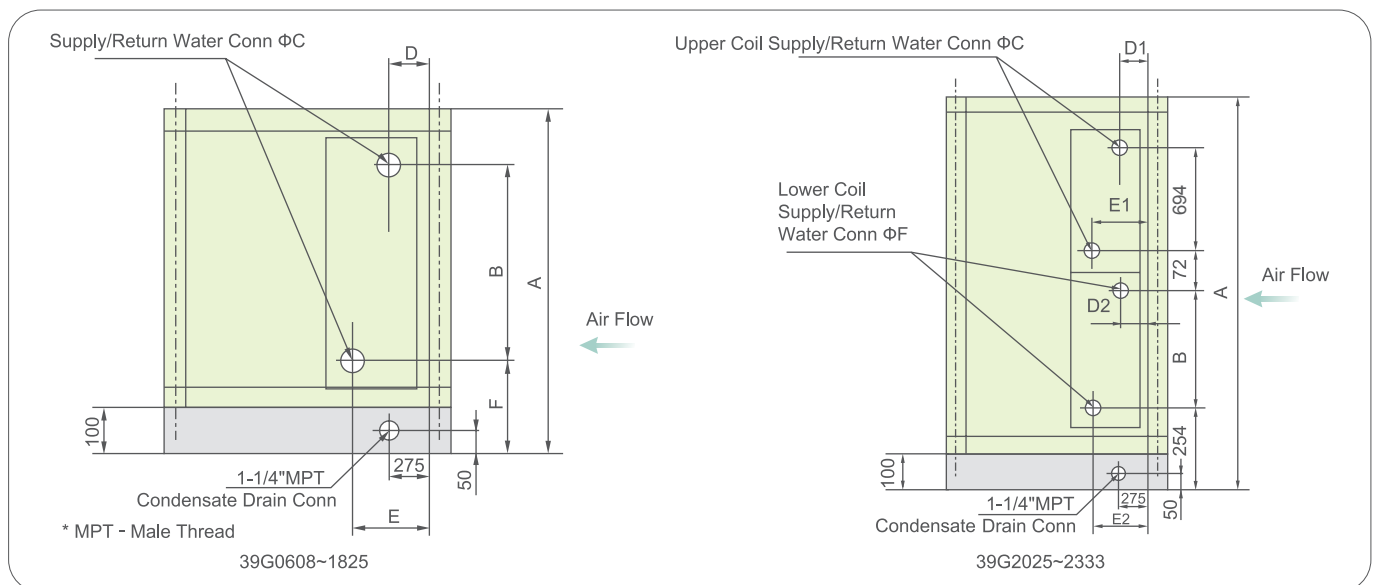

## 39G Steam Coil Connections

Unit Size	A	B	ΦC	F	D	E
39G0608	750	347	2" MPT	223	80	150
39G0609	750	347	2" MPT	223	80	150
39G0711	850	418	2" MPT	223	80	150
39G0811	950	560	2" MPT	223	80	150
39G0912	1050	631	2" MPT	223	80	150
39G0913	1050	631	2" MPT	223	80	150
39G0914	1050	631	2" MPT	223	80	150
39G1015	1150	738	2" MPT	223	80	150
39G1117	1250	738	2" MPT	223	80	150

Unit Size	A	B	ΦC	F	D	E
39G1317	1450	489	2" MPT	223	80	150
39G1418	1550	520	2" MPT	223	80	150
39G1420	1550	520	2" MPT	223	80	150
39G1621	1750	631	2" MPT	223	80	150
39G1822	1950	738	2" MPT	223	80	150
39G1825	1950	738	2" MPT	223	80	150
39G2025	2150	844	2" MPT	223	80	150
39G2125	2250	844	2" MPT	223	80	150
39G2226	2350	844	2" MPT	223	80	150
39G2328	2450	884	2" MPT	223	80	150
39G2330	2450	884	2" MPT	223	80	150
39G2333	2450	884 </td <td>2" MPT</td> <td>223</td> <td>80</td> <td>150</td>	2" MPT	223	80	150

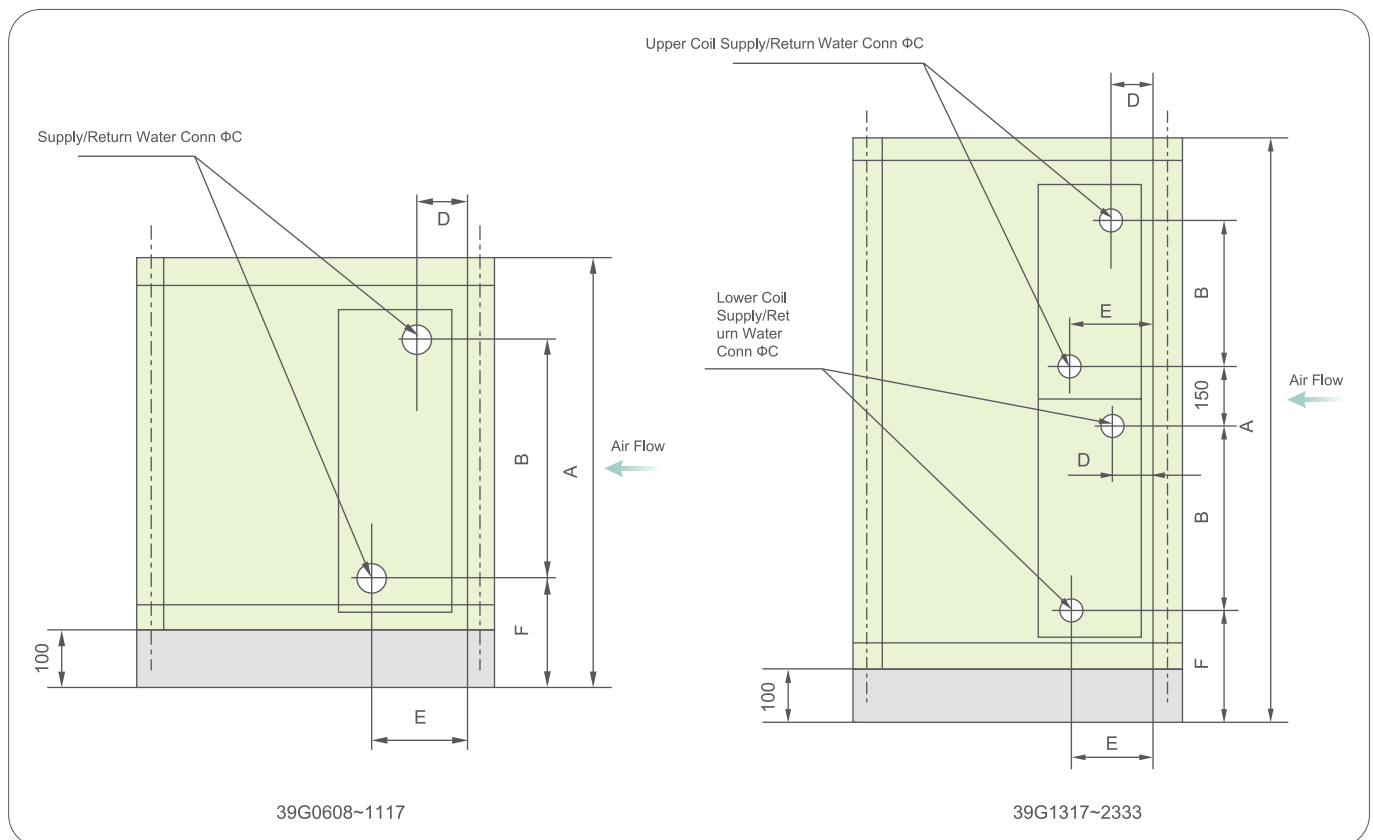

## 39G Horizontal Unit Air Outlet Arrangements and Flange Dimensions

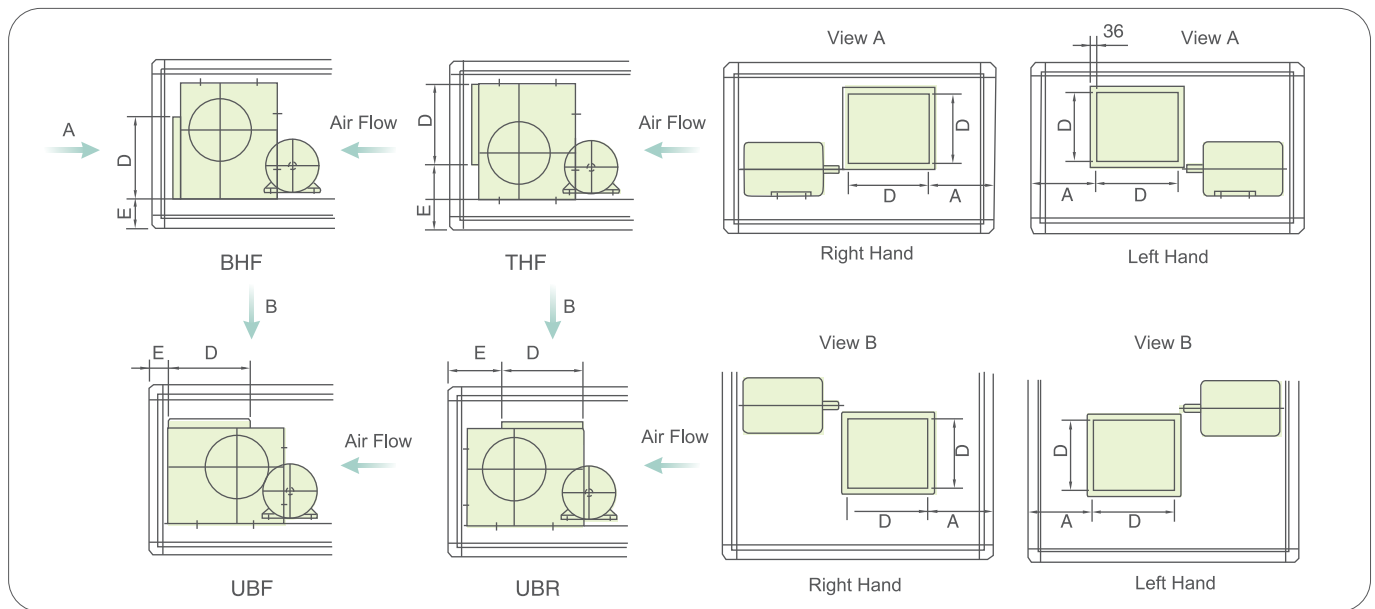

(单位：mm)

Unit Size	Fan Model	A	D	E			
				THF	BHF	UBF	UBR
39G0608	FC160	204	205.0	265.5	143	100	172
	FC180	159.5	229.0	265.5	143	100	197
39G0609	FC180	271	229.0	265.5	143	100	197
	FC200	240.5	256.0	273.5	143	100	206
39G0711	FC200	340.5	256.0	273.5	143	100	206
	FC225	291.5	288.0	287.5	143	100	243
39G0811	FC225	291.5	288.0	287.5	143	100	243
	FC/BC250	291.5	322.0	299	143	100	232
39G0912	FC/BC250	341.5	322.0	299	143	100	232
	FC/BC280	315.5	361.0	316	143	100	281
39G0913	FC/BC280	365.5	361.0	316	143	100	281
	FC/BC315	322.5	404.0	335	143	100	268
39G0914	FC/BC315	372.5	404.0	335	143	100	268
	FC/BC355	375.5	453.0	360	168	100	290
39G1015	FC/BC355	425.5	453.0	360	168	100	290
	FC/BC400	374.5	507.0	388	168	100	320
39G1117	FC/BC400	474.5	507.0	388	168	100	320
	FC/BC450	414.5	569.0	417	168	100	348
39G1317	FC/BC400	474.5	507.0	388	168	100	320
	FC/BC450	369.5	569.0	417	168	100	348
39G1418	FC/BC450	419.5	569.0	417	168	100	348
	FC/BC500	400.5	638.0	438	168	100	370
39G1420	FC/BC500	500.5	638.0	438	168	100	370
	FC/BC560	491.5	715.0	529	228	100	401
39G1621	FC/BC560	491.5	715.0	529	228	100	401
	FC/BC630	405.5	801.0	571	228	100	444
39G1822	FC/BC560	591.5	715.0	529	228	100	401
	FC/BC630	505.5	801.0	571	228	100	444
39G1825	FC/BC630	700.5	801.0	571	228	100	444
	FC/BC710	603.5	898.0	619	228	100	491
39G2025	FC/BC630	700.5	801.0	571	228	100	444
	FC/BC710	603.5	898.0	619	228	100	491
39G2125	FC/BC710	553.5	898.0	619	228	100	491
	FC/BC800	493.5	1007.0	688	241	100	547
39G2226	FC/BC710	653.5	898.0	619	228	100	491
	FC/BC800	593.5	1007.0	688	241	100	547
39G2328	FC/BC800	643.5	1007.0	688	241	100	547
	FC/BC900	615.5	1130.0	745	241	100	604
39G2330	FC/BC800	795.0	1007.0	668	241	150	547
	FC/BC900	767.0	1130.0	754	241	150	604
39G2333	FC/BC800	943.5	1007.0	688	241	100	547
	FC/BC900	915.5	1130.0	745	241	100	604

## 39G Vertical Unit Air Outlet Arrangements and Flange Dimensions

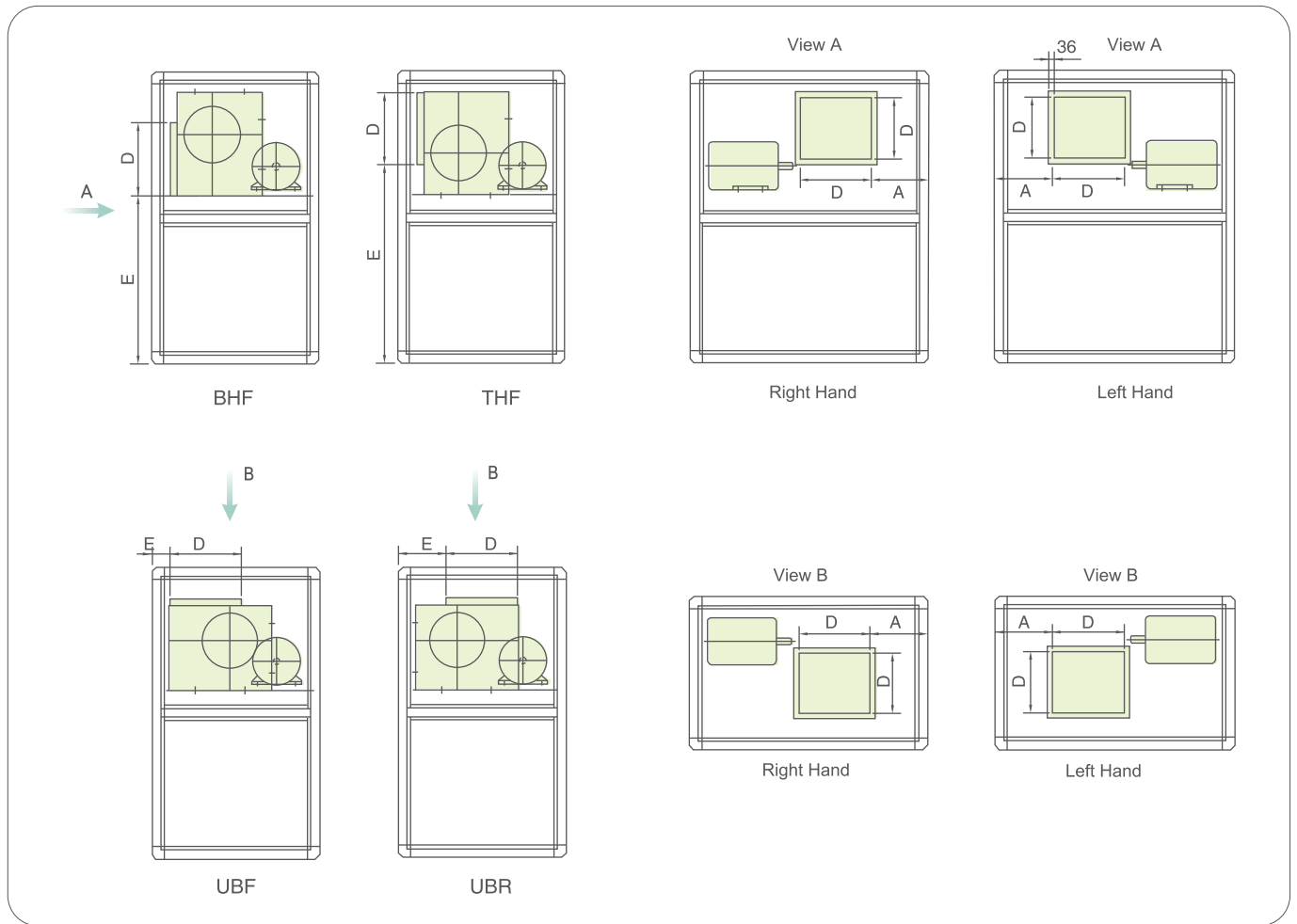

(单位 : mm)

Unit Size	Fan Model	A	D	E			
				THF	BHF	UBF	UBR
39G0608	FC160	204	205	915.5	793.0	100	172
	FC180	159.5	229	915.5	793.0	100	197
39G0609	FC180	271	229	915.5	793.0	100	197
	FC200	240.5	256	923.5	793.0	100	206
39G0711	FC200	340.5	256	1023.5	893.0	100	206
	FC225	291.5	288	1037.5	893.0	100	243
39G0811	FC225	291.5	288	1137.5	993.0	100	243
	FC/BC250	291.5	322	1149.0	993.0	100	232
39G0912	FC/BC250	341.5	322	1249.0	1093.0	100	232
	FC/BC280	315.5	361	1266.0	1093.0	100	281
39G0913	FC/BC280	365.5	361	1266.0	1093.0	100	281
	FC/BC315	322.5	404	1285.0	1093.0	100	268
39G0914	FC/BC315	372.5	404	1285.0	1093.0	100	268
	FC/BC355	375.5	453	1310.0	1118.0	100	290
39G1015	FC/BC355	425.5	453	1410.0	1218.0	100	290
	FC/BC400	374.5	507	1438.0	1218.0	100	320
39G1117	FC/BC400	474.5	507	1538.0	1318.0	100	320
	FC/BC450	414.5	569	1567.0	1318.0	100	348
39G1317	FC/BC400	474.5	507	1738.0	1518.0	100	320
	FC/BC450	369.5	569	1767.0	1518.0	100	348
39G1418	FC/BC450	419.5	569	1867.0	1618.0	100	348
	FC/BC500	400.5	638	1888.0	1618.0	100	370
39G1420	FC/BC500	500.5	638	1888.0	1618.0	100	370
	FC/BC560	491.5	715	1979.0	1678.0	100	401
39G1621	FC/BC560	491.5	715	2179.0	1878.0	100	401
	FC/BC630	405.5	801	2221.0	1878.0	100	444

## Ordering Information

1. Unit Direction: Along the airflow direction, left unit refers to units with water inlet and outlet of the coils and the access door on the left side, vice versa.
2. If units installed at outdoors or in corrosive environment, shall consult factory before ordering so as to ensure unit meet with application requirements.
3. Requirements of the unit basement: The length and width of the unit basement should be designed according to the unit, and the basement should be horizontally flat and higher than the ground for ease of installation of the condensate trap.

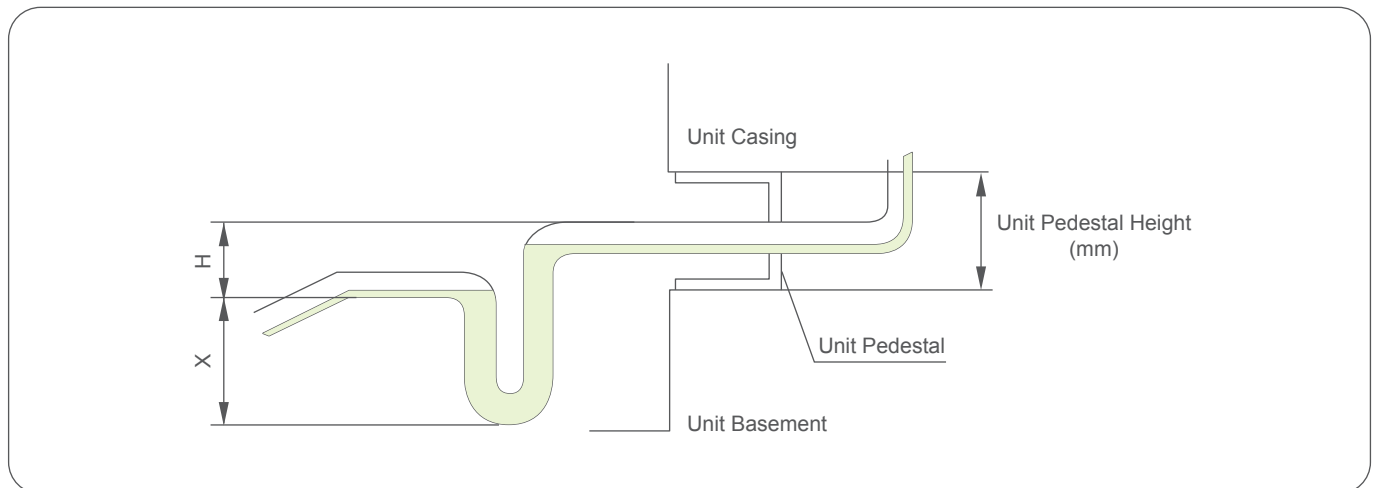

- Calculated Value:  $H = \text{Negative pressure at the drain hole of the condensate plate} / 10(\text{mm})$ ,  $X > 1/2H$
  - Empirical Value: when negative pressure  $< 1,000 \text{ Pa}$ ,  $H = 100\text{mm}$ ,  $X = 70\text{mm}$
4. Notice when connecting the coil: The designed working pressure of both cooling and heating coil is  $1.6\text{mPa}$ .
  5. For fresh air units, when the temperature drops below  $2^\circ\text{C}$ , preheating devices should be required to prevent frost cracking of the coils inside the units.
  6. The supply air temperature of the unit should not be higher than  $80^\circ\text{C}$  (when heating), requests as such shall be brought forward when ordering, so that high temperature bearings and motors could be adopted.
  7. The unit outlet and duct should be connected with flexible connection.
  8. Residual water should be drained of the coil if the temperature falls below the freezing point when the unit is shut down. Put antifreeze in the coil in case there's still residual water.
  9. For electric heating,
    - 1) Electrical components and cable configuration shall be wires according to the power of electric heater.
    - 2) Wiring shall be carried out in line with the electric heater wiring diagram.
    - 3) The temperature relay signal of the electric heater shall be sent to the electric heating controller, to assure automatic power off when the temperature is too high in the unit.
    - 4) The controller of electric heater shall interlock control fan and electric heater, to keep the electric heater module powered off when the fan stops.
  10. PTC thermistor has been installed in fan motor, should connected with protective relay, to achieve motor overheating protection function. If customer need more information about how to choose protective relay, please contact THC for technical support.



Carrier improves the world around us; Carrier improves people's lives; our products and services improve building performance; our culture of improvement will not allow us to rest when it comes to the environment.



[www.carrier.com](http://www.carrier.com)

The Manufacturer reserves the right to change any product specifications without prior notices  
© All Rights Reserved Carrier

Version:	CAT_39G_E-202002_05
Supersede:	CAT_39G_E-1808_04
Effective Date:	Feb, 2020