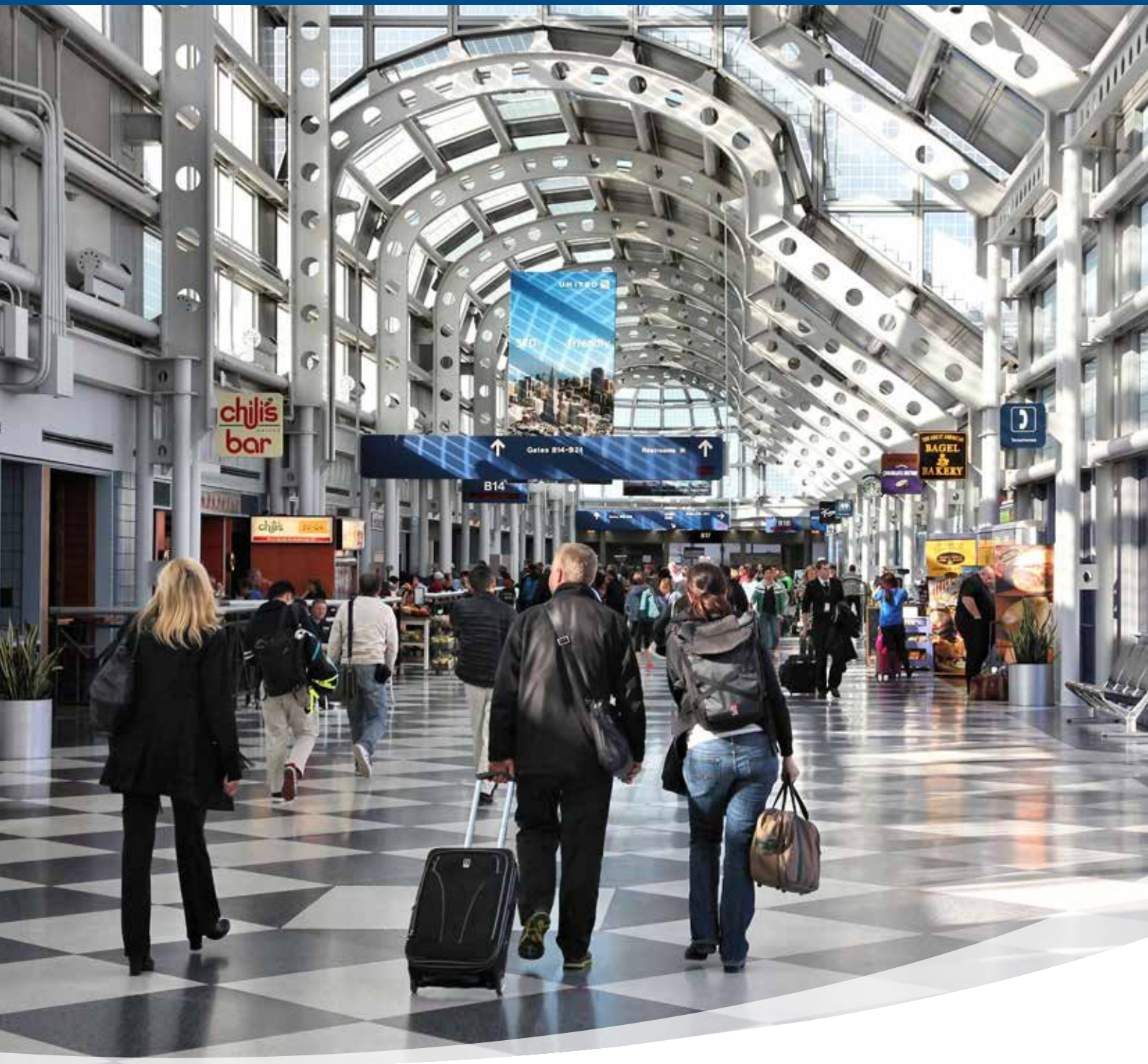


Air Handling Unit

SBA / BA



Systemair around the globe

Systemair was founded in 1974 with an innovative idea of creating an in-line centrifugal fan for circular ducts, which simplified ventilation.

Today, our company is one of the global leaders in the field of ventilation & air conditioning technology, with its operations spread across four continents. Our main focus is to develop products that supply, extract, convey, heat, cool and distribute air energy efficiently in a building. Our products are energy efficient, robust, easy to select, install and use.



50

Countries with Sales Subsidiaries



27

Production Facilities

Always close to you!

Contents

Systemair worldwide.....	2-3
Systemair India.....	4-5
Air handling units - overview.....	6-7
Example of applications	8-9
Components of Air handling units.....	10-22
Control panel.....	23
Selection tools.....	24-29
Unit dimensions.....	30-39
Certifications.....	40-43
Few of our valued customers.....	44-47

Systemair- we make in India

MARKET-LEADING PRODUCTS AND SOLUTIONS

Innovative product development closely tied into external trends are crucial to our ability to offer market-leading products and solutions that help customers to meet their challenges – today and tomorrow.

Systemair started operations in India in 2006 to meet the needs of fast growing markets. Today, Systemair India Pvt. Ltd. (100% owned subsidiary of Systemair AB, Sweden), is a reputed manufacturer in ventilation and air conditioning equipments.

In India, Systemair has 9 offices in Noida, Hyderabad, Bengaluru, Chennai, Kochi, Kolkata, Pune, Mumbai & Ahmedabad and 2 ultra-modern factories located at Greater Noida & Hyderabad.

The Greater Noida factory is a LEED Platinum certified building with an ultra modern Research & Development center having ATD & Acoustic laboratory built in compliance with EN 1228 and AMCA 210 & AMCA 300 standards.

The team of 400 dedicated professionals are now working in India looking after sales, technical support, production & logistics.



LEED certified Platinum rated Unit, India.



Manufacturing Facility, India.



Acoustic Lab, India.

The wide product range manufactured in India are 'Fans' 'Air handling units' & 'Air distribution & Fire safety products'

Fans



Air Handling Units



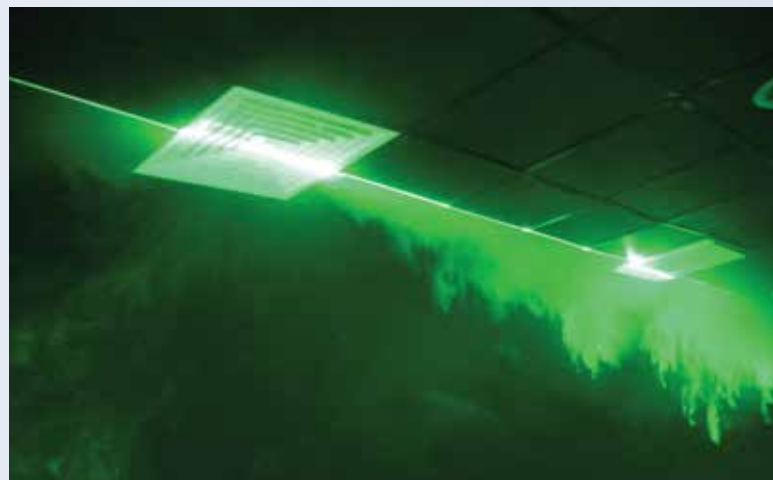
Air Distribution & Fire Safety



Explore more about air handlers with us >>>



Air Flow Chamber, India.



ATD Lab, India.

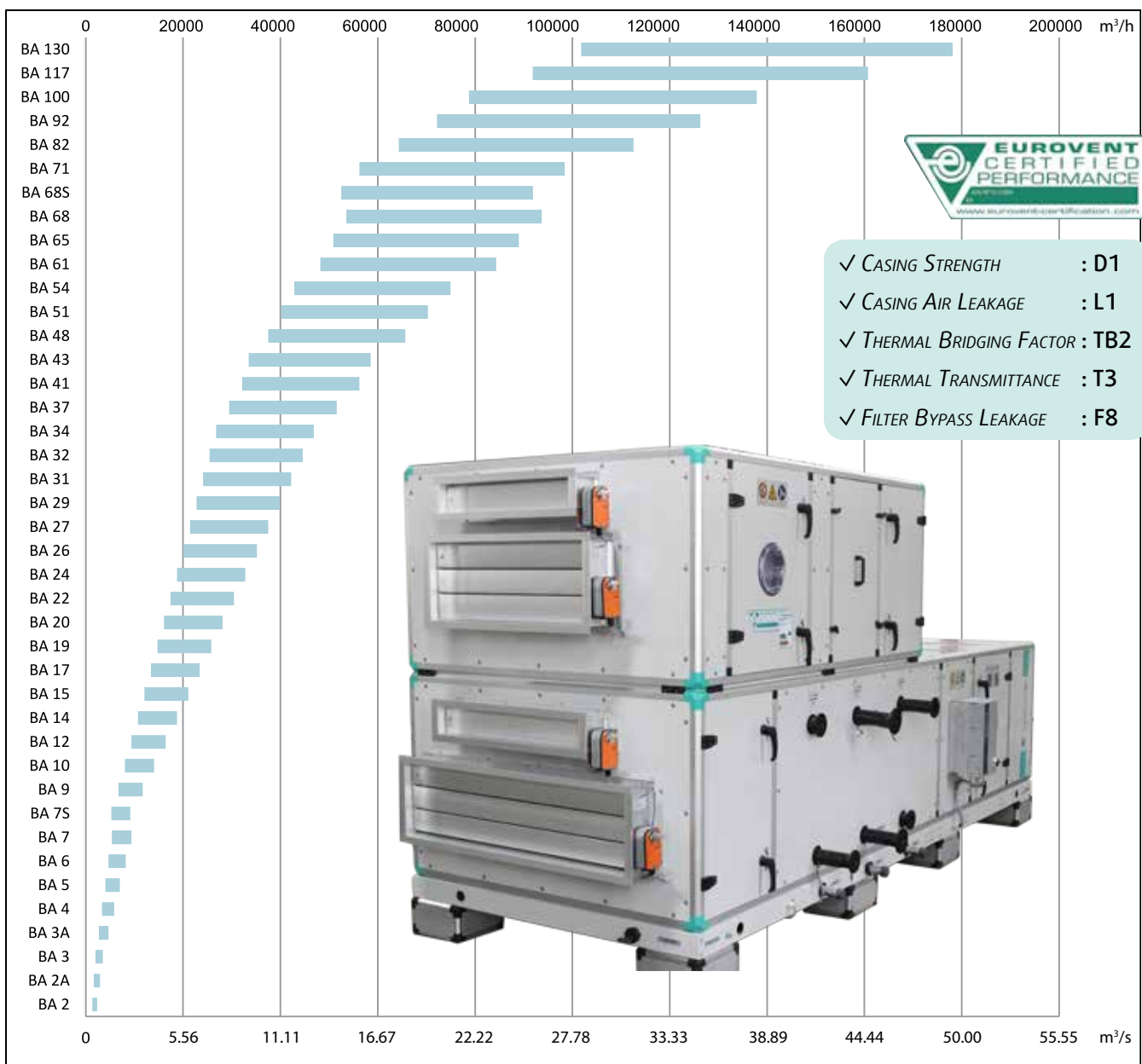
Air Handling Units

Modular & extremely adaptable

Systemair has a wide range of air handling units for use in various applications from small office premises to larger industrial applications. Common to all items in the range is that, systems and components have been developed to satisfy stringent demands for low energy consumption. Heat exchangers, motors and fan units have all undergone extensive testing, both in the laboratory and out in the field, in order to comply with current and future demands for low energy consumption.

All products are also manufactured to comply with environmental requirements. To ensure easy installation, many of these units feature control systems enabled for plug-and-play, i.e. simple start-up.

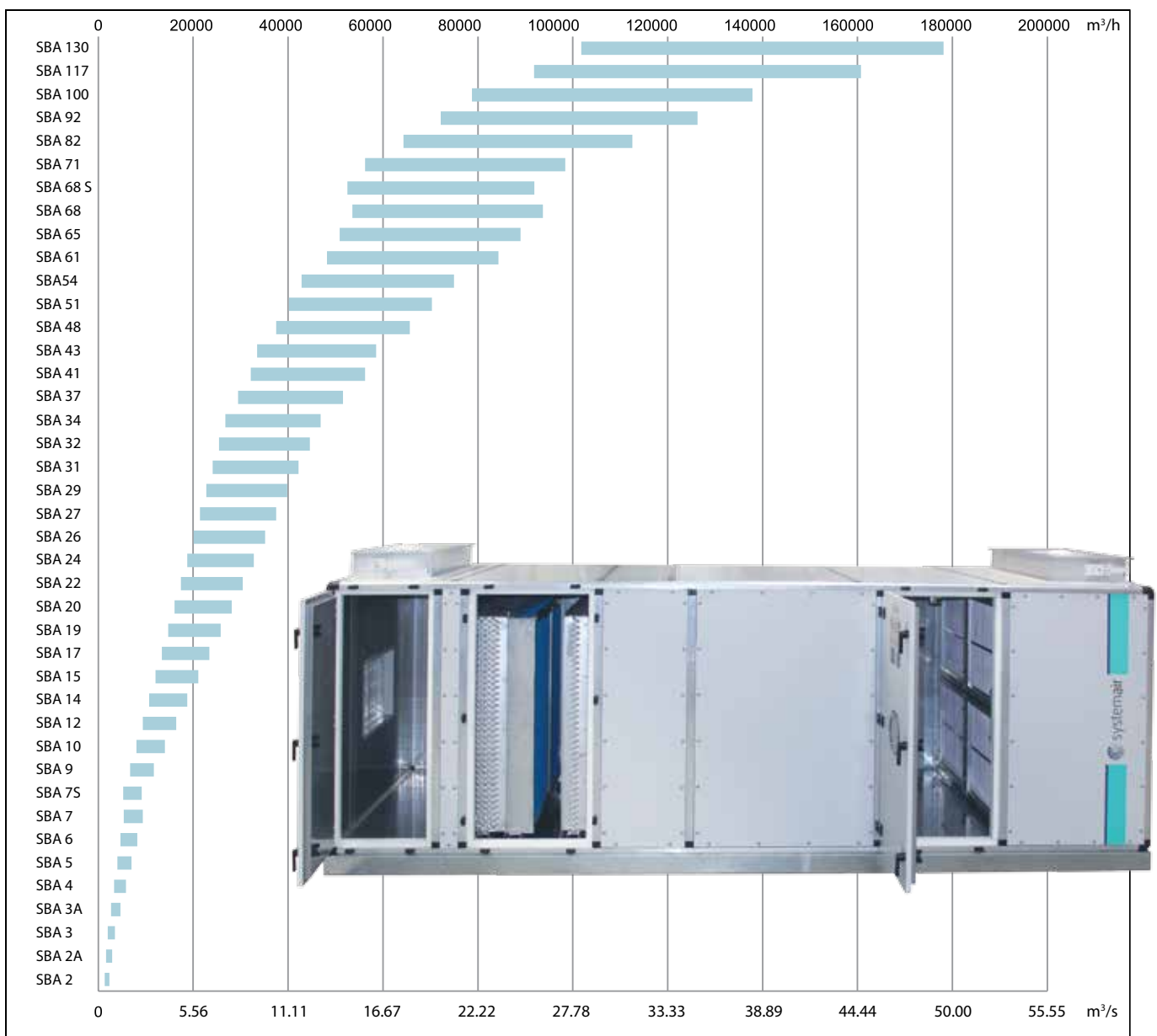
BA Units Eurovent certified- with 50mm panel



Facts about AHU

- BA units are Eurovent certified & SBA units are standard units
- Eurovent certified units are available in 50mm panel
- SBA units are available in 25mm & 50mm panels
- Available in 41 different models
- Handles airflows of 1000-178000 CMH
- For use with medium or high air pressure systems.
- Heating and cooling units
- Extensive range of filters & Heat recovery sections
- Static pressure upto 2300pa

SBA Standard Units- with 25mm & 50mm panel





Reference: "Seawoods Grand Central", Mumbai -India

Seawoods grand central is India's largest Transit -Oriented- Development project in Mumbai.

A unique combination of Commercial, Retail and Hospitality around the world class railway concourse, spread across 40 acres of land.

Products/Solution:

Modular air handling units

Air Distribution Products

Fire Safety Products

Examples Of Applications

Our air handling units are designed in modules. The module can be configured for different applications to make up the heart of any air conditioning system. The flexibility makes it possible to optimize the air handling unit for specific requirement.

Comfort Solutions

Simple project implementation for expansion of existing premises or new buildings. Simplifies selection and planning and includes smart solutions for easier installation.

Compact Solutions

Extreme space-saving solutions and new connections for units that can also be split. Completely adaptable to satisfy all new demands. Compact air handling units are easier to transport and handle at the construction site.

Flexible Solutions

Flexible solutions with heat recovery and intelligent control functions that are easily adapted to suit current needs of different recovery systems and configurations.

Plug & Play Solutions

Integrated control systems. Our factory-integrated solutions are designed with various levels of equipment that can handle everything from the simplest requirement to the toughest demands.

Industrial Solutions

Air humidifiers can be installed in air handling units, which makes it suitable for air cooling, water spray humidifier and scrubber applications.

Clean Room Solutions

Clean rooms can encompass numerous applications, everything from operating theatres to laboratories. Systemair's range of air handling units can satisfy all requirements relating to healthcare, whether these have to do with air cleanliness, noise levels or demand control.

Components of air handling units



Fan/motor.

A variety of fans can be offered based on the requirement.

- Belt driven DIDW centrifugal FC/BC fans
- Centrifugal plug fan
- Motors with IE1/IE2/IE3 efficiency
- PM motor with IE4 efficiency



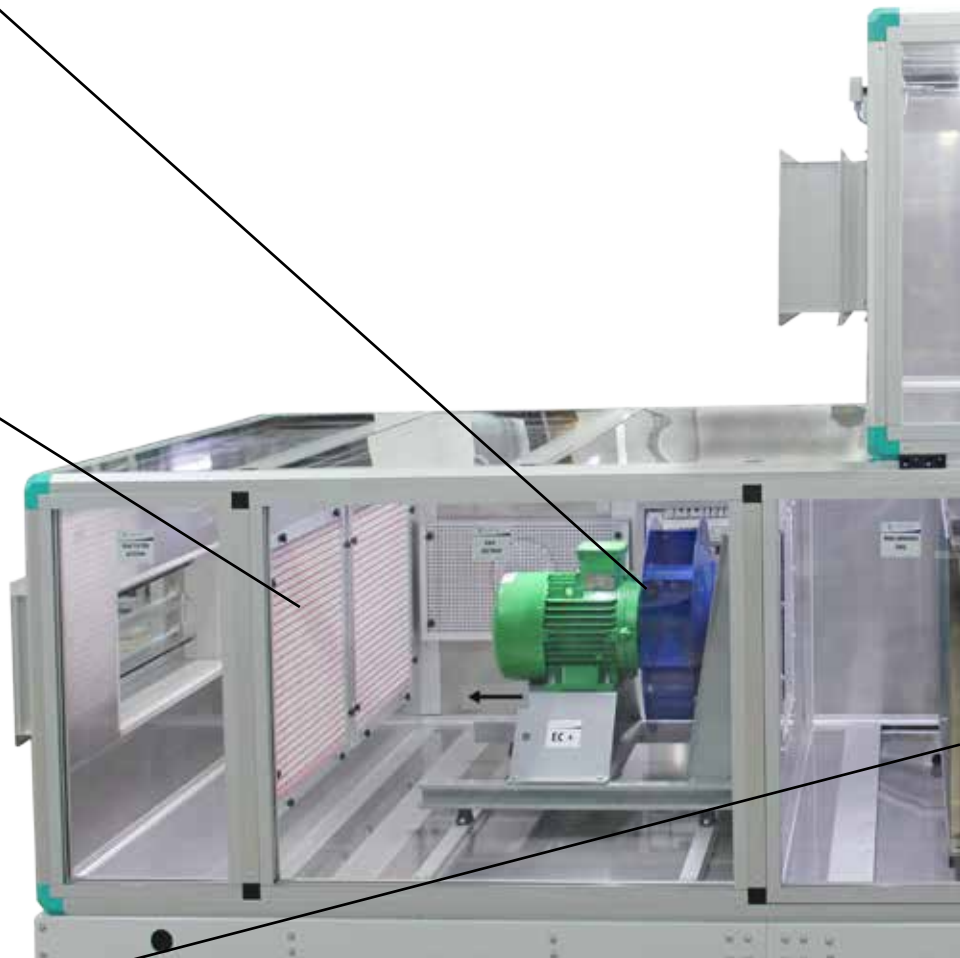
Supply and extract filters.

Units are offered with high quality & low pressure drop filters of different particulate efficiency.



Heat transfer coils.

Copper tube aluminium finned heat transfer coils available in multiple rows deep and are designed to give certified performance output for heating, cooling & recovery applications



Control system.

Units can be provided with fully tested control systems for all necessary standard functions and the settings can be easily adjusted to desired operational values.



Inspection doors/handles.

Adequate sized inspection doors are provided in each section fitted with high quality comfortable handles.





Tightness/corners.

Framework of airtight, elegant & sturdy extruded aluminium hollow profile with polyamide thermal break profile having glass filled nylon corners & spacers.



EC fan.

A wide range of EC fans can be offered.



Supply and extract dampers.

low-leakage extruded aluminium dampers suitable for manual or motorised operations.



Base frame.

The base frame is made from strong galvanized steel with lifting provision.



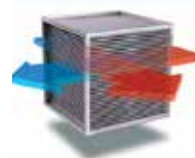
VFD.

Units are supplied with single speed motors. To regulate the fan speed to its actual point, frequency converters can be provided.



Heat exchanger.

High quality and energy-efficient heat exchangers are available: rotary heat exchanger, plate type heat exchanger, heat pipes or run around coil heat exchanger.



Casing

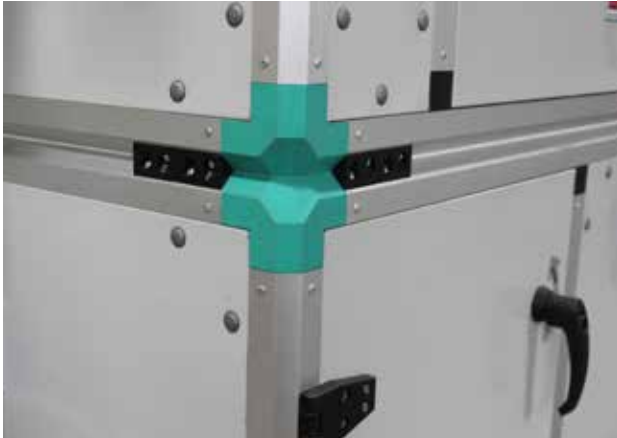
The metal enclosure that covers all the components contained in the Air Handling Unit is sturdy and has no protruding items to disturb the overall look of the unit.

Air handling units have a frame composed of an extruded aluminium section that outlines the equipment edges perfectly, resulting in a solid, robust and attractive overall look.

These aluminium extruded sections are joined by injection-moulded glass-reinforced plastic angle cleats. In these larger sizes, the sections are joined together by angle cleats made from engineering plastics. The assembly is anchored by slot screws, obtaining a solid, sturdy structure.

The unit enclosure is made up of sandwich panels comprising two pieces of galvanised sheets one inside the other.

The inner rack is manufactured of aluzinc or galvanised steel sheet, whereas the exterior rack of the same material has pre-coated/ aluzinc finish. The insulation material between the two racks is either machine injected polyurethane foam insulation or rockwool / glasswool to ensure excellent thermal & sound insulation and potential condensation.



The AHU panels are manufactured in nominal thickness of 25mm & 50mm which are mounted on a frame composed of an aluminium profile, which outlines the equipment edges precisely.

Regardless of the type of structure, all panels on the access side can be easily dismantled, thereby facilitating access to the internal parts of the air handling unit by the maintenance staff.

The finished equipment can have a bedplate composed of channel sections or feet. Based on the project needs, it can also be set on shock absorbers when vibration must be avoided.

The enclosure described contains all the air handling unit sections, which can include some or all of the ones described below:

Inlet Section

This section is composed of a standardised length with an air inlet to the air handling unit.

This opening can:

- Use a volume control damper, that can be equipped for manual operation or for subsequent automation.
- Be protected by an air shutter.
- The combination of the previous two.
- Be equipped with a simple inlet consisting of a straight flange for easier duct connection;

In addition, a cover to prevent water from entering when the equipment is placed outdoors can be provided.

Mixing Section

This has similar features as the above and two openings, each of which contain a control damper.

These dampers can be supplied with an extruded aluminium section construction. These damper models have an aluminium airfoil blades.

The operating mechanisms for all dampers are installed in the channel frame. This allows air to circulate freely and facilitates installation in closed ducts. The mechanisms and fasteners are made of corrosion-resistant materials.

The operating mechanism of the dampers may be manual or equipped for motor-driven operation. In the latter case, upon request and depending on the damper size, these controls can be supplied interconnected so they can be operated by a single servo drive.

Free Cooling Section

This section requires a return fan and a supply fan. These fans must have three dampers in between to regulate the volumes of exhaust, return and outside air. Therefore, in order to meet their purpose the dampers must be motor-driven.

When the enthalpy of the outside air is less than the enthalpy of the recirculated air, i.e., during spring and autumn, the mixture of outside air and recirculated air is controlled to achieve free cooling.

Consequently, the relative opening of the dampers is determined by an enthalpy (or dry temperature) comparator, which sends the respective signal to the damper motors.

In order to ensure the minimum ventilation air required in cooling or heating seasons, the outside air inlet damper can be split into two sections (one motor-driven and another manual that remains fixed). The cross-section of the damper will be proportional to the minimum ventilation air flow.

This effect can also be achieved more economically by adjusting the stroke of the motor operating the outside air damper so it does not close completely.

Access Section

This section, which has a hinged access door and is equipped with an enclosure and handle, is sandwiched in the air handling unit configuration to allow access to the lower parts that require surveillance or regular maintenance.

It may also be used to hold any type of auxiliary component, such as a perforated jet humidifier for

direct humidification with steam, or other types of components.

Filters

One of the purposes of the air handling unit is to ensure the purity of the room air. Air filtering is related to the quantity, variety and size of the suspended impurities, the existence of contaminant gases or odours, and the desired filtering efficiency. The various impurities that can exist in the air are discussed below.

The air contains numerous foreign substances caused by natural processes (e.g., wind erosion, sea evaporation, soil movements, volcanic eruptions) and by human activity (e.g., combustion). Atmospheric dust is a mixture of fog, combustion gases, fine dry particles and fibres. Air testing normally indicates the presence of soot and smoke, quartz, soil, residue from decomposed animals and vegetables, organic substances in the form of cotton and plant fibres, and metal fragments. The air also contains other organisms such as micro organisms, spores and pollen.

Particle size is expressed in microns (10-6 m). Air contains particles with a thickness of up to 0.01 microns and other particles with a thickness similar to fibres, leaves, etc. Dust is generally understood to mean particles under 100 microns. The particle size distribution of particles in atmospheric dust can be measured in several ways. Traditionally, a variety of measurement methods have been used to determine the efficiency of the different types of filters and no classification system combining the various criteria in use existed. The first version of the Unified Standard EN 779 was issued to unify the classification criteria for all filters with an initial efficiency with atmospheric dust less than or equal to 98%, (Group G: coarsedust filters; Group F: fine-dust filters). Later, in 1998 the first version of Unified Standard EN-1822 unifying the classification criteria for HEPA and ULPA absolute filters was published. The initial efficiency of these filters with atmospheric dust is greater than 98%.

The standardised range for the BA Air Handling Unit includes three air filtering sections which, combined with the wide variety of filtering materials, covering an extensive range of possibilities in filtering efficiency.

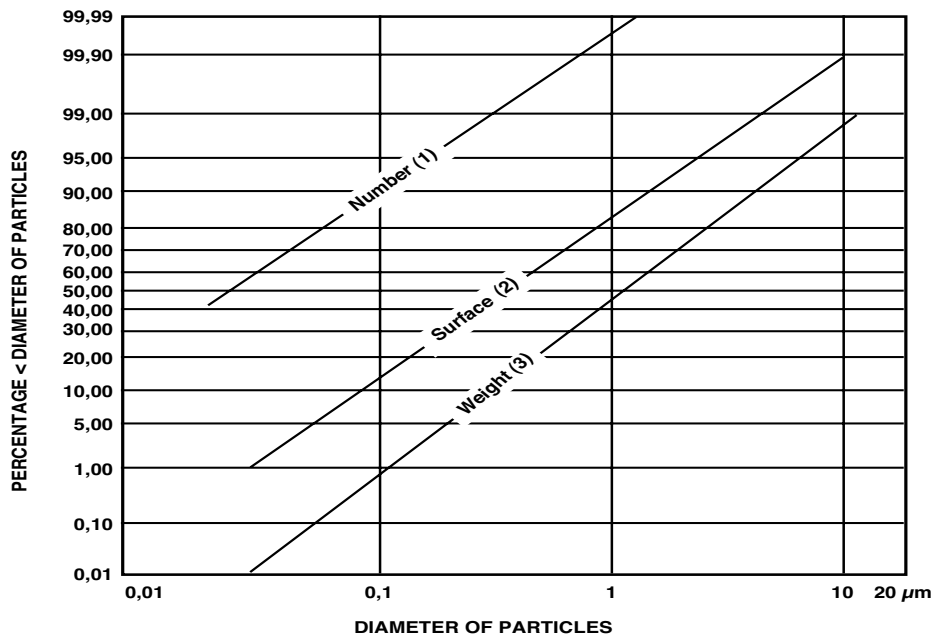


Door hinge



View window

Door handle



Extended surface filters

Characterised by a specific type of pleat which produces a larger filtering surface. The pleat design, as well as the alignment between the pleats, ensures uniform air circulation over the surface of the filtering media.

The extended surface filter is composed of a frame, filtering media in zigzag layout, and electrowelded mesh to hold the media. Its advantages with respect to flat filters are:

- Greater filtering surface;
- Reduced front air velocity;
- Greater efficiency;
- Greater dust retention capacity;
- Reduced front surface.

The filters correspond to Classes G1, G2, G3 and G4 of Group G (coarse-dust filters) and Class F5, F6 and F7 for Group F (fine-dust filters), as per UNE-EN 779.



Extended filter.

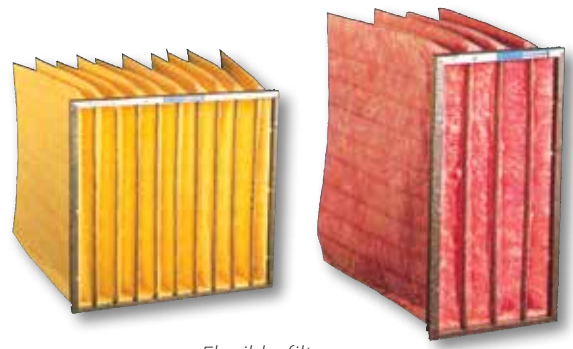
Flexible bag filters

The flexible bag filters allow a high filtering flow rate in relation to the front surface area. Constructed with fibreglass (greater efficiency) or synthetic fibre (lower efficiency) filtering media.

Flexible filters have the following advantages:

- Lower power requirement.
- Longer filter renewal interval.
- Lower energy costs.
- Lower maintenance.

These filters have a medium to high efficiency and correspond to Classes F5, F6, F7 and F8 of Group F (fine-dust filters) as per UNE-EN 779.



Flexible filter.

Classification of filter in accordance with EN779				Filters can also be classified as follows	
Class		Ability to separate synthetic dust, A_m	Mean value of the collecting efficiency, E_m	Eurovent 4/5	ASHRAE
G 1		$50 \leq A_m < 65$	-	-	-
G 2		$65 \leq A_m < 80$	-	-	-
G 3		$80 \leq A_m < 90$	-	EU3	G85
G 4		$90 \leq A_m$	-	EU3	G90
F 5		-	$40 \leq E_m < 60$	EU5	F45
F 6		-	$60 \leq E_m < 80$	EU6	F65
F 7		-	$80 \leq E_m < 90$	EU7	F85
F 8		-	$90 \leq E_m < 95$	EU8	F95
F 9		-	$95 \leq E_m$	-	-

Rigid bag filters

Rigid bag filters have similar filtering capacity as flexible bag filters with the following advantages:

- Solid, sturdy construction for fast, easy installation.
- Compact, reduced-volume design.

They have a medium to high efficiency and correspond to Classes F5, F6, F7, F8 and F9 of Group F (fine-dust filters) as per UNE-EN 779.

Both the rigid and the flexible bag filters are specially recommended for:

- Hospitals.
- Pharmaceutical companies.
- Food industries.
- Computer rooms.
- Office buildings.

Likewise, both rigid bag filters and the flexible bag filters of Class F8 and F9 trap particles below 6 microns, which correspond to the smallest particles of those in temporary suspension that are visible under a microscopic.



Rigid filter.

Absolute filters

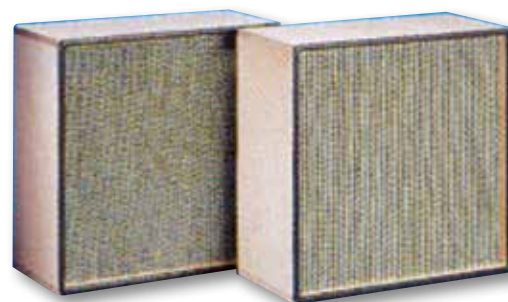
Require careful installation that guarantees complete air-tightness of all gaskets. They are designed to eliminate virtually even the smallest particles in the air, i.e., those in continuous suspension (the smallest of these are only visible using electronic microscopes).

They are specially recommended for:

- Hospitals.
- Food industries.
- Pharmaceutical companies.
- Clean rooms.
- Absolute filtering of air in environments with controlled contamination.

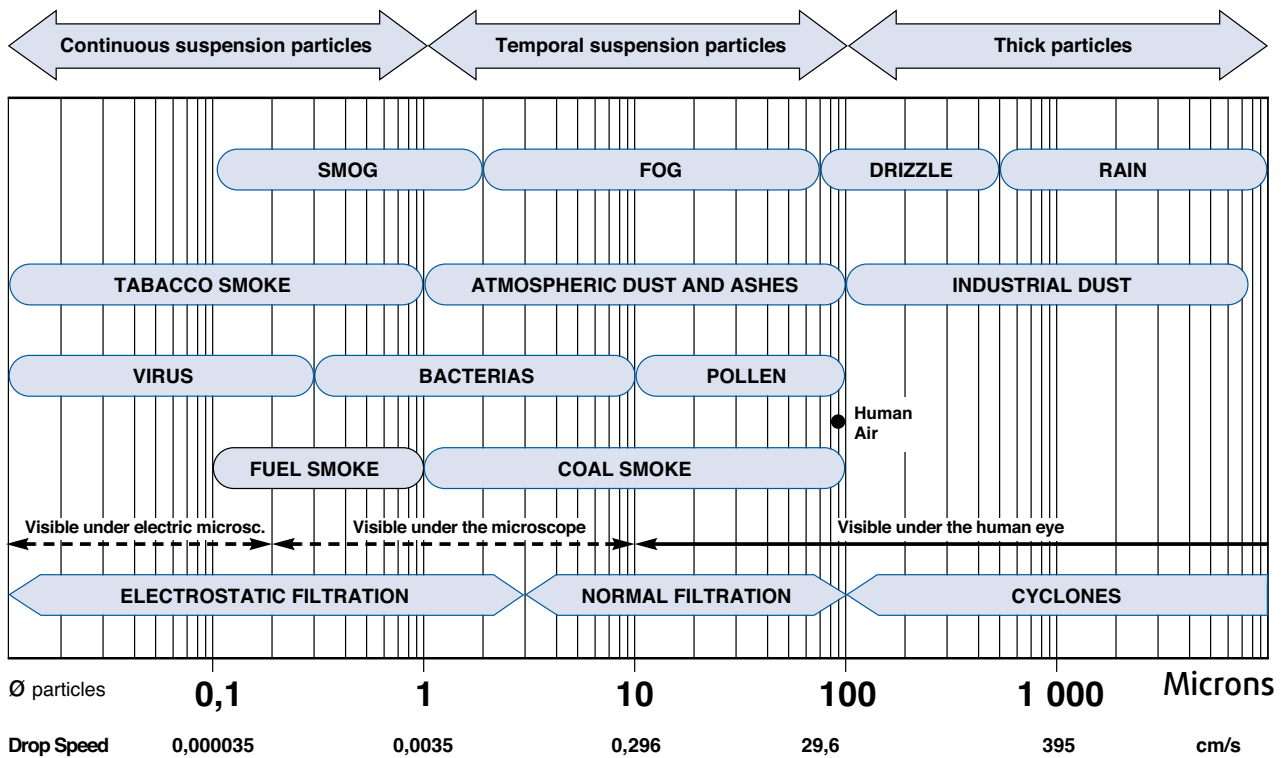
They should be installed immediately before the space requiring this virtually sterile air that these filters can supply.

They correspond to Classes H10, H11, H12, H13 and H14 of Group H: absolute filter, HEPA and ULPA, as per UNE-EN 1822.

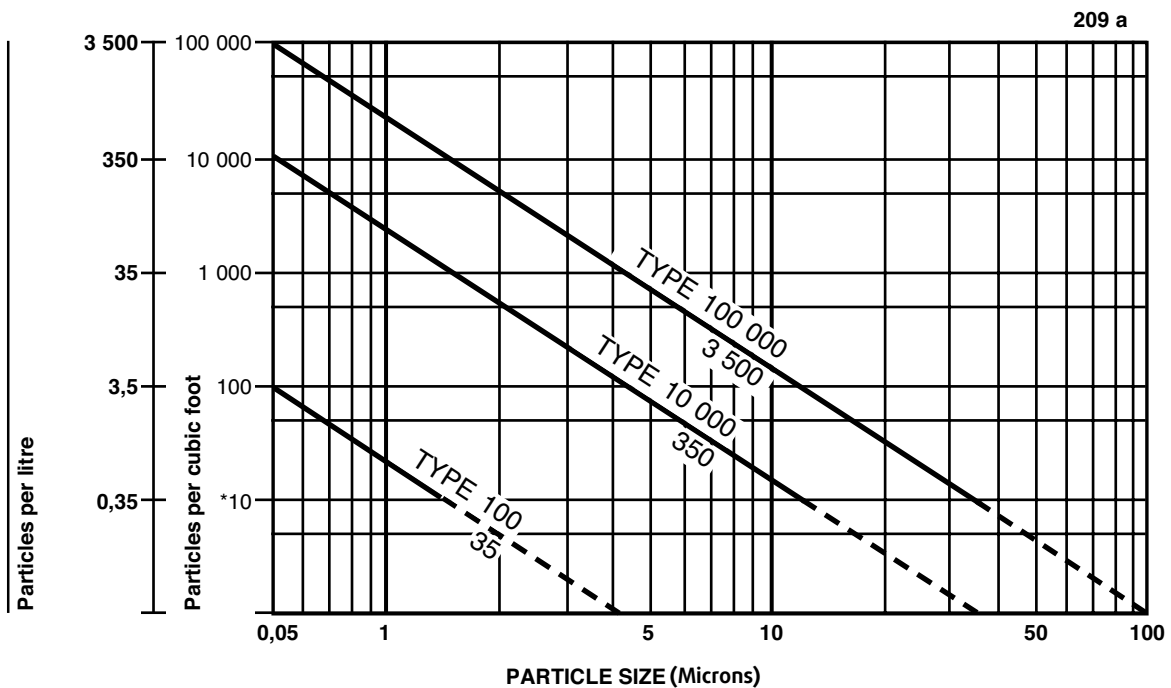


Absolute Hepa filters.

CHARACTERISTICS OF THE MAIN ATMOSPHERIC POLLUTANTS



AIR PURITY CONDITIONS IN CLEAN ROOMS



* Counts below 10 particles per cubic foot (0.35 per litre) are dubious.
 Example: admissible particles for a Class 10,000 system:
 10.000 per cubic foot, 0.5 microns.
 1.200 per cubic foot, 1 micron.
 70 per cubic foot, 1 micron.

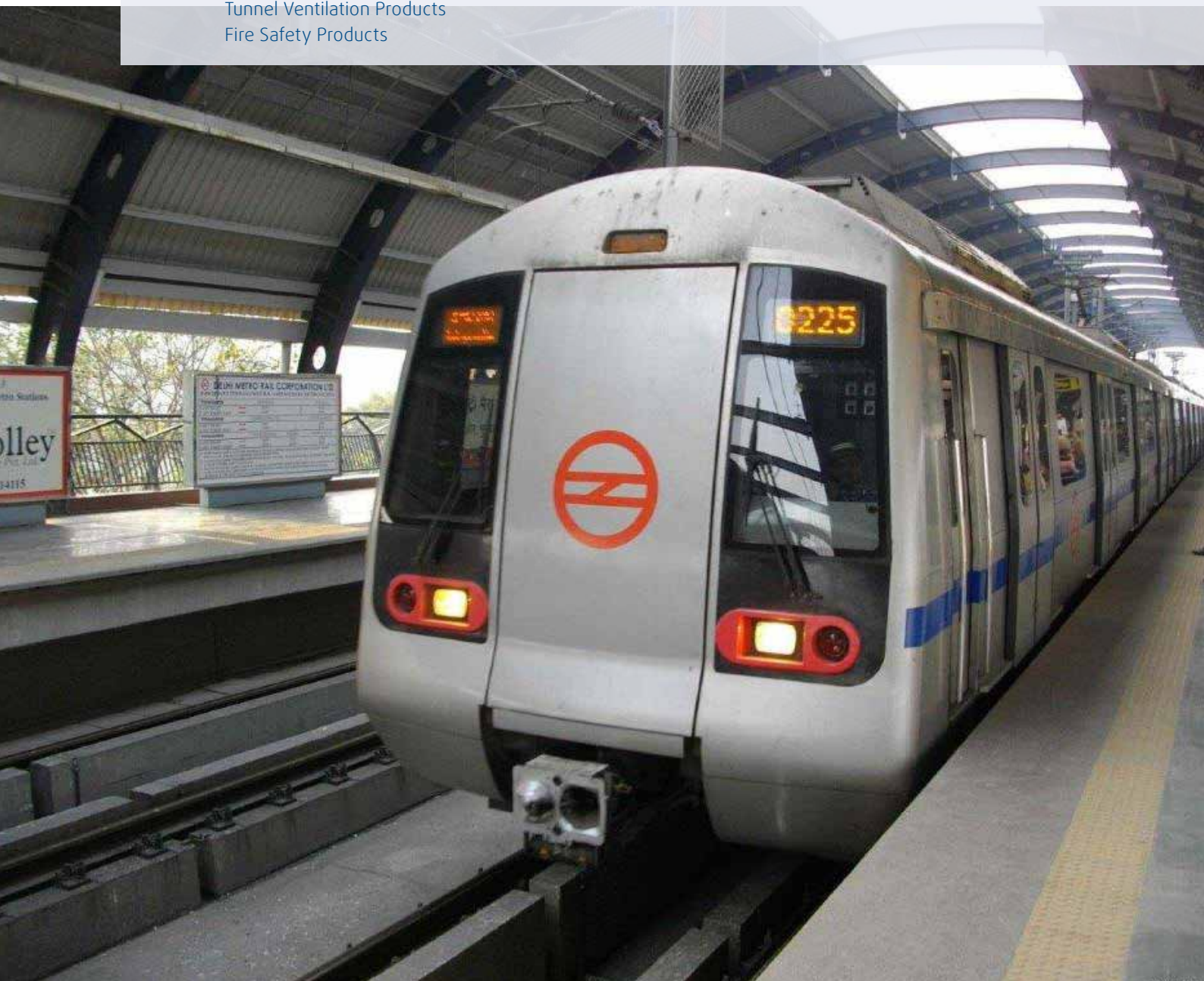


Reference: Delhi Metro "DMRC", Delhi, India

The "Delhi Metro" is a new era in the sphere of mass urban transportation in India. These modern Metro are comfortable, air conditioned and eco-friendly. A revolution in the mass transportation scenario not only in the National Capital Region but the entire country.

Products/Solution:

- Modular air handling units
- Air Distribution Products
- Tunnel Ventilation Products
- Fire Safety Products



Heat transfer coils

The cooling and heating units are composed in the enclosure described above, which contains the tube-and-fin heat transfer unit, mounted on a special joint cover.



For air cooling processes, units composed of copper pipes and aluminium fins (Cu/Al) are normally used. At the bottom, the cooling section has an aluminium/stainless steel pan for collecting condensation and a small hose to drain the condensation toward the outside. The pan is slightly tilted for easier drainage, in order to prevent the proliferation of harmful bacteria such as Legionella pneumophila.

Direct expansion units are also used for cooling. These units can be equipped with one or two manifolds. For heating processes, the same type of copper/aluminium units used for cooling is normally used. If the air might contain corrosive chemicals, copper tube and fin (Cu/Cu) units should be used to improve the corrosion resistance of the equipment. This type of unit is more expensive than the copper/aluminium unit.

Electrical heating units can also be installed upon request, depending on the customer's needs.

Copper tube and aluminium fin heating/cooling units

This class of heating/cooling unit is most commonly installed in air handling units and is composed of a coil of copper pipes covered with thin aluminium fins to greatly increase the primary heat transfer surface of the tube, due to the large transfer surface of the fins.

The front air velocity surface (A_{fo}) expressed in m^2 is determined by the dimensions (width x height) of the air handling unit internally.

The maximum horizontal length of the finned coil is

determined by the working width of the interior of the air handling unit and expressed in mm. The depth of the heating/cooling unit is composed of a specific number of rows of tubes facing the direction of air flow. The number of rows is calculated according to the air flow conditions at the inlet and outlet of the unit, based on the cooling or heating energy used by the equipment.

The number of rows is defined by a number, followed by the letter "R".

Based on the above, a unit designated as 20T 3R 950 means:

20 T Height of 20 tubes, equal to 635 mm;

3 R Depth of three tubes

950 Length of finned coil, in mm.

The standardised Air Handling Unit range uses the following heating/cooling units:

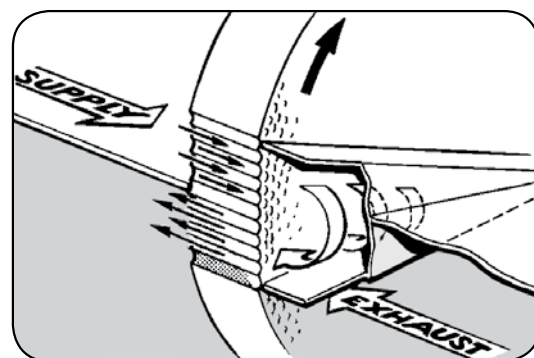
This range can be used with any cooling or heating fluid except steam, where the length of the finned coil is slightly lower, since collectors must be mounted on both sides of the unit instead of one side only, as normally done with other fluids. e deformed under these conditions due to excessive expansion of the metal.

Heat Recovery

Rotating regenerative air-to-air recovery unit

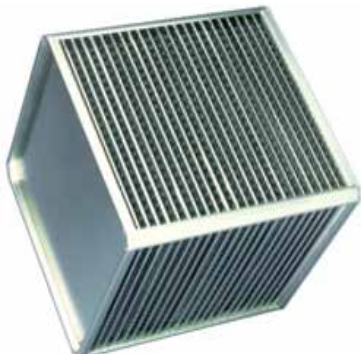
Specially designed to transfer sensitive (temperature) and latent (humidity) heat from the exhaust air to the supply air.

The supply air stops in one of the halves of the heat recovery unit, while the exhaust air circulates in counterflow through the other half.



When the impeller turns, the small air flowing channels comprising the impeller are alternately in contact with clean air and with return air, transmitting heat and moisture from one circuit to the other.

Static recovery unit



Designed with air-to-air crossflow to transfer sensitive (temperature) heat; in this type of heat recovery unit, the supply air is completely separate from the exhaust air, in order to prevent any type of contamination from one air stream to the other.

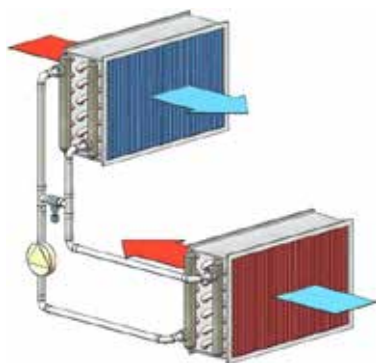
- Heat transfer takes place through the plate separating the two streams.
- Two adjacent plates form a small duct for exhaust or supply air.
- The plate-to-plate distance varies, depending on the size and efficiency requirements.

Run around heat pipe

Designed to transfer sensitive (temperature) heat, using units manufactured with copper pipes and aluminium fins (Cu/Al).

The method is simple and economic, as the return air flows through one of the units, heating the water that circulates inside and is then exhausted.

The outside air flows through the other unit, which heats the air while it cools the circulating water, with the latter heated again in the return circuit, creating a continuous sensitive-heat recovery cycle in the air.



In order to ensure proper system operation in winter, facilities with an extremely low outside air temperature must use glycol water.

Benefits achieved from the installation of any of these

heat recovery systems:

- Reduced heating plant power, minimising equipment sizes in terms of boilers, fuel tank, circulating pumps, heat pipes and heating units.
- Reduced cooling plant size (compressors and condensers or cooling towers), circulating pumps, pipe grid and cooling units. Savings in operating power consumption for heat and cold generation.

Any of the recovery systems mentioned in this section can be installed upon request only, as they are not included in the BA standardised range.

Fans

This section is composed of a centrifugal fan with an anchor bedplate, drive and electric motor or plug-fan.

The centrifugal fan motor assembly is mounted on Silentbloc bushings and the discharge outlet is joined to the opening in the enclosure by means of a flexible fire retardant synthetic seal.

This allows the unit to run without external transmission of the small vibrations normally caused by fan motor assemblies.

Centrifugal fan

There are three types of fans that cover all needs: the forward and aerofoil models for low pressures and the backward for medium and high pressures.



Forward curve fan.



Backward curve fan.

Once the fan model is selected, check the respective behaviour curve to obtain the unique characteristics.

Based on two essential factors (air flow and total static pressure), the following is obtained:

- Revolutions per minute
- Efficiency, in %
- Input power at the shaft, in kW;
- Mean sound power level of the octave bands, in dB;
- Air outlet velocity, in m/s;
- Dynamic pressure, in mm w.g.
- Peripheral velocity, in m/s.

Plug fan

Plug fan built into an acoustically insulated air handling unit. A plug fan supplies air at the fan section outlet with a low and even air speed. In certain situations it can, therefore, be an advantage to position air handling components on the outlet side of the fan.



Plug fan.

Single inlet plug fan with open outlet into the air handling unit. The fan impeller is fitted directly to the motor shaft. This fan type has low sound power levels in the lower frequencies. Efficiency up to 75%.

The motor is supplied with a 1-speed motor. In order to regulate the fan speed to its actual operating point the motor must be fitted with a frequency converter.

The frequency converter can continuously control the fan speed and airflow. Power consumption can be greatly reduced by operating the fan at lower speed.

Operating temperatures:

Standard design: -10/+40 °C

Special design: -30/+60 °C.

All fans are fully balanced both statically and dynamically. The fan and motor are built on a stable base frame that is connected to the unit casing with rubber vibration isolators. These are designed for high levels of vibration absorption.

The fan inlet is flexible connected to the unit casing. This ensures a good vibration absorption.

EC fan

The EC fan is equipped with a Single Inlet Centrifugal Impeller with High Efficiency Backward curved blades and external rotor EC (Electronically Commutated) motor,



EC fan.

energy optimized for operation without spiral housing for high efficiency and favourable acoustic behaviour. The high efficiency backward curved impeller with rotating diffuser, made of high performance composite material / welded aluminum sheet material, with external rotor motor balanced together statically and dynamically

Aerofoil Fans	EFFICIENCY	AREA OF APPLICATION
	Most efficient of the centrifugal fans	General ventilation/air conditioning
	Most efficient operating conditions are achieved with maximum flow of 40-50%	Mainly large systems
	Power is also peaked at the maximum efficiency level	Significant energy savings in large industrial fresh air systems

Backward Curved Fans	Efficiency is slightly lower	General ventilation/air conditioning
	Similar efficiency with Aerofoil fan	Certain industrial applications where air foil fans might be exposed to corrosion and wear

Forward Curved Fans	Fan should not be operated on the right side of maximum pressure	Mainly for low pressure ventilation/air conditioning applications
	Most efficient operating conditions are achieved with maximum flow of 50-60%	
	Lower maximum efficiency than the other centrifugal fans	

according to DIN ISO 1940 Part 1.

The EC fan is capable of being fitted in horizontal or vertical position in the AHU, depending on the application. Inlet cone is provided with a nozzle for volume flow measurement of the fan.

Silencers

The baffles of the silencer section are constructed of natural galvanized steel sheet, with a peak at the air inlet end to decrease the head loss. The baffles are also filled with a sound-insulating material composed of fibreglass with an appropriate density. This material is also heat-resistant and its outer face is protected against air erosion.

There are two options:

- **PA.** The sound insulation is protected against erosion due to air flow by a flame-retardant protective layer.

This is the most common approach in ventilation and air conditioning systems.

- **PAM.** Similar to PA, but with an additional polyester-film coating (Melinex).

Used for applications with acidic, alkaline or oily gases, as it can be steam-cleaned.

Recommended for hospitals, since bacterial colony formation is not possible.

These two models can be constructed with four lengths of baffle.

Humidifier

Two different types of air humidifiers can be installed in BA air handling units. In both cases, the units are adiabatic humidifiers.



Panel humidifier

Composed of a standardised enclosure, including a stainless steel drip pan at the bottom.

The enclosure houses the humidifier panel, which has crosswise corrugated channels to ensure minimum air resistance as well as a large contact surface between the air and water, thereby releasing moisture into the circulating air.

The top of the panel contains a water manifold, to which the water is pumped through the pipework from the drip pan by means of a small submersible electrical pump.

Water is distributed vertically downwards by gravity, coating the entire inner panel surface with an extremely fine film. As the air flows by the panel horizontally through the spaces provided, turbulent flow conditions are established, thereby resulting in efficient transfer of heat and moisture.

Air scrubber, composed of an enclosure with a large drip pan at the bottom. The tray contains enough water to create steady state conditions in the scrubber system and is equipped with hoses to connect the circulating pump (supplied when requested by the client) and water supply, drain and overflow fittings.

The water travels through a distribution branch with spray nozzles. Two distribution branches may be used to increase the efficiency of the humidifier.

A drop separator with blades designed to hold drops in the air is installed on the air outlet side, ensuring that no drops are carried to other sections.

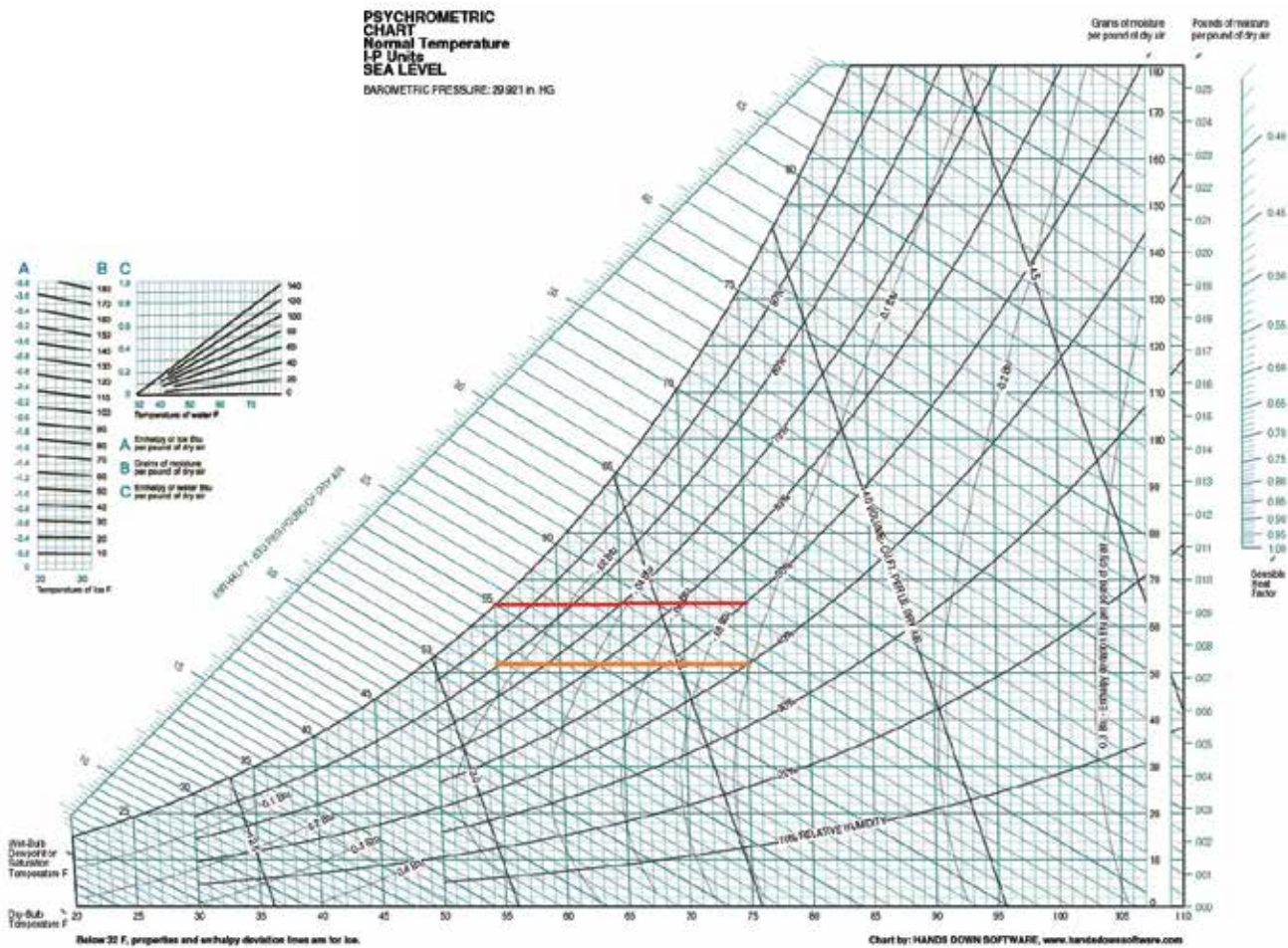
Air cooler application

The above example shows that this type of panel may be used as a cooling medium, since its behaviour is typical of an adiabatic cooling or constant enthalpy process.

Based on the above data, when heat dissipation of 200,000, kcal/h is needed in a space where the inside temperature should be maintained at no more than 29°C, it is possible to calculate the air flow that should be introduced and therefore also removed from the local.

The air flow required will be:

$$\frac{200}{(29^{\circ}\text{C} - 24^{\circ}\text{C}) \times 0,3} = 133.333 \text{ m}^3/\text{h}$$



In order to calculate the humidifier’s efficiency, use the following formula to determine the saturation efficiency (SE):

$$SE = \frac{T_{se} - T_{ss}}{T_{se} - T_h} \times 100$$

Where:

- T_{se} = dry bulb temperature of inlet air.
- T_{ss} = dry bulb temperature of outlet air.
- T_h = wet-bulb temperature of air.

Based on the psychrometric chart (a diagram is shown on this page), air with inlet conditions of 38° C (T_{se}) and 21° C (T_h) is converted in the humidifier finding the process at the wet-bulb line of 21° C until reaching an outlet temperature of 24° C (T_{ss}).

The saturation efficiency will be:

$$SE = \frac{38 - 24}{38 - 21} \times 100 = 82,3\%$$

This percentage is reasonable, since the maximum level that can be expected from this type of humidifier is 90%, as shown in actual practice.

When this example is applied to a specific case in which an air flow of 30000 m³/h, is circulating and the moisture content of the air at the inlet (x_e) is 8.6 g/kg and at the output (x_s) is 14.4 g/kg, **then the amount of moisture added is:**

$$\frac{30.000 \times 1,2 \times (14,4 - 8,6)}{1.000} = 208,8 \text{ kg of water/ hour}$$

Control System

BA AHU is available with preinstalled, preconfigured & fully integrated control system. It is a user friendly system where functions & parameters can be selected from the inbuilt Human machine interface (HMI) of the controller or through building management system. The operating data, set points, alarms, operating status & time settings are displayed on the controller. The control system is preloaded with design temperature, relative humidity, pressure drops etc., time settings & control sequence which simplifies field commissioning. The set points can be modified in the field if required. The control system is capable of performing various function such as

- Temperature control for supply air or room conditions.
- Relative humidity control
- Dew point control
- Constant air volume control for supply air
- Enthalpy control
- Excessive pressure drop alarm
- Heat recovery control
- Run around coil heat exchanger control
- Electric heater control
- Cooling/heating coil water flow control
- Integration of DX coil with outdoor condensing unit
- Fresh/return/bypass/mixing/supply air damper control
- Redundancy control for EC fans
- AHU shut off from external fire signal
- Open protocol (BACnet/Modbus over RS 485/LON) to communicate with all Building Management Systems.
- Possibility to access the control system remotely through WEB
- Possibility to add additional control/alarm points as per customer's need
- Logging of various parameters
- VAV integration



Selection Tools

We have developed this overview to make it easier for you to get an idea of which product best suits your specific needs. More detailed analysis or planning usually requires additional information, which is where the following tools come in.



Software Program

BA Selection Program named **SystemairBAAHU is tested & certified by EUROVENT.**

- customers can choose various construction/ manufacturing options viz. sheet thickness, insulating materials, fin material, manifolds material etc.
- customers can design unit sections based on required application viz. mixing section, filtration level, recovery section, cooling / heating section & choose fan/ motor of their choice.
- it actually lets customers decide sectional possibilities in order to decide the dimensions of space required to place a unit.
- Divide the equipment into modules, in accordance with the project requirements;
- Obtain all technical information for the equipment selected, including the curves for the selected fan and its operating point;
- Estimate the cost of the equipment.

The BA Selection Program is user-friendly and highly intuitive.



Product catalogue and specification data

More detailed technical information, sufficient to carry out complete planning, is available in separate catalogues and specification data. These describe all incorporated functions, available accessories, and additional technical data.



Quick Selection

IMPORTANT INFORMATION

1. These fast selection criteria are included to help the user choose the equipment for the design specifications. Nevertheless, this selection method is not precise enough to indicate the equipment that best fits your requirements. If more precise information is necessary, please use our computer-aided selection program or our Sales Department can be contacted.
2. The following formula must be used to determine the air velocity (m/s):

$$\text{Air velocity} = \frac{\text{Flow rate m}^3/\text{s}}{\text{Afo m}^2} = \text{m/s}$$

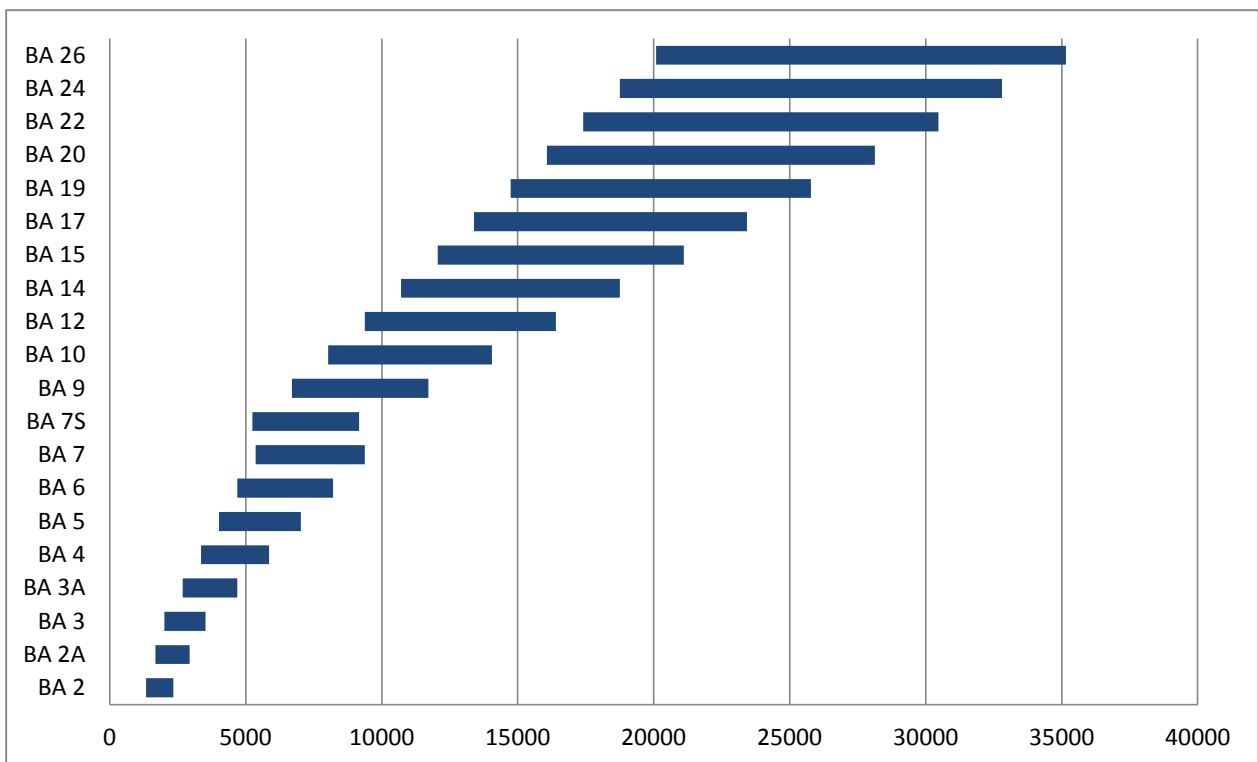
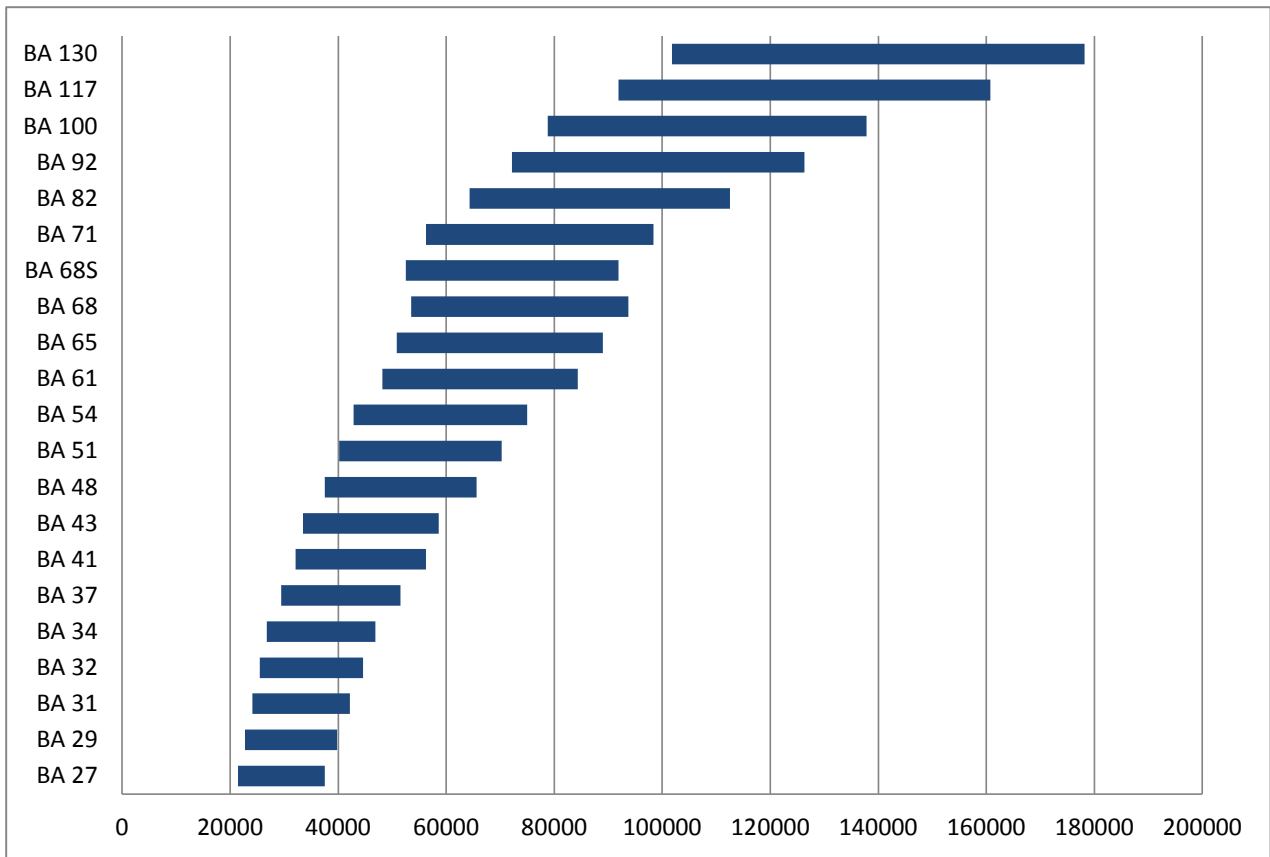
3. The data used to determine the number of rows of the units are based on the following values:

Cooling:	inlet air	26,4°C, 48,4% RH.
	outlet air	13,0°C, 92,0% RH.
Heating:	inlet air	18,0°C
	outlet air	30,0°C.

4. The fan features refer to operation in facilities with free inlet and ducted supply outlet, and do not take into account any air flow fittings.
5. The absolute fan power consumption does not include losses attributable to the drive.



Air Handling Unit Selection (BA)



SELECTION DIAGRAM Air flow rate, in m³/h.

Selection in a sample project

Horizontal air handling unit, composed of the following sections:

- Air mixture.
- Extended surface filters.
- Cooling unit based on chilled water.
- Hot-water heating unit.
- Low-pressure fan section.

Technical data:

- Air flow rate: 19,200 m³/h;
- External static pressure: 45 mm w.g.;
- Cooling power: 107 kw;
- Chilled water temperature: 7°C;
- Temp. difference of chilled water: 5°C;
- Conditions of inlet air: 26.4°C BS, 48.4% RH;
- Conditions of outlet air: 14°C BS, 86.2% RH;
- Temperature rise of motor: approx. 1°C;
- Heating power: 196 kw;
- Hot water temperature: 85°C;
- Temp. difference of heated water: 15°C;
- Conditions of inlet air: 18.0°C BS;
- Conditions of outlet air: 26.4°C BS.

BA Air Handling Unit Selection

Using the quick selection table, the appropriate model for a flow rate of air of 19,200 m³/h and an air velocity of 2.7 m/s is the

BA-20 with a cross sectional area (afo) of 2.22 m².

Step 1:

To determine the air velocity through the unit:

First, divide the flow rate of air expressed in m³/h by 3600 seconds to obtain the flow rate of air in m³/s:

$$19.200 / 3.600 = 5,33 \text{ m}^3/\text{s}$$

Divide this flow rate, in m³/s, by the afo for the BA-20 air handling unit, in m², to obtain the air velocity in m/s:

$$\text{Air velocity through heating/cooling unit} = 5,33 / 2,22 = \mathbf{2,4 \text{ m/s}}$$

Step 2:

To determine the number of rows and depth of each cooling and heating unit, with an air velocity of 2.4 m/s:

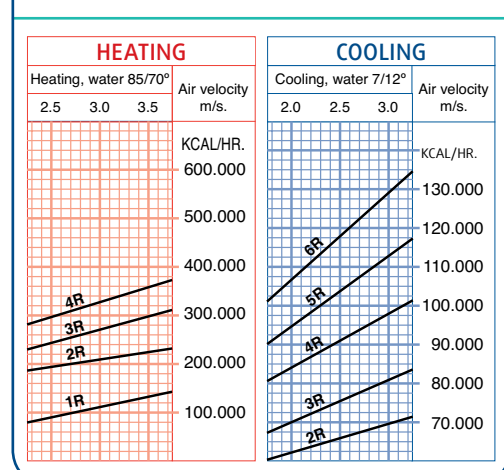
$$\text{Cooling, water at 7-12°C, 99100 -kcal/h} = \mathbf{4R}$$

$$\text{Heating, water 85/70°C, 69120 kcal/h} = \mathbf{1R}$$

Pressure drops in mm w.g.						
Section	Air velocity, m/s					
	2.50	2.75	3.00	3.25	3.50	
E	2	2	3	3	4	
M	2	2	3	3	4	
FC	2	2	3	3	4	
F	9	11	13	15	18	
FB	19	23	27			
FA	56	58	60			
S-234 (700 mm)	2	2	3	3	4	
S-334 (1050 mm)	2	3	3	4	5	
S-434 (1400 mm)	3	3	4	4	5	
S-534 (1750 mm)	3	4	4	5	6	
HP	11	13	15	NOTUSED		
HL	8	9	10			
BF 2R	5	6				
BF 3R	7	8				
BF 4R	9	10				
BF 5R	10	12				
BF 6R	12	14				
BC 1R	3	3	4	4	5	
BC 2R	4	5	6	7	7	
BC 3R	6	7	8	9	10	
BC 4R	7	8	9	11	12	

Code	Section
E	Air inlet
M	Air mixture
FC	Free Cooling
F	Extended surface filters
FB	Bag filters
FA	Absolute filters
BF	Cooling unit
BC	Heating unit
A	Access
HP	Panel humidifier
HL	Air scrubber humidifier
V	Fan
S	Silencer

Determination of the number of rows in the unit



Step 3:

Determine the static pressure of the air handling unit by adding the various pressure drops for the unit for an air velocity of 2.4 m/s:

• Air mixing section (M)	30 pa
• Extended surface filter section (F)	72 pa
• Heating unit (BC) 2R	35 pa
• Cooling unit (BF) 4R	85 pa

Total sum for the air handling unit	24 mm w.g.
• Available static pressure	45 mm w.g.

Total static pressure 69 mm w.g.

Step 4:

Determine the operating conditions of the fan, in this case for low speed, 560 model, on the respective curves: The pressures indicated on the curves are “total pressures”. Therefore, the dynamic pressure (Pd) for 19,200 m³/h of air flow must be added to the static pressure obtained earlier:

Total pressure (Pd + Pe) = 6.6 mm + 69 mm = 76.28 mm w.g.

Total pressure (Pt) 76.28 mm w.g. = 76.28 x 9,80665 = 740 Pa

The following values are obtained from the intersection of the air flowrate and total pressure:

- Revolutions: 776 r.p.m.
- Input power: 6.2 kw
- Sound power: 87 dB
- Efficiency: 64 %
- Air outlet velocity: 10.4 m/s

SECTION WEIGHTS			
Sections	Kg	Sections	Kg
E	26	HP	100
M	33	HL	190
FC	56	V (w/o motor)	53
F	22	BF 2R	46
FB	40	BF 3R	51
FA	55	BF 4R	55
A (Each 175-mm clear)	11	BF 5R	59
S-234 (700 mm)	32	BF 6R	63
S-334 (1050 mm)	37	BC 1R	29
S-434 (1400 mm)	42	BC 2R	33
S-534 (1750 mm)	47	BC 3R	38
		BC 4R	42
Bedplate - weight per metre			16

MOTOR WEIGHTS			
Power (HP)	Kg	Power (HP)	Kg
0,33	5	1,5	16
0,5	5	2	16
0,75	9	3	30
1	9		

The input power can then be used to calculate the motor output:

Motor output = 6.0 kw. x 1.2 = 7.5 kw (10HP)

Step 5:

Determine the dimensions and weight of the air handling unit:

Section	Dimensions	Weights
M	550 mm	104 kg
F	0 mm	8 kg
BC (2 R)	175 mm	60 kg
BF (4 R)	580 mm	215 kg
V	1215 mm	382 kg

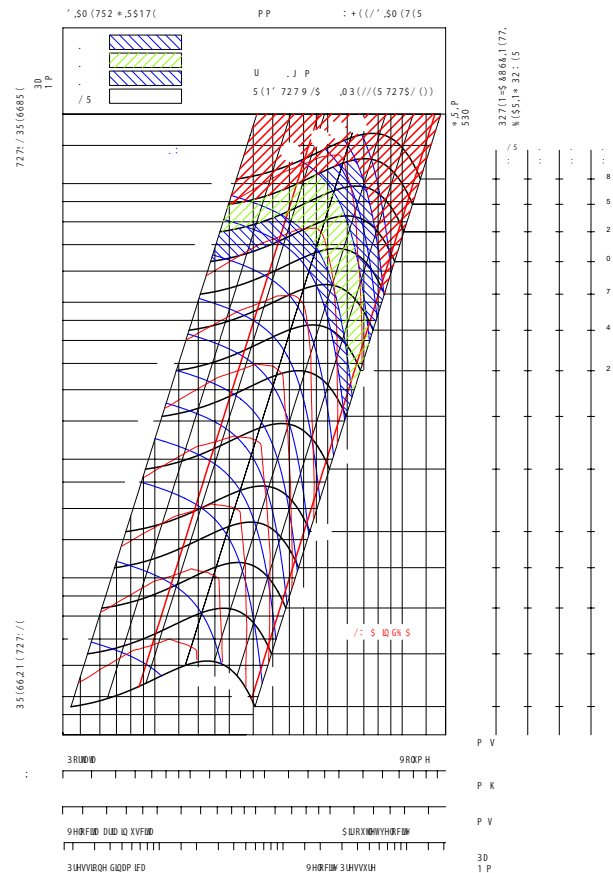
TOTAL 2478 mm 769 kg

The air handling unit will have the following dimensions and weight:

- Length 2478 mm**
- Width 2154 mm**
- Height 1542 mm**
- Weight 746 kg**

The air outlet mouth air are 715 x 715 mm.

The air inlets are 505 x 415 and 858 x 815 mm.





Reference: Airport "CIAL", Cochin, India

Cochin International airport is a mega HVAC project, designed as a 2 level terminal with arrival at ground level and departure on first level. Having provision for 112 check-in counters, 100 immigration counters, 19 boarding gates, 15 aerobridges, capable to handle 15 aircrafts during peak operation


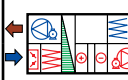
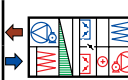
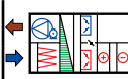
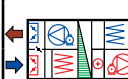
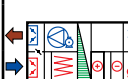
Products/Solution:

- Modular AHU with heat recovery wheel
- Air Distribution Products
- Fire Safety Products
- Fans
- Air Curtains

Unit dimensions with centrifugal fans

In order to facilitate the work of designing an air handling unit based on the numerous options available, we have provided specifications for the most common unit combinations. These examples should help to speed up the process of designing your preferred unit with the right functions. Choose the unit version that best matches your preferences.

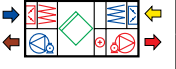
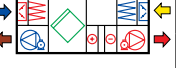

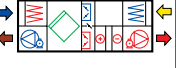

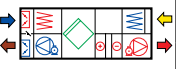
➡ = outdoor air ➡ = supply air ➡ = extract air ➡ = exhaust air

ROTATING HEAT EXCHANGER			SIZE																		
Unit Type/ Nomenclature	Panel Thickness	Dim.	2	2A	3	3A	4	5	6	7S	7	9	10	12	14	15	17	19	20	22	24
Panel 25		width	874	915	958	1004	1128	1229	1281	-	1430	1430	1559	1625	1625	1765	1846	2000	2154	2405	2405
		height	1246	1550	1550	1850	1850	1850	1880	-	1880	2358	2358	2668	2968	2984	2984	2984	2984	2984	3348
Panel 50		width	874	915	958	1004	1128	1229	1281	-	1430	1430	1559	1625	1625	1765	1846	2000	2154	2405	2405
		height	1246	1550	1550	1850	1850	1850	1880	-	1880	2358	2358	2668	2968	2984	2984	2984	2984	2984	3348
C1V 	25	Length	2805	2805	2805	2980	2980	2980	2980	-	2980	2980	3330	3330	3330	3330	3565	3740	3740	3740	3740
		Weight	394	435	454	565	607	641	668	-	727	824	1049	1178	1312	1392	1592	1748	1837	2045	2080
	50	Length	2865	2865	2865	2865	2865	2865	3040	-	3040	3040	3215	3390	3565	3390	3565	3565	3740	3740	3740
		Weight	409	453	468	573	616	647	742	-	806	964	1069	1221	1423	1442	1643	1732	1895	2113	2148
C2V 	25	Length	3330	3330	3330	3330	3330	3505	3505	-	3505	3505	3680	3855	3855	3855	4090	4090	4265	4265	4265
		Weight	426	476	489	561	605	696	728	-	799	907	1116	1274	1417	1567	1713	1809	1977	2203	2243
	50	Length	3390	3390	3390	3390	3390	3565	3565	-	3565	3565	3740	3915	3915	3915	4090	4090	4265	4265	4265
		Weight	442	495	509	584	629	725	757	-	875	1032	1157	1321	1468	1621	1768	1867	2040	2277	2317
C3V 	25	Length	3330	3330	3330	3680	3680	3680	3680	-	3680	3680	3855	4030	4030	4030	4265	4265	4440	4440	4440
		Weight	422	468	487	598	659	700	752	-	816	916	1076	1226	1329	1444	1645	1717	1895	2109	2144
	50	Length	3390	3390	3390	3740	3740	3740	3740	-	3740	3740	3915	4090	4090	4090	4265	4265	4440	4440	4440
		Weight	439	487	507	623	686	741	781	-	848	953	1116	1272	1378	1497	1699	1774	1957	2181	2216
C4V 	25	Length	3855	3855	3855	4030	4030	4205	4205	-	4205	4205	4205	4555	4555	4555	4790	4615	4965	4965	4965
		Weight	454	509	522	594	657	755	812	-	888	999	1143	1322	1434	1619	1766	1778	2035	2267	2307
	50	Length	3915	3915	3915	4265	4265	4440	4265	-	4265	4265	4440	4615	4440	4615	4790	4790	4965	4965	4965
		Weight	472	529	548	634	699	819	796	-	917	1021	1204	1372	1423	1676	1824	1909	2102	2345	2385
C5V 	25	Length	3330	3330	3330	3680	3680	3680	3680	-	3680	3680	3855	4030	4030	4030	4265	4265	4440	4440	4440
		Weight	436	482	502	615	677	718	770	-	836	938	1098	1250	1341	1518	1659	1731	1910	2125	2160
	50	Length	3390	3390	3390	3740	3740	3740	3740	-	3740	3740	3915	4090	4090	4090	4265	4265	4440	4440	4440
		Weight	453	503	523	640	704	747	801	-	869	976	1140	1298	1392	1511	1714	1789	1972	2198	2233
C6V 	25	Length	3855	3855	3855	4030	4030	4205	4205	-	4205	4205	4205	4555	4555	4555	4790	4615	4965	4965	4965
		Weight	468	523	537	611	675	773	830	-	908	1021	1165	1346	1446	1693	1780	1792	2050	2283	2323
	50	Length	3915	3915	3915	4265	4265	4440	4265	-	4265	4265	4440	4615	4440	4615	4790	4790	4965	4965	4965
		Weight	486	545	564	651	717	825	816	-	938	1044	1228	1398	1437	1690	1839	1924	2117	2362	2402

Dimensions in mm. Weight in kgs.

ROTATING HEAT EXCHANGER											SIZE												
Panel Thickness	Dim.	26	27	29	31	32	34	37	41	43	48	51	54	61	65	68S	68	71	82	92	100	117	130
	width	2259	2335.5	2412	2412	2710	2744	2710	2770	2710	2822	2850	2822	3078	3232	-	3386	3685	-	-	-	-	-
	height	3630	3653	3676	4250	3676	3676	4060	4250	4910	4910	5220	5520	5520	5520	-	5520	5520	-	-	-	-	-
	width	2259	2335.5	2412	2412	2710	2744	2710	2770	2710	2822	2850	2822	3078	3232	-	3386	3685	-	-	-	-	-
	height	3630	3653	3676	4250	3676	3676	4060	4250	4910	4910	5220	5520	5520	5520	-	5520	5520	-	-	-	-	-
25	Length	3740	3740	3740	4265	4265	4265	4500	4675	5025	5025	5375	5375	5375	5550	-	5550	5550	-	-	-	-	-
	Weight	2165	2252	2339	2985	3030	3061	3301	3507	4028	4144	4622	4887	5278	5437	-	5604	6392	-	-	-	-	-
50	Length	3740	3740	3740	4265	4265	4265	4500	4675	4675	5025	5375	5375	5375	5550	-	5550	5550	-	-	-	-	-
	Weight	2233	2323	2413	3073	3090	3149	3317	3609	3786	4263	4755	5024	5335	5626	-	6261	6579	-	-	-	-	-
25	Length	4265	4265	4265	4790	4790	4790	5200	5375	5375	5725	5900	5900	5900	6075	-	6075	6250	-	-	-	-	-
	Weight	2334	2429	2524	3185	3206	3271	3467	3768	3953	4442	4835	5037	5283	5696	-	5953	6717	-	-	-	-	-
50	Length	4265	4265	4265	4790	4790	4790	5200	5375	5550	5725	5900	5900	5900	6075	-	6250	6250	-	-	-	-	-
	Weight	2408	2506	2604	3280	3301	3366	3571	3879	4305	4570	4972	5178	5433	5855	-	6577	6894	-	-	-	-	-
25	Length	4440	4440	4440	4965	4965	5140	5200	5375	5375	6075	6075	6075	6075	6250	-	6250	6250	-	-	-	-	-
	Weight	2229	2317.5	2406	3056	3073	3173	3296	3583	3755	4574	4706	4973	5200	5626	-	5926	6491	-	-	-	-	-
50	Length	4440	4440	4440	4965	4965	5140	5200	5375	5725	6075	6075	6075	6075	6250	-	6250	6250	-	-	-	-	-
	Weight	2302	2393	2484	3149	3165	3267	3396	3690	4156	4705	4919	5116	5352	5787	-	6092	6669	-	-	-	-	-
25	Length	4965	4965	4965	5490	5490	5665	5900	6075	5725	6775	6600	6600	6600	6775	-	6775	6950	-	-	-	-	-
	Weight	2398	2494.5	2591	3256	3249	3383	3462	3844	3680	4872	4919	5123	5205	5885	-	6275	6816	-	-	-	-	-
50	Length	4965	4965	4965	5490	5490	5665	5900	6075	6600	6775	6600	6600	6600	6775	-	6950	6950	-	-	-	-	-
	Weight	2477	2576	2675	3356	3376	3484	3650	3960	4675	5012	5136	5270	5450	6016	-	6408	6984	-	-	-	-	-
25	Length	4440	4440	4440	4965	4965	5140	5200	5375	5375	6075	6075	6075	6075	6250	-	6250	6250	-	-	-	-	-
	Weight	2245	2325.5	2406	3056	3101	3173	3296	3559	3755	4574	4781	4973	5200	5626	-	5926	6491	-	-	-	-	-
50	Length	4440	4440	4440	4965	4965	5140	5200	5375	5375	6075	6075	6075	6075	6250	-	6250	6250	-	-	-	-	-
	Weight	2319	2401.5	2484	3149	3165	3267	3396	3666	3871	4705	4919	5116	5352	5787	-	6092	6669	-	-	-	-	-
25	Length	4965	4965	4965	5490	5490	5665	5900	6075	5725	6775	6600	6600	6600	6775	-	6775	6950	-	-	-	-	-
	Weight	2414	2502.5	2591	3256	3277	3383	3462	3820	3680	4872	4994	5123	5205	5885	-	6275	6816	-	-	-	-	-
50	Length	4965	4965	4965	5490	5490	5665	5900	6075	6250	6775	6600	6600	6600	6775	-	6950	6950	-	-	-	-	-
	Weight	2494	2584.5	2675	3356	3376	3484	3650	3936	4390	5012	5136	5270	5450	6016	-	6408	6984	-	-	-	-	-

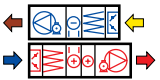

Dimensions in mm. Weight in kgs.

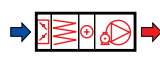

PLATE HEAT EXCHANGER			SIZE																			
Unit Type/ Nomenclature	Panel Thickness	Dim.	2	2A	3	3A	4	5	6	7S	7	9	10	12	14	15	17	19	20	22	24	26
Panel 25		width	874	915	958	1004	1128	1229	1281	-	1430	1430	1559	1625	1625	1765	1846	2000	2154	2405	2405	2259
		height	1246	1550	1550	1850	1850	1850	1880	-	1880	2358	2358	2668	2968	2984	2984	2984	2984	2984	3348	3348
Panel 50		width	874	915	958	1004	1128	1229	1281	-	1430	1430	1559	1625	1625	1765	1846	2000	2154	2405	2405	2259
		height	1246	1550	1550	1850	1850	1850	1880	-	1880	2358	2358	2668	2968	2984	2984	2984	2984	2984	3348	3348
Q1V 	25	Length	3330	3330	3330	3330	3330	3330	3330	-	3330	3505	3680	4380	4380	4555	4615	4790	4790	4790	4790	4790
		Weight	395	457	491	562	612	666	706	-	765	888	979	1293	1403	1525	1571	1738	1817	2021	2038	2065
	50	Length	3390	3390	3390	3390	3390	3390	3390	-	3390	3565	3740	4440	4615	4965	5140	5140	4790	4790	4965	4965
		Weight	413	477	513	586	639	695	736	-	797	925	1006	1343	1503	1719	1781	1961	1964	2207	2299	2277
Q2V 	25	Length	3855	3855	3855	3680	3680	3855	3855	-	3855	4030	4030	4905	4905	5080	5140	5140	5315	5315	5315	5315
		Weight	427	498	526	558	610	721	766	-	837	971	1046	1389	1508	1700	1692	1799	1957	2179	2201	2234
	50	Length	3915	3915	3915	3915	3915	4090	3915	-	3915	4090	4265	4965	4965	5490	5665	5665	5315	5315	5490	5490
		Weight	446	519	554	597	652	773	751	-	866	993	1094	1443	1548	1898	1906	2096	2109	2371	2468	2452
Q3V 	25	Length	3680	3680	4030	4030	4030	4030	4030	-	4205	4205	4380	5080	5255	5430	5840	5840	5840	5490	5490	5840
		Weight	395	462	487	552	601	654	693	-	780	880	971	1282	1437	1561	1687	1842	1976	2141	2145	2290
	50	Length	3740	3740	4090	4090	4090	4090	4090	-	4090	4265	4440	5140	5490	5490	5840	5840	5490	5490	5490	5665
		Weight	413	482	505	577	637	687	723	-	782	918	998	1333	1513	1621	1751	1928	1928	2155	2215	2290
Q4V 	25	Length	4205	4205	4555	4380	4380	4555	4555	-	4730	4730	4730	5605	5780	5955	6365	6190	6365	6015	6015	6365
		Weight	427	503	522	548	599	709	753	-	852	963	1038	1378	1542	1736	1808	1903	2116	2299	2308	2459
	50	Length	4265	4265	4615	4615	4615	4790	4615	-	4615	4790	4965	5665	5840	6015	6365	6365	6015	6015	6015	6190
		Weight	446	524	546	588	650	765	738	-	851	986	1086	1433	1558	1800	1876	2063	2073	2319	2384	2465
Q5V 	25	Length	3680	3680	4030	4030	4030	4030	4030	-	4030	4205	4380	5080	5255	5605	5840	5840	5840	5490	5490	5665
		Weight	383	442	483	552	610	659	693	-	750	880	971	1282	1437	1595	1687	1861	1976	2084	2137	2210
	50	Length	3740	3740	4090	4090	4090	4090	4090	-	4090	4265	4440	5140	5315	5490	5490	5490	5840	5490	5490	5665
		Weight	400	462	505	577	628	683	723	-	782	918	998	1315	1493	1625	1752	1928	2047	2163	2215	2290
Q6V 	25	Length	4205	4205	4555	4380	4380	4555	4555	-	4555	4730	4730	5605	5780	6130	6365	6190	6365	6015	6015	6190
		Weight	415	483	518	548	608	714	753	-	822	963	1038	1378	1542	1770	1808	1922	2116	2242	2300	2379
	50	Length	4265	4265	4615	4615	4615	4790	4615	-	4615	4790	4965	5665	5665	6015	6015	6015	6365	6015	6015	6190
		Weight	433	504	546	588	641	761	738	-	851	986	1086	1415	1538	1804	1877	2063	2192	2327	2384	2465

Dimensions in mm. Weight in kgs.

PLATE HEAT EXCHANGER											SIZE												
Panel Thickness	Dim.	27	29	31	32	34	37	41	43	48	51	54	61	65	68S	68	71	82	92	100	117	130	
25	width	2335.5	2412	2412	2710	2744	2710	2770	2710	2822	2850	2822	3078	3232	-	3386	3685	-	-	-	-	-	-
	height	3653	3676	4250	3676	3676	4060	4250	4910	4910	5220	5520	5520	5520	-	5520	5520	-	-	-	-	-	-
50	width	2335.5	2412	2412	2710	2744	2710	2770	2710	2822	2850	2822	3078	3232	-	3386	3685	-	-	-	-	-	-
	height	3653	3676	4250	3676	3676	4060	4250	4910	4910	5220	5520	5520	5520	-	5520	5520	-	-	-	-	-	-
25	Length	4965	5140	5665	5315	5840	6425	7475	7475	7475	7475	7475	8175	8350	-	8525	8525	-	-	-	-	-	-
	Weight	2279.5	2494	2799	2705	3068	3607	4076	4352	4489	4833	4975	5631	6268	-	6246	6622	-	-	-	-	-	-
50	Length	5052.5	5140	5665	5840	7065	6425	7475	6425	7475	7475	7475	7650	8350	-	8525	8525	-	-	-	-	-	-
	Weight	2430.5	2584	2899	3131	3553	3722	4200	4080	4628	5084	5242	5569	6458	-	6444	6833	-	-	-	-	-	-
25	Length	5490	5665	6190	5840	6365	7125	8175	7825	8175	8000	8000	8700	8875	-	9050	9225	-	-	-	-	-	-
	Weight	2456.5	2679	2999	2881	3278	3773	4337	4277	4787	5046	5125	5636	6527	-	6595	6947	-	-	-	-	-	-
50	Length	5577.5	5665	6190	6365	7590	7125	8175	7300	8175	8000	8000	8175	8875	-	9225	9225	-	-	-	-	-	-
	Weight	2613.5	2775	3106	3342	3770	3976	4470	4599	4935	5301	5396	5667	6687	-	6760	7148	-	-	-	-	-	-
25	Length	6015	6190	6365	6540	6540	6775	8175	8175	8175	8175	8175	8875	9050	-	9225	9225	-	-	-	-	-	-
	Weight	2394.5	2499	2742	2941	3014	3260	4066	4289	4489	4843	4975	5631	6003	-	6260	6622	-	-	-	-	-	-
50	Length	5752.5	5840	6365	6540	6540	6775	8175	8175	8875	8175	8175	8875	9050	-	9225	9225	-	-	-	-	-	-
	Weight	2404	2518	2899	3131	3170	3368	4200	4497	4930	4990	5232	5814	6458	-	6444	6833	-	-	-	-	-	-
25	Length	6540	6715	6890	7065	7065	7475	8875	8525	8875	8700	8700	9400	9575	-	9750	9925	-	-	-	-	-	-
	Weight	2571.5	2684	2942	3117	3224	3426	4327	4214	4787	5056	5125	5636	6262	-	6609	6947	-	-	-	-	-	-
50	Length	6277.5	6365	6890	7065	7065	7475	8875	9050	9575	8700	8700	9400	9575	-	9925	9925	-	-	-	-	-	-
	Weight	2587	2709	3106	3342	3387	3622	4470	5016	5237	5207	5386	5912	6687	-	6760	7148	-	-	-	-	-	-
25	Length	5752.5	5840	6365	6540	7765	7125	8175	8175	8175	8175	8175	8875	9050	-	9225	9225	-	-	-	-	-	-
	Weight	2321	2432	2799	3030	3437	3607	4066	4352	4489	4833	4975	5631	6268	-	6246	6622	-	-	-	-	-	-
50	Length	5752.5	5840	6365	6015	6540	6775	8175	8175	8175	8175	8175	8875	9050	-	9225	9225	-	-	-	-	-	-
	Weight	2404	2518	2899	2800	3170	3368	4210	4497	4638	4990	5137	5814	6458	-	6444	6833	-	-	-	-	-	-
25	Length	6277.5	6365	6890	7065	8290	7825	8875	8525	8875	8700	8700	9400	9575	-	9750	9925	-	-	-	-	-	-
	Weight	2498	2617	2999	3206	3647	3773	4327	4277	4787	5046	5125	5636	6527	-	6595	6947	-	-	-	-	-	-
50	Length	6277.5	6365	6890	6540	7065	7475	8875	9050	8875	8700	8700	9400	9575	-	9925	9925	-	-	-	-	-	-
		2587	2709	3106	3011	3387	3622	4480	5016	4945	5207	5291	5912	6687	-	6760	7148	-	-	-	-	-	-

Dimensions in mm. Weight in kgs.

LIQUID-COUPLED HEAT EXCHANGERS																			SIZE									
Unit Type/ Nomenclature	Panel Thickness	Dim.	2	2A	3	3A	4	5	6	7S	7	9	10	12	14	15	17	19	20	22	24	26						
Panel 25	width		874	915	958	1004	1128	1229	1281	1575	1430	1430	1559	1625	1625	1765	1846	2000	2154	2405	2405	2259						
	height		1346	1650	1650	1950	1950	1950	1980	1780	1980	2458	2458	2768	3068	3084	3084	3084	3084	3448	3448	3730						
Panel 50	width		874	915	958	1004	1128	1229	1281	1575	1430	1430	1559	1625	1625	1765	1846	2000	2154	2405	2405	2259						
	height		1346	1650	1650	1950	1950	1950	1980	1780	1271	2458	2458	2768	3068	3084	3084	3084	3084	3448	3448	3730						
R1V 	25	Length	2685	2685	2860	2860	2860	2860	2860	2860	3035	3035	3035	3035	3385	3385	3405	3405	3405	3405	3405	3580						
		Weight	324	377	419	487	543	591	639	594	730	839	929	1050	1241	1325	1437	1571	1656	1836	1929	2014						
	50	Length	2705	2705	2880	2880	2880	2880	2880	2880	3055	3055	3055	3055	3405	3405	3405	3405	3405	3405	3405	3405	3580					
		Weight	337	393	437	510	565	614	663	623	758	870	963	1087	1283	1370	1482	1619	1707	1896	1990	2076						
R2V 	25	Length	3210	3210	3385	3385	3385	3385	3385	3385	3385	3560	3560	3560	3735	3910	3930	3930	3930	3930	3930	4280						
		Weight	359	416	462	533	594	647	701	653	792	916	1015	1146	1337	1474	1559	1703	1814	2013	2094	2223						
	50	Length	3230	3230	3405	3405	3405	3405	3405	3405	3405	3405	3580	3580	3580	3755	3930	3930	3930	3930	3930	3930	3930					
		Weight	374	433	482	558	622	678	727	685	822	950	1051	1187	1382	1523	1608	1756	1870	2079	2161	2212						

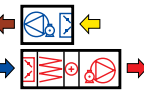
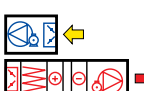
SUPPLY AIR UNITS			SIZE																				
Unit Type/ Nomenclature	Panel Thickness	Dim.	2	2A	3	3A	4	5	6	7S	7	9	10	12	14	15	17	19	20	22	24	26	
Panel 25	width		874	915	958	1004	1128	1229	1281	1575	1430	1430	1559	1625	1625	1765	1846	2000	2154	2405	2405	2259	
	height		673	825	825	975	975	975	990	890	990	1229	1229	1384	1534	1542	1542	1542	1542	1724	1724	1865	
Panel 50	width		874	915	958	1004	1128	1229	1281	1575	1430	1430	1559	1625	1625	1765	1846	2000	2154	2405	2405	2259	
	height		673	825	825	975	975	975	990	890	281	1229	1229	1384	1534	1542	1542	1542	1542	1724	1724	1865	
S1V 	25	Length	2685	2685	2860	2860	2860	2860	2860	2860	3035	3035	3035	3035	3385	3385	3405	3405	3405	3405	3405	3405	3580
		Weight	146	170	190	219	244	266	290	266	332	381	421	477	568	605	650	720	758	839	894	914	
	50	Length	2705	2705	2880	2880	2880	2880	2880	2880	3055	3055	3055	3055	3405	3405	3405	3405	3405	3405	3405	3405	3580
		Weight	152	177	198	231	258	276	300	281	345	395	436	494	587	626	670	742	781	866	922	942	
S2V 	25	Length	2685	2685	2860	2860	2860	2860	2860	2860	3035	3035	3035	3035	3385	3385	3405	3405	3405	3405	3405	3405	3580
		Weight	178	207	229	268	299	325	349	328	398	458	508	573	673	720	787	851	898	997	1035	1100	
	50	Length	2705	2705	2880	2880	2880	2880	2880	2880	3055	3055	3055	3055	3405	3405	3405	3405	3405	3405	3405	3405	3580
		Weight	185	216	239	279	307	338	363	342	413	475	527	593	696	744	812	877	926	1030	1068	1134	

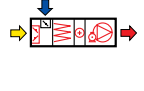
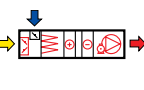

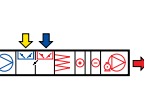
Dimensions in mm. Weight in kgs.

		LIQUID-COUPLED HEAT EXCHANGERS																	SIZE					
Panel Thickness	Dim.	27	29	31	32	34	37	41	43	48	51	54	61	65	685	68	71	82	92	100	117	130		
25	width	2335.5	2412	2412	2710	2744	2710	2770	2710	2822	2850	2822	3078	3232	5488	3386	3685	5540	5644	5700	6000	6000		
	height	3753	3776	4350	3776	3776	4160	4350	5010	5010	5320	5620	5620	5620	3776	5620	5620	4340	5010	5010	5620	6060		
50	width	2335.5	2412	2412	2710	2744	2710	2770	2710	2822	2850	2822	3078	3232	5488	3386	3685	5540	5644	5700	6000	6000		
	height	3753	3776	4350	3776	3776	4160	4350	5010	5010	5320	5620	5620	5620	3776	5620	5620	4340	5010	5010	5620	6060		
25	Length	3667.5	3755	3930	4105	4105	4125	4125	4125	4125	4125	4125	4475	4475	4125	4475	4475	4125	4125	4475	4475	4475		
	Weight	2162	2310	2776	2990	3040	3193	3362	3549	3784	4108	4374	4838	4995	4659	5317	5551	5241	5804	6531	8314	7915		
50	Length	3667.5	3755	3930	4105	4105	4125	4125	4125	4125	4125	4125	4475	4475	4125	4475	4475	4125	4125	4125	4475	4475		
	Weight	2227.5	2379	2859	3073	3124	3294	3455	3650	3888	4218	4489	4970	5131	4807	5458	5702	5416	6071	6507	8547	8154		
25	Length	4367.5	4455	4455	4630	4630	4825	4825	4825	4825	5000	5000	5000	5175	4650	5175	5175	4825	4825	4825	5000	5175		
	Weight	2368	2513	2927	3020	3076	3453	3626	3892	4147	4448	4730	5120	5360	4864	5631	5880	5728	6400	6736	8790	8511		
50	Length	4192.5	4455	4455	4455	4630	4825	4825	4825	4825	4825	5000	5175	5175	4650	5175	5175	4825	4825	4825	5000	5175		
		2400.5	2589	3016	3058	3166	3561	3790	4003	4261	4462	4857	5329	5502	5024	5778	6037	5918	6685	7000	9030	8759		

		SUPPLY AIR UNITS																	SIZE					
Panel Thickness	Dim.	27	29	31	32	34	37	41	43	48	51	54	61	65	685	68	71	82	92	100	117	130		
25	width	2335.5	2412	2412	2710	2744	2710	2770	2710	2822	2850	2822	3078	3232	5488	3386	3685	5540	5644	5700	6000	6000		
	height	1876.5	1888	2175	1888	1888	2080	2175	2505	2505	2660	2810	2810	2810	1888	2810	2810	2170	2505	2505	2810	3030		
50	width	2335.5	2412	2412	2710	2744	2710	2770	2710	2822	2850	2822	3078	3232	5488	3386	3685	5540	5644	5700	6000	6000		
	height	1876.5	1888	2175	1888	1888	2080	2175	2505	2505	2660	2810	2810	2810	1888	2810	2810	2170	2505	2505	2810	3030		
25	Length	3667.5	3755	3930	4105	4105	4125	4125	4125	4125	4125	4125	4475	4475	4125	4475	4475	4125	4125	4475	4475	4475		
	Weight	1003.5	1093	1407	1424	1446	1517	1596	1692	1838	1927	2120	2249	2319	2199	2472	2578	2473	2738	2922	4312	3627		
50	Length	3667.5	3755	3930	4105	4105	4125	4125	4125	4125	4125	4125	4475	4475	4125	4475	4475	4125	4125	4125	4475	4475		
	Weight	1033.5	1125	1448	1464	1487	1572	1641	1741	1889	1980	2177	2310	2382	2271	2537	2648	2564	2912	3075	4423	3737		
25	Length	3667.5	3755	3930	4105	4105	4125	4125	4125	4125	4125	4125	4475	4475	4125	4475	4475	4125	4125	4475	4475	4475		
	Weight	1158.5	1217	1369	1566	1594	1676	1766	1857	1946	2181	2254	2589	2676	2460	2845	2973	2768	3066	3609	4002	4288		
50	Length	3667.5	3755	3930	4105	4105	4125	4125	4125	4125	4125	4125	4475	4475	4125	4475	4475	4125	4125	4125	4475	4475		
		1194	1254	1411	1609	1637	1722	1814	1909	1999	2238	2312	2660	2749	2536	2921	3054	2852	3159	3432	4124	4417		

Dimensions in mm. Weight in kgs.

SUPPLY AIR UNITS			SIZE																				
Unit Type/ Nomenclature	Panel Thickness	Dim.	2	2A	3	3A	4	5	6	7S	7	9	10	12	14	15	17	19	20	22	24	26	
Panel 25		width	874	915	958	1004	1128	1229	1281	1575	1430	1430	1559	1625	1625	1765	1846	2000	2154	2405	2405	2259	
		height	1346	1650	1650	1950	1950	1950	1980	1780	1980	2458	2458	2768	3068	3084	3084	3084	3084	3084	3448	3448	3730
Panel 50		width	874	915	958	1004	1128	1229	1281	1575	1430	1430	1559	1625	1625	1765	1846	2000	2154	2405	2405	2259	
		height	1346	1650	1650	1950	1950	1950	1980	1780	1271	2458	2458	2768	3068	3084	3084	3084	3084	3084	3448	3448	3730
S3V 	25	Length	2685	2685	2860	2860	2860	2860	2860	2860	3035	3035	3035	3035	3385	3385	3405	3405	3405	3405	3405	3405	3580
		Weight	208	237	270	313	347	379	421	372	472	544	607	710	818	893	943	1058	1145	1300	1356	1378	
	50	Length	2705	2705	2880	2880	2880	2880	2880	2880	3055	3055	3055	3055	3405	3405	3405	3405	3405	3405	3405	3405	3580
		Weight	216	247	282	329	365	393	437	392	490	564	629	735	855	924	973	1091	1179	1341	1398	1420	
S4V 	25	Length	2685	2685	2860	2860	2860	2860	2860	2860	3035	3035	3035	3035	3385	3385	3405	3405	3405	3405	3405	3405	3580
		Weight	240	274	309	362	402	438	480	434	538	621	694	806	923	1008	1080	1189	1285	1458	1497	1564	
	50	Length	2705	2705	2880	2880	2880	2880	2880	2880	3055	3055	3055	3055	3405	3405	3405	3405	3405	3405	3405	3405	3580
			249	286	323	377	414	455	500	453	558	644	720	834	964	1042	1115	1226	1324	1505	1544	1612	

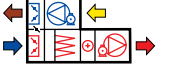
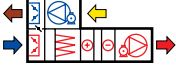
UNITS WITH MIXING SECTION			SIZE																			
Unit Type/ Nomenclature	Panel Thickness	Dim.	2	2A	3	3A	4	5	6	7S	7	9	10	12	14	15	17	19	20	22	24	26
Panel 25		width	874	915	958	1004	1128	1229	1281	1575	1430	1430	1559	1625	1625	1765	1846	2000	2154	2405	2405	2259
		height	673	825	825	975	975	975	990	890	990	1229	1229	1384	1534	1542	1542	1542	1542	1724	1724	1865
Panel 50		width	874	915	958	1004	1128	1229	1281	1575	1430	1430	1559	1625	1625	1765	1846	2000	2154	2405	2405	2259
		height	673	825	825	975	975	975	990	890	990	1229	1229	1384	1534	1542	1542	1542	1542	1724	1724	1865
M1V 	25	Length	2160	2160	2335	2335	2335	2335	2335	2335	2510	2510	2510	2510	2860	2860	2880	2880	2880	2880	3055	3055
		Weight	148	172	192	224	246	272	292	272	337	384	423	480	571	610	689	727	763	843	915	934
	50	Length	2180	2180	2355	2355	2355	2355	2355	2355	2530	2355	2530	2530	2880	2880	2880	2880	2880	2880	3055	3055
		Weight	154	180	200	233	256	282	303	284	349	380	438	496	591	631	709	748	786	870	943	962
M2V 	25	Length	2685	2685	2860	2685	2685	2860	2860	2860	3035	3035	2860	3035	3385	3385	3405	3230	3405	3405	3580	3580
		Weight	180	213	227	220	244	327	352	332	409	467	490	576	676	785	810	788	903	1001	1078	1103
	50	Length	2705	2705	2880	2880	2880	3055	2880	2880	3055	2880	3055	3055	3230	3405	3405	3405	3405	3405	3580	3580
		Weight	187	222	241	244	269	360	318	299	418	448	526	596	636	810	834	883	931	1034	1112	1137
M3V 	25	Length	3035	3035	3385	3385	3385	3385	3735	-	3735	3735	4085	4435	4785	4960	5330	5680	5680	5855	6030	6030
		Weight	218	246	283	328	366	400	455	-	459	574	657	797	884	1021	1120	1246	1343	1527	1593	1618
	50	Length	3055	3055	3405	3405	3405	3405	3755	-	3755	4105	4105	4455	5155	4980	5330	5680	5680	5855	6030	6030
		Weight	226	256	294	341	381	418	471	-	473	617	680	830	933	1056	1157	1288	1386	1579	1646	1690
M4V 	25	Length	3560	3560	3910	3735	3735	3910	4260	-	4260	4260	4435	4960	5310	5485	5855	6030	6205	6380	6555	6555
		Weight	250	287	318	324	364	455	515	-	531	657	724	893	989	1196	1241	1307	1483	1685	1756	1787
	50	Length	3580	3580	3930	3930	3930	4105	4280	-	4280	4630	4630	4980	5505	5505	5855	6205	6205	6380	6555	6555
			259	298	335	352	394	496	486	-	542	685	768	930	978	1235	1282	1423	1531	1743	1815	1865

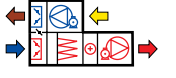

Dimensions in mm. Weight in kgs.

SUPPLY AIR UNITS																	SIZE						
Panel Thickness	Dim.	27	29	31	32	34	37	41	43	48	51	54	61	65	68S	68	71	82	92	100	117	130	
25	width	2335.5	2412	2412	2710	2744	2710	2770	2710	2822	2850	2822	3078	3232	5488	3386	3685	5540	5644	5700	6000	6000	
	height	3753	3776	4350	3776	3776	4160	4350	5010	5010	5320	5620	5620	5620	3776	5620	5620	4340	5010	5010	5620	6060	
50	width	2335.5	2412	2412	2710	2744	2710	2770	2710	2822	2850	2822	3078	3232	5488	3386	3685	5540	5644	5700	6000	6000	
	height	3753	3776	4350	3776	3776	4160	4350	5010	5010	5320	5620	5620	5620	3776	5620	5620	4340	5010	5010	5620	6060	
25	Length	3667.5	3755	3930	4105	4105	4125	4125	4125	4125	4125	4125	4475	4475	4125	4475	4475	4125	4125	4475	4475	4475	
	Weight	1561	1744	2079	2116	2142	2330	2424	2543	2770	2908	3114	3267	3363	3162	3547	3677	3573	3890	4118	5558	4930	
50	Length	3667.5	3755	3930	4105	4105	4125	4125	4125	4125	4125	4125	4475	4475	4125	4475	4475	4125	4125	4475	4475	4475	
	Weight	1605.5	1791	2137	2173	2200	2404	2489	2613	2844	2986	3196	3354	3453	3265	3640	3839	3699	4101	4309	5711	5083	
25	Length	3667.5	3755	3930	4105	4105	4125	4125	4125	4125	4125	4125	4475	4475	4125	4475	4475	4125	4125	4475	4475	4475	
	Weight	1716	1868	2041	2258	2290	2489	2594	2708	2878	3162	3248	3607	3720	3423	3920	4072	3868	4218	4805	5248	5591	
50	Length	3667.5	3755	3930	4105	4105	4125	4125	4125	4125	4125	4125	4475	4475	4125	4475	4475	4125	4125	4475	4475	4475	
		1766	1920	2100	2318	2350	2554	2662	2781	2954	3244	3331	3704	3820	3530	4024	4245	3987	4348	4666	5412	5763	

UNITS WITH MIXING SECTION																	SIZE						
Panel Thickness	Dim.	27	29	31	32	34	37	41	43	48	51	54	61	65	68S	68	71	82	92	100	117	130	
25	width	2335.5	2412	2412	2710	2744	2710	2770	2710	2822	2850	2822	3078	3232	5488	3386	3685	5540	5644	5700	6000	6000	
	height	1876.5	1888	2175	1888	1888	2080	2175	2505	2505	2660	2810	2810	2810	1888	2810	2810	2170	2505	2505	2810	3030	
50	width	2335.5	2412	2412	2710	2744	2710	2770	2710	2822	2850	2822	3078	3232	5488	3386	3685	5540	5644	5700	6000	6000	
	height	1876.5	1888	2175	1888	1888	2080	2175	2505	2505	2660	2810	2810	2810	1888	2810	2810	2170	2505	2505	2810	3030	
25	Length	3142.5	3230	3755	3755	3755	3775	3775	3775	3775	3775	3775	3950	3950	3775	3950	3950	3775	3775	3775	3950	3950	
	Weight	974.5	1015	1412	1442	1464	1536	1602	1698	1772	1995	2056	2257	2329	2220	2475	2587	2479	2740	2920	3410	3636	
50	Length	3142.5	3230	3755	3755	3755	3775	3775	3775	3775	3775	3950	3950	3950	3775	3950	3950	3775	3775	3775	3950	3950	
	Weight	1004	1046	1453	1470	1505	1579	1648	1748	1970	2048	2182	2318	2392	2292	2540	2657	2559	2914	3073	3514	3746	
25	Length	3667.5	3755	4280	4280	4280	4475	4475	4125	4475	4300	4300	4475	4475	4300	4475	4650	4475	4475	4475	4650	4650	
	Weight	1151.5	1200	1612	1618	1674	1702	1863	1623	2070	2208	2206	2262	2588	2569	2824	2912	2804	3065	3245	3735	3961	
50	Length	3667.5	3755	4280	4280	4280	4475	4475	4650	4475	4300	4475	4475	4475	4475	4650	4650	4475	4475	4475	4650	4650	
	Weight	1187	1237	1660	1681	1722	1833	1918	2267	2277	2265	2336	2416	2621	2608	2856	2972	2874	3229	3388	3829	4061	
25	Length	6292.5	6555	6555	6555	6555	7100	7100	7450	8150	8150	8150	8500	8500	-	8500	8500	-	-	-	-	-	
	Weight	1878	2138	2252	2289	2318	2640	2736	2938	3214	3360	3461	3697	3810	-	3830	4221	-	-	-	-	-	
50	Length	6292.5	6555	6555	6555	6555	7100	7100	7450	8150	8150	8150	8500	8500	-	8500	8500	-	-	-	-	-	
	Weight	1945.5	2201	2321	2357	2387	2716	2848	3027	3311	3474	3567	3825	4004	-	3953	4352	-	-	-	-	-	
25	Length	6817.5	7080	7080	7080	7080	7800	7800	7800	8850	8675	8675	9025	9025	-	9025	9200	-	-	-	-	-	
	Weight	2055	2323	2452	2465	2528	2806	2997	2863	3512	3573	3611	3702	4069	-	4179	4546	-	-	-	-	-	
50	Length	6817.5	7080	7080	7080	7080	7800	7800	8325	8850	8675	8675	9025	9025	-	9200	9200	-	-	-	-	-	
		2128.5	2392	2528	2568	2604	2970	3118	3546	3618	3691	3721	3923	4233	-	4269	4667	-	-	-	-	-	

Dimensions in mm. Weight in kgs.

UNITS WITH MIXING SECTION			SIZE																				
Unit Type/ Nomenclature	Panel Thickness	Dim.	2	2A	3	3A	4	5	6	7S	7	9	10	12	14	15	17	19	20	22	24	26	
Panel 25		width	874	915	958	1004	1128	1229	1281	1575	1430	1430	1559	1625	1625	1765	1846	2000	2154	2405	2405	2259	
		height	1346	1650	1650	1950	1950	1950	1980	1780	1980	2458	2458	2768	3068	3084	3084	3084	3084	3448	3448	3730	
Panel 50		width	874	915	958	1004	1128	1229	1281	1575	1430	1430	1559	1625	1625	1765	1846	2000	2154	2405	2405	2259	
		height	1346	1650	1650	1950	1950	1950	1980	1780	1271	2458	2458	2768	3068	3084	3084	3084	3084	3448	3448	3730	
MSV 	25	Length	2685	2685	2860	2860	2860	2860	2860	2860	3035	3035	3035	3035	3385	3385	3405	3405	3405	3405	3405	3580	
		Weight	208	237	270	313	347	379	421	372	472	544	607	710	818	893	943	1058	1145	1300	1356	1378	
	50	Length	2705	2705	2880	2880	2880	2880	2880	2880	3055	3055	3055	3055	3405	3405	3405	3405	3405	3405	3405	3405	3580
		Weight	216	247	282	329	365	393	437	392	490	564	629	735	855	924	973	1091	1179	1341	1398	1420	
M6V 	25	Length	2685	2685	2860	2860	2860	2860	2860	3035	3035	3035	3035	3385	3385	3405	3405	3405	3405	3405	3405	3580	
		Weight	240	274	309	362	402	438	480	434	538	621	694	806	923	1008	1080	1189	1285	1458	1497	1564	
	50	Length	2705	2705	2880	2880	2880	2880	2880	2880	3055	3055	3055	3055	3405	3405	3405	3405	3405	3405	3405	3405	3580
		Weight	249	286	323	377	414	455	500	453	558	644	720	834	964	1042	1115	1226	1324	1505	1544	1612	

UNITS WITH MIXING SECTION			SIZE																				
Unit Type/ Nomenclature	Panel Thickness	Dim.	27	29	31	32	34	37	41	43	48	51	54	61	65	68S	68	71	82	92	100	117	130
Panel 25		width	2335.5	2412	2412	2710	2744	2710	2770	2710	2822	2850	2822	3078	3232	5488	3386	3685	5540	5644	5700	6000	6000
		height	3753	3776	4350	3776	3776	4160	4350	5010	5010	5320	5620	5620	5620	3776	5620	5620	4340	5010	5010	5620	6060
Panel 50		width	2335.5	2412	2412	2710	2744	2710	2770	2710	2822	2850	2822	3078	3232	5488	3386	3685	5540	5644	5700	6000	6000
		height	3753	3776	4350	3776	3776	4160	4350	5010	5010	5320	5620	5620	5620	3776	5620	5620	4340	5010	5010	5620	6060
MSV 	25	Length	3667.5	3755	3930	4105	4105	4125	4125	4125	4125	4125	4125	4475	4475	4125	4475	4475	4125	4125	4475	4475	4475
		Weight	1561	1744	2079	2116	2142	2330	2424	2543	2770	2908	3114	3267	3363	3162	3547	3677	3573	3890	4118	5558	4930
	50	Length	3667.5	3755	3930	4105	4105	4125	4125	4125	4125	4125	4125	4125	4475	4475	4125	4475	4475	4125	4125	4475	4475
		Weight	1605.5	1791	2137	2173	2200	2404	2489	2613	2844	2986	3196	3354	3453	3265	3640	3839	3699	4101	4309	5711	5083
M6V 	25	Length	3667.5	3755	3930	4105	4105	4125	4125	4125	4125	4125	4125	4475	4475	4125	4475	4475	4125	4125	4475	4475	4475
		Weight	1716	1868	2041	2258	2290	2489	2594	2708	2878	3162	3248	3607	3720	3423	3920	4072	3868	4218	4805	5248	5591
	50	Length	3667.5	3755	3930	4105	4105	4125	4125	4125	4125	4125	4125	4125	4475	4475	4125	4475	4475	4125	4125	4475	4475
		Weight	1766	1920	2100	2318	2350	2554	2662	2781	2954	3244	3331	3704	3820	3530	4024	4245	3987	4348	4666	5412	5763

Dimensions in mm. Weight in kgs.



Resulting Class according to EN 1886 : 2007

CASING STRENGTH : D1
CASING AIR LEAKAGE : L1
THERMAL BRIDGING FACTOR : TB2
THERMAL TRANSMITTANCE : T3
FILTER BY PASS LEAKAGE : F8

Performance Characteristics tested to EN 13053 /2006 standard for

AIR FLOW – STATIC PRESSURE DATA - POWER CONSUMPTION
HEAT RECOVERY
COOLING DUTY
HEATING DUTY
AIR – SIDE & WATER - SIDE PRESSURE DROP

BA unit performance certificate



Eurovent Certita Certification S.A.S. - 48/50, rue de la victoire - 75009 PARIS FRANCE
R.C.S. PARIS 513 133 637 - NAF 7120B

Accreditation #5-0517 Products and Services Certification
according to NF EN ISO/CEI 17065:2012 - Scope available on
www.cofrac.fr.
COFRAC is signatory of EA MLA, list of EA members is available in
<http://www.european-accreditation.org/ea-members>

Certification Diploma N° : 13.10.004

Eurovent Certita Certification certifies that

Air Handling Units

from

SYSTEMAIR AB

Located at

Industrivägen 3
739 30 Skinnskatteberg, Sweden

Range

BA

Software for calculation of performances

SYSTEMAIR BAAHU 4.2.0

Trade name

SYSTEMAIR

have been assessed according the requirements of following standard

OM-5-2017

The list of certified products is displayed at :

<http://www.eurovent-certification.com>

Manufacturing places

GREATER NOIDA, India

SYSTEMAIR AB

is authorised to use the EUROVENT CERTIFIED PERFORMANCE mark

in accordance with the rules specified in the Operational Manual

OM-5-2017

Erick MELQUIOND

President

Approval date : 2013/10/29

Re-checked on : 2018/02/22

Valid until : 2019/06/30

Claris version: Prod 7.2 (09/02/2018)

Quality Management ISO certificate

DNV·GL

MANAGEMENT SYSTEM CERTIFICATE

Certificate No: 176390-2015-AQ-IND-RvA	Initial certification date: 12, April, 2006	Valid: 12, April, 2018 - 11, April, 2021
---	--	---

This is to certify that the management system of

Systemair India Pvt. Ltd.
HO & Unit 1: Plot No. 3, Ecotech-1, Sector-31, Kasna, Greater Noida – 201 308,
Uttar Pradesh, India
and the sites as mentioned in the appendix accompanying this certificate

has been found to conform to the Quality Management System standard:
ISO 9001:2015

This certificate is valid for the following scope:
Design, development, manufacture, marketing, supply and service of HVAC products

Place and date:
Chennai, 09, April, 2018



MGMT. SYS.
RvA C 024

The RvA is a signatory to the IAF MLA

For the issuing office:
**DNV GL – Business Assurance
ROMA, No. 10, GST Road, Alandur,
Chennai - 600 016, India**



Sivadasan Madiyath
Management Representative

Lack of fulfilment of conditions as set out in the Certification Agreement may render this Certificate invalid.
ACCREDITED UNIT: DNV GL Business Assurance B.V., ZWOLSEWEG 1, 2994 LB, BARENDRECHT, NETHERLANDS. TEL: +31102922689.
assurance.dnvgl.com



Certificate No: 176390-2015-AQ-IND-RvA
Place and date: Chennai, 09, April, 2018

Appendix to Certificate

Systemair India Pvt. Ltd.

Locations included in the certification are as follows:

Site Name	Site Address	Site Scope
Systemair India Pvt. Ltd.	HO & Unit 1: Plot No.3, Ecotech-1, Sector-31, Kasna, Greater Noida - 201 308, Uttar Pradesh, India	Design, development, manufacture, marketing, supply and service of HVAC products
Systemair India Pvt. Ltd.	Unit 2: Plot No. 8-84/14/11, Opp. Sai Geetha Ashram, Devaryamzal, Medchal Dist., Hyderabad - 500 078, Telangana, India	Manufacture, marketing, supply and service of HVAC products

Lack of fulfilment of conditions as set out in the Certification Agreement may render this Certificate invalid.
ACCREDITED UNIT: DNV GL Business Assurance B.V., ZWOLSEWEG 1, 2994 LB, BARENDRECHT, NETHERLANDS. TEL:+31102922689. assurance.dnvgl.com
Page 1 of 1

Few of our valued customers

Pharmaceuticals / Clean Room

1	ACG-Pithampur
2	ACME Formulation-Baddi
3	Actoverco-Iran
4	Agila Specialities Pvt. Ltd.
5	Ahlcon Parenterals India Ltd.
6	Akorn India Pvt. Ltd.
7	Aleor Dermaceuticals Ltd.
8	Alkem Laboratories, Baddi
9	Alpha Pharma Healthcare (I) Pvt. Ltd.-Thane
10	Apotex
11	Ashrae Clean Room, Hy'bad
12	Atra Pharmaceuticals
13	Avantis Pharma
14	BCG Vaccine Laboratories-Tamilnadu
15	Bengal Chemical, Kolkata
16	Biocon Pharma
17	Biocon SDN BHD-Malaysia
18	Biological E Limited-Hyderabad
19	BSL / German Remedies Ltd., Goa
20	Cipla Limited-Bengaluru/Pune/Sikkim
21	Cosmo Laboratories, Ludhiana
22	Dhanuka Laboratories Ltd.
23	Dr. Actoverco-Iran
24	Dr. Reddy's Laboratories
25	East African (India) Overseas
26	E-Biological, Pune
27	EISAI Pharmaceuticals India Pvt. Ltd.-Vizag
28	Elysium Pharmaceuticals Limited
29	Emami Limited- Dongari/ Vapi
30	Emami Research Park
31	Fresenius Kabi Oncology Ltd.
32	Goa Formulation Ltd.
33	Gufic-Ahmedabad
34	HBL Limited-Tamilnadu
35	Hellios Pharma, Baddi
36	Hindustan Liver Limited
37	Hospira, Vishakhapatnam
38	HPL Pharmaceutical, Bangladesh
39	Immacule-Nalagarh
40	Innova Captab, Baddi
41	INTAS Pharmaceuticals, Ahmedabad

42	IPCA Laboratories Ltd.
43	Jodas Expoim Pvt. Ltd.-Hyderabad
44	Johnsons & Johnsons Ltd.
45	Life Pharma-Dubai
46	Mankind Pharma Limited
47	Marck Parenterals
48	Martin & Harris Labs Ltd.
49	Mayer Organics Pvt. Ltd.,
50	Medical Cyclotron Centre-Kolkata
51	MICO, B'lore
52	Morepan Lab. Baddi
53	Mylan Laboratories
54	Nabros Pharma Pvt. Ltd.
55	Neon Pharma
56	Nicolas Piramal, Mumbai
57	Okasa Remedies Daman
58	Optimus Pharma-Hyderabad
59	Pan Pharma, Baroda
60	Parsan Oversease (P) Limited
61	Perrigo API India Pvt. Ltd.
62	Pfizer, Mumbai
63	Project at Myanmar
64	Ranbaxy Laboratory-Dewas, Toansa, Baddi, Mohali, Poanta Sahib
65	Sangre-La Pharma
66	Scott Edil Adv. Reseach Lab & Education Ltd.
67	Sekh Saria Chemicals
68	Sequent Pharma
69	Serum Institute-Pune
70	Shree Ji Laboratory Pvt. Ltd.
71	Sidmak Laboratories (I) Pvt.Ltd.
72	Stelis Biopharma-Bangalore
73	Sudair Pharma
74	Sun Pharma Sikkim-II & Dadra
75	Sunpharma-Basaka
76	Swiss Garnier Genexiaa Sciences-Sikkim
77	Syngene International Ltd.
78	Teva-Gajraula, Malanpur
79	Torrent Pharmaceuticals Ltd., Dahej, Baddi, Ahmedabad, Indrad

80	Troikaa Pharmaceuticals Ltd.
81	Unichem Laboratories-Pithampur, Roha
82	USV Ltd., Baddi, Mumbai, Daman
83	Vitane-Iran
84	Watson Pharma Limited
85	West Pharma
86	Wockhardt Ltd.

Industrial

1	Amway India Enterprises Pvt. Ltd.
2	Apollo Tyres
3	Asian Paints Ltd., Mumbai
4	BARC-Mysore
5	BHEL, Bhopal
6	Bosch Ltd.
7	British High Commission
8	CGPL, Mundra
9	Colgate, Baddi
10	ETA/Warner Lambert
11	Exxon Co./ Voltas Ltd., Bangalore
12	Godrej Hospital, Mumbai
13	HB Estate, Gurgaon
14	IEML, NOIDA
15	IGIB, NewDelhi
16	IOCL, Barauni ,Bihar
17	IOCL, Faridabad
18	IOCL, Medinipur, WB
19	JMI, New Delhi
20	JRRCRL-Jaipur
21	Mars International India Pvt. Ltd.
22	MES-Manesar, Jabalpur, Shimla
23	NABARD, Lucknow
24	NCBS, Bangalore
25	Oberoi Airport Services, New Delhi
26	Om Kar Builder
27	Paradip Refinery IOCL
28	Price Water House, Calcutta
29	Procter & Gamble, Singapore
30	Punj Lloyd Ltd., Gurgaon
31	Rajwest Power Plant

32	SAIL IISCO-Burnpur
33	SBC, Hyderabad
34	Scott Edil Advance Research Lab & Edu. Ltd.
35	Sekhsaria Chemicals
36	Serum Institute, Pune
37	Texas Instrument, B'lore
38	Thermax Solar Power Plant, Jaisalmer
39	Tmcb-2 Bombay Dyeing
40	Unitech Hi-Tech Structures Limited.-Kolkata
41	Vacmet India Ltd.
42	Warner Lambert

Hospital

1	AIIMS, New Delhi
2	Alexis Hospital-Nagpur
3	Apollo Hospital
4	Apollo Reach Hospital-Trichy
5	Cancer Hospital-Bathinda
6	Centre for Digestive & Kidney Disease, Mumbai
7	Dhanalakshmi Srinivasan Medical College & Hospital
8	Dr. L.H. Hiranandani Hospital,
9	EPR Centre (Vitane)
10	Escorts Heart Institute
11	ESIC Hospitals
12	Eternal Healthcare Centre & Research Institute Pvt. Ltd., Jaipur
13	Fortis Hospital, New Delhi
14	Godrej Hospital-Mumbai
15	Hiranandani Hospital-Mumbai
16	Jaypee Medical Center
17	Krishna Heart Institute, Amedabad
18	Manipal Medical Institute, Nepal
19	Mata Chanan Devi Hospital
20	Max Hospital, Shalimar Bagh, New Delhi
21	Sanjay Gandhi Hospital, New Delhi
22	Shillong Hospital
23	Sir Ganga Ram Hospital, New Delhi
24	Tata Memorial Cancer Hospital-Vizag
25	Trauma Center, New Delhi
26	Udgir Hospital
27	West Bengal Hospital

Hotels

1	Aakriti Hotel, Greater Noida
2	Bharat Hotel Limited, Jaipur
3	Botanix Resorts-Gurgaon
4	Dusit Devrana Hotel, New Delhi-I
5	Fortune Hotel, Gurgaon
6	Ganapath Hotel-Mysore
7	Garden-Galeria
8	Goa Hotels (Hyatt Goa) HRW
9	Grand Hyatt, Goa
10	Grand Hyatt-Cochin
11	Hotel Hyatt Regency, Calcutta
12	Hotel Intercontinental-Dhaka
13	Hotel Kaniska, New Delhi
14	Hotel Marriott, New Delhi
15	Hotel Shang RE-LA
16	Hotel Udaivilas, Udaipur
17	Hotel Yak & Yeti, Nepal
18	Hyatt Andaz-New Delhi
19	IBIS hotel, New Delhi
20	ITC Gardenia-Bangalore
21	ITC Green Bharat
22	ITC Ltd., Gurgaon
23	Jas Hotel at Amritsar
24	JW Marriot
25	KBJ Grand-Varanasi
26	Kenwood Hotel, Mumbai
27	Lemon Tree Hotel, Hyderabad
28	Malsi Hotel, Dehradun
29	MBD Hotels, Jalandhar
30	Novotel Hotel, Gurgaon
31	Piccadily Hotels Pvt. Ltd.
32	Powai Plaza, Mumbai
33	Radisson Hotel-Guwahati
34	Raj Chopra Mussoorie Hotel
35	Royal Orchid Hotel at Jaipur
36	Sheraton Hotel-Gr. Noida, New Delhi, Jaipur
37	Taj-Bangalore, Kolkata, Mumbai, Hyderabad
38	The Oberoi
39	Tip Top Hotel-Pune
40	Today Hotel
41	Waves Hospitality Pvt. Ltd.
42	Westin Hotel-Gurgaon

Commercial Office

1	Amanora Park Town-Pune
2	American Embassy School, New Delhi
3	Amity-Noida
4	Anjaneya Building-Bangalore
5	Ansal Plaza Mall, Ghaziabad
6	British High Commission
7	BSL/Eagelton -The Golf Village, Bangalore
8	BSNL, New Delhi
9	Callnet India Pvt. Ltd.
10	Cargo Complex, New Delhi
11	Cyber Park, Gurgaon
12	Cyber Walk, Manesar
13	Daksh Call Centre, Gurgaon
14	DHL Airfreight, Gurgaon
15	Era Infra Engineering Limited
16	Global Business Park, Gurgaon
17	Godrej IT Park, Mumbai
18	Golden Heights, Bangalore
19	IIL, Hyderabad
20	IIT, Kanpur
21	IIT-Mumbai
22	Inorbit Mall-Pune, Malad, Mumbai, Vasi
23	I-Park, Gurgaon (Amendment)
24	ISRO, Lucknow
25	Jaipur Central Developers P. Ltd.
26	Jaipur Stock Exchange
27	Jindal Saw, Gurgaon
28	JMI-New Delhi
29	Khalsa Heritage, Punjab
30	LIC Mumbai
31	LMT School of Management, Punjab
32	Lodha I Think-Mumbai
33	Manjeera Mall
34	Market City, Kurla
35	Mind Space Club, Mumbai
36	Mind Space, Hyderabad
38	Motherson Corporate Office, Noida
39	MTNL Mumbai
40	New District Court-Chandigarh
41	Orchid Agora, Gurgaon
42	Orchid Square, Gurgaon
43	Parinee, Mumbai

44	Park View Business Tower
45	Parliament Library, New Delhi
46	Pothys Textiles, Chennai
47	Power Finance Corporation
48	Prasar Bharti, New Delhi
49	PSP Projects Pvt. Ltd.-Gandhinagar
50	Punj Lloyd-Gurgaon
51	Raheja Building, 1A
52	ITES Ltd., Gurgaon
53	Ritnand Balved Education Foundation, Lucknow
54	Seawoods-Navi Mumbai
55	Shopat Mantri, Bengaluru
56	Shri Guru Ram Das Institute of Dental Science & Research
57	SRMT Mall-Kakinada
58	Star TV India-Mumbai
59	Thimphu Tech Park, Bhutan
60	TOD-Hyderabad
61	TG Arla Dairy Products Lftz Enterprises-Nigeria
62	Unitech Business Park, Gurgaon
63	Vatika-Tech Park, City, Hospitality
64	Vipul Business Park-Gurgaon
65	Voltas / TCS Salt Lake, Calcutta
66	WHO, Delhi
67	Windsor, Mumbai
68	YKK India

Infrastructure

1	Bangabandhu military museum, Bangladesh
2	Cochin International Airport Ltd.
3	Delhi Metro Rail Corporation
4	Shivaji Stadium, New Delhi
5	TN Assembly Building
6	Rashtrapati Bhawan
7	DU Commom Wealth Games
8	Airport Authority of India
9	IAAI Guwahati Airport, Calcutta
10	ULCC Infrastructure (P) Ltd.
11	Hyderabad International Airport
12	Delhi International Airport

IT / ITES

1	Accenture Services, Bengaluru
2	ARN IT Park, Greater Noida
3	CIS Udyog Vihar, Gurgaon
4	Cognizant Technology Service, Chennai
5	Computer Associates, B'lore
6	E-Serve International, Mumbai
7	Hughes Software, Gurgaon
8	I Gate-Pune
9	Infosys Ltd., Bengaluru, Mangalore, Pune, Trivenderum
10	IT Square, Greater Noida
11	Net Apps-Bangalore
12	Oxygen at Noida
13	Phillips Software, Bangalore
14	Phoenix Infocity Pv.t Ltd.
15	Pune Embassy Projects Pvt. Ltd.,
16	S.P. Infocity, Manesar
17	Tata Teleservices, New Delhi
18	TCS Salt Lake-Calcutta
19	TCS, Bangalore
20	Tidel Park, Chennai
21	Wipro Limited

Technical Assistance & Customer Care Services

Systemair India provides to all customers a Technical Assistance Service by highly qualified and experienced team having specialization in both Industrial and comfort facilities. We also offer a service for commissioning and technical advice for the equipment supplied to our valued customers. Kindly feel free to contact us or request a quote for such services.

www.systemair.in

service@systemair.in

Tel. +91 (0120) 476 3100 / 3140

NORTH & EXPORT

Noida

A-19, First Floor, Sector-64 Noida, U.P 201307
Tel: +91 120 4639 700

EAST

Kolkata

92/2A Bidhan Nagar Road, Kolkata, West Bengal -700067
Tel: +91 983 0420 473

WEST

Mumbai

Office No. G 16, Neo Corporate Plaza, RamChandra Lane
Ext., Kanchpada, Malad West, Mumbai-400064
Tel: +91 08108124863

Pune

Office No 7B , B wing Manorama Apartments
Lane no 7, Prabhat Road, Pune-411004
Tel: +91 9823987810

Ahmedabad

138/1655, Karnavati Apartment, Paras Nagar,
Sola Road, Naranpura, Ahmedabad-380063
Tel: +91 9624 448 912 / 9823987810

SOUTH

Hyderabad

Plot No. 8-84/14/11; Opp. Sai Geetha Ashram;
Devaryamzal, Medchal Dist, Hyderabad 500078
Tel:+91 40 40176398 / 9686454434

Bengaluru

40 Sindhoora, MLA Layout, Block 4, RMV 2nd Stage,
Bengaluru, Karnataka - 560094
Tel: +91 80 2341 6922 / 9686454434

Cochin

53/1690 B, 2nd Floor. Meppullil Building,
Vytila Ernakulam , Kerala -682019
Tel: +91 904 8181 300 / 9686454434

Chennai

Tel: +91 9686454434

SYSTEMAIR INDIA

(Head office & Manufacturing Plant India)

LEED Platinum campus

Plot No.03, ECOTECH I, Sector-31,
Kasna, Greater Noida, U.P - 201308.

Tel: +91 120 4763 100

Fax: +91 120 4763 101



www.systemair.in