



Air Preparation Products

651 Series | Filter Regulator Lubricator (FRL)
652 Series



Table of Contents

651/652 Series

Product Overview	2
Particulate Filter	4
Coalescing Filter	8
Adsorber - Activated Carbon	8
Regulator	12
Manifold Regulator	16
Particulate Filter/Regulator	19
Coalescing Filter/Regulator	23
Lubricator	27
Shut-Off Isolation Valve	30
Slow-Start/Quick Exhaust Valve	33
Diverter Block	36
Lockout Valve	38
Air Preparation Manifold Assemblies	40
Mounting Bracket Dimensional Drawings	42
Bowl and Drain Features	43
280 Series Digital Pressure Switch	44
PS182 Series Pressure Switch	45
PS180 Series Pressure Switch	46
Digital Pressure Gauge	46
349 Series Pressure Switch	47
Electric Differential Pressure Indicator (DPI)	48
Electronic Liquid Level Indicator	48
Kits and Service Parts	49

651/652 Series - Product Overview

Air Preparation Manifold Assembly & Optional Features

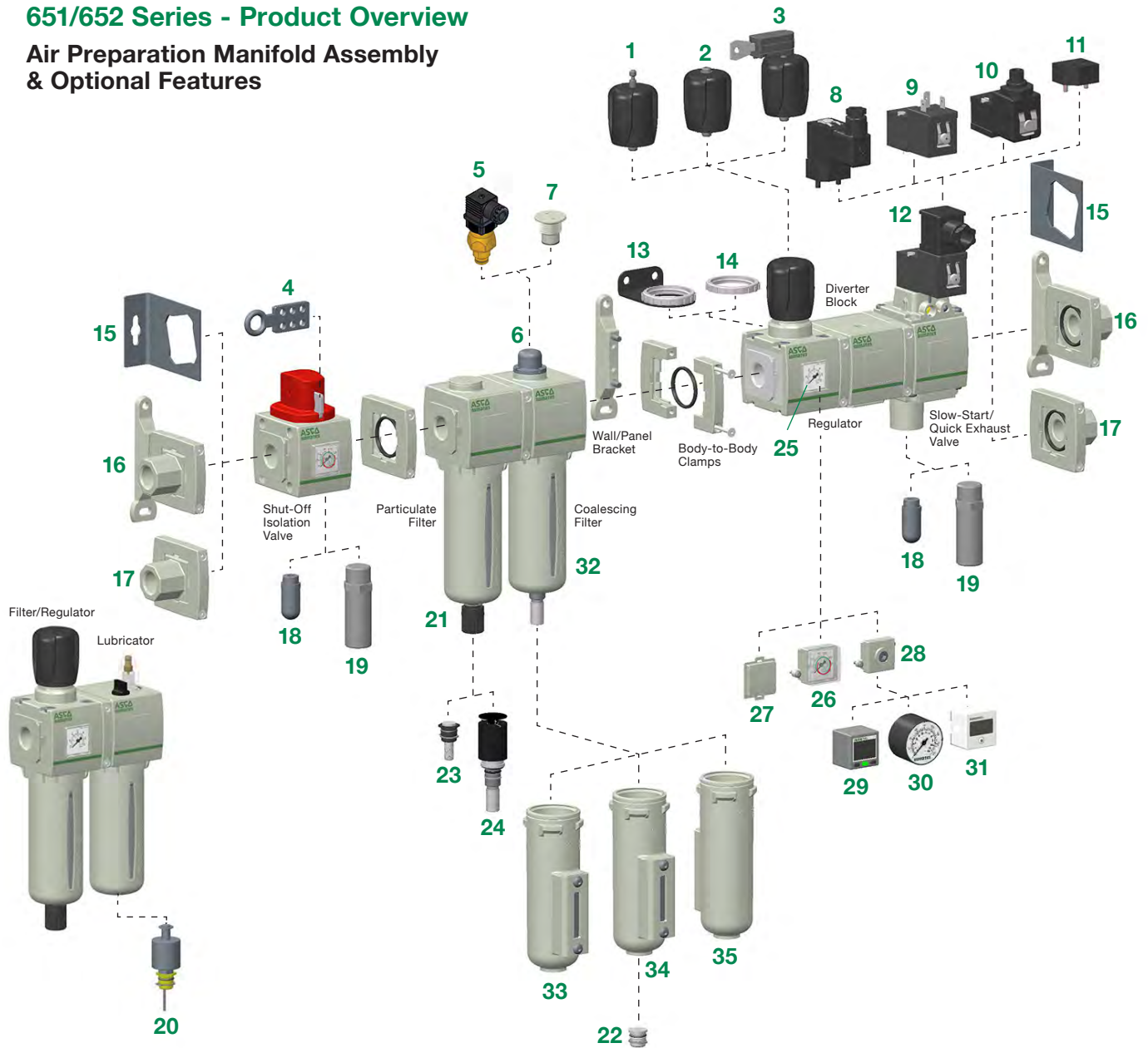

- | | | |
|--|---|---|
| 1) Provision for Key Lockable (Regulator & F/R*) | 12) Horizontal Solenoid (DIN Connector with & w/o LED) | 24) Automatic Drain – Normally Open – Brass |
| 2) Tamper Resistant (Regulator & F/R*) | 13) Panel Nut/Panel Bracket (Regulator & F/R*) | 25) Low Profile Gauge |
| 3) Key Lockable (Regulator & F/R*) | 14) Panel Nut (Regulator & F/R) | 26) Low Profile Gauge with Pressure Range Indicators |
| 4) Scissor Lock | 15) Side Mounting Brackets | 27) No Gauge Port |
| 5) Electric Differential Pressure Indicator (Coalescing Filter) | 16) End Plates, Body-to-Body Clamps & Wall/Panel Brackets | 28) Port Plate |
| 6) Differential Pressure Visual Pop-Up Indicator (Coalescing Filter) | 17) End Plates & Body-to-Body Clamps | 29) Digital Pressure Switch – DPS 280 Series |
| 7) No Differential Pressure Indicator | 18) Polyethylene Muffler | 30) Round Gauge |
| 8) Vertical Solenoid (DIN Connector with & w/o LED) | 19) Metal Muffler | 31) Digital Gauge |
| 9) Horizontal Solenoid without DIN Spade Coil without Connector | 20) Electronic Liquid Level Indicator | 32) Polycarbonate Bowl & Guard (No Bowl Guard Option - 651 Series Only) |
| 10) Horizontal Solenoid with 3 Pin M12 Connection | 21) Semi-Automatic/Manual Drain | 33) Metal Bowl with Polyamide Sight Gauge |
| 11) Pilot Air Operated | 22) Plug for No Drain | 34) Metal Bowl with Borosilicate (Glass) Sight Gauge |
| | 23) Manual Drain – Stainless Steel | 35) Metal Bowl without Sight Gauge |

* F/R = Filter/Regulator

651/652 Series Modular Assembly Mounting Features

(see Accessories page 51 for part numbers)

Body-to-Body Assembly Clamp

Easy to assemble Body-to-Body clamp, with captive screws. Available with NBR or FKM Seal. Products are easily assembled in seconds.



End Plates with Body-to-Body Assembly Clamp

The "End Plate" feature allows the user to easily remove the air prep assembly without having to remove the piping. Simply loosen the screws on the Body-to-Body assembly clamps, and the manifold is easily removed in seconds. The kit includes Inlet/Outlet plates, Body-to-Body clamps and O-rings.



Wall/Panel Bracket

The Wall/Panel Bracket feature is the primary mounting feature for the air prep assemblies. These brackets easily attach to the back of the Body-to-Body assembly clamps using two screws. In addition, this bracket can be used as a support bracket between any station on the manifold.



Side Mounting Brackets

The "Side Mounting Brackets" are typically used to mount single units, but could also be used to mount multiple units.

Note: All ports are threaded as standard (except Lockout Valve).



PARTICULATE FILTER

- Large selection of filtering capacities to remove particulate and water droplets from compressed air or inert gas
- Sintered polyethylene elements, with centrifugal separator, include 5, 25 and 40 Microns
- Optional extended temperature range of -40 °F to 176 °F (-40 °C to 80 °C)
- Innovative two position plastic drain with manual and semi-automatic functions. Additional drains include an automatic style (brass) and manual (stainless steel)
- Polycarbonate and Aluminum bowls with a selection of sight gauge materials that meet industry and application requirements
- Threaded ports allow for individual or modular mounting
- Air purity class according to ISO 8573-1: 2010



Performance Data					
Series		651		652	
Port Sizes		1/8, 1/4		1/4, 3/8, 1/2	
Thread Type		NPTF, G & Rc			
Nominal Flow - Per ISO 6358 P1 = 91.3 PSI (6.3 bar) ΔP = 14.5 PSI (1 bar)		Micron Rating		SCFM (L/min ANR)	
		1/8	5μ	31.2 (885)	-
			25μ	32.5 (920)	-
			40μ	34.6 (980)	-
		1/4	5μ	44.1 (1250)	70.8 (2020)
			25μ	49.6 (1410)	89.3 (2250)
			40μ	54.7 (1550)	92.4 (2640)
		3/8	5μ	-	76.5 (2190)
			25μ	-	118.7 (3390)
			40μ	-	135.5 (3870)
		1/2	5μ	-	80.2 (2290)
			25μ	-	129.5 (3700)
			40μ	-	153 (4370)
Maximum Inlet Pressure PSIG (bar)		Polycarbonate Bowl	232 (16)		
		Aluminum Bowl	232 (16)		
Ambient Temperature Range °F (°C)		-4 to 122 (-20 to 50)			
Fluid Temperature Range °F (°C)		-4 to 122 (-20 to 50)			
Fluid		Air or Inert Gas			
Weight lbs (kg)		w/Polycarbonate Bowl	0.524 (0.238)	0.94 (0.426)	
		w/Aluminum Bowl	0.842 (0.382)	1.22 (0.553)	

Materials in Contact with Fluid	
Body	Aluminum
Seals	NBR/FKM
Filter Element	Sintered Polyethylene
Bowl	Polycarbonate or Aluminum

Air Purity Class - ISO 8573-1:2010*	
5μ	(5:8:4)
25μ	(6:8:4)
40μ	(7:8:4)

How to Order

Particulate Filter

8 651 A B B P 2 J A00 0 N

Port Type

- 8 = NPTF
- G = ISO 228/1-G*
- J = ISO 7/1 Rc

Product Series

- 651
- 652

Revision

A

Product Type

- B = Filter - Particulate

Elements

- A = 40 Micron (Green)
- B = 5 Micron (White)
- J = 25 Micron (Yellow)

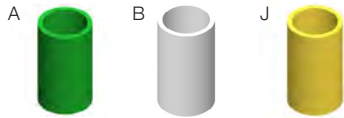

Bowl Type

- K = Metal Bowl without Sight Gauge
- L = Metal Bowl with Sight Gauge (Glass)
- M = Metal Bowl with Sight Gauge (Polyamide)
- N = Polycarbonate Bowl without Bowl Guard (651 only)
- P = Polycarbonate Bowl with Bowl Guard



Drain Type

- 0 = No Drain
- A = Auto Drain Normally Open
- N = Manual - Semi-Automatic Drain
- Q = Manual Drain - Stainless Steel



Options***

- A00 = No Options
- 101 = Side Mounting Brackets
- 105 = High Temperature (80 °C/176 °F)
- 106 = Low Temperature (-40 °C/-40 °F)**
- 109 = FKM Seals
- 117 = ATEX Zones 1-21
- 202 = 105 + 109
- 2A9 = 105 + 106
- 101



Port Size

- 1 = 1/8 (651 Series)
- 2 = 1/4 (651 or 652 Series)
- 3 = 3/8 (652 Series)
- 4 = 1/2 (652 Series)

* Conforms to ISO standards 1179-1

** Compressed air must be dry enough so no ice formation is present on the product. All bowls should be emptied prior to ambient temperatures dropping below 32 °F (0 °C)

*** If multiple options are required, please use the on-line CAD configurator on the website to generate the part number (www.asco.com), or consult factory.

Dimensions: mm (inches)

Dimensional Drawing - 651/652 Series Particulate Filter

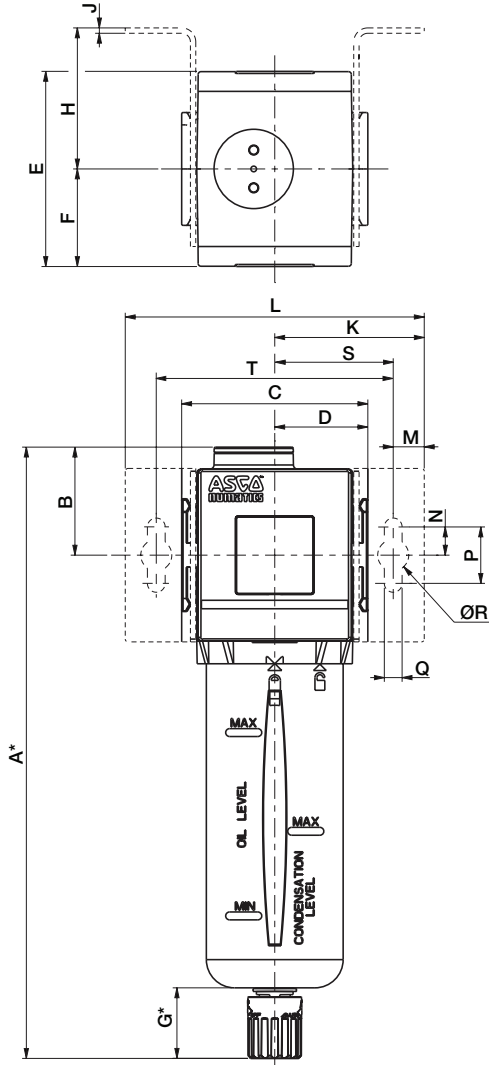

Cross Section - 651/652 Series Particulate Filter

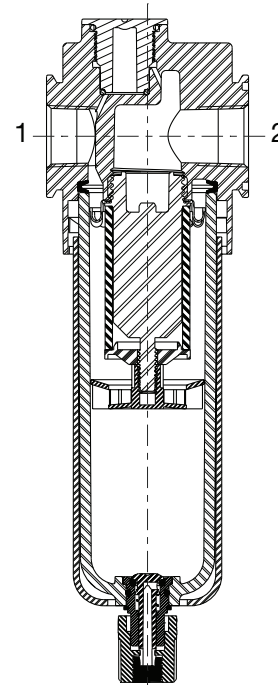

To remove bowl allow:
651 - 44mm (1.8in)
652 - 75mm (3.0in)
from the bottom of
the bowl drain.

	A	B	C	D	E	F	G	H	J
651	197	33.8	50	25	58	29	25	44.5	1.27
	(7.76)	(1.33)	(1.97)	(0.98)	(2.28)	(1.14)	(0.98)	(1.75)	(0.05)
652	217	38.3	66	33	69	34.5	25	50	1.9
	(8.54)	(1.51)	(2.60)	(1.30)	(2.72)	(1.36)	(0.98)	(1.97)	(0.07)

	K	L	M	N	P	Q	ØR	S	T
651	46	92	11	10	20	6.3	11	35	70
	(1.81)	(3.62)	(0.43)	(0.39)	(0.79)	(0.25)	(0.43)	(1.38)	(2.76)
652	53	106	11	10	20	6.3	5.5	42	84
	(2.09)	(4.17)	(0.43)	(0.39)	(0.79)	(0.25)	(0.22)	(1.65)	(3.31)

* Variable dimension based on type of drain that is specified; If an Automatic Drain is specified, add another 5mm to "G" dimension, which also adds 5mm to the "A" dimension.

Particulate Filter Flow Charts

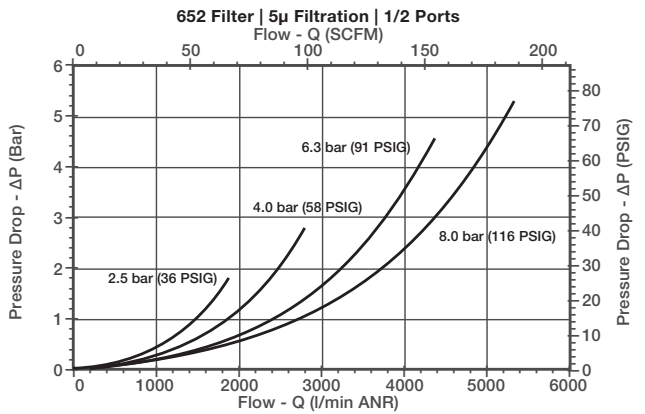
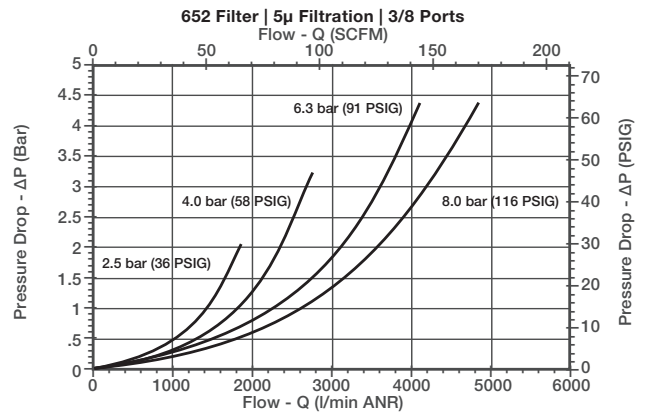
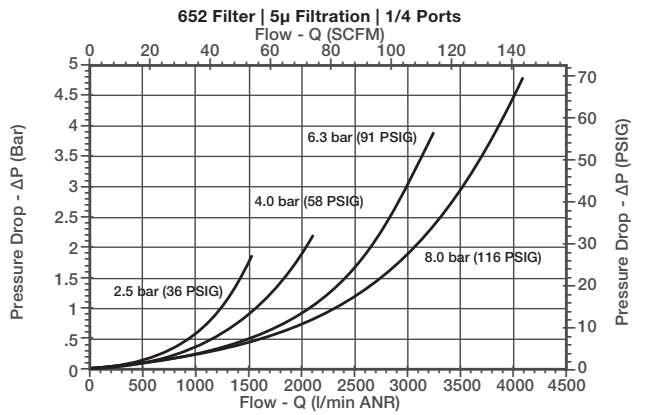
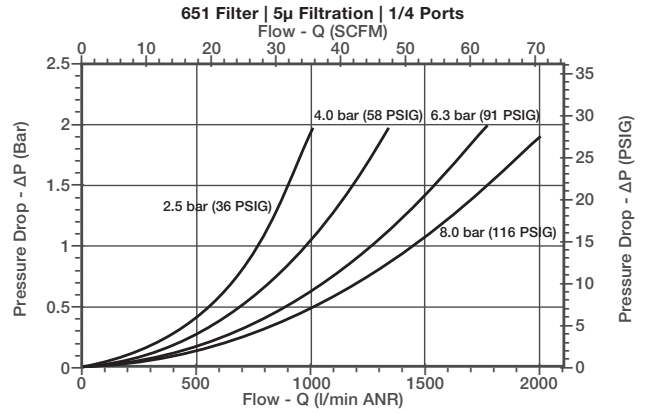
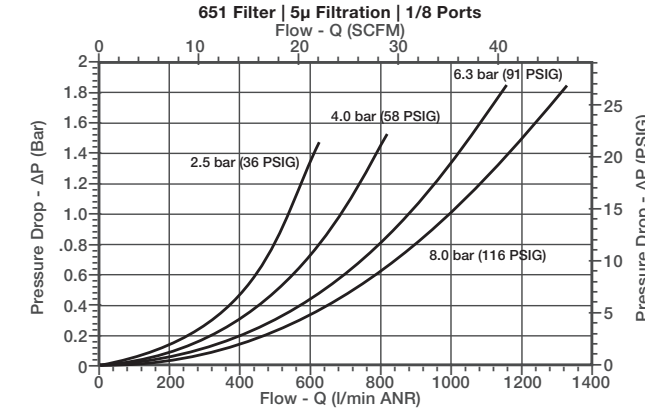

COALESCING FILTER & ADSORBER

- Extensive range of coalescing filter elements to remove oil and sub-micron particles down to 0.01 microns. Air purity class according to ISO 8573-1: 2010
- Optional 3 micron pre-filter integrated in the coalescing element eliminates the need for a separate particulate element. Coalescing filter elements include 0.3 and 0.01 microns
- Adsorber filter (activated carbon) for removal of odors and hydrocarbon vapor
- Innovative two position plastic drain with manual and semi-automatic functions. Additional drains include an automatic style (brass) and manual (stainless steel)
- Polycarbonate and Aluminum bowls with a selection of sight gauge materials that meet industry and application requirements
- Optional extended temperature range of 176 °F (80 °C)
- Visual or electrical differential pressure Indicators for condition monitoring of filter element

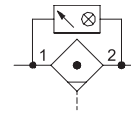

Performance Data					
Series		651		652	
Port Sizes		1/8, 1/4		1/4, 3/8, 1/2	
Thread Type		NPTF, G & Rc			
Nominal Flow - Per ISO 6358 P1 = 91.4 PSI (6.3 bar) ΔP = 5 PSI (0.35 bar)		Micron Rating		SCFM (L/min ANR)	
		1/8	0.3 μm	15.3 (430)	-
			0.01 μm	10.9 (310)	-
		1/4	0.3 μm	17.0 (480)	28.0 (800)
			0.01 μm	12.4 (350)	25.0 (710)
		3/8	0.3 μm	-	28.6 (820)
			0.01 μm	-	27.5 (790)
		1/2	0.3 μm	-	30.5 (870)
0.01 μm	-		29.1 (830)		
Maximum Inlet Pressure PSIG (bar)		Polycarbonate Bowl	232 (16)		
		Aluminum Bowl	232 (16)		
Ambient Temperature Range °F (°C)		35 to 122 (1.7 to 50)			
Fluid Temperature Range °F (°C)		35 to 122 (1.7 to 50)			
Fluid		Air or Inert Gas			
Weight lbs (kg)		w/Polycarbonate Bowl	0.540 (0.245)	0.98 (0.442)	
		w/Aluminum Bowl	0.860 (0.390)	1.25 (0.569)	

Materials in Contact with Fluid	
Body	Aluminum
Seals	NBR/FKM
Coalescing Filter Element	Borosilicate Microfiber & Polyester
Filter Element End Cap	Polypropylene
Adsorber	Activated Carbon
Bowl	Polycarbonate or Aluminum

Air Purity Class - ISO 8573-1:2010*	
0.3 μm	(3:7:3)
0.01 μm	(2:7:2)

* 651 Series maximum flow at 91.4 PSI (6.3 bar) inlet pressure to maintain air purity class is 3.5 SCFM (100 L/min)

* 652 Series maximum flow at 91.4 PSI (6.3 bar) inlet pressure to maintain air purity class is 10.6 SCFM (303 L/min)

How to Order

Coalescing Filter

8 651 A F D P 2 H A00 0 N

Port Type

- 8 = NPTF
- G = ISO 228/1-G*
- J = ISO 7/1 Rc

Product Series

- 651
- 652

Revision

A

Product Type

- A = Adsorber - Activated Carbon
- F = Filter - Coalescing

Elements

- D = 0.3 Micron - Coalescer (Green)
- E = 0.01 Micron - Coalescer (Red)
- F = Adsorber - Activated Carbon (Gray)
- M = 0.3 Micron Coalescer with 3 Micron Prefilter (Green)
- N = 0.01 Micron Coalescer with 3 Micron Prefilter (Red)



Bowl Type

- K = Metal Bowl without Sight Gauge
- L = Metal Bowl with Sight Gauge (Glass)
- M = Metal Bowl with Sight Gauge (Polyamide)
- N = Polycarbonate Bowl without Bowl Guard (651 only)
- P = Polycarbonate Bowl with Bowl Guard



Drain Type

- 0 = No Drain
- A = Auto Drain Normally Open
- N = Manual - Semi-Automatic Drain
- Q = Manual Drain - Stainless Steel



Options**

- A00 = No Options
- 101 = Side Mounting Brackets
- 105 = High Temperature (80 °C/176 °F)
- 109 = FKM Seals
- 117 = ATEX Zones 1-21 ⚠
- 202 = 105 + 109



Indication Type

- E = Electric Differential Pressure Indicator (Coalescing only)
- H = Differential Pressure Visual Pop-Up Indicator (Coalescing only)
- J = No Differential Pressure Indicator

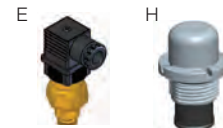

Port Size

- 1 = 1/8 (651 Series)
- 2 = 1/4 (651 or 652 Series)
- 3 = 3/8 (652 Series)
- 4 = 1/2 (652 Series)

* Conforms to ISO standards 1179-1

** If multiple options are required, please use the on-line CAD configurator on the website to generate the part number (www.asco.com), or consult factory.

Dimensions: mm (inches)

Dimensional Drawing - 651/652 Series Coalescing Filter and Adsorber

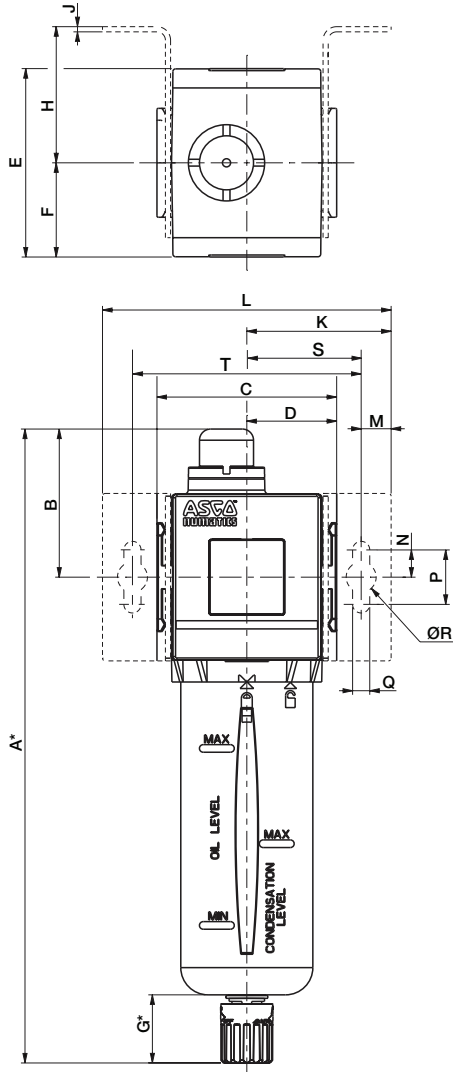

Cross Section - 651/652 Series Coalescing Filter

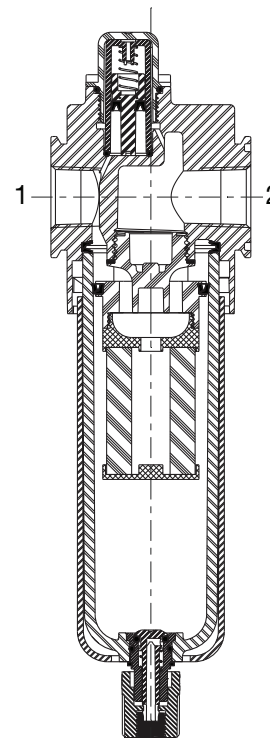

To remove bowl allow:
651 - 60mm (2.4in)
652 - 80mm (3.2in)
from the bottom of
the bowl drain.

	A	B	C	D	E	F	G	H	J
651	213	50	50	25	58	29	25	44.5	1.27
	(8.39)	(1.97)	(1.97)	(0.98)	(2.28)	(1.14)	(0.98)	(1.75)	(0.05)
652	233	54.4	66	33	69	34.5	25	50	1.9
	(9.17)	(2.14)	(2.60)	(1.30)	(2.72)	(1.36)	(0.98)	(1.97)	(0.07)

	K	L	M	N	P	Q	ØR	S	T
651	46	92	11	10	20	6.3	11	35	70
	(1.81)	(3.62)	(0.43)	(0.39)	(0.79)	(0.25)	(0.43)	(1.38)	(2.76)
652	53	106	11	10	20	6.3	5.5	42	84
	(2.09)	(4.17)	(0.43)	(0.39)	(0.79)	(0.25)	(0.22)	(1.65)	(3.31)

* Variable dimension based on type of drain that is specified; If an Automatic Drain is specified, add another 5mm to "G" dimension, which also adds 5mm to the "A" dimension.

Coalescing Filter and Adsorber Flow Charts

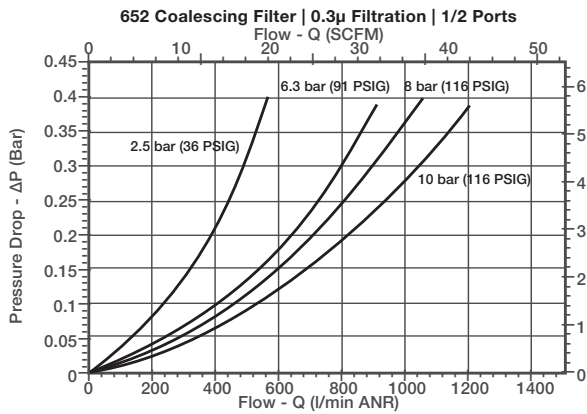
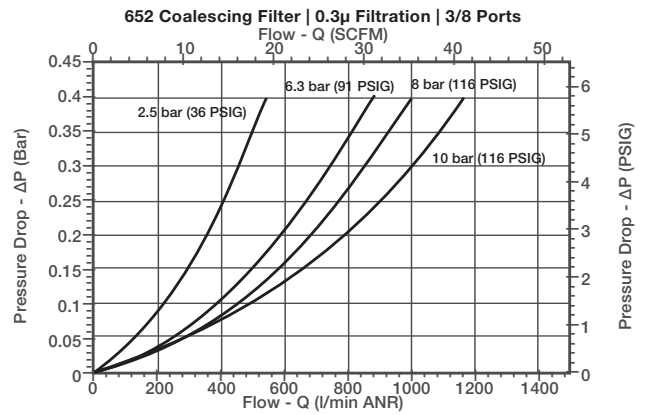
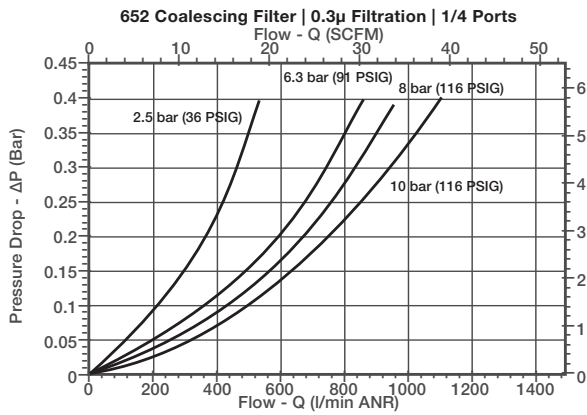
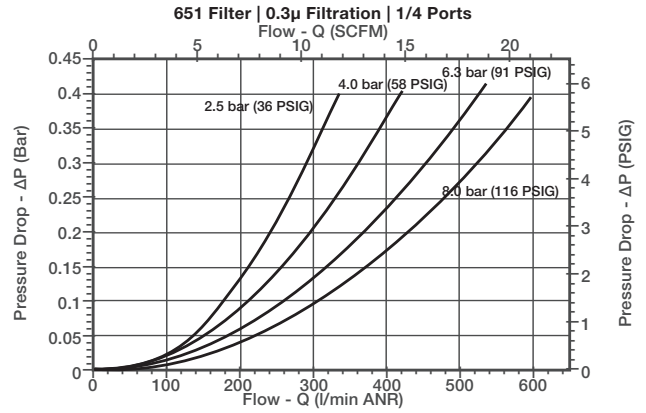
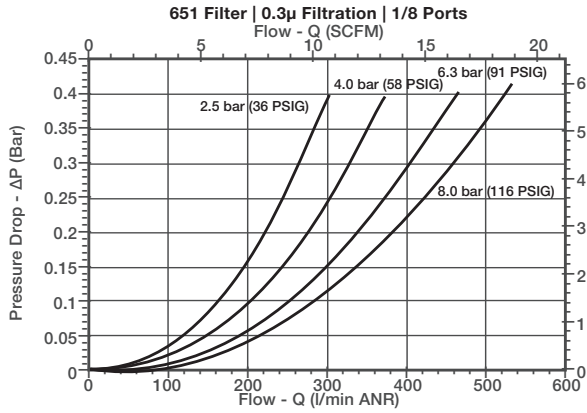

REGULATOR

- High flow with a wide range of adjustable output pressure ranges
- Available with relieving, non-relieving and internal flow check options
- Optional low profile gauge, round gauge, digital gauge or digital pressure switch
- Optional extended temperature range of -40 °F to 176 °F (-40 °C to 80 °C)
- Threaded ports allow for individual or modular mounting
- Key lockable and tamper resistant options

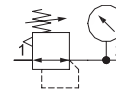

Performance Data			
Series	651	652	
Port Size	1/8, 1/4	1/4, 3/8, 1/2	
Thread Type	NPTF, G & Rc		
Nominal Flow - Per ISO 6358 P1 = 145 PSI (10 bar) Setpoint P2 = 91.4 PSI (6.3 bar) ΔP = 14.5 PSI (1 bar)	SCFM (L/min ANR)		
	1/8	28.1 (800)	-
	1/4	72.6 (2060)	144.2 (4120)
	3/8	-	228.6 (6530)
	1/2	-	245.0 (7000)
Maximum Inlet Pressure PSIG (bar) P1	232 (16)		
Adjustable Pressure Ranges PSIG (bar) P2	3 to 45 (0.2 to 3)		
	3 to 60 (0.2 to 4)		
	7 to 125 (0.5 to 8)		
	7 to 145 (0.5 to 10)		
Ambient Temperature Range °F (°C)	-4 to 122 (-20 to 50)		
Fluid Temperature Range °F (°C)	-4 to 122 (-20 to 50)		
Fluid	Air or Inert Gas		
Weight lbs (kg)	0.47 (0.215)	0.95 (0.431)	

Materials in Contact with Fluid	
Body	Aluminum
Seals	NBR/FKM
Springs	Stainless Steel

How to Order

Regulator

8 651 A R 0 0 2 F A00 G 0

Port Type

- 8 = NPTF
- G = ISO 228/1-G*
- J = ISO 7/1 Rc

Product Series

- 651
- 652

Revision

A

Product Type

- K = Regulator with Internal Flow Check (652 only)
- R = Regulator**
- W = Pilot Operated Regulator (652 only)
- K/R



Port Size

- 1 = 1/8 (651 Series)
- 2 = 1/4 (651 or 652 Series)
- 3 = 3/8 (652 Series)
- 4 = 1/2 (652 Series)

Gauge Type

- B = Digital Pressure Switch - PNP
- C = Digital Pressure Switch - NPN
- D = Digital Gauge
- F = Low Profile Gauge PSI/bar
- G = Low Profile Gauge bar/PSI
- H = Low Profile Gauge PSI/bar with Pressure Range Indicator
- J = Low Profile Gauge bar/PSI with Pressure Range Indicator
- N = No Gauge with Port Plate (1/8 NPTF)
- P = No Gauge with Port Plate (1/8 ISO 7/1 Rc)
- Q = Round Gauge bar/PSI
- R = Round Gauge PSI/bar
- 0 = No Gauge Port

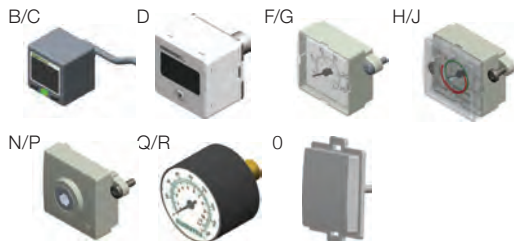

Pressure Range

- D = 3-45 PSIG/0.2-3 bar
- E = 3-60 PSIG/0.2-4 bar
- G = 7-125 PSIG/0.5-8 bar
- H = 7-145 PSIG/0.5-10 bar

Options****

- A00 = No Options
- 101 = Side Mounting Brackets
- 102 = Panel Nut
- 103 = Tamper Resistant
- 104 = Key Lockable
- 105 = High Temperature (80 °C/176 °F)
- 106 = Low Temperature (-40 °C/-40 °F)***
- 109 = FKM Seals
- 113 = Stainless Steel Fasteners
- 114 = Provision for Key Lockable Option
- 117 = ATEX Zones 1-21 ⚠
- 119 = Panel Bracket with Panel Nut
- 121 = Non-Relieving
- 122 = Bottom Oriented Pressure Adjustment
- 123 = Gauge Type Mounted for Right-to-Left Flow
- 202 = 105 + 109
- 2A9 = 105 + 106



* Conforms to ISO standards 1179-1

** Relieving Standard; use option 121 for Non-Relieving

*** Compressed air must be dry enough so no ice formation is present on the product.

**** If multiple options are required, please use the on-line CAD configurator on the website to generate the part number (www.asco.com), or consult factory.

Dimensions: mm (inches)

Dimensional Drawing - 651/652 Series Regulator

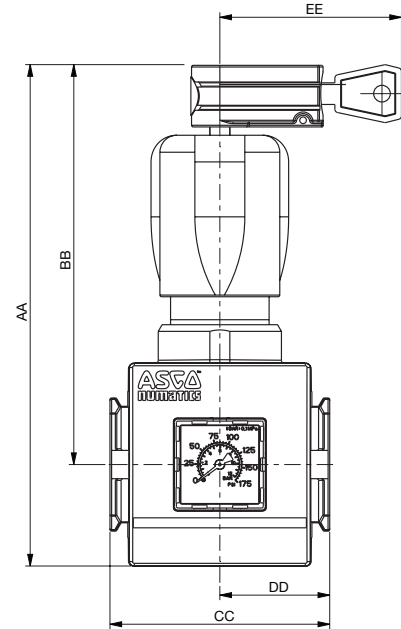
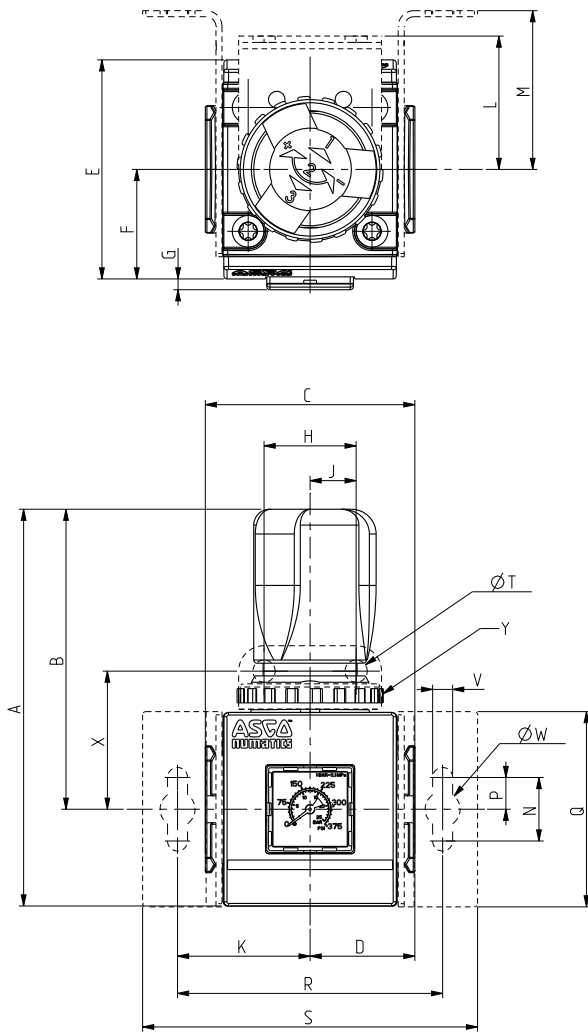

	AA	BB	CC	DD	EE
651	121.5	96	50	25	54.6
	(4.78)	(3.78)	(1.97)	(0.98)	(2.15)
652	151	120	66	33	55
	(5.94)	(4.72)	(2.60)	(1.30)	(2.17)

	A	B	C	D	E	F	G	H	J	K	L
651	103	77.5	50	25	58	29	3.4	29	14.5	35	42
	(4.06)	(3.05)	(1.97)	(0.98)	(2.28)	(1.14)	(0.13)	(1.14)	(0.57)	(1.38)	(1.65)
652	125	94.5	66	33	69	34.5	2.5	29	14.5	41.75	42
	(4.92)	(3.72)	(2.60)	(1.30)	(2.72)	(1.36)	(0.10)	(1.14)	(0.57)	(1.64)	(1.65)

	M	N	P	Q	R	S	ØT	V	ØW	X	Y
651	44.5	20	10	50	70	92	7	6.3	11	39.1	M30 x 2
	(1.75)	(0.79)	(0.39)	(1.97)	(2.76)	(3.62)	(0.28)	(0.25)	(0.43)	(1.54)	-
652	50	20	10	61.5	84	106	7	6.3	11	43.5	M37 x 2
	(1.97)	(0.79)	(0.39)	(2.42)	(3.31)	(4.17)	(0.28)	(0.25)	(0.43)	(1.71)	-

Cross Section - 651/652 Series Regulator

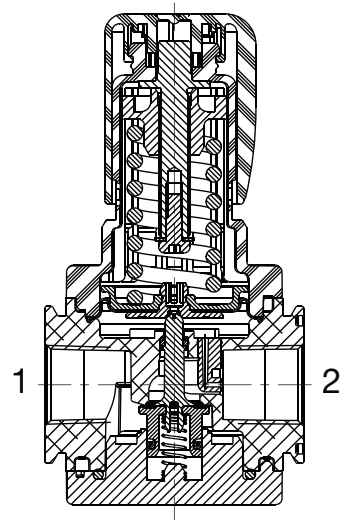

Regulator Flow Charts

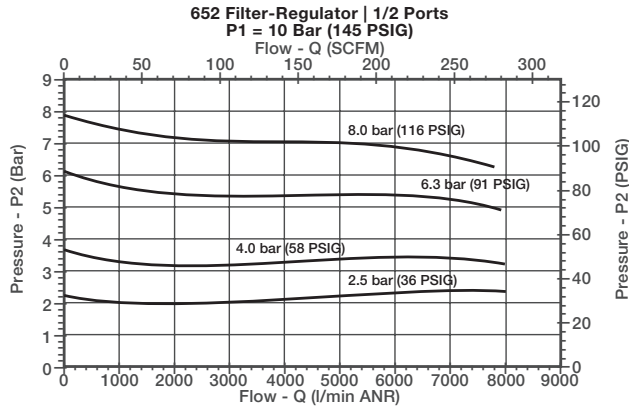
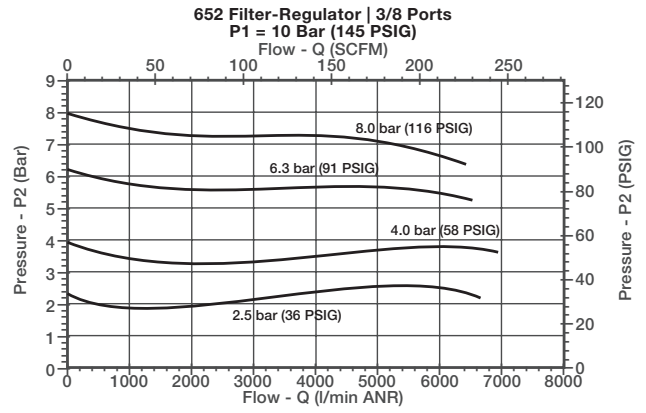
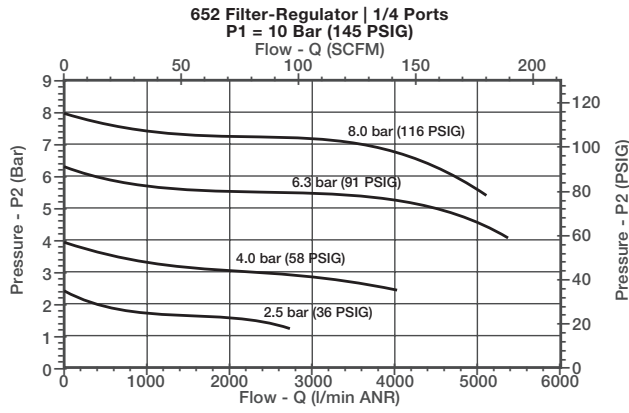
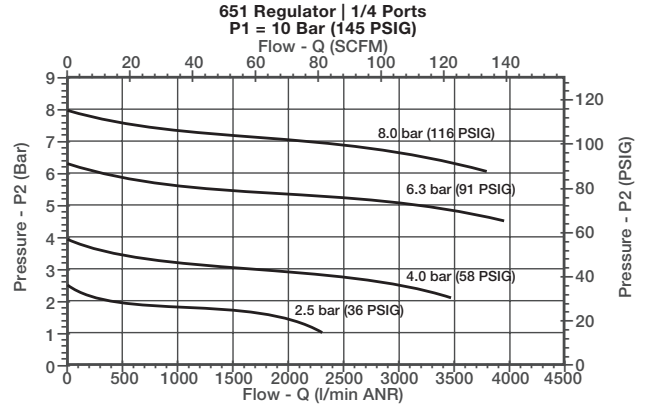
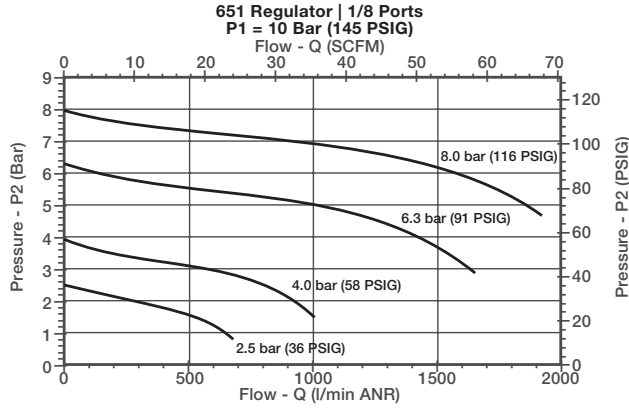

MANIFOLD REGULATOR

- High flow with a wide range of adjustable output pressure ranges
- Allows for a common inlet supply pressure within the regulator manifold, while maintaining several adjustable output pressures
- Optional low profile gauge, round gauge, digital gauge and digital pressure switch
- Optional extended temperature range of -40 °F to 176 °F (-40 °C to 80 °C)
- Key lockable and tamper proof options

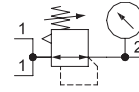

Performance Data			
Series		651	652
Port Sizes	P1 (Inlet)	1/4	1/2
	P2 (Outlet)	1/8	3/8
Thread Type		NPTF, G & Rc	
Nominal Flow - Per ISO 6358		SCFM (L/min ANR)	
P1 = 145 PSI (10 bar) Setpoint P2 = 91.4 PSI (6.3 bar) ΔP = 14.5 PSI (1 bar)		29.5 (840)	280 (8000)
Maximum Pressure PSIG (bar) P1		232 (16)	
Adjustable Pressure Ranges PSI (bar) P2		3 to 45 (0.2 to 3)	
		3 to 60 (0.2 to 4)	
		7 to 125 (0.5 to 8)	
		7 to 145 (0.5 to 10)	
Ambient Temperature Range °F (°C)		-4 to 122 (-20 to 50)	
Fluid Temperature Range °F (°C)		-4 to 122 (-20 to 50)	
Fluid		Air or Inert Gas	
Weight lbs (kg)		0.47 (0.215)	0.93 (0.422)

Materials in Contact with Fluid	
Body	Aluminum
Seals	NBR/FKM
Springs	Stainless Steel

How to Order

Manifold Regulator

8 651 A M 0 0 2 F A00 G 0

Port Type
 8 = NPTF
 G = ISO 228/1-G*
 J = ISO 7/1 Rc

Product Series
 651
 652

Revision
 A

Product Type
 M = Manifold Regulator**



Port Size
 2 = 1/4 In (1/8 Out) (651 Series)
 4 = 1/2 In (3/8 Out) (652 Series)

Gauge Type
 B = Digital Pressure Switch - PNP
 C = Digital Pressure Switch - NPN
 D = Digital Gauge
 F = Low Profile Gauge PSI/bar
 G = Low Profile Gauge bar/PSI
 H = Low Profile Gauge PSI/bar with Pressure Range Indicator
 J = Low Profile Gauge bar/PSI with Pressure Range Indicator
 N = No Gauge with Port Plate (1/8 NPTF)
 P = No Gauge with Port Plate (1/8 ISO 7/1 Rc)
 Q = Round Gauge bar/PSI
 R = Round Gauge PSI/bar
 0 = No Gauge Port

B/C D F/G H/J



N/P Q/R 0



Pressure Range
 D = 3-45 PSIG/0.2-3 bar
 E = 3-60 PSIG/0.2-4 bar
 G = 7-125 PSIG/0.5-8 bar
 H = 7-145 PSIG/0.5-10 bar

Options****

- A00 = No Options
- 101 = Side Mounting Brackets
- 102 = Panel Nut
- 103 = Tamper Resistant
- 104 = Key Lockable
- 105 = High Temperature (80 °C/176 °F)
- 106 = Low Temperature (-40 °C/-40 °F)***
- 109 = FKM Seals
- 113 = Stainless Steel Fasteners
- 114 = Provision for Key Lockable Option
- 117 = ATEX Zones 1-21 ⚠
- 119 = Panel Bracket with Panel Nut
- 121 = Non-Relieving
- 122 = Bottom Oriented Pressure Adjustment
- 123 = Gauge Type Mounted for Right-to-Left Flow

202 = 105 + 109
 2A9 = 105 + 106



* Conforms to ISO standards 1179-1

** Relieving Standard; use option 121 for Non-Relieving

*** Compressed air must be dry enough so no ice formation is present on the product.

**** If multiple options are required, please use the on-line CAD configurator on the website to generate the part number (www.asco.com), or consult factory.

Dimensions: mm (inches)

Dimensional Drawing - 651/652 Series Manifold Regulator

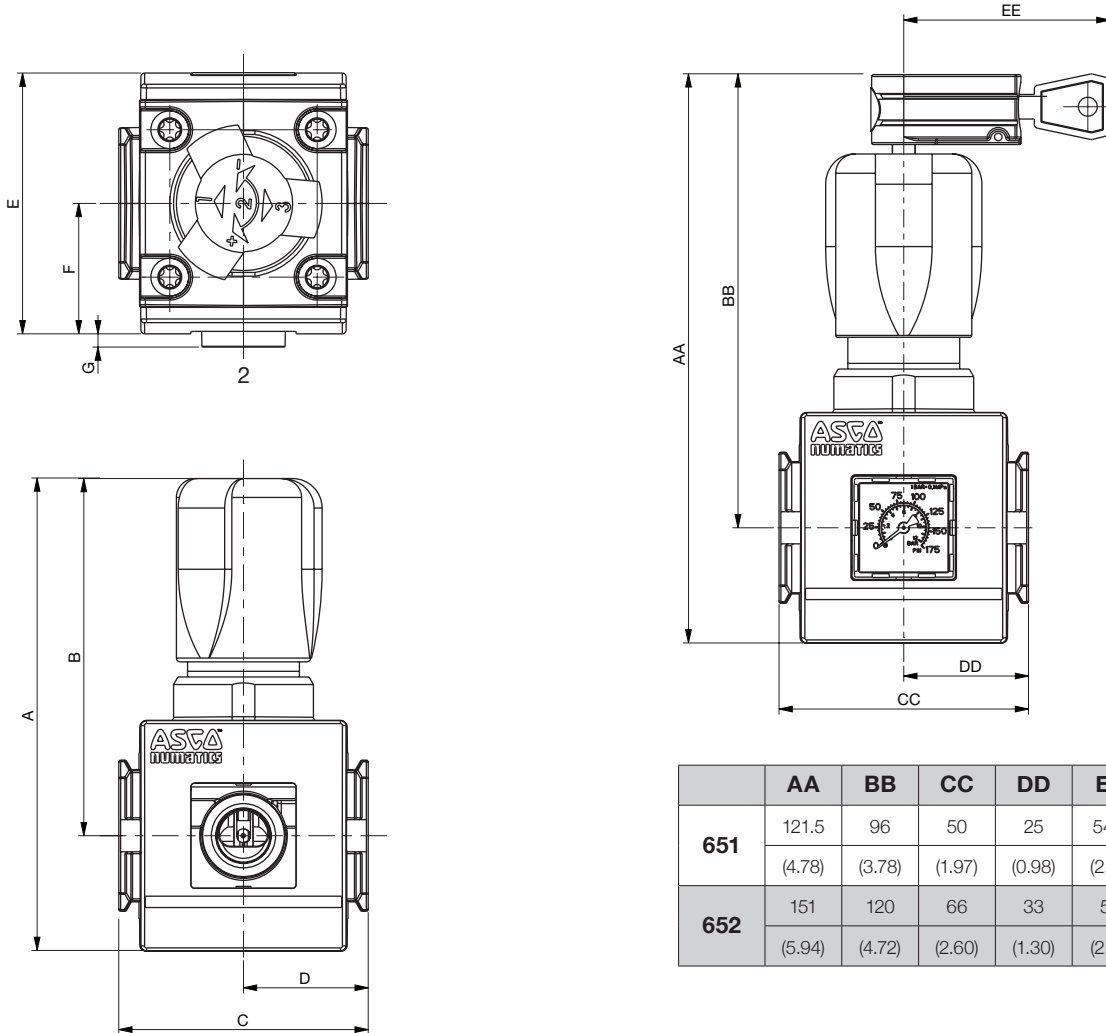

	AA	BB	CC	DD	EE
651	121.5	96	50	25	54.6
	(4.78)	(3.78)	(1.97)	(0.98)	(2.15)
652	151	120	66	33	55
	(5.94)	(4.72)	(2.60)	(1.30)	(2.17)

	A	B	C	D	E	F	G
651	103	77.5	50	25	58	29	0.3
	(4.06)	(3.05)	(1.97)	(0.98)	(2.28)	(1.14)	(0.01)
652	125	94.5	66	33	69	34.5	3.5
	(4.92)	(3.72)	(2.60)	(1.30)	(2.72)	(1.36)	(0.14)

Cross Section - 651/652 Series Manifold Regulator

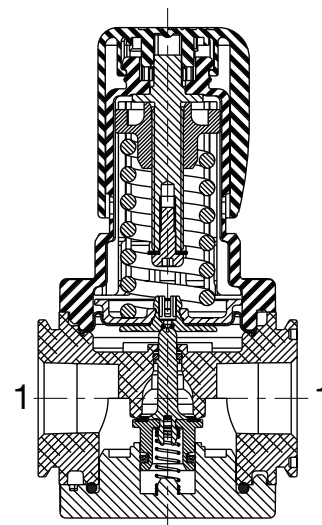

PARTICULATE FILTER/REGULATOR

- High flow with a wide range of adjustable output pressure ranges
- Optional low profile gauge, round gauge, digital gauge or digital pressure switch
- Optional extended temperature range of -40 °F to 176 °F (-40 °C to 80 °C)
- Sintered polyethylene elements, with centrifugal separator, include 5, 25 and 40 Microns
- Threaded ports allow for individual or modular mounting
- Innovative two position plastic drain with manual and semi-automatic functions. Additional drains include an automatic style (brass) and manual (stainless steel)
- Polycarbonate and Aluminum bowls with a selection of sight gauge materials that meet industry and application requirements
- Key lockable and tamper resistant models
- Air purity class according to ISO 8573-1: 2010

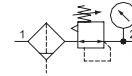

Performance Data					
Series		651		652	
Port Sizes		1/8, 1/4		1/4, 3/8, 1/2	
Thread Type		NPTF, G & Rc			
Nominal Flow - Per ISO 6358 P1 = 145 PSI (10 bar) Setpoint P2 = 91.4 PSI (6.3 bar) ΔP = 14.5 PSI (1 bar)		Micron Rating	SCFM (L/min ANR)		
			1/8	5μ	25.1 (710)
		25μ		25.8 (730)	-
		40μ		28.5 (800)	-
		1/4	5μ	79.1 (2240)	133.0 (3800)
			25μ	83.4 (2360)	144.2 (4120)
			40μ	100.1 (2840)	150.5 (4300)
		3/8	5μ	-	155.8 (4450)
			25μ	-	189.7 (5420)
			40μ	-	196 (5590)
		1/2	5μ	-	157.2 (4490)
			25μ	-	192.5 (5500)
			40μ	-	203.0 (5800)
Maximum Inlet Pressure PSIG (bar) P1		Polycarbonate Bowl	232 (16)		
		Aluminum Bowl	232 (16)		
Adjustable Pressure Ranges PSIG (bar) P2		3 to 45 (0.2 to 3)			
		3 to 60 (0.2 to 4)			
		7 to 125 (0.5 to 8)			
		7 to 145 (0.5 to 10)			
Ambient Temperature Range °F (°C)		-4 to 122 (-20 to 50)			
Fluid Temperature Range °F (°C)		-4 to 122 (-20 to 50)			
Fluid		Air or Inert Gas			
Weight lbs (kg)		w/Polycarbonate Bowl	0.617 (0.304)	1.20 (0.546)	
		w/Aluminum Bowl	0.989 (0.449)	1.52 (0.688)	

Materials in Contact with Fluid	
Body	Aluminum
Seals	NBR/FKM
Springs	Stainless Steel
Filter Element	Sintered Polyethylene
Bowl	Polycarbonate or Aluminum

Air Purity Class - ISO 8573-1: 2010*	
5μ	(5:8:4)
25μ	(6:8:4)
40μ	(7:8:4)

How to Order

Particulate Filter/Regulator

8 651 A P B P 2 F A00 G N

Port Type
 8 = NPTF
 G = ISO 228/1-G*
 J = ISO 7/1 Rc

Product Series
 651
 652

Revision
 A

Product Type
 P = Filter/Regulator - Particulate

Elements
 A = 40 Micron (Green)
 B = 5 Micron (White)
 J = 25 Micron (Yellow)

Bowl Type
 K = Metal Bowl without Sight Gauge
 L = Metal Bowl with Sight Gauge (Glass)
 M = Metal Bowl with Sight Gauge (Polyamide)
 N = Polycarbonate Bowl without Bowl Guard (651 only)
 P = Polycarbonate Bowl with Bowl Guard

Port Size
 1 = 1/8 (651 Series)
 2 = 1/4 (651 or 652 Series)
 3 = 3/8 (652 Series)
 4 = 1/2 (652 Series)

Gauge Type
 B = Digital Pressure Switch - PNP
 C = Digital Pressure Switch - NPN
 D = Digital Gauge
 F = Low Profile Gauge PSI/bar
 G = Low Profile Gauge bar/PSI
 H = Low Profile Gauge PSI/bar with Pressure Range Indicator
 J = Low Profile Gauge bar/PSI with Pressure Range Indicator
 N = No Gauge with Port Plate (1/8 NPTF)
 P = No Gauge with Port Plate (1/8 ISO 7/1 Rc)
 Q = Round Gauge bar/PSI
 R = Round Gauge PSI/bar
 0 = No Gauge Port

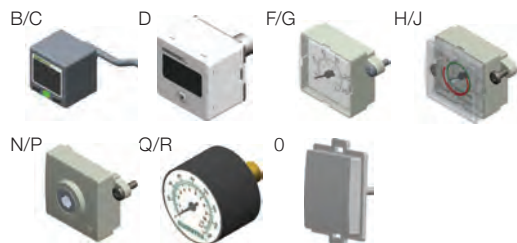

Drain Type

- 0 = No Drain
- A = Auto Drain Normally Open
- N = Manual - Semi-Automatic Drain
- Q = Manual Drain - Stainless Steel



Pressure Range

- D = 3-45 PSIG/0.2-3 bar
- E = 3-60 PSIG/0.2-4 bar
- G = 7-125 PSIG/0.5-8 bar
- H = 7-145 PSIG/0.5-10 bar

Options***

- A00 = No Options
- 101 = Side Mounting Brackets
- 102 = Panel Nut
- 103 = Tamper Resistant
- 104 = Key Lockable
- 105 = High Temperature (80 °C/176 °F)
- 106 = Low Temperature (-40 °C/-40 °F)**
- 109 = FKM Seals
- 113 = Stainless Steel Fasteners (652 only)
- 114 = Provision for Key Lockable Option
- 117 = ATEX Zones 1-21
- 119 = Panel Bracket with Panel Nut
- 121 = Non-Relieving
- 123 = Gauge Type Mounted for Right-to-Left Flow
- 202 = 105 + 109
- 2A9 = 105 + 106



* Conforms to ISO standards 1179-1

** Compressed air must be dry enough so no ice formation is present on the product. All bowls should be emptied prior to ambient temperatures dropping below 32 °F (0 °C)

*** If multiple options are required, please use the on-line CAD configurator on the website to generate the part number (www.asco.com), or consult factory.

Dimensions: mm (inches)

Dimensional Drawing - 651/652 Series Particulate Filter/Regulator

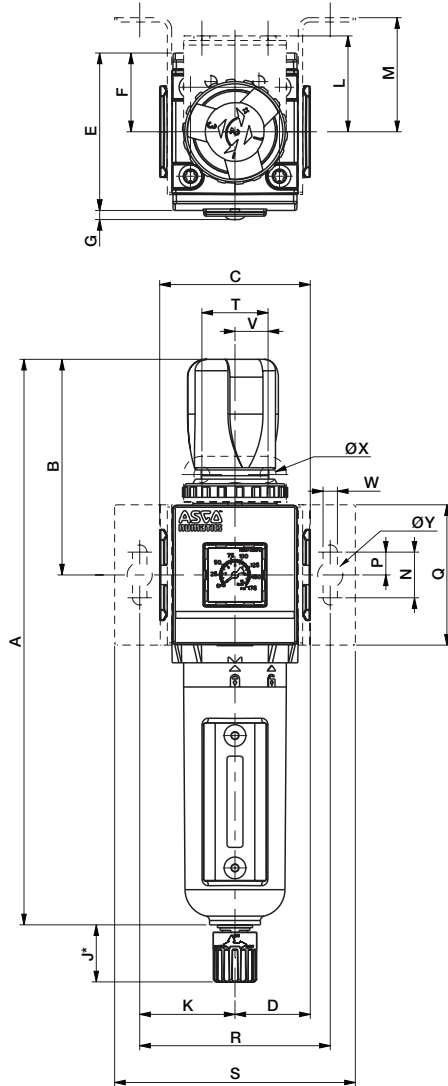

Cross Section - 651/652 Series Particulate Filter/Regulator

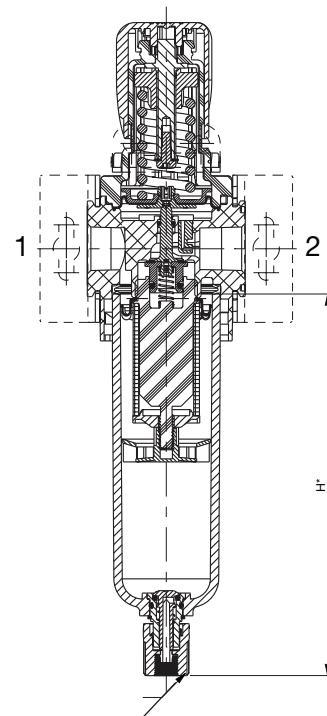

To remove bowl allow:
651 - 44mm (1.8in)
652 - 75mm (3.0in)
from the bottom of
the bowl drain.

	A	B	C	D	E	F	G	H	J	K	L
651	215.5	77.5	50	25	58	29	3.4	116	25	35	42
	(8.48)	(3.05)	(1.97)	(0.98)	(2.28)	(1.14)	(0.13)	(4.57)	(0.98)	(1.38)	(1.65)
652	248	94.5	66	33	69	30.5	4	160	25	41.75	42
	(9.76)	(3.72)	(2.60)	(1.30)	(2.72)	(1.20)	(0.16)	(6.30)	(0.98)	(1.64)	(1.65)

	M	N	P	Q	R	S	T	V	W	ØX	ØY
651	44.5	20	10	50	70	92	29	14.5	6.3	7	11
	(1.75)	(0.79)	(0.39)	(1.97)	(2.76)	(3.62)	(1.14)	(0.57)	(0.25)	(0.28)	(0.43)
652	50	20	10	61.5	84	105.5	29	14.5	6.3	7	11
	(1.97)	(0.79)	(0.39)	(2.42)	(3.31)	(4.15)	(1.14)	(0.57)	(0.25)	(0.28)	(0.43)

* Variable dimension based on type of drain that is specified; If an Automatic Drain is specified, add another 5mm to "J" dimension.

Particulate Filter/Regulator Flow Charts

651 Filter-Regulator | 5µ Filtration | 1/8 Ports
P1 = 10 Bar (145 PSIG)

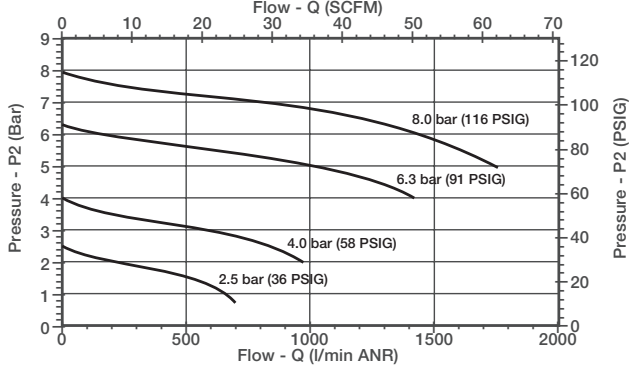

651 Filter-Regulator | 5µ Filtration | 1/4 Ports
P1 = 10 Bar (145 PSIG)

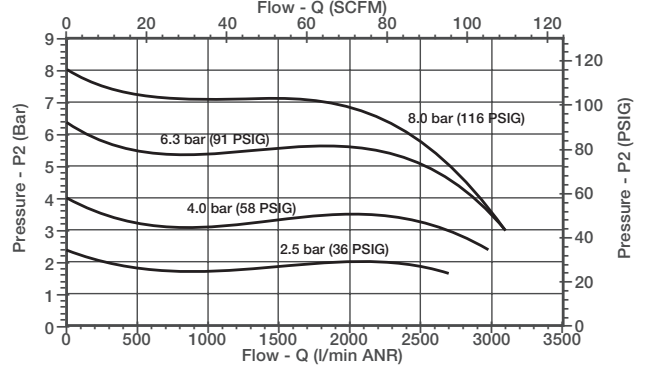

652 Filter-Regulator | 5µ Filtration | 1/4 Ports
P1 = 10 Bar (145 PSIG)

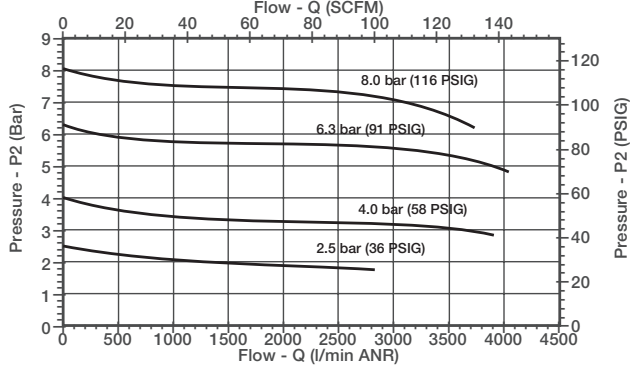

652 Filter-Regulator | 5µ Filtration | 3/8 Ports
P1 = 10 Bar (145 PSIG)

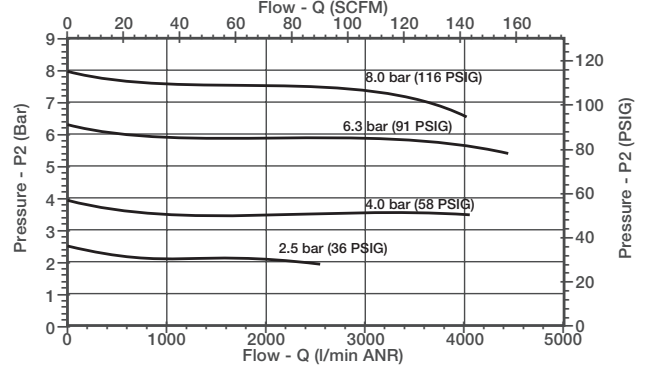

652 Filter-Regulator | 5µ Filtration | 1/2 Ports
P1 = 10 Bar (145 PSIG)

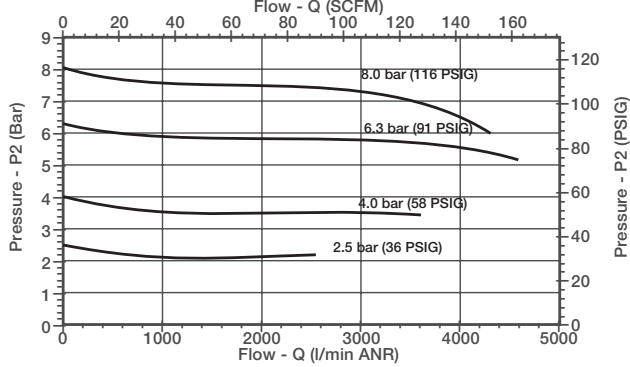

COALESCING FILTER/REGULATOR

- Extensive range of coalescing filter elements to remove oil and sub-micron particles down to 0.01 microns. Air purity class according to ISO 8573-1: 2010
- Optional 3 micron pre-filter integrated in the coalescing element eliminates the need for a separate particulate element.
- Optional low profile gauge, round gauge, digital gauge or digital pressure switch
- Optional extended temperature range up to 176 °F (80 °C)
- Threaded ports allow for individual or modular mounting
- Innovative two position plastic drain with manual and semi-automatic functions
Additional drains include an automatic style (brass) and manual (stainless steel)
- Polycarbonate and Aluminum bowls with a selection of sight gauge materials that meet industry and application requirements
- Key lockable and tamper proof models

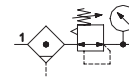

Performance Data				
Series	651		652	
Port Sizes	1/8, 1/4		1/4, 3/8, 1/2	
Thread Type	NPTF, G & Rc			
Nominal Flow - Per ISO 6358 P1 = 145 PSI (10 bar) Setpoint P2 = 91.4 PSI (6.3 bar) ΔP = 5 PSI (0.35 bar)	1/8	Micron Rating	SCFM (L/min ANR)	
		0.3 μm	8.5 (240)	-
	1/4	0.01 μm	5.9 (170)	-
		0.3 μm	10.3 (290)	11.3 (320)
	3/8	0.01 μm	7.2 (200)	10.2 (290)
		0.3 μm	-	20.5 (580)
	1/2	0.01 μm	-	18.9 (540)
		0.3 μm	-	20.8 (590)
Maximum /Inlet Pressure PSIG (bar) P1	Polycarbonate Bowl	232 (16)		
	Aluminum Bowl	232 (16)		
Adjustable Pressure Ranges PSIG (bar) P2	3 to 45 (0.2 to 3)			
	3 to 60 (0.2 to 4)			
	7 to 125 (0.5 to 8)			
	7 to 145 (0.5 to 10)			
Ambient Temperature Range °F (°C)	35 to 122 (1.7 to 50)			
Fluid Temperature Range °F (°C)	35 to 122 (1.7 to 50)			
Fluid	Air or Inert Gas			
Weight lbs (kg)	w/Polycarbonate Bowl	0.679 (0.308)	1.24 (0.564)	
	w/Aluminum Bowl	0.999 (0.453)	1.55 (0.705)	

Materials in Contact with Fluid	
Body	Aluminum
Seals	NBR/FKM
Springs	Stainless Steel
Filter Element	Borosilicate Microfiber & Polyester
Filter Element End Cap	Polypropylene
Bowl	Polycarbonate or Aluminum

Air Purity Class - ISO 8573-1: 2010*	
0.3 μm	(3:7:3)
0.01 μm	(2:7:2)

* 651 Series maximum flow at 91.4 PSI (6.3 bar) inlet pressure to maintain air purity class is 3.5 SCFM (100 L/min)

* 652 Series maximum flow at 91.4 PSI (6.3 bar) inlet pressure to maintain air purity class is 10.6 SCFM (303 L/min)

How to Order

Coalescing Filter/Regulator

- 8 651 A C D P 2 F A00 G N**
- Port Type**
 8 = NPTF
 G = ISO 228/1-G*
 J = ISO 7/1 Rc
- Product Series**
 651
 652
- Revision**
 A
- Product Type**
 C = Filter/Regulator - Coalescing
- Elements**
 D = 0.3 Micron - Coalescer (Green)
 E = 0.01 Micron - Coalescer (Red)
 M = 0.3 Micron Coalescer with 3 Micron Prefilter (Green)
 N = 0.01 Micron Coalescer with 3 Micron Prefilter (Red)
- Bowl Type**
 K = Metal Bowl without Sight Gauge
 L = Metal Bowl with Sight Gauge (Glass)
 M = Metal Bowl with Sight Gauge (Polyamide)
 N = Polycarbonate Bowl without Bowl Guard (651 only)
 P = Polycarbonate Bowl with Bowl Guard
- Port Size**
 1 = 1/8 (651 Series)
 2 = 1/4 (651 or 652 Series)
 3 = 3/8 (652 Series)
 4 = 1/2 (652 Series)
- Gauge Type**
 B = Digital Pressure Switch - PNP
 C = Digital Pressure Switch - NPN
 D = Digital Gauge
 F = Low Profile Gauge PSI/bar
 G = Low Profile Gauge bar/PSI
 H = Low Profile Gauge PSI/bar with Pressure Range Indicator
 J = Low Profile Gauge bar/PSI with Pressure Range Indicator
 N = No Gauge with Port Plate (1/8 NPTF)
 P = No Gauge with Port Plate (1/8 ISO 7/1 Rc)
 Q = Round Gauge bar/PSI
 R = Round Gauge PSI/bar
 0 = No Gauge Port

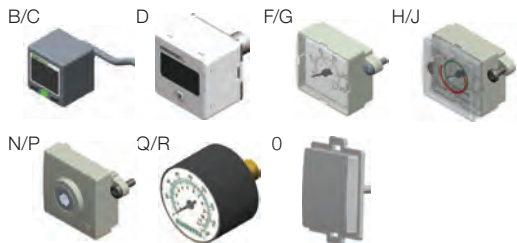

- Drain Type**
 0 = No Drain
 A = Auto Drain Normally Open
 N = Manual - Semi-Automatic Drain
 Q = Manual Drain - Stainless Steel



- Pressure Range**
 D = 3-45 PSIG/0.2-3 bar
 E = 3-60 PSIG/0.2-4 bar
 G = 7-125 PSIG/0.5-8 bar
 H = 7-145 PSIG/0.5-10 bar

- Options****
 A00 = No Options
 101 = Side Mounting Brackets
 102 = Panel Nut
 103 = Tamper Resistant
 104 = Key Lockable
 105 = High Temperature (80 °C/176 °F)
 109 = FKM Seals
 113 = Stainless Steel Fasteners (652 only)
 114 = Provision for Key Lockable Option
 117 = ATEX Zones 1-21 ⚠
 119 = Panel Bracket with Panel Nut
 121 = Non-Relieving
 123 = Gauge Type Mounted for Right-to-Left Flow
 202 = 105 + 109



* Conforms to ISO standards 1179-1
 ** If multiple options are required, please use the on-line CAD configurator on the website to generate the part number (www.asco.com), or consult factory.

Dimensions: mm (inches)

Dimensional Drawing - 651/652 Series Coalescing Filter/Regulator

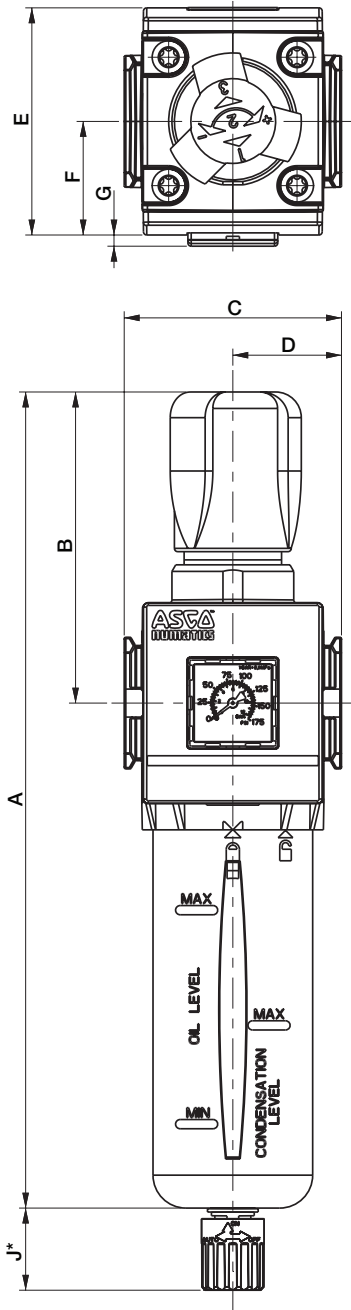

Cross Section - 651/652 Series Coalescing Filter/Regulator

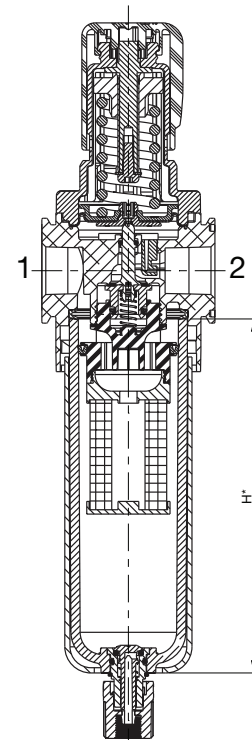

To remove bowl allow:
651 - 60mm (2.4in)
652 - 80mm (3.2in)
from the bottom of
the bowl drain.

	A	B	C	D	E	F	G	H	J
651	215.5	77.5	50	25	58	29	3.4	116	25
	(8.48)	(3.05)	(1.97)	(0.98)	(2.28)	(1.14)	(0.13)	(4.57)	(0.98)
652	248	94.5	66	33	69	30.5	2.5	135	25
	(9.76)	(3.72)	(2.60)	(1.30)	(2.72)	(1.20)	(0.10)	(5.31)	(0.98)

* Variable dimension based on type of drain that is specified; If an Automatic Drain is specified, add another 5mm to "J" dimension.

Coalescing Filter/Regulator Flow Charts

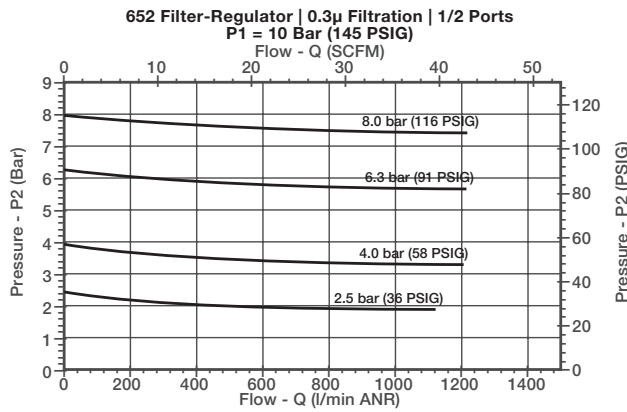
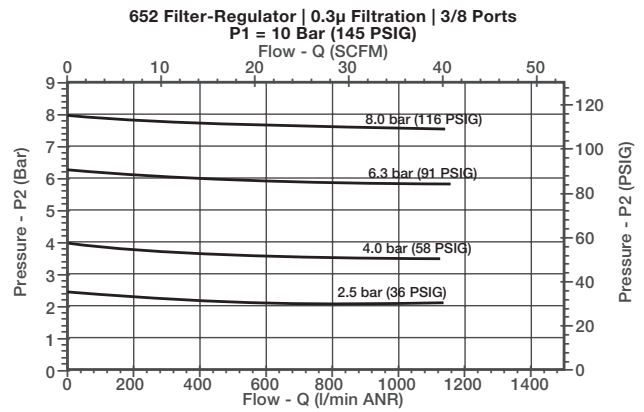
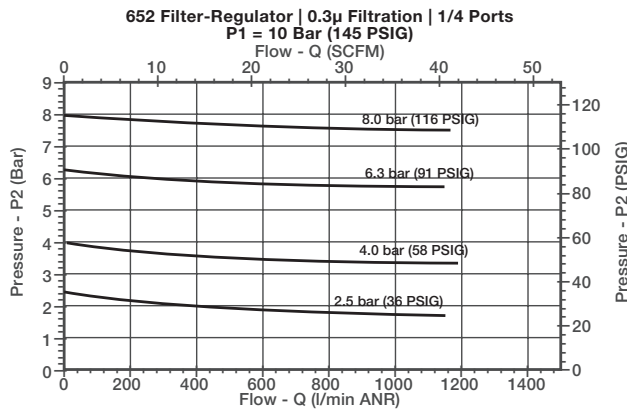
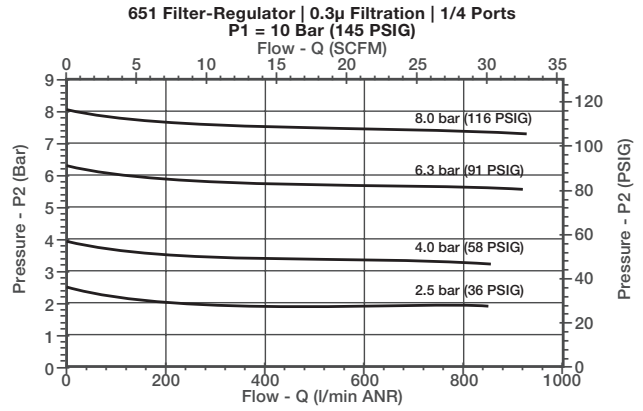
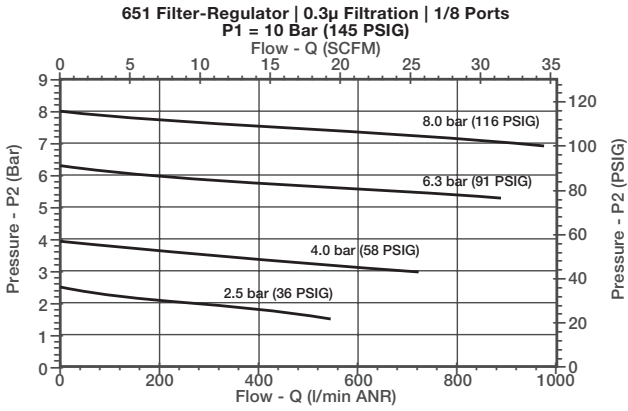

LUBRICATOR

- Provides consistent reliable lubrication to the system
- Uses venturi type technology to distribute the lubrication into the compressed air line
- Optional electronic liquid level indicator provides condition monitoring
- Allows fill while under pressure from fill port or bowl by removing the fill plug
- Polycarbonate and Aluminum bowls with a selection of sight gauge materials that meet industry and application requirements
- Recommended oil type: Non-detergent type and without aggressive additives (VG32 - ISO3448)
- Threaded ports allow for individual or modular mounting



Performance Data			
Series		651	652
Port Sizes		1/8, 1/4	1/4, 3/8, 1/2
Thread Type		NPTF, G & Rc	
		SCFM (L/min ANR)	
Nominal Flow - Per ISO 6358 P1 = 91.4 PSI (6.3 bar) ΔP = 11.6 PSI (0.8 bar)	1/8	31.8 (900)	-
	1/4	68.5 (1940)	97.3 (2780)
	3/8	-	175.0 (5000)
	1/2	-	178.5 (5100)
Maximum Pressure PSIG (bar)	Polycarbonate Bowl	145 (10)	
	Aluminum Bowl	145 (10)	
Minimum Flow for Lubrication SCFM (L/min)		0.16 (4.5)	0.71 (20)
Ambient Temperature Range °F (°C)		-4 to 122 (-20 to 50)	
Fluid Temperature Range °F (°C)		-4 to 122 (-20 to 50)	
Fluid		Air or Inert Gas	
Bowl Capacity mL (fluid oz.)		42 (1.42)	72 (2.43)
Weight lbs (kg)	Polycarbonate Bowl	0.529 (0.240)	1.16 (0.526)
	Aluminum Bowl	0.736 (0.334)	1.47 (0.667)

Materials in Contact with Fluid	
Body	Aluminum
Seals	NBR/FKM

How to Order

Lubricator

8 651 A L 0 P 2 0 A00 0 0

Port Type

- 8 = NPTF
- G = ISO 228/1-G*
- J = ISO 7/1 Rc

Product Series

- 651
- 652

Revision

A

Product Type

- L = Lubricator

Bowl Type

- K = Metal Bowl without Sight Gauge
- L = Metal Bowl with Sight Gauge (Glass)
- M = Metal Bowl with Sight Gauge (Polyamide)
- N = Polycarbonate Bowl without Bowl Guard (651 only)
- P = Polycarbonate Bowl with Bowl Guard



Options**

- A00 = No Options
- 101 = Side Mounting Brackets
- 108 = Liquid Level Indicator - Electronic
- 109 = FKM Seals
- 117 = ATEX Zones 1-21 



Port Size

- 1 = 1/8 (651 Series)
- 2 = 1/4 (651 or 652 Series)
- 3 = 3/8 (652 Series)
- 4 = 1/2 (652 Series)

* Conforms to ISO standards 1179-1

** If multiple options are required, please use the on-line CAD configurator on the website to generate the part number (www.asco.com), or consult factory.

Dimensions: mm (inches)

Dimensional Drawing - 651/652 Series Lubricator

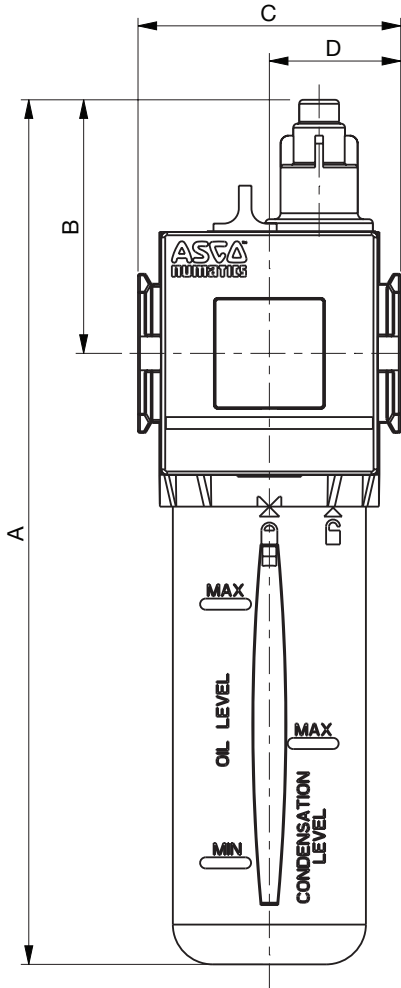
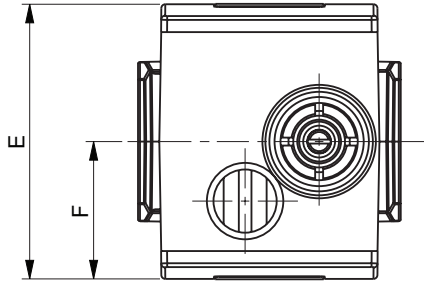

Cross Section - 651/652 Series Lubricator

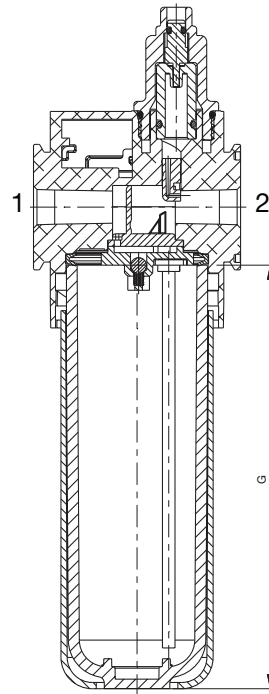

To remove bowl allow:
651 Series - 20mm (0.8in)
652 Series - 25mm (1.0in)
from the bottom of the bowl.

	A	B	C	D	E	F	G
651	198	58	50	25	58	29	116
	(7.80)	(2.28)	(1.97)	(0.98)	(2.28)	(1.14)	(4.57)
652	217	64	66	33	69	30.5	135
	(8.54)	(2.52)	(2.60)	(1.30)	(2.72)	(1.20)	(5.31)

SHUT-OFF ISOLATION VALVE

- Robust and easy-to-operate shut-off valve, with lockout (front or back) on handle
- Provides shut-off to downstream machinery
- Optional low profile gauge provides clear indication of the downstream pressure, and when the downstream components can be safely removed when pressure (P2) is at zero
- Available as 3/2 or 2/2 construction
- Threaded ports allow for individual or modular mounting

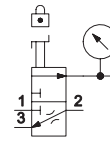

Performance Data					
Series	651		652		
Port Sizes	1/8, 1/4		1/4, 3/8, 1/2		
Thread Type	NPTF, G & Rc				
Nominal Flow - Per ISO 6358 P1 = 91.4 PSI (6.3 bar) ΔP = 14.5 PSI (1 bar)	SCFM (L/min ANR)				
		1 → 2	2 → 3	1 → 2	2 → 3
	1/8	50.8 (1440)	8.83 (250)	-	-
	1/4	166.7 (4720)	8.83 (250)	151 (4300)	8.05 (230)
	3/8	-	-	308 (8800)	8.05 (230)
	1/2	-	-	400 (11400)	8.05 (230)
Maximum Inlet Pressure PSIG (bar)	232 (16)				
Ambient Temperature Range °F (°C)	14 to 122 (-10 to 50)				
Fluid Temperature Range °F (°C)	14 to 122 (-10 to 50)				
Fluid	Air or Inert Gas				
Weight lbs (kg)	0.57 (0.260)		0.97 (0.438)		

Materials in Contact with Fluid	
Body	Aluminum
Ball	Zinc Plated Steel
Seat	PTFE
Seals	NBR/FKM

How to Order

Shut-Off Isolation Valve

8 651 A 3 M 0 2 F A00 00

Port Type

- 8 = NPTF
- G = ISO 228/1-G*
- J = ISO 7/1 Rc

Product Series

- 651
- 652

Revision

- A

Product Type

- 2 = 2/2 - Shut Off Valve
- 3 = 3/2 - Shut Off Valve

Valve Type

- M = Manually Operated Ball Valve with Lockout

Pilot Valve/Electrical Connection

- 0 = No Electrical Connection

Port Size

- 1 = 1/8 (651 Series)
- 2 = 1/4 (651 or 652 Series)
- 3 = 3/8 (652 Series)
- 4 = 1/2 (652 Series)

* Conforms to ISO standards 1179-1

** If multiple options are required, please use the on-line CAD configurator on the website to generate the part number (www.asco.com), or consult factory.

Options**

- A00 = No Options
- 101 = Side Mounting Brackets
- 109 = FKM Seals
- 111 = Metal Muffler
- 112 = Polyethylene Muffler
- 113 = Stainless Steel Fasteners
- 115 = Scissor Lock
- 117 = ATEX Zones 1-21 
- 122 = Bottom Oriented Pressure Adjustment
- 123 = Gauge Type Mounted for Right-to-Left Flow
- 2B9 = 111 + 115



Gauge Type

- F = Low Profile Gauge PSI/bar
- G = Low Profile Gauge bar/PSI
- H = Low Profile Gauge PSI/bar with Pressure Range Indicator
- J = Low Profile Gauge bar/PSI with Pressure Range Indicator
- N = No Gauge with Port Plate (1/8 NPTF)
- P = No Gauge with Port Plate (1/8 ISO 7/1 Rc)
- Q = Round Gauge bar/PSI
- R = Round Gauge PSI/bar
- 0 = No Gauge Port

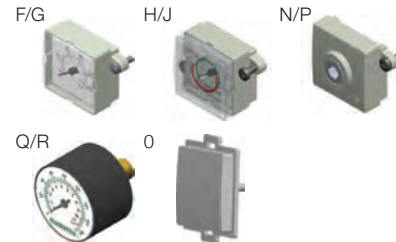

Dimensions: mm (inches)

Dimensional Drawing - 651/652 Series Shut-Off Isolation Valve

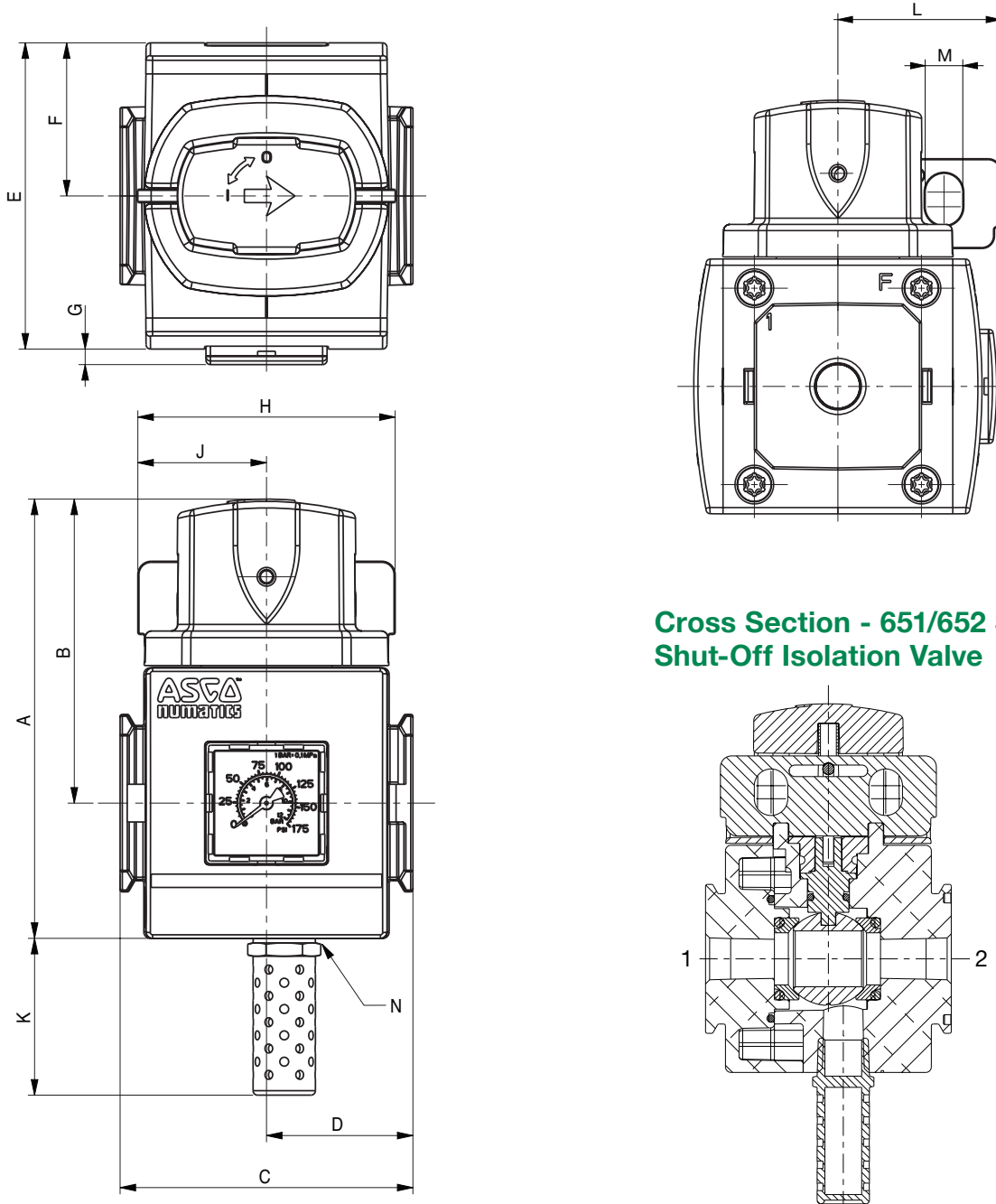

Cross Section - 651/652 Series Shut-Off Isolation Valve

	A	B	C	D	E	F	G	H	J	K	L	M	N
651	90.5	65.5	50	25	58	29	4.4	57.8	28.9	35.5	38	9	-
	(3.56)	(2.58)	(1.97)	(0.98)	(2.28)	(1.14)	(0.17)	(2.28)	(1.14)	(1.40)	(1.50)	(0.35)	1/4 NPTF or 1/4 ISO 228/1-G
652	99	68	66	33	69	34.5	2.5	58	29	35	39	9	-
	(3.90)	(2.68)	(2.60)	(1.30)	(2.72)	(1.36)	(0.10)	(2.28)	(1.14)	(1.38)	(1.54)	(0.35)	1/4 NPTF or 1/4 ISO 228/1-G

SLOW-START/ QUICK EXHAUST VALVE

- High exhaust capacity for quick depletion of downstream pressure
- Slow Starts provide gradual increase of downstream pressure and full flow once 70% of inlet pressure is reached
- Threaded ports allow for individual or modular mounting
- Manual override (momentary-pulse type) is standard when using the horizontal solenoid operator
- Optional extended temperature range of -40 °F to 176 °F (-40 °C to 80 °C); for air piloted models only (excludes solenoid operators)
- Constructions includes: 3/2 Quick Exhaust, 3/2 Slow-Start/Quick-Exhaust, and 2/2 Slow Start
- Electrical connections: Coil with DIN terminals; DIN Plug, DIN Plug with LED, and coil with built-in M12 3 Pin male connection (24 VDC)
- Voltages: 24 VDC, 120/60 & 115/50 VAC, 230-50/60 VAC, 24-50/60 VAC

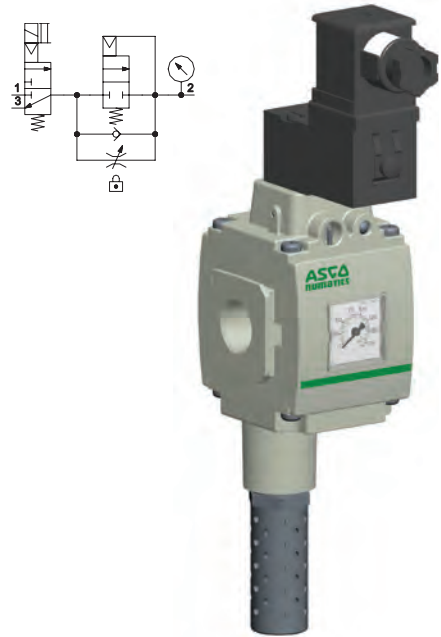

Performance Data					
Series	651		652		
Port Sizes	1/8, 1/4		1/4, 3/8, 1/2		
Thread Type	NPTF, G & Rc				
Nominal Flow – Per ISO 6358 P1 = 91.4 PSI (6.3 bar) ΔP = 14.5 PSI (1 bar)	SCFM (L/min ANR)				
		1 → 2	2 → 3	1 → 2	2 → 3
	1/8	27.5 (780)	36.7 (1040)	-	-
	1/4	35.3 (1000)	39.6 (1120)	53 (1500)	74 (2100)
	3/8	-	-	132 (3750)	151 (4300)
	1/2	-	-	164 (4650)	176 (5000)
Minimum Operating Pressure PSIG (bar)	40 (2.75)				
Maximum Operating Pressure PSIG (bar)	145 (10)				
Ambient Temperature Range °F (°C)	14 to 122 (-10 to 50)				
Fluid Temperature Range °F (°C)	14 to 122 (-10 to 50)				
Fluid	Air or Inert Gas				
Weight lbs (kg)	0.85 (0.387)		0.97 (0.438)		

Materials in Contact with Fluid	
Body	Aluminum
Seals	NBR/FKM
Springs	Stainless Steel

Operating Data				
	24/DC	120/60	240/60	24/60
Power	—	9 VA	9 VA	9 VA
Holding	3.0 Watts	4 VA (3.0 Watts)		

System Pressurization and Depressurization Curves

(with Automatic Soft-Start Device)

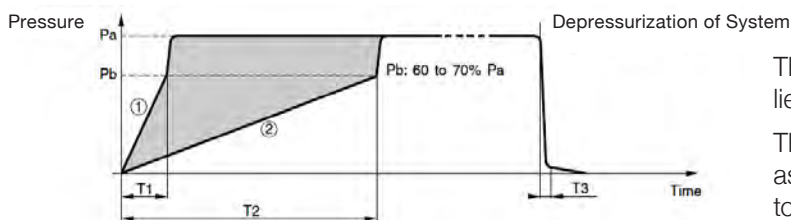

The adjustment range for the pressurization time lies between curves (1) and (2).

The transition to full flow takes place automatically as soon as the downstream pressure reaches 60 to 70% of the upstream pressure

Filling and venting times (seconds)		
	651 Series	652 Series
T1 (with screw loosened by 7 turns)	8	3.2
T2 (with screw loosened by 1 turn)	112	23
T3 (venting time)	4.8	1

These times correspond to a supply pressure (Pa) of 6.3 bar, a transition pressure (Pb) of 60 to 70% Pa (not adjustable) and a downstream system volume of **10 liters**.

How to Order

Slow-Start/Quick Exhaust Valve

8 651 A 6 S 6 2 F A00 F1

Port Type

8 = NPTF
G = ISO 228/1-G*
J = ISO 7/1 Rc

Product Series

651
652

Revision

A

Product Type

4 = 2/2 - Slow Start
5 = 3/2 - Quick Exhaust
6 = 3/2 - Slow Start/Quick Exhaust

Valve Type

E = External Air Pilot
P = Internal Air Pilot (Available on 2/2 Slow Start only)
S = Solenoid Pilot

Pilot Valve/Electrical Connection

0 = No Electrical Connection
1 = Vertical Solenoid, without DIN Connector (must order with option 110)
2 = Vertical Solenoid, DIN Connector with LED (must order with option 110)
3 = Vertical Solenoid, DIN Connector w/o LED (must order with option 110)
4 = Vertical Solenoid, 3 Pin M12 Connection** (must order with option 110)
5 = Horizontal Solenoid, without DIN Connector
6 = Horizontal Solenoid, DIN Connector with LED
7 = Horizontal Solenoid, DIN Connector without LED
8 = Horizontal Solenoid with 3 Pin M12 Connection**
9 = Without Pilot Operator

Port Size



1 = 1/8 (651 Series)
2 = 1/4 (651 or 652 Series)
3 = 3/8 (652 Series)
4 = 1/2 (652 Series)

Voltage

EW = 120/60, 115/50 VAC
F1 = 24 VDC
FQ = 24 50/60 VAC
FH = 230 50/60 VAC
00 = No Voltage





Options***



A00 = No Options
101 = Side Mounting Brackets
109 = FKM Seals
110 = Without Manual Override
111 = Metal Muffler
112 = Polyethylene Muffler
113 = Stainless Steel Fasteners
117 = ATEX Zones 1-21 ⚠****
122 = Inverted Mounting
123 = Gauge Type Mounted for Right-to-Left Flow
201 = 110 + 111

101  123 

Gauge Type

B = Digital Pressure Switch - PNP
C = Digital Pressure Switch - NPN
D = Digital Gauge
F = Low Profile Gauge PSI/bar
G = Low Profile Gauge bar/PSI
H = Low Profile Gauge PSI/bar with Pressure Range Indicator
J = Low Profile Gauge bar/PSI with Pressure Range Indicator
N = No Gauge with Port Plate (1/8 NPTF)
P = No Gauge with Port Plate (1/8 ISO 7/1 Rc)
Q = Round Gauge bar/PSI
R = Round Gauge PSI/bar
0 = No Gauge Port

B/C  D  F/G  H/J 

N/P  Q/R  0 

* Conforms to ISO standards 1179-1

** Available for 24 VDC voltage only

*** If multiple options are required, please use the on-line CAD configurator on the website to generate the part number (www.asco.com), or consult factory.

**** Option 117 (ATEX 1-21) is available with Valve Type "E" or "P". For Valve Type "S" (Solenoid Pilot), please select "9" under the "Pilot Valve/Electrical Connection". Consult factory for further information.

Dimensions: mm (inches)

Dimensional Drawing - 651/652 Series Slow-Start/Quick Exhaust Valve

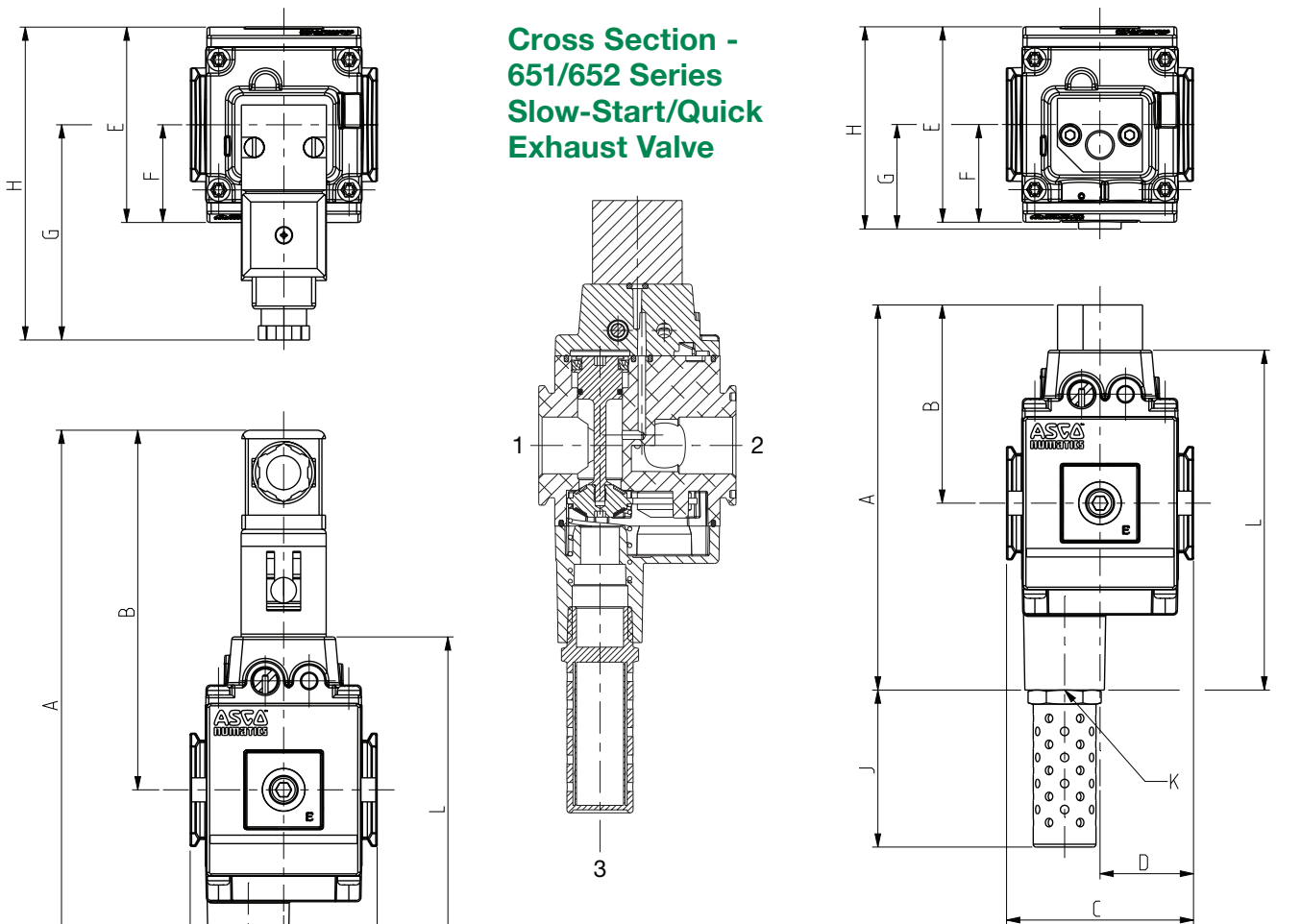

External Air Pilot

	A	B	C	D	E	F	G	H	J	K	L
651	113	59	50	25	58	29	31.5	60.5	34.5	-	97
	(4.45)	(2.32)	(1.97)	(0.98)	(2.28)	(1.14)	(1.24)	(2.38)	(1.36)	1/4 NPTF or 1/4 ISO 228/1-G	(3.82)
652	136	70	66	33	69	34.5	37	71.5	57	-	120
	(5.35)	(2.76)	(2.60)	(1.30)	(2.72)	(1.36)	(1.46)	(2.81)	(2.24)	1/2 NPTF or 1/2 ISO 228/1-G	(4.72)

Solenoid Pilot

	A	B	C	D	E	F	G	H	J	K	L
651	170	116	50	25	58	29	72	101	34.5	-	97
	(6.69)	(4.57)	(1.97)	(0.98)	(2.28)	(1.14)	(2.83)	(3.98)	(1.36)	1/4 NPTF or 1/4 ISO 228/1-G	(3.82)
652	193	127	66	33	69	34.5	76	110.5	57	-	120
	(7.60)	(5.00)	(2.60)	(1.30)	(2.72)	(1.36)	(2.99)	(4.35)	(2.24)	1/2 NPTF or 1/2 ISO 228/1-G	(4.72)

DIVERTER BLOCK

- Ideal for branching off primary series air prep manifold to add additional products, such as adding another regulator or dividing lubricated and un-lubricated compressed air lines
- 1/8 or pad mount interface ports on top of product for adding pressure switches/sensors or other condition monitoring devices
- 1/4 ports (651 Series) or 3/8 ports (652 Series) on the front and back provide additional flexibility to attach or branch off the main manifold. It can also be used to feed auxiliary air to air prep assemblies that require additional air capacity, such as a bank of manifold regulators



Performance Data			
Series		651	652
Port Sizes	Left, Right & Bottom	1/4 & Flanged	1/2 & Flanged
	Front & Back	1/4	3/8
Thread Type		NPTF, G & Rc	
Top Port (for Pressure Switch/Pressure Sensor)		1/8*	
Maximum Pressure PSIG (bar)		232 (16)	
Fluid		Air or Inert Gas	
Weight lbs (kg)		0.41 (0.188)	0.73 (0.331)

* Different for EU

Materials in Contact with Fluid	
Body	Aluminum
Body Covers	Polyamide

How to Order

Diverter Block

8 651 A D 0 0 2 T A00 0 0

Port Type

- 8 = NPTF
- G = ISO 228/1-G*
- J = ISO 7/1 Rc

Product Series

- 651
- 652

Revision

- A

Product Type

- D = Diverter Block

Options**

- A00 = No Options
- 101 = Side Mounting Brackets
- 117 = ATEX Zones 1-21

Pressure Switch Interface

- C = Pad Mount (Europe only)
- T = 1/8 (US only)

Port Size

- 2 = 1/4 (651 Series)
- 4 = 1/2 (652 Series)

* Conforms to ISO standards 1179-1

** If multiple options are required, please use the on-line CAD configurator on the website to generate the part number (www.asco.com), or consult factory.

Dimensions: mm (inches)

Dimensional Drawing - 651/652 Series Diverter Block

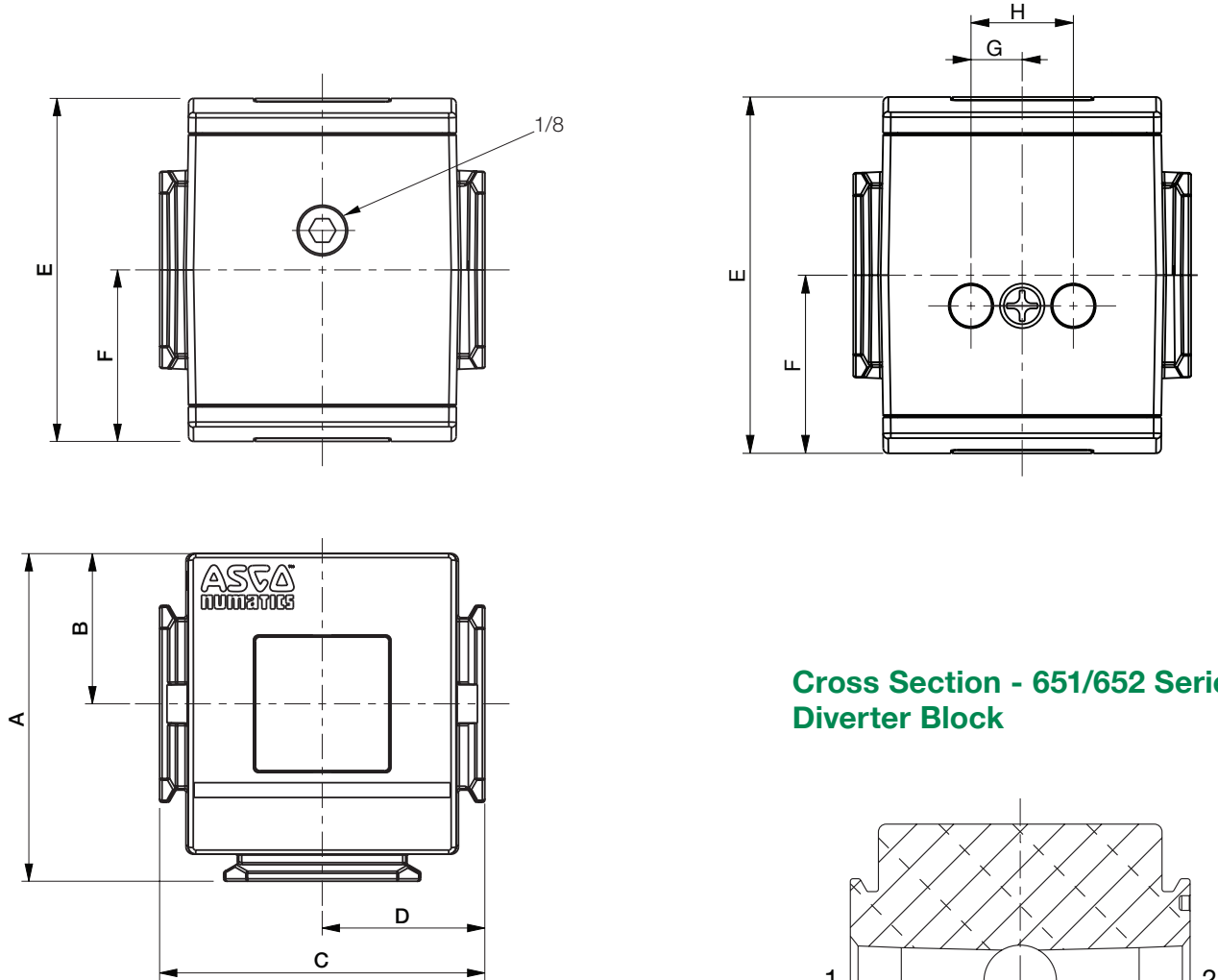

Cross Section - 651/652 Series Diverter Block

	A	B	C	D	E	F	G	H
651	54.4	25	50	25	58	29	10	20
	(2.14)	(0.98)	(1.97)	(0.98)	(2.28)	(1.14)	(0.39)	(0.79)
652	66.5	30.5	66	33	70	35	10	20
	(2.62)	(1.20)	(2.60)	(1.30)	(2.76)	(1.38)	(0.39)	(0.79)

LOCKOUT VALVE

- Modular assembly to 652 series manifold using common 652 series body-to-body clamps
- Provides high exhaust capacity of downstream pressure
- Available as full-flow start or slow-start
- Slow-start feature allows operator to turn knob counter clock wise to “On” position, gradually ramping up downstream pressure
- Bright yellow body with red knob is easily identified as an emergency shut-off device
- Typically located as the final component in an Air Preparation assembly

Performance Data			
Port Sizes*		1/2	
Nominal Flow		1 → 2	2 → 3
	SCFM (L/min ANR)	116 (5905)	116 (5905)
Ambient Temperature Range °F (°C)		40 to 120 (4 to 50)	
Fluid Temperature Range °F (°C)		40 to 120 (4 to 50)	
Maximum Pressure PSIG (bar)		150 (10.3)	
Fluid		Air or Inert Gas	
Weight lbs (kg)	Standard	2.7 (1.23)	
	Slow Start	3.1 (1.39)	

*Ports are not threaded (grey flanges). Easily connect to 652 Series Manifold. When connecting to pipe, use end-plate kits #T652AT502468001

Materials in Contact with Fluid	
Body	Aluminum
Seals	NBR
Spool	Aluminum

How to Order

Lockout Valve

T 652 A 5 L 0 4 0 A00 00

Port Type
T = Modular Mounting

Product Series
652

Revision
A

Product Type
5 = 3/2 - Quick Exhaust
6 = 3/2 - Slow Start - Quick Exhaust

Options*
A00 = No Option
111 = Metal Muffler
115 = Scissor Lock
2B9 = 111 + 115

Port Size
1/2

Valve Type
L = Manually Operated Lockout

* If multiple options are required, please use the on-line CAD configurator on the website to generate the part number (www.asco.com), or consult factory.

3/2 Lockout Valve with Slow Start Feature



3/2 Lockout Valve

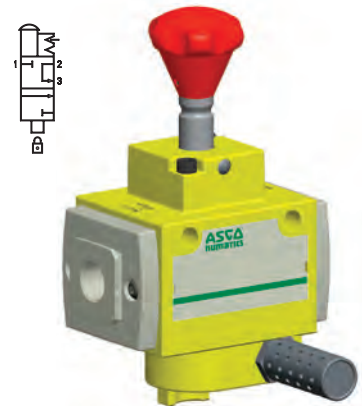

Dimensions: mm (inches)

Dimensional Drawing - 652 Series Lockout Valve

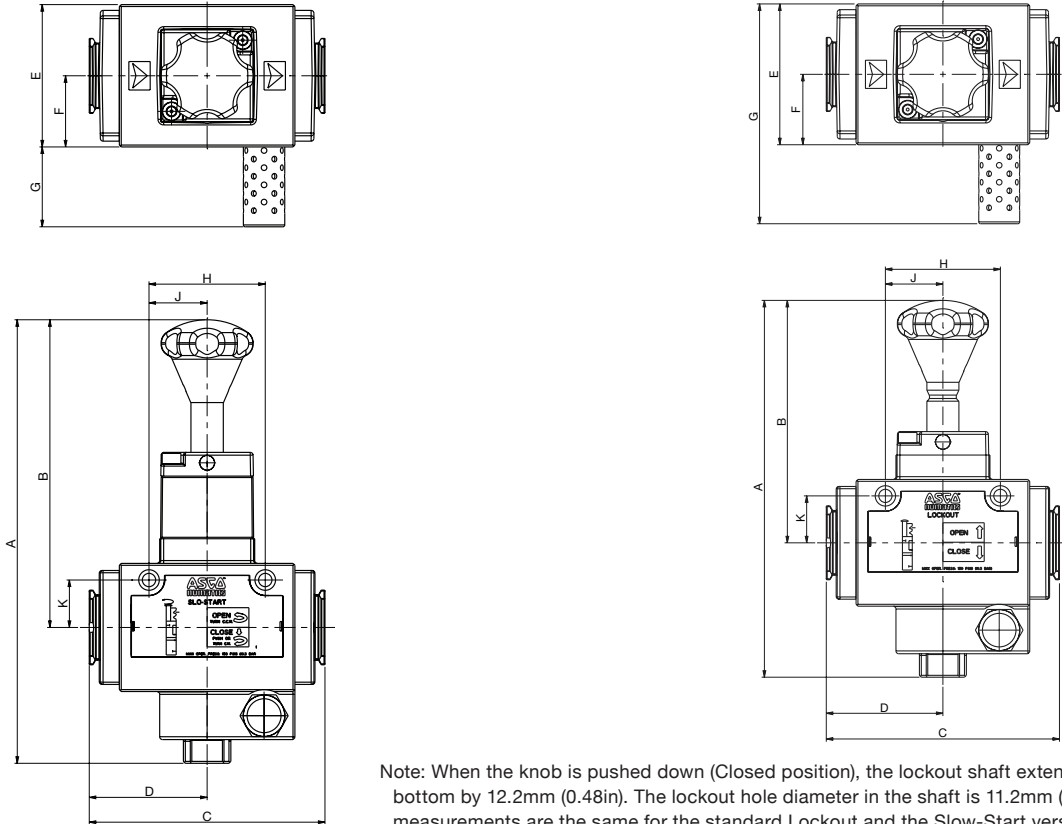

3/2 Lockout Valve with Slow Start Feature

A	B	C	D	E
237.5	164.9	126.2	63.1	76.2
(9.35)	(6.49)	(4.96)	(2.48)	(3.00)

F	G	H	J	K
38.1	42.7	62.2	31.1	25.4
(1.50)	(1.68)	(2.44)	(1.22)	(1.00)

3/2 Lockout Valve

A	B	C	D	E
204	131.3	126.2	63.1	76.2
(8.03)	(5.17)	(4.96)	(2.48)	(3.00)

F	G	H	J	K
38.1	119	62.2	31.1	25.4
(1.50)	(4.68)	(2.44)	(1.22)	(1.00)

3/2 Lockout Valve with Slow Start Feature Cross Section

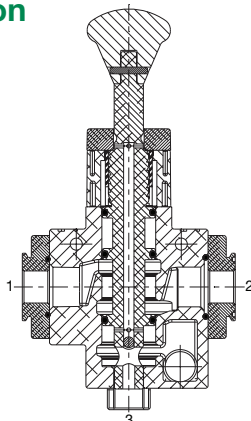

3/2 Lockout Valve Cross Section

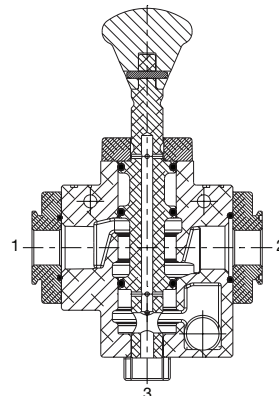

How to Order

Air Preparation Manifold Assemblies

8 651 A S L D 2 C 0 0 A00

Port Type
8 = NPTF
G = ISO 228/1-G*
J = ISO 7/1 Rc

Product Series
651
652

Revision
A

Product Type
S = FRL Assembly



Air Flow Direction
L = Configure Air Flow P(1) Left - P(2) Right
R = Configure Air Flow P(1) Right - P(2) Left

Number of Stations

A = 1	K = 11
B = 2	L = 12
C = 3	M = 13
D = 4	N = 14
E = 5	O = 15
F = 6	P = 16
G = 7	Q = 17
H = 8	R = 18
I = 9	S = 19
J = 10	T = 20

Options
A00 = No Options
117 = ATEX Zones 1-21

Mounting Type
0 = No Mounting
C = End Plates, Body-to-Body Assembly Clamps & Wall/Panel Brackets
F = End Plates and Body-to-Body Assembly Clamps
L = Side Mounting Brackets

End Plate Port Size
0 = None
2 = 1/4 (651 Series)
4 = 1/2 (652 Series)

* Conforms to ISO standards 1179-1

All manifolds come assembled and fully tested to your configuration.

If additional support is required in the middle of a manifold. Please specify kit number P699AT502467001. This kit contains one Wall/Panel Bracket (also referred to as support bracket or mounting bracket). This bracket can be installed at the factory or ordered separately as a kit. This kit contains two screws, which allows customers to easily attach the bracket to the back of any of the body-to-body clamps in the manifold assembly.

After selecting the top level assembly part number, please refer to each of the How-to-Order charts within this catalog to determine the specific product that is required in the manifold assembly. The How-to-Order charts are located on the following pages:

Particulate Filter	5	Lubricator	28
Coalescing Filter	9	Shut-Off Isolation Valve	31
Regulator	13	Slow-Start/Quick Exhaust Valve	34
Manifold Regulator	17	Diverter Block	37
Particulate Filter/Regulator	20	Lockout Valve	39
Coalescing Filter/Regulator	24		

How-to-order 651/652 Series Air Preparation Manifold Assemblies (Examples)

Example #1

The following example assembly includes six stations of the 652 series products, manifold end plates with mounting brackets and an additional support bracket between station 1 and 2. The manifold air flow is from Left-to-Right. Port type is NPTF. Port size is 1/2.

The regulator is configured for a bottom oriented pressure adjustment (option 122). The Shut-Off Isolation Valve is configured with a low profile gauge, with pressure range indicators.

Example Order

Assembly	8652ASLF4C00A00	651 Series Air Prep Assembly
Station 1	8652A3M04H11100	652 Series Shut Off Isolation Valve
	P699AT5Q2467001	Support Bracket
Station 2	8652ABBP4JA000N	652 Series Particulate Filter
Station 3	8652AFDM4FA000A	652 Series Coalescing Filter
Station 4	8652AR004F122G0	652 Series Regulator
Station 5	8652AD004TA0000	652 Series Diverter Block
Station 6	8652A6S74FA00F1	652 Series Slow-Start/Quick Exhaust Solenoid Valve

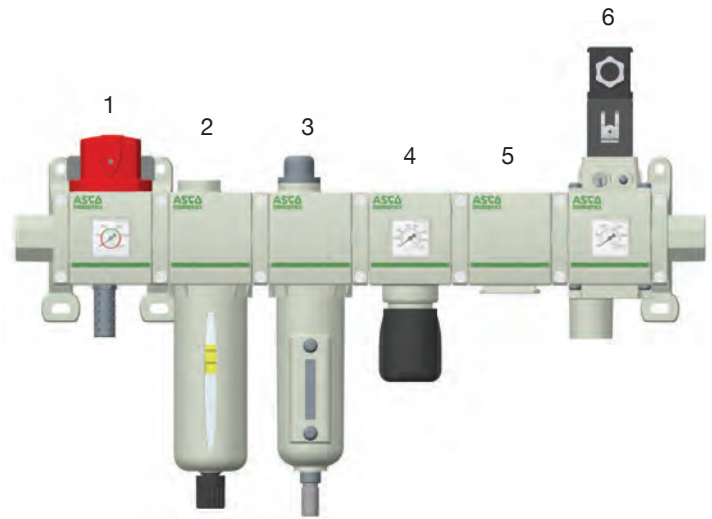

Assembled

Example #2

The following example assembly includes five stations of the 651 series products and side mounting brackets. The manifold air flow is from Right-to-Left. Port type is ISO 228/1-G. Port size is 1/4.

The Lubricator is configured with an Electronic Liquid Level Indicator (option 108). The Shut-off Isolation Valve uses a combination option (270), which is configured when you use a Metal Muffler (111) and a low profile gauge that requires a right-to-left flow (123). The Coalescing Filter/Regulator also uses a combination option. In this case a combination option (243) includes a Key Lockable Handle (104) and a low profile gauge that requires right-to-left flow (123).

Example Order

Assembly	G651ASRE0L00A00	651 Series Air Prep Assembly
Station 5	G651AL0M2010800	651 Series Lubricator
Station 4	G651AD002TA0000	651 Series Diverter Block
Station 3	G651ACDM2F243GA	651 Series Coalescing Filter-Regulator
Station 2	G651ABBM2JA000A	651 Series Particulate Filter
Station 1	G651A3M02F27000	651 Series Shut Off Isolation Valve

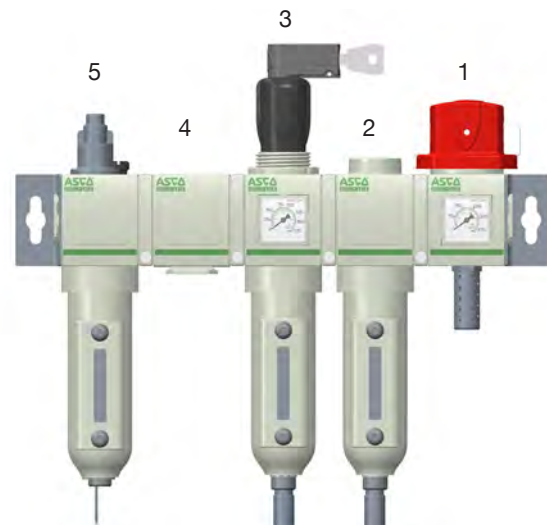

Assembled

If multiple options are required, please use the on-line CAD configurator on the website to generate the part number (www.asco.com), or consult factory.

MOUNTING BRACKETS

Dimensions: mm (inches)

Dimensional Drawings - Mounting Options

651 Series Side Mounting Brackets Kit#: P651AT503860001

652 Series Side Mounting Brackets Kit#: P652AT503860002

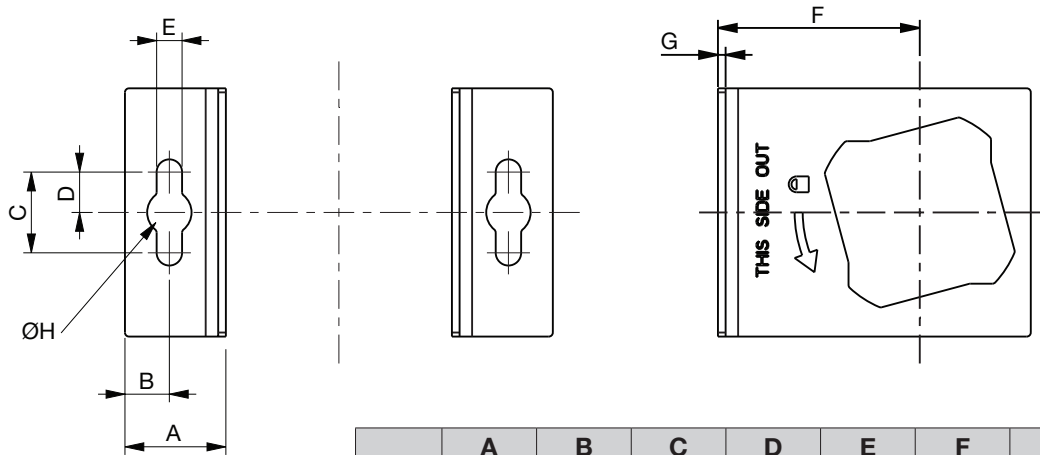

	A	B	C	D	E	F	G	ØH
651	25	11	20	10	6.3	44.5	1.27	11
	(0.98)	(0.43)	(0.79)	(0.39)	(0.25)	(1.75)	(0.05)	(0.43)
652	25	11	20	10	6.3	50	1.9	11
	(0.98)	(0.43)	(0.79)	(0.39)	(0.25)	(1.97)	(0.07)	(0.43)

Wall/Panel Bracket Kit#: P699AT502467001

A	B	C	D
26	13	92	46
(1.02)	(0.51)	(3.62)	(1.81)

E	F	G	ØH
6	3	6.5	6.5
(0.24)	(0.12)	(0.26)	(0.26)

J	K	L	M
8	18	109	44.5
(0.31)	(0.71)	(4.29)	(1.75)

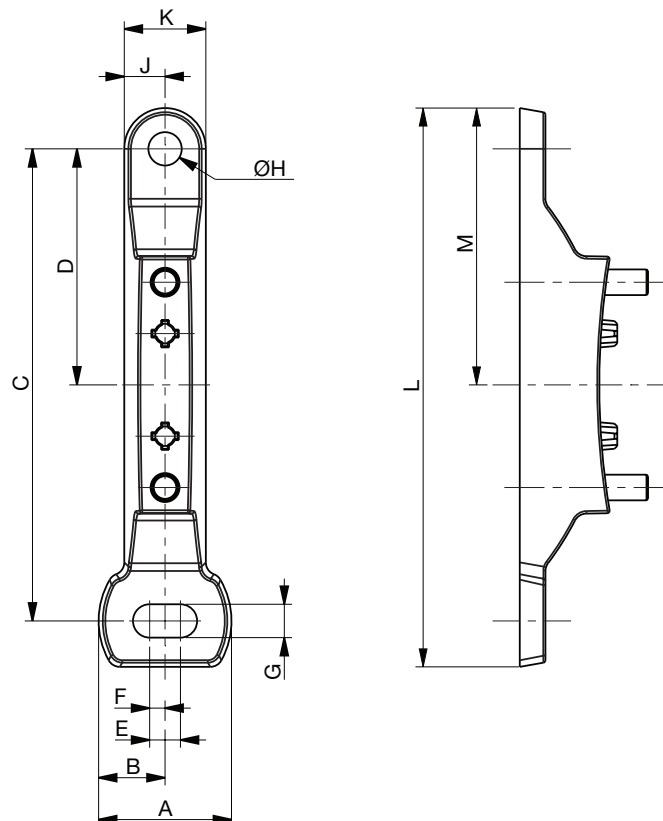

BOWLS

Dimensions: mm (inches)

Dimensional Drawings - Bowl and Drain Options

Polycarbonate Bowl/Guard with Semi-Automatic/Manual Drain

Polycarbonate Bowl/Guard with Stainless Steel Manual Drain

Metal Bowl with Automatic Drain

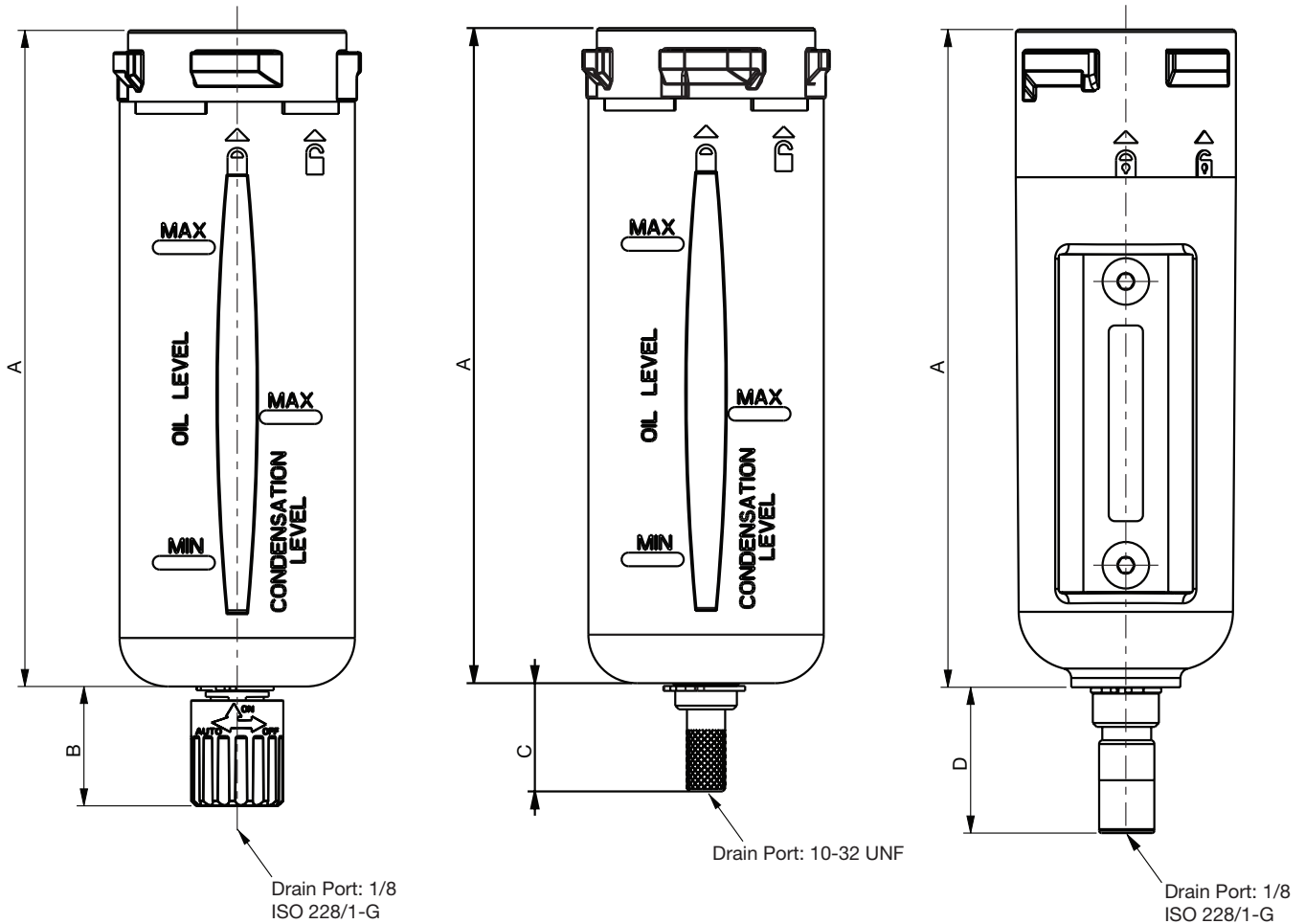

	A	B	C	D
651	116	25	22.3	30
	(4.57)	(0.98)	(0.88)	(1.18)
652	135	25	22.3	30
	(5.31)	(0.98)	(0.88)	(1.18)

Please allow the following mm (inch) clearance for bowl removal:

	651	652
Particulate Filter or Filter/Reg (from bottom of drain)	44 (1.8)	75 (3.0)
Coalescing Filter or Filter/Reg (from bottom of drain)	60 (2.4)	80 (3.2)
Lubricator (from bottom of bowl)	20 (0.8)	25 (1.0)

Bowl Type	Series	Filter - Max Condensate Level (ml)				Lubricator - Max Oil Level (ml)	
		Semi\Manual	Manual	Automatic	No Drain	No Option	w/Liquid Level Indicator
Polycarbonate	651	30	30	15	30	45	35
	652	50	50	35	50	90	80
Aluminum	651	30	30	15	30	45	35
	652	50	50	35	50	90	80

280 Series Digital Pressure Switch

Performance Data		
Port Size/Thread Type	1/8 NPTF Male x 10/32 UNF Female	
	1/8 ISO 7/1 Rc Male x M5-0.8 Female	
Ambient Temperature Range °F (°C)	32 to 122 (0 to 50)	
Rated Pressure Range PSIG (bar)	0 to 145 (0 to 10)	
Maximum Pressure PSIG (bar)	217.5 (15)	
Fluid	Air or Inert Gas	
Set Pressure Resolution	kPa	1
	kgf/cm ²	0.01
	bar	0.01
	PSI	0.1
LCD Display	7 Segment; Red/Green Color	
Sampling Rate	5 times per second	
Repeatability	≤ +/- 0.2% F.S. +/- 1 Digit	
Hysteresis (window comparator mode)	Adjustable	



Electrical Ratings		
Power Supply Voltage	12 to 24 VDC +/- 10% Ripple (P-P) 10% or Less	
Current Consumption	≤ 45 mA (with no load)	
Switch Output	PNP Open Collector / NPN Open Collector	
Max. Load Current	125 mA	125 mA
Max Supply Voltage	24 VDC	30 VDC
Residual Voltage	≤ 1.5 V	≤ 1.5 V
Load Current	125 mA	125 mA
Enclosure Rating	IP40	

Materials in Contact with Fluid	
Enclosure Case	PBT + 30 GF
Port	Nickel Plated Brass
Seals	NBR

How to Order

Model Numbers

DPS280PNQ8 1/8 NPTF (PNP)

DPS280PRQ8 1/8 ISO 7/1 Rc (PNP)

DPS280NNQ8 1/8 NPTF (NPN)

DPS280NRQ8 1/8 ISO 7/1 Rc (NPN)

Note: All part numbers include an 8mm Pico 4 Pin connector and 2 meter cable (4mm O.D. x 26 AWG)

Display Panel Instructions

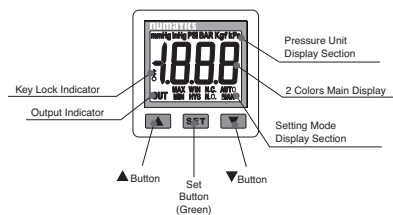

Switch Wiring

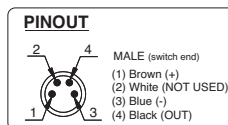

Output Circuit Wiring

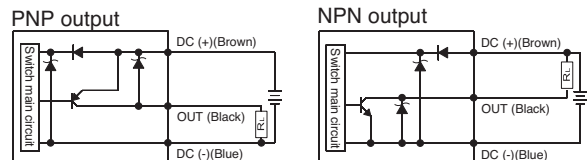

Accessory Numbers

Model	Accessory Description
DPS280-8-4-ST-2	Mating Cable 8mm 4 Pin 2 Meter
DPS280-8-4-ST-5	Mating Cable 8mm 4 Pin 5 Meter
PC0402MEETA03000	Patch Cable M8 4 Pin X M12 3 Pin 2 Meter

Model	Accessory Description
PMK280-C	Panel Mount Kit with Cover

PS182 Series Pressure Switch

Performance Data	
Port Size/Thread Type	1/8 NPTF or 1/8 ISO 228/1-G (BSPP)
Ambient Temperature Range °F (°C)	-40 to 250 (-40 to 121)
Set Point Adjustment Ranges PSI (bar)	2-10 (0.14 to 0.69), 6-30 (0.41 to 2.07), 20-130 (1.38 to 8.96)
Set Point Tolerance	+ 1 PSI or 5%
Maximum Pressure PSIG (bar)	600 (41.4)
Fluid	Air or Inert Gas
Maximum Cycle Rate per Minute	200
Hysteresis Adjustment	10%

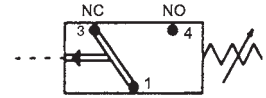

Electrical Ratings	
Switch Contact Rating	4 Amp (Gold Plated Contacts)
Voltage Range	12 VDC to 250 VDC
Enclosure Rating	IP 65
Electrical Connection	3 Pin M12

Materials in Contact with Fluid	
Enclosure Case	Anodized Aluminum
Body	Brass
Seals	NBR

How to Order

Model Numbers

- PS182CAN01-2 1/8 NPTF (Pin out is compatible with G3 Fieldbus Digital I/O)
- PS182CAN01 1/8 NPTF
- PS182CAG01 1/8 ISO 228/1-G (BSPP)

Dimensions: mm (inches)

Dimensional Drawings - PS182 Series Pressure Switch

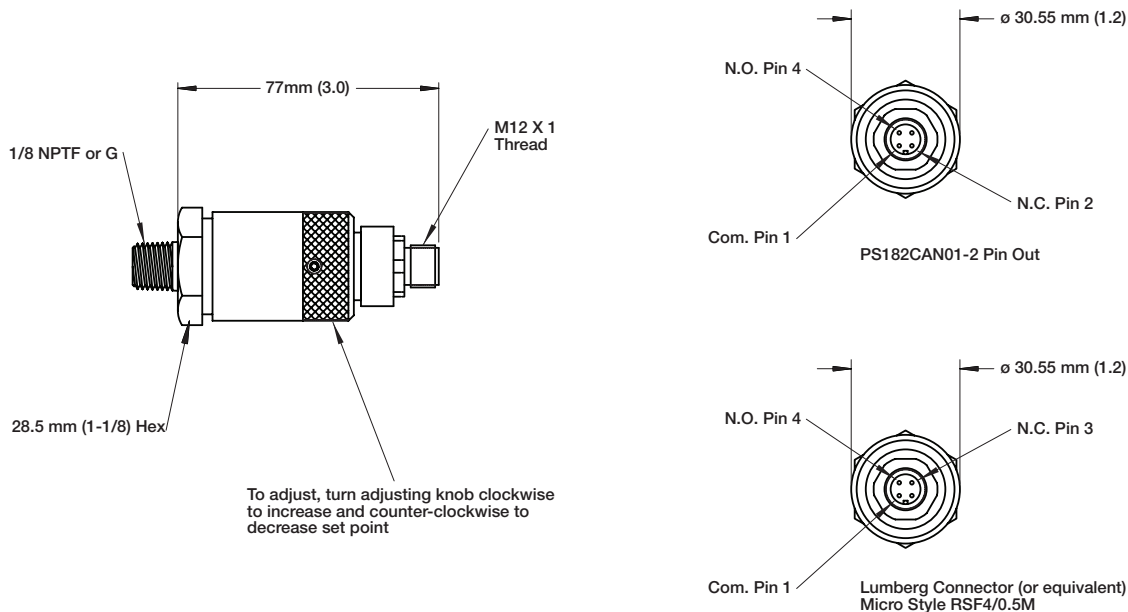

PS180 Series Pressure Switch

Performance Data	
Port Size/Thread Type	1/8 NPTF & ISO 228/1-G (BSPP)
Ambient Temperature Range °F (°C)	0 to 190 (-15 to 85)
Set Point Adjustment Ranges PSI (bar)	4-20 (0.28 to 1.38), 14-150 (0.97 to 10.34)
Maximum Pressure PSIG (bar)	300 (20.7)
Fluid	Air or Inert Gas
Maximum Cycle Rate per Minute	200
Hysteresis Adjustment	15%

Electrical Ratings	
Switch Contact Rating	4 Amp
Maximum Voltage	250 VAC (200 VDC)
Enclosure Rating	IP 65

Materials in Contact with Fluid	
Connector Housing	Polyamide
Port	Zinc Plated Steel
Seals	NBR

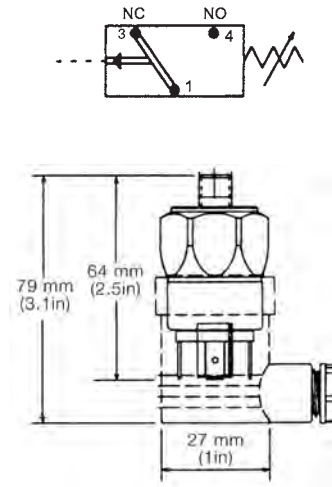

How to Order

Model Numbers

- PS180CAN01 1/8 NPTF
- PS180CAG01 1/8 ISO 228/1-G

Digital Pressure Gauge

Performance Data	
Port Size/Thread Type	1/8 (NPTF or ISO 7/1 Rc)
Ambient Temperature Range °F (°C)	32 to 122 (0 to 50)
Rated Pressure Range PSIG (bar)	0 to 145 (0 to 10)
Maximum Pressure PSIG (bar)	217.5 (15)
Fluid	Air or Inert Gas
Display (Unit Measurement)	PSI, bar, MPa, kgf/cm ²
LCD Display	7 Segment 3-1/2 Digit
Sampling Rate	2 times per second
Repeatability	< + 0.2% + 1 Digit

Electrical Ratings	
Battery	CR 2032 Lithium (Replaceable)
Battery Life	3 Year (display turned on 5 times per day)
Battery Power Saving Mode	Display turns off after 30 seconds
Enclosure Rating	IP65

Materials in Contact with Fluid	
Enclosure - Front Case	ABS
Enclosure - Back Case	Zinc
Seals	NBR



How to Order

Model Numbers

- M699AG504650001 1/8 NPTF
- M699AG504650002 1/8 ISO 7/1 Rc

349 Series Pressure Switch

Performance Data		
	Without Protection	With Protection
Port Size/Thread Type	Pad Mounted	
Fluid	Air or Inert Gas	
Pressure Setting	0.2 to 6, 0.5 to 10, 0.5 to 16 bar	
Hysteresis	0.4 bar at the beginning of adjustment range 1 bar at the end of adjustment range	
Operating Temperature (°C)	-10 to +60	0 to +60
Max Voltage	250V - AC/DC	24 VDC
Current Breaking Capacity	5A - 250V resistive	2A - 24Vcc Resistive
Protection Degree	IP65	
Max Speed	60 cycles per minute	

Material in contact with fluid	
Body	High Performance Polymer (PA61/XT)/Aluminium for 16 bar version
Seals	NBR

How to Order

	0.2 - 6 bar	0.5 - 10 bar	0.5 - 16 bar
With Protection	34900028	34900031	34900034
Without Protection	34900027	34900030	34900033

Dimensional Drawings

Without Protection

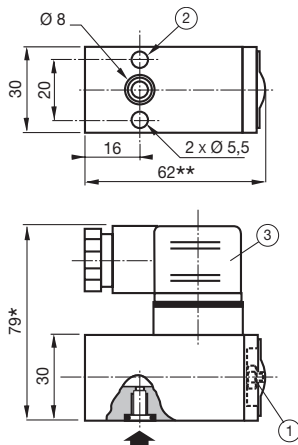

- ① Pressure set screw (spanner for hexagon nuts: 3mm)
- ② 2 holes Ø5.5 for mounting
- ③ ISO4400 size 30 connector, 4 terminals, rotatable by 90°

With Protection

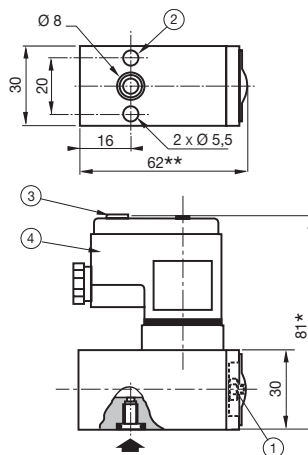

- ① Pressure set screw (spanner for hexagon nuts: 3mm)
- ② 2 holes Ø5.5 for mounting
- ③ Identification label holder
- ④ Pg9P connector, non rotatable*

With Protection Electrical Diagram

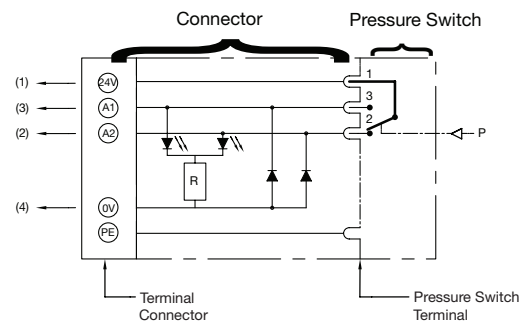

Status indicated by two diodes:

- at rest: contact 1-2 made: orange diode lights
 - at work: contact 1-3 made: red diode lights
- Terminal connection for 1.5mm² wire integrated interference blinking

Electrical Connection With and Without Protection

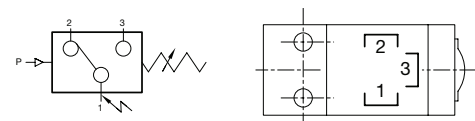

Electric Differential Pressure Indicator

Performance Data	
Ambient Temperature Range °F (°C)	-13 to 212 (-25 to 100)
Maximum Pressure PSIG (bar)	290 (20)
Delta P Setting +PSIG (bar)	10.2 (0.7)

Electrical Ratings	
Switching Contact	SPDT
14 VDC/5 A; 30 VDC/4 A; 125 VAC/5 A; 250 VAC/5 A	
Minimum Load	5 VDC/160 mA
Enclosure Rating	IP65 (DIN Connector 43650)

Materials in Contact with Fluid	
Body	Brass
Seals	NBR

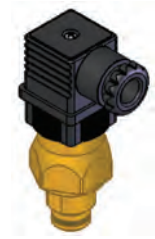

How to Order

Model Numbers

M699AG439851003

Electronic Liquid Level Indicator (for Lubricator)

Performance Data	
Actuation Point	25 mL (Nominal)*
Switch Contact is open when fluid drops below 25 mL	
Connection	1/8-27 NPT External Thread

Electrical Ratings	
Switching Contact	SPST
Switch Type	50 Watt Reed Switch
Wire Size/Length	22 AWG/24 Inches (610mm)

Materials in Contact with Fluid	
Body	Brass
Float	Nylon



How to Order

Model Numbers

M699AG506837001

Repair Kits and Service Parts

651/652 Series - Spare Parts Kits

		Description	Series	Kit Number
Bowls*		Polycarbonate Bowl & Bowl Guard - Includes NBR Bowl Seal for Filters, Filter-Regulators and Lubricators (Electronic Liquid Level Indicator only)	651	M651AU434133001
			652	M652AU440511001
		Polycarbonate Bowl (No Bowl Guard) - Includes NBR Bowl Seal for Filters, Filter-Regulators and Lubricators (Electronic Liquid Level Indicator only)	651	M651AU434133009
			651	M651AU434133008
		Polycarbonate Bowl & Bowl Guard - Includes NBR Bowl Seal for Lubricators.	651	M651AU434133008
			652	M652AU440511008
		Polycarbonate Bowl (No Bowl Guard) - Includes NBR Bowl Seal for Lubricators	651	M651AU434133010
			651	M651AU434133002
		Metal bowl without sight gauge. Includes NBR Bowl Seal.	651	M651AU434133002
			652	M652AU440511002
		Metal bowl without sight gauge. Includes FKM Bowl Seal.	651	M651AU434133011
			652	M652AU440511011
		Metal bowl with polyamide sight gauge. Includes NBR Bowl Seal.	651	M651AU434133003
			652	M652AU440511003
		Metal bowl with polyamide sight gauge. Includes FKM Bowl Seal.	651	M651AU434133013
			652	M652AU440511013
	Metal bowl with borosilicate (glass) sight gauge. Includes NBR Bowl Seal.	651	M651AU434133004	
		652	M652AU440511004	
	Metal bowl with borosilicate (glass) sight gauge. Includes FKM Bowl Seal.	651	M651AU434133015	
		652	M652AU440511015	
Drains		Drain Plug Assembly. Provides an option to customers that do not want to use a bowl drain. Includes NBR Bowl Seal.	651 652	M699AQ440512001
		Semi-Automatic/Manual Drain Assembly - with NBR seals. This normally open drain can be used as a manual drain or set to semi-automatic, which will drain the bowl upon a loss of system pressure. Drain material is plastic.	651 652	M699AQ440512002
		Semi-Automatic/Manual Drain Assembly - with FKM seals. This normally open drain can be used as a manual drain or set to semi-automatic, which will drain the bowl upon a loss of system pressure. Drain material is plastic.	651 652	M699AQ440512007
		Manual Stainless Steel Drain Assembly - with NBR seals. Provides the user with an alternative to the plastic semi-automatic drain.	651 652	M699AQ440512003
		Manual Stainless Steel Drain Assembly - with FKM seals. Provides the user with an alternative to the plastic semi-automatic drain.	651 652	M699AQ440512008
		Automatic Drain Assembly - with NBR seals. This drain uses a float that initiates the bowl to drain when the liquid rises. In addition, all fluid will drain when the pressure drops below 22 PSI. Drain material is brass. This drain can also be operated manually.	651 652	M699AQ501862001
Bowl & Drain Assembly		Bowl and Drain Assembly - Includes Polycarbonate Bowl/Guard and Semi-Automatic Drain Assembly (NBR Seals).	651	M651AU514009001
			652	M652AU513311001
	Bowl and Drain Assembly - Includes Polycarbonate Bowl (no bowl guard) and Semi-Automatic Drain Assembly (NBR Seals).	651	M651AU514009002	

* For lubricator replacement metal bowls, please also order bowl plug p/n M699AQ440512001. This is not required if the Electronic Liquid Level Indicator is used.

Repair Kits and Service Parts
651/652 Series - Spare Parts Kits





		Description	Series	Kit Number	Color
Filter Elements		5 Micron Particulate Filter Element	651	M651AE434063001	White
			652	M652AE433582001	
		25 Micron Particulate Filter Element	651	M651AE434063002	Yellow
			652	M652AE433582002	
		40 Micron Particulate Filter Element	651	M651AE434063003	Green
			652	M652AE433582003	
		0.3 Micron Coalescing Filter Element	651	EKF12D	Green
			652	EKF22D	
		0.01 Micron Coalescing Filter Element	651	EKF12E	Red
			652	EKF22E	
		0.3 Micron Coalescing Filter Element - with 3 Micron pre-filter	651	EKF12DD	Green
			652	EKF22DD	
		0.01 Micron Coalescing Filter Element - with 3 Micron pre-filter	651	EKF12ED	Red
			652	EKF22ED	
	Adsorber (Activated Carbon) Filter	651	EKF12F	White/ Clear	
		652	EKF22F		

Repair Kits and Service Parts

651/652 Series - Air Prep Assembly and Mounting Kits





	Description	Series	Kit Number		
	Body-to-Body Assembly Clamps (Includes NBR O-Ring). Clamp material is aluminum.	651	P651AT504958001		
		652	P652AT502466001		
	Body-to-Body Assembly Clamps (Include FKM O-Ring). Clamp material is aluminum.	651	P651AT504958003		
		652	P652AT502466003		
	End Plate Kit: Includes two end plates and body-to-body assembly clamps & O-Ring. End plate material is aluminum.	NBR O-Ring	1/4 NPTF	651	T651AT504959001
			1/2 NPTF	652	T652AT502468001
		FKM O-Ring	1/4 ISO228/1-G	651	T651AT504959002
			1/2 ISO228/1-G	652	T652AT502468002
			1/4 ISO 7/1 Rc	651	T651AT504959003
			1/2 ISO 7/1 Rc	652	T652AT502468003
			1/4 NPTF	651	T651AT504959007
			1/2 NPTF	652	T652AT502468007
		FKM O-Ring	1/4 ISO228/1-G	651	T651AT504959008
			1/2 ISO228/1-G	652	T652AT502468008
FKM O-Ring	1/4 ISO 7/1 Rc	651	T651AT504959009		
	1/2 ISO 7/1 Rc	652	T652AT502468009		
	Wall/Panel Bracket Kit includes one bracket and two screws for attaching bracket to body clamp. Two brackets are required for mounting three or more products. One bracket is suitable for mounting two products. Material is aluminum.	651 652	P699AT502467001		
	Side Mounting Brackets (Includes two brackets): Designed for mounting single products to wall or panel, but is capable of handling up to 3 stations. Material is stainless steel. Recommended only for static applications (without vibration).	651	P651AT503860001		
		652	P652AT503860002		
	Panel Nut: Used for Regulators and Filter-Regulators where adjustment knob is fed through a panel and the panel nut is then used to secure the product to the panel. Material is polyamide.	651	P651AT513928001		
		652	P652AT513177001		
	Panel Nut & Bracket: The panel nut and bracket are used to mount a Regulator or Filter-Regulator to a wall or panel. Materials are stainless steel and polyamide.	651	P651AT503861001		
		652	P652AT503861002		
	651 to 652 Series Transition Kit: Includes one 651 body clamp, one 652 body clamp, transition plate and required O-rings to transition from a 651 to a 652 Series component within a manifold configuration (e.g. using a 652 body within a 651 manifold to achieve higher filtration flow rates).	NBR O-Ring	651 652	T651AT519193001	
		FKM O-Ring	651 652	T651AT519193002	
	652 to 651 Series Transition Kit: Includes one 652 body clamp, one 651 body clamp, transition plate and required o-rings to transition from a 652 to a 651 Series component within a manifold configuration (e.g. using a 652 body within a 651 manifold to achieve higher filtration flow rates).	NBR O-Ring	651 652	T652AT519193003	
		FKM O-Ring	651 652	T652AT519193004	

Repair Kits and Service Parts
651/652 Series - Spare Parts Kits

		Description	Series	Kit Number
No Gauge		No Gauge Cover Kit - NBR Seal. Includes gauge cover, screw and O-Ring	651 652	M699AG503396001
		No Gauge Cover Kit - FKM Seal. Includes gauge cover, screw and O-Ring	651 652	M699AG503396002
Low Profile Gauges*		Low Profile Gauge - 651/651/653 Series: 0-90 PSI Scale with NBR seals	651 652	M699AG438047005
		Low Profile Gauge - 651/651/653 Series: 0-90 PSI Scale with FKM seals	651 652	M699AG438047017
		Low Profile Gauge - 651/651/653 Series: 0-175 PSI Scale with NBR seals	651 652	M699AG438047004
		Low Profile Gauge - 651/651/653 Series: 0-175 PSI Scale with FKM seals	651 652	M699AG438047016
		Low Profile Gauge - 653 Series: 0-375 PSI Scale with NBR seals	651 652	M699AG438047006
		Low Profile Gauge - 653 Series: 0-375 PSI Scale with FKM seals	651 652	M699AG438047018
		Low Profile Gauge - 651/651/653 Series: 0-6 bar Scale with NBR seals	651 652	M699AG438047002
		Low Profile Gauge - 651/651/653 Series: 0-6 bar Scale with FKM seals	651 652	M699AG438047014
		Low Profile Gauge - 651/651/653 Series: 0-12 bar Scale with NBR seals	651 652	M699AG438047001
		Low Profile Gauge - 651/651/653 Series: 0-12 bar Scale with FKM seals	651 652	M699AG438047013
		Low Profile Gauge - 653 Series and SOV for 651/651/653: 0-25 bar Scale with NBR seals	651 652	M699AG438047003
		Low Profile Gauge - 653 Series and SOV for 651/651/653: 0-25 bar Scale with FKM seals	651 652	M699AG438047015
		Pressure Range Indicators (Red/Green) for Low Profile Gauges. Desired range can be easily set in the field. This kit allows customers to add the pressure range indicator to existing low profile gauges in the field.	651 652	M699AG500179001
		Low Profile Gauge with Pressure Range Indicator - 651/651/653 Series: 0-90 PSI Scale with NBR seals	651 652	M699AG438047011
		Low Profile Gauge with Pressure Range Indicator - 651/651/653 Series: 0-175 PSI Scale with NBR seals	651 652	M699AG438047010
		Low Profile Gauge with Pressure Range Indicator - 653 Series: 0-375 PSI Scale with NBR seals	651 652	M699AG438047012
Low Profile Gauge with Pressure Range Indicator - 651/651/653 Series: 0-6 bar Scale with NBR seals		651 652	M699AG438047008	
Low Profile Gauge with Pressure Range Indicator - 651/651/653 Series: 0-12 bar Scale with NBR seals		651 652	M699AG438047007	
Low Profile Gauge with Pressure Range Indicator - 653 Series and SOV for 651/651/653: 0-25 bar Scale with NBR seals		651 652	M699AG438047009	

Repair Kits and Service Parts







651/652 Series - Spare Parts Kits

		Description	Series	Kit Number
Digital Gauge		Digital Pressure Gauge - 651/651/653 Series: 0-145 PSI Scale (User can change units; bar, MPa, Kg/cm ²) 1/8" NPTF	651 652	M699AG504650001
		Digital Pressure Gauge - 651/651/653 Series: 0-145 PSI Scale (User can change units; bar, MPa, Kg/cm ²) 1/8" ISO 7/1 Rc	651 652	M699AG504650002
Round Gauges*		Round Gauge - 0-60 PSI Series 1/8 NPTF and 1.5" Face Diameter	651 652	214-116
		Round Gauge - 0-160 PSI Series 1/8 NPTF and 1.5" Face Diameter	651 652	214-103
		Round Gauge - 0-300 PSI 1/8 NPTF and 1.5" Face Diameter	651 652	214-118
		Round Gauge - 0-60 PSI 1/8 ISO 7/1 Rc and 1.5" Face Diameter	651 652	RA060
		Round Gauge - 0-160 PSI 1/8 ISO 7/1 Rc and 1.5" Face Diameter	651 652	214-153
		Round Gauge - 0-300 PSI 1/8 ISO 7/1 Rc and 1.5" Face Diameter	651 652	RA300A
		Round Gauge - 0-4 bar 1/8 ISO 7/1 Rc and 40mm Face Diameter (Europe)	651	34300015
		Round Gauge - 0-10 bar 1/8 ISO 7/1 Rc and 40mm Face Diameter (Europe)	651	34300014
		Round Gauge - 0-12 bar 1/8 ISO 7/1 Rc and 40mm Face Diameter (Europe)	651	34300041
		Round Gauge - 0-25 bar 1/8 ISO 7/1 Rc and 50mm Face Diameter (Europe)	651 652	34200063
		Round Gauge - 0-4 bar 1/8 ISO 7/1 Rc and 50mm Face Diameter (Europe)	652	34200061
		Round Gauge - 0-12 bar 1/8 ISO 7/1 Rc and 50mm Face Diameter (Europe)	652	34200062
		Round Gauge - 0-16 bar 1/8 ISO 7/1 Rc and 50mm Face Diameter (Europe)	652	34200997
Port Plates		Gauge Port Plate Assembly - 1/8 NPTF	651 652	M699AG440510001
		Gauge Port Plate Assembly - 1/8 ISO 7/1 Rc	651 652	M699AG440510002
Pressure Switch/Sensor		DPS280 Pressure Switch/Sensor - NPN M8 with Cable 1/8 ISO 7/1 Rc	651 652	DPS280NRQ8
		DPS280 Pressure Switch/Sensor - PNP M8 with Cable 1/8 ISO 7/1 Rc	651 652	DPS280PRQ8
		DPS280 Pressure Switch/Sensor - NPN M8 with Cable 1/8 NPTF	651 652	DPS280NNQ8
		DPS280 Pressure Switch/Sensor - PNP M8 with Cable 1/8 NPTF	651 652	DPS280PNQ8
		Pressure Switch: 1/8 NPTF, 20-130 PSI (1.4 to 9 bar) range, Brass/NBR 3 PIN M12 connection (12mm); IP65 (Pin out is compatible with G3 Fieldbus Digital I/O)	651 652	PS182CAN01-2
		Pressure Switch: 1/8 NPTF, 20-130 PSI (1.4 to 9 bar) range, Brass/NBR 3 PIN M12 connection (12mm); IP65	651 652	PS182CAN01
		Pressure Switch: 1/8 BSPP, 20-130 PSI (1.4 to 9 bar) range, Brass/NBR 3 PIN M12 connection (12mm); IP65	651 652	PS182CAG01
		Pressure Switch: 1/8 NPTF, 14 - 150 PSI (1 to 10 bar) range, Zinc Plated Steel/NBR Polyamide Connector Material, 4 PIN DIN Connector; IP65	651 652	PS180CAN01
		Connector/Cord-set for PS182 - 90° Elbow: 5 Meter cable	651 652	PS182-5-90
		Connector/Cord-set for PS182 - Straight: 5 Meter cable	651 652	PS182-5-ST

* Each of the Low Profile and Round Gauges are dual scale; consult factory for further information. The scale that is listed in the description has the units located near the outside of the scale. The other units would be on the inside.



















Note: For all pressure switches & round gauges that are added to series products in the field, a port plate is required. The port plate can be added at the time of order entry or as a kit.

Repair Kits and Service Parts
651/652 Series - Spare Parts Kits



		Description	Series	Kit Number
Lubricator Repair Kits		Lubricator dome repair kit - NBR seals. Includes dome cover, screw and o-rings.	651 652	M699AY506842001
		Lubricator dome repair kit - FKM seals. Includes dome cover, screw and o-rings.	651 652	M699AY506842002
		Lubricator Level Switch assembly kit. Includes level switch, stainless steel retainer ring, O-Ring and bushing.	651 652	M699AG506837001
		Lubricator Bowl Plug assembly: Includes Lubricator bowl plug, stainless steel retainer ring and NBR O-Ring.	651 652	M699AQ440512001
Filter Kits		Particulate Filter Repair Kit - Includes the filter retainer, head baffle, lower end cap and bowl baffle.	651	M651AY570170001
			652	M652AY506833001
		Differential Pressure Pop-Up Indicator (NBR Seals) This is used for the Coalescing Filters to provide visual indication when the filter element needs to be replaced.	651 652	M699AG439851001
		Differential Pressure Pop-Up Indicator (FKM Seals) This is used for the Coalescing Filters to provide visual indication when the filter element needs to be replaced.	651 652	M699AG439851004
		DPI Plug (NBR Seals) This is used to plug the top port on the filter when a Differential Pressure Indicator is not used.	651 652	M699AG439851002
		DPI Plug (FKM Seals) This is used to plug the top port on the filter when a Differential Pressure Indicator is not used.	651 652	M699AG439851005
	Electric Differential Pressure Indicator (NBR Seals) This is used for the Coalescing Filter only. It provides a contact that will actuate when the filter element needs to be replaced.	651 652	M699AG439851003	

Repair Kits and Service Parts

651/652 Series - Spare Parts Kits

	Description	Series	Kit Number
Regulator & Filter Regulator Kits	 Adjusting Screw Repair Kit - Includes adjusting screw, nut, washer and screw	651	M651AY507149001
		652	M652AY506952001
	 Key Lockable Adjusting Screw Repair Kit - Includes adjusting screw, adjusting nut, flat washer and screw	651	M651AY507149002
		652	M652AY506952002
	 Tamper Resistant Repair Kit - Includes adjusting screw, adjusting nut, flat washers and screws	651	M651AY507149003
		652	M652AY506952003
	 Replacement knob for regulator or filter-regulators.	651	M651AY519042001
		652	M652AY519042003
	 Replacement knob for the tamper resistant or key lockable regulator or filter-regulators	651	M651AY519042002
		652	M652AY519042004
	 Poppet Repair Kit (NBR Seals): Includes poppet, stem & seals.	651	M651AY507175001
		652	M652AY506863001
	 Poppet Repair Kit (FKM Seals): Includes poppet, stem & seals.	651	M651AY507175002
		652	M652AY506863002
	 Diaphragm Assembly Repair Kit (Pilot Operated Regulator NBR Seals)	652	M652AH435268001
	 Diaphragm Assembly Repair Kit (Pilot Operated Regulator FKM Seals)	652	M652AH435268002
	 Diaphragm Assembly Repair Kit (Relieving Regulator NBR Seals)	651	M651AH504954001
		652	M652AH434213001
	 Diaphragm Assembly Repair Kit (Relieving Regulator FKM Seals)	651	M651AH504954002
		652	M652AH434213002
 Diaphragm Assembly Repair Kit (Non-Relieving Regulator NBR Seals)	651	M651AH504954003	
	652	M652AH434213003	
 Diaphragm Assembly Repair Kit (Non-Relieving Regulator - FKM Seals)	651	M651AH504954004	
	652	M652AH434213004	
 Main Spring (45 PSIG/3 bar)	651	M651AY514010001	
	652	M652AY513313001	
 Main Spring (60 PSI/4 bar)	651	M651AY504691001	
	652	M652AY438708001	
 Main Spring (125 PSI/8 bar)	651	M651AY504692001	
	652	M652AY438709001	
 Main Spring (145 PSI/10 bar)	651	M651AY514011001	
	652	M652AY513314001	
Bowl Seal Kits	 U-Cup Seal Kit (NBR Seals) Kit contains 10 U-Cup seals. This seal is used for all bowls	651	M651AH507403001
		652	M652AH507085001
	 U-Cup Seal Kit (FKM Seals) Kit contains 10 U-Cup seals. This seal is used for all bowls	651	M651AH507403002
		652	M652AH507085002

Repair Kits and Service Parts
651/652 Series - Spare Parts Kits

		Description	Series	Part/Kit Number
3/2 Slow-Start/ Quick Exhaust Valve Kits		Horizontal Solenoid Operator (190) - With Manual Override	651 652	19090017
		Horizontal Solenoid Operator (190) - Without Manual Override	651 652	19090005
		24 VDC coil with 3 Pin M12 Connection, for Horizontal Solenoid Operator	651 652	43005525
		24 VDC coil with DIN Spade connection for Horizontal Solenoid Operator	651 652	43004473
		120 VAC coil with DIN Spade connection for Horizontal Solenoid Operator	651 652	43004471
		24 VAC coil with DIN Spade connection for Horizontal Solenoid Operator	651 652	43004469
		240 VAC coil with DIN Spade connection for Horizontal Solenoid Operator	651 652	43004472
		DIN Connector, without LED - Horizontal Solenoid Operator	651 652	88122602
		DIN Connector, with LED, for 24 VAC/DC coil - Horizontal Solenoid Operator	651 652	88122603
		DIN Connector, with LED, for 120 VAC coil - Horizontal Solenoid Operator	651 652	88122605
	DIN Connector, with LED, for 240 VAC coil - Horizontal Solenoid Operator	651 652	88122608	
		Vertical Solenoid Operator (189) - Without Manual Override	651 652	18990007
		24 VDC coil with 3 Pin M12 Connection, for Vertical Solenoid Operator	651 652	43005523
		24 VDC coil with DIN Spade connection for Vertical Solenoid Operator	651 652	43004166
		120 VAC coil with DIN Spade connection for Vertical Solenoid Operator	651 652	43004419
		24 VAC coil with DIN Spade connection for Vertical Solenoid Operator	651 652	43004416
		240 VAC coil with DIN Spade connection for Vertical Solenoid Operator	651 652	43004422
		DIN Connector, without LED - Vertical Solenoid Operator	651 652	88122404
		DIN Connector, with LED, for 24 VAC/DC coil - Vertical Solenoid Operator	651 652	88122405
		DIN Connector, with LED, for 120 VAC coil - Vertical Solenoid Operator	651 652	88122407
DIN Connector, with LED, for 240 VAC coil - Vertical Solenoid Operator		651 652	88122410	
		Jumper Plate Kit: For Air Operated Internally Piloted 3/2 Slow-Start/QE Valve	651 652	M699AY513316001
		Pilot Port Plate: For Air Operated Externally Piloted 3/2 Slow-Start/QE Valve	651 652	M699AY513318001
		Pilot Port Plate: For Air Operated Externally Piloted 3/2 Slow-Start/QE Valve, 1/8 NPT	651 652	M699AY513318002

Accessories

651/652 Series - Accessories

		Description	Series	Kit Number
Scissor Lock		Scissor Lock for Shut-Off Isolation Valve & Lockout Valve	651 652	VB-1
Mufflers/ Silencers		Metal Muffler – 1/4 NPTF (Shut-Off Isolation Valves & Slow-Start/Quick Exhaust Valves)	651 652	M2MN
		Metal Muffler – 1/2 NPTF (Slow-Start/Quick Exhaust & Lockouts)	651 652	M4MN
		Polyethylene Muffler – 1/4 NPTF (Shut-Off Isolation Valves & Slow-Start/Quick Exhaust)	651 652	E2MN
		Polyethylene Muffler – 1/2 NPTF (Slow-Start/Quick Exhaust & Lockouts)	651 652	E4MN
Key Lock		Key lock for regulator and filter-regulator supplied seperately with 2 keys	651 652	M699AY438663001

NOTES

NOTES

NOTES



World Headquarters

USA - Numatics, Incorporated

46280 Dylan Drive
Novi, Michigan 48377

P: 248-596-3200
F: 248-596-3201

Canada - Numatics, Ltd

P: 519-758-2700
F: 519-758-5540

México - Ascomatica SA de CV

P: 52 55 58 09 56 40 (DF y Area metropolitana)
P: 01 800 000 2726 (Interior de la República)
F: 52 55 58 09 56 60

Brazil - Ascoval Ind.e Comercio Ltda

P: (55) 11-4208-1700
F: (55) 11-4195-3970