

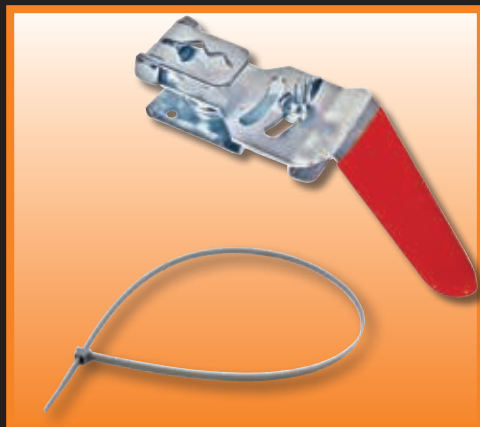

AIR REGULATION CONTROL EQUIPMENT

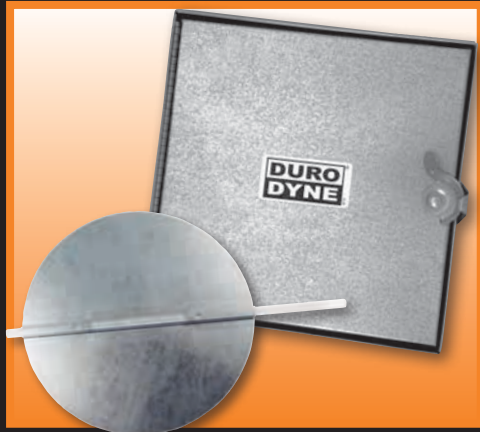

PRODUCT CATALOG

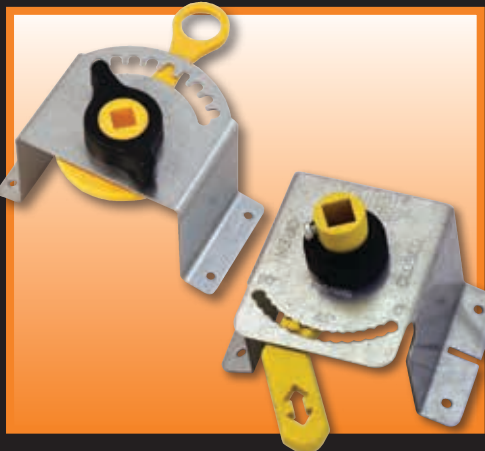

TABLE OF CONTENTS

ECONOMY STANDOFF REGULATOR.....2
DURO-TWIST™ REGULATORS.....3
DYNA-CLICK® REGULATORS.....3
STANDOFF REGULATORS.....2-4
QUADLINE™ REGULATORS.....4-5
SPEC-SEAL™ UNIVERSAL REGULATOR.....5
UNIVERSAL REGULATOR.....5
SPEC SEAL END BEARING SUPPORT KITS.....5
STAMPLINE™ REGULATORS.....6
SPECLINE® REGULATORS & DAMPER PARTS.....7-8
END BEARINGS.....9
JIFFY DAMPERS.....9
HAMMER ON DAMPER HARDWARE & ACCESSORIES.....10
MULTI-BLADE DAMPER HARDWARE.....11

BLADE EDGING.....12
SIDE SEALS.....12
MULTI-BLADE DAMPER PARTS.....12-13
ACCESS DOORS.....14
ACCESS DOOR LOCKING DEVICES.....15
GASKETING.....15
INSTRUMENT TEST PORTS.....16
HINGES.....16
FIRE DAMPER HARDWARE.....16
HANGING STRAP.....16
DYN-O-TIE®.....17
DYN-O-TIE GUN.....17
STAINLESS STEEL DYNA-CLAMPS™.....18
STAINLESS STEEL PARTS.....18-19

ECONOMY STANDOFF REGULATOR

UNIVERSAL ECONOMY STANDOFF REGULATOR

The Universal Economy Standoff Regulator from Duro Dyne is a hand operated elevated regulator designed for use with 1/4" or 3/8" square rod on externally insulated duct. The unique 10 degree foot allows the same regulator to be used on both square or round ductwork, alleviating the need to stock multiple regulators. It is offered in four standoff heights: 1", 1-1/2", 2" & 3". The handle is locked in place with a heavy duty high torque stamped wing nut and clearly shows damper position with embossed designations for open and closed. Reinforcing gussets in four locations add to the rigidity of this regulator. An optional score and Heto Notch allows the UESO to work for multiple damper fitting applications including Hetos.

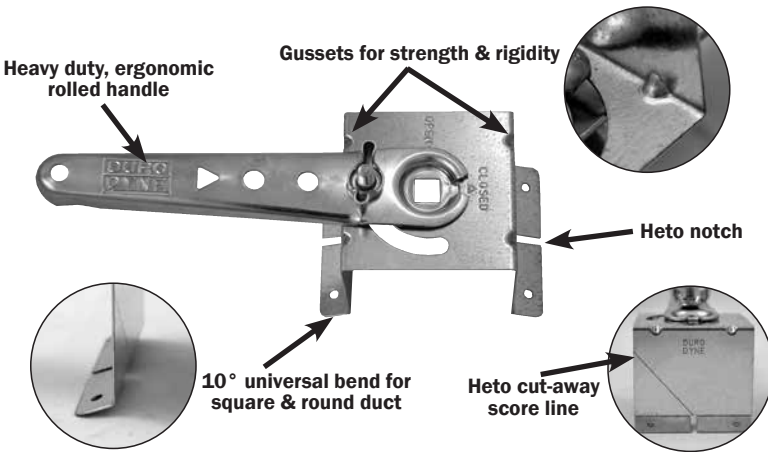

UESO - UNIVERSAL ESO			
ITEM#	CODE	SHAFT SIZE	STAND HEIGHT
6369	UESO-14-100	1/4" sq.	1"
6370	UESO-14-150	1/4" sq.	1-1/2"
6371	UESO-14-200	1/4" sq.	2"
6372	UESO-14-300	1/4" sq.	3"
6373	UESO-38-100	3/8" sq.	1"
6374	UESO-38-150	3/8" sq.	1-1/2"
6375	UESO-38-200	3/8" sq.	2"
6376	UESO-38-300	3/8" sq.	3"
6377	UESO-12-100	1/2" sq.	1"
6378	UESO-12-150	1/2" sq.	1-1/2"
6379	UESO-12-200	1/2" sq.	2"
6380	UESO-12-300	1/2" sq.	3"

Seal Kits Sold Separately.

SEAL FOR STANDOFF WITH ECONOMY HANDLE

SES0-38-214



ESO SEAL		
ITEM#	CODE	FOR USE WITH STAND HEIGHT
7245	SES0-38-214	2"

Seal is always 1/4" larger for tighter seal.

DURO-TWIST™ REGULATORS

The Duro-Twist is a hand operated elevated regulator designed for use with square rod on both square and round externally insulated duct. It is offered in two standoff heights: 1-1/2" & 2". The Duro-Twist is engineered with a strong friction resistance so it stays set without any need to lock it in place. The high visibility yellow handle allows it to be easily found in the field on wrapped duct. The handle position illustrates damper blade position on the outside of the ductwork.

Manual operation (no tools)

10° angled stand to accommodate both square and round duct

The wing nut has a locking feature molded into the nut. This secure locked fit eliminates any movement from duct system vibration.

Rubber 'O' Ring immobilizes the handle to eliminate rattling

DURO-TWIST			
ITEM#	CODE	SHAFT SIZE	STAND HEIGHT
6324	DT38150	3/8" sq.	1-1/2"
6325	DT38200	3/8" sq.	2"

DYNA-CLICK® REGULATORS

Dyna-Click is the latest in self-locking regulators offered by Duro Dyne. This 15 position indexing regulator features a triggerless 3/4" twist locking nut that fixes the regulator in place once set. Designed for use with square rod on both square and round externally insulated duct, it is offered in two standoff heights, 1-1/2" & 2". The Dyna-Click is engineered with a heavy duty spring so it stays set once clicked into place. The high visibility yellow handle allows it to be easily found in the field on wrapped duct.

Set screw to secure 3/8" rod in place

Marking on regulator easily show the open-close positions

15 position settings

Pre-notched feet for use with hetro application. Simply cut to the notch with a snip.

CDC Dyna-Click with cast metal handle

DYNA-CLICK			
ITEM#	CODE	SHAFT SIZE	STAND HEIGHT
6320	DC38150	3/8" sq.	1-1/2"
6321	DC38200	3/8" sq.	2"
6295	CDC38150	3/8" sq.	1-1/2"
6296	CDC38200	3/8" sq.	2"

STANDOFF REGULATORS

STANDOFF WITH *SPECLINE*® REGULATOR

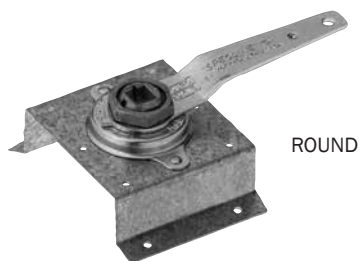
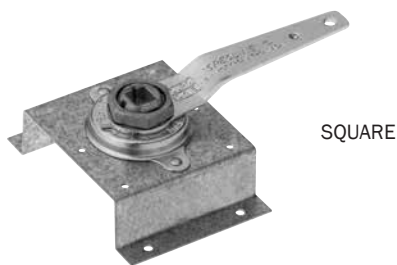

SRST SERIES FOR SQUARE DUCT			
ITEM#	CODE	SHAFT SIZE	STAND HEIGHT
8184	SRST 1-148 w/SRHS-148	1/4" sq.	1"
8318	SRST 1-1/2-148 w/SRHS-148	1/4" sq.	1-1/2"
8196	SRST 2-148 w/SRHS-148	1/4" sq.	2"
8019	SRST 1-388 w/SRHS-388	3/8" sq.	1"
8020	SRST 1-1/2-388 w/SRHS-388	3/8" sq.	1-1/2"
8021	SRST 2-388 w/SRHS-388	3/8" sq.	2"

Packed 10 Per Carton. 1/2" available upon request.

SRST SERIES FOR ROUND DUCT			
ITEM#	CODE	SHAFT SIZE	STAND HEIGHT
7353	SRST1R-148 w/SRHS-148	1/4" sq.	1"
7354	SRST1-1/2R-148 w/SRHS-148	1/4" sq.	1-1/2"
7355	SRST2R-148 w/SRHS-148	1/4" sq.	2"
7350	SRST1R-388 w/SRHS-388	3/8" sq.	1"
7351	SRST1 1/2R-388 w/SRHS-388	3/8" sq.	1-1/2"
7352	SRST2R-388 w/SRHS-388	3/8" sq.	2"

Packed 10 Per Carton. 1/2" available upon request.

STANDOFF REGULATORS (CONTINUED)

STANDOFF WITH STAMPLINE™ 1/4" DIAL REGULATOR (FOR DAMPERS UP TO 10")

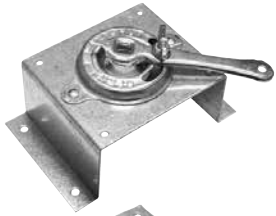

SQUARE

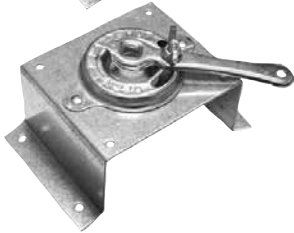

ROUND

K2 SERIES FOR SQUARE DUCT			
ITEM#	CODE	SHAFT SIZE	STAND HEIGHT
7364	K2-1	1/4" sq.	1"
7365	K2-150	1/4" sq.	1-1/2"
7366	K2-2	1/4" sq.	2"
Packed 10 Per Carton.			

K2 SERIES FOR ROUND DUCT			
ITEM#	CODE	SHAFT SIZE	STAND HEIGHT
7362	K2-1R	1/4" sq.	1"
8197	K2-150R	1/4" sq.	1-1/2"
7363	K2-2R	1/4" sq.	2"
Packed 10 Per Carton.			

STANDOFF WITH STAMPLINE™ 3/8" DIAL REGULATOR (FOR DAMPERS UP TO 20")

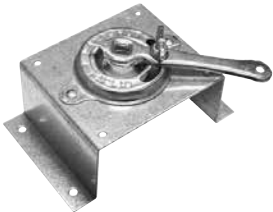

SQUARE

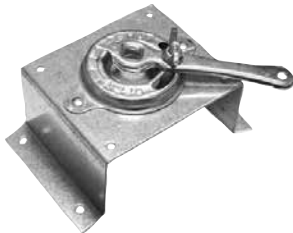

ROUND

KR Series available in stainless steel. See page 18.

KR SERIES FOR SQUARE DUCT			
ITEM#	CODE	SHAFT SIZE	STAND HEIGHT
8304	KR3-1	3/8" sq.	1"
8310	KR3-150	3/8" sq.	1-1/2"
7360	KR3-2	3/8" sq.	2"
Packed 10 Per Carton.			

KR SERIES FOR ROUND DUCT			
ITEM#	CODE	SHAFT SIZE	STAND HEIGHT
7361	KR3-1R	3/8" sq.	1"
8366	KR3-150R	3/8" sq.	1-1/2"
7359	KR3-2R	3/8" sq.	2"
Packed 10 Per Carton.			

QUADLINE™ REGULATORS SETS AND PARTS

These heavy gauge plated steel quadrants are designed with excellent handle action as well as quick wing nut adjustment and locking of the damper. The frame is marked to show the exact position of the damper. For use on square or round ducts.

3/8" QUADRANT SETS (FOR DAMPERS UP TO 20")



3/8" QUADRANT SETS		
ITEM#	CODE	SET CONSISTS OF:
8050	KS38	K-4 quadrant; KP-9R round end bearing; KP-9S square end bearing
8051	KS385	K-4 quadrant; KP-7 spring loc bearing; KP-9S long square end bearing
8049	KS385L	K-4 quadrant; KP-7L long spring loc bearing; KP-9L long square end bearing
Packed 1 Set Per Carton		
8059	K4	3/8" quadrant only
Packed 100 per Carton		

1/2" QUADRANT SETS (FOR DAMPERS UP TO 30")



1/2" QUADRANT SETS		
ITEM#	CODE	SET CONSISTS OF:
8052	KS12	K-5 quadrant; KP-10R round end bearing; KP-10S square end bearing
Packed 1 Set Per Carton		
8060	K5	1/2" quadrant only
Packed 100 per Carton		

QUADLINE™ REGULATORS

SETS AND PARTS (CONTINUED)

1/2" SHAFT LOC QUADRANT SETS (FOR DAMPERS UP TO 30")

"**Shaft Loc**" Quadrants are stamped of heavy gauge steel and clearly indicate the position of the damper. The quadrant handle (available for either 1/2" square or round shafts) is unique in that it locks the shaft of the damper to it by means of a powerful friction holding device strong enough to cut into the damper shaft eliminating damper rattle. The shaft is easily locked with 1/2" open end wrench. Available for square or round ducts.



ROUND



SQUARE

1/2" SHAFT LOC QUADRANT SETS

ITEM#	CODE	SHAFT DESCRIPTION
8063	KL7	1/2" square Shaft loc quadrant
8064	KL7R	1/2" round Shaft loc quadrant
Packed 100 Per Carton		

SPEC-SEAL™ UNIVERSAL REGULATOR & SET

The Spec-Seal Universal Regulator Set utilizes a special rubber seal for applications up to 500°F constant temperature. It eliminates leakage and rattle via the Shaft Loc Mechanism in high pressure systems. The handle's unique design utilizes a highly-visible orange plastic cover showing the damper position. This unit, made of heavy-gauge, zinc-plated steel, accommodates four styles of end bearings: 3/8" and 1/2" with both round or square bearing shafts. It is also available in stainless steel. Individual parts available upon request.

Select items available in stainless steel. See page 18.

Each Set Consists of:

- Regulator
- 2 Rubber Seals
- 2 Metal Washers
- 2 End Bearings
- End Bearing Support

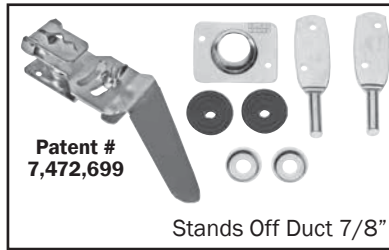

SPEC-SEAL™

ITEM#	CODE	BEARING TYPE
8153	AL38	3/8" Square
8154	AL38R	3/8" Round
8158	AL38L	3/8" Square Long
8152	AL12R	1/2" Round
Quantity per carton: 10 sets		

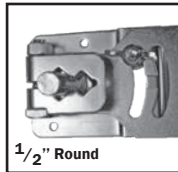

1/2" Round

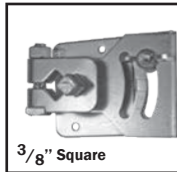

3/8" Square

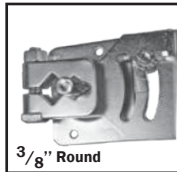

3/8" Round

UNIVERSAL REGULATOR™

- Universal - one regulator for 3/8" and 1/2"; round or square rods.
- Clamp on handle for snug and rattle free fit to bearing or rod.
- Unique "quick set up" handle allows shift from 1/2" to 3/8" without disassembling the regulator.
- **Shaft loc** mechanism to eliminate rattle
- High visibility handle; shows damper direction.
- Heavy gauge, zinc plated steel.
- Optional Seal Kit - available for low leakage applications.
- Also available in Stainless Steel - Please see page 19.

UNIVERSAL REGULATOR		
ITEM#	CODE	DESCRIPTION
8270	MSR03812	3/8 & 1/2" Multisize Regulator Only
Quantity per carton: 10		

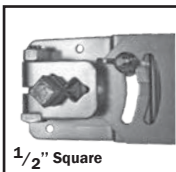
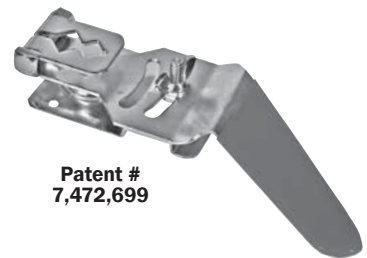

1/2" Square

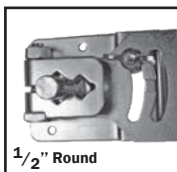

1/2" Round

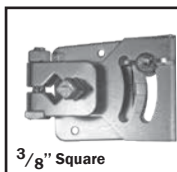

3/8" Square

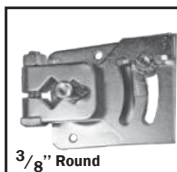

3/8" Round

SPEC-SEAL™ END BEARING SUPPORT KITS



SPEC-SEAL™ END BEARING SUPPORT KITS

ITEM#	CODE	BEARING TYPE
8162	EB12R	1/2" Round Bearing Support Housing

STAMPLINE REGULATORS

FOR CONTROLLING SMALL DAMPERS

1/4" "JIFFY" REGULATOR SETS (FOR DAMPERS UP TO 10")



These efficient, low cost, heavy gauge, plated steel regulators install in a "jiffy" by slipping the washer and handle over the threaded square end bearing. The wing nut locks the damper in position. The position of the handle indicates the position of the damper in the duct. For use on round or square ducts.

1/4" "JIFFY" REGULATOR SETS		
ITEM#	CODE	SET CONSISTS OF
8039	KS7	KP5 1/4" threaded bearing, handle; KP-6 spring loc bearing, bevelled wingnut & washer
8046	KS7L	KP5L 1/4" long threaded bearing, handle; KP-6L long spring loc bearing, bevelled wingnut & washer
Packed 10 Per Carton; 10 cartons per box.		
8102	JB1	KP5 1/4" threaded bearing, handle; wingnut & washer
8220	JB1L	KP5L 1/4" long threaded bearing, handle; wingnut & washer
8295	JB1XL	KP5XL 1/4" extra long threaded bearing, handle; wingnut & washer
Packed 100 Per Carton.		

1/4" DIAL REGULATOR SETS AND BEARINGS (FOR DAMPERS UP TO 10")



These heavy gauge plated steel regulators are among the most popular on the market. They minimize air leakage and reduce rattle. A wing nut locks the damper in position, yet permits quick readjustment. The dial shows the damper position at a glance. The regulator mounts easily on round or square ducts.

1/4" DIAL REGULATOR SETS		
ITEM#	CODE	SET CONSISTS OF
8040	KS14	K-2 regulator; KP-8S square end bearing; KP-8R round end bearing
8041	KS145	K-2 regulator; KP-6 spring loc bearing; KP-8S square end bearing
8047	KS145L	K-2 regulator; KP-6L long spring loc bearing; KP-8L long square end bearing
7384	KS145XLS	K-2 regulator; KP-6 spring loc bearing; KP-8XL extra long square end bearing
Packed 10 Per Carton; 10 cartons per box.		
8056	K2	1/4" regulator only
Packed 100 Per Carton.		

FOR CONTROLLING LARGER DAMPERS

3/8" DIAL REGULATOR SETS AND END BEARINGS (FOR DAMPERS UP TO 20")



The following sets and parts are the same as the 1/4" size shown above except designed for larger dampers. The 3/8" bearings and regulator are suitable to use on round as well as square duct. Clear markings on the regulator indicate the damper position which can be locked securely by a wing nut. The regulator only is also available in stainless steel - see page 18.

3/8" dial regulator available in stainless steel. See page 18.

3/8" DIAL REGULATOR SETS		
ITEM#	CODE	SET CONSISTS OF
8044	KSR19	KR-3 regulator; KP-9R round end bearing; KP-9S square end bearing
8045	KSR195	KR-3 regulator; KP-7 spring loc bearing; KP-9S square end bearing
8139	KSR195L	KR-3 regulator; KP-7L long spring loc bearing; KP-9L long square end bearing
7383	KSR195XLS	KR-3 regulator; KP-7 spring loc bearing; KP-9XL extra long square end bearing
Packed 1 Set Per Carton		
8058	KR3	3/8" dial regulator only
Packed 100 Per Carton		

3/8" "WEDGE-LOC®" REGULATOR SETS (FOR DAMPERS UP TO 20")



This attractive rectangular regulator features exclusive "Wedge Loc" action which firmly locks the bearing to the regulator handle when the damper is set - preventing rattling. Heavy construction, minimum air leakage and easy adjustability make this ideal for large dampers in round or square ducts.

3/8" WEDGE 'LOC' REGULATOR SETS		
ITEM#	CODE	SET CONSISTS OF
8042	KS19	K3 regulator; KP-9S spring end bearing; KP-9R round end bearing
8043	KS195	K-3 regulator; KP-7 spring loc bearing; KP-9S square end bearing
8048	KS195L	K-3 regulator; KP-7L long spring loc bearing; KP-9L long square end bearing
Packed 1 Set Per Carton		

SPECLINE - STAMPLINE REGULATOR SET



3/8" OPEN-CLOSED REGULATOR SET		
ITEM#	CODE	SET CONSISTS OF
6338	SBKS385L	K4 Quadrant, KP9L Long Square End Bearing, KP7L Long Spring Loc Bearing, SB138 3/8" Open End Bearing, SB338 3/8" Closed End Bearing

SPECLINE® REGULATORS

MINIMUM LEAKAGE DAMPER REGULATORS

Specline Regulators are designed for minimum leakage applications. Each regulator is comprised of a frame, an indicator handle, a serrated cast alloy and a cast alloy nut. Serrations on the cast alloy core mesh with serrations in the frame to firmly lock the regulator in position. A spring washer situated between the core and the cast frame allows for smooth non-binding adjustment.

- All SR and SRH type regulators include a cast alloy frame and a neoprene frame gasket.
- The SRHS and SRS utilize a stamped frame and include a neoprene frame gasket.

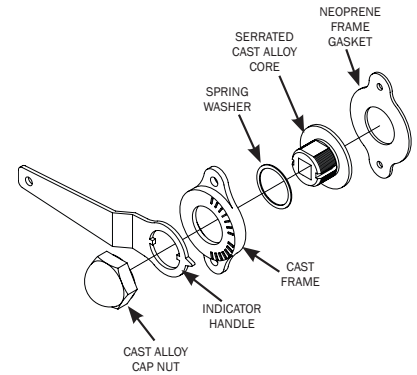

INDICATOR STYLE REGULATOR WITH HEX NUT AND ACORN NUT

Regulator Height 5/8"

Regulator Height 1-3/8"

- Cast Alloy Frame and Body
- Heavy Mounting Gasket
- Heavy Cast Indicator Dial
- Hex Nut



SRH Series



SR Series

INDICATOR STYLE CAST		
ITEM#	CODE	SHAFT SIZE & NUT
8012	SRH280	3/8" Hex Nut
8014	SRH220	1/2" Hex Nut
8003	SR380	3/8" Acorn Nut
8005	SR120	1/2" Acorn Nut
Packed 10 Per Carton		

HANDLE REGULATOR WITH HEX NUT AND ACORN NUT

Regulator Height 5/8"

Regulator Height 1-3/8"

- Cast Alloy Body
- Heavy Stamped Handle
- Hex Nut
- Solid Die Cast Core



SRH Series

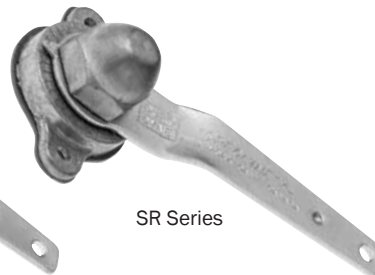

SR Series

HANDLE SET CAST		
ITEM#	CODE	SHAFT SIZE & NUT
8011	SRH248	1/4" Hex Nut
8013	SRH288	3/8" Hex Nut
8015	SRH228	1/2" Hex Nut
8002	SR148	1/4" Acorn Nut
8004	SR388	3/8" Acorn Nut
8006	SR128	1/2" Acorn Nut
Packed 10 Per Carton		

HANDLE STYLE (STAMPED) REGULATOR WITH HEX NUT & ACORN NUT

Regulator Height 5/8"

Regulator Height 1-3/8"

- Stamped Frame
- Heavy Stamped Handle
- Solid Die Cast Core
- Hex Nut

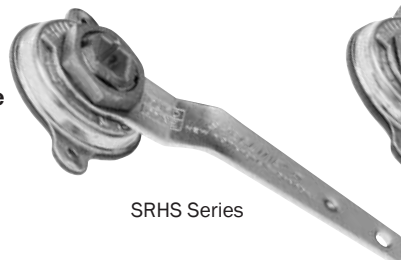

SRHS Series

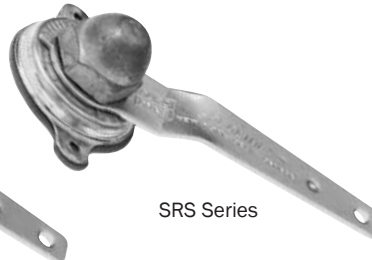

SRS Series

HANDLE SET (STAMPED)		
ITEM#	CODE	SHAFT SIZE & NUT
8016	SRHS148	1/4" Hex Nut
8017	SRHS388	3/8" Hex Nut
8018	SRHS128	1/2" Hex Nut
8022	SRS148	1/4" Acorn Nut
8023	SRS388	3/8" Acorn Nut
8024	SRS128	1/2" Acorn Nut
Packed 10 Per Carton		

WIDE BASE HEX NUT REGULATOR

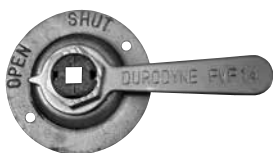

FVF Series

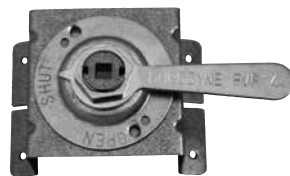

SFVF Series

FVF SERIES		
ITEM#	CODE	DESCRIPTION
6336	FVF14	1/4" Wide Base Hex Nut Regulator
6337	FVF38	3/8" Wide Base Hex Nut Regulator

FVF SERIES WITH STANDOFF		
ITEM#	CODE	DESCRIPTION
6309	SFVF14-1	1/4" Universal 1" Standoff Wide Base Dial Regulator
6310	SFVF14-1.5	1/4" Universal 1-1/2" Standoff Wide Base Dial Regulator
6311	SFVF14-2	1/4" Universal 2" Standoff Wide Base Dial Regulator
6312	SFVF14-3	1/4" Universal 3" Standoff Wide Base Dial Regulator
6313	SFVF38-1	3/8" Universal 1i" Standoff Wide Base Dial Regulator
6314	SFVF38-1.5	3/8" Universal 1-1/2" Standoff Wide Base Dial Regulator
6315	SFVF38-2	3/8" Universal 2" Standoff Wide Base Dial Regulator
6316	SFVF38-3	3/8" Universal 3" Standoff Wide Base Dial Regulator

SPECLINE® REGULATORS (CONTINUED)

90° ANGLE DRIVE DIE CAST MITRE GEAR ASSEMBLY

Will accommodate 3/8" square rod from duct



90° ANGLE DRIVE		
ITEM#	CODE	DESCRIPTION
8135	AD38	Mitre Gear Assembly
Packed 5 Per Carton		

CONCEALED STYLE REGULATOR SET WITH HEX NUT

Attractive cast alloy housing with a corrosion resistant plated cover

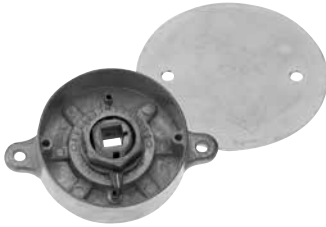

CONCEALED		
ITEM#	CODE	SHAFT SIZE
8007	SRC140	1/4" sq.
8008	SRC380	3/8" sq.
Packed 5 Per Carton		

SPECLINE PARTS AND ACCESSORIES

OPEN END BEARING CAST ALLOY



OPEN END		
ITEM#	CODE	SHAFT SIZE
8025	SB114	1/4" sq.
8027	SB138	3/8" sq.
8029	SB112	1/2" sq.
Packed 25 Per Carton		

CLOSED END BEARING CAST ALLOY



CLOSED END		
ITEM#	CODE	SHAFT SIZE
8026	SB314	1/4" sq.
8028	SB338	3/8" sq.
8030	SB312	1/2" sq.
Packed 25 Per Carton		

SPLITTER DAMPER HARDWARE

SPLITTER DAMPER BRACKET

Steel Bracket, Brass Pivot

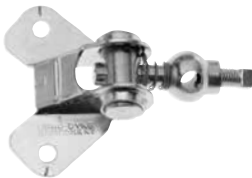

SPLITTER DAMPER		
ITEM#	CODE	SHAFT SIZE
8034	SRP40	1/4"
8035	SRP50	5/16"
Packed 25 Per Carton		

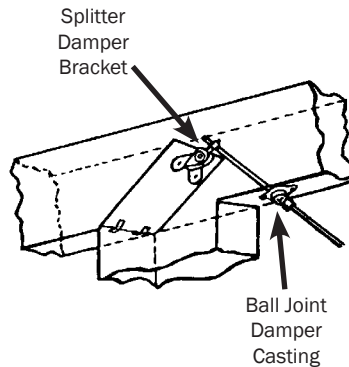

BALL JOINT DAMPER CASTING

Cast Alloy



BALL JOINT		
ITEM#	CODE	SHAFT SIZE
8032	SRP14	1/4"
8033	SRP516	5/16"
Packed 25 Per Carton		

END BEARINGS

(PACKED 100 PER CARTON)

Select items available in stainless steel. See page 19.



SPRING LOC		
ITEM#	CODE	APPROX. DIM.
8065	KP6	1/4" x 2"
8066	KP7	3/8" x 2-11/16"



SPRING LOC LONG		
ITEM#	CODE	APPROX. DIM.
8241	KP6L	1/4" x 3-1/4"
8242	KP7L	3/8" x 3-3/4"



ROUND		
ITEM#	CODE	APPROX. DIM.
8070	KP9R	3/8" x 1-1/8"
8073	KP10R	1/2" x 1-1/4"



1/4" SQUARE THREADED		
ITEM#	CODE	APPROX. DIM.
8075	KP5	1/4" x 1-1/8"
8079	KP5XL	1/4" x 3-1/8"



1/4" SQUARE		
ITEM#	CODE	APPROX. DIM.
8068	KP8S	1/4" x 1-1/8"
8069	KP8L	1/4" x 2-1/8"
8077	KP8XL	1/4" x 3-1/8"
6270	KP8XXL	1/4" x 3-7/8"
6272	KP8XXXL	1/4" x 4-7/8"



3/8" SQUARE		
ITEM#	CODE	APPROX. DIM.
8071	KP9S	3/8" x 1-1/8"
8072	KP9L	3/8" x 2-1/8"
8247	KP9XL	3/8" x 3-1/8"
6271	KP9XXL	3/8" x 3-7/8"
6272	KP9XXXL	3/8" x 4-7/8"



1/2" SQUARE		
ITEM#	CODE	APPROX. DIM.
8074	KP10S	1/2" x 1-1/4"
8179	KP10L	1/2" x 2-1/4"

Spring Loc Example
KP6 #8065:

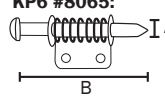

ITEM#	APPROX. DIM.
8065	1/4"(A) x 2"(B)

Square Example
KP8S #8068:

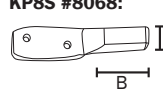

ITEM#	APPROX. DIM.
8068	1/4"(A) x 1-1/8"(B)

JIFFY DAMPERS

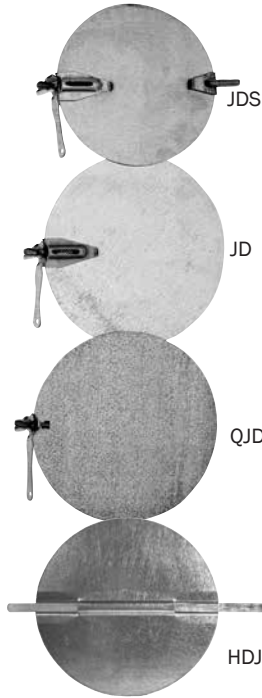

The "JDS" Series Jiffy Damper offers the contractor a quality round damper at a cost lower than most shop-made dampers. The Duro Dyne JDS series utilizes quality Rapit Spring and Rapit Solid End Bearing sets. (Packed 10 per carton only.)

The "JD" Series Jiffy Damper offers added economy in those applications where a supporting solid tail bearing is not required on the damper. The Duro Dyne JD Damper utilizes one Rapit Spring End Bearing. (Packed 10 per carton only.)

The "QJDE Series Jiffy Damper offers an inexpensive alternative for low pressure applications. The Duro Dyne Economy Damper utilizes one threaded stud as a support bearing. (Packed 100 per carton only.)

The Heavy Duty Jiffy Damper (HDJD) offers an economical alternative to in shop damper fabrication. It is manufactured of 22 gauge galvanized steel blades and comes pre-assembled. The 3/8" square rod extends 3 inches beyond the blade. The HDJD is compatible with Duro Dyne's ESO damper regulator assembly. (Packed 10 per carton only.)

JIFFY DAMPERS		
ITEM#	CODE	FOR DUCT SIZE DIA.
8092	JDS4	4"
8093	JDS5	5"
8094	JDS6	6"
8095	JDS7	7"
8096	JDS8	8"
8097	JDS9	9"
8137	JDS10	10"
7188	JDS12	12"
7189	JDS14	14"
8098	JD4	4"
8099	JD5	5"
8100	JD6	6"
8101	JD7	7"
8146	JD8	8"
8140	JD10	10"
6238	QJDE5H*	5"
6239	QJDE6H*	6"
6240	QJDE7H*	7"
6241	QJDE8H*	8"
6245	QJDE6HW**	6"
6246	QJDE7HW**	7"

*Bag unattached
 **Bag attached

HDJD DAMPERS					
ITEM#	CODE	FOR DUCT SIZE DIA.	ITEM#	CODE	FOR DUCT SIZE DIA.
7077	HDJD4	4"	7168	HDJD12	12"
7078	HDJD5	5"	7169	HDJD14	14"
7163	HDJD6	6"	7170	HDJD16	16"
7164	HDJD7	7"	7273	HDJD18	18"
7165	HDJD8	8"	7274	HDJD20	20"
7166	HDJD9	9"	7275	HDJD22	22"
7167	HDJD10	10"	7276	HDJD24	24"

HDJD DAMPERS - UNASSEMBLED					
ITEM#	CODE	FOR DUCT SIZE DIA.	ITEM#	CODE	FOR DUCT SIZE DIA.
6357	HDJD4UA	4"	6362	HDJD9UA	9"
6358	HDJD5UA	5"	6363	HDJD10UA	10"
6359	HDJD6UA	6"	6364	HDJD12UA	12"
6360	HDJD7UA	7"	6365	HDJD14UA	14"
6361	HDJD8UA	8"	6366	HDJD16UA	16"

HDJD DAMPER / UES038-200 REGULATOR / BKPRB83 BUSHING KITS

HDJD / UESO / BUSHING KITS		
ITEM#	CODE	FOR DUCT SIZE DIA.
6327	HDJD6S	3/8" Shaft w/ 6" Diameter Damper Kit
6328	HDJD8S	3/8" Shaft w/ 8" Diameter Damper Kit
6329	HDJD10S	3/8" Shaft w/ 10" Diameter Damper Kit
6330	HDJD12S	3/8" Shaft w/ 12" Diameter Damper Kit

HAMMER ON DAMPER HARDWARE & ACCESSORIES-

'RAPIT'[®] DAMPER REGULATOR

The **RAPIT** is an inexpensive, rattle-free regulator for quick installation on balance or splitter dampers. It is formed from rust-resistant, heavy gauge, galvanized steel and installs in seconds. The Rapit will penetrate and secure to round or rectangular damper blades up to 24 gauge steel. It has a fully retractable bearing of zinc alloy, threaded to accept a 5/16-18 wing nut and a handle that indicates the damper position. It's as easy to use as 1-2-3.

1. Slip the bearing over the edge of the damper at the bearing line.
2. Lay the assembly on any firm surface and rap the prong with a hammer. One blow drives the prong through the damper blade, holding it securely to the damper.
3. When hit with a hammer, the prong will automatically form up tight by the anvil, which is built into the bottom of the "Rapit" Bearing.

Note: Not recommended for use in systems over 300 °F.

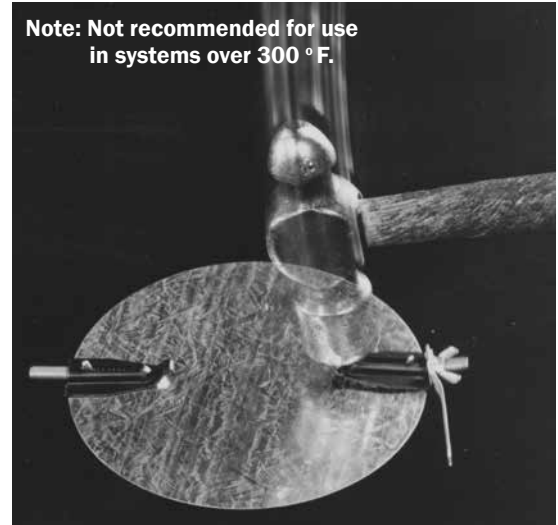

RAPIT REGULATOR SETS

ITEM#	CODE	CONSISTS OF:
8087	RB56	1 RB-50 Rapit spring bearing; 1 RP-3 washer; 1 RP-2 wing nut
8086	RS156	1 RB-50 Rapit spring bearing; 1 RP-3 washer; 1 RP-1 handle; 1 RP-2 wing nut
8085	RS256	2 RB-50 Rapit spring bearings; 1 RP-3 washer; 1 RP-1 handle; 1 RP-2 wing nut
8233	RS356	1 RB-50 Rapit spring bearing; 1 RB-25T threaded Rapit solid bearing; 1 RP-3 washer; 1 RP-1 handle; 1 RP-2 wing nut

SLIDE RAPIT[®] EXTENSION

The Slide Rapit Extension provides a fast method for extending the length of a rapit spring end bearing 2". There is no need for tools; just twist the extension fork over the threaded bearing and slip the sleeve over the joint. Slide Rapit Extensions can also be combined to accommodate liner thicker than 2".

Patent #
8,356,796

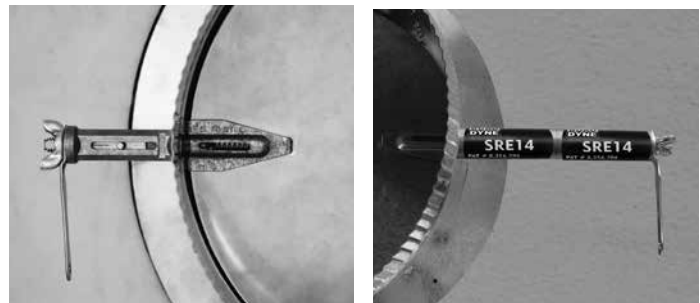

2" extension

Two combined Slide Rapit extensions



USEA516



SRE14

SLIDE RAPIT EXTENSION

ITEM#	CODE	DESCRIPTION
7079	USEA516	5/16" Slide Rapit Extension
7308	SRE14-14	1/4" Slide Rapit Extension

RAPIT[®] REGULATOR PARTS

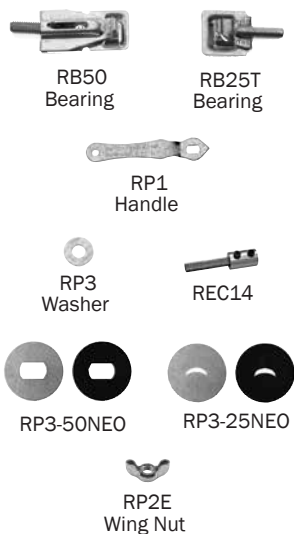

RAPIT REGULATOR PARTS

ITEM#	CODE	DESCRIPTION
8088	RB50	Rapit spring bearing
8201	RB25T	Threaded Rapit solid bearing
8089	RP1	Rapit handle
8090	RP2	Rapit wing nut
8091	RP3	Rapit washer
7190	RP3-50NEO	RB50 washer with neoprene
7191	RP3-25NEO	RB25 washer with neoprene
7388	REC14	1/4" Square Rapit Extension 2-3/4" long
7349	RP2E	5/16-18 Stamped Wing Nut
Packed 100 per carton* (*7388 packed 10 per carton)		
Bulk packing also available		

ECONO-STUD - ECONOMY DAMPER HARDWARE



ECONOMY DAMPER HARDWARE

ITEM#	CODE	DESCRIPTION
7031	ES14	1/4" Econo-Stud
7033	ES14W	1/4-20 Stamped Wing Nut
7035	ES14NW-NEO	1/4" Washer with Neoprene

MULTI-BLADE DAMPER HARDWARE

NEVA-BIND™ DURO BLADE KIT

FOR PARALLEL DAMPERS

Duro Dyne's "NEVA-BIND" Linkage Bracket will always align itself to assure smooth, non-binding operation even on the heaviest damper blades. Above, or at unequal distance from the blade axis, it is capable of adjusting itself all four ways, in-out, up-down, sideways and rotation. Each carton contains all necessary hardware for one blade of a parallel multi-blade damper.



PARALLEL		
ITEM#	CODE	BEARING SIZE
2002	BK2	1/2" ID.

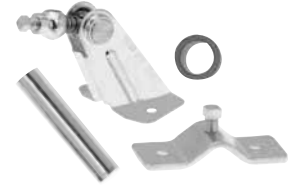

OPAX® BLADE KIT

FOR OPPOSED ACTION DAMPERS

Opposed Action Dampers minimize turbulence and the control of the air is more linear. Neva-Bind, 4 way self-adjustability which Duro Dyne "OPAX" kits feature, automatically compensates for any construction inaccuracies as well as maintaining linear operation and critical dimensions between linkage points. "OPAX" provides opposed action of damper blades and holds the blades rigidly in position eliminating rattle or flutter. These linkage kits contain all the necessary hardware for two opposed action damper blades.



OPPOSED		
ITEM#	CODE	BEARING SIZE
2003	BK03	7/16" ID.
2004	BK04	1/2" ID.

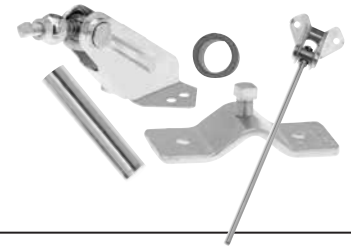

DAMPER ASSEMBLY UTILIZING SHOP MATERIALS

A. MAKING THE FRAME

(Same for both parallel and opposed dampers)

- Cut a piece of channel for the frame 1/4" less than the duct size, for clearance.
- SIDE FRAME:**
 - Mark off 5/16" from each end.
 - Divide the section inside these marks into as many parts as there are blades required.
 - Mark for each pivot at the center of each blade section (b).
 - Drill or punch a 5/8" hole at each pivot (c). Insert self-oiling bushings (tap fit).
- Weld the sides and bottoms of the frames. Be sure to keep them square.
- On large frames weld on corner braces to keep the frame square. Place any braces on the side of the frame which will not interfere with blade movement. Attach top and bottom end stops, if required. Cement felt, if required, with insulation adhesive.

B. MAKING THE BLADES

Same for both parallel and opposed dampers

1. Material:

Gauge	Blade Width	Activating Brackets Required per blade
20	to 36"	1
16	to 48"	1 or 2
12	to 52"	2

2. CUT:

- "WIDTH" dimension 3/16" less than the inside of frame.
- "HEIGHT" dimension: Allow for approximately 7/8" "shrinkage" due to forming; approximately 1/4" blade overlap; approximately 3/16" end clearance to frame.

3. MARK:

Mark the blades as shown and bend on the scribe lines.

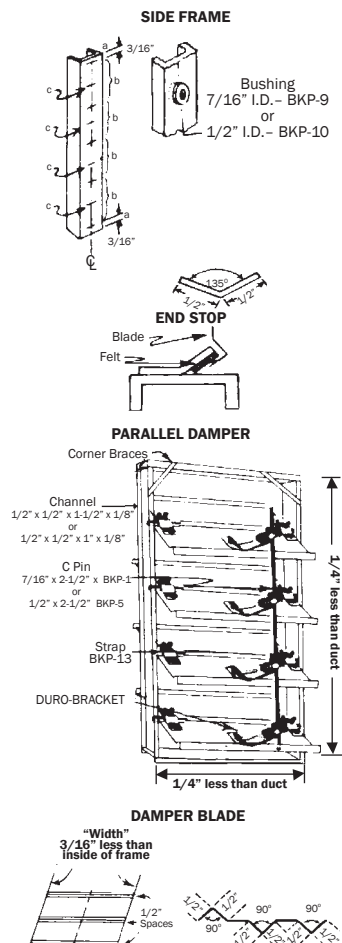

C. MOUNTING THE HARDWARE

"OPAX" HARDWARE

Attach the brackets as shown in drawing "B". (Always drive a "lo" blade, never a "hi" blade.)

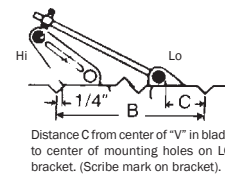

Dimension "B"	Distance "C"
5"	1"
6"	1-3/16"
7"	1-1/4"
8"	1-5/16"
9"	1-3/8"
10"	1-3/8"
11"	1-7/16"
12"	1-1/2"

PARALLEL HARDWARE

Attach the brackets at the center of blade.



Lean bracket here, against the edge of the "V"

DURO-BRACKET



D. ASSEMBLING THE DAMPER

- Lay the damper frame flat on the bench.
- Place the blades inside the frame in the approximate required position (correct overlap, etc.)
- Place 2 bearing pins in each center blade groove.
- Slide the pins under the straps (loosen the set-screws) and into the frame. Tighten the strap set-screws.
- Attach all linkage rods.

BLADE EDGING

White Vinyl



Grey Vinyl



Stainless Steel

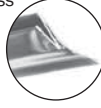

DAMPER BLADE EDGINGS

ITEM#	CODE	DESCRIPTION	LENGTH
2151	BKDBE2	White Vinyl	6 ft.
2156	BKDBE3	Grey Vinyl	6 ft.
2153	BKDBE-SSE	Stainless Steel	12 ft.

SIDE SEALS

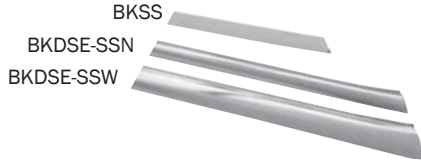

STAINLESS STEEL SIDE SEALS

ITEM#	CODE	DESCRIPTION
2077	BKSS	Side Seal
2154	BKDSE-SSN	Side Edging 1-1/2"
2155	BKDSE-SSW	Side Edging 2.59"

*For large runs, custom punched designs available upon request

MULTI-BLADE DAMPER PARTS

(All steel parts are Zinc or Cadmium Plated)
ALL PACKED 100 PER CARTON UNLESS NOTED

Select items available in stainless steel. See page 19.

BLADE BRACKETS

Standard Bracket as supplied in BK-1 and BK-2 Parallel Kits.



STANDARD BRACKETS		
ITEM#	CODE	ROD SIZE
2005	BKP814	1/4"
2006	BKP856	5/16"
2007	BKP838	3/8"



HIGH BRACKETS		
ITEM#	CODE	DESCRIPTION
2008	BKP22	High Bracket as supplied in Opax Blade Kits BKO-3 and BKO-4
2011	BKP25	High Bracket (not Neva-Bind) with Brass Pivot & Steel Set Screw (Not Shown)



LOW BRACKETS		
ITEM#	CODE	DESCRIPTION
2009	BKP23	Low Bracket and Linkage Rod as supplied in Opax Blade Kits
2010	BKP24	Low Bracket (not Neva-Bind) with Brass Pivot & Steel Set Screw (Not Shown)

STRAPS



STANDARD & SET SCREW		
ITEM#	CODE	DESCRIPTION
2016	BKP13	Strap and set screws



SELF ALIGN & SET SCREW		
ITEM#	CODE	DESCRIPTION
2025	BKP71	Self-aligning strap and set screws. "V" groove does not deform blade.

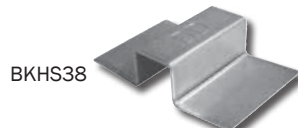

HAT BRACKET		
ITEM#	CODE	DESCRIPTION
2075	BKHS38	3/8" Hat Bracket 22ga

Sold 500 Per Ctn.

BUSHINGS



RUBBER BUSHINGS		
ITEM#	CODE	DESCRIPTION
2266	BK-PRB80	1/4" Round ID rubber bushings
2267	BK-PRB81	1/4" Square ID rubber bushings
2268	BK-PRB82	3/8" Round ID rubber bushings
2269	BK-PRB83	3/8" Square ID rubber bushings



BUSHINGS		
ITEM#	CODE	DESCRIPTION
2012	BKP9	Bronze Bushings 7/16" dia. ID. as supplied in BK-1 Parallel Blade Kits and BKO-3 Opax Kits.
2013	BKP10	Bronze Bushings 1/2" dia. ID. as supplied in BK-2 Parallel Blade Kits and BKO-4 Opax Kits.
2240	BKP80	Plastic Bushing 1/4" dia. ID. is designed for use with KP6 & KP6L Spring Loc Bearings Only.
2241	BKP81	Plastic Bushing 1/4" sq. ID.
2242	BKP82	Plastic Bushing 3/8" dia. ID. is designed for use with KP7 & KP7L Spring Loc Bearings Only.
2079	BKP64	Plastic Bushing 1/2" dia. ID.
2244	BKP84	Plastic Bushing 1/2" sq. ID.
2261	BKP30P	Closed flanged ball bearing bushing 1/2" ID
2277	BKP83T	3/8" Square Loc Bushing

MULTI-BLADE DAMPER PARTS (CONTINUED)

(All steel parts are Zinc or Cadmium Plated)
ALL PACKED 100 PER CARTON UNLESS NOTED

Select items available in stainless steel. See page 19.

ROD COUPLINGS



BKP3812

ROD COUPLING		
ITEM#	CODE	DESCRIPTION
2239	BKP3812	3/8" Square to 1/2" Round Rod Coupling
Sold 50 Per Carton		

STANDARD PINS



BKP1

STANDARD PINS		
ITEM#	CODE	DESCRIPTION
2017	BKP1	7/16" diameter pin 2-1/2in long
2019	BKP5	1/2" diameter pin 2-1/2" long
Sold 100 Per Ctn.		
2020	BKP6	1/2" diameter pin 6" long
Sold 50 Per Ctn.		

MILLED & DRILLED PINS



BKP116

MILLED & DRILLED PINS		
ITEM#	CODE	DESCRIPTION
2076	BKP116	1/2" diameter, 6" long, milled and drilled pin
Sold 50 Per Ctn.		
2115	BKP113	1/2" diameter, 3 1/2" long, milled and drilled pin
Sold 100 Per Ctn.		

ROUND TO SQUARE PINS



BKP7

ROUND TO SQUARE PINS		
ITEM#	CODE	DESCRIPTION
2022	BKP4	7/16" diameter to 1/2" square, 6" long
2023	BKP7	1/2" diameter to 1/2" square, 6" long
2024	BKP70	7/16" diameter to 3/8" square, 6" long
Sold 50 Per Ctn.		
2063	BKP8	1/2" diameter to 3/8" square, 4" long
Sold 100 Per Ctn.		

SLIDE PINS

With Duro Dyne's complete line of Damper Slide Pins, nearly every configuration requirement can be satisfied. Duro Dyne's Damper Blade Slide Pin selection provides a low cost alternative to damper hardware such as straps, set screws and solid pins. Installation is as easy as 1-2-3.

1. Punch a hole in the Damper Blade
2. Position a Pin on the Blade
3. Lock the pin in position by tightening 1/4" hex nut after sliding the pin into the damper bushing.

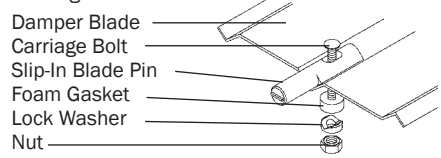

DBP1A



SLIDE PINS		
ITEM#	CODE	APPROX. PIN SIZE
2094	DBP1A	7/16" diameter and 1/2" diameter slide pin, 5/8" Length.
2067	DBP1	Damper Blade Pin only

RDBP



SLIDE PINS		
ITEM#	CODE	APPROX. PIN SIZE
2221	RDBP100A	1/2" Round Pin 1" Long
2222	RDBP150A	1/2" Round Pin 1 1/2" Long
2223	RDBP200A	1/2" Round Pin 2" Long

SDBP



SLIDE PINS		
ITEM#	CODE	APPROX. PIN SIZE
2215	SDBP100A	3/8" Sq. Pin 1" Long
2217	SDBP200A	3/8" Sq. Pin 2" Long

PIVOT & SET SCREW



BKP36

PIVOT		
ITEM#	CODE	DESCRIPTION
2135	BKP36	1/4-28 Brass Pivot Fully Tapped

BKP35



SET SCREW		
ITEM#	CODE	DESCRIPTION
2134	BKP35	1/4-28x1/2" Set Screw

CRANK ARM



CAC212L

CRANK ARM		
ITEM#	CODE	DESCRIPTION
8185	CAC212L	1/2" long shaft

CONTROL SWIVEL



DSC516

CONTROL SWIVEL		
ITEM#	CODE	DESCRIPTION
8186	DSC516	Fits 1/4" & 5/16" Rods

ROD CLIPS



KP25

ROD CLIPS (U-BOLTS)		
ITEM#	CODE	DESCRIPTION
8053	KP25	3/8" Damper Rod Clips
8054	KP26	1/2" Damper Rod Clips
8055	KP27	5/8" Damper Rod Clips

ACCESS DOORS

INSULATED ACCESS DOORS TAB STYLE

The DAD Door has been designed to create an airtight seal utilizing a moisture, oil and grease resistant neoprene gasketing between the door to the frame and the frame to the duct. The door panel is constructed out of 24 gauge galvanized steel and is filled with a 1" 1-1/2 lb. fiberglass insulation (K factor .26+.03@75°F). The frame is 24 gauge galvanized steel with punched steel tabs along each side, which locks the frame into the ductwork. Smaller frame corner tabs make installation easy. Double camlock latches are used on doors 14" and larger. 12" and smaller have one camlock. Special sizes can be fabricated with multiple walls of steel or see-through panels or Cam-Lock only style.

Standard Sizes: Installation Note: All holes should be cut 1-1/8" smaller than the door.

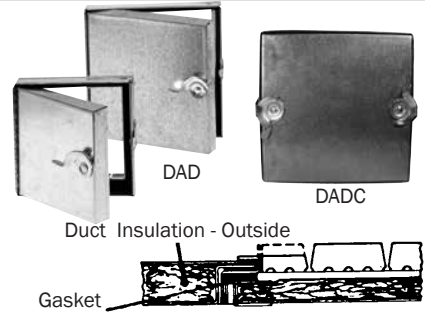

UNION LABEL INSULATED ACCESS DOORS TAB STYLE

The YDAD Access Door is similar in specifications to the standard Insulated Access Door but is manufactured by industrial workers in the sheet metal union.



INSULATED ACCESS DOORS SELF STICK STYLE

Duro Dyne NHSAD & NCSAD access doors feature a self stick frame for easy application. Simply size and cut the hole, peel the release paper off the frame, press the door onto the ductwork and secure with screws. They are easy to position with no frame 'dove tails' to align and bend. Self Stick Access Doors are manufactured of 24 ga galvanized steel and feature a one inch wide gasketed frame, 1" thick fiberglass insulation, and have been tested to 10"SP with minimal leakage when properly installed. Cam Only Self Stick Access Door also available with Safety Cable (CSADSC).

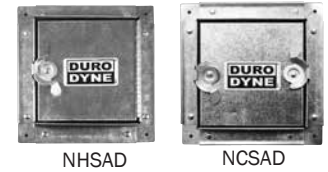

UNION LABEL INSULATED ACCESS DOORS SELF STICK STYLE

The YHSAD & YCSAD Access Doors are similar in specifications to the standard Self Stick Insulated Access Doors but are manufactured by industrial workers in the sheet metal union.



VISION PANEL INSULATED ACCESS DOORS

Manufactured of 24 ga galvanized steel, a 1" 1-1/2 lb. fiberglass insulation and door to frame and frame to door gasket Duro Dyne IADVP's provide an airtight seal with the added convenience of a vision panel. Square tabs make for an easier and safer installation process. A clear vision panel allows visual duct inspection effortlessly!



UNION LABEL HIGH PRESSURE INSULATED ACCESS DOORS

The YCCSAD Access Doors are similar in specifications to the standard Self Stick Insulated Access Doors but are manufactured by industrial workers in the sheet metal union. Additional cams & latches make these doors appropriate for higher pressure situations. Safety cable available upon request.



DUCT BOARD ACCESS DOORS

Duro Dyne's DBD Series Door is an insulated access door specifically designed for quick and easy installation onto ductboard. Simply cut the appropriate size hole in the duct, remove the release paper from the adhesive strip on the door, and press the door into position. Complete the installation by pushing the nails provided through the eight holes in the frame and capping them with the speed nuts, also provided, on the inside of the duct.



	INSULATED ACCESS DOORS TAB STYLE		UNION LABEL INSULATED ACCESS DOORS TAB STYLE		INSULATED ACCESS DOORS SELF STICK STYLE		UNION LABEL INSULATED ACCESS DOORS SELF STICK STYLE		VISION PANEL INSULATED ACCESS DOORS		UNION LABEL HIGH PRESSURE ACCESS DOORS	DUCT BOARD ACCESS DOORS
	Hinged (DAD)	Cam Only (DADC)	Hinged (YDAD)	Cam Only (YDADC)	Hinged (NHSAD)	Cam Only (NCSAD)	Hinged (YHSAD)	Cam Only (YCSAD)	Hinged (DADVP)	Cam Only (DADVPC)	Cam Only (YCCSAD)	(DBD)
4x4	6100	6130	6110	6140	•	•	7271	7272	•	•	6001	•
6x6	6101	6131	6111	6141	7046	7056	7310	7320	1002	1032	6002	•
8x8	6102	6132	6112	6142	7047	7057	7311	7321	1003	1033	6003	36066
10x10	6103	6133	6113	6143	7048	7058	7312	7322	1004	1034	6004	36067
12x12	6104	6134	6114	6144	7049	7059	7313	7323	1005	1035	6005	•
14x14	6105	6135	6115	6145	7050	7060	7314	7324	1006	1036	6006	•
16x16	6106	6136	6116	6146	7051	7061	7315	7325	1007	1037	6007	•
18x12	•	•	•	•	7052	7062	7316	7326	•	•	6008	•
18x18	6107	6137	6117	6147	7053	7063	7317	7327	1008	1038	6009	•
20x20	6108	6138	6118	6148	7054	7064	7318	7328	1009	1039	6010	•
24x24	6109	6139	6119	6149	7055	7065	7319	7329	1010	1040	6011	•

Clamshell style access doors are available in the Dyn-O-Mate Catalog.

ACCESS DOOR LOCKING DEVICES

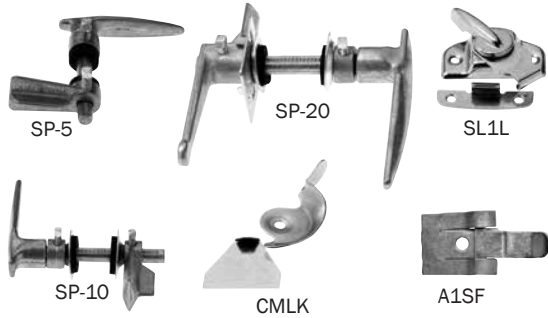

Cam Lock available in stainless steel. See page 18.

ACCESS DOORS LOCKING DEVICES					
ITEM#	CODE	SHAFT LENGTH	SHAFT SIZE	MAXIMUM DOOR THICKNESS	QTY. PER CTN.
8105	SP5	2"	1/4" dia.	1 3/8"	25
8106	SP10	3"	3/8" dia.	1 1/2"	10
8107	SP20	4"	1/2" dia.	2"	10
8138	CMLK				100
6305	SL1L				25
8397	SL2				50
8182	A1SF				100

THE DIMENSIONS SHOWN ARE NORMAL AND SUBJECT TO STANDARD MANUFACTURING TOLERANCES.

GASKETING

Wherever flanges are used in connecting parts of a duct system, the potential for air leakage exists. Besides contributing to energy waste, leaks can also create noise. Sealing of ductwork can be accomplished with the use of gasket which adheres to flanged surfaces. When this material is attached to a flange, which is then assembled to a second flange, the material is compressed and fills gaps and irregularities creating a seal.



VINYL FOAM (PVC)

Vinyl Foam is a low density PVC Foam. When this material is attached to a flange which is then assembled to a second flange, the material is compressed and fills gaps and irregularities creating a seal.

VINYL FOAM (PVC)			
ITEM#	CODE	DESCRIPTION	LENGTH
8123	PVC 1812	1/8" x 1/2"	50'/RL
8124	PVC 1434	1/4" x 3/4"	50'/RL
8125	PVC 3834	3/8" x 3/4"	50'/RL

URETHANE

Urethane Gasket is a 2 lb. Polyester Urethane. When this material is attached to a flange which is then assembled to a second flange, the material is compressed and fills gaps and irregularities creating a seal.

URETHANE			
ITEM#	CODE	DESCRIPTION	LENGTH
8126	UF 312	3/16" x 1/2"	50'/RL
8127	UF 1434	1/4" x 3/4"	50'/RL
8128	UF 3834	3/8" x 3/4"	25'/RL

NEOPRENE

Neoperene Gasket is a black, continuous, closed cell, medium density rubber product that has excellent resistance to oil and fuel.

NEOPRENE			
ITEM#	CODE	DESCRIPTION	LENGTH
8129	BN 1812	1/8" x 1/2"	50'/RL
8130	BN 1434	1/4" x 3/4"	50'/RL
8131	BN 3834	3/8" x 3/4"	25'/RL
8261	BN 31634	3/16" x 3/4"	50'/RL
8151	BN 51634	5/16" x 3/4"	50'/RL
8149	BN3161	3/16" x 1"	50'/RL
6303	BN142	1/4" x 2"	50'/RL

NEOPRENE UL LISTED

Neoperene Gasket is a black, continuous, closed cell, medium density rubber product that has excellent resistance to oil and fuel. UL Listed #723

NEOPRENE UL LISTED			
ITEM#	CODE	DESCRIPTION	LENGTH
6339	BN1812UL723	1/8" x 1/2"	50'/RL
6340	BN1434UL723	1/4" x 3/4"	50'/RL
6341	BN3834UL723	3/8" x 3/4"	25'/RL
6343	BN51634UL723	5/16" x 3/4"	50'/RL
6344	BN3161UL723	3/16" x 1"	50'/RL

DOUBLE SIDED BLACK FOAM TAPE

BF2S18 is a 1/8" thick black closed cell, crosslinked polyethylene foam coated on both sides with a high performance acrylic based adhesive with a white kraft liner. Typical applications: circular duct connectors and rectangular duct connectors.

DOUBLE SIDED BLACK FOAM TAPE			
ITEM#	CODE	DESCRIPTION	LENGTH
7197	BF2S18-100	1/8" x 1"	108'/CTN
7199	BF2S18-112	1/8" x 1-1/2"	108'/CTN

INSTRUMENT TEST PORTS

The **Instrument Test Port** has a durable cast zinc alloy construction with a heavy gauge zinc plated cap. Its Neoprene Expansion Plug can withstand up to 180°F and has resisted pressures up to 90 PSI when installed. The TH-1 accommodates 1" of insulating materials and has an inside diameter of 1-1/16". The IP-2 accommodates 2" of insulation material and has an inside diameter of 1-1/8". The IP-4 offers a 3/4" diameter access to the air stream. All are designed for high velocity systems. A flat neoprene mounting gasket is supplied. However, for maximum protection against leakage, we recommend using Quad Seal.

INSTRUMENT TEST PORT		
ITEM#	CODE	QTY PER CARTON
8036	TH1	25
8398	IP2	10
8340	IP4	25



HINGES

PIANO HINGES

HPH116
HPH112



PIANO HINGES			
ITEM#	CODE	SIZE	DESCRIPTION
8120	HPH116	1-1/16" x 3'	Piano hinge, with holes, zinc plated
8121	HPH112	1-1/2" x 3'	

Packed 25 Per Carton - Special sizes available upon request

BUTT HINGES

HH2
HH3

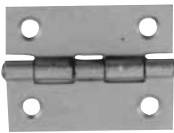

BUTT HINGES				
ITEM#	CODE	SIZE	DESCRIPTION	FINISH
8109	HH2	2" x 1 - 9/16"	Light, narrow butt hinge, fast pin, w/ screw holes.	Zinc plated
8110	HH3	3" X 2"		Zinc plated

Packed 24 Per Carton - Special sizes available upon request

FIRE DAMPER HARDWARE

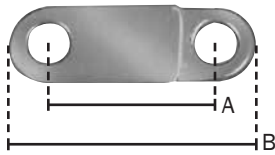

All fusible links are listed by Underwriter's Laboratories, Inc.

FIRE DAMPER HARDWARE				
ITEM#	CODE	DESCRIPTION	DIM. A	DIM. B
2032	FLS39	temperature rating 165° 10 pound load	1"	1-1/2"
2033	FL43	temperature rating 165° 30 pound load	1-3/4"	2-9/16"
2034	FL41	temperature rating 212° 30 pound load	1-3/4"	2-9/16"
2356	FL43L	temperature rating 165° 30 pound load - with long hook	1-3/4"	2-9/16"
2357	FL41L	temperature rating 212° 30 pound load - with long hook	1-3/4"	2-9/16"

Packed 100 Per Carton

HANGING STRAP

Duro Dyne provides Hanging Strap fabrics that are waterproof, grease, oil & acid resistant, and have low smoke & flame development.



Designed for hanging:

- Flexible Duct
- PVC Vent Duct
- Duct Board Systems
- Light Weight Steel
- Duct Applications

HANGING STRAP			
ITEM#	CODE	DESCRIPTION	SIZE
10181	VDS200C	Vinyl Duro Strap	1-1/2" x 200'
10180	NS300	Nova Strap	1-3/4" x 300'



	VINYL DURO STRAP	NOVA STRAP
FLAME SPREAD & SMOKE DEVELOPMENT:	N/A	Less Than 25 / Less Than 50
TENSILE STRENGTH:	Warp-70 lbs./In. Fill-70 lbs./In	Warp-70 lbs./In.; Fill-70 lbs./In
HEAT RESISTANCE:	200° F	200° F
TEAR STRENGTH:	Warp- 8 lbs./In. Fill-11 lbs./In	N/A
FABRIC:	Black vinyl coated polyester fill	Black Woven Polypropylene
TOTAL FABRIC THICKNESS:	.022" Approx.	.025" Approx.
QUANTITY PER CARTON:	10 rolls (Conveniently packaged in a dispenser box with cutting blade)	24 rolls per box
ADDITIONAL INFO:	N/A	Resistant to Grease, Oil, Gasoline and Acid.

DYN-O-TIE®

Whenever your job calls for securing round flexible duct to outlets, pipes or fittings, you can do the job better, faster, and at a lower cost using **DYN-O-TIES**, flexible duct ties.

No tapes, no screws, no clamps. Position the flexible duct and slip a **DYN-O-TIE** around the flexible duct over the joint. Draw the **DYN-O-TIE** tight with our ratchet action hand tool. A push with the thumb completes the job by clipping off the excess nylon tab for the neatest and most secure connection you could want. Duro Dyne **UV DYN-O-TIES** are made to resist Ultraviolet rays and adverse weather conditions when used in outdoor applications.

DYN-O-TIES, when properly installed, provide secure, self-extinguishing joints when connecting certain types of flexible duct listed by Underwriters Laboratories Inc., class 1.

NYLON	
6/6 V2 - available in five sizes	
Self-extinguishing	
Fungus inert	
Normal service temp. range: - 40° F to 185° F	
Test Results*: Nylon-175 lbs-	



181B-C 13ER
MH19757

For use with UL nonmetallic
airducts and air connectors

Non-Metallic
Mechanical
Fastener

*Test Method: Tie is secured at both ends forming a loop. A weight is suspended from the bottom of loop to determine tensile strength of **DYN-O-TIE** strap.



NYLON DYN-O-TIES							
ITEM #	CODE	DESCRIPTION	COLOR	LENGTH	MAX. DIA.	PKG.	PKG./CTN
7002	UVDN48	UV Resistant Nylon	Black	48"	14"	50	10
7003	UVDN36	UV Resistant Nylon	Black	36"	11"	50	10
6298	DDN36	Nylon Dyn-o-tie USA Made	Natural	36"	11"	50	10
6299	DDN48	Nylon Dyn-o-tie USA Made	Natural	48"	14"	50	10



TITANIUM DYN-O-TIES							
ITEM #	CODE	DESCRIPTION	COLOR	LENGTH	MAX. DIA.	PKG.	PKG./CTN
7116	DN36HDG	Heavy Duty Titanium Nylon - USA Made	Gray	36"	11"	50	10
7107	DNC48HDG	Heavy Duty Titanium Nylon - USA Made	Gray	48"	15"	50	10

MINI DYN-O-TIE®

MINI DYN-O-TIES are available in natural nylon or black to resist ultraviolet rays and adverse weather conditions when used in outdoor applications. The 8" length is also available with a mouting hole.

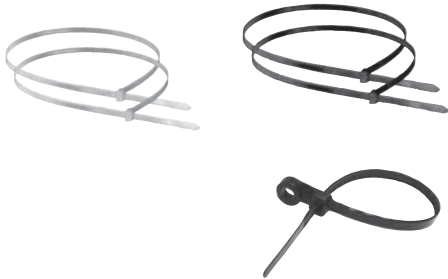

MINI DYN-O-TIES					
ITEM #	CODE	DESCRIPTION	COLOR	LENGTH	MAX. DIA.
6250	DDNM05M	Nylon	Natural	5"	1.38"
6251	DDNM05UVM	UV Resistant Nylon	Black	5"	1.38"
6252	DDNM08M	Nylon	Natural	8"	1.97"
6253	DDNM08UVM	UV Resistant Nylon	Black	8"	1.97"
6254	DDNM11M	Nylon	Natural	11"	2.76"
6255	DDNM11UVM	UV Resistant Nylon	Black	11"	2.76"
6256	DDNM14M	Nylon	Natural	14"	4.02"
6257	DDNM14UVM	UV Resistant Nylon	Black	14"	4.02"

MINI DYN-O-TIES WITH MOUNTING HOLE					
ITEM #	CODE	DESCRIPTION	COLOR	LENGTH	MAX. DIA.
6367	DNMH08M	Nylon	Natural	8"	1.97"
6368	DNMH08UVM	UV Resistant Nylon	Black	8"	1.97"

DYN-O-TIE GUN INSTALLATION TOOL

The DIT3 gun is light weight and commonly used to install most makes of nylon duct ties.



DYN-O-TIE GUN		
ITEM #	CODE	DESCRIPTION
7343	DIT3	For use with nylon ties

STAINLESS STEEL DYNA-CLAMPS™

The Dyna-Clamp is an efficient way to secure flex or rigid round duct connections. The stainless steel band can withstand up to 60 PSI, as well as extreme temperature conditions. The band is secured in place at the bridge by a slotted hex head screw. This zinc plated carbon steel screw can be flipped up away from the band to offer a quick release when adjustments are needed. Dyna-Clamps are available in stock sizes ranging from a 7" diameter to 20". Two or more clamps can also be connected together to accommodate duct diameters over 20".

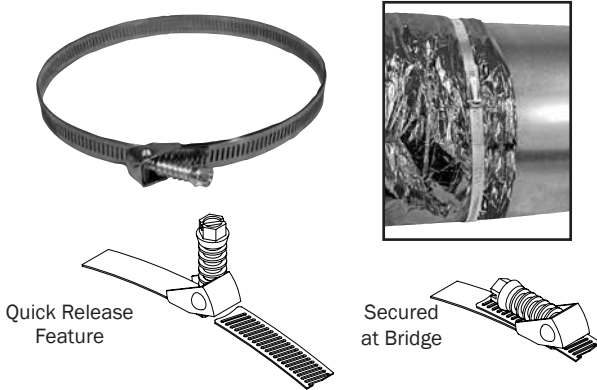

DYNA-CLAMPS				
ITEM #	CODE	MAXIMUM DIAMETER	MINIMUM DIAMETER	OVERALL LENGTH
7012	DT7WD	7"	1.75"	23.5"
7007	DT8WD	8"	1.75"	28.25"
7008	DT10WD	10"	1.75"	33"
7009	DT12WD	12"	1.75"	40"
7010	DT15WD	15"	1.75"	48.75"
7011	DT16WD	16"	1.75"	52.5"
7013	DT18WD	18"	1.75"	57.31"
7044	DT20WD	20"	1.75"	63.58"

STAINLESS STEEL HARDWARE

STANDOFF 3/8" DIAL REGULATOR (FOR DAMPERS UP TO 20")

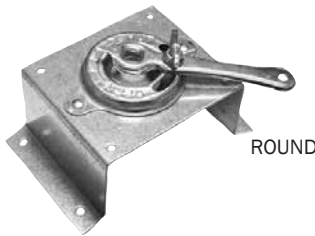
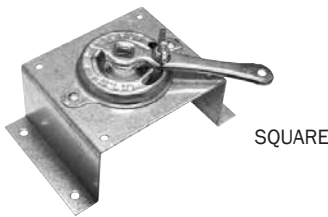

300 SERIES FOR SQUARE DUCT			
ITEM#	CODE	SHAFT SIZE	STAND HEIGHT
7290	KR3SS-100	3/8" sq.	1"
7292	KR3SS-150	3/8" sq.	1-1/2"
7294	KR3SS-200	3/8" sq.	2"

Packed 10 Per Carton.

300 SERIES FOR ROUND DUCT			
ITEM#	CODE	SHAFT SIZE	STAND HEIGHT
7291	KR3SS-100R	3/8" sq.	1"
7293	KR3SS-150R	3/8" sq.	1-1/2"
7295	KR3SS-200R	3/8" sq.	2"

Packed 10 Per Carton.

3/8" DIAL REGULATOR (FOR DAMPERS UP TO 20")

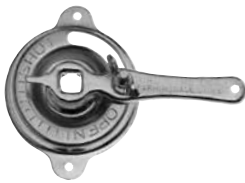

300 SERIES 3/8" DIAL REGULATOR		
ITEM#	CODE	DESCRIPTION
8272	KR3SS	3/8" Stainless Steel dial regulator only

Packed 10 Per Carton

ACCESS DOORS LOCKING DEVICE



ACCESS DOORS LOCKING DEVICES			
ITEM#	CODE	DESCRIPTION	QTY. PER CTN.
8396	CMLK-SS	Stainless Steel Cam-Lock	100

STAINLESS STEEL HARDWARE (CONTINUED)

1/2" SPEC SEAL™ UNIVERSAL REGULATOR SET (FOR DAMPERS UP TO 30")

The Spec-Seal Regulator Set utilizes a special rubber seal for applications up to 500°F constant temperature. It eliminates leakage and rattle via the Shaft Loc Mechanism in high pressure systems. The handle's unique design utilizes a highly-visible orange plastic cover showing the damper position. This kit includes 1/2" square bearing shafts. Individual parts available upon request.

Set Consists of:

- Regulator
- 2 Rubber Seals
- 2 Metal Washers
- 2 End Bearings
- End Bearing Support

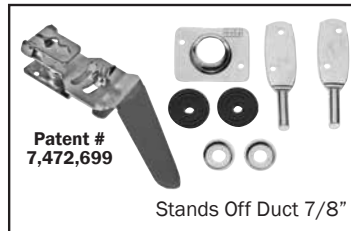

300 SERIES STAINLESS STEEL SPEC-SEAL™		
ITEM#	CODE	BEARING TYPE
8301	AL12SS	1/2" Square Stainless
8302	ALR012SS	1/2" Square Stainless

*Item #8302 contains regulator and washers only

316 SERIES STAINLESS STEEL SPEC-SEAL™		
ITEM#	CODE	BEARING TYPE
8161	ALR012SS316	1/2" Square Stainless
8297	ALR012RSS316	1/2" Round Stainless

*Item #8161 & 8297 contain regulator and washers only

304 SERIES STAINLESS STEEL SPEC-SEAL™		
ITEM#	CODE	DESCRIPTION
8328	MSR0304SS	Multisize Regulator Only

Quantity per carton: 10

END BEARINGS - 300 SERIES (PACKED 10 PER CARTON)

KP9XL-SS



3/8" SQUARE		
ITEM#	CODE	APPROX. DIM.
7393	KP9XL-SS	3/8" x 3-1/8"

KP10S-SS



1/2" SQUARE		
ITEM#	CODE	APPROX. DIM.
7395	KP10S-SS	1/2" x 1-1/4"

KP10R-SS



1/2" ROUND		
ITEM#	CODE	APPROX. DIM.
7394	KP10R-SS	1/2" x 1-1/4"

KP7LSS



SPRING LOC		
ITEM#	CODE	APPROX. DIM.
7396	KP7LSS	3/8" x 3-3/4"

Spring Loc Example
KP7LSS #7396:

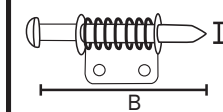

ITEM#	APPROX. DIM.
7396	3/8"(A) x 3-3/4"(B)

Square Example
KP10S-SS #7395:

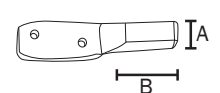

ITEM#	APPROX. DIM.
7395	1/2"(A) x 1-1/4"(B)

MULTI-BLADE DAMPER KITS AND PARTS

BLADE BRACKETS

BKP52SS



HIGH BRACKETS - 300 SERIES		
ITEM#	CODE	DESCRIPTION
2049	BKP52SS	Stainless BKP-22
2047	BKP50SS	Stainless BKP-25

BKP54SS



BKP62SS



LOW BRACKETS - 300 SERIES		
ITEM#	CODE	DESCRIPTION
2058	BKP54SS	Stainless Low Bracket/ Pivot/Screw
2062	BKP62SS	Stainless Low Bracket/ Pivot/Lollypop

STRAPS

BKP56SS



STRAP & SET SCREW - 300 SERIES		
ITEM#	CODE	DESCRIPTION
2052	BKP56SS	Stainless Strap/Screw

STANDARD PINS

BKP63SS



STANDARD PINS - 300 SERIES		
ITEM#	CODE	DESCRIPTION
2051	BKP55SS	Stainless 1/2" diameter pin 2-1/2" long
2068	BKP63SS	Stainless 1/2" diameter pin 6" long

BUSHINGS

BKP49SS



BUSHINGS - 300 SERIES		
ITEM#	CODE	DESCRIPTION
2085	BKP49SS	Stainless 1/2" Bushing

ROD CLIPS

KP25SS



ROD CLIPS (U-BOLTS) - 300 SERIES		
ITEM#	CODE	DESCRIPTION
7397	KP25SS	3/8" Stainless Damper Rod Clips w/ Nyloc Nut

Please Visit Our Website
www.durodyne.com
for the most current product information.



7/7/2022
BB008402

Duro Dyne National Corporate Headquarters, Bay Shore, NY
631-249-9000 • Fax: 631-249-8346
Duro Dyne Midwest • Duro Dyne West • Duro Dyne Canada
www.durodyne.com • E-mail: durodyne@durodyne.com