Air Sampling in the Workplace

Final Report

U.S. Nuclear Regulatory Commission

Office of Nuclear Regulatory Research

E. E. Hickey, G. A. Stoetzel, D. J. Strom, G. R. Cicotte, C. M. Wiblin, S. A. McGuire



Air Sampling in the Workplace

Final Report

Manuscript Completed: February 1993
Date Published: September 1993

E. E. Hickey*, G. A. Stoetzel*, D. J. Strom*, G. R. Cicotte*, C. M. Wiblin**, S. A. McGuire

**Division of Regulatory Applications
Office of Nuclear Regulatory Research
U.S. Nuclear Regulatory Commission
Washington, DC 20555-0001**



*Pacific Northwest Laboratory
Richland, WA 99352

**Advanced Systems Technology, Inc.
3490 Piedmont Road, NE - Suite 1410
Atlanta, GA 30305

AVAILABILITY NOTICE

Availability of Reference Materials Cited in NRC Publications

Most documents cited in NRC publications will be available from one of the following sources:

1. The NRC Public Document Room, 2120 L Street, NW, Lower Level, Washington, DC 20555-0001
2. The Superintendent of Documents, U.S. Government Printing Office, Mail Stop SSOP, Washington, DC 20402-9328
3. The National Technical Information Service, Springfield, VA 22161

Although the listing that follows represents the majority of documents cited in NRC publications, it is not intended to be exhaustive.

Referenced documents available for inspection and copying for a fee from the NRC Public Document Room include NRC correspondence and internal NRC memoranda; NRC Office of Inspection and Enforcement bulletins, circulars, information notices, inspection and investigation notices; Licensee Event Reports; vendor reports and correspondence; Commission papers; and applicant and licensee documents and correspondence.

The following documents in the NUREG series are available for purchase from the GPO Sales Program: formal NRC staff and contractor reports, NRC-sponsored conference proceedings, and NRC booklets and brochures. Also available are Regulatory Guides, NRC regulations in the Code of Federal Regulations, and Nuclear Regulatory Commission Issuances.

Documents available from the National Technical Information Service include NUREG series reports and technical reports prepared by other federal agencies and reports prepared by the Atomic Energy Commission, forerunner agency to the Nuclear Regulatory Commission.

Documents available from public and special technical libraries include all open literature items, such as books, journal and periodical articles, and transactions. Federal Register notices, federal and state legislation, and congressional reports can usually be obtained from these libraries.

Documents such as theses, dissertations, foreign reports and translations, and non-NRC conference proceedings are available for purchase from the organization sponsoring the publication cited.

Single copies of NRC draft reports are available free, to the extent of supply, upon written request to the Office of Information Resources Management, Distribution Section, U.S. Nuclear Regulatory Commission, Washington, DC 20555-0001.

Copies of industry codes and standards used in a substantive manner in the NRC regulatory process are maintained at the NRC Library, 7920 Norfolk Avenue, Bethesda, Maryland, and are available there for reference use by the public. Codes and standards are usually copyrighted and may be purchased from the originating organization or, if they are American National Standards, from the American National Standards Institute, 1430 Broadway, New York, NY 10018.

Use of NUREG-1400 by Licensees

This report, NUREG-1400, was written to provide technical information to licensees using Regulatory Guide 8.25, Revision 1, "Air Sampling in the Workplace." The report was reviewed by the U.S. Nuclear Regulatory Commission (NRC) staff for its technical content.

NUREG-1400 is not and should not be used as a regulatory compliance document, because it neither establishes regulatory positions nor defines what is acceptable to the NRC. For the case in which a licensee has made a commitment to conduct air sampling in accordance with the recommendations in Regulatory Guide 8.25, NUREG-1400 should *not* be used in compliance reviews to determine whether the recommendations have been followed. Instead, NUREG-1400 is a technical resource for the licensee to use to obtain technical information when information is wanted.

Regulatory Guide 8.25 specifically states that the guide does not apply to activities conducted under 10 CFR Part 50 at reactor facilities, however, NUREG-1400 provides examples of reactor facilities to demonstrate all types of air sampling programs.

Abstract

This report provides technical information on air sampling that will be useful for facilities following the recommendations in the NRC's Regulatory Guide 8.25, Revision 1, "Air Sampling in the Workplace." That guide addresses air sampling to meet the requirements in NRC's regulations on radiation protection, 10 CFR Part 20. This report describes how to determine the need for air sampling based on the amount of material in process modified by the type of material, release potential, and confinement of the material. The purposes of air sampling and how the purposes affect the types of air sampling provided are discussed. The report discusses how to locate air samplers to accurately determine the concentrations of airborne radioactive materials that workers will be exposed to. The need for and the methods of performing airflow pattern studies to improve the accuracy of air sampling results are included. The report presents and gives examples of several techniques that can be used to evaluate whether the airborne concentrations of material are representative of the air inhaled by workers. Methods to adjust derived air concentrations for particle size are described. Methods to calibrate for volume of air sampled and estimate the uncertainty in the volume of air sampled are described. Statistical tests for determining minimum detectable concentrations are presented. How to perform an annual evaluation of the adequacy of the air sampling is also discussed.

Contents

Use of NUREG-1400 by Licensees	iii
Abstract	v
Acknowledgments	xiii
1 Evaluation of the Need for Air Sampling	1.1
1.1 When to Evaluate the Need for Air Sampling	1.1
1.2 Air Sampling Based on Potential Intakes and Concentrations	1.2
1.2.1 Release Fraction R	1.2
1.2.2 Confinement Factor C	1.2
1.2.3 Dispersibility D	1.2
1.2.4 Examples of How to Determine Air-Sampling Needs	1.3
1.2.4.1 Nuclear Medicine Example	1.3
1.2.4.2 Uranium Fuel Fabrication Pellet Grinding Area Example	1.3
1.3 Air-Sampling Systems	1.4
1.3.1 Sample Collectors	1.4
1.3.1.1 Sample Collectors for Particulates	1.4
1.3.1.2 Sample Collectors for Gas	1.5
1.3.1.3 Sample Collector Holders	1.6
1.3.2 Air Movers	1.6
1.3.3 Types of Samplers	1.7
1.3.3.1 Lapel Samplers	1.7
1.3.3.2 Portable Air Samplers	1.8
1.3.3.3 Fixed-Location Samplers	1.8
1.3.3.4 Air Monitors	1.8
1.4 References	1.9
2 Location of Air Samplers	2.1
2.1 Purpose of Airflow Studies	2.1
2.1.1 Stratification and Stagnation	2.2
2.1.2 Water-Filled Pools	2.4
2.1.3 Doors	2.4
2.1.4 Bi-Level Airflow	2.4

Contents

2.1.5	Recirculating Airflow	2.6
2.1.6	Wall and Floor Penetrations	2.6
2.2	Determination of Airflow Patterns	2.7
2.2.1	Preparation for Airflow Studies	2.8
2.2.2	Methods of Airflow Studies	2.9
2.2.2.1	Qualitative Airflow Studies	2.9
2.2.2.2	Quantitative Airflow Studies	2.10
2.2.3	Performing Qualitative Airflow Pattern Studies	2.13
2.2.3.1	Examples of a Qualitative Airflow Study in a Laboratory	2.14
2.2.3.2	Airflow Study at a Nuclear Power Plant	2.16
2.2.4	Quantitative Airflow Pattern Studies	2.16
2.2.4.1	Example of a Quantitative Airflow Pattern Study	2.17
2.3	Selecting Sampler Location	2.21
2.3.1	Factors in Locating Samplers	2.21
2.3.2	Examples of Determining Sample Locations	2.21
2.3.2.1	Effective Confinement of Radioactive Material	2.22
2.3.2.2	Estimation of Worker Intakes	2.23
2.3.2.3	Early Warning of Elevated Air Concentrations	2.24
2.4	References	2.25
3	Demonstration that Air Sampling Is Representative of Inhaled Air	3.1
3.1	Need to Demonstrate that Air Sampling Is Representative of Breathing Zone Air	3.1
3.2	Comparison of Fixed-Location Air Sample Results with Lapel Sample Results	3.1
3.3	Comparison of Fixed-Location Air Samples with Bioassay Results	3.2
3.4	Comparison with Air Sampler Results Using Multiple Samplers	3.8
3.5	References	3.8
4	Adjustments to Derived Air Concentrations	4.1
4.1	Adjusting Derived Air Concentrations for Particle Size	4.1
4.2	Methods for Adjusting DACS	4.6
4.2.1	Use of a Cascade Impactor to Determine Particle Size	4.6
4.2.2	Using Cyclones to Compensate for Particle Size	4.6
4.3	Adjusting Derived Air Concentrations for Solubility	4.6

4.4	References	4.7
5	Measuring of the Volume of Air Sampled	5.1
5.1	Means to Determine Volume of Air Sampled	5.1
5.1.1	Flow Control for Portable Air Samplers	5.1
5.1.2	Flow Control for Air Samplers Connected to Central Vacuum Systems	5.3
5.1.3	The Importance of Having a Gauge to Indicate the Filter Load	5.3
5.1.4	The Importance of Constant Flow	5.3
5.1.5	Total Volume Measurement Devices	5.3
5.2	Calibration Frequency and Methods	5.4
5.2.1	Calibration Frequency	5.4
5.2.2	Calibration to Primary Standards	5.5
5.2.3	Calibration to Secondary Standards	5.5
5.2.4	Calibration of Rotameters	5.5
5.2.5	Calibration of Flow Totalizers	5.7
5.3	Uncertainty	5.7
5.4	Method for Determining Air In-Leakage	5.8
5.5	Pressure and Temperature	5.8
5.6	References	5.11
6	Evaluation of Sampling Results	6.1
6.1	Detecting Changes in Air Concentrations Over Time	6.1
6.2	Efficiency of Collection Media	6.1
6.3	Detection Sensitivity	6.2
6.3.1	Determining the Activity Concentration	6.3
6.3.2	Deciding Whether an Air Sample Is Above Background: the Decision Level	6.5
6.3.3	Measuring Detection Capability for a Counting System: Minimum Detectable Activity	6.5
6.3.4	Measuring Detection Capability for an Air-Sampling Program: Minimum Detectable Concentration	6.6
6.3.5	MDC for a Mixture of Radionuclides	6.7
6.3.6	Checking Counter Background for Non-Random Fluctuations	6.7
6.4	References	6.8
Appendix A - Additional Decision Level Equations		A.1

Figures

2.1	Example of Stratification of Air Layers	2.3
2.2	Airflow Modification Due to Water	2.5
2.3	Example of Variable Flow Through Openings	2.6
2.4	Example of Bi-Level Flow Reversals	2.7
2.5	Example of Unexpected Flows	2.8
2.6	Quantitative Dispersion Factors	2.12
2.7	Diagram of Example Work Area	2.15
2.8	Preliminary Airflow Pattern Survey in Cube at 262-ft Level	2.17
2.9	Airflow Patterns as Determined by Smoke Candles at Selected Locations	2.18
2.10	Example Work Area, Test 1	2.19
2.11	Example Work Area, Test 2	2.20
2.12	Example Work Area, Multiple Release Points in a New Facility	2.23
2.13	Analytical Laboratory Work Area	2.24
3.1	Example Work Area Configuration for One Worker and Two Fixed-Location Samplers	3.3
3.2	Example Multi-Workstation Configuration for Six Workers and Seven Fixed-Location Air Samplers	3.3
3.3	Sample Work Sheet (1) Showing the Results of a Comparison Study of Air Sampling with Bioassay	3.6
3.4	Sample Work Sheet (2) Showing the Results of a Comparison Study of Air Sampling with Bioassay	3.7
3.5	Sample Work Sheet (3) Showing the Results of a Comparison with Multiple Samplers	3.9
4.1	Values for Ratios of Deposition Fractions	4.2
4.2	DAC Ratios for ²³⁵ U	4.5
5.1	Rotameter	5.2
5.2	Orifice Meter	5.2
5.3	Calibration Setup of a Rotameter Using a Wet Test Meter	5.6
5.4	Calibration Setup of a Rotameter Using a Spirometer	5.6
5.5	Typical Rotameter Floats and Reading Indicator Positions	5.9
5.6	In Place Calibration of Sample Collector	5.10

Tables

1.1	Release Fractions	1.3
2.1	Purposes and General Placement of Air Samplers and Monitors	2.2
2.2	Comparison of Techniques Used to Determine Airflow Patterns Within the Workplace	2.10
2.3	Common Tracer Gases and Measurement Techniques	2.13
3.1	Comparison of Lapel Samplers and Fixed-Location Air Samplers, One Worker with Two Fixed-Location Air Samplers	3.4
3.2	Comparison of Lapel Samplers and Fixed-Location Air Samplers, Six Workers with Seven Fixed-Location Air Samplers	3.4
4.1	Ratios for Deposition Fractions	4.2
4.2	Percentages of Committee Dose Equivalent, Factors and $H_{50,T}$ (Sv/Bq) for Cobalt 60, Class W	4.3
4.3	Values of Deposition Fraction Ratios, Committed Dose Equivalents and Weighted Committed Dose Equivalents for Cobalt 60, Class W, and AMAD = $7 \mu\text{m}$	4.4
4.4	Ratios of DAC to DAC for ^{235}U	4.5
5.1	Types of Flow Rate Measurement Instruments	5.4
6.1	Filter Efficiencies for the Oxide Conversion Building	6.3
6.2	Summary of Symbols, Quantities, and Units	6.4
6.3	Chi ² Calculation for the Example	6.9

Acknowledgments

The authors would like to thank the many people who contributed to the development, production, and publication of this report. We greatly appreciate their guidance, technical assistance, and patience as this document has evolved from the original drafts of Stephen McGuire, NRC project manager. Wayne Knox and Claude Wiblin of Advanced Systems Technology are acknowledged for their technical contributions, especially on the hazard evaluation method and flow pattern studies, and Allen Brodsky for the 10^{-6} factor and its use. A special thanks is given to Alfred C. Schmidt, Schmidt Instrument Co., for assistance in revising information on air sampling devices. Other technical contributors include Judson Kenoyer, Timothy Lynch, Jofu Mishima, and Paul Stansbury. Andrew McFarland and N. K. Anand of Texas A&M provided review and technical input on deposition in sampling lines. Many helpful comments were also received from the following NRC reviewers: Jack Bell, Donald Cool, George Kuzo, Cynthia Jones, Ron Nimitz, Scott Pennington, Alan Roecklein, Sami Sherbini, Dennis Sollenberger, Joseph Wang, and James Wigginton. The reviewers at the Pacific Northwest Laboratory included Don Bihl, Jerry Martin, Jack Selby, Paul Stansbury, Ken Swinth, and Bruce Vesper. Information was contributed for examples by Michael Orcutt of Nuclear Fuel Services, Richard Dubiel of Philadelphia Electric, Jay Maisler of NUMARC, and Bob Robinson of GE Nuclear Energy. The assistance from Nora Nicholson, North Anna Power Station, in obtaining data for examples is greatly appreciated. The review by Tony Weadock, U.S. Department of Energy, is also appreciated. Finally, a special thanks is given to the Jim Jamison, Paul Stansbury, and George Vargo for their advice as the final peer reviewers of the document, to Diana McInturff, Marianna Cross, and Mary Heid for text processing, and to the technical editors, Jim Weber and Susan Ennor, for all the effort necessary to edit and coordinate production of this report.

1 Evaluation of the Need for Air Sampling

This document provides examples, methods, and techniques for air sampling that may be useful for implementing the recommendations in Regulatory Guide 8.25, "Air Sampling in the Workplace," and the requirements of 10 CFR Part 20.

As discussed in Regulatory Guide 8.25 (NRC 1992), the purposes of air sampling are to determine if the confinement of radioactive material is effective, to measure airborne radioactive material concentrations in the workplace, to estimate worker intakes, to determine posting requirements, to determine what protective equipment and measures are appropriate, and to warn of significantly elevated levels of airborne radioactive materials. Workplace air sampling for both airborne particulates and radioactive gases is addressed; however, air sampling of radiological effluents is not addressed.

1.1 When to Evaluate the Need for Air Sampling

The need to perform surveys and monitoring is based on the need to limit dose to workers. According to 10 CFR 20.1502(b)(1), worker intakes of radioactive materials must be monitored if the intakes are likely to exceed 10% of the applicable annual limit on intake (ALI) in 1 year. If a worker's intake is likely to exceed 10% of the ALI, monitoring of intake is required (10 CFR 20.1502) and the licensee must record the intake, the committed effective dose equivalent, and the committed dose to the organ receiving the highest total dose (10 CFR 20.2106). For most licensee employees, intakes approaching 10% of the ALI are unlikely and monitoring of intakes under 10 CFR 20.1502 is unnecessary. However, for a small fraction of licensee employees, intakes exceed 10% of the ALI and monitoring is required. Some employees cannot be easily put in either category. These are the employees for whom 10 CFR 20.1502 requires that the licensee predict the annual intake.

Thus, in effect, the new 10 CFR Part 20 requires a method for predicting likely intakes for some workers who might (or might not) have a significant intake. The following method provides a system for determining whether projected airborne concentrations may be high

enough that workers are likely to exceed 10% of an ALI, thereby requiring monitoring and indicating the need for a licensee to perform air sampling. This two-step method is acceptable to the U.S. Nuclear Regulatory Commission (NRC) through endorsement in Regulatory Guide 8.25.

The first step is to estimate the quantity Q of unencapsulated radioactive material that is available to be inhaled by a worker during 1 year in a room or work location. For facilities that have routine operations throughout the year in each work area, such as fuel fabrication or pharmaceutical production operations, estimating the total amount of material processed is relatively straightforward. For facilities where the process or activity varies throughout the year, estimates can be based on the best available knowledge of what will be processed in the area during the year. All potential radionuclides and amounts that may be used are to be considered in the estimate. If more than one radionuclide is present, the value of the ALI is calculated according to methods described in the notes in Appendix B of 10 CFR 20.1001-20.2401. Likewise, if the radioactive material is of several classes (D, W, or Y) of the same radionuclide, it may be evaluated as a mixture of different radionuclides. This step of the process addresses only the total estimated amount of material handled in the room or area, without considering how many workers may be exposed.

The second step in the method is to estimate the potential for the intake of material by a worker. Based on observations and experience with a wide range of facilities, equipment, and processes, Brodsky has concluded that the fractional amount of radioactive material inhaled by a worker is generally less than one millionth (10^{-6}) of the amount of radioactive material processed (Brodsky 1980). This means that the potential intake is one millionth of the unencapsulated radioactive material in the work location during 1 year.

Regulatory Guide 8.25 recommends that the need for air sampling be considered when the quantity Q of radioactive material being processed in a year in unsealed or loose form exceeds 10^4 times the ALI, a quantity not likely to cause intakes more than 1% of the ALI or average concentrations more than 1% of the

Need for Air Sampling

DAC. Thus, Regulatory Guide 8.25 recommends that the need for air sampling be considered if:

$$Q > 10^4 ALI \quad (1.1)$$

where Q is the total quantity of unencapsulated material processed in a year for a given work location. The values for ALIs are taken from Appendix B of 10 CFR 20.1001-20.2401.

Therefore, to meet the intent of the regulations, if the quantity of unencapsulated material handled or processed annually is approximately 10,000 times the ALI for inhalation, Regulatory Guide 8.25 recommends that the need for air sampling be considered.

Table 1 of Regulatory Guide 8.25, "Recommended Air Sampling Based on Estimated Intakes and Airborne Concentrations," recommends air sampling based on estimated fractions of the ALI or the derived air concentration (DAC).

1.2 Air Sampling Based on Potential Intakes and Concentrations

After it is decided that air sampling is needed in a certain area, several additional factors are involved in determining the amount of material that may actually be inhaled by a worker, the potential intake I_p . These factors include the release fraction R for the radioactive material based on its physical form and use, the type of confinement C for the material, and dispersibility D of the material. Using the rule of thumb that, when normal precautions are taken, a worker is not likely to have an intake I_p exceeding 10^{-6} of the material being handled, the modified potential intake I_p will be:

$$I_p = Q \times 10^{-6} \times R \times C \times D \quad (1.2)$$

where the modifying factors are described below.

1.2.1 Release Fraction R

The release fraction R is the fraction of the radioactive material likely to be released into the workplace, as determined by its physical and chemical form.

The NRC has published suitable release fractions in 10 CFR 30.72. Although the values published in the NRC regulations were developed specifically for emergency planning, they are generally suitable for releases to air in the workplace. The technical basis for the release fractions, and the experiments from which they are derived, are described by McGuire (1988). A simplified list of release fractions adapted from 10 CFR 30.72 is presented in Table 1.1. Adjustments were made to provide an "order of magnitude" value so that some of the values used in Table 1.1 differ from those contained in 10 CFR 30.72. Other references give values for solids between 10^{-6} and 10^{-8} (Watson and Fisher 1987). The value of the release fraction for liquids was estimated from a maximum spill release in static air (Sutter et al. 1984). For example, the potential intake for a nonvolatile powder ($R = 10^{-2}$) would be:

$$I_p = Q \times 10^{-6} \times 10^{-2} \quad (1.3)$$

1.2.2 Confinement Factor C

The confinement factor C takes into consideration whether the material is separated and confined while a worker is present or whether it is actually handled in the open. Suggested values for the confinement factor would be one hundredth of the material handled in a glovebox ($Q \times 0.01$), one tenth of the material handled in a well-ventilated hood ($Q \times 0.1$), and one for material handled in an open work area ($Q \times 1$).

1.2.3 Dispersibility D

Another factor that may be appropriate to consider is the dispersibility that comes from adding energy to the system through grinding, milling, boiling, or exothermic chemical reactions. A dispersibility factor D of 10 can be applied to the calculation if cutting, grinding, heating, or chemical reactions of materials are performed. Therefore, the potential intake for a nonvolatile powder ($R = 10^{-2}$) that is being ground ($D = 10$) in a glovebox ($C = 10^{-2}$) would be:

$$I_p = Q \times 10^{-6} \times 10^{-2} \times 10^{-2} \times 10 \quad (1.4)$$

Table 1.1. Release Fractions

Physical Form	Release Fraction
Gases or volatile material	1.0
Nonvolatile powders	0.01
Solids, e.g., uranium fuel pellets, cobalt, or iridium metal)	0.001
Liquids	0.01
Encapsulated material	0

1.2.4 Examples of How to Determine Air-Sampling Needs

The following two examples describe the methods for determining if air sampling is appropriate and the suggested modifying factors used to help establish the extent and type of air sampling needed in a facility.

1.2.4.1 Nuclear Medicine Example

A lab technician makes up ^{125}I injections in a fume hood. The maximum activity that is prepared at one time, and on average, once per week is 10 mCi. Therefore, the yearly throughput of ^{125}I is approximately 0.5 Ci (1.9×10^{10} Bq). The ALI is 6×10^{-5} Ci (2.2×10^6 Bq) from Appendix B to 10 CFR 20.1001-20.2401. The predicted maximum likely intake as a fraction of the ALI (I_f) can be estimated from the 10^{-6} fractional potential intake of material processed:

$$I_f = \frac{0.5 \text{ Ci} \times 10^{-6}}{6 \times 10^{-5} \text{ Ci}} = 0.0083 \quad (1.5)$$

Similarly, the average annual airborne concentration of radioactive material as a fraction of the DAC is estimated to be 0.0083.

When the estimated concentration is less than 1% of the DAC, Table 1 of Regulatory Guide 8.25 has the following recommendation: "Air sampling is generally not necessary. However, monthly or quarterly grab samples or some other measurement may be appropriate to confirm that airborne levels are indeed low."

1.2.4.2 Uranium Fuel Fabrication Pellet Grinding Area Example

In one step in the manufacturing of uranium fuel, sintered pellets of U_3O_8 are ground to a uniform diameter. This grinding is mostly an automated dry process. The apparatus is contained in a well-ventilated shroud, but the containment is not as tight as a glovebox. The annual throughput for a grinding station is 100,000 kg of uranium. At 3% enrichment, this amount is 170 Ci (6.3×10^{12} Bq). The material is class Y with an ALI of 0.04×10^{-6} Ci (1480 Bq).

Using the 10^{-6} fractional potential intake, the potential annual intake is 1.7×10^{-4} Ci, which is far greater than an ALI. To further modify this number to the actual situation, the factors to modify the intake would be a release factor of 10^{-3} since the material is fuel pellets, an estimated confinement factor of 10^{-1} (because the shroud is not as tight as a glovebox, the value for a hood is used), and an additional modifying factor of 10 (because grinding of the material is done). Therefore, the modified potential intake I_f as a fraction of the ALI is:

$$I_f = \frac{170 \text{ Ci} \times 10^{-6} \times 10^{-3} \times 10^{-1} \times 10}{0.04 \times 10^{-6} \text{ Ci}} \quad (1.6)$$

$$I_f = 4.25 \quad (1.7)$$

Since the potential intake is 4.25 times the ALI, monitoring of worker intake is required by 10 CFR 20.1502, either by air sampling or bioassay. Table 1 of Regulatory Guide 8.25 recommends that the

Need for Air Sampling

representativeness of the air sampling be demonstrated and that an early warning capability should exist to warn of higher than normal airborne concentrations.

1.3 Air-Sampling Systems

Once the need for and extent of air sampling is determined, an appropriate air-sampling system can be chosen. Air-sampling systems consist of an air sample collector with an appropriate collection medium, an air mover to move the air through the collector, and a means for controlling the rate of flow. The type of system chosen depends on the purpose of the air-sampling, system, type of airborne radiological hazard (particulate or gas) and concentrations that must be measured.

1.3.1 Sample Collectors

The sample collector typically consists of the collection medium and a holder, which directs the flow through the collection medium and permits it to be removed for analysis.

The proper collection medium for air-sampling systems depends on the physical and chemical properties of the materials to be collected and analyzed. In using a sample collector, it is important to take into account its collection efficiency, size (filter area), and resistance to airflow. Other factors may also be important, depending upon the application, e.g., background activity of the filter, cost, self-absorption, fragility, chemical solubility and the environment in which the filter will be placed. However, sample collectors normally vary according to whether they are meant to sample particulates or gases.

1.3.1.1 Sample Collectors for Particulates

Airborne radioactive particulates may be sampled with a number of different kinds of filters depending on how the analysis is going to be performed and on the nature of the radioactivity. Of these, the most commonly used kinds are glass microfiber filters and cellulose ester membrane filters. Glass microfiber filters are made with different efficiency ratings and frequently come with a thin spun-bonded polyester outer layer to keep the fibers in place. Cellulose ester membrane filters are available in a wide range of compositions and pore sizes, with different collection efficiencies and flow resistances.

Generally, glass fiber filters are a better choice than cellulose filters.

Four characteristics are important to consider when choosing a filter: collection efficiency, airflow resistance, blocking rate, and burial depth of particulate aerosols. A high collection efficiency is needed both for collecting the smallest airborne radioactive particles that may be present, and for keeping particles from contaminating the rest of the system. Low resistance to airflow helps avoid the necessity for excessive vacuum pump power to collect the sample. Low blocking rate reduces filter loading. Finally, a low depth of burial of the particulates in the filter improves counting efficiency.

The collection efficiency of a filter varies, based on the flow velocity, properties of the filter, and the particle size being collected. Users of filters typically accept the manufacturer's stated collection efficiency for conditions under which sampling is conducted. If there is reason to question the validity of the manufacturer's collection efficiencies (e.g., using the filter under conditions not tested by the manufacturer), then the user can conduct a collection efficiency test using the method described in Section 6.2.

The collection efficiency and the flow resistance of filters usually are specified in terms of the "face velocity," which is the flow per unit of usable flow area. Thus, if the sampling flow rate is 28.3 L/min (1 cfm) and the effective flow area of the filter holder is 9.6 cm², the face velocity will be 49.2 cm/s (96.8 ft/min). Inasmuch as the collection efficiency of most filters increases with face velocity, it is important to use a high enough face velocity so that the filter will be operating efficiently. A high face velocity also helps the analytical sensitivity by concentrating the collected particles on a small filter area, and it saves on filter costs by permitting the use of small filters.

Small pressure drops are wanted for the sample flow rate being used. Resistance to airflow through a sample filter (equivalent to pressure drop across a sample filter) increases with increasing flow velocity. Section O, "Sampling Aerosols by Filtration," in *Air Sampling Instruments for Evaluation of Atmospheric Contaminants* (ACGIH 1989) provides pressure drop data for different types of filters at typical sample face velocities (53, 106, and 211 cm/s [106, 212, and 422 ft/min]) used in air sampling. The flow resistance and the blocking tendency of the filter must also be kept in mind because the higher

the face velocity and the higher the initial pressure drop, the sooner the filter will become loaded to the point that it will have to be changed. Blocking will be slower with glass microfiber filters than with membrane filters, and slower with large-pore membrane filters than with small-pore membrane filters. A disadvantage of membrane filters with pore sizes larger than $3\ \mu\text{m}$ is that they can act like depth filters which reduce the radiation counting efficiency.

Automatic flow control makes it possible to operate filters at higher face velocities and for longer periods of time between filter changes than does manual flow control. Some automatic flow control systems can compensate for flow resistance changes of 254-cm (10-in.) Hg with less than a 3% change in the incoming flow rate. In contrast, a positive displacement pump with manual flow control will have a 5% drop for every 254-mm (1-in.) Hg increase in the flow resistance of the filter.

1.3.1.2 Sample Collectors for Gas

Iodine is normally collected by adsorption on chemically impregnated activated charcoal. Collection efficiencies depend on flow rate, temperature, humidity, particle size, iodine concentration, and impregnant used. To maximize the collection efficiency, the optimal grain size is 12 to 30 mesh. This mesh size provides adequate packing density to minimize channeling and provides adequate surface area for adsorption (APHA 1977). Adsorption of contaminants in the charcoal cartridge can be minimized by keeping the cartridge in an air-tight sealed package before use.

For other halogens, noble gases, and water vapor, activated charcoal is also an efficient absorber. Because the adsorption process is not radionuclide-specific, the analysis of other radioactive halogens and noble gases with charcoal will require analytical discrimination to measure the iodine concentrations. Purging the charcoal after sampling is a procedure that can be used to drive off the noble gases. Another alternative is to use silver zeolite cartridges, which collect negligible amounts of the noble gases compared to activated charcoal cartridges (Kathren 1984).

Readers can consult Section S, "Gas and Vapor Sample Collectors," in *Air Sampling Instruments for Evaluation of Atmospheric Contaminants* (ACGIH 1989) for a detailed discussion of activated charcoal adsorbents. A method of

analyzing a charcoal cartridge for ^{131}I is found in *Methods of Air Sampling and Analysis* (APHA 1977).

Sampling for airborne tritium (usually as tritiated water vapor or hydrogen gas) is most commonly done by collecting the tritiated water vapor (HTO or T_2O) using desiccants and bubblers. Condensation or freezing techniques can also be used but are not as common.

The use of bubblers is perhaps the simplest method for collecting airborne tritium. However, gaseous tritium is not directly collected with bubblers. The gaseous tritium is first passed over a catalyst such as palladium to convert it to tritiated water vapor. The tritiated water vapor is then passed through a water-filled bottle and the tritium is collected in the water. The collection efficiencies are high (greater than 90%) if the HTO/ H_2O ratio in the water is low (NCRP 1976). The efficiency of specific bubblers can be determined by placing several bubblers in series.

To collect tritiated water vapor, a desiccant such as silica gel, molecular sieves (alumino-silicates), anhydrous calcium sulfate, and activated alumina can also be used. The relative humidity of the sampled air affects the quantity of moisture the desiccant can hold at equilibrium; the greater the relative humidity, the smaller the quantity of moisture that can be held. Loss of the sample occurs if the collection capacity is reached during sampling. Information about the adsorptive capacities is usually provided by the desiccant manufacturer. Choosing a desiccant with a capacity approximately double the maximum anticipated loading minimizes the chances of saturation. Collection materials are available that change color when nearing saturation to assist the user in determining the appropriate time to replace the collector. Distillation at normal or reduced pressure is common for the extraction of tritiated water vapor collected on the desiccant.

A real-time monitoring instrument for directly measuring tritium in air is the flow-through ionization chamber. A particulate filter is placed on the inlet to remove dust and particulates. Ionization chambers also respond to other radioactive gases and external radiation fields; therefore, shielding of the chamber or discrimination techniques may be necessary. Sensitivity is a function of the chamber volume, with larger chambers having greater sensitivity.

Need for Air Sampling

More detailed discussion on the collection of tritium from air with bubblers or desiccants is found in NCRP (1976).

1.3.1.3 Sample Collector Holders

Sample collector holders provide structural support for a sample filter, prevent flow from passing around the filter, and ease filter removal. A porous metal backing of wire mesh or beaded screen is often used. A filter backing with a smooth surface will minimize tearing during changing of the filter. Cross-contamination of samples can be avoided by using filter holders designed for easy cleaning and decontamination.

Rubber gaskets are frequently used to seal the filter to the backing plate. A gasket in contact with the filter along its entire circumference ensures a good seal and is best located on the downstream side of the filter (i.e., the clean side) to minimize contamination. Care must be taken to select a rubber gasket that will not adhere to the filter medium and damage it. Periodic inspection of the gasket helps detect degradation and buildup of dust and filter material that can cause leakage around the filter.

Leakage may occur in filter holders that are not designed properly or maintained properly. It most often occurs between the edge of the filter and the sealing face of the holder, and can result in deceptively low concentration measurements because it allows part of the air sample to bypass the filter. A simple leak test consists of installing a thin plastic flow barrier (such as polyethylene) in place of the filter, and connecting the filter holder through a bubble jar to a controlled source of vacuum. If there is a leak, there will be a continuous stream of bubbles in the bubble jar; if not, the bubbles will stop quickly. Testing at the time of purchase assures that filter holders are designed properly and periodic testing thereafter assures that filter holders are properly maintained.

A frequently asked question is, "How much leakage is permissible?" The answer is that an air-sampling filter is a quantitative device with a carefully controlled pore size. Unless the filter holder is as good as the filter itself, specified filter performance will not be realized. Furthermore, it is not difficult to make filter holders that are leak-tight; it mainly requires the manufacturer to have adequate quality control, and the user to accept no filter holder without testing it.

Charcoal cartridge holders also are subject to leakage, especially those that use the ends of the charcoal canister

as a flow seal. Sources of leakage include dents and other imperfections in the ends of the canisters, variations in the height of the canisters, variations in the thickness and smoothness of the rubber gaskets, and imperfections in the pipe threads. Because charcoal cartridge holders invariably are located downstream from filter holders, any leakage in them may reduce the flow through the filter holder, also. Leak-testing of charcoal cartridge holders can be performed using a bubble jar.

1.3.2 Air Movers

The air mover may be small and serve one air sampler, or it may be on a central vacuum system that serves a number of air-sampling stations. The function of the air mover and associated flow control system is to draw air through the sample collector at a predetermined flow rate. The means for controlling the flow rate may be either manual or automatic and may include an indicating flow meter, as discussed in Section 5. How well the air flow is controlled can be determined by connecting a portable flowmeter to the inlet with a valve to simulate the filter load, and a vacuum gauge or manometer to measure the filter load. The flow rate, measured at atmospheric pressure, is then plotted against the filter load to show how well the system performs.

Adequate air sampling uses a unique combination of flow and vacuum that is best met by air movers that are designed to operate at between 127-mm (5-in.) and 379-mm (15-in.) Hg vacuum. At less than 127-mm (5-in.) Hg, there is not enough vacuum to produce satisfactory face velocities through the filter medium and to compensate for filter blocking; at more than 379 mm (15-in.) Hg, there is too little flow for the size of the pump and motor. Other desirable features of the air mover are its quiet operation at the selected operating vacuum, its nearly pulsation-free flow, and its need for little maintenance.

Some of the different kinds of air movers that have proven satisfactory for air sampling include:

- oil-less rotary vane pumps (with carbon vanes) for flow rates between 14 and 570 L/min (1/2 and 20 cfm) (508 mm [20-in.] Hg maximum operating vacuum)
- lubricated rotary vane pumps (with phenolic vanes) for flow rates between 28 and 1416 L/min (1 and

50 cfm) (686-mm [27-in.] Hg maximum operating vacuum)

- rotary positive blowers (Roots type) for flow rates between 142 and 2832 L/min (5 and 100+ cfm) (203-to 356-mm [8-in. to 14-in.] Hg maximum operating vacuum, depending on the size of the blower and its construction)
- vacuum cleaner blowers for flow rates between 283 and 1416 L/min (10 and 50 cfm) (127-mm [5-in.] Hg maximum operating vacuum)
- turbo blowers (1 and 2 stage) for flow rates above 1416 L/min (50 cfm) 152- to 254-mm ([6-in. to 10-in.] Hg maximum operating vacuum, depending on the size of the blower and the number of stages)

Piston and diaphragm pumps are not included in the above list because their pulsating flow affects the behavior of the airborne particles being sampled and is difficult to damp to an acceptable level.

Because the noise from air movers varies between different makes and models, as well as with the operating vacuum and the kind of muffler provided, evaluation of noise prior to purchase through actual tests of the air movers and air samplers is recommended.

- Soundproofing enclosures may increase the temperatures of the pump and motor, and consequently shorten their operating life.

Because all air movers have close operating clearances, it is important to keep out pipe debris and flakes of paint during their assembly. A protective (or backup) filter may be used to keep out particulate matter that might get past the sample collector.

As a general rule, the smaller-size air movers and carbon vane pumps are built more inexpensively and will operate continuously for only about a year (8000 hours) without major repairs or replacement. Consequently, for continuous air sampling, it is often desirable to use one of the larger heavy-duty air movers on a central vacuum system that serves a number of air-sampling stations. This also enables the air mover to be located in a machinery room where its noise will not disturb the people at the sampling stations, saves valuable space at the sampling stations, and requires only one proof of operation for the entire system.

1.3.3 Types of Samplers

There are four basic types of air-sampling systems. The first consists of a lapel sampler, which is worn by the worker and can be used to determine intake. The second and third types are the portable air samplers and fixed-location air samplers, which are usually used to determine airborne radioactive concentrations in the workplace and to ensure that confinement control is maintained. The fourth sampling system is air monitoring, which samples and measures airborne concentrations for use as an early warning of higher-than-expected airborne radioactive concentrations.

1.3.3.1 Lapel Samplers

Lapel samplers (also called personal air samplers) are worn by the worker, with the filter holder worn on or near the shirt collar and the battery-powered vacuum pump worn on the belt. Lapel samplers may be the best method of estimating breathing zone concentrations because they are located close to the worker's nose and mouth.

Although lapel samplers appear to be the sampler of choice for breathing zone samplers, they have several disadvantages. A primary problem is that they have a low flow rate (2 L/min), which may make them unsuitable for airborne radioactivity areas, just at the point where breathing zone sampling may be appropriate according to Regulatory Guide 8.25, Table 1. However, the problem of a low flow rate can be overcome by collecting the sample for a longer time, counting the samples long enough to detect radioactivity, or having a more sensitive counting system. Another disadvantage is that lapel samplers may become contaminated by improper handling, which may cause the instrument to give a higher reading. Contamination on a lapel sampler may also result in erroneous worker intake. Lapel samplers are expensive, many workers think they are uncomfortable to wear, and the worker must be sure to turn them on and off. Advancements made by various manufacturers have improved lapel samplers and, even with some drawbacks, lapel air samplers may be the sampling system of choice for determining intake.

When a lapel sampler fails, it is most likely due to battery failure or inadequate charging, debris in the sample pump, leakage caused by vibration, fatigue in its valves or diaphragms, or the mechanical failure of rotary vane pumps or motor. Approximately 5% to 10% of lapel

Need for Air Sampling

samplers can be expected to be out of service for maintenance and calibration at any given time.

Consult Ritter et al. (1984), *The Role of Personal Air Sampling in Radiation Safety Programs and Results of a Laboratory Evaluation of Personal Air-Sampling Equipment*, NUREG/CR-4033, for more information about the types and use of lapel samplers and an evaluation of personal air samplers.

1.3.3.2 Portable Air Samplers

Portable samplers are usually used in facilities where the location of airborne radioactivity changes frequently, such as nuclear power plants, where routine and special maintenance often create actual or potential radioactive airborne areas. Because the samplers are portable, they can be located close to the worker.

The most common portable air samplers are lightweight, rugged AC samplers designed for taking grab samples. They are made for heavy-duty industrial applications for sampling airborne particulates and iodines. The air is drawn in through an inlet, pulled through the filter, and exhausted. Usually, a rotameter is used to indicate the airflow rate. Sample heads on portable air samplers commonly hold 5-cm-(2-in.-) or 47-mm-(1.9-in.-) diameter filters. In addition to the commonly used AC portable air sampler, battery-powered air samplers with air volume totalizers are available, as are constant airflow air samplers with the sampler on a telescoping goose neck, both of which facilitate collection of the sample in the breathing zone.

Portable samplers are categorized by their airflow rates as low-volume and high-volume samplers. For breathing zone sampling, low-volume portable samplers are used, with sample airflow rates from 28 to 56 L/min (1 to 2 cfm). High-volume samplers are not typically used for breathing zone sampling because they are very noisy.

If a portable sampler meets the criterion in Regulatory Guide 8.25 for representativeness (i.e., located within 30 cm [1 ft] of the worker's head) and the sampler is sensitive enough to obtain a lower limit of detection less than 4 DAC-h for samples collected over a 40-hour period, the sample result may be considered a breathing zone sample. If the sampler is not located in the breathing zone, representativeness would have to be demonstrated, which probably would not be feasible.

1.3.3.3 Fixed-Location Samplers

A major difference between the locations of general air samplers and breathing zone samplers is that, according to Regulatory Guide 8.25, breathing zone samplers should intercept radioactive material before it reaches or soon after it passes the individual worker. Therefore, if fixed-location air samplers are placed strategically in a work area, they too can be used to collect representative samples of the air that workers inhale. A facility with a history of operations may have air concentration data that can be used in conjunction with airflow pattern studies to determine the best location for fixed-location air samplers.

1.3.3.4 Air Monitors

Some air-sampling systems are designed to help prevent or minimize worker exposure to higher-than-expected levels of airborne radioactive materials by indicating the presence of elevated concentrations. This early warning sampling is conducted in either of two ways: by prompt sample analysis, which involves collecting an air sample and analyzing it in a counting laboratory; or by continuous monitoring, a real-time monitoring method to alert staff when concentrations rise far above and remain above the DAC. A continuous air monitor may have an automatic alarm that sounds at a predetermined activity or rate of collection of activity on the collection medium.

In general, commercially available monitors may be divided into two types: those that measure the presence of radioactive particulates (either alpha-emitters or beta/gamma-emitters) and those that measure radioactive gases or vapors. Among particulate monitors, the alpha monitors use either solid-state devices (such as surface barrier or diffused junction detectors) or scintillators (such as zinc sulfide) as detectors. Beta detectors, on the other hand, are Geiger-Mueller (GM) tubes, beta-scintillator material, or ion chambers. The beta monitors that use GM tubes are generally much larger and heavier than alpha monitors due to the amount of lead or other shielding material necessary to reduce the background radiation to acceptable levels.

Monitors of gases and vapors use ion chambers for their detection devices. Tritium monitors, for instance, usually use fairly large ion chambers as their detectors; the larger the ion chamber, the more sensitive the measurement. Some instruments have the capability of simultaneously measuring the presence of particulates (beta particles), radioiodine, and noble gases. These are

large semi-mobile systems with arrays of monitoring configurations and detectors, shielding to reduce background radiation effects, and electronic units to control data acquisition, analysis, and documentation.

1.4 References

- 10 CFR 20. 1991. U.S. Nuclear Regulatory Commission, "Standards for Protection Against Radiation." U.S. Code of Federal Regulations.
- 10 CFR 30. 1988. U.S. Nuclear Regulatory Commission, "Rules of General Applicability to Domestic Licensing of Byproduct Material."
- American Conference of Governmental Industrial Hygienists (ACGIH). 1989. *Air Sampling Instruments for Evaluation of Atmospheric Contaminants*, 7th ed. Cincinnati, Ohio.
- American Public Health Association (APHA). 1977. *Methods of Air Sampling and Analysis*, 2 ed., ed. M. Katz. Washington, D.C.
- Brodsky, A. 1980. "Resuspension Factors and Probabilities of Intake of Material in Process (Or 'Is 10^{-6} a Magic Number in Health Physics?')." *Health Physics* 39:992-1000.
- Kathren, R. L. 1984. *Radioactivity in the Environment - Sources, Distribution, and Surveillance*. Harwood Academic Publishers, New York.
- McGuire, S. A. 1988. *A Regulatory Analysis of Emergency Preparedness for Fuel Cycle and Other Radioactive Material Licensees*. NUREG-1140, U.S. Nuclear Regulatory Commission, Washington, D.C.
- National Council on Radiation Protection and Measurements (NCRP). 1976. *Tritium Measurement Techniques*. NCRP Report No. 47, NCRP Publications, Bethesda, Maryland.
- Ritter, P. D., B. L. Huntsman, V. J. Novick, J. L. Alvarez, and B. L. Rich. 1984. *The Role of Personal Air Sampling in Radiation Safety Programs and Results of a Laboratory Evaluation of Personal Air-Sampling Equipment*. NUREG/CR-4033, U.S. Nuclear Regulatory Commission, Washington, D.C.
- Sutter, S. L., J. Mishima, M. Y. Ballinger, and C. G. Lindsey. 1984. *Emergency Preparedness Source Term Development for the Office of Nuclear Material Safety and Safeguards-Licensed Facilities*. NUREG/CR-3796, PNL-5081, U.S. Nuclear Regulatory Commission, Washington, D.C.
- U.S. Nuclear Regulatory Commission. 1992. "Air Sampling in the Workplace." Regulatory Guide 8.25, Washington, D.C.
- Watson, E. C., and D. R. Fisher. 1987. *Feasibility Study on a Data-Based System for Decisions Regarding Occupational Radiation Protection Measures*. NUREG/CR-4856, PNL-6137, U.S. Nuclear Regulatory Commission, Washington, D.C.

2 Location of Air Samplers

Regulatory Guide 8.25 (NRC 1992) notes that concentrations of airborne materials can vary widely within a room so that improperly placed samplers and monitors can give misleading results. Even air samplers placed close to workers, for example, at the end of a hood or glovebox, may not accurately reflect the air concentrations of radionuclides in the workers' breathing zones. There have been many instances in which significant releases of airborne radioactivity were undetected by existing air-sampling systems in a work area. The major cause of such system failures was the improper placement of the air samplers. To locate fixed air samplers, continuous air monitors, and portable samplers in areas to ensure adequate air sampling, health physicists need a clear understanding of the flow of air in a work area. Proper placement of samplers cannot be determined by simply observing the position of room air supply and exhaust vents. Published experiences with airflow studies attest to their value.

2.1 Purpose of Airflow Studies

Health physicists can use systematic airflow studies, such as the release of smoke aerosols, to determine the airflow in a work area. The significance of airflow pattern studies and the use of the information for locating samplers depend, of course, on the purpose of the sample being collected—whether for estimating worker intakes, warning of high concentrations, testing for confinement or leakage of radioactive materials from apparatuses or enclosures, or defining airborne radioactivity areas. Table 2.1 lists the purposes and general placement of air samplers and monitors to best achieve the desired measurements.

Studies have shown the extreme differences that are possible between the concentrations in a worker's breathing zone and those measured at fixed locations or, as commonly done, in the area exhausts. In one study, an aerosol was released from multiple release points and sampling was conducted in the worker's breathing zone, at eight area samplers, and at four continuous air monitors, two located near exhausts and two inside the

exhausts (Scripsick et al. 1978). Dilution measurements were made between the breathing zone sampler and the other 12 sampler locations. Quantitative dispersion factors, equal to the ratio of the concentration at a remote location to the concentration at the release point, were then determined for each exhaust vent. Results showed that the average dispersion factor was 3×10^{-3} for the closest exhaust vent and 4×10^{-2} for the further exhaust vent, i.e., exhaust vent measurements underestimated breathing zone concentrations by a factor of between 25 and 330.

Other studies have shown that there can be a significant difference in sample measurements between lapel samplers worn by workers and fixed-location air samplers. One study compared results for lapel samplers with those for nearby fixed-location samplers in a work area containing concentrations of uranium (Brunskill and Holt 1967). The lapel samplers showed uranium concentrations up to 80 times greater than those of the fixed-location samplers; the average was 10 times greater for lapel samplers than for fixed-location samplers. This study also noted differences up to a factor of two for personal samplers located on the right side and on the left side of a worker's body. A second study found similar results when workers' activities caused increased airborne concentrations of radioactive materials. The ratio of the concentrations from lapel samplers to fixed-location samplers varied from 1.5 to 50; 85% of the ratios were less than 10 (Schulte 1967). Because the lapel samplers were typically closer to the airborne source than were the fixed-location samplers, they were measuring materials with particle sizes larger than those collected by the fixed-location sampler a short distance away.

Based on airflow pattern studies conducted by Advanced Systems Technology, Inc., a significant number of air samplers in facilities were not positioned adequately to sample airborne radioactive material released from potential sources. Air sampler placement based on

¹One Securities Centre; 3490 Piedmont Road, NE; Suite 1410; Atlanta, Georgia 30305-1550.

Table 2.1. Purposes and General Placement of Air Samplers and Monitors

Purpose of Sampling/Monitoring	General Placement of Samplers/Monitors
Estimate worker's intake for calculating internal dose	Sampler located in worker's breathing zone, near nose and mouth
Identify area needing confinement control	Sampler in airflow pathway near actual or potential release point
Provide early warning of elevated airborne release	Continuous air monitors placed between workers and release point(s)
Test for leakage of radioactive materials from sealed confinement system	Samplers located downstream of confinement-control area
Determine total concentration from many potential release points	Downstream at exhaust point
Determine if an airborne radioactivity area exists	Samplers at workers' locations
Special purposes, e.g., determining particle size	Case by case, depending on airflow patterns

location of ventilation supply and exhaust vents alone was found to be inadequate because of the considerations discussed below. Although the following examples do not describe all possible work environments, they demonstrate how airflow is affected by various features of the work area.

2.1.1 Stratification and Stagnation

Stratification, the accumulation of contaminants in distinct layers, can occur in radiological facilities under several circumstances. Thermal stratification is often observed in large rooms with high ceilings. Equipment that introduces a large heat load into a room can produce thermal currents that alter airflow patterns significantly. Heat loads can reverse the normal airflow patterns from corridors into laboratories or process areas, with warm air flowing out from the top of a doorway and cooler air flowing into the room at floor level, despite the presence of supply and exhaust vents within the room. The presence of large structures, equipment, or partitions within rooms can produce areas with stagnant airflow conditions. This problem

can be particularly significant if a facility has undergone modification since its ventilation system was originally designed. Added equipment can disrupt laminar airflow patterns within a room and produce low-velocity vortices and eddies with elevated local concentrations of airborne radioactive material. In the study represented in Figure 2.1, air was supplied through several vents located throughout the room. Air was exhausted through the roof at several evenly spaced vents high on the walls and also through the floor to the room below. The air was being pulled up and down, resulting in the creation of a stratification layer in one section of the room. The stratification layer was detected by releasing a smoke candle at an elevated sampling station. The smoke drifted downward and pooled in a layer approximately 0.6 m (2 ft) thick and about 1.5 m (5 ft) from the floor. The layer moved slowly southward down one side of the room. Next, the pooled layer crossed to the other side of the room, turned northward, and slowly dissipated. Known releases and associated intakes had occurred in this facility. The releases were generally not detected by fixed-location air samplers due to the unusual and unexpected airflow patterns.

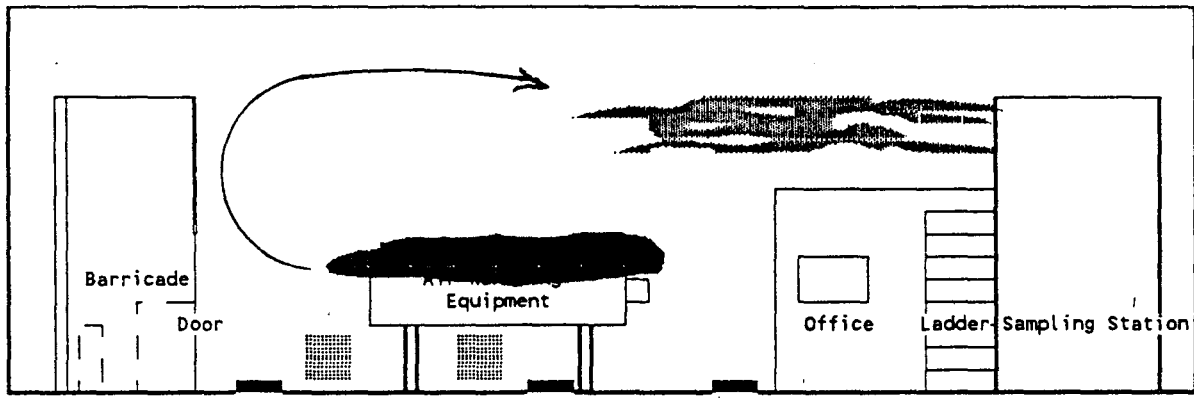

North =

Location of Air Samplers



Note: This exhaust is located beneath the dissipating stratified layer

Legend

-  = West wall supply duct locations
-  = Floor exhaust duct locations

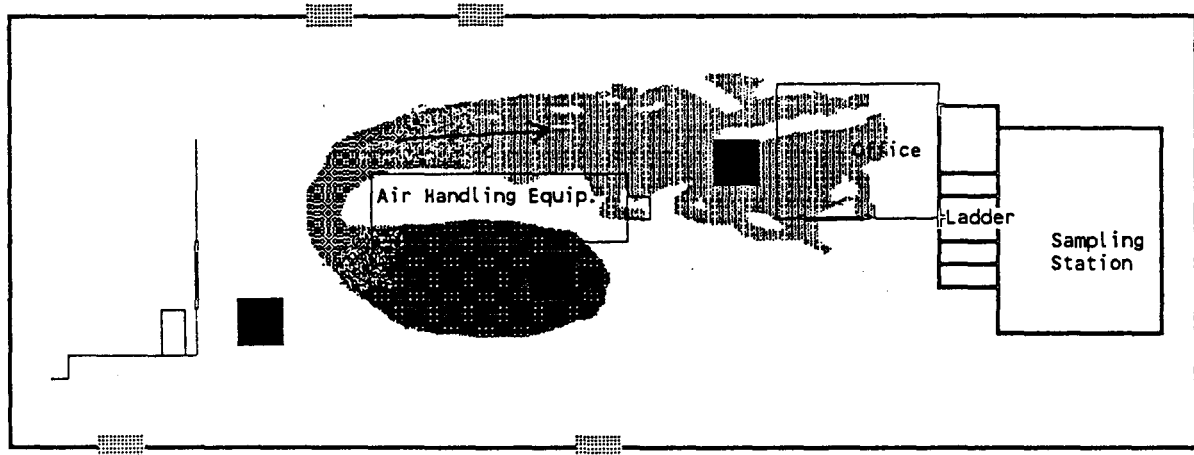

Legend



-  = Wall supply duct locations
-  = Floor exhaust duct locations

Figure 2.1. Example of Stratification of Air Layers

Location of Air Samplers

2.1.2 Water-Filled Pools

Water-filled pools, such as spent fuel pools, can modify airflow patterns as a result of thermal currents. This is particularly true during periods of high thermal loading, such as those encountered during full-core, off-load conditions. Thermal uplift over the surface of the water can draw air from the walls of the refuel floor or fuel handling building to the pool. Warm moist air that reaches the ceiling is cooled and flows downward along the exterior walls. This problem can be particularly severe during winter outages. In some cases, these thermal air currents can act as flow boundaries that prevent or restrict flow across the pool.

Thermal uplift can also modify flow patterns observed under conditions where the pool temperature is approximately equal to the building ambient temperature. Performing airflow studies using smoke tubes or smoke candles during outages or periods of major activity around water-filled pools provides a realistic picture of airflow under those operating conditions.

In the facility shown in Figure 2.2, air was supplied on the west side of the spent fuel pool through a series of vents located about 4.5 m (15 ft) from the floor. Air was vented through a similar arrangement of vents located on the east side. Air samplers were placed on the east side of the pool. The health physicist assumed, because the air flowed from west to east, that releases from the pool would move accordingly.

However, based on the study using smoke candles and smoke tubes to simulate releases at the water surface, the flow pattern in Figure 2.2 was determined. The smoke moved westward instead of eastward and then travelled along the west walkway where no samplers were located. Releases on the east side of the pool also moved westward and then upward toward the exhaust vents. The samplers located on the east walkway would not intercept a release from the pool.

The airflow at levels above 3.6 m (12 ft) generally flowed from west to east.

2.1.3 Doors

Under some conditions, cool air may enter a room through the bottom of a doorway while, at the same time, warm air flows out through the top. Airflow

studies and air sampler placement verification made under the same conditions as experienced during operation helps ensure that samplers will be positioned in the best locations to collect airborne radioactivity. If the facility is to be operated with the doors normally open, making necessary changes to the room air balance ensures adequate control of potential airborne radioactive sources. Reverse airflow from laboratories or other engineered facilities can also be induced when the airflow through a corridor is significantly higher than normal. This can happen when delivery or service entrances are opened to the outdoors. The increased airflow through the corridor may be sufficient to draw air from the laboratories into the corridor.

In one airflow study test of a laboratory, the hood was used as the principal room exhaust. Air was also vented through vents located on the mezzanine level above. Air was supplied through the open doorways and through small ceiling vents. Smoke tests demonstrated that air flowed into the bottom of an adjacent office after bypassing the hood and passing through a surface contamination area. The airflow entered through the bottom part of the door even though only air supplies with no exhausts were located in the office (see Figure 2.3).

2.1.4 Bi-Level Airflow

Air can flow in opposite directions within the same room. This typically occurs in poorly designed ventilation systems, such as the case in which the supply vent is located near the door to a long, narrow room or gallery with no exhaust vent provided. In this case, supply air would flow from the vent toward the rear wall of the room or gallery where it is deflected back toward the supply vent and door. In cases of bi-level airflow, the proper air sampler placement depends heavily on the elevation of the release point and the worker's breathing zone. In such cases, it may not be possible or practical to use a single fixed air sampler. Multiple fixed air samplers or lapel samplers worn by workers may be needed to adequately intercept releases of radioactive material.

In the example shown in Figure 2.4, air was supplied at the northern end of a long corridor with cells on both sides. The air traveled southward and was vented into some cells and an exhaust pit located on the floor near the middle of the corridor. The air velocity was high at

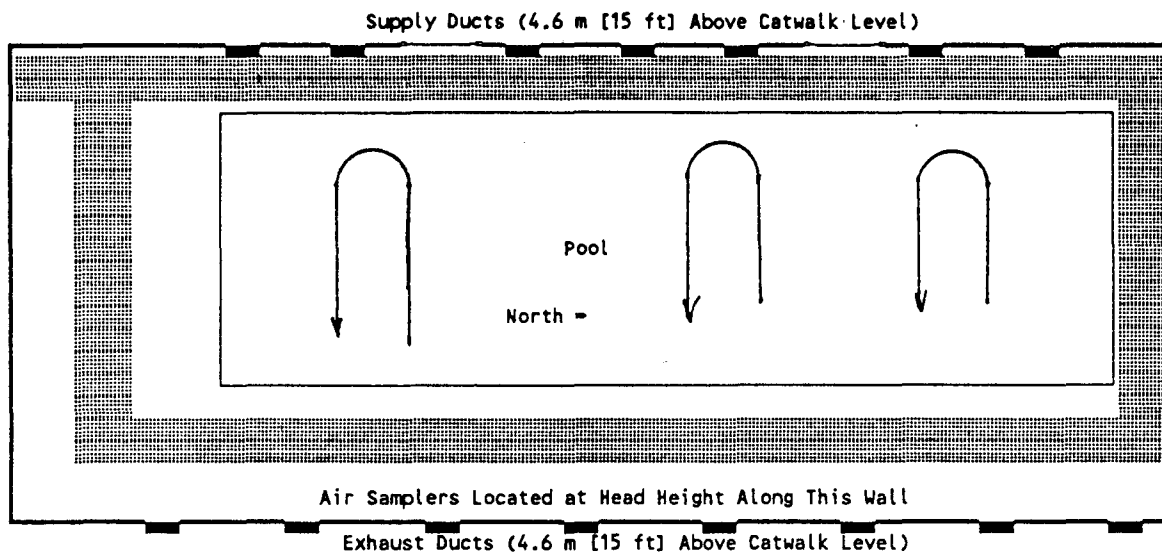

Legend

- ▬ = West wall supply duct and east wall exhaust duct locations.
- ▨ = Catwalk around pool

VIEW FROM ABOVE

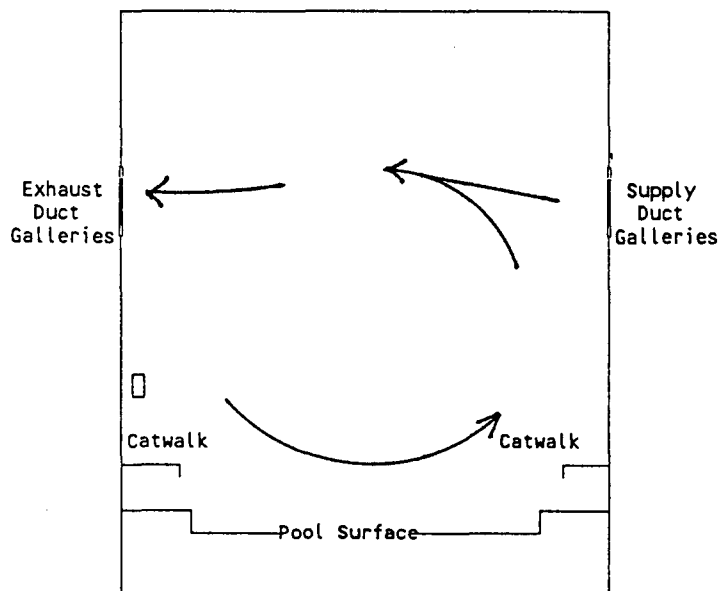

VIEW FACING SOUTH FROM NORTH WALL

Legend

- ▬ = Location of ducts (supply on west [right side] and exhaust on east [left side])
- = Location of air samplers above catwalk

Figure 2.2. Airflow Modification Due to Water

Location of Air Samplers

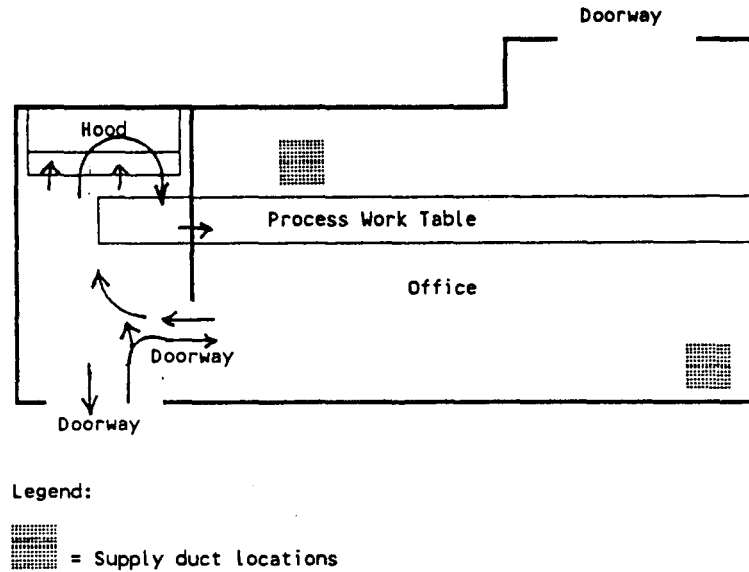

Figure 2.3. Example of Variable Flow Through Openings (Doors)

1.8 m/s (350 lfpm) near the northern end. This high velocity caused air to flow rapidly to the rear of the corridor, which does not contain an exhaust vent. The air was then forced upward and returned northward where it was exhausted into the pit.

Bi-level flows represent a particular problem when valves and lines transporting radioactive materials are located at the top of the cell. Positioning the sampler at the lower level downstream of the release point (valve) would not capture the release. The release would actually flow in the opposite direction.

In this example, personnel had received significant contamination during the operation of leaking valves, which were located at the top of the cell. The releases were not detected. The air circulated across the airborne radioactivity area boundary rope located in the southwest corner. The health physicist had assumed incorrectly that air in-leakage through the door would create a flow toward the center of the room and exhaust in the cells and pit.

2.1.5 Recirculating Airflow

A recirculation pattern may be established by a poorly designed ventilation system, or a room configuration that is different from that for which the original system was designed. Recirculation patterns can develop if the

supply and exhaust ducts are configured so that the supply air impinges on a wall, is transported vertically, and moves back in the direction of the supply without being intercepted by the exhaust ducts. In such cases, lobes of higher concentration will be formed.

Samplers could be placed in each recirculating lobe to capture a representative sample. A redesign of the ventilation system or reconfiguration of the room layout could also correct this problem.

2.1.6 Wall and Floor Penetrations

Unsealed wall and floor penetrations represent a potential pathway for movement of airborne radioactive material to or from adjacent rooms or spaces. Aerosols may be transported by either differential air pressure or thermal currents. Airflows may be reversed under some conditions (e.g., open versus closed door, transient heat loads, etc.).

Performing airflow studies for all possible conditions helps to determine airflow patterns between rooms for both proper air sampler placement and protective requirements. Although sealing of penetrations is recommended, many considerations, such as thermal expansion or environmental qualification requirements, may preclude this.

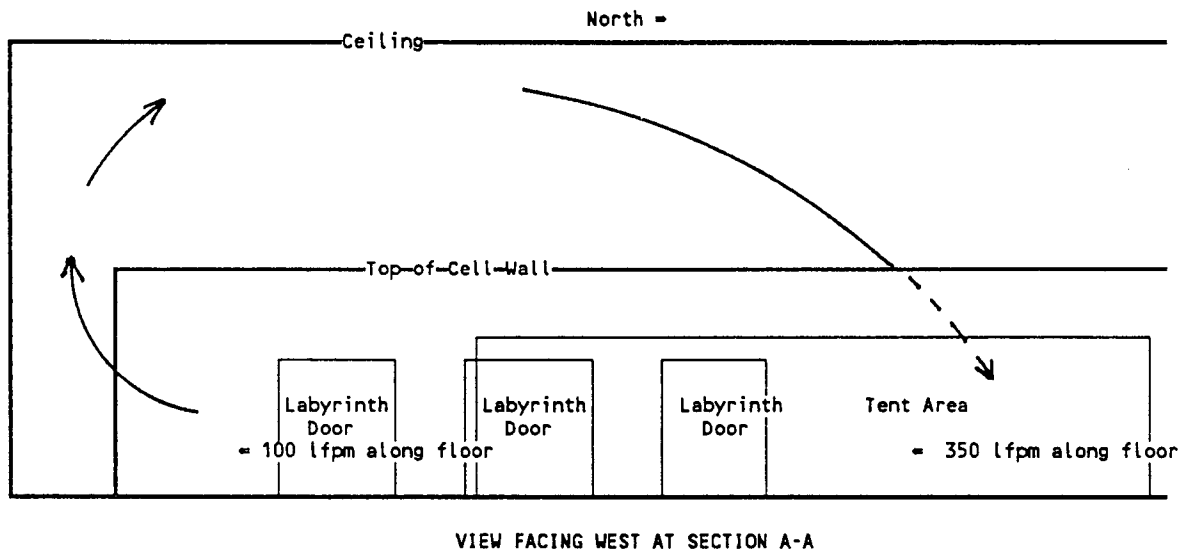
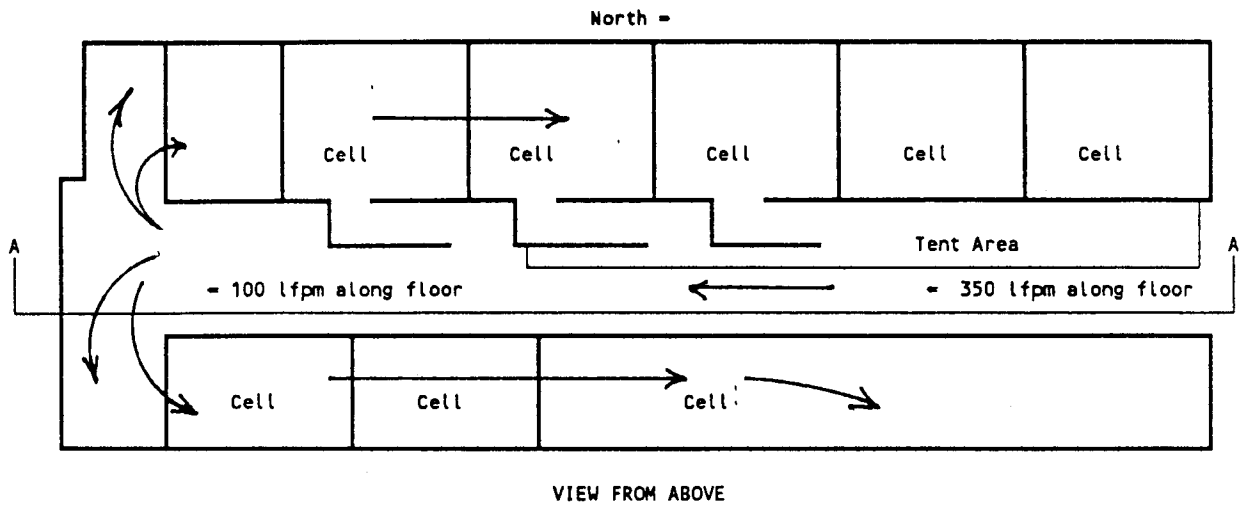

Figure 2.4. Example of Bi-Level Flow Reversals

The control room areas, where personnel may stay during release events, are generally provided with a separate ventilation system that can be isolated. In Figure 2.5, the control room was surrounded by sources of potential airborne release. During the study, smoke released from the source points entered the reportedly sealed control room through the air conditioner intake located outside the control room.

2.2 Determination of Airflow Patterns

Regulatory Guide 8.25, suggests that an airflow study be conducted after any work-area changes, including changes in the setup of work areas, ventilation system changes, or seasonal variations that might change airflow patterns (such as opening doors and windows in

Location of Air Samplers

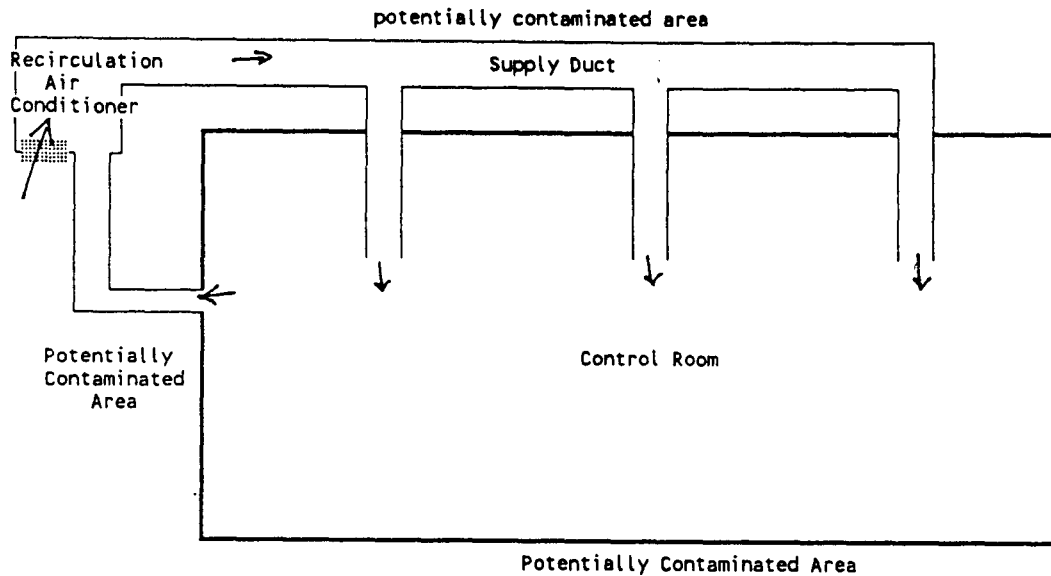

Figure 2.5. Example of Unexpected Flows

the spring or summer). Changes in the configuration of work areas often involve the addition of contamination containment structures or partitions, or of hoods or waste compactors; any of these added features in a work area can change the airflow. A new hood, for example, will act as another exhaust point in the room, and the waste compactor's exhaust vent, if directed into the room, could modify the airflow. Equipment that generates waste heat, such as chillers, power supplies, large motors, or other process or experimental equipment, can produce the airflow pattern changes described in Section 2.1. Ventilation system changes to be aware of include rebalancing the ventilation system, adding or removing supply air or exhaust vents, or changing the location of an existing supply air or exhaust vent.

Regulatory Guide 8.25 also recommends a routine evaluation of fixed-location samplers—10% evaluated once a year—to determine if their locations are still appropriate. Such spot tests would most profitably concentrate on samplers near the points in a work area with greatest potential for release.

Finally, informal observations of changes in airflow patterns, such as a change in the direction of flow or a noticeable increase or decrease in flow velocity, would require further investigation and a proper airflow study.

2.2.1 Preparation for Airflow Studies

Certain preparations provide a good starting point for making an airflow pattern study. First, review the significant features of the work area, the area's air-sampling history, and any facility changes that may have affected airflow patterns since the last study to determine which areas to test. Additional useful information can be gained by determining potential radiological source terms for each work area, noting those that have the greatest potential for release, and mapping the normal configuration of the work areas, both for the current study and for future reference. The maps could include the locations of current air samplers and monitors, supply air vents, exhaust vents, doors, and major pieces of equipment, such as process equipment, gloveboxes, and hoods.

Recording normal working conditions that may affect airflow is also suggested, including whether each door is open or closed during normal operations, or whether the heating, ventilation, and air conditioning (HVAC) unit is normally on or off. Heat-generating sources, such as ovens or furnaces, and equipment exhaust fans may also affect airflow. Note that the engineering drawings of the ventilation system may not accurately reflect how the system currently works unless they have been carefully

maintained to reflect as-built conditions. The HVAC maintenance staff may be the best source of information; they may be able to supply differential pressure readings and hood and stack flows. A health physicist may want to determine if modifications to the ventilation system have altered the airflows, or if future alterations can be expected to change airflows. If major ventilation system modifications are planned within the next several months, delaying the study until after modifications are finished may eliminate the need for retesting.

In areas of high external dose rate or high concentrations of airborne radioactive materials, it is desirable to keep airflow testing to a minimum. Regulatory Guide 8.25 recommends that worker dose be maintained as low as reasonably achievable (ALARA) during airflow studies. For example, instead of using smoke candles with two people observing the dispersal of the aerosol, a single observer using smoke tubes would reduce the disruption during operating hours and perhaps be more representative of normal airflow. Another possibility would be to videotape the airflow tests, removing workers from the area while the test is being conducted.

2.2.2 Methods of Airflow Studies

The two types of airflow pattern studies are qualitative studies, which use an aerosol that can be visually observed and recorded, and quantitative methods, which actually provide measurements of dilution effects in the work area. Qualitative studies are generally adequate for placing air samplers. The quantitative methods, which are more expensive and time-consuming, determine how well fixed-location samplers actually measure the concentration in air that workers breathe. The advantages and disadvantages of the methods are summarized in Table 2.2.

2.2.2.1 Qualitative Airflow Studies

Qualitative methods are the primary means of determining airflow patterns to assist in the placement of air samplers. Qualitative methods include the use of smoke candles and smoke tubes, helium-filled balloons, and isostatic bubbles. A combination of smoke candles and smoke tubes is in common use today at nuclear facilities because they are readily available and relatively inexpensive.

The airflow direction and transit times can be readily determined by visual observation of the smoke aerosol. The airflow patterns can be recorded on worksheet drawings with narrative descriptions or by using photographs or videotapes.

Smoke candles, sometimes referred to as smoke bombs, are available in a variety of sizes (e.g., 120 m³ [4000 ft³] and 240 m³ [8000 ft³]) and produce a grayish white smoke. The smoke is actually a mist, seeded by zinc chloride, and contains a large percentage of atmospheric moisture. The diameter of smoke particles is 0.01 to 1 μm. The smoke is somewhat buoyant because of the heat generated by the smoke candle.

Smoke candles are best used to determine the general airflow patterns in large areas. The observation of smoke as a means to determine airflow is limited to situations of relatively low air velocity. At high velocity (greater than 30 m/min [100 ft/min]), the smoke diffuses too rapidly to allow tracking with the naked eye. Most work areas have airflow velocities of less than 30 m/min (100 ft/min), except for those locations near supply air vents, narrow corridors, or entrances into rooms.

The appropriate amount of smoke released during a test depends on the size of the work area. To protect the floor surface, smoke candles are typically placed in a metal can before being lighted. Enough smoke is released to create a visible haze but not enough to totally obscure vision. The amount of smoke can be varied by the size of the candle used or by smothering the candle to stop the smoke (i.e., placing a lid on the metal can). During testing, personnel wear full-face respirators with special cartridges for particulates, smoke, mists, and vapors (e.g., MSA-GMC-H chemical cartridges) because the smoke is a respiratory irritant.

Smoke tubes produce less aerosol than smoke candles, approximately the amount produced by a burning cigarette. The smoke generated is a cold smoke produced by a corrosive acid, which is not as dense as that of smoke candles and has no initial buoyancy. Smoke is generated from the plastic or glass tube containing the corrosive acid material by squeezing air through the tube with an aspirator bulb.

Location of Air Samplers

Table 2.2. Comparison of Techniques Used to Determine Airflow Patterns Within the Workplace (Mishima et al. 1988)

Technique	Advantages	Disadvantages
Qualitative Methods		
Smoke candles	Equipment readily available; provides visible evidence of airflow	Semi-quantitative; limits visibility; may affect operations; leaves residue; makes thermal plume
Smoke tubes	Readily available; visible evidence of airflow, leaves no residue	Can only evaluate small areas at a time; not quantitative
Isostatic bubbles	Visible; more persistent than smoke	Semi-quantitative; may affect operations; leaves residue
Quantitative Methods		
Tracer aerosols	Quantitative for range of particle sizes	Choice of tracer particles limited; costly; requires large array of detectors
Tracer gases	Quantitative for gases, vapors, and particles	Can require many detectors; < 2- μ m activity median aerodynamic diameter (AMAD); choice of tracer gases limited

Smoke tubes are used primarily in small work areas less than 27 m² (300 ft²), where smoke candles would produce too much smoke to allow observation of the airflow. In laboratories or work areas with sensitive analytical equipment, smoke tubes are used because they leave less residue than do smoke candles. Sensitive equipment can be covered for protection from the smoke candle residue. Smoke tubes can be used to quickly show if airflow direction is different at various heights above the floor. They also give initial information on workplace airflow before using smoke candles.

Air velocity measurement instruments, such as hot-wire anemometers, can provide useful information on air velocities in work areas. Such air velocity measurements, used in conjunction with smoke test results, provide information on airflow patterns. For example, air velocity measurements would tell the time it will take a release to reach a key location in the work area (e.g., the exhaust vent); these measurements could then be compared with the velocities estimated from the smoke drift over a known distance. In another kind of

application, air velocity measurements can be used to help determine the size of an area of stagnant air noted during the smoke testing. For instance, if smoke tests revealed little air movement in a certain location, a hot-wire anemometer reading of less than 3 m/min (10 ft/min) in the same location would reinforce the smoke test results.

2.2.2.2 Quantitative Airflow Studies

Quantitative methods, such as tracer studies, provide measurements of dilution effects in the work area, but are more expensive and time-consuming than qualitative methods. To characterize the aerosol dispersion, non-radioactive tracer aerosols are released at the potential release points for radioactive materials and then the concentrations of the aerosol are measured at selected points in the work area. The dispersion of the aerosol at a remote location from the release point is expressed as the ratio of the concentration measured at the remote location to the concentration measured at the release point.

An application of this concept is illustrated in Figure 2.6. The largest concentration is measured near the release point (Location A) and the dispersion factors (D) at remote locations are determined by the ratio of the concentration at the remote location to the concentration at Location A. From the dispersion factor data in Figure 2.6, one can conclude that most of the flow is toward the east into the exhaust vent sampled by Sampler C.

Quantitative methods of analyzing airflow patterns can be used to determine the representativeness for breathing zone samples, as discussed in Section C.3.2 of Regulatory Guide 8.25. These methods can be especially effective when the workplace air concentrations are normally near the lower limit of detection, making it difficult to use any one of the other three methods for determining that breathing zone samples are representative (i.e., comparison with lapel sampler results, comparison with bioassay results, and comparison with multiple measurements near the breathing zone).

Quantitative methods can also be used for placing fixed-location air samplers. For example, they can be used to quantify the amount of dilution between a release point and an exhaust vent, allowing a health physicist to determine if the counting equipment is sensitive enough to measure a release for the given sampling conditions.

Several kinds of tracers can be used: tracer gases (e.g., helium and sulfur hexafluoride), fluorescent particle tracers, ice nucleus particle tracers, and nonspecific aerosol particle tracers. Tracers are not used routinely in the nuclear industry as an aid in placement of workplace air samplers. Therefore, facilities that elect to use one of these methods either to show sample representativeness or to aid in determining sampler placement are likely to have to perform some development work.

The desirable properties of tracer gases are detectability at a relatively low concentration in ambient air, non-reactivity, and nontoxicity. If a large area is to be tested, tracer gas can become costly. Although sulfur hexafluoride, halocarbon refrigerants, and perfluorocarbons have been found to be the most cost-effective for large areas, they are environmentally unsound and are being phased out. Common tracer gases and their typical measurement techniques are noted in Table 2.3 and discussed below. Refer to the report by Mishima et al. (1988) for more detailed information on using tracer gases for determining airflow patterns.

Fluorescent Particle Tracer

Fluorescent particle tracers have the advantage of more closely simulating the inertial properties of particulate aerosols (e.g., uranium aerosols) than do gaseous tracers. A disadvantage of this method is that only time-integrated concentrations can be determined from the sample analysis.

One successfully concluded quantitative airflow study using a fluorescent particle tracer was done in an area containing several plutonium gloveboxes (Scripsick et al. 1978). Simulated airborne releases at gloveboxes were made from 20 potential release locations in the work area under study. The fluorescent particle test aerosol was generated from a 0.1% solution of fluorescein in 0.01 N NH_4OH . Fluorescein is an organic compound used to generate test aerosols in the laboratory. Its fluorescent properties permitted detection of airborne concentrations down to $0.1 \mu\text{g}/\text{m}^3$. The aerosol generator used was designed and built at Los Alamos National Laboratory and consisted of 24 nebulizers suspended in a 30-cm- (12-in.-) diameter canister filled with the 0.1% fluorescein solution. Releases were made at about 1.3 m (4.3 ft) above the floor. During the release, air samples were collected with the room air-sampling system. Additional air samples were collected with samplers located at both room ventilation exhausts. Air sample filters from the tests were placed in bottles containing 0.01 N NH_4OH solution. These solutions were analyzed using a fluorometer. Blanks for this test were made by placing clean filters into 0.01 N NH_4OH solution. The breathing zone concentration to an individual at the release location was measured by air sampling at ~ 0.4 m (1.3 ft) above the generator exhaust, i.e., about 1.7 m (5.6 ft) above the floor. The results were used to calculate dilution factors between the worker's breathing zone and the sampler locations.

Ice Nucleus Particle Tracer

Ice nuclei are particles that nucleate ice crystals in super-cooled clouds. Only a few chemicals (e.g., silver iodide and phloroglucinol) can nucleate ice crystals efficiently. The advantages of using this type of tracer are that it can be detected in very low concentrations and provide a real-time indication of air concentrations.

The major disadvantage of this method is that detectors are bulky and heavy, making multipoint sampling difficult. Laser particle counting is better suited for

Location of Air Samplers

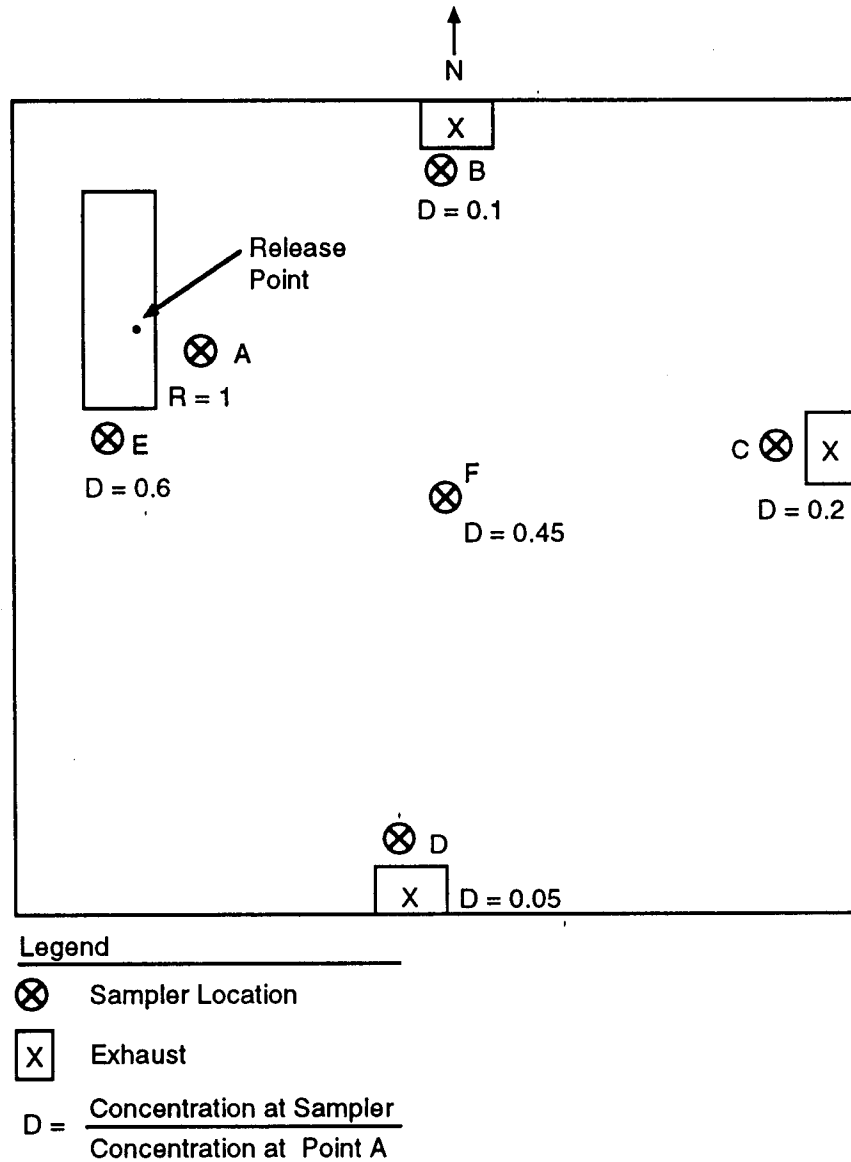

Figure 2.6. Quantitative Dispersion Factors

multipoint sampling. A single-particle, real-time detector has been used to track ice nuclei particles in a plutonium area (Langer 1987). The detector consisted of a 10-L cloud chamber and associated refrigeration.

For more information, refer to the report by Mishima et al. (1988), where experience in using ice nuclei particle tracers is reviewed.

Table 2.3. Common Tracer Gases and Measurement Techniques

Tracer Gases	Measurement Technique
Hydrogen (H ₂), helium (He), and carbon dioxide (CO ₂)	Thermal conductivity detector
Sulfur hexafluoride (SF ₆), refrigerants, and perfluorocarbons	Electron capture gas chromatograph
Ethane (C ₂ H ₆)	Flame ionization gas chromatograph
Carbon monoxide (CO), CO ₂ , SF ₆ , N ₂ O, C ₂ H ₆ , and methane (CH ₄)	Infrared absorption
Ethyl iodide (CH ₃ CH ₂ I)	Neutron activation analysis (see Contreras and Schlapper 1985)

Nonspecific Aerosol Particle Tracer

A nonspecific aerosol tracer is useful because instrumentation for counting aerosol particles by optical means is readily available and relatively inexpensive. One type of nonspecific aerosol tracer system is the laser particle counter, which has the advantage of showing the effects of particulate depositions, that a gaseous aerosol cannot show. Moreover, a laser particle counter system provides data in real time, the detectors can be multiplexed, and the data output can be routinely computerized. Commercial software and a multiplexer system are available that can handle data from up to 64 laser particle counter detectors simultaneously. A laser particle counter system has been used to study airflow patterns at a plutonium facility (Langer 1987). A simple pneumatic atomizer produced solid tracer particles with two particle-size ranges (greater than 0.5 μm and less than 5.0 μm) from the evaporation of sugar solution droplets.

2.2.3 Performing Qualitative Airflow Pattern Studies

Ideally, qualitative airflow studies would be performed with staff positioned in the work area, performing their normal jobs to best represent airflow patterns. In reality, however, studies are typically done with no workers in the work area (i.e., no movement in the area) because it is neither practical nor desirable to have workers wearing respirators during smoke testing.

Often to avoid exposing workers to the smoke, testing is performed during off-shifts or at other times when workers are not present. However, during work activities, airflow patterns could vary, particularly in the localized area around a worker who is moving. Thus, the health physicist anticipated the actual airflow patterns, based on observations of work habits in the area and on the qualitative airflow study, in order to find suitable locations for the samplers.

Preparation for a qualitative airflow pattern study using smoke candles includes covering sensitive equipment such as computers to keep out potentially damaging smoke residues. Because smoke plumes are tracked in the work area during testing, the room is well lit. If the light in the area is dim, portable lighting may be used for better visibility of the smoke; it is important to remember, however, that portable lighting could produce unwanted thermal effects on the airflow.

To begin a qualitative airflow pattern test, the smoke candle is placed near the points at which radioactive materials are potentially or actually released. After the smoke is released, it is recommended that at least two persons observe the dissipation of the smoke in the work area: one person standing downwind of the release point and one person standing upwind. Both observers record 1) the pattern of smoke flow and 2) the time it takes for the smoke to be dissipated (i.e., until it is not visible to the naked eye). In addition, the downwind observer notes the time required for smoke to

Location of Air Samplers

reach key locations, to enable estimates of air velocities in the work area. Each observer independently records observations. The results are then documented on drawings of the work area. After the smoke has cleared, the observers consolidate their observations into a single airflow pattern description for the work area.

2.2.3.1 Examples of a Qualitative Airflow Study in a Laboratory

The following example, which is based on real data, outlines the steps a health physicist would take in conducting an airflow pattern study for the work area shown in Figure 2.7.

First, the health physicist identifies potential release points for radioactive materials in this work area: the hot cell loadout port, the hot cell manipulator area, Hood 1, and Hood 2. The areas with the largest source term potential are the hot cell loadout port and the hot cell manipulator area. The health physicist also takes into account the physical and chemical form of the material. The next step is to document the configuration of the ventilation system in the work area. Supply air to the work area is from two ceiling supply air vents and through the south door, which is left open during work activities. The room air is vented through the wall exhaust vent in the northeast corner of the room and through Hoods 1 and 2. There are no temporary activities, such as opening large service-bay doors, nor are there other equipment or a heat-generating source that might affect airflow in the room.

The health physicist now documents routine work activities. During routine operations, two workers operate the manipulators located on the east side of the hot cell. Work in the hot cell is typically done during two shifts per week. Hoods 1 and 2 are used for sample preparation activities on a daily basis. Review of past air sample results for the four air samplers located in the room indicates no elevated results for the past 2 years.

Next, the health physicist documents the status of the work area's ventilation system before beginning the airflow study. No ventilation system upgrades were performed during the past year and none are currently planned by the maintenance staff. Monthly differential pressure readings taken at various locations throughout

the work area have been consistent for the past several months. Monthly air velocity measurements for Hoods 1 and 2 have been consistent. The latest ventilation system data (before the current airflow study) were recorded.

The health physicist then performs the smoke test and observes airflow patterns. Smoke candles are lit in front of the hot cell loadout port and between the hot cell manipulators because these areas have the greatest potential source term. Smoke tubes are used to define airflow near the hoods. The smoke aerosol from the candle in front of the loadout port travels north and west, with most of the aerosol flowing towards Hood 2. A smaller portion of the aerosol flows into the northeast corner exhaust vent. The smoke aerosol that does not flow directly into either exhaust vent continues to the north wall and recirculates in a southward direction, filling the north third of the room. Eventually, the aerosol is exhausted through Hood 2 and the northeast corner exhaust vent. The smoke aerosol from the candle near the manipulators rises and mixes with the supply air and quickly disperses through the width of the room. The aerosol then drifts to the north and is vented through the northeast exhaust vent and Hood 2. More of the aerosol is observed flowing into the northeast exhaust vent.

Based on the smoke test, the health physicist draws the following conclusions and makes the associated recommendations regarding the locations of the four samplers:

- Sampler 1 – This sampler is upwind of the loadout port and would be better located to the east side of the loadout port.
- Sampler 2 – This sampler appears to be in a good location to sample any releases that may occur near the manipulators.
- Sampler 3 – This sampler is located in the supply airflow coming in the south door. The sampler would be better located on the front surface of Hood 1.
- Sampler 4 – This sampler appears to be in a good location to sample any releases from Hood 2.

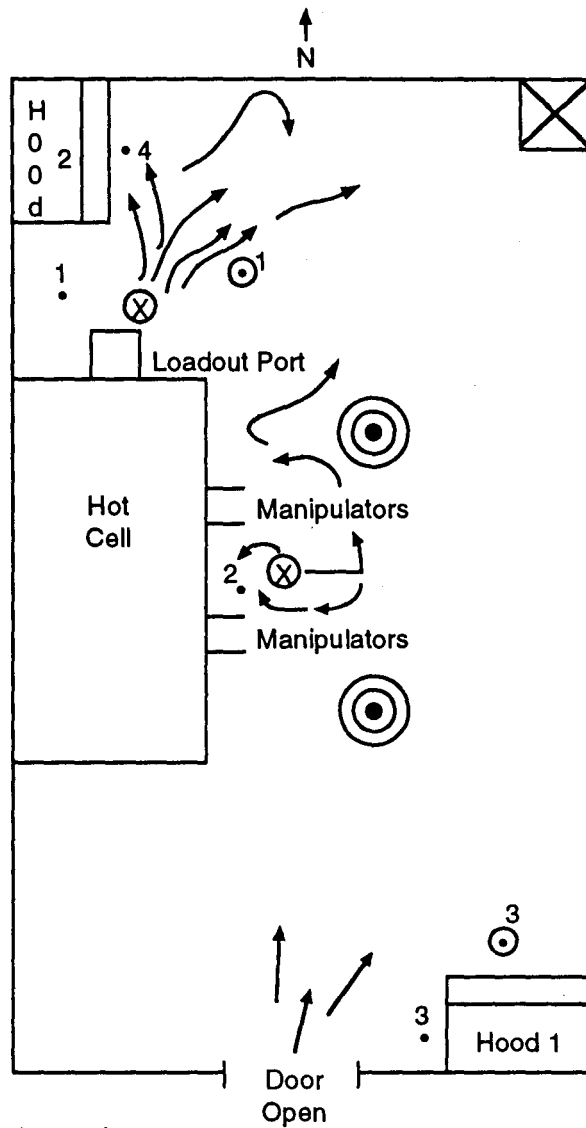

Legend

- ⊙ = Ceiling Supply Air Vent
- ⊠ = Wall Exhaust
- = Fixed Air Sampler Location
- ⊙ = Recommended Air Sampler Location
- # = Smoke Candle Location

Figure 2.7. Diagram of Example Work Area

Location of Air Samplers

2.2.3.2 Airflow Study at a Nuclear Power Plant

The following example outlines the steps a health physicist could take in conducting an airflow pattern study at a nuclear power plant.

A health physicist at a pressurized water reactor power plant needs to determine the air-sampling needs for a nonroutine radiation work permit. The job requires removing insulation and preparing welds and components for nondestructive examinations for in-service inspection programs. For this particular task, the insulation is removed and the loop stop valves are inspected. The health physicist expects that the work may cause higher-than-normal airborne radioactive material levels. The health physicist reviews the general area survey data, the air-sampling data from similar past operations, and data from the adjacent operating unit. Before the work begins, there are some surface contamination levels above 1000 dpm/100 cm² and the general area survey reads about 20 mrem/h. Because of the surface contamination levels, there is the potential for increased airborne contamination requiring continuous air sampling during the job.

While not done in this case, the health physicist could decide to perform qualitative smoke tests to determine if the portable air samplers are well-located to measure airborne radioactive material levels. In making that decision, the health physicist would have to decide if the improvement in the air sampling data would be worth the dose that would be received while the smoke tests were being performed. If the dose received due to conducting airflow tests is likely to be a substantial fraction of the dose received when performing the in-service inspection work, smoke tests probably would not be justified. On the other hand, if the dose likely to be received during the in-service inspection work was likely to be substantial, it would be acceptable to receive some dose while doing airflow tests in order to improve the quality of the measurements of dose received during in-service inspection. In this example, it is assumed that the health physicist has concluded that more accuracy in the air sampling measurements is important and that the air flow tests are thus necessary.

There are little data on the ventilation systems that would be useful in determining the flow patterns of the cubicle in question. However, in the cubicle being evaluated, the cooling coil banks are suspended from the ceiling above the 81-m (271-ft) level. Below the cooling coil banks is the loop stop valve that will be worked on.

In general, containment air flows from the top of the dome and upper elevations to lower elevations. Four 3.1×10^5 L/min (11,000-cfm) fans, two for supply and two for exhaust, are located in the auxiliary building; they are operated in various combinations to yield flow rates through containment that range from 3.4×10^4 - 6.2×10^5 L/min (1200 cfm to 22,000 cfm).

Because the cubicle is an odd shape with large open bays to the steam generator and reactor coolant pumps that might affect the airflow, the health physicist makes a thorough survey of the area with smoke tubes to determine the expected flow and determine where to locate the smoke candles. Figure 2.8 illustrates the flow patterns obtained from the smoke tubes.

After the general survey using smoke tubes, smoke candles are lit one at a time in the areas numbered 1 through 4 in Figure 2.9. However, because the areas are rather confined, with the large bays open to levels below, the health physicist has several assistants who are assigned to observe the smoke at various elevations (i.e., floor level, about eye level, and overhead). However, because of the high exposure rates in the area, the number of personnel to observe the test is minimized. The smoke patterns observed are also shown in Figure 2.9.

Based on the smoke tests, the health physicist concludes that most of the air near the loop stop valves located under the cooling coil banks (at the top left corner of the cubicle) is swept east and down the opening to the loop stop valves on the lower level. The health physicist recommends the following sampler locations:

- Sampler 1 – A portable air sampler is recommended to be located east of and as close as possible to the loop stop valves, about 1.5 m (5 ft) from the floor, if possible.
- Sample 2 – A second sampler is recommended to be located west of the loop stop valves at the elevation below 80 m (262 ft), about 1.5 m (5 ft) above the floor. This air sampler would probably sample airborne contamination from the adjacent loop stop valve and, if work was going on at the same time, at the loop stop valve on the 83-m (271-ft) level.

2.2.4 Quantitative Airflow Pattern Studies

Before choosing a quantitative method for an airflow study, the type of potential release is characterized in as

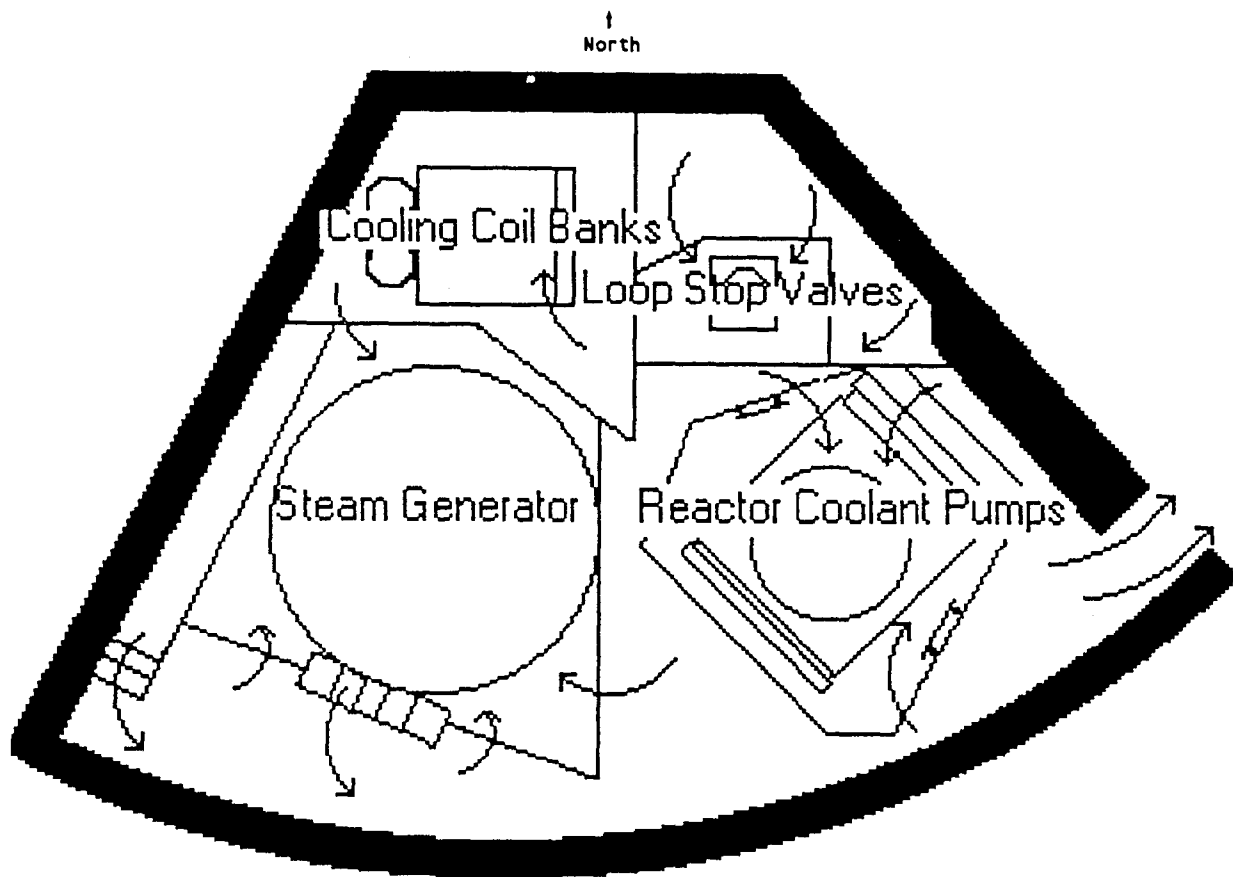

Figure 2.8. Preliminary Airflow Pattern Survey in Cube at 262-ft Level

much detail as possible. For example, for a potential noble gas release, a gaseous tracer would be applicable; for a potential uranium release, the laser particle counter method or fluorescent particle tracer method would be better. Particle sizes of the released material are matched with the particle sizes of the tracer material so that the effect of particle deposition will be similar.

2.2.4.1 Example of a Quantitative Airflow Pattern Study

The following example, which is based on real data that have been adjusted for the example, outlines the steps a health physicist would take in conducting a quantitative airflow pattern study. The health physicist has already conducted a qualitative (smoke testing) study and knows the general airflow patterns in the work area. Those results are included in the example above of a qualitative airflow pattern study of a laboratory (see Figure 2.7).

The health physicist uses a fluorescent particle tracer method to perform the quantitative airflow study (see Scripsick et al. 1978). An aerosol generator is located at the loadout port for Test 1 and at the manipulator area for Test 2. The following conditions exist at each test location:

- Releases are made at the height of the loadout port for Test 1 and at the height of the manipulators for Test 2 to simulate potential release heights.
- Six portable air samplers capable of collecting samples at a rate of 75 L/min (2 cfm) are located as indicated in Figures 2.10 and 2.11. The locations were chosen based on the smoke test results, which showed the major portion of the smoke aerosol passing these locations. The sample collectors are

Location of Air Samplers

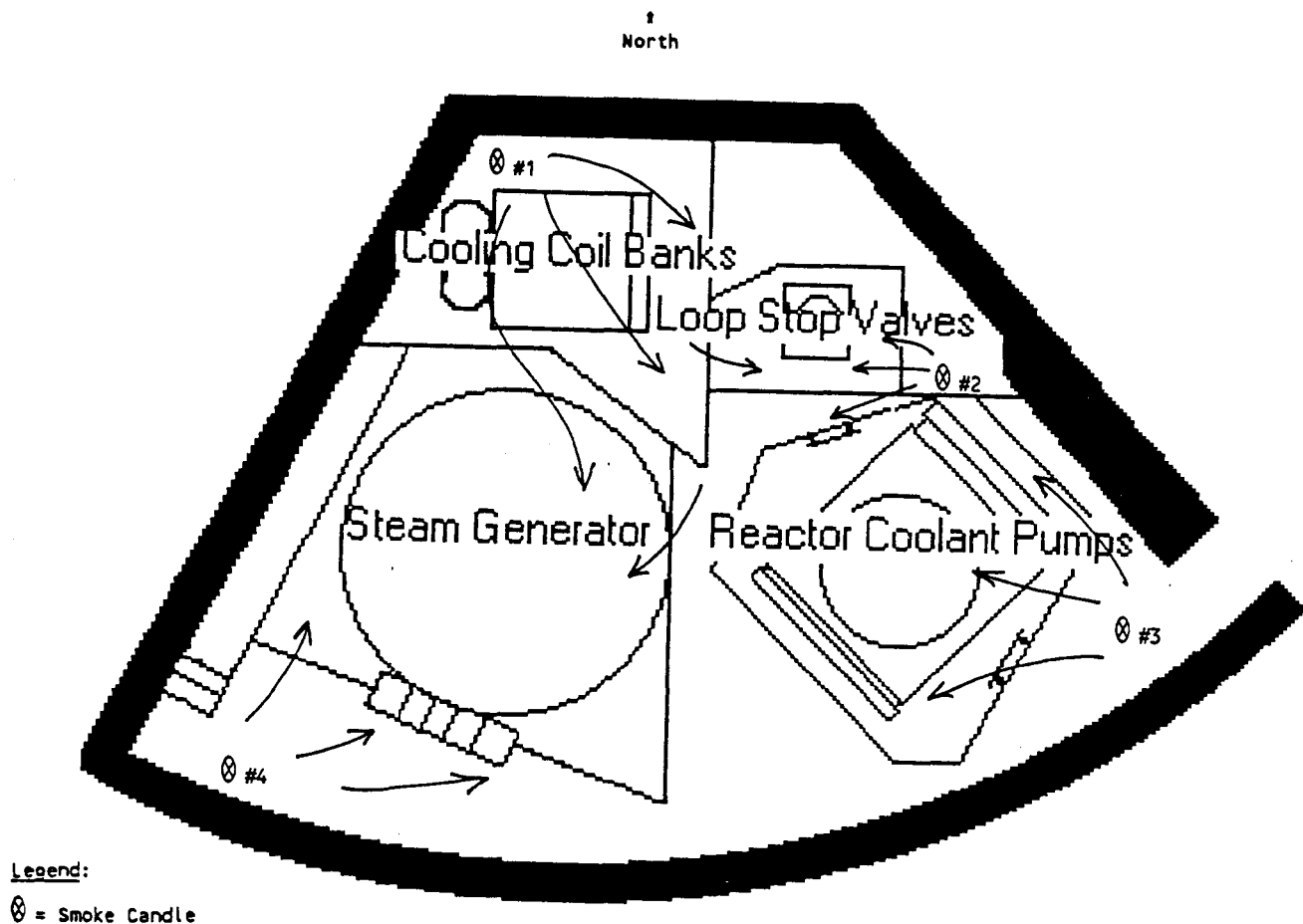

Figure 2.9. Airflow Patterns as Determined by Smoke Candles at Selected Locations

located at the worker's head level or about 1.7 m (5.5 ft) above the floor to simulate the worker's breathing zone.

- The aerosol is generated during the first 15 minutes of each run. The portable air samplers are started with the aerosol generator and continue to operate for an additional 15 minutes after the aerosol generator is stopped. Six runs are completed for each test, based on the study completed by Scripsick et al. (1978). Sufficient time is allowed between runs for the aerosol to dissipate to several orders of magnitude below test concentrations.
- Sample filters are placed in bottles containing a 0.01 N NH_4OH solution and analyzed using a fluorometer.

The health physicist averages the concentrations for the six runs for each sampler and then calculates the quantitative dispersion factor (D) by dividing the average air concentration for each sampler by the average concentration for the sampler located above the aerosol generator. The D values are shown in Figures 2.10 and 2.11 for the example work area.

Based on the results of the tracer test, the health physicist concludes that the quantitative dispersion factors in the loadout port area (Figure 2.10) are greater than 0.7, which Regulatory Guide 8.25 (NRC 1992) defines as a representative sample. The health physicist recommends the following locations for samplers:

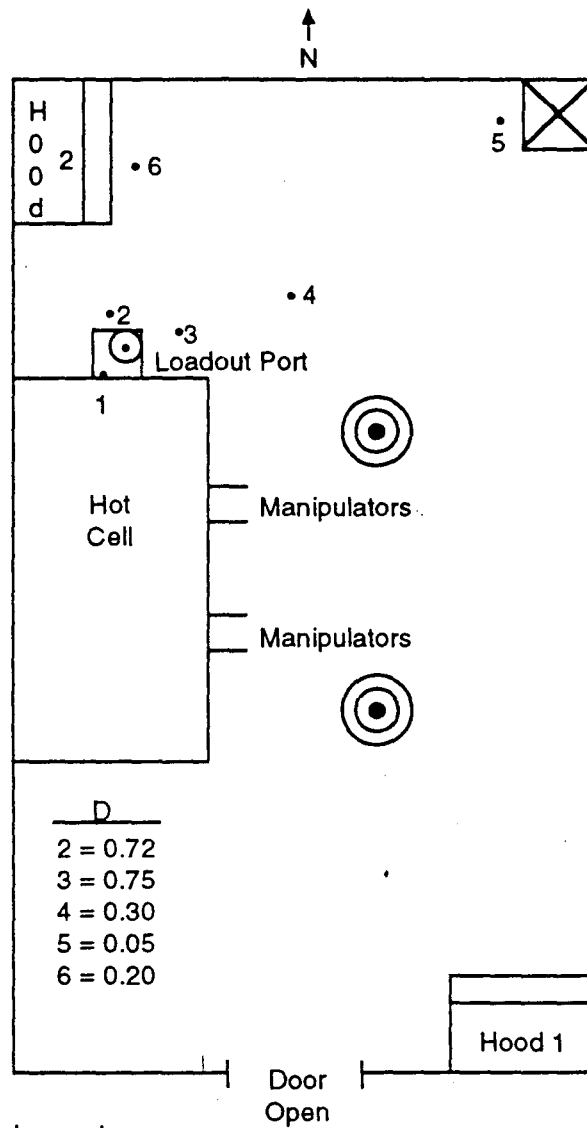

Legend

- ⊙ Ceiling Supply Air Vent
- ⊠ Wall Exhaust
- Fixed Air Sampler Location
- ⊙ Aerosol Generator and Air Sampler

R9010060.2

Figure 2.10. Example Work Area, Test 1 (Loadout Port)

Location of Air Samplers

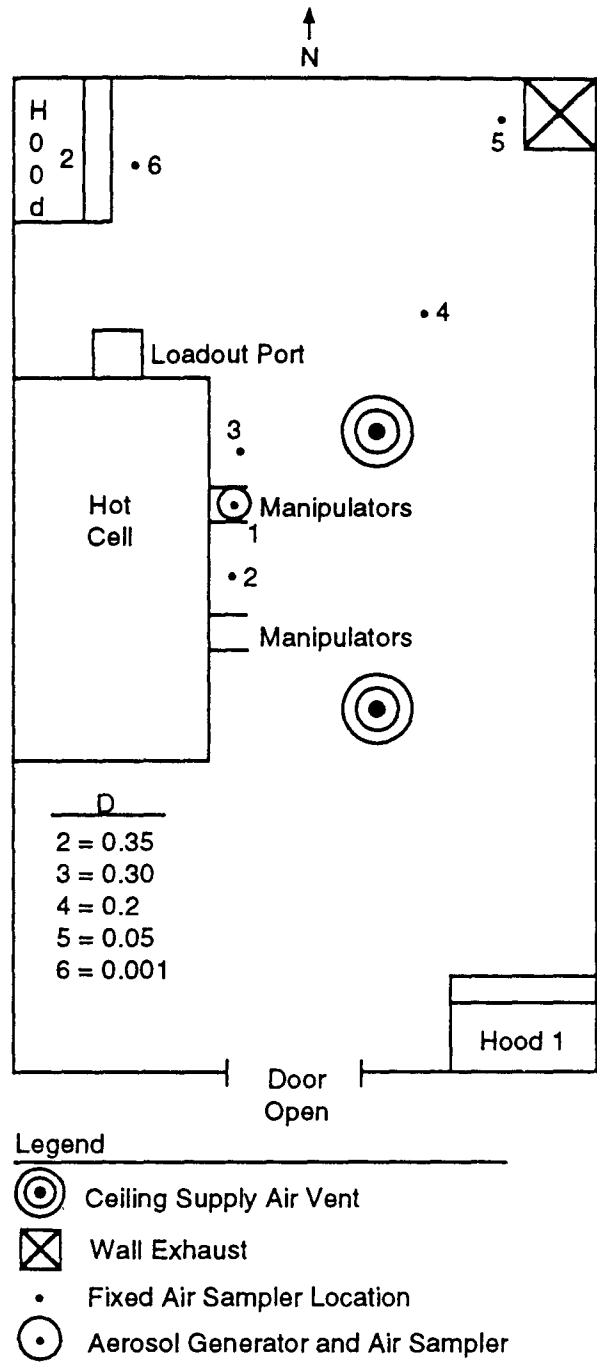

R9010060.3

Figure 2.11. Example Work Area, Test 2 (Manipulator Area)

- **Sampler 1** — A fixed air sampler should be positioned within 0.6 m (2 ft) north or east of the loadout port to be representative of the worker's breathing zone.
- **Sampler 2** — Hood 2 would be a better place to locate a fixed-location air sampler than the northeast exhaust vent because the D value for Sampler 6 in front of Hood 2 is four times greater than the D value for the northeast corner exhaust.

Based on the test results in the manipulator area, the health physicist concludes that the influence of the supply air resulted in a greater dilution within several feet of the release points (as shown in Figure 2.11), producing dispersion factors of approximately 0.3. The effect of the supply air mixing was to decrease the concentration gradient in the local area around the release point. The D values at the exhaust were low, indicating that a fixed-location air sampler at the exhaust vent may not be appropriate. Thus the health physicist recommends that the samplers would be better positioned closer to a potential release point (i.e., a loadout port or manipulators).

2.3 Selecting Sampler Location

The steps taken to determine air sampler locations include identifying the purpose of the sample, identifying release points, and determining airflow patterns around these release points, as discussed in Sections 2.1 and 2.2. This section provides information on using the sample purpose, the release points, and airflow patterns along with other modifying factors (e.g., worker movements and influence of supply air ventilation) to determine air sampler locations.

2.3.1 Factors in Locating Samplers

When workers' locations within the workplace during various processing operations are defined in enough detail, a health physicist can ensure that air sampler placement does not interfere with the normal conduct of work. For example, if a potential release point is a hood or glovebox, the air sampler can be placed where it cannot be bumped by a worker. Fixed-location air samplers on hoods are typically placed at a height of 1.8 m (6 ft) or less from the floor on the front face of the hood. The ideal sampler height is 1.5 to 1.8 m (5 to 6 ft) from the floor to the sampler; however, in corridors and busy

work areas, samplers may be placed overhead, preferably not higher than 2.4 m (8 ft), or at the sides of the areas.

Air samplers are generally placed so as to avoid the influence of supply airflow. An air sampler placed in the supply airflow will be sampling air that is representative of the supply instead of the ambient workplace air. This could result in the underestimation of ambient workplace air concentrations. If an air sampler is in the supply airflow just downwind of a potential or actual release point, then information on the airflow patterns in the area is used to reposition the sampler out of the supply air and in position to sample material from the potential release point. If the ventilation system is operated in the recirculation mode, sampling the supply air may be warranted because the supply air now becomes a potential airborne release point in the work area. Some other rules-of-thumb for locating samplers include the following:

- Samplers are placed so that they are easily accessible for changing filters and servicing.
- High-volume samplers are positioned so that their exhaust is directed downstream from the sample collector to avoid sampling their own clean exhaust air.
- If a sampler is operated on a horizontal surface, as a convenient means of support, the air discharged from the sampler is not directed at the surface, where it could cause localized excessive air concentration from resuspended surface contamination.
- When sampling at an exhaust duct with an area of more than 0.09 m² (1 ft²), the health physicist evaluates the need for a multi-nozzle sample inlet. If there is good mixing of the air before the exhaust, the use of one sample inlet may be justified. If the air is not well mixed, it is recommended in American National Standards Institute Standard N13.1 that the multi-nozzle sample inlet be used (ANSI 1969).

2.3.2 Examples of Determining Sample Locations

Several examples of how to determine air sampler locations are presented below, based on the purpose of the measurement identified in Section 2.1. Examples are

Location of Air Samplers

provided for locating air samplers to 1) verify confinement of radioactive materials, 2) estimate worker intakes, and 3) provide early warning of elevated concentrations. The examples are based on real data that were adjusted for the purpose of the examples.

2.3.2.1 Effective Confinement of Radioactive Material

The two examples presented in this section involve work areas with multiple release points in a new facility that is not yet operational and in an existing operational facility. Determining sample locations is not an exact science, and qualified health physicists' interpretations of the following examples may vary.

Example 1—Sampler Locations for a New Facility

Figure 2.12 depicts a work area in a new facility that is not yet operational. The hot cell loadout port and the hood are the two potential release points. Supply air enters the room through perforated ceiling panels from diffusers, located above the panels, that distribute the supply air evenly over the surface area of the ceiling. A qualitative airflow study shows that the general airflow is to the west, with air exiting through either the hood or the exhaust vent in the southwest corner.

Air concentrations in the work area are estimated to be about 10% of the DAC during work operations that would result in about 4-DAC-h/wk exposure to the workers. Therefore, continuous air sampling is recommended, based on Table 1 of Regulatory Guide 8.25 (NRC 1992).

An appropriate place for a continuous air sampler is on the front face of the hood (see Figure 2.12), preferably at a height less than 1.8 m (6 ft) from the floor. The sampler is best placed so as not to hinder the movement of the worker using the hood. The sampler at the loadout port should be located just downwind of the release point, as shown on Figure 2.12. Again, the sampler is located less than 1.8 m (6 ft) from the floor, but not hindering worker activities at the loadout port.

If the airflow pattern study had shown that most of the air flowing from the loadout port was exhausted through the hood, one sampler placed at the hood might cover the entire work area. However, to be sure that releases would not be so diluted as to escape detection, a quantitative airflow study of potential releases from the

loadout port would have to be done to justify placement of a single sampler.

Example 2—Sampler Locations for an Existing Operational Facility

An existing operational facility contains a sample preparation room in an existing analytical laboratory (see Figure 2.13). The five hoods in the work area are the potential release points. High-activity process samples are prepared in Hoods 4 and 5, while lower-activity process samples are handled in Hoods 1, 2, and 3. Supply air enters the room through the doors to Corridor A and the perforated ceiling panels from diffusers located above the panels. This results in an even distribution of supply air over the surface area of the ceiling. Smoke testing shows that the general airflow is to the east, with air exhausting through the hoods or into Corridor B.

Routine sample results for the continuous air sampler located between Hoods 4 and 5 average about 5% of the DAC. Based on these results and the guidance in Regulatory Guide 8.25, the health physicist recommends that the continuous air sampling near the two hoods be continued. However, the location of the sampler needs to be reevaluated based on the airflow patterns in the room. A release from Hood 4 would travel to the east and might escape detection by the sampler in its current location. Because each hood has the same potential for a release, the health physicist considers relocating the sampler to the east side of Hood 4 (see Figure 2.13) to allow sampling of a potential release from either hood.

Air sampler results for the sampler located between Hoods 1 and 2 average less than 1% of the DAC. According to guidance in Regulatory Guide 8.25, no air sampling is needed. However, based on the location of the air sampler and the airflow patterns, the health physicist cannot be certain that a release from Hood 1 would not exceed 1% of the DAC near the hood and be diluted to less than 1% of the DAC by the time it reached the current sampler. Also, the sampler is located upstream of any releases from Hoods 2 or 3. To properly evaluate this situation, the health physicist could either 1) conduct temporary air sampling at Hoods 1, 2, and 3 for several weeks to verify actual concentrations near the hoods (i.e., worker location), or 2) calculate potential releases for each hood to determine if air sampling is needed.

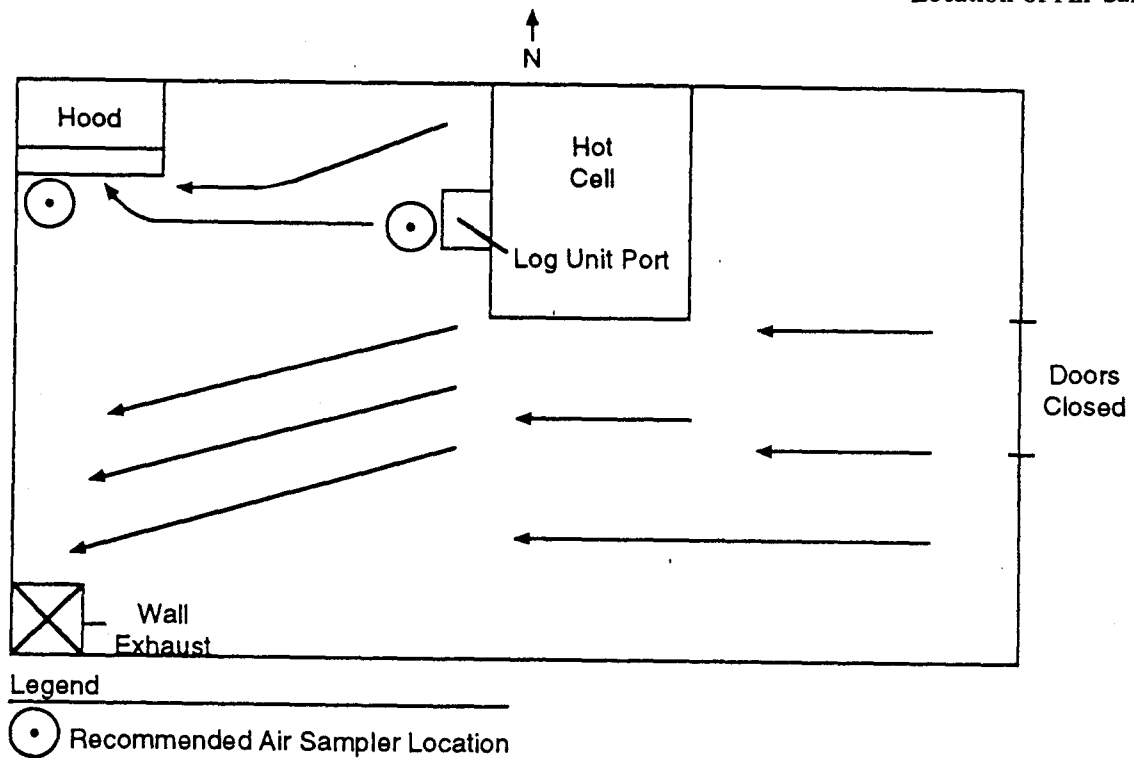

Figure 2.12. Example Work Area, Multiple Release Points in a New Facility

2.3.2.2 Estimation of Worker Intakes

Air samplers that collect samples for estimating worker intake intercept radioactive material before it reaches or soon after it passes the individual worker. Fixed-location air samplers can be used to collect representative samples of the air that workers inhale if they are strategically placed in the work area (see Section 3). Two examples are presented below illustrating how to locate fixed-location air samplers to obtain sample results that can be used to estimate worker intake. One example discusses sampling in a new (not-yet-operational) facility and the other covers sampling in an existing operational facility.

Example 1—Locating Fixed-Location Samplers in a New Facility

Fixed-location air samplers are to be placed in a new facility, depicted in Figure 2.12 (above). Workers will be located at 1) the hot cell loadout port and 2) in front of the hood. Smoke testing showed that the general airflow is to the west, with air venting through either the

hood or the exhaust vent in the southwest corner. A worker exposure greater than 12 DAC-h was estimated for work near the hot cell loadout port. Therefore, according to Table 1 of Regulatory Guide 8.25, the sample collected should be representative of the air inhaled by the worker. Placing the fixed-location air sampler just downwind of the loadout port will serve to monitor the integrity of the confinement. However, because it is not possible to position the sample within 30 cm (1 ft) of the worker's mouth and nose, an evaluation needs to be performed to determine if the sample is representative. Results from this single sampler could serve both as the basis for estimating worker intake and for monitoring the integrity of confinement control.

Example 2—Locating Fixed-Location Samplers in an Existing Operational Facility

Fixed head air samplers are to be installed in the existing facility shown in Figure 2.13. The work area is a sample preparation room in an analytical laboratory. The five hoods in the work area are the potential release points. Smoke testing revealed that the general airflow

Location of Air Samplers

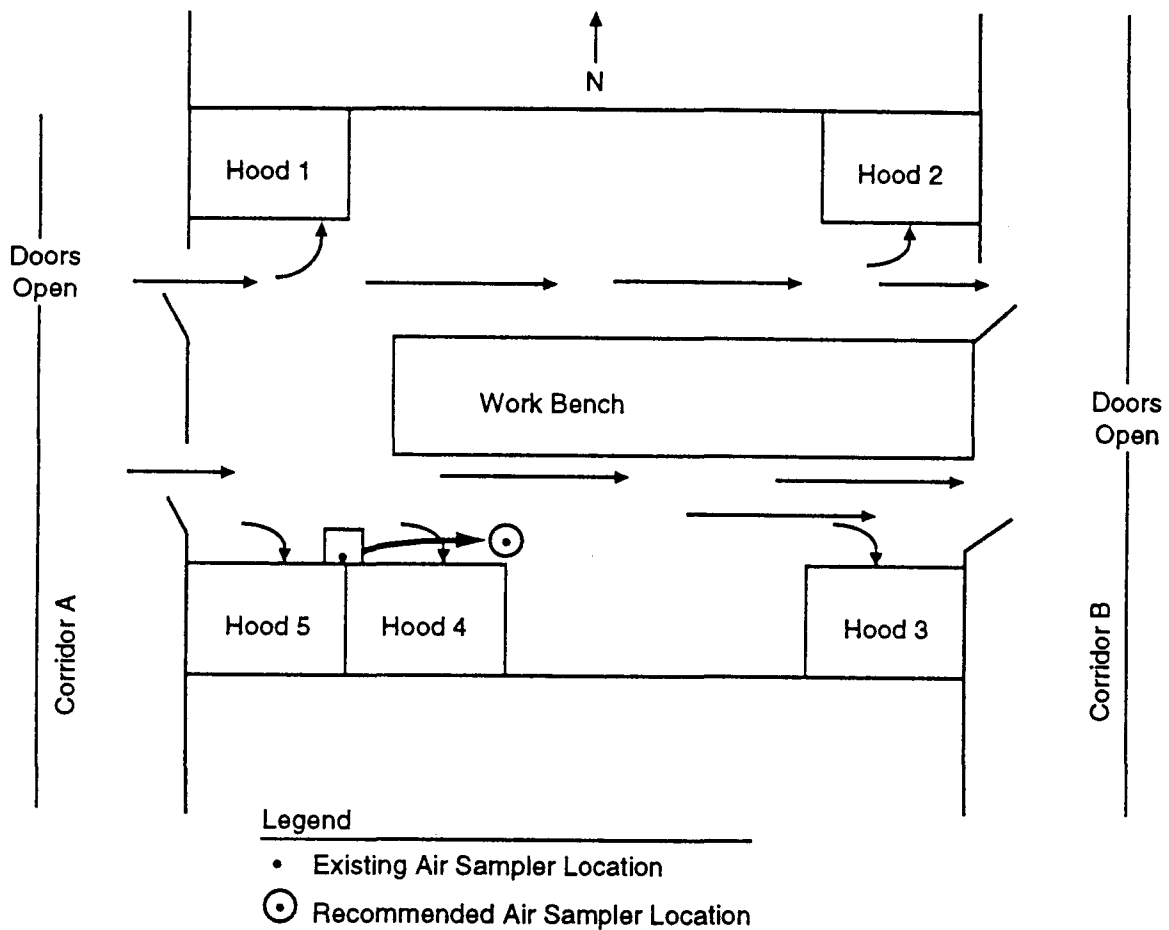

Figure 2.13. Analytical Laboratory Work Area

is to the east, with air venting either through the hoods or into Corridor B.

Air sampler results for the past year show that sample results for the continuous air sampler located between Hoods 4 and 5 were greater than 30% of the DAC. Therefore, air sampling is required for Hoods 4 and 5 and the location of the air sampler needs to be evaluated to determine if it is representative of what the worker inhales, as found in Table 1 of Regulatory Guide 8.25. Because the air sample results will be used to determine worker intake, air samplers are located on the front faces of Hoods 4 and 5, positioned to avoid being bumped by workers.

2.3.2.3 Early Warning of Elevated Air Concentrations

Regulatory Guide 8.25 states that early warning samplers should be located close to release points, preferably between workers and release points, and should be capable of detecting a release. For work areas with a *single* release point and where workers may exceed 40 DAC-h in 1 week, placing the air sampler immediately downwind from the release point provides the best indication of elevated airborne concentrations. Placement at an exhaust is also appropriate if dilution effects would still allow detection of a release in a reasonable amount of time; such a determination can be made with quantitative methods of analyzing airflow

(see Section 2.2.2.2). For an area with *multiple* release points and where workers may exceed 40 DAC-h in 1 week, two alternatives are possible. First, samplers can be placed downwind of each release point. Second, a sampler can be placed at each room exhaust vent, when a quantitative evaluation shows that dilution effects between the sampler and the exhaust vent will still allow prompt detection of the release. If there are multiple exhaust vents, air samplers located at all the vents that would receive airflow from any release points would provide coverage for all possible releases. Thus, the health physicist can analyze airflow data to determine which exhaust vents receive most of the releases.

As in locating samplers for evaluating confinement control and worker intake estimates, early warning sampler locations are determined differently for new and for existing facilities. For new (or proposed) facilities, an estimate of workplace air concentrations is used as a basis for determining the need for early warning samplers because there are no measurement data from which to draw information. At existing facilities, however, use data from past air sample results to determine the need for early warning sampling.

An example of the situation a health physicist faces when locating early warning samplers in a new facility that has multiple release points is described here. Figure 2.13 shows the work area. The hot cell loadout port, the glovebox, and the hood are the three potential release points. Observation and diagrams of the facility reveal that the supply air enters the room through perforated ceiling panels from diffusers located above the panels. It appears that there is an even distribution of supply air over the surface area of the ceiling. The room air is vented through the hood and the wall exhaust vent located in the southwest corner of the room. Smoke tests show that the general airflow is to the west, with air venting through either the hood or the southwest-corner exhaust vent.

The health physicist obtains data on source terms and then estimates weekly worker exposures in DAC-h for the hood, the glovebox, and the hot cell loadout port, with the results of 5, 15, and 50 DAC-h, respectively. Based on this information and Table 1 of Regulatory Guide 8.25, the following conclusions can be drawn:

- Continuous fixed-location air sampling should be performed at the hood and the glovebox. In addition, the air sampling at the glovebox needs to be evaluated to determine if it is representative of air inhaled by the worker.
- Early warning sampling should be performed at the loadout port. Samples should be evaluated at the end of each shift or a continuous air monitor should be used.

Because airflow in the room (specifically from the hot cell) is towards the hood, a fixed-location air sampler is placed on the front face of the hood, at a height slightly less than 1.8 m (6 ft) from the floor, making sure that the sampler does not interfere with the movements of the worker using the hood.

A fixed-location air sampler is also placed 1.8 m (6 ft) from the floor, on the center of the glovebox's north face, where the worker will be located. Once the facility is operating, one of the methods in Section C.3 of Regulatory Guide 8.25 will be used to demonstrate that the samples are representative.

Finally, the hot cell loadout port warrants placing a continuous air monitor downwind of the loadout port. A fixed-location air sampler is also placed near the loadout port to determine the representativeness of the sample, using one of the methods in Section C.3 of Regulatory Guide 8.25 once the facility is operating.

2.4 References

- American National Standards Institute (ANSI). 1969. *Guide to Sampling Airborne Radioactive Materials in Nuclear Facilities*. ANSI N13.1, New York.
- Brunskill, R. T., and F. B. Holt. 1967. "Aerosol Studies on Plutonium and Uranium Plants at the Windscale and Springfield Works of the United Kingdom Energy Authority." SM-95/30, In *Proceedings of a Symposium on Instruments and Techniques for the Assessment of Airborne Radioactivity in Nuclear Operations*, July 3-7, 1967, International Atomic Energy Agency, Vienna.

Location of Air Samplers

Contreras, Y. R., and G. A. Schlapper. 1985. "Aerosol Dilution and Dispersion in a Nuclear Research Facility." *Radiation Protection Management* 2(4):41-50.

Langer, L. 1987. *Ventilation Air Change Rate Versus Particulate Contaminant Speed*. RFP-4154, Rockwell International, Golden, Colorado.

Mishima, J., J. Hunt, W. D. Kittinger, G. Langer, D. Ratchford, P. D. Ritter, D. Rowan, and R. G. Stafford. 1988. *Health Physics Manual of Good Practices for the Prompt Detection of Airborne Plutonium in the Workplace*. PNL-6612, Pacific Northwest Laboratory, Richland, Washington.

Schulte, H. F. 1967. "Personal Air Sampling and Multiple Stage Sampling: Interpretation of Results from Personal and Static Air Sampler." CONF-670621-3, in Proceeding of ENEA Symposium on Radiation Dose Measurements, June 12-16, 1967.

Scripsick, R. C., R. G. Stafford, R. J. Beckman, M. I. Tillery, and P. O. Romero. 1978. Evaluation of a Radioactive Aerosol Surveillance System. IAEA-SM-229/62, In Proceedings of an International Symposium on Advances In Radiation Protection Monitoring, June 26-30, 1978, International Atomic Energy Agency, Vienna.

U.S. Nuclear Regulatory Commission. 1992. "Air Sampling in the Workplace." Regulatory Guide 8.25, Washington, D.C.

3 Demonstration that Air Sampling Is Representative of Inhaled Air

When air sampling results are being used to determine intake, correct interpretation of the air sampling data is important, and includes the knowledge of the physical and chemical properties and particle size of the contaminant, the extent to which samples represent the air inhaled by the workers, the time the workers are in the work area are other details.

3.1 Need to Demonstrate that Air Sampling Is Representative of Breathing Zone Air

Many factors can contribute to samples taken using area air samplers not being representative of the breathing zone of workers. For instance, even if air samplers are located in what appears to be the airflow pattern from the release point to the worker, airflow may be disturbed by worker movement and equipment operation. Air sampling rate and particle size are also factors that affect the representativeness of the sample. For these and other reasons, air samples may not be truly representative of the air breathed by the worker.

Regulatory Guide 8.25 (NRC 1992) states that if the decision is made to monitor a worker because the worker will exceed 10% of an ALI and the dose of record will be based on air sampling, then the air sample should be representative of the air breathed by the worker. Further, if the sample is taken with a lapel sampler, then it is considered to be representative of the air breathed by the worker. If the air sampler is either fixed, portable or a continuous monitor, the sampler must be shown to be in the breathing zone of the worker (approximately 30 cm [1 ft] from the head) or the air sample location must be shown to be representative of the breathing zone. If air samples are not taken within about 30 cm (1 ft) of the worker's head, Regulatory Guide 8.25 suggests the use of one of four methods to demonstrate that samples are representative. The Guide also provides a mechanism for correcting sampling results that are not within its suggested acceptance criteria. Four methods are used, as follows: comparison of area

air sample results with 1) lapel sampler results, 2) bioassay results, 3) multiple measurements taken near the breathing zone, and 4) quantitative airflow tests (discussed in Section 2.2.4).

3.2 Comparison of Fixed-Location Air Sample Results with Lapel Sample Results

Comparing fixed-location air sampler results with those of lapel samplers is useful when airborne radioactivity levels are routinely above the detection limit. This method of comparison, as described in Regulatory Guide 8.25, is appropriate for workers whose intake is likely to exceed 10% of an ALI and whose dose of record will be based primarily on air sampling. If airborne levels are at or near the lower limit of detection for the lapel sampler, this comparison will be difficult because the lapel samplers may not detect radioactive air concentrations that the fixed-location samplers can detect for the same sampling time.

Fuel fabrication facilities have used this method of comparison to determine whether their fixed-location samplers are representative of the air breathed by the workers. The studies are usually conducted on all shifts for comparison purposes and there is often a significant difference between the comparison ratio on day shift, when most of the work is performed and the swing and midnight shifts. Results from the studies are used to determine whether lapel sampling is desirable (if the criteria for sample representativeness are not met) or whether other corrective actions are appropriate. These corrective actions could include better contamination control, repair of equipment for better confinement control, and modification of ventilation systems.

Lapel sampler and fixed-location air sampler comparisons were taken from information from actual fuel fabrication facilities and are presented in the following paragraphs. Although the data in the example provided are taken from real situations, they have been adjusted

Inhaled Air

to adequately describe specific circumstances and information considered crucial to understanding air sampling practices.

The example scenario is as follows. Staff at a fuel fabrication facility want to perform a comparison study, as described in Regulatory Guide 8.25, to determine if the air sampled by fixed-location air samplers used for breathing zone sampling is representative of the air breathed by the workers. By company policy, they perform such studies annually. The facility staff evaluated each fixed-location air sampler location used to collect breathing zone samples. Each worker who may have an intake of 10% of an ALI or more is equipped with a lapel sampler, which is worn for at least one week or three operations. Sample results from the fixed-location air sampler and lapel samplers are each measured for equivalent time periods; that is, the filter on the fixed-location sampler is changed and counted at the same frequency as the lapel sampler, or adjustments are made.

The study compares lapel air sampler results with fixed air sample results for two areas in the facility that show greater than 10% of a DAC for the fixed air samplers. The first area is occupied by a single individual who spends most of his/her time at or near a hood (see Figure 3.1); two fixed-location air samplers are placed in this work area. The second area is larger, with seven fixed-location air samplers and six workers during a shift (see Figure 3.2). To perform the comparison studies, workers wear lapel samplers for 5 days during the time they are working in the specified area. The lengths of the sampling times are recorded. The fixed-location air samplers are run as usual for an 8-hour shift; they are then replaced and the samples are counted.

Table 3.1 shows the data collected for the small work area with one worker and two fixed-location air samplers. The health physicist averages the readings from the two fixed-location samplers and calculates the DAC-h based on the sample time of the lapel samplers. As described in Regulatory Guide 8.25, the ratio of the intakes is calculated by dividing the intakes calculated from the fixed-location air samplers by the intakes from the lapel samplers. To determine the DAC-h, the measured concentration, in $\mu\text{Ci}/\text{mL}$ is multiplied by the sample time and divided by the DAC for ^{234}U , class Y ($2 \times 10^{-11} \mu\text{Ci}/\text{mL}$). The ratios range from 0.2 to 0.5. According to Regulatory Guide 8.25, the ratio for an

individual worker should exceed 0.5 or corrective actions should be taken.

The health physicist determined the correction factor by taking the total DAC-h for the fixed-location air samplers and the lapel samplers, and determining the ratio. The correction factor that makes the fixed-location air sample data comparable to the lapel sampler data is 3.58. The correction factor is applied to all the intakes calculated previously for that area for the year. For further corrective actions, airflow pattern studies of the room were made and the locations of the fixed-location samplers were adjusted based on the studies.

The second area studied for comparison involved the six workers in the larger room with many work stations and seven fixed-location air samplers, which have been placed according to the results of an airflow pattern study. Table 3.2 shows the data collected for this work area.¹ The ratios for the daily intake calculations varied from 0.09 to 0.46. The correction factor calculated to adjust the ALIs of the workers is 4.75. This correction factor is applied to all intakes calculated for that area for the previous quarter. The health physicist decided that because three of the five daily ratios are so low (below 20% of the lapel sampler intake calculations) even though the samplers were located based on airflow studies, it would be preferable to put the workers in lapel samplers rather than trying to change the locations of the fixed-location air samplers.²

3.3 Comparison of Fixed-Location Air Samples with Bioassay Results

To meet the intent of Regulatory Guide 8.25 in demonstrating the representativeness of fixed-location air

¹Although the workers stay primarily at one assigned work location each day, the study was performed by averaging all the results from fixed-location air samplers and averaging the results from the lapel samplers.

²The health physicist also considered the possibility of performing quantitative airflow studies, but decided to wait until the next cycle of lapel/fixed-location sampler studies before making such a recommendation.

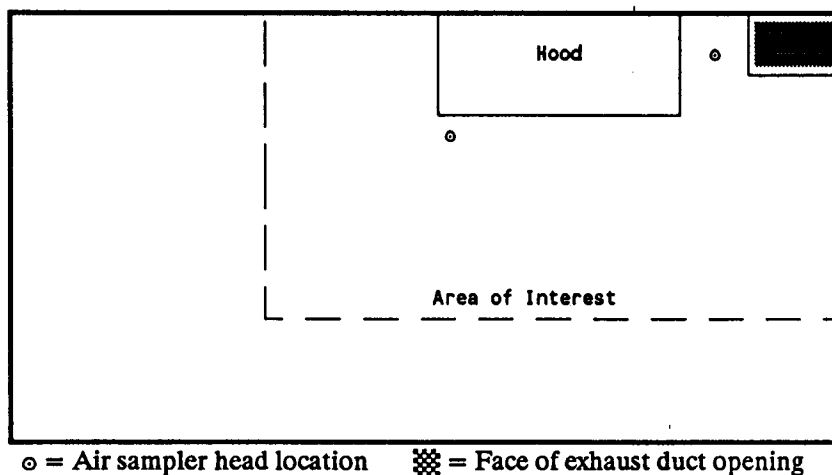

○ = Air sampler head location ▨ = Face of exhaust duct opening

Figure 3.1. Example Work Area Configuration for One Worker and Two Fixed-Location Samplers

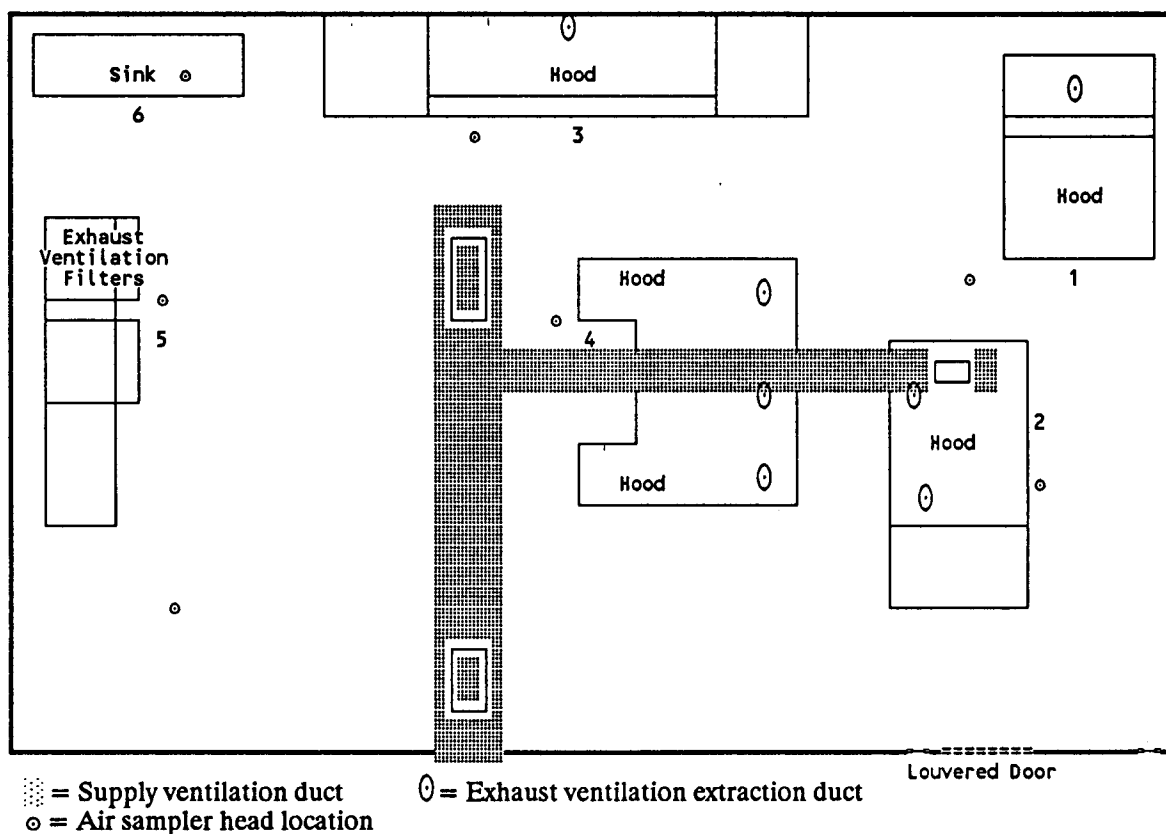

▨ = Supply ventilation duct ○ = Exhaust ventilation extraction duct
 ○ = Air sampler head location

Figure 3.2. Example Multi-Workstation Configuration for Six Workers and Seven Fixed-Location Air Samplers

Inhaled Air

Table 3.1. Comparison of Lapel Samplers and Fixed-Location Air Samplers, One Worker with Two Fixed-Location Air Samplers

Day	Lapel Sampler			Fixed-Location Air Samplers			Ratio ^(b)
	Concentration ($\mu\text{Ci} \times 10^{-12}$ mL)	Time Sampled (h)	Calculated Intake (DAC-h)	Concentration ^(a) ($\mu\text{Ci} \times 10^{-12}$ mL)	Sample Time/ Exposure Time	Calculated Intake (DAC-h)	
1	14.5	4	2.9	2.3	8/4	0.5	0.2
2	8.2	4	1.4	2.8	8/4	0.6	0.4
3	11.3	4	2.3	5.7	8/4	1.1	0.5
4	11.6	4	2.3	2.8	8/4	0.6	0.3
5	15.3	5	3.8	3.1	8/5	0.8	0.2
		Total	12.7		Total	3.6	

(a) Average of the two air samplers located near work station.

(b) Ratio of intakes (air sampler DAC-h/lapel sampler DAC-h).

Table 3.2. Comparison of Lapel Samplers and Fixed-Location Air Samplers, Six Workers with Seven Fixed-Location Air Samplers

Day	Lapel Sampler			Fixed-Location Air Samplers			Ratio ^(b)
	Concentration ($\mu\text{Ci} \times 10^{-12}$ mL)	Time Sampled (h)	Calculated Intake (DAC-h)	Concentration ^(a) ($\mu\text{Ci} \times 10^{-12}$ mL)	Sample Time/ Exposure Time	Calculated Intake (DAC-h)	
1	8.3	5	2.1	0.87	8/5	0.22	0.1
2	6.1	5	1.5	0.55	8/5	0.14	0.09
3	9.9	5	2.5	1.73	8/5	0.41	0.16
4	10.2	5	2.6	3.44	8/5	0.86	0.33
5	3.9	4	0.8	1.83	8/4	0.37	0.46
		Total	9.5		Total	2.0	

(a) Average concentrations for four workers.

(b) Average of seven air samplers located in work area.

(c) Ratio of intakes (air sampler DAC-h/lapel sampler DAC-h).

sampling, a comparison can be made of area air sampled by fixed-location air samplers with bioassay results of workers located in the area of the air sampler. This comparison method is probably the hardest to do and has the most limitations. For instance, if air sampling is used as the method of choice to determine intake because detection limits for bioassay are not sensitive enough to measure intakes close to 10% of an ALI, then comparison with bioassay results to determine representativeness is not appropriate. Other drawbacks include the need to keep the worker only in the location being studied or in areas with no potential intakes so that the bioassay result is only related to that of the air sampler being compared against. Finally, it is best for the study duration to be long enough to have a positive bioassay of the worker(s) of interest. Using routine air sampling data and bioassay data probably will not show a true correlation of the intake by the workers working at the air samplers of interest.

Although a less rigorous study may be adequate, if comparison of air samples with bioassay results is chosen the following method will provide the most accurate comparison. The method includes setting up and conducting the study, as well as applying appropriate correction factors, as needed.

Parameters for setting up the study are as follows:

- The air sampler filters are to be indicative of the time the worker(s) is at the work location. Installing a new filter when the worker starts work and changing the filter when the work is stopped will assure that the air sample data are for a time period comparable to the bioassay results. To provide continuous sampling of the work location, sampling can continue during normal operations, but the data from the samples taken when the worker is not present are not used in the study.
- All air samplers that represent a given work location are to be used in the study.
- One or more workers can participate in the study. If more than one worker is involved, the workers are to be in the area of study at the same time. Any time the workers are not in the area of study, they are to be located in an area with no for potential for an intake.

- Baseline bioassays are to be performed prior to the start of the study, and preferably the workers have no body burden.
- The study is to be conducted long enough so that the potential intake necessary to exceed the minimum detectable activity for the bioassay counting system is obtained.

The comparison study is conducted by completing the following steps in sequence:

1. Determine which fixed-location samplers are located in areas that have the potential for airborne radioactivity concentrations 10% of a DAC or higher.
2. Identify the workers who will be monitored under 10 CFR 20.1502 and whose dose of record will be based primarily on air sampling, but who are on a bioassay program with results routinely above the minimum detectable activity.
 - a. In addition, ensure that the workers are working in the area of the fixed-location air sampler of interest.
 - b. For best results, perform this study with several workers in the same work location.
 - c. Work is not performed wearing respirators.
3. Carefully track the air sampling data to ensure that the air samples are collected for the same time the workers are in the work location. (Sample work sheets are shown in Figures 3.3 and 3.4.)
4. Record the time that the worker is at the work location being studied, and when the worker is not in this area, limit him/her to areas where there is a no likelihood of intake.
5. Change the air sampler filter when the worker comes to the work location of interest and record the time of the filter change on the work sheet.
 - a. Replace the filter when the worker leaves the area and again record that time on the work sheet.
 - b. Record the reading of the filter on the data sheet.

COMPARISON STUDY OF AIR SAMPLING WITH BIOASSAY			
NAME: Andy Anderson		AREA: Baseline Bioassay: 0 DAC-h	
BLDG: 333	AREA: Lab	AIR SAMPLER NO(s): 222	
Date	Times Worked	Air Sample Filter Changed	Filter Reading (DAC-h)
03/01/92	7:30-noon	Yes	0.7
	1-4 pm	Yes	1.1
03/02/92	7:30-noon	Yes	0.3
03/03/92	7:30-noon	Yes	0.9
	2:30-4	Yes	0.4
03/04/92	7:30-noon	Yes	1.0
	1-4	Yes	0.2
03/05/92	1-4	Yes	1.0
			Total: 5.6
BIOASSAY: 13.3 DAC-h			
DATE: 03/06/92			
RATIO $\frac{5.6 \text{ DAC-h}}{13.3 \text{ DAC-h}} = 0.42$			

Figure 3.3. Sample Work Sheet (1) Showing the Results of a Comparison Study of Air Sampling with Bioassay

COMPARISON STUDY OF AIR SAMPLING WITH BIOASSAY			
NAME: James Jameson		AREA: Baseline Bioassay: 0 DAC-h	
BLDG: 333	AREA: Lab	AIR SAMPLER NO(s): 222	
Date	Times Worked	Air Sample Filter Changed	Filter Reading (DAC-h)
03/01/92	7:30-noon	Yes	0.7
	1-4 pm	Yes	1.1
03/02/92	7:30-noon	Yes	0.3
03/03/92	7:30-noon	Yes	0.9
	2:30-4	Yes	0.4
03/04/92	7:30-noon	Yes	1.0
	1-4	Yes	0.2
03/05/92	1-4	Yes	1.0
			Total: 5.6
BIOASSAY: 9.4 DAC-h			
DATE: 03/06/92			
RATIO $\frac{5.6 \text{ DAC-h}}{9.4 \text{ DAC-h}} = 0.6$			

Figure 3.4. Sample Work Sheet (2) Showing the Results of a Comparison Study of Air Sampling with Bioassay

Inhaled Air

- c. Convert the data so that the units are the same for both the air sample data and the bioassay data (see Figure 3.1).
6. Upon completion of the study, total the results of the air samples taken, obtain the bioassay results, and determine the ratio of the total air sampled to the bioassay results.

The following example describes the data from a comparison study made using bioassay data and a fixed-location air sampler. Figures 3.3 and 3.4 present data obtained from actual workers at a fuel fabrication facility, however modifications have been made to better illustrate the method for performing this comparison study. Both individuals for whom the study was performed had intakes higher than calculated for the fixed-location sampler being studied.

The study made on the air sampler did not meet the acceptance criteria of exceeding 0.7 when averaged for all the workers in the comparison. One worker met the 0.5 acceptance criteria, but the other did not. Based on Regulatory Guide 8.25, a correction factor should be applied to the workers. The average between the two ratios was about 0.5, so a correction factor of 2 should be applied to both workers intake estimates made within the last year. It may be appropriate to only apply the correction factor to the dose estimates made while the workers were at that location if the records are adequate to allow such a determination. The Regulatory Guide also suggests that the problem be corrected. Either the air sampler can be moved and the evaluation can be performed again, or the workers can be put in lapel samplers while working in that area, or the bioassay data can be used to estimate the intake of the workers.

3.4 Comparison of Air Sampler Results Using Multiple Samplers

This method for determining whether air samplers are sampling air that is representative of the breathing zone

air is probably the easiest and most reliable. The studies can be performed during normal operations, although there may be some inconvenience to the workers during the time. A multiple sample comparison can use portable air samplers located in the breathing zone or a simple apparatus can be devised connecting several fixed samplers that can be situated around a workers head and connected to a pump or house vacuum.

The results of a multiple sampler comparison are shown in Figure 3.5. In this example, four fixed-location samplers were used in one work area of a decontamination facility. The samplers were run 24 h/day and the filters were changed after each shift. A four-head test air sampler was placed as conveniently as possible around a worker in the decontamination facility during the day shift. The test samplers were run and the filters were changed after the swing shift and midnight shift even though the facility was not in use. The data show that the ratio of the fixed-location samplers to the averaged value of the multiple test air samplers was between 0.7 and 1.0. Therefore, the conclusion is that the four samplers, as placed in the decontamination facility, adequately demonstrate that the air sampled was representative of the air the worker breathes.

3.5 References

10 CFR 20. 1991. U.S. Nuclear Regulatory Commission, "Standards for Protection Against Radiation." U.S. Code of Federal Regulations.

U.S. Nuclear Regulatory Commission. 1992. "Air Sampling in the Workplace." Regulatory Guide 8.25, Washington, D.C.

COMPARISON WITH MULTIPLE SAMPLERS																		
LOCATION: Decon Facility																		
DATE: 10/05/92																		
Air Sampler Concentration in $\mu\text{Ci}/\text{ml} \times 10^{-11}$				Test Air Sampler Concentration in $\mu\text{Ci}/\text{ml} \times 10^{-11}$														
				MIDNIGHT					DAYS					SWING				
Sampler No.	Mid-night	Days	Swing	1	2	3	4	Avg.	1	2	3	4	Avg.	1	2	3	4	Avg.
111	0.3	15.3	0.2	0.3	0.2	0.4	0.3	0.3	18.0	17.2	21.2	16.0	18.2	0.4	0.2	0.3	0.1	0.3
112	0.2	2.4	0.3	0.2	0.2	0.4	0.3	0.3	3.1	2.8	3.2	4.0	3.3	0.3	0.4	0.2	0.2	0.3
113	0.2	22.9	0.3	0.3	0.4	0.2	0.2	0.3	29.0	31.0	24.0	27.0	27.8	0.2	0.2	0.3	0.4	0.3
114	0.3	16.5	0.3	0.3	0.2	0.4	0.2	0.3	20.0	19.0	18.7	17.9	18.9	0.2	0.4	0.2	0.3	0.3
RATIO																		
$\frac{\text{Sampler 111}}{\text{Midnight Avg.}} = \frac{0.3}{0.3} = 1.0$				$\frac{\text{Sampler 111}}{\text{Days Avg.}} = \frac{15.3}{18.3} = 0.84$					$\frac{\text{Sampler 111}}{\text{Swing Avg.}} = \frac{0.2}{0.3} = 1.0$					Average: 0.95				
$\frac{\text{Sampler 112}}{\text{Midnight Avg.}} = \frac{0.2}{0.3} = 0.7$				$\frac{\text{Sampler 112}}{\text{Days Avg.}} = \frac{2.4}{3.3} = 0.7$					$\frac{\text{Sampler 112}}{\text{Swing Avg.}} = \frac{0.3}{0.3} = 1.0$					Average: 0.8				
$\frac{\text{Sampler 113}}{\text{Midnight Avg.}} = \frac{0.2}{0.3} = 0.7$				$\frac{\text{Sampler 113}}{\text{Days Avg.}} = \frac{22.9}{27.8} = 0.8$					$\frac{\text{Sampler 113}}{\text{Swing Avg.}} = \frac{0.3}{0.3} = 1.0$					Average: 0.8				
$\frac{\text{Sampler 114}}{\text{Midnight Avg.}} = \frac{0.3}{0.3} = 1.0$				$\frac{\text{Sampler 114}}{\text{Days Avg.}} = \frac{16.5}{18.9} = 0.9$					$\frac{\text{Sampler 114}}{\text{Swing Avg.}} = \frac{0.3}{0.3} = 1.0$					Average: 0.95				

Figure 3.5. Sample Work Sheet (3) Showing the Results of a Comparison Using Multiple Samplers

4 Adjustments to Derived Air Concentrations

With the prior approval of NRC (based on 10 CFR 20.1204 [c]), the committed effective dose equivalent can be calculated by adjusting the DAC or ALI to better represent the physical and biochemical characteristics of the radionuclides taken into the body or their behavior in an individual. This section reviews considerations for adjusting DACs by particle sizing (e.g., aerosol size distribution or density), by measuring the respirable fraction of airborne particles (using size selective inlets like cyclone separators), and by identifying compound solubility.

4.1 Adjusting Derived Air Concentrations for Particle Size

The calculations of committed effective dose equivalent presented in Publication 30 of the International Commission on Radiological Protection (ICRP 1979) are based on a standard aerosol with 1- μm activity median aerodynamic diameter (AMAD). For an aerosol with an AMAD between 0.2 μm and 10 μm and a geometric standard deviation less than 4.5, an adjustment can be made to the 50-year committed dose equivalent, H_{50} .

Each radionuclide will have its own dose adjustment, due to the differing contribution to committed dose equivalent of radionuclides deposited in the three lung compartments: nasal passage (N-P), trachea and bronchial tree (T-B), and pulmonary parenchyma (P). The following equation expresses the adjustment to the committed dose equivalent in terms of the changed deposition in the different lung compartments:

$$\frac{H_{50}(AMAD)}{H_{50}(1 \mu m)} = f_{N-P} \frac{D_{N-P}(AMAD)}{D_{N-P}(1 \mu m)} + f_{T-B} \frac{D_{T-B}(AMAD)}{D_{T-B}(1 \mu m)} + f_P \frac{D_P(AMAD)}{D_P(1 \mu m)} \quad (4.1)$$

where f_{N-P} , f_{T-B} , and f_P are fractions of the committed dose equivalents in the reference tissues resulting from

deposition in the N-P, T-B, and P regions, and D_{N-P} , D_{T-B} , and D_P are the fractions of inhaled material initially deposited in the three compartments of the lung.

The values for f_{N-P} , f_{T-B} , and f_P are found in the Supplement to Part 1 of ICRP 30. These values are presented in the Supplement and are given as percentages of the committed dose equivalent. The numbers are in parentheses beneath the value of the committed dose equivalent and must be converted to decimal fractions before use.

Values for the ratios of deposition fractions (AMAD to 1 μm) are derived from the data in Part 1 of ICRP 30 (pages 24 and 25) and are presented in NUREG/CR-4884 (page B-801) as shown here in the Table 4.1. Figure 4.1 plots the data in Table 4.1 and allows the user to interpolate values other than those specifically given in the table.

Substitution of the fractions of committed dose equivalent and the ratios of deposition fraction into Equation (4.1), for a given AMAD, will provide a correction value for the H_{50} (the 50-year committed dose equivalent). Because the fractions of committed dose equivalent routinely differ for the various tissues, this correction value is likewise different for each tissue. This is important in the formulas for deriving stochastic ALI but not for deriving a nonstochastic ALIs. Regulatory Guide 8.34, *Monitoring Criteria and Methods to Calculate Occupational Radiation Doses*, discusses how to determine the appropriate ALI to use when adjusting DACs.

$$ALI(1 \mu m)_{stochastic} = \frac{0.05 \text{ Sv}}{\sum_T W_T H_{50,T} \text{ Sv/Bq}} \quad (4.2)$$

$$ALI(1 \mu m)_{nonstochastic} = \frac{0.5 \text{ Sv}}{H_{50,T} \text{ Sv/Bq}} \quad (4.3)$$

Table 4.1. Ratios for Deposition Fractions (AMAD to 1 μm)

Aerosol AMAD (μm)	$\frac{D_{N-P}(AMAD)}{D_{N-P}(1 \mu m)}$	$\frac{D_{T-B}(AMAD)}{D_{T-B}(1 \mu m)}$	$\frac{D_P(AMAD)}{D_P(1 \mu m)}$
0.2	0.17	1.00	2.00
0.5	0.53	1.00	1.40
0.7	0.77	1.00	1.20
1.0	1.00	1.00	1.00
2.0	1.67	1.00	0.68
5.0	2.47	1.00	0.36
7.0	2.70	1.00	0.28
10.0	2.90	1.00	0.20

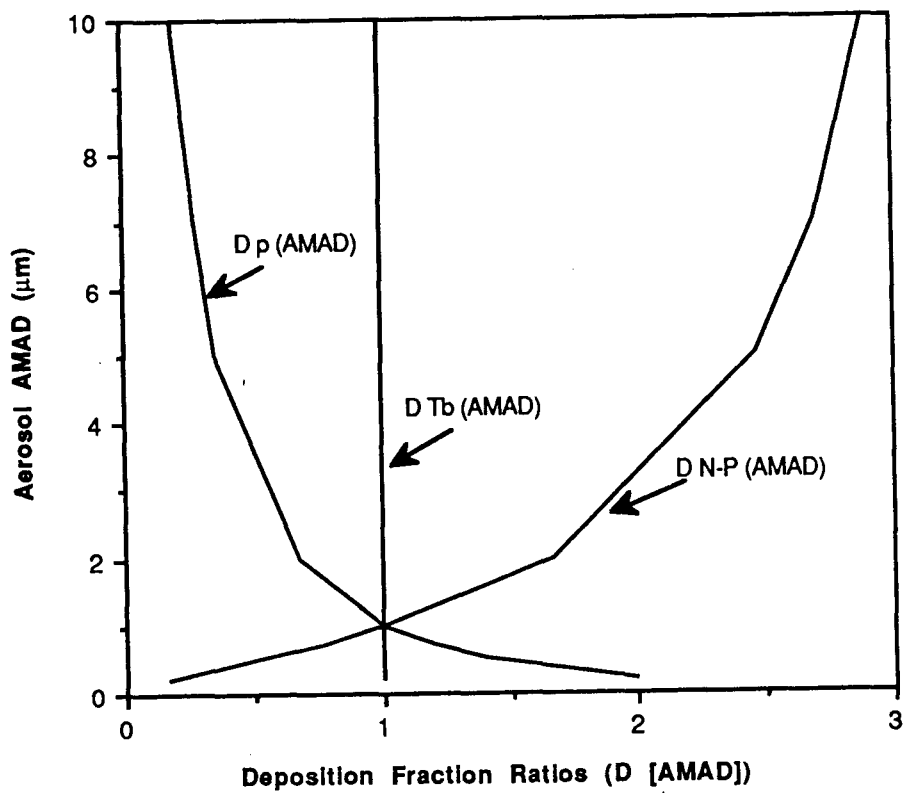

Figure 4.1. Values for Ratios of Deposition Fractions

where W_T is the weighting factor for tissue (T) and has the values from 10 CFR 20.1003. The $H_{50,T}$ per unit intake (in Sv/Bq) is the committed dose equivalent in tissue (T) from the uptake of unit activity of the radionuclide.

This task can become tedious, as seen in the following example using the percentages of $H_{50,T}$, weighting factors, and the $H_{50,T}$ (Sv/Bq) for class W cobalt-60 that are presented in Table 4.2.

The $\Sigma W_T H_{50}(1 \mu\text{m})$ value is inserted into Equation (4.2). The maximum value of $H_{50}(1 \mu\text{m})$ occurs for the lung in this example and is used in Equation (4.3).

$$\text{ALI}(1 \mu\text{m})_{\text{stochastic}} = \frac{0.05 \text{ Sv}}{7.97 \times 10^{-9} \text{ Sv/Bq}} \quad (4.4)$$

$$\text{ALI}(1 \mu\text{m})_{\text{stochastic}} = 6.27 \times 10^6 \text{ Bq} \quad (4.5)$$

$$\text{ALI}(1 \mu\text{m})_{\text{nonstochastic}} = \frac{0.5 \text{ Sv}}{3.6 \times 10^{-8} \text{ Sv/Bq}} \quad (4.6)$$

$$\text{ALI}(1 \mu\text{m})_{\text{nonstochastic}} = 1.39 \times 10^7 \text{ Bq} \quad (4.7)$$

The stochastic ALI used in this example is found on page 41, of ICRP 30, Supplement to Part 1 (ICRP 1979).

Changing the deposition percentages into fractions and inserting deposition fraction ratios from Table 4.1 into Equation (4.1) produces the value of $H_{50}(7 \mu\text{m})/H_{50}(1 \mu\text{m})$ for the various organs. To continue the example, Equation (4.1) is used, as shown in Equation 4.8, for an AMAD particle size of $7 \mu\text{m}$ and the results shown in Table 4.3.

$$\frac{H_{50}(7 \mu\text{m})}{H_{50}(1 \mu\text{m})} = f_{N-P} \quad (2.70) \quad (4.8)$$

$$+ f_{T-B}(1.00) + f_P(0.28)$$

The $\Sigma W_T H_{50}(7 \mu\text{m})$ value is inserted into Equation (4.2). The maximum value of $H_{50}(7 \mu\text{m})$ into Equation (4.3) to perform an evaluation of the maximum ALI allowed, as follows:

Table 4.2. Percentages of Committed Dose Equivalent, Factors, and $H_{50,T}$ (Sv/Bq) for Cobalt 60, Class W

Tissue	CDE			
	Percentage (f_{N-P}, f_{T-B}, f_P)	W_T	$H_{50,T} \times 10^{-9}$	$W_T H_{50,T} \times 10^{-9}$
Gonads	(35,21,44)	0.25	4.0	1.00
Breast	(19,17,64)	0.15	4.2	0.62
Red marrow	(20,17,63)	0.12	4.2	0.51
Lungs	(02,02,96)	0.12	36.0	4.32
LLI wall	(45,15,40)	0.06	8.2	0.49
Liver	(21,19,60)	0.06	9.2	0.55
Remainder	(10,09,81)	0.06	8.0	0.48
			$\Sigma W_T H_{50,T} =$	7.97

Table 4.3. Values of Deposition Fraction Ratios, Committed Dose Equivalents and Weighted Committed Dose Equivalents for Cobalt 60, Class W, and AMAD = 7 μm

Tissue	Ratio	H _{50,T} (1 μm) x 10 ⁻⁹	H _{50,T} (7 μm) x 10 ⁻⁹	W _T H _{50,T} (7 μm) x 10 ⁻⁹
Gonads	1.28	4.0	5.12	1.28
Breast	0.86	4.2	3.61	0.54
Red Marrow	0.89	4.2	3.74	0.45
Lungs	0.34	36.0	12.24	1.47
LLI wall	1.48	8.2	12.14	0.73
Liver	0.93	9.2	8.56	0.51
Remainder	0.59	8.0	4.72	0.28
			Σ W _T H _{50,T} =	5.26

$$ALI (7 \mu m)_{stochastic} = \frac{0.05 \text{ Sv}}{5.26 \times 10^{-9} \text{ Sv/Bq}} \quad (4.9)$$

$$ALI (7 \mu m)_{stochastic} = 9.51 \times 10^6 \text{ Bq} \quad (4.10)$$

$$ALI (7 \mu m)_{nonstochastic} = \frac{0.5 \text{ Sv}}{1.22 \times 10^{-8} \text{ Sv/Bq}} \quad (4.11)$$

$$ALI (7 \mu m)_{nonstochastic} = 4.10 \times 10^7 \text{ Bq} \quad (4.12)$$

To complete the example, a relationship between the DAC and the ALI is required,

$$DAC = [ALI / 2.4 \times 10^3] \text{ Bq/m}^3 \quad (4.13)$$

Therefore, with rounding, the DAC for the ALI (1 μm) of 6.0 x 10⁶ Bq for class W ⁶⁰Co, class W, is 3.0 x 10³ Bq/m³, while the DAC for the ALI (7 μm) of 1.0 x 10⁷ Bq is 4.0 x 10³ Bq/m³.

Not all calculations will be as straightforward as in the case of class W ⁶⁰Co. Computer programs are developed that compute adjusted DACs and ALIs for particle-sizing corrections. The computer program used to develop the Environmental Protection Agency's, Federal Guidance Report No. 11, *Limiting Values of Radionuclide Intake and Air Concentration and Dose Conversion Factors for Inhalation, Submersion and Ingestion* (EPA 1988), does

not employ rounding methods as suggested in ICRP 30 and effective dose equivalent factors may be slightly higher (by 10 to 20%). The described program gives slightly higher doses for the same intake described in 10 CFR Part 20.

There are examples of the ratio of the 50-year committed dose equivalents (Equation [4.1]) becoming simple ratios, such as for ²³⁵U, classes W and Y (Thind 1986). This is primarily true because of the reported deposition percentages of H_{50,T} are (0,0,100). Thus for class Y ²³⁵U, Equation 4.8 simplifies to

$$\frac{H_{50} (AMAD)}{H_{50} (1 \mu m)} = \frac{DAC (1 \mu m)}{DAC (AMAD)} \quad (4.14)$$

Table 4.4 and Figure 4.2 present the calculated data for class D, W, and Y ²³⁵U. The data presented clearly show that various multiples of a DAC are appropriate, depending upon the particle size and solubility class. The data indicate that for class Y ²³⁵U for an AMAD of 7 μm, the DAC may be increased by a multiple of 3.6.

According to ICRP 35 (1982), "If the AMAD of the aerosol is known to be markedly different from 1 μm, the retained fraction will differ from the standard aerosol and the need for correction factors should be considered." Particle-sizing devices, such as cascade impactors, are useful for measuring the AMAD of the

Table 4.4. Ratios of DAC (AMAD) to DAC (1 μm) for ^{235}U

Particle Size (μm)	Ratio of DAC (AMAD) to DAC (1 μm)		
	Class D	Class W	Class Y
0.2	0.81	0.5	0.5
0.5	0.94	0.71	0.71
0.7	0.98	0.83	0.83
1.0	1.00	1.00	1.00
2.0	0.96	1.5	1.5
5.0	0.86	2.8	2.8
7.0	0.84	3.6	3.6
10.0	0.82	5.0	5.0

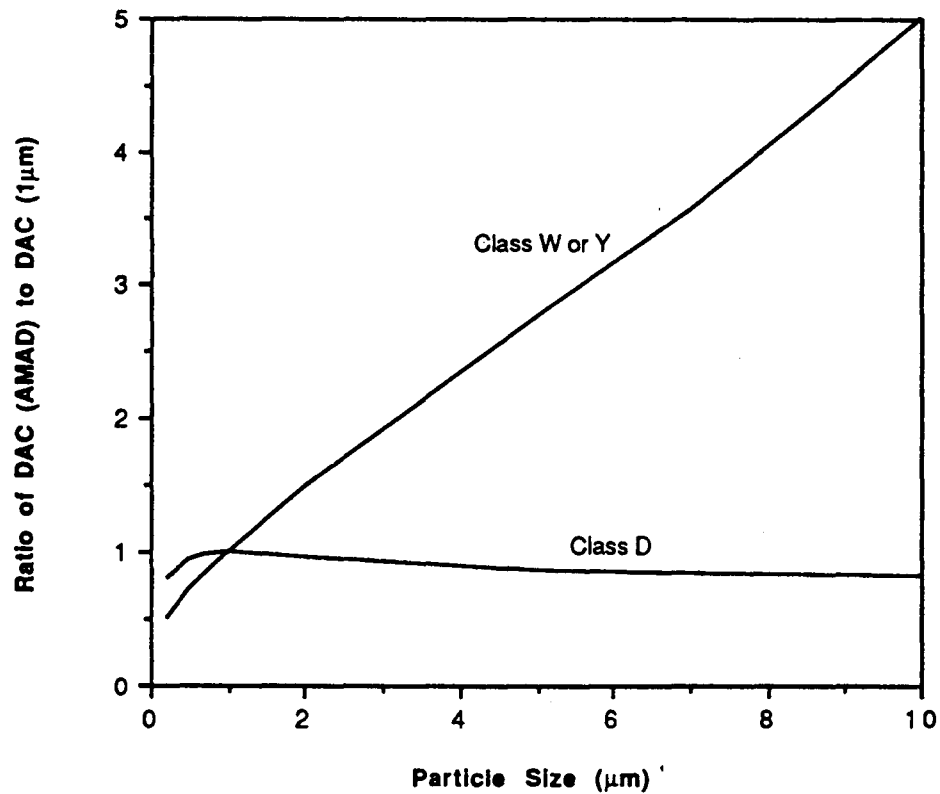
Figure 4.2. DAC Ratios for ^{235}U

sampled radioactive aerosol. Section 4 of Regulatory Guide 8.25 notes that particle size measurements and adjustments of DACs and ALIs are not required, but are permitted (with NRC approval as stated in 10 CFR 20.1204) for determining adjusted DACs and ALIs and subsequent change in effective dose equivalent. Particle size measurements may sometimes reduce the calculated dose equivalent due to internal radionuclide exposure, because particle size distributions found in the nuclear industry are often significantly greater than the default value of 1- μm AMAD, which is used in ICRP 30 (ICRP 1979).

4.2 Methods for Adjusting DACS

The DAC or ALI can be adjusted by determining particle sizes using measurements made with a cascade impactor or a cyclone separator or by determining the solubility classes of the materials and adjusting the DAC based on the fraction of material that is class D, W, or Y. Additional information on particle size sampling can be found in *Particle Size-Selective Sampling in the Workplace* (ACGIH 1985).

4.2.1 Use of a Cascade Impactor to Determine Particle Size

Particle size distributions can be determined using a cascade impactor or similar method. The cascade impactor separates particulate aerosols into many different size fractions for analysis of particle size distributions. Practical guidance on the operation of cascade impactors can be found in the monograph, *Cascade Impactor Sampling and Data Analysis* (Lodge and Chan 1986). (See Section 6.4 of this publication for plotting lognormal distributions of particle size measurements.) To determine whether the entire workplace can be represented by a single particle size, measurements of aerosols in each work area or process can be made. If the results of the particle-size determination indicate a geometric standard deviation of less than 4.5 for all measurements, one particle size can be assumed, and used in adjusting the DAC.

A geometric standard deviation of 4.5 or greater is likely to indicate a bimodal distribution of aerosols. Resolution of a composite distribution into two components that can be accounted for in ICRP 30 (ICRP 1979) methodology may require complicated procedures (Cheng 1986). Coarse particles are created by mechanical processes

such as cutting, abrasion, and mixing, while operations involving high-temperature processes such as heating, welding, and distillation produce particles smaller than 1 μm . It is possible that with several and different ongoing operations in a workplace, multiple size modes will be found.

4.2.2 Using Cyclones to Compensate for Particle Size

Cyclone separators can discriminate against large particles and thus are useful in directly measuring particulates that are respirable. Inspection of cyclone efficiency curves shows that a cyclone separator can be operated at a flow rate to collect a sample of an aerosol that mimics the deposition of particles in the pulmonary parenchyma (P region of the lung as modeled in the ICRP 30 lung model) (Bartley and Breuer 1982). According to Regulatory Guide 8.25, the use of a cyclone is acceptable for insoluble radionuclides as long as collection efficiency of the cyclone is at least 50% for a particle of 4 μm aerodynamic diameter.

Cyclone separators can only be used to estimate the intake of insoluble radionuclides (class W and class Y). For insoluble radionuclides material deposited in the P region of the lungs is the principal contributor to the dose because most material deposited in the N-P and T-B regions is cleared without much uptake. For soluble radionuclides (class D), there is significant uptake of material deposited in the N-P and T-B regions, and thus a significant contribution to dose from soluble materials deposited in those regions. Since larger particles are preferentially deposited in those regions, there is a significant contribution to dose from large particles that would not be collected by a cyclone sampler. Thus, cyclone samplers are not suitable for sampling soluble (class D) radionuclides.

4.3 Adjusting Derived Air Concentrations for Solubility

The DAC may be adjusted based on chemical characteristics of the radionuclide. The DACs for inhalation are given for three classes (D, W, and Y) of radioactive material, which refer to their retention (approximately days, weeks, or years) in the pulmonary region of the lung. This classification applies to a range of clearance half-times for class D material of less than 10 days, for class W from 10 to 100 days, and for class Y greater than

100 days. Generally, if the physical and biochemical properties of the radionuclides or the behavior of the material in the body are known and different from the ICRP assumptions, the DAC can be adjusted using that information. A variation in intake retention factors or discovery of a classification not listed for a radionuclide are examples of two situations that could lead to a DAC adjustment. Lessard et al. (1987) provide information to relate biological data to estimates of intakes. From this estimate of intakes and associated doses, a correction factor to the DAC may be made. The process for making DAC adjustments based on solubility involves sampling a workplace for the respirable fraction of the radionuclide in question. Samples are then subjected to dissolution in simulated lung fluid, which chemically represents the pulmonary environment. A detailed discussion of a method for performing a solubility study is provided by Briant and James (1990).

4.4 References

- 10 CFR 20. U.S. Nuclear Regulatory Commission. "Standards for Protection Against Radiation." U.S. Code of Federal Regulations.
- American Conference of Governmental Industrial Hygienists (ACGIH). 1985. *Particle Size-Selective Sampling in the Workplace*. ACGIH, Cincinnati, Ohio.
- Bartley, D. L., and G. M. Bruer. 1982. "Analysis and Optimization of the Performance of the 10 mm Cyebne." *American Industrial Hygiene Association Journal* 43:520-528.
- Briant, J. K., and A. C. James. 1990. *Dissolution and Particle Size Characterization of Radioactive Contaminants in Hanford Facilities: Criteria for Methods of Measurement*. PNL-7438, Pacific Northwest Laboratory, Richland, Washington.
- International Commission on Radiological Protection (ICRP). 1978. *Limits for Intakes of Radionuclides by Workers*. ICRP Publication 30, Part 1, and ICRP Publication 30, Supplement to Part 1, Pergamon Press, Oxford.
- International Commission on Radiological Protection (ICRP). 1982. *General Principles of Monitoring for Radiation Protection of Worker*. ICRP Publication 35, Pergamon Press, Oxford.
- Lessard, E. T. et al. 1987. *Interpretation of Bioassay Measurements*, NUREG/CR-4884, U.S. Nuclear Regulatory Commission, Washington, D.C.
- Lodge, J.P., and T. L. Chan, eds. 1986. *Cascade Impactor Sampling and Data Analysis*. American Industrial Hygiene Association (AIHA), Akron, Ohio.
- Thind, K. S. 1986. "Determination of Particle Size for Airborne UO₂ Dust at a Fuel Fabrication Work Station and Its Implication on the Derivation and Use of ICRP Publication 30 Derived Air Concentration Values." *Health Physics* 51(1):97-105.
- U.S. Environmental Protection Agency (EPA). 1988. *Limiting Values of Radionuclide Intake and Air Concentration and Dose Conversion Factors for Inhalation, Submersion and Ingestion*. Federal Guidance Report No. II, Cincinnati, Ohio.
- U.S. Nuclear Regulatory Commission (NRC). 1992. *Air Sampling In the Workplace*. Regulatory Guide 8.25, Rev. 1, Washington, D.C.
- U.S. Nuclear Regulatory Commission (NRC). 1992. *Monitoring Criteria and Methods to Calculate Occupational Radiation Doses*. Regulatory Guide 8.34, Washington, D.C.
- International Commission of Radiological Protection (ICRP). 1979. *Limits for Intakes of Radionuclides by Workers*. ICRP Publication 30, Pergamon Press, New York, NY.

5 Measurement of the Volume of Air Sampled

Determining the concentration of radioactive materials in the air involves accurate measurements of both the sample activity collected and the volume of air collected during the sampling interval. Regulatory Guide 8.25 (NRC 1992) recommends that an air-sampling program provide for an annual calibration of all flow-rate measurement instruments (airflow or volume meters). Regulatory Guide 8.25 also recommends that additional calibrations be performed after repairs or alterations are made or if the flow-rate measurement instrument is damaged.

5.1 Means to Determine Volume of Air Sampled

For most workplace air-sampling applications, the sample volume is measured with a flow-rate measurement instrument such as a rotameter or orifice meter. These instruments are relatively inexpensive, lightweight, compact, and useful over a wide range of flow rates. With proper handling and maintenance, they provide acceptable measurement accuracy.

The rotameter typically consists of a tapered transparent tube with a solid float inside (see Figure 5.1). The cross-sectional area of the tube increases from the bottom to the top. A scale in flow-rate units is marked on the outside surface. The airflow raises the float until the buoyant and kinetic forces of the air balance the gravitational force on the float. The height of the float varies in proportion to the volumetric flow rate. There are rotameter designs to measure flow rates from less than 1 cm²/min. to hundreds of cubic feet per minute. Float design will vary depending on the manufacturer and the flow rate. Readings are conventionally taken at the widest point of the float, but the user's manual for a particular instrument will specify the reading point.

The orifice meter consists of a carefully machined constriction in a tube between the upstream and downstream pressure taps (see Figure 5.2). The flow rate is calculated from the orifice diameter, the pressure upstream of the orifice, the ratio of the orifice

diameter to the tube diameter, and the upstream temperature. (Refer to Section F of the ACGIH's *Air-Sampling Instruments for Evaluation of Atmospheric Contaminants* [1989]) for a discussion of the equation used to calculate flow rate.)

In addition to rotameters and orifice meters, mass flow meters are commonly used as flow-rate measurement devices in continuous air monitors. A mass flow meter contains a heating element in a duct section between two points where the temperature of the air is measured. The temperature difference between the two points is dependent on the mass flow rate and the heat input. Pressure loss through the mass flow meter is usually negligible.

For more information on the design and operating characteristics of the rotameter, orifice meter, mass flow meter, and other types of flow-rate measurement instruments Section F (Calibration of Air-Sampling Instruments) in ACGIH (1989) can be consulted.

5.1.1 Flow Control for Portable Air Samplers

Constant flow for portable air samplers to avoid correction problems can be maintained as follows:

- flow control with a vacuum gauge at the pump calibrated to indicate the entering flow rate, regardless of the filter load
- manual adjustment of the flow with a rotameter located between the control valve and the pump; the rotameter can be calibrated to indicate the entering volumetric flow rate regardless of the filter load
- automatic flow control with a vacuum regulator in series with each sample collector to compensate for the filter load
- automatic flow control with a differential regulator in series with each sample collector to compensate for the filter load

Measuring Air Sampled

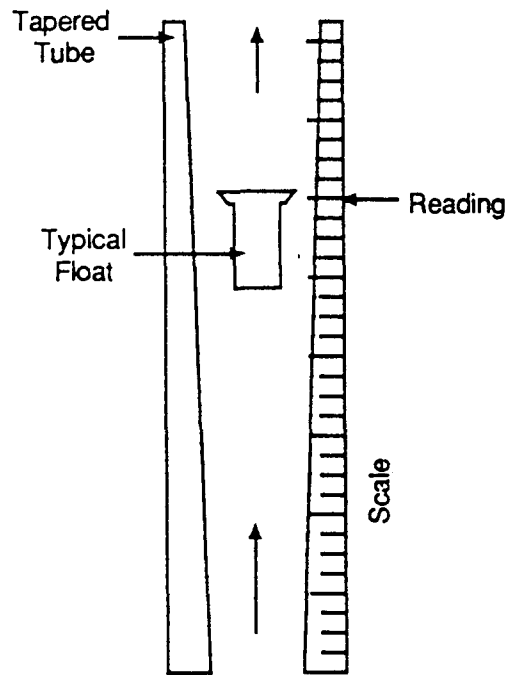

Figure 5.1. Rotameter

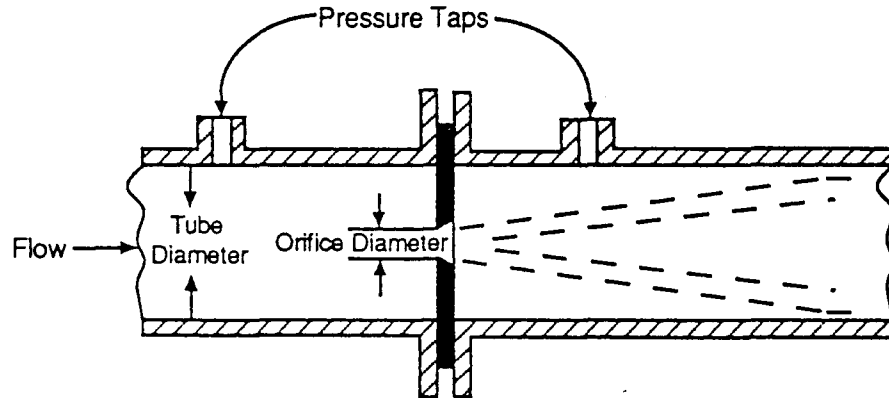

Figure 5.2. Orifice Meter

- automatic flow control with a thermal anemometer used to control the speed of the pump.

Contrary to popular belief, orifice flow control (in which the velocity in the orifice is at the speed of sound) cannot compensate for changing filter loads, and consequently is not recommended for use in air samplers that employ a filter as the sample collector.

5.1.2 Flow Control for Air Samplers Connected to Central Vacuum Systems

Flow control for air samplers connected to central vacuum systems is simplified greatly if the system is used only for air-sampling, and if the pump and piping are operated at a constant vacuum. This makes each sampling station independent of the others (like electrical appliances on a 115-V electrical circuit), provides a constant reference vacuum for flow control purposes, and permits the air mover to be optimized for one operating condition. The vacuum most frequently selected is 254-mm Hg (10-in. Hg), which is adequate for most air-sampling purposes and is within the operating range of most of the heavy-duty air movers.

The sampling flow rate to air samplers connected to a constant vacuum system can be controlled, while at the same time avoiding flow meter correction problems, by one of the following methods:

- manual flow control with the flowmeter located downstream from the control valve and calibrated for the constant vacuum in the piping system
- automatic flow control with a differential regulator and an adjustable metering orifice in series with the sample collector, to compensate for the filter load
- automatic flow control with a thermal anemometer used to operate a control valve in series with the sample collector.

5.1.3 The Importance of Having a Gauge to Indicate the Filter Load

A vacuum gauge for indicating the filter load is recommended for a number of reasons: 1) it shows whether the load from a newly installed sampling filter is normal;

2) it shows whether the load from the protective (or backup) filter is normal; 3) it shows the effect of using different sample collectors; 4) it shows how fast the filter load is increasing, which is an indication of the amount of a particulate in the air; 5) it simplifies the testing of the flow control system; and 6) it shows how close the filter load is to the limit of the flow control system.

5.1.4 The Importance of Constant Flow

Accurate interpretation of air-sampling data depends upon knowing how much air the sample came from and obtaining a true time average of the changing concentrations of contaminants in the air during the test. With constant flow, the amount of air sampled is simply a product of the flow rate and the elapsed time. Without constant flow, the sample may contain a disproportionately large amount of particulate from the start of the test when the filter was clean and a disproportionately small amount from later periods. Thus, under varying flow conditions, a short radioactive burst might be collected at either a high or a low flow rate, depending on the condition of the filter, making the sample unrepresentative and jeopardizing its usefulness in radiation protection.

5.1.5 Total Volume Measurement Devices

For some air-sampling applications, the total volume of the sample is measured, rather than calculating the flow rate and integrating over time. The method of operation of flow totalizers may vary, but most use some adaptation of rate measurement. Some devices use electronic calculation of integrated flow based on critical orifice parameters or the position of a rotameter or similar device; however, the most commonly used totalizers use timing devices that assume a continuous flow rate and read out in units of total volume sampled. Compositor samplers are usually of the latter type, with a timed-operation positive displacement air mover. Under normal conditions, the reliability and accuracy are comparable to rate measurement devices. Totalizers can be made more accurate than rate measurement devices by designing them to correct for fluctuations in flow rate. A summary of the types of flow-rate measurement instruments is in Table 5.1.

Table 5.1. Types of Flow-Rate Measurement Instruments^(a)

Type of Meter	Quantity Measured	Typical Range
Spirometer	Integrated volume	6 to 600 L
Soap film meter	Integrated volume	0.002 to 10 L
Wet test meter	Integrated volume	Unlimited volumes, maximum rates
Dry gas meter	Integrated volume	Unlimited volumes, maximum flow rates from 10 to 150 L/min
Venturi meter	Volumetric flow rate	Depends on tube and orifice diameters
Orifice meter	Volumetric flow rate	Depends on tube and orifice diameters
Rotameter	Volumetric flow rate	From 0.001 L/min

(a) Adapted from Table F-4 of the ACGIH document (1989).

5.2 Calibration Frequency and Methods

Calibration of flow-rate measurement instruments used in the field (typically, rotameters or critical orifice meters) is performed by comparing the flow rate measured by the field instrument with the flow rate measured by a primary standard instrument, such as a spirometer or soap film flowmeter, or a secondary standard instrument, such as a dry gas meter or wet test meter.

5.2.1 Calibration Frequency

Regulatory Guide 8.25 states that licensees should calibrate airflow rate meters annually and after modifications, repairs, or any indication that the meter is not performing properly. The annual frequency was established as follows:

1. Five vendors were queried on the recommended frequency of calibration based on historical performance of the instruments. Three of the vendors recommended annual calibration, one vendor suggested semiannual calibration as use and operating experience dictates, and one vendor did not recommend recalibration of their meters.

2. In addition to the annual frequency, ANSI N42.17B, *Performance Specification for Health Physics Instrumentation—Occupational Airborne Radioactivity Monitoring Instruments* (ANSI 1989), Section 4.9, "Alteration and Modification," states, "Instruments that have been altered, changed or modified by the manufacturer in any manner which could affect the capability of the instrument to meet the specifications provided in this standard shall be re-evaluated to ensure conformance...."

Other criteria in ANSI N42.17B are also given to help determine when calibration is needed between the annual scheduled calibrations. When these criteria (listed below) are not met, repair and or recalibration is suggested.

- Section 9.1, "Flow-Rate Meter Accuracy," states, "Airflow rate meters shall be accurate to within $\pm 20\%$ of the conventionally true flow-rate values."
- Section 9.2, "Air In-Leakage," states, "The leakage of air into the monitoring unit upstream of the flow-rate meter shall be less than 5% of the nominal flow rate."

- Section 9.3, "Flow-Rate Stability," states, "The manufacturer shall state the nominal flow rate for the type of filter that is used. After the warm-up time specified by the manufacturer for the monitoring unit, the measured flow rate shall not vary more than 10% from the nominal flow rate."

5.2.2 Calibration to Primary Standards

The spirometer and soap film flowmeter are examples of primary standards that measure volume directly. The spirometer is a cylindrical bell with its open end under a liquid seal. The soap film flowmeter is a graduated tube in which a soap bubble is created. These are primary standards because they are a direct measurement of volume based on the physical dimensions of an enclosed space. Recalibration of primary standards is not necessary, except when there is physical damage that can change the volume of the enclosed air space used for the flow-rate measurement.

Refer to the American Society of Testing and Materials Standard D1071, *Standard Methods for Volumetric Measurement of Gaseous Fuel Samples* (ASTM 1983a), for a calibration procedure for spirometers using standard cubic-foot bottles. A calibration procedure for a soap film flowmeter using a liquid positive-displacement technique is contained in Volume II of the EPA's *Quality Assurance Handbook for Air Pollution Measurement Systems* (EPA 1985).

5.2.3 Calibration to Secondary Standards

The wet test and dry gas meters are examples of secondary standards, tracing their calibrations to primary standards. Although secondary standards require recalibration, they can maintain their accuracy for extended periods with proper handling and maintenance. A calibration procedure for a wet test meter can be found in Section 19 of ASTM Standard D1071 (ASTM 1983a). A wet test meter measures volume by displacement of the liquid in the meter by the air being measured; a dry gas meter measures volume by displacement of the air in the meter by the air being measured. A more complete description of the operation of these meters is provided by ACGIH (1989; Section F).

Air-Sampling Instruments for Evaluation of Atmospheric Contaminants (ACGIH 1989) refers to rotameters and critical orifice meters as "additional secondary

standards," meaning that they usually have an accuracy less than either a wet test meter or a dry gas meter. These additional calibration standards have accuracy characteristics similar to those of field rotameters and orifice meters. Therefore, if they are used to calibrate field instruments, it is appropriate to calibrate them against a primary or secondary standard at the same frequency specified for field instruments. The calibration hierarchy is as follows:

- primary standard (e.g., spirometer)
- secondary standard (e.g., wet test meter)
- additional secondary standard (e.g., rotameter).

Thus, a rotameter can be calibrated with a wet test meter, which in turn can be calibrated with a spirometer, or the rotameter can be calibrated directly with a primary standard.

5.2.4 Calibration of Rotameters

Because rotameters are the flow-rate meters most often used in the field, their calibration and maintenance are of common concern to users. The ASTM Procedure D3195, *Standard Practice for Rotameter Calibration* (ASTM 1983b), provides a method for calibrating a rotameter with either a wet test meter or a spirometer (gasometer). Beginning with a wet test meter or spirometer, the rotameter output (usually at the top of the rotameter) is connected to the wet test meter or spirometer, as shown in Figures 5.3 and 5.4. Keeping connections as short as possible, with a maximum inside-line diameter helps avoid appreciable pressure drops. It is important to the calibration process that air leakage be avoided and that tight connections be made between the rotameter and the standard. Leakage can be checked in several ways. Plugging the line upstream of the connection will cause the flow to drop to zero if the connection is tight. A smoke test or small amounts of soap solution applied near potential leak points can also be used to detect leaks.

The ASTM Procedure D1071, *Standard Methods for Volumetric Measurement of Gaseous Fuel Samples* (ASTM 1983a), suggests that a minimum of five readings be taken over the entire range of flow rates for the particular instrument. The average of a pair of timed readings on the wet test meter or spirometer should be

Measuring Air Sampled

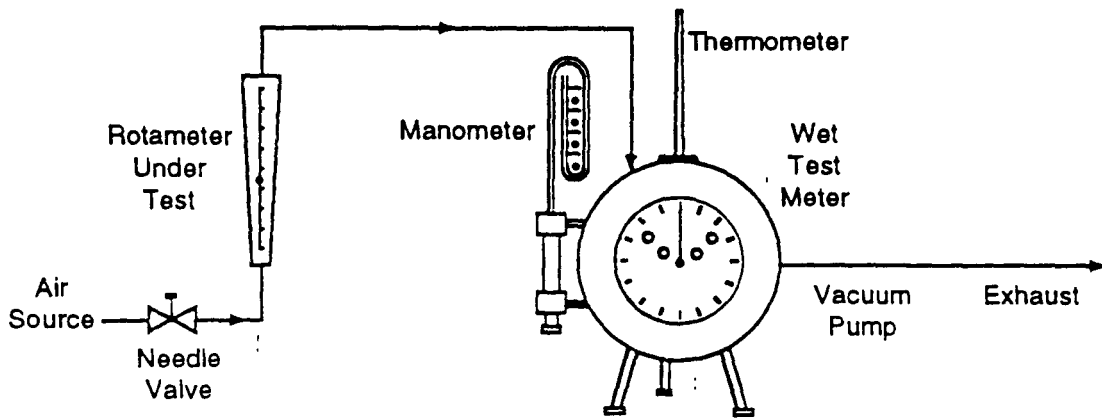

Figure 5.3. Calibration Setup of a Rotameter Using a Wet Test Meter

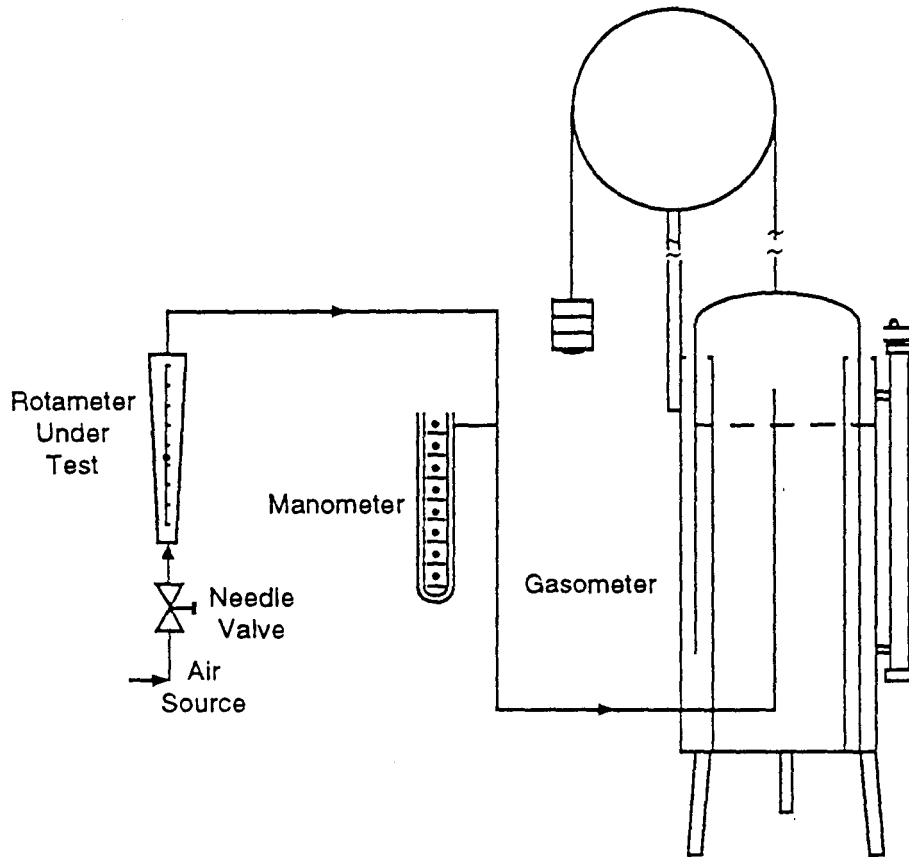

Figure 5.4. Calibration Setup of a Rotameter Using a Spirometer

determined for each measurement point. When taking readings, the meter is first read from lowest to highest measurement point and then from highest to lowest. The manometer reading and the meter water temperature are recorded for each measurement. In addition, the room temperature, the barometric pressure, and the relative humidity are recorded before and after the calibration run; the average values are used in the calculations.

An alternative calibration procedure for a rotameter is in Volume II of EPA's *Quality Assurance Handbook for Air Pollution Measurement Systems* (EPA 1985). The procedure uses a soap-film meter for the calibration. A calibration procedure for the special situation of calibrating a lapel-sampler rotameter is contained in Appendix A.1 of ASTM Procedure D4185, *Methods for Calibration of Small Volume Air Pumps* (ASTM 1983c). Again, the procedure described uses a soap-film meter for the calibration.

5.2.5 Calibration of Flow Totalizers

Two methods of calibration are typically used. One is to calibrate the flow-rate measurement portion and independently test the time integration. The other is to pass a specific volume through the device, and compare this with the measured result, most often by slowly releasing a compressed gas of known mass, with corrections for pressure and temperature.

5.3 Uncertainty

As specified in Regulatory Guide 8.25, air-sampling instruments, including personal air samplers having flow-rate meters or total-volume meters, should have the meters calibrated so that the overall measurement uncertainty in determining the sample volume is less than 20%. The overall uncertainty or measurement error is calculated by adding 1) the estimated uncertainty that arises when a user reads the meter scale, 2) the estimated uncertainty in the measurement instrument's calibration factor, and 3) the estimated uncertainty in the measurement of sampling time. Each of these uncertainties is expressed as a percent uncertainty, i.e., the absolute value of an arbitrary allowance for uncertainty (absolute uncertainty) divided by a relevant true value and then multiplied by 100. For example, in determining the percent uncertainty in reading the meter scale, the arbitrary uncertainty is customarily assumed to be one-half of the smallest scale division on the instrument. Thus, if an instrument scale reads a total of

50 L/min, with each L/min divided into segments of 0.1 L/min, the absolute uncertainty is 0.1/2, or 0.05 L/min. (That is, the uncertainty is arbitrarily assumed to be ± 0.25 L/min around a middle value; then, the absolute uncertainty is the absolute value of the number, or 0.05 L/min.) To find the percent of uncertainty in reading the meter scale, this absolute uncertainty is divided by the flow rate (in this example, 2 L/min) of the instrument and then multiplied by 100:

$$(0.05 \text{ L/min} / 2 \text{ L/min}) \times 100 = 2.5\% \quad (5.1)$$

Similar approaches yield the percent of uncertainty in the calibration and in the measurement of sampling time. The calibration percent of uncertainty is found relative to a standard. The percent uncertainty in sampling time, which is used only for samplers with flow-rate meters, has been assumed to be 1% for most sampling times.

Once the uncertainties for meter reading, calibration, and sampling are obtained, the overall measurement uncertainty (U_v) in computing the total volume of air sampled can be calculated using Equation (5.2):

$$U_v = [U_r^2 + U_c^2 + U_t^2]^{1/2} \quad (5.2)$$

where U_r = the percent uncertainty in reading the meter scale. The absolute uncertainty in the meter reading is converted to a percent uncertainty before being inserted in Equation (5.2). This is done by dividing the absolute uncertainty by the flow rate (cfm) and multiplying by 100. An estimate of the absolute uncertainty in reading a meter scale for both flow-rate instruments and total flow volume instruments is one-half of the smallest scale division.

U_c = the uncertainty in determining the calibration factor. An estimate is the percent uncertainty associated with the standard instrument used in the calibration.

U_t = the percent uncertainty in the measurement of sampling time. When using a timing device to measure sample volume, an appropriate value of the percent uncertainty for usual sampling

Measuring Air Sampled

volume, an appropriate value of the percent uncertainty for usual sampling intervals is 1%. For an instrument with a total volume meter, this term is dropped from the equation.

Assuming some typical values, the overall uncertainty (U_v) associated with a calibration factor (U_c) uncertainty of 1%, a scale reading (U_s) uncertainty of 2%, and a sampling time (U_t) uncertainty of 1% is determined as follows:

$$U_v = [(2.5)^2 + 1^2 + 1^2]^{1/2} = 2.9\% \quad (5.3)$$

Minimizing the uncertainty in reading the scale requires a consistent method for reading the rotameter. Most manufacturers recommend reading the float at the widest point. Establishing procedures for reading the scale will help reduce the variation among readings from individuals using different methods. Figure 5.5 shows several float designs and the recommended points for reading the flow rate.

5.4 Method for Determining Air In-Leakage

Regulatory Guide 8.25 recommends that continuous air monitors be checked for in-leakage when they are calibrated for volume of air sampled. In-leakage upstream of the flow-measuring device is limited to a maximum of 5% by ANSI N42.18 (1985). A potential problem affecting the accuracy of volume measurements is system leakage downstream of the sample collector and upstream of the flow measurement instrument. Under these conditions, the indicated flow is more than the airflow through the sample collector and will lead to overestimates of the air volume that is sampled. A field test for system in-leakage can be performed simply by blocking the sample inlet and seeing if the flow drops to zero. If it does not, there is in-leakage to the system. Caution is necessary for systems with components that are either fragile or sensitive to rapid pressure changes, such as continuous air monitors with thin-window detectors located in the sample stream. The preferred method,

using rotameter intercomparisons upstream and downstream of the sample collector, is contained in ANSI N42.7B (1985), Section 9.2.2.

5.5 Pressure and Temperature

There are many variables that may affect the accuracy of an air-sample measurement. Two of these are pressure and temperature variations. Appropriate corrections, using the ideal gas laws, when either the absolute pressure or absolute temperature exceeds 5%, can assure that the pressure and temperature variations do not cause inaccurate measurement results. Two commonly performed tasks that may involve pressure differences are cited: calibration of an instrument at a different altitude (and thus a different air pressure) than that at which the instrument will be used, and measurement of flow rate on the downstream side of the collector (resulting in measurement under a vacuum). The difference in altitude can be evaluated by comparing the barometric pressure readings at the calibration location with those at the sampling location. Measurements under a vacuum can be accounted for by connecting a manometer to the sampling assembly downstream of the collector and taking pressure readings with the collector present and the collector removed.

One method used to account for the pressure drop is to calibrate the field instrument in place with the sample collector, as shown in Figure 5.6. The primary or secondary standard flow-rate measurement instrument is connected to the air-sampling assembly upstream of the sample collector and one leg of the standard instrument is open to the atmosphere. The field instrument flow (e.g., a rotameter) can be directly related to the flow at atmospheric pressure, as measured by the standard instrument.

The ideal gas laws can be used to normalize volume (flow-rate) measurements taken in the field to those taken under calibration conditions, using Equation (5.4):

$$V_c = V_s \left(\frac{P_s}{P_c} \right) \left(\frac{T_c}{T_s} \right) \quad (5.4)$$

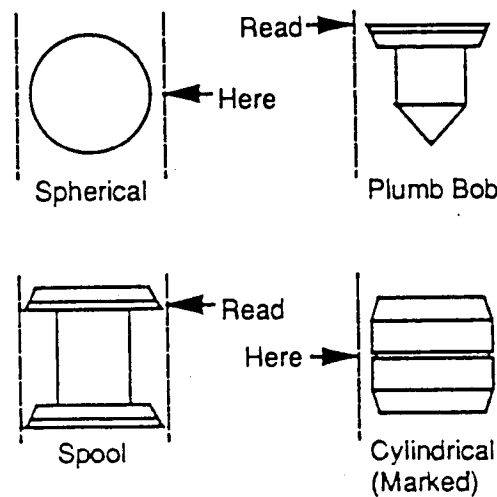

Figure 5.5. Typical Rotameter Floats and Reading Indicator Positions

where V_c = volume under calibration conditions (m^3)

$$\text{mm Hg} = \text{kPa} \times 7.5 \quad (5.8)$$

V_s = volume under field conditions (m^3)

P_c = absolute pressure during calibration (mm Hg)

P_s = absolute pressure during sampling (mm Hg)

T_c = absolute temperature during calibration ($^{\circ}K$)

T_s = absolute temperature during sampling ($^{\circ}K$).

Conversion equations to obtain absolute temperatures and pressures are as follows:

$$^{\circ}K = ^{\circ}C + 273 \quad (5.5)$$

$$^{\circ}K = [(^{\circ}F - 32)/1.8] + 273 \quad (5.6)$$

$$\text{mm Hg} = \text{in. of water} \times 1.87 \quad (5.7)$$

Although clean dry air behaves similarly to an ideal gas, some variation may occur. Comparing the calculations in Equations (5.4) through (5.8) to the manufacturer's performance curve for the flowrate measurement instrument will verify performance.

The following examples illustrate the use of the ideal gas laws to correct the volume of air sampled to calibration conditions.

Temperature Correction Example - A health physicist calculates that a sample volume of $90 m^3$ (V_s) is collected by a rotameter in the field, based on the flow rate. The health physicist learns that the rotameter was calibrated at a temperature of $72^{\circ}F$ and that the temperature in the field during sampling was $7^{\circ}C$ ($45^{\circ}F$). To determine if an adjustment should be made to the volume of the sample, the health physicist converts the temperatures to the absolute (Kelvin) scale, using Equation (5.6). Thus, the sampling temperature (T_s) is $295^{\circ}K$. The difference is 5.4%. Because the difference exceeds 5%, a corrected volume should be calculated, as recommended in Regulatory Guide 8.25. The health

Measuring Air Sampled

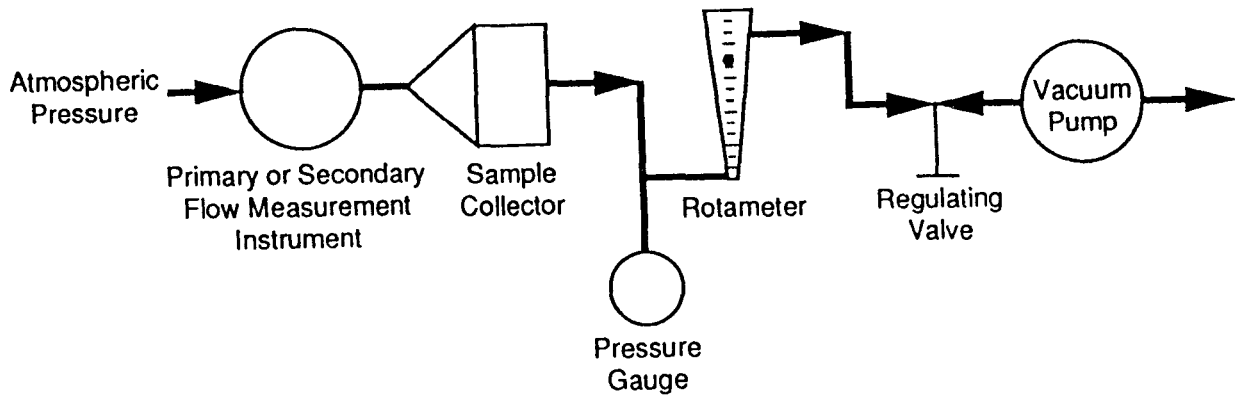

Figure 5.6. In Place Calibration of Sample Collector

physicist finds that the sampling and calibration absolute pressures are equivalent (at 760-mm Hg [29-in. Hg]), so only the temperature differences need to be used in changing the sampling volume. The health physicist uses Equation (5.4) to adjust sample volume to calibration conditions, as follows:

$$V_c = V_s \left(\frac{P_s}{P_c} \right) \left(\frac{T_c}{T_s} \right) \quad (5.9)$$

$$= 90 \left(\frac{760}{760} \right) \left(\frac{295}{280} \right) = 95 \text{ m}^3$$

If the calibration was done at normal room temperature 22°C (72°F), the correction would be less than 5% if the temperature in the field was within 15°C (26°F) of normal room temperature. Thus, a correction would be needed only for operating temperatures below about 46°F or above about 98°F.

Pressure Correction Example - Later, the health physicist discovers that the absolute pressure during sampling with the rotameter described in the previous example was 700-mm (28-in.) Hg and that the absolute pressure during calibration was 760-mm (29-in.) Hg. Because the difference in absolute pressure between the sampling and the calibration is

8%, a corrected volume is calculated. Using Equation (5.4), the health physicist calculates the sample volume corrected to calibration conditions:

$$V_c = V_s \left(\frac{P_s}{P_c} \right) \left(\frac{T_c}{T_s} \right) \quad (5.10)$$

$$= 90 \left(\frac{700}{760} \right) \left(\frac{295}{280} \right) = 87 \text{ m}^3$$

If the calibration was done at sea level (760-mm [29-in.] Hg), the difference will be less than 5% if the field pressure is within 38-mm (1.5-in.) Hg of 760-mm (29-in.) Hg.

Pressure Drop Example - A health physicist calculates a sample volume of 100 m³ based on the flow rate as determined by a rotameter (located downstream of the sample collector) and the same time. A manometer placed in series after the sample collector indicates an absolute pressure 720-mm (28-in.) Hg. To correct the sample volume for this pressure drop, Equation (5.4) becomes:

$$V_a = V_s \left(\frac{P_s}{P_a} \right) \quad (5.11)$$

where V_a = volume collected under atmospheric pressure

V_s = volume collected under sampling conditions

P_a = atmospheric pressure

P_s = pressure at which sample volume was measured.

Using Equation (5.11), the adjusted sample volume becomes

$$V_a = V_s \left(\frac{P_s}{P_a} \right) = 100 \left(\frac{720}{760} \right) = 95 \text{ m}^3 \quad (5.12)$$

5.6 References

- American Conference of Governmental Industrial Hygienists (ACGIH). 1989. *Air-Sampling Instruments for Evaluation of Atmospheric Contaminants*. 7th edition, Cincinnati, Ohio.
- American National Standards Institute (ANSI). 1985. *Specification and Performance of On-Site Instrumentation for Continuously Monitoring Radioactivity in Effluents*. ANSI N42.18, New York, New York.
- American National Standards Institute (ANSI). 1989. *Performance Specifications for Health Physics Instrumentation—Occupational Airborne Radioactivity Monitoring Instrumentation*. ANSI N42.17B, New York, New York.
- American Society for Testing and Materials (ASTM). 1983a. *Standard Methods for Volumetric Measurement of Gaseous Fuel Samples*. ASTM D1071, Philadelphia, Pennsylvania.
- American Society for Testing and Materials (ASTM). 1983b. *Standard Practice for Rotameter Calibration*. ASTM D3195, Philadelphia, Pennsylvania.
- U.S. Environmental Protection Agency (EPA). 1985. *Quality Assurance Handbook for Air Pollution Measurement Systems, Volume II, Ambient Air Specific Methods*. EPA-600/4-77-027a, Washington, D.C.
- U.S. Nuclear Regulatory Commission (NRC). 1992. *Air-Sampling in the Workplace*. Regulatory Guide 8.25, Rev. 1, Washington, D.C.

6 Evaluation of Sampling Results

Regulatory Guide 8.25 recommends that several evaluations be made on the results of an air sample. First, if the air sample is used to determine if confinement is being maintained, the guide recommends that air-sampling results be evaluated for changes in concentrations over time. Second, the guide recommends that consideration be given to sample adjustments for the filter efficiency. Finally, the guide recommends that detection sensitivity of the measurement equipment be established.

6.1 Detecting Changes in Air Concentrations Over Time

Regulatory Guide 8.25 recommends that the results of fixed-location sampling, whose purpose is to confirm radioactive material confinement during routine or repeated operations, be either 1) analyzed for trends or 2) compared with administrative action levels. Trend analysis (for example, by use of control charts) can be performed to determine whether airborne concentrations are within the normal range, to verify that administrative and engineering controls are operating properly to maintain occupational doses ALARA. Administrative action levels can be used to serve as a basis for determining when confinement is satisfactory.

6.2 Efficiency of Collection Media

Regulatory Guide 8.25 (NRC 1992) recommends that for collection efficiencies of less than 95%, the sample result be adjusted to account for airborne radioactive material not collected from the sampled atmosphere. The collection efficiency varies based on several factors, including the sample velocity across the medium, properties of the medium itself, and the range of particle sizes being collected.

Manufacturers of sample collection equipment routinely determine the efficiency for collection of the sample of interest (respirable particles, for example). For particles in the respirable range, manufacturer's data on collection

efficiency are generally adequate. However, if such data are not available or are not specific to the particle sizes of interest, determination of the efficiency by the user may be appropriate. The collection efficiency of a medium can be determined by evaluating losses to a filter such as glass fiber or membrane with a known collection efficiency near 99.9%. The filter to be evaluated is placed, first backed up by a filter known to be highly efficient for particles much smaller than the minimum particle size in the range of interest. The filters are then subjected to an atmosphere containing long-lived radioactive material under field conditions and evaluated. The collection efficiency (E) may then be calculated as given by Equation (6.1):

$$E = \frac{A_1}{A_1 + A_{k1}} \quad (6.1)$$

where A_1 is the activity collected on the filter to be evaluated and A_{k1} is the activity collected on the backup filter with known efficiency.

The potential for burial of radionuclides within the filter medium can also be evaluated, which can be especially important for alpha counting. To perform the evaluation, a second filter with a known efficiency is placed in parallel with those described above. After normalizing the data to account for any differences in airflow, the activity lost, A_L , to absorption in the medium is simply the difference and can be determined as given by Equation (6.2):

$$A_L = A_{k2} - A_{k1} - A_1 \quad (6.2)$$

where A_{k2} is the activity on the known filter that was used in parallel. The activity lost is then included to adjust for particle burial and Equation (6.1) is modified:

$$E = \frac{A_1 + A_L}{A_{k2}} \quad (6.3)$$

Evaluation of Sampling Results

EXAMPLE 1. The following is an example using Equation (6.1) when alpha counting is not a consideration.

A paper filter with an unknown efficiency is backed up by a membrane filter with an efficiency of 99.9%. Activity measured on the filter in question, A_1 , is 100 dpm and activity on the backup (well-known) filter is 10 dpm.

$$E = \frac{A_1}{A_1 + A_2} = \frac{100}{110} = 0.91 \quad (6.4)$$

Because the efficiency of the filter is calculated to be 91% and Regulatory Guide 8.25 recommends that a correction factor be used if the efficiency of the collection media is less than 95%, the calculated activity on the filter should be increased by 9%.

EXAMPLE 2. Use of the above equations when burial may be a problem.

A filter with a known high efficiency is placed in parallel with the two filters in series as in Example 1. This time the atmosphere contains uranium and the samples are to be analyzed by direct alpha counting. Activity measured on the questionable filter, A_1 , is 210 dpm and activity on the backup (well known) filter is 8 dpm. The activity on the filter placed in parallel was 300 dpm.

First, the activity buried in filter A_1 , which cannot be analyzed by direct alpha counting, is calculated.

$$A_L = A_{L2} - A_{L1} - A_1 = 82 \text{ dpm} \quad (6.5)$$

Adjusting for this loss through Equation (6.3) yields the following efficiency:

$$E = \frac{A_1 + A_L}{A_{L2}} = \frac{292}{300} = 0.97 \quad (6.6)$$

The filter met the 95% level of efficiency, but each analysis should now be increased by the absorption factor, which in this case is $A_1/(A_1 + A_L)$ or about 71%.

To illustrate the value of determining the collection media efficiency, a short experiment was conducted at a fuel fabrication facility. Membrane filters, which are considered to be the closest to 100% efficient, were used

as backup filters for Whatman 41 and glass fiber filters. Sample times were varied to see if dust loading affected efficiency. The site of the study was originally chosen to be the pellet area, but the airborne concentrations were not great enough to allow collection of sufficient radioactivity on the backup filter. Although it would have been best to sample in a location that showed little variation in particle size, the oxide building was chosen next because the airborne levels proved to be consistently greater. The instrument used to analyze the samples was a Canberra high-throughput proportional counter.

Table 6.1 shows the results of this experiment. The level of radioactivity was still low, but in most of the Whatman 41 cases the instruments used could detect the presence of radioactivity on the backup filters. The average efficiency calculated for the glass fiber filters was 99.7%, while the average efficiency for the Whatman 41 was 89.7%. To meet the intent of Regulatory Guide 8.25, a correction of 10.3% should be applied to all air samples taken in this area. Because particle size distributions may vary in different areas of a facility, the licensee may want to test the filter efficiency in other areas where the particle size distribution is not well characterized. Because it may not be feasible to determine collection efficiency for different areas of a facility, the cellulose filters may be replaced with filters that have a higher efficiency for the range of particle sizes encountered.

6.3 Detection Sensitivity

There are no specific requirements in 10 CFR Part 20 for the sensitivity of a workplace air monitoring program. However, a licensee may want to evaluate the detection capability of an air-sampling program to see if it will adequately support the licensee's dose measurement and ALARA goals.

For operational purposes, the statistical concept of "decision level" is useful for deciding if a sample contains radioactivity. Results of individual or pooled measurements are compared with the decision level. The decision level is a value chosen so that results above it are unlikely to be false alarms. Thus, the operational health physicist chooses the decision level to be far enough above zero so that there is an acceptably low rate of false alarms due to random statistical fluctuations in the counting process (known to statisticians as "false positives").

Table 6.1. Filter Efficiencies for the Oxide Conversion Building

Filter Tested	Sample Duration (h)	Face Velocity cm/s	Activity on Filter (cpm)	Activity on Back-up (cpm)	Filter Efficiency
W41	8	37	5.3	0.5	0.91
W41	14	37	4.7	1.4	0.77
W41	16	37	30.8	3.6	0.90

Another concept a licensee may want to use is that of "minimum detectable activity" or "minimum detectable concentration." Unlike the decision level, the minimum detectable quantities are performance gauges of a program that can be compared with a performance goal. For example, suppose a licensee wanted to ensure detection of airborne conditions that would lead to intakes resulting in more than a 10-mrem committed effective dose equivalent. Because 2000 DAC-h result in 5000 mrem, 4 DAC-h result in 10 mrem. Thus, the licensee may decide to implement an air monitoring program capable of detecting 4 DAC-h in, say, any 40-hour work period. To do this, the licensee would require a program with a minimum detectable concentration of 0.1 DAC when operated for 40 hours.

Many air-sampling systems use a pump to draw air through a filter that is later removed and counted. Measurements derived from counting the filter can be used to deduce an average air concentration during the sampling time. The various hardware and procedural and statistical factors that determine the detection sensitivity of a measurement system are discussed in this section. This section also gives formulas and examples (including solutions) for calculating the activity concentration ($\mu\text{Ci}/\text{cm}^3$), decision level, minimum detectable activity, minimum detectable concentration, and, when results of many measurements are pooled, the minimum detectable average concentration. A summary of the symbols, quantities, and units used is presented in Table 6.2.

6.3.1 Determining the Activity Concentration

An integral part of an air-sampling program is the measurement of radioactivity and the subsequent interpretation of the data. Counts in a radioactivity

measurement system come from both the background and samples. The result of a measurement of radioactive materials in or on an air-sampling medium is the number of gross counts, N_g , during the gross counting time, T_g ; the result of a measurement of an appropriate blank is the number of background (or blank) counts N_b during the background (or blank) counting time, T_b . Background may be counted once per shift for a period of time equal to or longer than the time the samples are counted. If background can be counted longer than samples, the licensee may choose to make one long background count or several replicate counts each for the same length of time as for the samples. The latter alternative affords the opportunity to test for non-random changes in background count rate, thereby building confidence in a program. For example, if samples are counted for 1 minute and background for ten minutes, the background could be counted for 10 one-minute intervals and the data analyzed for stability. Little statistical precision is gained by counting background more than 10 times as long as the sample.

Because there are purely statistical fluctuations in background count rates, and because background contributes both to the blank and the sample counts, a statistical test may be applied to the net count rate to decide if activity is present. For counting times expressed in minutes (or seconds), the net count rate R_n in counts per minute (cpm) (or counts per second [cps]) is

$$R_n = R_g - R_b = \frac{N_g}{T_g} - \frac{N_b}{T_b} \quad (6.7)$$

where R_g and R_b are the gross and background count rates, respectively.

Evaluation of Sampling Results

Table 6.2. Summary of Symbols, Quantities, and Units

Symbol	Quantity	Traditional Unit	SI Unit
T_b	background counting time	min.	s
T_g	gross counting time	min.	s
T_s	duration of sample collection	min.	s
T_D	decay time between sampling and counting	min.	s
N_b	number of background counts observed	-	-
N_g	number of gross counts observed	-	-
N_n	number of net counts observed	-	-
N_i	number of counts in the <i>i</i> th observation	-	-
R_b	background count rate	counts min ⁻¹	s ⁻¹
R_g	gross count rate	counts min ⁻¹	s ⁻¹
R_n	net count rate	counts min ⁻¹	s ⁻¹
F	air flow rate through the air sampler	cm ³ min ⁻¹	m ³ s ⁻¹
E	fractional filter efficiency = (%eff)/100	-	-
K	counting efficiency	counts min ⁻¹ μCi ⁻¹	s ⁻¹ Bq ⁻¹
$T_{1/2}$	radioactive half-life	min	s
λ	decay constant = 0.693/ $T_{1/2}$	min ⁻¹	s ⁻¹
C	activity concentration	μCi/cm ³	Bq m ⁻³
s_c	standard deviation of activity concentration	μCi/cm ³	Bq m ⁻³
$DL(R_n)$	decision level for net count rate	counts min ⁻¹	s ⁻¹
MDC	minimum detectable concentration	μCi/cm ³	Bq m ⁻³
n	number of air samples	-	-
-	a bar over a symbol denotes "average," e.g., \bar{R}_n , \bar{C} , \bar{N} , $MDC\bar{C}$	-	-
χ^2	chi-squared statistic	-	-

If several background measurements are made during a 24-hour period to check for consistency, the counts and the times may be combined to improve the precision of the measurement as follows:

$$N_b = \sum_{i=1}^n N_{b,i} \text{ and } T_b = \sum_{i=1}^n T_{b,i} \quad (6.8)$$

Under the assumption of constant concentration of radioactivity in the air during the time the sample is collected, and if sampling, decay, and counting times are short with respect to the half-life, the activity concentration is given by

$$C = \frac{R_n}{EFKT_s} \quad (6.9)$$

where

- C = concentration of radioactive material in the air in $\mu\text{Ci}/\text{cm}^3$ (or Bq m^{-3})
- R_n = net count rate in cpm (or cps)
- E = fractional filter efficiency (% efficiency/100)
- F = airflow rate through the sampler in cm^3/min (or $\text{m}^3 \text{s}^{-1}$)
- K = counting efficiency in $\text{cpm}/\mu\text{Ci}$ (or cps Bq^{-1})
- T_s = duration of sample collection in min (or s).

EXAMPLE. An air sampler operating at 10 L/min is run for 10 minutes to sample for gross beta-emitting particulates. The filter efficiency is 90%. The filter is promptly counted for 1 minute, giving 60 counts. The background is counted for 10 minutes, giving 110 counts. The counter efficiency is 33%. What is the activity concentration?

SOLUTION. First make sure all quantities are in the units appropriate for the equations:

- $T_g = 1 \text{ min}$
- $T_b = 10 \text{ min}$
- $R_g = 60 \text{ counts}/1 \text{ min} = 60 \text{ cpm}$
- $R_b = 110 \text{ counts}/10 \text{ min} = 11 \text{ cpm}$
- $R_n = 60 - 11 = 49 \text{ cpm}$
- E = 90%/100% = 0.90
- F = 10 L/min \times 1E3 $\text{cm}^3/\text{L} = 1\text{E}4 \text{ cm}^3/\text{min}$
- K = 0.33 count/disintegration \times 2.22E6 dis/ $\mu\text{Ci} = 732,600 \text{ cpm}/\mu\text{Ci}$
- $T_s = 10 \text{ min}$

Then calculate the concentration as follows:

$$C = \frac{49 \text{ cpm}}{(.9) (10^4 \text{ cm}^3/\text{min}) (732,000 \text{ cpm}/\mu\text{Ci}) (10 \text{ min})} = 7.4\text{E}-10 \mu\text{Ci}/\text{cm}^3 \quad (6.10)$$

6.3.2 Deciding Whether an Air Sample Is Above Background: The Decision Level

Any net count rate greater than the decision level represents the presence of activity in the sample. The decision level for the net count rate is as follows (Strom and Stansbury 1992; Lochamy 1976):

$$DL(R_n) = 1.645 \sqrt{R_b (1/T_b + 1/T_g)} \quad (6.11)$$

where the 1.645 value corresponds to a 5% false alarm rate (i.e., 1 sample in 20 that has no activity present will exceed this count rate simply due to random statistical fluctuations). Licensees may assume that no activity is present in air if the net count rate is less than the decision level; however, it is a good practice to record all air-sampling results, whether above the decision level or not.

EXAMPLE. Using the data from the previous example, calculate the decision level.

SOLUTION. For $R_b = 11 \text{ cpm}$, $T_b = 10 \text{ min.}$, and $T_g = 1 \text{ min.}$, the decision level is

$$DL(R_n) = 1.645 \sqrt{11 \text{ cpm} \left[\frac{1}{10 \text{ min}} + \frac{1}{1 \text{ min}} \right]} = 1.645 \sqrt{11 \times 1.1} = 5.7 \text{ cpm} \quad (6.12)$$

Using this counting scenario, any net count rate above 5.7 cpm would be judged to be significant, with only a 5% chance of being a false alarm.

Equations are given in Appendix A for cases where radioactive decay during sampling and counting may affect results. Equations are also provided in the appendix that may improve precision and detection capability.

6.3.3 Measuring Detection Capability for a Counting System: Minimum Detectable Activity

A counting system may be characterized by a minimum detectable activity for a specified choice of parameters such as counting times. Once a decision level has been specified by the choice of count times and the false alarm rate (this document uses a 5% false alarm rate), it is possible to determine a value of activity that would yield a count rate less than the decision level a certain fraction of the time. This value of activity is called the minimum detectable activity. The fraction of the time that an activity equal to the minimum detectable activity would actually result in a count rate less than the decision level

Evaluation of Sampling Results

is called the *false negative rate*. This document uses a 5% false negative rate, i.e., 1 time in 20 a sample with an activity equal to the minimum detectable activity would actually result in a count rate less than the decision level. Under these assumptions, the minimum detectable activity for the activity on the filter becomes

$$\text{MDA} = \frac{2.71 + 3.29 \sqrt{R_b T_g (1 + T_g/T_b)}}{K T_g} \quad (6.13)$$

where the terms are defined above (Currie 1968, 1984; Brodsky 1984; NCRP 1985). Note that the filter efficiency does not appear in Equation (6.10).

The filter efficiency, E , appears in the equation on page 8 of Regulatory Guide 8.25 because that equation describes the minimum amount of activity in the air that was sampled (some of which passed through the filter), while Equation (6.13) refers to the activity actually trapped by the filter.

The minimum detectable activity is a performance indicator for a counting system. Normally the minimum detectable activity is compared with a performance goal rather than with the result of a measurement. The minimum detectable activity is an amount of activity that yields a result above the decision level most of the time (95% of the time for this document). To contrast the decision level and the minimum detectable activity, consider the following: the decision level represents a count rate large enough that it is unlikely to be a "false alarm," but the minimum detectable activity represents an activity large enough that it is unlikely not to "set off the alarm," that is, an activity at or above the minimum detectable activity is likely to result in a count above the decision level (likely to "set off the alarm"). Note that it is quite possible that an activity less than the minimum detectable activity will "set off the alarm" or result in a count rate above the decision level.

For example, suppose that a licensee has determined that 4 DAC-h are expected to result in an activity of 4×10^{-5} μCi (1.5 Bq) on the filter of an air sampler run for 8 hours. Would the counting system described in the example above have adequate detection capability to detect a 4 DAC-h exposure? The minimum detectable activity becomes

$$2.71 + 3.29 \frac{\sqrt{11 \times 1 (1 + 1/10)}}{732,600 \times 1} = 1.9\text{E-}5 \mu\text{Ci} \quad (6.14)$$

This is below the desired performance of $4\text{E-}5 \mu\text{Ci}$ (1.5 Bq), so the licensee can conclude that the counting system is adequate. If the minimum detectable activity had been greater than $4\text{E-}5 \mu\text{Ci}$ (1.5 Bq), then the licensee could have chosen to count the sample longer, used a more efficient counter, or chosen a counter with a lower background to reduce the minimum detectable activity until it was less than the desired goal. For other options when the minimum detectable activity is too high, refer to the section on "minimum average concentration."

Normally, measurement results (in terms of count rates) are compared with the decision level or other action levels. The minimum detectable activity, on the other hand, is normally compared with performance goals.

Because it is convenient to think of air-sampling programs in terms of concentrations, not activities, and because there are several other variables to be considered in determining concentrations, a more useful performance indicator for an air-sampling program (as contrasted with a counting system that is only a part of the program) is the minimum detectable concentration, described below.

6.3.4 Measuring Detection Capability for an Air-Sampling Program: Minimum Detectable Concentration

Suppose a licensee wants to set a performance goal for an air-sampling program of being able to detect $0.1 \times \text{DAC}$. Such a choice would ensure that, for workers continuously present in the area, no intakes would occur that would result in a committed effective dose equivalent in excess of 500 mrem/y.

To determine if a program would meet this goal, the licensee may calculate the minimum detectable concentration (MDC) of the equipment and procedures in the program. The MDC for any single measurement is

$$\text{MDC} = \frac{2.71 + 3.29 \sqrt{R_b T_g (1 + T_g/T_b)}}{E F K T_s T_g} \quad (6.15)$$

where the symbols are as defined above.

To have an air-sampling program that meets this detection capability goal, the licensee may select procedures and equipment with values of flow rate, duration of sample collection, filter efficiency, counting efficiency, and gross and background counting times so that the MDC in Equation (6.15) is less than or equal to $0.1 \times \text{DAC}$ (unless a weighted average of sample results for intervals less than 40 hours is used; see below).

EXAMPLE. Using the data given above, calculate the MDC for this scenario.

SOLUTION.

The MDC

$$= 2.71 + 3.29 \frac{\sqrt{11 \text{ cpm} \times 1 \text{ min} \times (1 + 1 \text{ min}/10 \text{ min})}}{.9 (10^4 \text{ cm}^3/\text{min}) (732,600 \text{ cpm}/\mu\text{Ci}) (10 \text{ min})}$$

$$= 2.1\text{E-}10 \mu\text{Ci}/\text{cm}^3 \quad (6.16)$$

This choice of count times, flow rate, filter efficiency, duration of sample collection, counting efficiency, and counting equipment results in an MDC of $2.2 \text{ E-}10 \mu\text{Ci}/\text{cm}^3$. This means that a true concentration of $2.2 \text{ E-}10 \mu\text{Ci}/\text{cm}^3$ would result in a count rate less than 5.7 cpm only 5% of the time.

If the licensee wanted to be able to detect (that is, only miss 5% of the time) $1 \text{ E-}10 \mu\text{Ci}/\text{cm}^3$ (3.7 Bq/mL), then he/she would have to use some combination of longer sample collection time, higher filter efficiency, higher flow rate, longer count time, lower background counting equipment to achieve a lower MDC. In this case, little improvement in filter efficiency can be obtained; liquid scintillation counting might give a higher counting yield, but it might be prohibitively costly; so modifying other parameters is sensible.

6.3.5 MDC for a Mixture of Radionuclides

If the proportion of the total activity of a sample that is due to a specific radionuclide in a mixture is known, the MDC for that radionuclide may be reduced proportionately:

$$\text{MDC}_i = \frac{A_i}{A} \times \text{MDC} \quad (6.17)$$

where A_i/A is the proportion of the total sample activity from radionuclide i .

6.3.6 Checking Counter Background for Non-Random Fluctuations

A licensee may want to use a statistical test called a "chi-squared" (χ^2) test to determine whether the fluctuations in a series of background measurements are consistent with purely statistical fluctuations, or whether the variability in the measurements is greater or less than would be expected due to random fluctuations. For a Poisson process such as background measurements, the χ^2 statistic is

$$\chi^2 = \sum_{i=1}^n \frac{(N_i - \bar{N})^2}{\bar{N}} \quad (6.18)$$

where each of the n background counting results, N_i , came from counting a blank for the same time interval and \bar{N} is the average of N_i (Bevington 1969, Beyer 1984). The result is compared with tabulated values of the χ^2 statistic for $(n - 1)$ degrees of freedom at a specified significance level 2α for a two-tailed test (that is, either too much or too little variability).

If χ^2 is greater than the upper tabulated value, there is more variation in the N_i than would be expected from random statistical fluctuations alone; if χ^2 is less than the lower tabulated value, then there is less variation in the N_i than would be expected from random statistical fluctuations alone.

If χ^2 is too large, there are several possible causes:

1. This was the one time in $1/2\alpha$ (e.g., 1 in 20 for $2\alpha = 0.05$) that random fluctuations were larger than expected. The licensee may want to repeat the χ^2 test for new measurements.
2. The equipment or the power supply is unstable or unreliable. The licensee may need to repair or replace the equipment.
3. Background changed during or between the measurements due to cosmic radiation, radioactive sources being moved in the area, use of radiation-producing machines, changes in radon and radon progeny levels, contamination of the detector, etc.

Evaluation of Sampling Results

If χ^2 is too small, there are several possible causes:

1. This was the one time in $1/2\alpha$ (e.g., 1 in 20 for $2\alpha = 0.05$) that random fluctuations were smaller than expected. The licensee may want to acquire more data and repeat the χ^2 test.
2. There is a nonrandom component of the counts, such as periodic electrical noise in the circuitry or double pulses from single events.
3. Background counts were not random, e.g., the detector is seeing a parent with short-lived progeny so that events come in pairs. (This may only be a problem with high-efficiency detectors.)

The licensee may want to plot the background count rate for a given counter as a function of time to observe whether there are short- or long-term changes. Single points that are several standard deviations above or below the line may be a sign of short-term instability. A non-zero slope over time (e.g., background rate is increasing or decreasing) may indicate gradual increase or decrease in gain, high voltage, etc. An abrupt rise in background may indicate that the counter has become contaminated.

EXAMPLE. During 10 repeated 20-minute counts of background, a licensee observes 48, 29, 40, 44, 35, 39, 46, 45, 43, and 30 counts. Is the variability in the background more or less than expected due to random statistical fluctuations alone?

SOLUTION. Compute a χ^2 statistic and compare it with values tabulated in Table 6.3 for a two-tailed test at $2\alpha = 0.05$. (The data in Table 6.3 have been sorted in ascending order.)

Because the observed χ^2 is between 2.7 and 19, the data have neither too little nor too much variability to be consistent with random fluctuations. The licensee may conclude with confidence that the system is functioning as expected insofar as background is concerned.

6.4 References

Bevington, P. R. 1969. *Data Reduction and Error Analysis for the Physical Sciences*. McGraw-Hill, New York, New York.

Beyer, W. H. 1984. *CRC Standard Mathematical Tables*. 27th ed., CRC Press, Boca Raton, Florida.

Brodsky, A. 1986. *Accuracy and Detection Limits for Bioassay Measurements in Radiation Protection: Statistical Considerations*. NUREG-1156, U.S. Nuclear Regulatory Commission, Washington, D.C.

Currie, L. A. 1968. "Limits for Qualitative Detection and Quantitative Determination." *Analytical Chemistry* 40(3):586-593.

Currie, L. A. 1984. *Lower Limit of Detection: Definition and Elaboration of a Proposed Position for Radiological Effluent and Environmental Measurements*. NUREG/CR-4007, National Technical Information Service, National Technical Information Service, Springfield, Virginia.

Lochamy, J. 1976. "The Minimum Detectable Activity Concept." In: National Bureau of Standards Report, NBS-SP456, pp. 169-172, Washington, D.C.

National Council on Radiation Protection and Measurements. 1985. *A Handbook of Radioactivity Measurements Procedures*. NCRP Report No. 58, 2nd ed, Bethesda, Maryland.

Strom, D. J., and P. S. Stansbury. 1992. "Minimum Detectable Activity when Background Is Counted Longer than the Sample." *Health Phys.* 63(3):360-361.

Table 6.3. Chi² Calculation for the Example^(a)

Observation i	N_i	$N_i - \bar{N}$	$(N_i - \bar{N})^2$	$(N_i - \bar{N})^2/\bar{N}$
1	29	-10.9	118.8	2.98
2	30	-9.9	98.0	2.46
3	35	-4.9	24.0	0.60
4	39	-0.9	0.8	0.02
5	40	0.1	0.0	0.00
6	43	3.1	9.6	0.24
7	44	4.1	16.8	0.42
8	45	5.1	26.0	0.65
9	46	6.1	37.2	0.93
10	48	8.1	65.6	1.64
mean (\bar{N})	39.9			
standard deviation (s)	6.64			
n	10			
degrees of freedom	9			
χ^2 statistic				9.95
$2\alpha = 0.05$, lower limit				2.70
$2\alpha = 0.05$, upper limit				19.02

- (a) The N_i (column 2) are the observed numbers of counts for observation i , \bar{N} is the mean of the data, and s is the sample standard deviation. The differences between the mean and each observation ($N_i - \bar{N}$) are given in column 3, the squared differences in column 4, and the individual contribution to the χ^2 statistic in column 5. Because the χ^2 value of 9.95 falls between the lower limit (looked up in a χ^2 table) of 2.7 and the upper limit of 19, the data have "passed" the test, that is, they have neither more nor less variation than would be expected from random fluctuations in the counting process.

Appendix A

Additional Decision Level Equations

APPENDIX A

A.1 General Form of Equations to Account for Radioactive Decay During Sampling and Counting, or Between Sampling and Counting

The equations in Section 6.3 are valid for the usual case in which the half-life of the radionuclide is much longer than the sample collection time and the counting time. If the half-life is not much longer, then the equations in Section 6.3 must be modified to account for radioactive decay during sample collection and counting.

If $T_s = T_b$, the number of net counts to be used in the formulas below is simply the difference between N_s and N_b :

$$N_n = N_s - N_b \quad (\text{if } T_s = T_b) \quad (\text{A.1})$$

However, if $T_s \neq T_b$, then the number of net counts should be computed using the background count rate:

$$N_n = N_s - R_b T_s \quad (\text{A.2})$$

Under the assumption of constant concentration during sample collection, the concentration of radioactive material in air is given for any combination of times by a general equation of the form

$$C \text{ in } \mu\text{Ci}/\text{cm}^3 \text{ (or Bq}/\text{m}^{-3}) = \frac{\lambda^2 N_n}{\text{EFK}} \frac{1}{(1 - e^{-\lambda T_s}) e^{-\lambda T_b} (1 - e^{-\lambda T_s})} \quad (\text{A.3})$$

where λ denotes the radioactive decay constant in inverse minutes (or s^{-1}) ($\lambda = 0.693/T_{1/2}$), and T_b denotes the decay time between sampling and counting in min (or s), and the other symbols are as previously defined. All time units must be the same in the decay constant, flow rate, and various time quantities (that is, use minutes and per minute throughout, or use seconds and per second throughout).

The formula for the decision level (Equation 6.11) does not change when radioactive decay is taken into account. The formula for the MDC (Equation 6.15) becomes

$$\text{MDC } (\mu\text{Ci}/\text{cm}^3) = \frac{\lambda^2 \left(2.71 + 3.29 \sqrt{R_b T_s (1 + T_s/T_b)} \right)}{\text{EFK} (1 - e^{-\lambda T_s}) e^{-\lambda T_b} (1 - e^{-\lambda T_s})} \quad (\text{A.4})$$

where the symbols are as defined in Table 6.2.

EXAMPLE. A grab sampler is run for 20 minutes in a low radon area to collect a sample of particulate ^{88}Rb ($T_{1/2} = 17.7$ min). It takes 15 minutes to get the sample to the lab, where it is counted for 10 minutes. The gross counts are 300, while a 60-minute background measurement results in 600 counts. The flow rate was 2 cfm and the filter is taken to be 90% efficient. A simulated ^{88}Rb standard showed a counting efficiency of 5E5 cpm/ μCi . What was the concentration of

Appendix A

⁸⁸Rb? What is the decision level for such a counting scenario? What concentration would result in a count rate above the decision level 95% of the time (i.e., the MDC)?

SOLUTION. Clearly, this is a case for the exact formula, because sample collection occurs over more than one half-life, decay between sampling and counting is nearly one half-life, and the count itself lasts for a significant fraction of a half-life. Here,

$$\begin{aligned}\lambda &= 0.693/17.1 \text{ min} = 0.039 \text{ min}^{-1} \\ N_a &= N_s - R_s T_s = 300 - (10 \text{ cpm} \times 10 \text{ min}) = 200 \text{ counts} \\ E &= 90\%/100\% = 0.90 \\ F &= 2 \text{ cfm} \times (30.48 \text{ cm/foot})^3 = 5.7E4 \text{ cm}^3/\text{min} \\ K &= 5E5 \text{ cpm}/\mu\text{Ci} \\ T_s &= 20 \text{ min} \\ T_D &= 15 \text{ min} \\ T_c &= 10 \text{ min}\end{aligned}$$

From Equation (A.3) the concentration of ⁸⁸Rb was

$$\begin{aligned}C &= \frac{(0.039 \text{ min}^{-1})^2 200 \text{ counts}}{(0.90) (5.7E4 \text{ cm}^3/\text{min}) (5E5 \text{ cpm}/\mu\text{Ci})} \\ &\times \frac{1}{(1 - e^{-0.039 \text{ min}^{-1} \times 20 \text{ min}}) e^{-0.039 \text{ min}^{-1} \times 15 \text{ min}} (1 - e^{-0.039 \text{ min}^{-1} \times 10 \text{ min}})} \\ &= \frac{0.039^2 \times 200}{0.9 \times 5.7E4 \times 5E5 \times 0.54 \times 0.56 \times 0.32} \\ &\approx 1.2E-10 \mu\text{Ci}/\text{cm}^3\end{aligned} \tag{A.5}$$

Note that the long half-life Equation (6.9) gives an answer of $3.9E-11 \mu\text{Ci}/\text{cm}^3$, less than one third of the correct answer.

The decision level from Equation (6.11) for this example is

$$\begin{aligned}DL(R_p) &= 1.645 \sqrt{10 \text{ cpm} \times 10 \text{ min} (1 + 10 \text{ min}/60 \text{ min})} \\ &= 1.8 \text{ cpm}\end{aligned} \tag{A.6}$$

Thus, for observed count rates above 1.8 cpm, the licensee decides that there is airborne activity above background. The MDC for this counting situation (Equation A.4) is

$$\begin{aligned}
 \text{MDC} &= \frac{(0.039 \text{ min}^{-1})^2 (2.71 + 3.29 \sqrt{10 \text{ cpm} \times 10 \text{ min} (1 + 10 \text{ min} / 60 \text{ min})})}{(0.90) (5.7\text{E}4 \text{ cm}^3 / \text{min}) (5\text{E}5 \text{ cpm} / \mu\text{Ci})} \\
 &\times \frac{1}{(1 - e^{-0.039 \text{ min}^{-1} \times 20 \text{ min}}) e^{-0.039 \text{ min}^{-1} \times 15 \text{ min}} (1 - e^{-0.039 \text{ min}^{-1} \times 10 \text{ min}})} \\
 &= \frac{0.039^2 \times 38.2}{0.9 \times 5.7\text{E}4 \times 5\text{E}5 \times 0.54 \times 0.56 \times 0.32} \\
 &= 2.4\text{E}-11 \mu\text{Ci} / \text{cm}^3
 \end{aligned} \tag{A.7}$$

This means that the licensee can legitimately claim to be able to detect an activity concentration of $2.4 \text{E}-11 \mu\text{Ci}/\text{cm}^3$. This activity concentration would fail to produce a count rate above the decision level only 5% of the time (i.e., a 5% false negative rate).

A.2 Averaging Multiple Concentration Measurements to Improve Precision and Detection Capability

A licensee can achieve better precision and detection capability by performing appropriate time-weighted averaging of air-sampling results. The better precision and detection capability only apply to an average over many samples, but this may be quite helpful.

- If a 40-hour week is divided into n equal sampling intervals (e.g., five 8-hour air samples are collected to measure the activity in air for a 40-hour week), the MDC for each air sample would have to be $0.1 \times \text{DAC}$ unless concentrations were averaged. If results are not averaged, the $0.1 \times \text{DAC}$ requirement means that the sampling/counting system as a whole would have to be n times more sensitive than it would have to be for a single 40-hour air sample.

The concentration during an air-sampling interval (if there is no decay during sampling and counting or between sampling and counting) is given by Equation (6.9). Ignoring systematic errors, its standard deviation is

$$s_c \text{ in } \mu\text{Ci} / \text{cm}^3 \text{ (or Bq m}^{-3}\text{)} = \sqrt{\frac{\frac{R_b}{T_b} + \frac{R_s}{T_s}}{EFKT_s}} \tag{A.8}$$

Appendix A

For n (not necessarily equal) sampling intervals during a week, the time-weighted average concentration is

$$\bar{C} = \frac{\sum_{i=1}^n T_{s,i} C_i}{\sum_{i=1}^n T_{s,i}} \quad (\text{A.9})$$

and its standard deviation is

$$s_{\bar{C}} = \sqrt{\frac{\sum_{i=1}^n \left[\frac{R_{b,i} + R_{e,i}}{T_{b,i} + T_{e,i}} \right] \frac{1}{E_i^2 F_i^2 K_i^2}}{\left[\sum_{i=1}^n T_{s,i} \right]^2}} \quad (\text{A.10})$$

where the subscripts i denote the ith time, concentration, filter efficiency, count rate, flow rate, or counting efficiency.

If all counting times, background count rates, air-sampling times, filter efficiencies, counting efficiencies, and flow rates are the same, then Equations (A.9) and (A.10) simplify to

$$\bar{C} = \frac{1}{n} \sum_{i=1}^n C_i \quad (\text{A.11})$$

and

$$s_{\bar{C}} = \frac{s_C}{\sqrt{n}} \quad (\text{A.12})$$

The time-weighted average count rate is

$$\bar{R}_n = \frac{\sum_{i=1}^n T_{s,i} R_{n,i}}{\sum_{i=1}^n T_{s,i}} \quad (\text{A.13})$$

and the decision level for a time-weighted average count rate is

$$DL(\bar{R}_n) = 1.65 \sqrt{\frac{\sum_{i=1}^n T_{s,i}^2 \left(\frac{R_{b,i}}{T_{b,i}} + \frac{R_{e,i}}{T_{e,i}} \right)}{\left(\sum_{i=1}^n T_{s,i} \right)^2}} \quad (\text{A.14})$$

If all counting times, background count rates, air sample collection times, filter efficiencies, counting efficiencies, and flow rates are the same, then Equation (A.14) simplifies to

$$DL(\bar{R}_n) = \frac{DL(R_n)}{\sqrt{n}} \quad (\text{A.15})$$

where $DL(R_n)$ for a single air sample is given by Equation (6.11).

The MDC for a time-weighted average of air samples is

$$MDC_{\bar{C}} = \left(\frac{\sum_{i=1}^n T_{s,i}}{\sum_{i=1}^n (E_i F_i K_i T_{s,i}^2)} \right) \left(\frac{2.71}{\sum_{i=1}^n T_{e,i}} \right) + 3.29 \sqrt{\frac{\sum_{i=1}^n \frac{R_{b,i} \left(\frac{1}{T_{b,i}} + \frac{1}{T_{e,i}} \right)}{E_i^2 F_i^2 K_i^2}}{\left(\sum_{i=1}^n T_{s,i} \right)^2}} \quad (\text{A.16})$$

If all counting times, background count rates, air sample collection times, filter efficiencies, counting efficiencies, and flow rates are the same, then Equation (A.16) simplifies to

$$MDC_{\bar{C}} = \frac{2.71}{n E F K T_s T_e} + \frac{3.29 \sqrt{R_b \left(\frac{1}{T_b} + \frac{1}{T_e} \right)}}{\sqrt{n} E F K T_s} \quad (\text{A.17})$$

Appendix A

For numbers of counts large with respect to 2.71, Equation (A.17) can be approximated by Equation (A.18), as follows:

$$\overline{\text{MDC}} \approx \frac{\text{MDC}_1}{\sqrt{n}} \quad (\text{A.18})$$

where MDC_1 is the MDC for a single air sample given by Equation (6.15).

EXAMPLE. In a fuel fabrication facility, breathing zone air-sampling for class Y uranium is performed for workers. Each sampler is worn for 6 h/day, 5 days/week. The samplers operate at 1.8 L/min. After waiting for the decay of radon progeny, the filters are counted for 5 minutes each, and a 20-minute background measurement is made once pershift. The background count rate is stable at 2.0 cpm. The counter efficiency is 40%. The filters have been shown to be 95% efficient for the particle sizes encountered. What is the MDC? What is the minimum detectable average concentration for a week, for a year (50 weeks)?

SOLUTION. The MDC for one sample is

$$\begin{aligned} \text{MDC} &= \frac{2.71 + 3.29 \sqrt{2 \text{ cpm} \times 5 \text{ min} (1 + 5 \text{ min} / 20 \text{ min})}}{(0.95) (1800 \text{ cm}^3 / \text{min}) (890,000 \text{ cpm} / \mu\text{Ci}) (360 \text{ min}) (5 \text{ min})} \\ &= 5.2\text{E}-12 \mu\text{Ci} / \text{cm}^3 \end{aligned} \quad (\text{A.19})$$

This value is below the DAC of $2\text{E}-11 \mu\text{Ci} / \text{cm}^3$. For a 6-hour sample, the minimum detectable exposure is

$$\begin{aligned} \text{Exposure in DAC -h} &= \frac{5.2\text{E}-12 \mu\text{Ci} / \text{cm}^3}{2\text{E}-11 \mu\text{Ci} / \text{cm}^3 \cdot \text{DAC}} \times 6 \text{ h} \\ &= 1.6 \text{ DAC -h} \end{aligned} \quad (\text{A.20})$$

For 5 days, the sum of the minimum detectable exposures would be 8 DAC-h, above the performance goal of 4 DAC-h in a 40-hour period. The licensee can meet the performance goal by averaging concentrations as described below.

In five 5-minute counts at 2 cpm, 50 counts are expected due to background. Because 50 is large with respect to 3, the simple formula Equation (A.18) will be adequate for the week-long average. The $\overline{\text{MDC}}$ for 1 week is

$$\overline{\text{MDC}} \approx \frac{\text{MDC}_1}{\sqrt{5}} = 2.3\text{E}-12 \mu\text{Ci} / \text{cm}^3 \quad (\text{A.21})$$

and the exposure is $5 \text{ days} \times 6 \text{ h/day} \times 2.3\text{E-}12/2\text{E-}11 = 3.5 \text{ DAC-h}$, within the desired performance goal. The MDC for 50 5-day weeks (250 days) is

$$\text{MDC} \approx \frac{\text{MDC}_1}{\sqrt{250}} = 3.3 \text{ E-}13 \mu\text{Ci/cm}^3 \quad (\text{A.22})$$

corresponding to an exposure of $250 \text{ days} \times 6 \text{ h/day} \times 3.3\text{E-}13/2\text{E-}11 = 24.8 \text{ DAC-h}$ over a year. An average of 25 DAC-h in a 50-week calendar year is only 0.5 DAC-h/week, well within the licensee's performance goal of 4 DAC-h in a week.

The results of this example are shown in Table A.1. Treating each sample individually does not permit the licensee to optimize use of the available information. Averages of 5 or 250 samples provide lower minimum detectable exposures (in DAC-h) and lower minimum detectable dose equivalent values (in mrem) over a year. This improved precision is obtained because the random statistical fluctuations tend to cancel out over a year.

Table A.1. Comparison of MDC , Exposure, and Minimum Detectable Dose for One-, Five-, and 250-Sample Averages

Average Over Group of	Minimum Detectable Average Concentration (MDC) ($10^{-12} \mu\text{Ci/cm}^3$)	Minimum Detectable Exposure (DAC-h)	Minimum Detectable Dose per group (mrem)	Minimum Detectable Dose per year (mrem)
1 sample	5.2	1.6	3.9	984
5 samples	2.3	3.5	8.8	440
250 samples	0.33	25	62	62

BIBLIOGRAPHIC DATA SHEET

(See instructions on the reverse)

1. REPORT NUMBER
(Assigned by NRC. Add Vol., Supp., Rev.,
and Addendum Numbers, if any.)

NUREG-1400

2. TITLE AND SUBTITLE

Air Sampling in the Workplace

Final Report

3. DATE REPORT PUBLISHED

MONTH YEAR

September 1993

4. FIN OR GRANT NUMBER

5. AUTHOR(S)

E.E. Hickey*, G.A. Stoetzel*, D.J. Strom*,
G.R. Cicotte*, C.M. Wiblin**, S.A. McGuire

6. TYPE OF REPORT

7. PERIOD COVERED (Inclusive Dates)

8. PERFORMING ORGANIZATION - NAME AND ADDRESS (If NRC, provide Division, Office or Region, U.S. Nuclear Regulatory Commission, and mailing address; if contractor, provide name and mailing address.)

Division of Regulatory Applications *Pacific Northwest Laboratory
Office of Nuclear Regulatory Research Richland, WA 99352
U.S. Nuclear Regulatory Commission **Advanced Systems Technology, Inc.
Washington, D.C. 20555 3490 Piedmont Road, NE, Atlanta, GA 30305

9. SPONSORING ORGANIZATION - NAME AND ADDRESS (If NRC, type "Same as above"; if contractor, provide NRC Division, Office or Region, U.S. Nuclear Regulatory Commission, and mailing address.)

Division of Regulatory Applications
Office of Nuclear Regulatory Applications
U.S. Nuclear Regulatory Commission
Washington, D.C. 20555

10. SUPPLEMENTARY NOTES

11. ABSTRACT (200 words or less)

This report provides technical information on air sampling that will be useful for facilities following the recommendations in the NRC's Regulatory Guide 8.25, Revision 1, "Air Sampling in the Workplace." That guide addresses air sampling to meet the requirements in NRC's regulations on radiation protection, 10 CFR Part 20. This report describes how to determine the need for air sampling based on the amount of material in process modified by the type of material, release potential, and confinement of the material. The purposes of air sampling and how the purposes affect the types of air sampling provided are discussed. The report discusses how to locate air samplers to accurately determine the concentrations of airborne radioactive materials that workers will be exposed to. The need for and the methods of performing airflow pattern studies to improve the accuracy of air sampling results are included. The report presents and gives examples of several techniques that can be used to evaluate whether the airborne concentrations of material are representative of the air inhaled by workers. Methods to adjust derived air concentrations for particle size are described. Methods to calibrate for volume of air sampled and estimate the uncertainty in the volume of air sampled are described. Statistical tests for determining minimum detectable concentrations are presented. How to perform an annual evaluation of the adequacy of the air sampling is also discussed.

12. KEY WORDS/DESCRIPTORS (List words or phrases that will assist researchers in locating the report.)

Air Sampling
Regulatory Guide 8.25
Airborne Radioactive Materials

13. AVAILABILITY STATEMENT

Unlimited

14. SECURITY CLASSIFICATION

(This Page)

Unclassified

(This Report)

Unclassified

15. NUMBER OF PAGES

16. PRICE