



altherma

ALL-IN-ONE, YEAR-ROUND HEATING,  
COOLING AND DOMESTIC HOT  
WATER SUPPLY SOLUTION

**DAIKIN**  
altherma

# HEAT PUMP SOLUTION TO FIT BOTH NEW BUILD HOMES AND THE HARDER TO HEAT OLDER PROPERTIES

## High Quality, Innovative Products

Innovation and quality are constantly at the forefront of Daikin's philosophy. Daikin's systems provide highly efficient solutions, which minimize the impact on the environment and running costs.

### Daikin Altherma™ Advantages over Traditional Boiler Systems

- ✓ 30 – 50% reduction in CO<sub>2</sub> emissions
- ✓ Low running and maintenance costs
- ✓ Low noise – unobtrusive and quiet
- ✓ Easy to install, no groundwork i.e. trenches or boreholes
- ✓ Ideal for off gas grid properties
- ✓ Single phase power supply with low starting current
- ✓ Flexible, can be connected to underfloor heating, low temperature radiators or fan coils
- ✓ Advanced Energy Saving Features
  - Outdoor reset built in as standard
  - Inverter Technology
- ✓ Excellent option for net zero home- with thermal solar domestic hot water production and inverter driven compressor compatibility with photovoltaic solar.



### DID YOU KNOW...

Renewable heating and hot water solutions help save money and also help the environment



COOLING

HEATING

## 3 IN 1 SYSTEM

## FOR NEW CONSTRUCTION

## & RENOVATION

- MORE COMFORT
- LOW ENERGY CONSUMPTION
- FEWER CO<sub>2</sub> EMISSIONS



DOMESTIC HOT WATER PRODUCTION

1. **DAIKIN altherma**<sup>™</sup> Page 4  
THE 3 IN 1 GUARANTEE  
FOR ABSOLUTE COMFORT
2. **DAIKIN altherma**<sup>™</sup> Page 6  
THE BASICS
3. **DAIKIN altherma**<sup>™</sup> Page 10  
TECHNICALLY
4. **DAIKIN altherma**<sup>™</sup> Page 18  
ECONOMICALLY
5. **DAIKIN altherma**<sup>™</sup> Page 19  
APPLICATIONS
6. **DAIKIN altherma**<sup>™</sup> Page 24  
TECHNICAL SPECIFICATIONS
7. **DAIKIN altherma**<sup>™</sup> Page 30  
THE SOFTWARE



# 1. THE 3 IN 1 GUARANTEE FOR ABSOLUTE COMFORT

Daikin Altherma™ is an innovative system that **heats**, produces **domestic hot water** and can even **cool** spaces. Daikin Altherma offers your customer maximum comfort the whole year through.

These heat pumps are also an interesting alternative for classic gas or fuel oil heating as they offer your customers unique benefits:

- They use renewable energy sources (such as outside air)
- They deliver considerable savings in energy
- They deliver a significant contribution in the fight against CO<sub>2</sub> emissions
- They can provide heating, cooling and domestic hot water

## ENERGY EFFICIENT OPERATION

The air-to-water heat pump from Daikin uses a sustainable energy source. In fact, it extracts heat from the outside air. The system consists of a closed circuit containing R-410A refrigerant. A thermodynamic cycle is created through evaporation, condensation, compression and expansion. A heat pump “pumps” heat from a low to a high temperature level. The heat raised is transferred to the water distribution system (under floor heating, low temperature radiators and/or fan coil units) in the home via a heat exchanger.

Depending on the model and the conditions, a Daikin Altherma air-to-water heat pump delivers between 3 and 5 kWh of usable heat for every 1 kWh of electricity it uses. That’s a great ratio from 3:1 - 5:1!

Renovating your heating system and wanting to reduce your energy costs? Interested in a heating solution with lower energy costs? The heat pump is currently the most efficient indoor comfort system on the market: a cutting-edge technology with clear benefits for you and the environment.

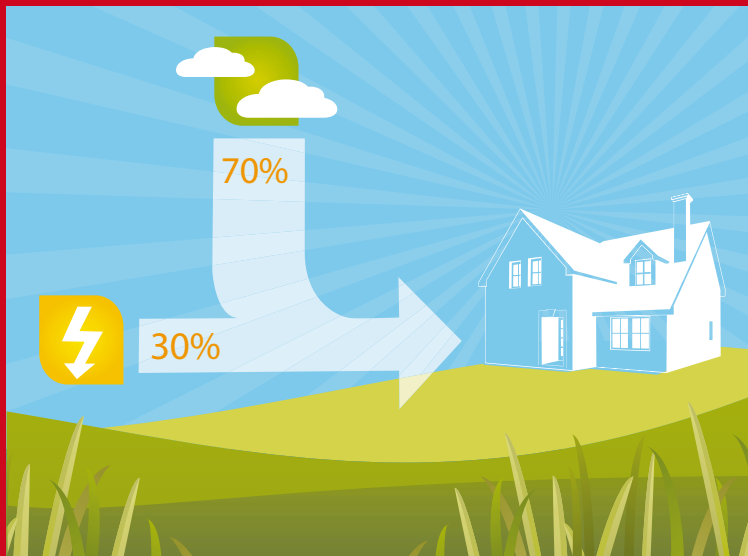

## DAIKIN HEAT PUMP EXPERIENCE

Daikin has more than 50 years of experience with heat pumps, and supplies more than one million of them to homes, shops and offices each year. This success is not just a quirk of fate: Daikin has always been at the cutting edge of technology and its goal is to provide you with turn-key comfort. Only a market leader can guarantee you this level of service and quality control!

## HIGH EFFICIENCY MEANS LOW ENERGY COSTS

Heating system efficiency is measured using the Coefficient of Performance (COP), which is the ratio of heat produced to energy consumed.

# DAIKIN OFFERS THE COMPLETE RENEWABLE SOLUTION FOR HOME HEATING AND HOT WATER

## Daikin Altherma™ Benefits for New Construction and Retrofit Installations

- ✓ Cost effective installations
- ✓ Inverter technology and weather compensation as standard
- ✓ Low energy consumption
- ✓ Reduced CO<sub>2</sub> emissions
- ✓ Safe, easy to maintain and comfortable all year round
- ✓ No extensive ground works
- ✓ No Flues, fuel lines or fuel tanks
- ✓ Providing all your heating and hot water needs throughout the year
- ✓ A fully packaged heat pump system – no hidden ‘extras’
- ✓ Superior technology ensuring performance is unaffected in a cool climate, in fact even as low as -4°F (-20°C)

### How Heat Pumps Work

A “Heat Pump” is a mover of heat, utilizing the available renewable heat from the outside air. It works on the same principle as a refrigerator, but in reverse!

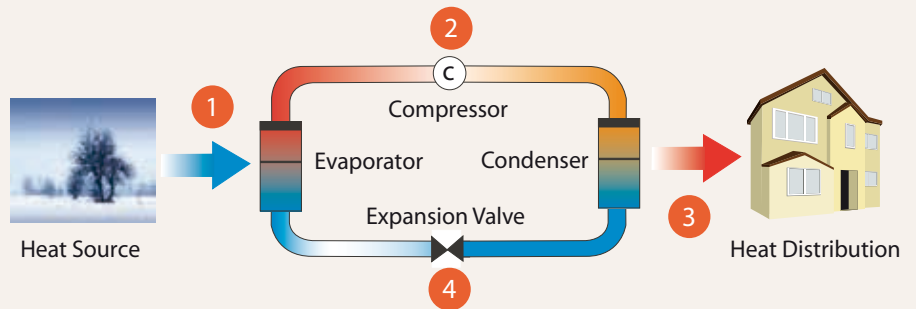

#### 1 STAGE ONE

The heat transfer medium (the refrigerant) is colder than the heat source (the outside air). As the outside air passes across the first heat exchanger (the evaporator) the liquid refrigerant absorbs the heat and evaporates.

#### 2 STAGE TWO

The vapor then passes to the compressor and is compressed. When compressed the pressure is increased and the temperature of the vapour rises, effectively concentrating the heat.

#### 3 STAGE THREE

The hot vapor passes to the second heat exchanger (the condenser) where the heat is rejected and the vapor condenses back into a liquid. In the case of Altherma the rejected heat is passed into the water of the central heating and hot water system ready for use in the home.

#### 4 STAGE FOUR

The liquid refrigerant then passes through an expansion valve, reducing its pressure and temperature, ready to start the whole cycle once again.

## ↗ DID YOU KNOW THAT...

Air source heat pumps provide 3-5kW of energy for every 1kW of electricity used

# DAIKIN 2.THE BASICS

## altherma

Daikin offers you the choice between a Daikin Altherma™ system with an outdoor unit and indoor unit, or a Daikin Altherma™ Monobloc System, in which the hydrobox components are located within the outdoor unit. The Daikin Altherma™ is a low temperature heating system optimized to work with radiant floor heating.

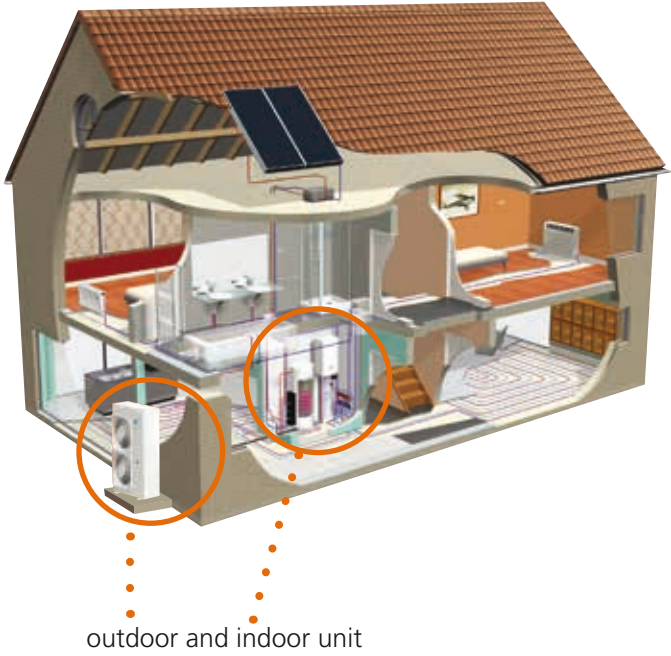
	DAIKIN ALTHERMA™ SPLIT TYPE
Application	Heating and (optional) cooling (+ domestic hot water)   <p style="text-align: center;">outdoor and indoor unit</p>
Heat pump type	Outdoor (compressor) unit + Indoor (hydronic parts) unit
R-410A refrigerant piping	Between outdoor unit and indoor unit
H <sub>2</sub> O piping	Between indoor unit and indoor heating appliances
Installer's advantages	No extra insulation of H <sub>2</sub> O piping required to protect from freezing up

The Split system can be combined with:

- Under floor heating
- Fan coil units
- Low temperature radiators, to provide your customers the comfort they require.

In addition, the Split system can be connected to:

- A domestic hot water tank to supply your customer's hot water needs
- Solar collectors, with optional solar kit, to compliment the production of hot water
- A room thermostat, to regulate the ideal temperature easily, quickly and conveniently.

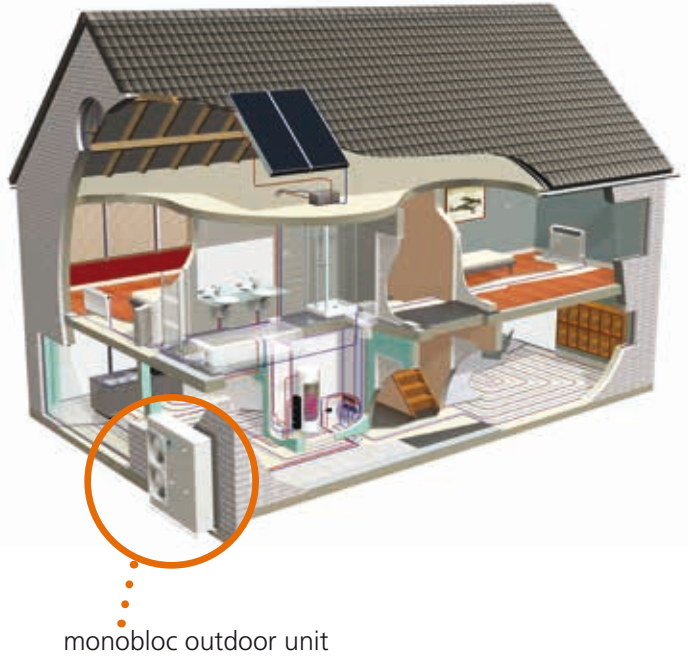
	<b>DAIKIN ALTHERMA™</b> <b>MONOBLOC</b>
Application	Heating and (optional) cooling (+ domestic hot water) 
Heat pump type	Outdoor unit only (compressor and hydronic parts combined)
R-410A refrigerant piping	Inside outdoor unit
H <sub>2</sub> O piping	Between outdoor unit and heating terminal units
Installer's advantages	Only H <sub>2</sub> O piping needed to install the system

The monobloc system can be combined with:

- Under floor heating
- Fan coil units
- Low temperature radiators, to provide your customer the comfort they require.

In addition, the monobloc system can be connected to:

- A domestic hot water tank to supply your customer's hot water needs
- Solar collectors, with optional solar kit, to compliment the production of hot water
- A room thermostat, to regulate the ideal temperature easily, quickly and conveniently.



## AIR-TO-WATER HEAT PUMP

The system consists of 5 components which work together to provide the ideal comfort and water temperature.

### 1A/ OUTDOOR UNIT : AN EFFICIENT USE OF ENERGY FROM THE AIR



Daikin Altherma uses a natural source of energy. The outdoor unit extracts heat from the outside air and transfers it inside through refrigerant piping to supply heating. The compact outdoor unit is easily installed and, as no drilling or excavation work is required, it can also be installed in condos and apartments.

### 1B/ HYDROBOX : THE HEART OF THE DAIKIN ALTHERMA™ SYSTEM

The hydrobox heats the water that circulates through low temperature radiators, floor heating systems or fan coil units and also provides domestic hot water. If you opt for the combination of heating and cooling, then the hydrobox can also reverse the cycle to provide lower water temperatures and thus cooling to the home.

### 2/ DOMESTIC HOT WATER TANK : FOR LOW ENERGY CONSUMPTION

As for your domestic hot water, Daikin Altherma is just as clever. The unique lay-out and special placement of the system components maximize energy efficiency. The water inside the storage tank is primarily warmed up by thermal energy from the outside air, thanks to a heat exchanger connected to the heat pump. However, an additional electrical heating element in the domestic water tank can take care of extra heat required in the shower, tub or sink. At necessary intervals the water

is automatically heated to 158°F or more to prevent the risk of bacteria growth. With Daikin Altherma, delightfully warm and perfectly safe water can be enjoyed at all times. Depending on the daily consumption of hot water, Daikin Altherma domestic hot water tanks are available in two different sizes.

- 1A/ USING HEAT PUMP TECHNOLOGY
- 2B/ WITH SOLAR KIT OPTION

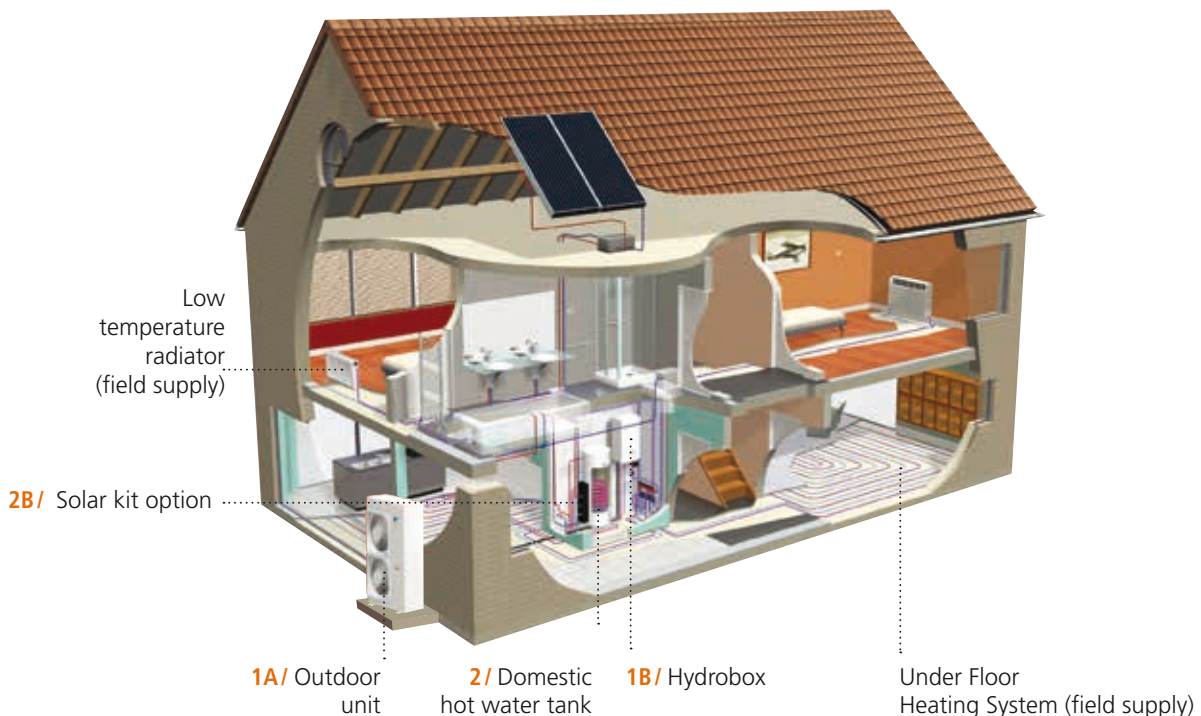



### 3/ MONOBLOC OUTDOOR UNIT: ALL IN ONE

In addition to Daikin Altherma Split type systems, Daikin has a monobloc version in which the hydrobox components are located within the outdoor unit. In this new system, the water pipes, rather than refrigerant

lines, run indoors from the outdoor unit, making installation much quicker and easier for the installer.

### 4/ SOLAR CONNECTION KIT

Averaged over an entire year, the sun delivers half of the energy we need to bring our domestic water up to the desired temperature for free. Your customer can use this solar energy by connecting a solar kit to his Daikin Altherma system. A solar kit is a thermal solar-energy system whereby solar rays are transformed into heat. The heat is then stored in a water supply tank.

#### 4A/ SOLAR COLLECTOR PANEL (FIELD SUPPLY)

The high-efficiency collectors transfer all the short-wave solar radiation into heat as a result of their highly selective coating. The collectors can be mounted on the roof tiles.

#### 4B/ SOLAR PUMP STATION (FIELD SUPPLY)

Typical pump stations are equipped with safety valve, pressure gauge and connection for expansion vessel, and flow and return temperature indication. A digital temperature difference controller with plain text is also included. The Solar yield (kWh) is measured by a sensor. Pump speed is controlled by the solar intensity to ensure maximum efficiency. The heat pump is disabled during solar heating as solar energy gets the first priority, which ensures system protection and maximum efficiency.

### 5A/ HYDRONIC FAN COIL UNIT-EFWT (OPTION)

For Hydro-Air or traditional forced air applications, the high efficiency hydronic fan coil unit can be used to meet your comfort needs.

### 5B/ DAIKIN THERMOSTAT-EKRTWA

With the wired room thermostat, the ideal temperature can be easily, quickly and conveniently regulated. (Daikin Altherma room thermostat is for radiant applications only)

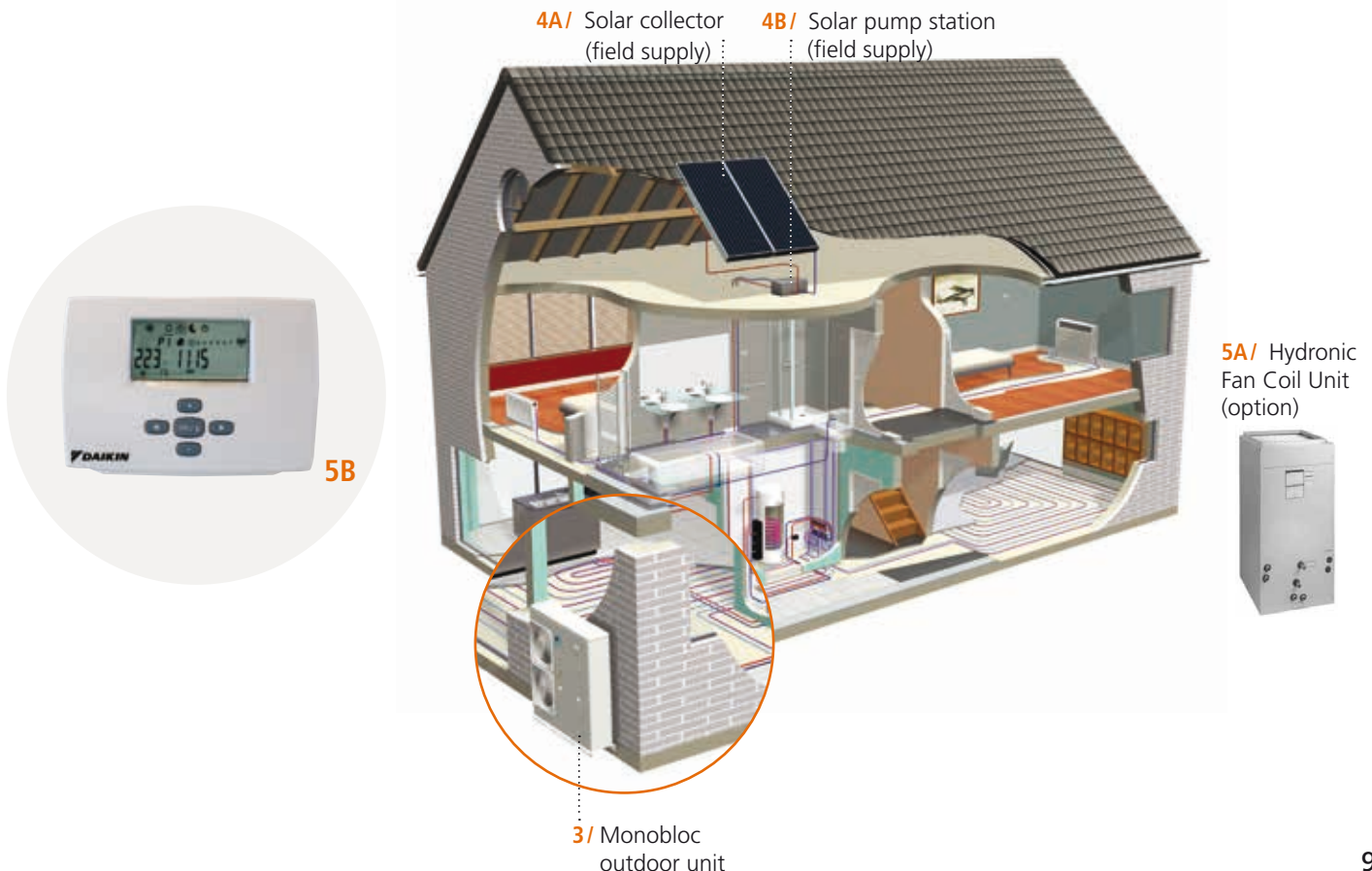

## 1 - DAIKIN ALTHERMA™ SPLIT TYPE AIR-TO-WATER HEAT PUMP

### THE OUTDOOR UNIT

- Compact, weather-resistant and easy to install
- Contains an inverter controlled compressor for energy efficiency and precise temperature regulation
- Heat pump operation range: heating and domestic hot water to -4°F (-20°C) outside temperature

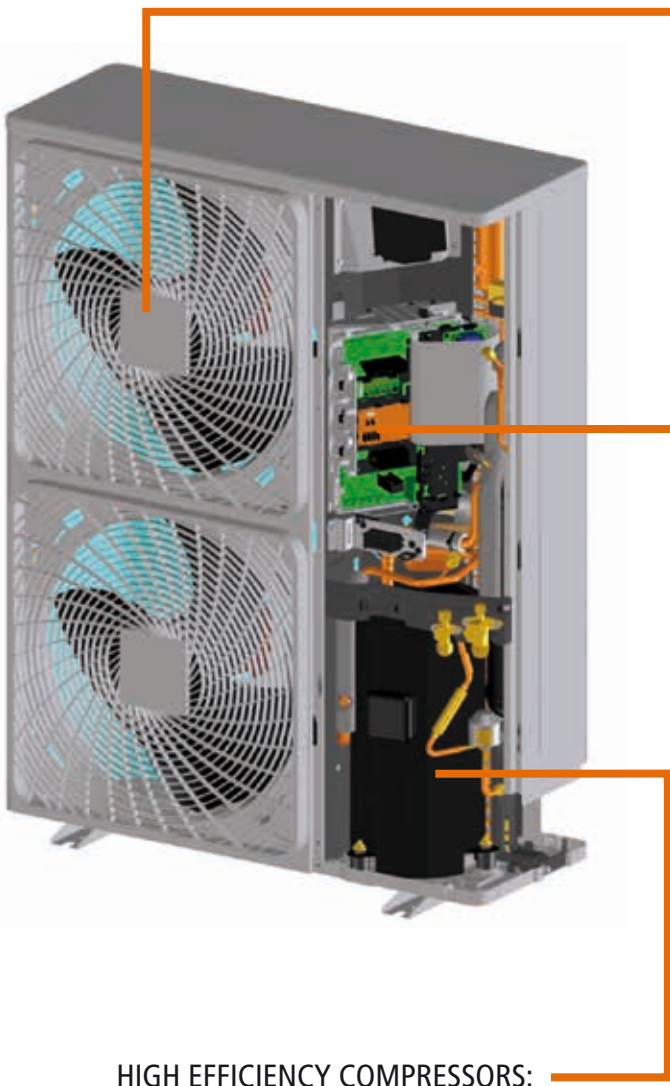

### HEAT EXCHANGER ANTI-CORROSION TREATMENT

As standard, the heat exchanger in the outdoor unit is provided with an anti-corrosion treatment. This treatment guarantees and noticeably increases the resistance against acid rain and salt corrosion.



### SUPER PERFORMANCE THANKS TO THE INVERTER PRINCIPLE

The coefficient of performance (COP) of the Daikin Altherma heat pump is also largely attributable to the Daikin inverter principle. An integrated frequency-converter adjusts the rotational speed of the compressor to suit the heating demand. Therefore, the system seldom operates at full capacity and your customer only pays for the energy which they actually need.

#### Heating operation:

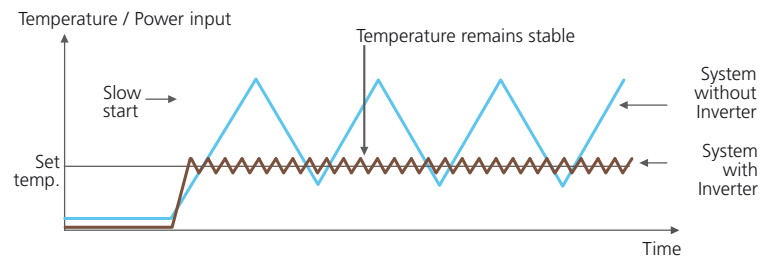

### HIGH EFFICIENCY COMPRESSORS:



The **scroll-compressors** are designed as a compact, robust, low-noise device to guarantee optimal operational reliability (no valves and built-in swing-link coupling) and efficiency (through a low initial flow and a constant compression ratio). It uses Pulse Width Modulation (PWM) Technology.



The **swing-compressors** have been setting trends in the area of energy efficient performance for the past 10 years (leaks and friction are basically non-existent). The design of the swing compressor reduces friction during operation for smoother and quieter rotation with less vibration resulting in a more durable compressor. It also minimizes the leakage of refrigerant gas during compression. The result is a system that operates quietly and efficiently. It uses Pulse Amplitude Modulation (PAM) Technology. The PAM Control reduces energy loss by controlling how often the converter switches on and off.

## HYDROBOX

- Available in two versions: EKHBH for heating only, EKHBX for heating and cooling
- Built-in electric back-up heater for additional heating during extremely cold outdoor temperatures or as back-up in case of problems with the outdoor unit
- 2 shut-off valves to assemble the water outlet and inlet
- Compact and easy to install: all components are pre-assembled, all parts are easy to reach for maintenance. Wall-mounting is comparable to a traditional gas heater.

1. Heat exchanger
2. Expansion tank (2.64 gal.)
3. Circulator
4. Tank with back-up heating
5. Air purge valve
6. Refrigerant liquid connection
7. Refrigerant gas connection
8. Water inlet connection
9. Water outlet connection
10. Pressure gauge (water circuit)
11. Water filter
12. Pressure relief valve
13. User interface
14. Switch box
15. Flow switch

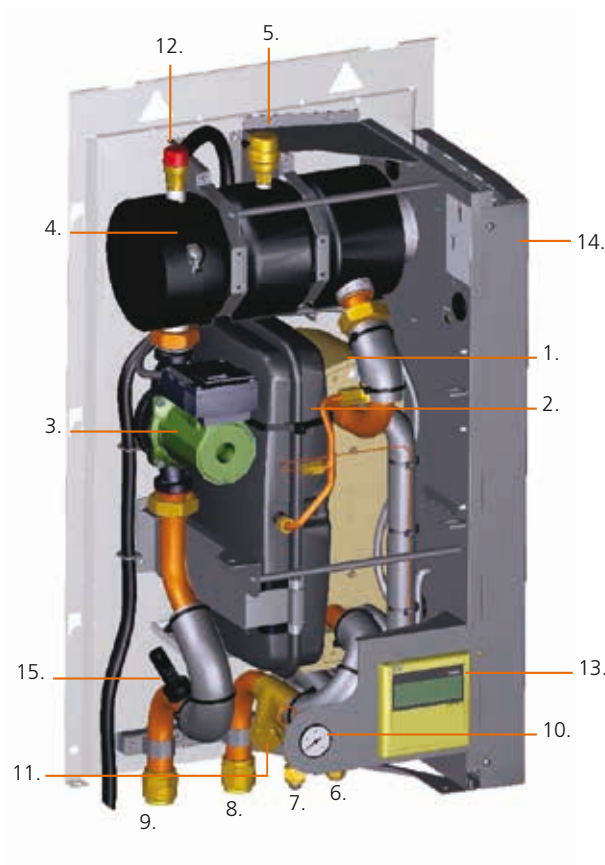

## EXTRA POSSIBILITIES THANKS TO THE INDOOR UNIT...

### Heating and Cooling

If you choose Daikin Altherma with an indoor unit EKHBX, it can not only heat the house, but also cool it. The heat pump is then equipped with a reversible 4-way valve, whereby the refrigeration cycle is reversed and heat is removed from the rooms. The indoor unit can cool rooms via under floor cooling or fan coil units.

### Set temperature limits

To prevent incorrect manual adjustments, temperature limits can be implemented for both cooling and heating. With under floor heating, for example, it is important that the temperature of the water is controlled to the type of floor element. To prevent condensation problems, the temperature for floor cooling can never be lower than 64.4°F (18°C). For fan coil units, the water temperature can be allowed to decrease to 41°F (5°C).

## THE USER INTERFACE

With the easy to reach digital user interface in the indoor unit, controlling the Daikin Altherma system is also simple for your customer. The display offers a great deal of useful information:

- Day of the week
- Time
- Operating mode  
(heating or cooling, heating domestic hot water, low-noise operating outdoor unit)
- Compressor operation
- Pump operation
- Back-up operation
- Booster heating operation  
(in the hot water tank)
- Error codes for alarm
- Temperature  
(outdoor temperature, temperature in hot water tank, leaving water temperature at indoor unit exit)



## DID YOU KNOW...

Your customer can select a maximum of five time periods each day during which the following functions will or will not be activated:

- Low-noise operation of the outdoor unit
- Electric booster heater in the hot water tank
- Heating of the domestic water
- Reduction of the water temperature

The five time periods per function are repeated daily. Your customer can still manually adjust the system when he stays home unexpectedly or stays up later. These settings are automatically switched off at the next programmed event.



## 2 - DAIKIN ALTHERMA™ MONOBLOC AIR-TO-WATER HEAT PUMP

- All hydronic parts are located within the outdoor unit
- H<sub>2</sub>O piping between outdoor unit and indoor heating apparatus

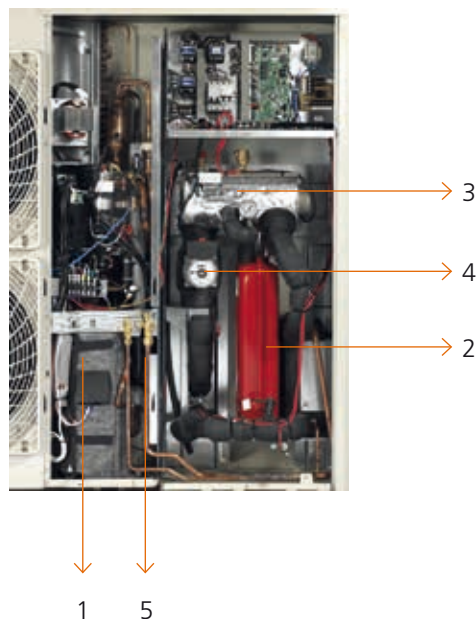

1. High efficiency compressor
2. Expansion tank
3. Tank with back up heating
4. Pressure gauge (water circuit)
5. Refrigerant connection

### ↗ DID YOU KNOW...

In order to protect the water pipes from freezing up during winter, insulation is provided for all hydronic components and special software has been applied to activate the pump and back-up heater if necessary. This prevents the water temperature from dropping below freezing point and can minimize the need for the addition of glycol to the water pipes.

- **The Daikin Altherma™ monobloc is available in different versions**

- heating only or heating and cooling
- with bottom plate heater
- single phase
- 35MBH, 48MBH, or 54MBH

- **Built-in electric back-up heater** for additional heating during extremely cold outdoor temperatures. The Daikin Altherma Monobloc is standard equipped with a 6 kW back-up heater, which can be adjusted to 3 kW.

If necessary, an "in line" back-up heater of 6 kW can be mounted indoors (also adjustable to 3 kW or 3.5 kW)

- The **scroll-compressors** provided are designed as a compact, robust, low-noise device to guarantee optimal operational reliability (no valves and built-in swing-link coupling) and efficiency (through a low initial flow and a constant compression ratio).



### 3 - THE DOMESTIC HOT WATER TANK

- Available in 2 capacities: 50 and 80 gallons for floor mounted installation.
- Stainless steel design.
- 1 37/64" cfc-free insulation material (polyurethane).
- Contains 2 heating elements: a heat exchanger at the bottom where the hot water from the hydrobox circulates and an extra 3 kW electric heater at the top.
- A thermistor in the hot water tank controls a 3-way valve and/or booster heater via the hydrobox.



1. Field supplied fitting
2. Temperature and Pressure relief valve (field supplied)
3. Hot water connection (H)
4. Field supplied fitting
5. Electrical box
6. Electrical box lid
7. Recirculating pump connection
8. Thermistor socket
9. Flow inlet connection (F) (from main unit)
10. Heat exchanger coil
11. Return outlet connection (R) (to main unit)
12. Cold water connection
13. Threaded hole for use with solar kit option.  
(Refer to the Installation manual EKSOLHWBAVJU).
14. Anode rod
15. Thermal protectors (Q2L, Q3L)
16. Booster Heater

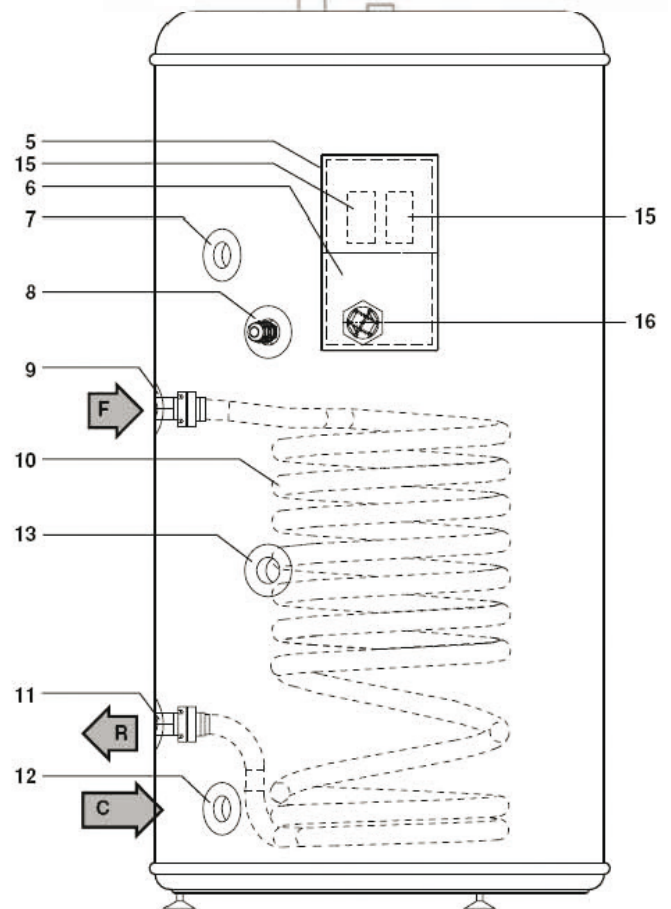
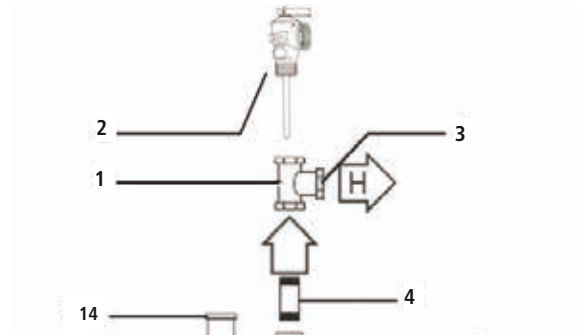
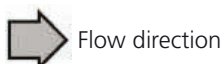

## MULTIFUNCTIONAL HOT WATER TANK ...

### ■ Stainless steel

Daikin offers a tank made of stainless steel equipped with a sacrificial rod to protect the tank against corrosion.

### ■ Anti-bacteria function

To prevent the development of bacteria, the hot water tank is equipped with an anti-bacteria function. You can set up the program so the water is heated to a specific temperature (standard setting = 158°F (70°C) at a set time on one or more days of the week.

### ■ Flexible control

It is possible to set “priority setting” for the production of domestic hot water. In this way the customer has domestic hot water available at any time of the day.

The heating of the domestic hot water can also be set up according to the night tariff. Another opportunity for rational energy consumption.

### ■ Regulating switch-on and shut-off temperatures

You personally set the minimum and maximum temperature when the water in the tank must be heated by the heat pump for the customer.

### ■ Delaying booster heater switch-off

To prevent the booster heater from switching on and off too often, you can allow the system to switch off as soon as the temperature reaches a maximum of 39°F (22°C) higher than the set temperature.

### ■ Allowing back-up heater and booster heater to work separately

Programming the system to prevent the simultaneous operation of the back-up heater and the booster heater is also possible. An interesting possibility for homes with a limited current amp load!

### ■ No natural gas or fuel oil connection or exhaust fume channel required.



## DID YOU KNOW...

Your customers with a solar boiler can enjoy wonderful hot water at any time, even when the sun is not shining? An integrated re-heater is included in the system to help the sun on cloudy days.

## 4 - SOLAR CONNECTION

### SOLAR THERMAL DOMESTIC HOT WATER (DHW)

Averaged over an entire year, the sun delivers half of the energy we need to bring our domestic water up to the desired temperature for free. Your customer can use this solar energy by connecting a solar kit to the Daikin Altherma system. A solar kit is a thermal solar-energy system, whereby solar rays are transformed into heat. The heat is then stored in a water supply tank.

### SOLAR KIT

The solar kit provides the transfer of solar heat to the Daikin Altherma hot water tank via an external heat exchanger. In contrast to tanks with two heat exchangers, this system allows the entire content of the tank to be efficiently heated with solar heat and, if necessary, with heat pump energy.

### SOLAR THERMAL SYSTEM

High-efficiency collectors transfer all the short-wave solar radiation into heat as a result of their highly selective coating. The collectors can be mounted on the roof tiles. The solar kit controller and 3rd party pump station provide the transfer of solar heat to the Daikin Altherma domestic hot water tank via an external heat exchanger. In contrast to tanks with two heat exchangers, this system allows the entire content of the tank to be efficiently heated with solar heat and, if necessary, with heat pump energy.



### Daikin Altherma™ when used with a solar thermal package

- Solar collector (field supply)
- Plumbing network and solar pump station (field supply)
- Supply tank: standard Daikin Altherma™ domestic hot water tank
- Solar kit
- Auxiliary (Daikin Altherma™ heat pump unit, which also provides the home with heating)



1. Solar collector (Flat plate collector) (field supply)
2. Hydrobox
3. Domestic Hot Water Tank
4. Solar kit
5. Solar pump station (field supply)



## 5A - HYDRONIC FAN COIL UNIT - EFWT

The Hydronic Fan Coil Unit has been engineered to provide an effective solution in combination with the "Low Temperature" Daikin Altherma system. High efficiency and comfort are delivered and allow your application to blend into the environment using the traditional ductwork for Heating and Cooling air distribution.

- Single A-Coil configured for Hydronic Heating and Cooling Operation
- ECM fan motor for improved sound levels and energy savings
- Flexible installation with Upflow, Horizontal L and Horizontal R configuration possible
- Factory installed MERV 8 Filter for cleaner indoor air (throwaway type)
- Minimal cabinet dimensions with 1/2" TUF-SKIN Cabinet Insulation
- Option electric heat integrated fan coil units also available
- Works with most conventional 24 volt thermostats



## 5B - DAIKIN ROOM THERMOSTAT - EKRTWA

The large LCD screen on the room thermostat indicates all the necessary information regarding the setting of the Daikin Altherma system in a blink of an eye. The user can also easily navigate between the different menus whose most common functions and modes include:



- Radiant Applications Only Solution (no fan control). For fan control, third party stat required
- Setting the temperature of the room based on measurements from the built-in sensor
- Cooling and heating mode
- Off function (with integrated frost-protection function)
- Vacation function mode
- Comfort and reduced function modes
- Time (day and month)
- Programmable weekly timer with 2 standard and 5 pre-set programs
- Keylock function
- Setting limits. The installer can change the upper and lower limits

Functions	Wired room thermostat EKRTWA
Heating only	✓
Heating and cooling	✓
Comfort function mode	✓
Reduced function mode	✓
Scheduled function mode	✓
Number of setpoint changes	12/day
Holiday function mode	✓
Off function	✓
Setpoint limitation	✓
Keylock function	✓

### ↗ DID YOU KNOW THAT...

Daikin has set up a number of monitoring sites (in Europe, Oregon, New Hampshire, Alaska, ...), where Daikin Altherma has been tested under totally different climate conditions. High satisfaction has been achieved with increased comfort, stable indoor temperature, low energy consumption and hot water always available... whatever the weather conditions at the monitoring site.



## How We Use Energy in Our Homes

Heating and cooling account for the largest portion of a typical utility bill.

Source: 2007 Buildings Energy Data Book, Table 4.2.1., 2005 energy cost data.

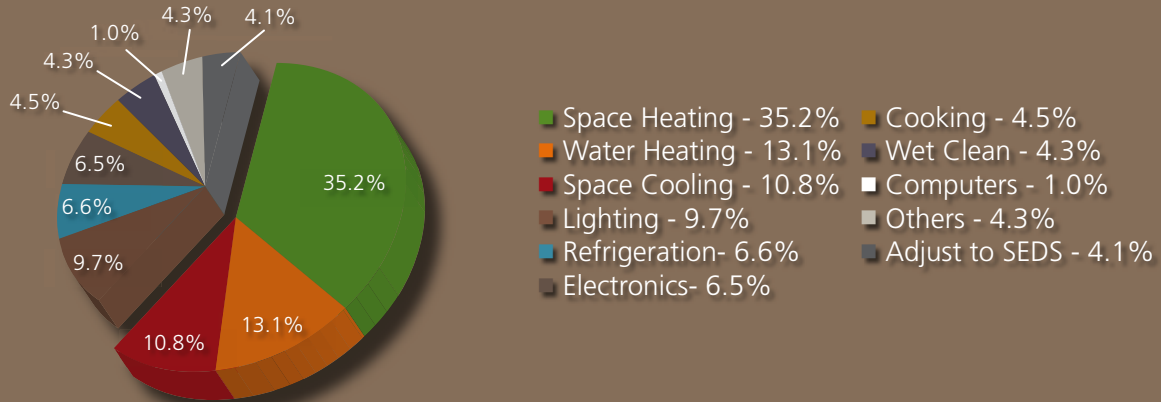

- Customers today are, more than ever, conscious of the cost of heating.
- There is not only the increasing cost of fuel oil and natural gas, but also the limited supply of fossil fuels and the problem of CO<sub>2</sub> emissions.
- Energy efficient heating solutions are gaining in popularity.
- Daikin Altherma™ debuted in Europe in 2006 and since then has demonstrated significant economical advantages over traditional systems as highlighted on the following graphics:

### 1. 66 To 80% Additional Heat

A heat pump boiler works more efficiently and saves more energy than a traditional heating system using fossil fuel. Daikin Altherma™ generates at least 3 to 5 kW of additional heat per 1kW of electricity used. Talk about a good investment.

#### OPERATING COSTS:

Conditions: Required annual heating energy: 20,000 kWh. Source: Energy prices based on EUROSTAT statistics [first semester 2007].

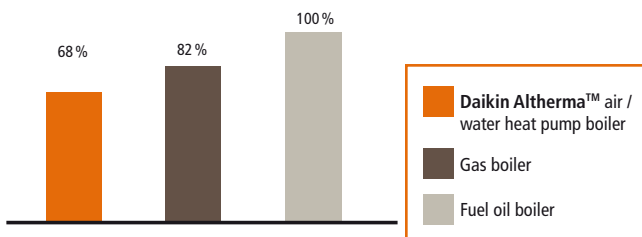

### 2. PER (primary energy ratio)

This is the relationship between the useable energy generated and the primary energy consumed, with consideration for the electricity production efficiency and the electricity distribution.

#### LOW PRIMARY ENERGY CONSUMPTION

Conditions : For combustion systems, the PER indicates the overall efficiency of the system, while for heat pumps it is equal to the seasonal performance factor multiplied by the electricity production efficiency which on average is 0.4 in the European Union.

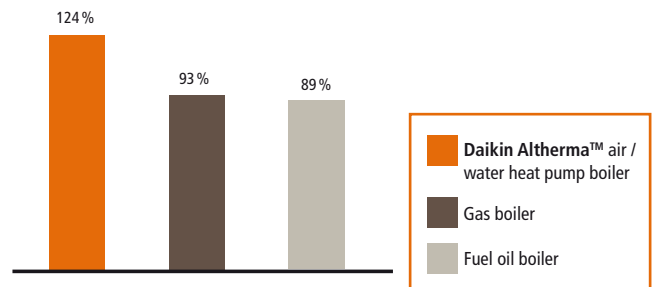

#### AVERAGE ANNUAL CO<sub>2</sub> EMISSIONS

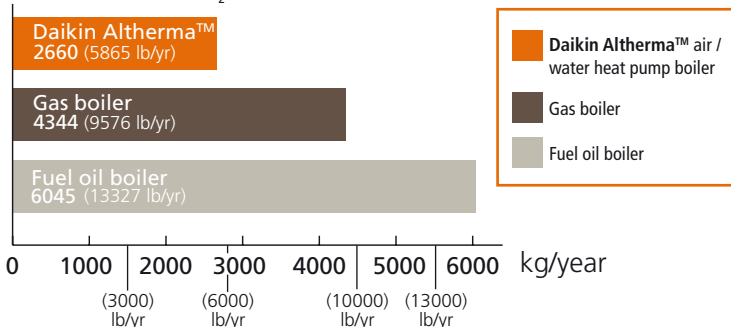

#### LOWER CO<sub>2</sub> EMISSIONS

Daikin Altherma produces no direct CO<sub>2</sub> emissions, so you personally contribute to a better environment. The system does use electricity, but even without renewable electricity the CO<sub>2</sub> emissions are still much lower than boilers that use fossil fuels.

Calculation based on data from Eurelectric (organization of European electricity producers), "Eurelec Program - 2001" for EU27

## UNDERSTANDING DESIGN AND APPLICATION

To better understand the startup and service of the Daikin Altherma system, it is important to also understand basic principles of design and application. The next few pages will describe different ways of how the system can be applied.

### Basic Steps for selecting the correct Daikin Altherma system

- DESIGN STEP 1** Calculation of heat loss and heat gain. Calculation of domestic hot water requirements.
- DESIGN STEP 2** Deciding the leaving water temperature range needed of heat/cool emitters that will cover the heat loss and heat gain.
- DESIGN STEP 3** Selection of the Daikin Altherma™ system based on heat loss calculation and temperature range needed for heat emitters.  
Tip: Use the available Daikin Altherma™ selection and software tools.

#### 1. Mono-Valent (Mild Climate):



100% Heat pump coverage: selection of bigger capacity and higher investment cost heat pump

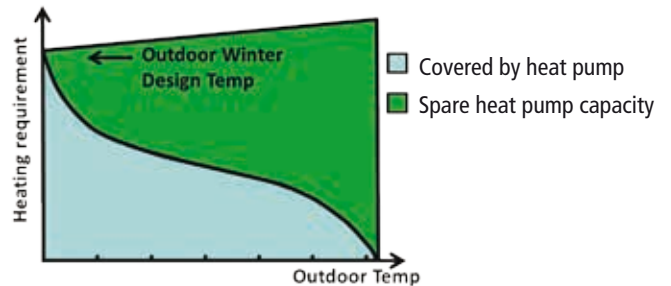

#### 2. Mono-Energetic (Cold Climate):



Best balance between investment cost and running cost, results in lowest Lifecycle Cost

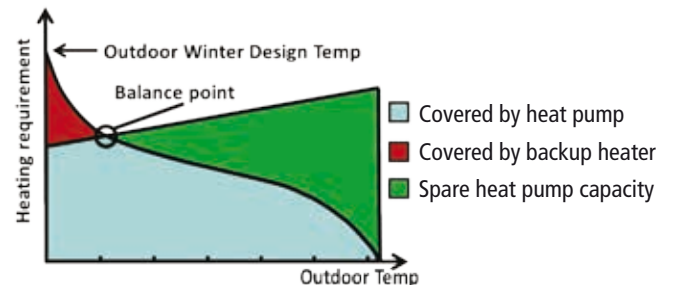

#### 3. Co-Valent (Mid-Ultra Cold Climate):

Option 1: Auxiliary Heat in Hydronic Loop  
Option 2: Auxiliary Heat in Air Stream  
(Could be Gas or Fuel Heating Solution)

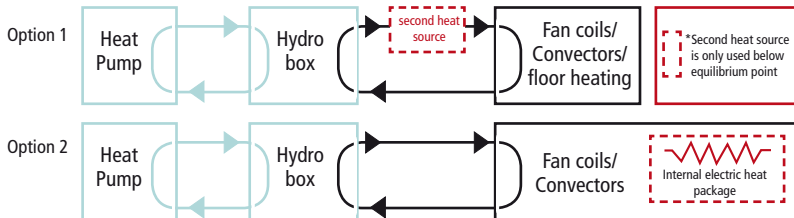

Utilization of heat pump with combination of the optional second heat source (electric, oil or gas boiler) for Mid-ultra cold climate heating days

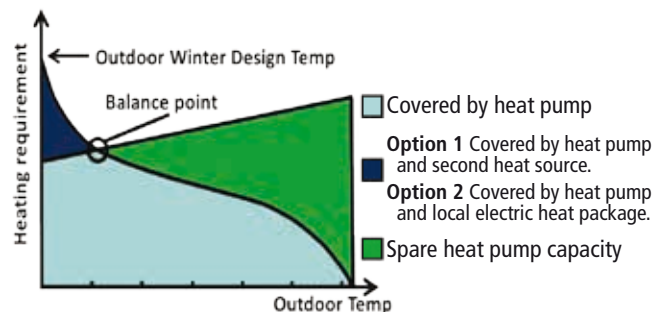

#### 4. Bi-Valent (Ultra-Cold Climate):

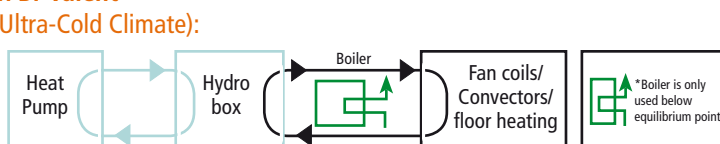

Utilization of heat pump then switching over to alternative heat source like boiler for ultra cold climate heating days

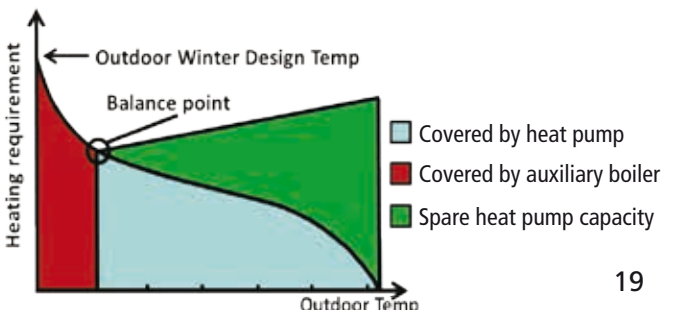

## DAIKIN ALTHERMA™ SPLIT TYPE APPLICATIONS

### 1. Application "heating only" with a room thermostat connected to the indoor unit

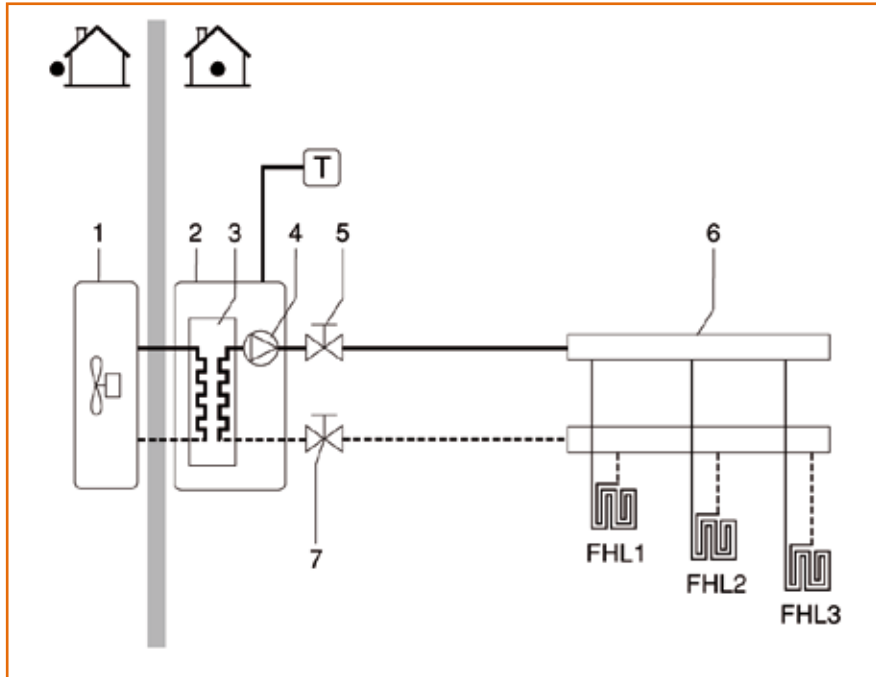

1. Outdoor unit
2. Hydrobox
3. Heat exchanger
4. Pump
5. Valve
6. Manifold\*
7. Valve

FHL1...3 (Under) floor heating loop\*  
 T Room thermostat\*

### 2. Application "heating" and "production of domestic hot water"

The temperature in each room is regulated by a valve on every water circuit. Hot water for domestic use is delivered by the domestic hot water tank connected to the indoor unit.

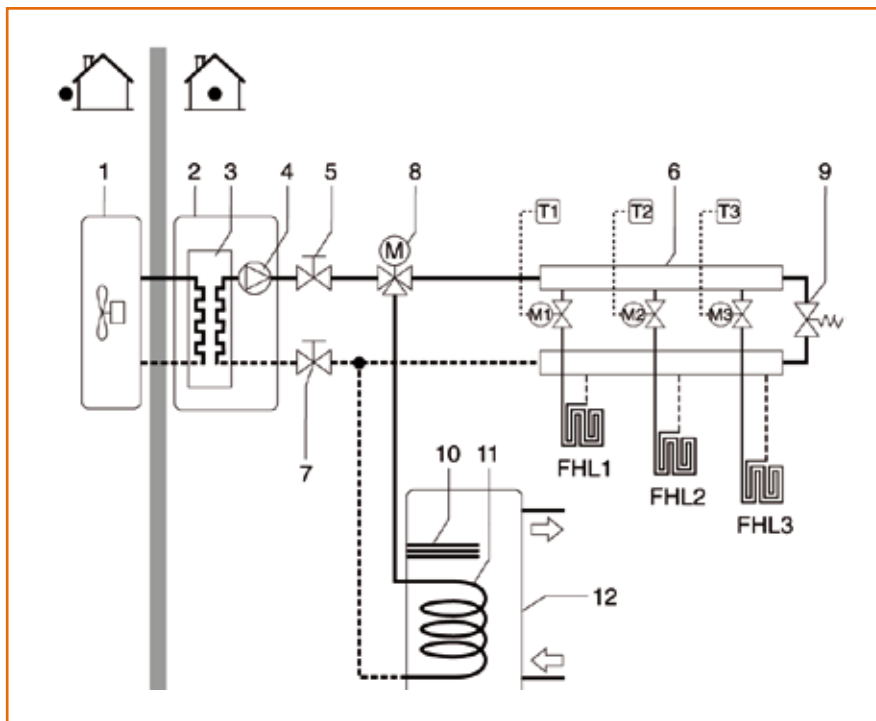

1. Outdoor unit
2. Hydrobox
3. Heat exchanger
4. Pump
5. Valve
6. Manifold\*
7. Valve
8. Motorized 3-way valve
9. Pressure relief valve\*
10. Booster heater
11. Heat exchanger spiral
12. Tank for domestic hot water

FHL1...3 (Under) floor heating loop\*  
 T 1...3 Individual room thermostat\*



### 3. Application “heating/cooling” via room thermostat and “production of domestic hot water”

Heating using under floor heating loops and fan coil units. Cooling using only the fan coil units.

Hot water for domestic use is delivered by the domestic hot water tank connected to the indoor unit.

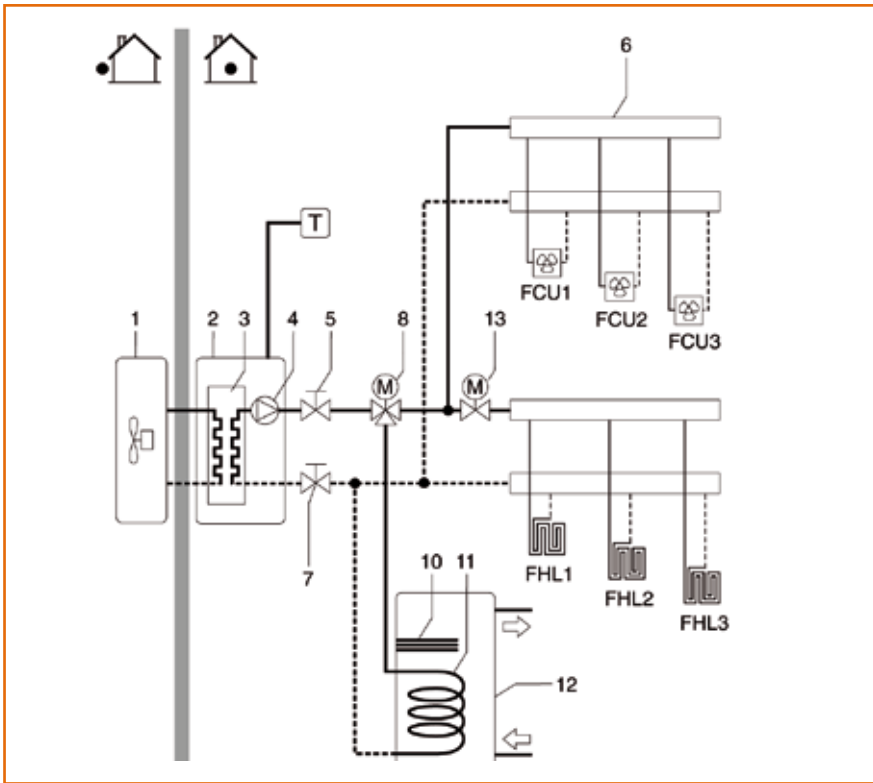

1. Outdoor unit
2. Hydrobox
3. Heat exchanger
4. Pump
5. Valve
6. Manifold\*
7. Valve
8. Motorized 3-way valve
10. Booster heater
11. Heat exchanger spiral
12. Tank for domestic hot water
13. Motorized 2-way valve\*

FCU1...3 Fan coil unit\*  
 FHL1...3 (Under) floor heating loop\*  
 T Room thermostat with cooling / heating switch\*

### 4. Bi-valent application

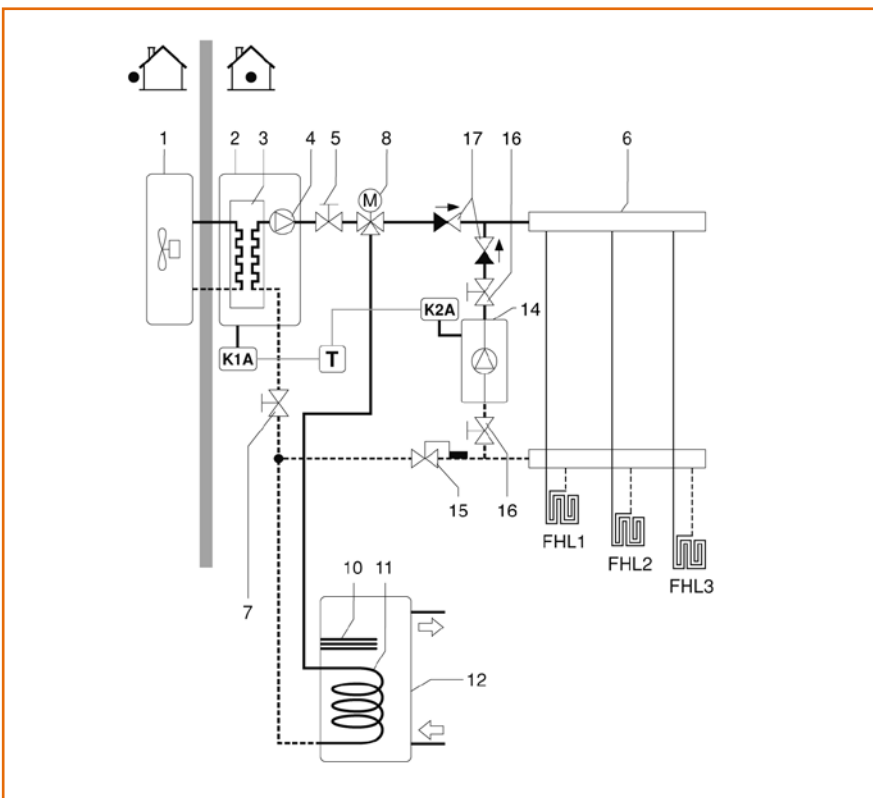

1. Outdoor unit
2. Hydrobox
3. Heat exchanger
4. Pump
5. Valve
6. Manifold\*
7. Valve
8. Motorized 3-way valve
10. Booster heater
11. Heat exchanger spiral
12. Tank for domestic hot water
14. Alternate heating device\*
15. Aquastat\*
16. Valve\*
17. One-way valve\*

FHL1...3 (Under) floor heating loop\*  
 K1A Relay for activating EKHB\*unit\*  
 K2A Relay for activating hot water tank\*  
 T Room thermostat

## DAIKIN ALTHERMA™ MONOBLOC APPLICATIONS

### 1. Application "heating only" with a room thermostat connected to the indoor unit

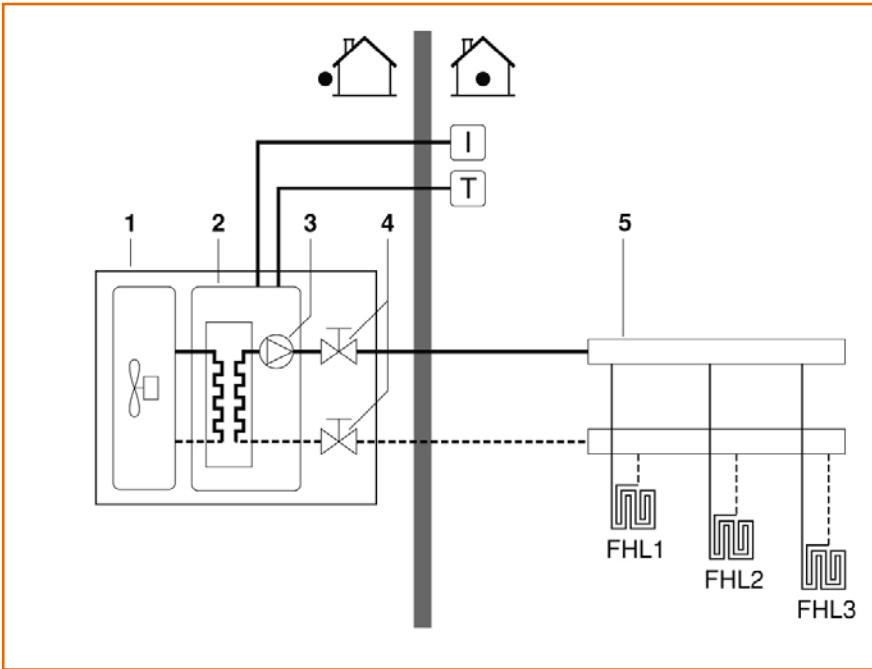

1. Unit
2. Heat exchanger
3. Pump
4. Shut-off valve
5. Collector\*

FHL1...3 Floor heating loop\*  
 T Room thermostat\*  
 I User interface

### 2. Application "heating" and "production of domestic hot water"

The temperature in each room is regulated by a valve on every water circuit. Hot water for domestic use is delivered by the domestic hot water tank connected to the unit.

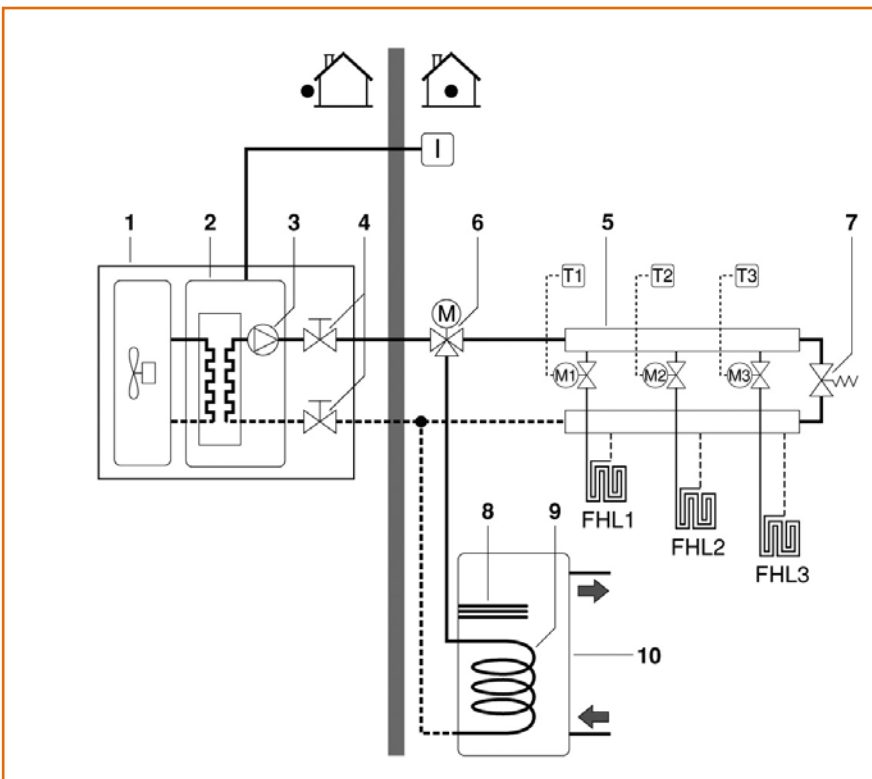

1. Unit
2. Heat exchanger
3. Pump
4. Shut-off valve
5. Collector\*
6. Motorized 3-way valve
7. By-pass valve\*
8. Booster heater
9. Heat exchanger coil
10. Domestic hot water tank

FHL1...3 Floor heating loop\*  
 T 1...3 Individual room thermostat\*  
 M 1...3 Individual motorized valve to control loop FHL1\*  
 I User interface

### 3. Application "heating/cooling" via room thermostat and "production of domestic hot water"

Heating using under floor heating loops and fan coil units. Cooling using only the fan coil units.

Hot water for domestic use is delivered by the domestic hot water tank connected to the unit.

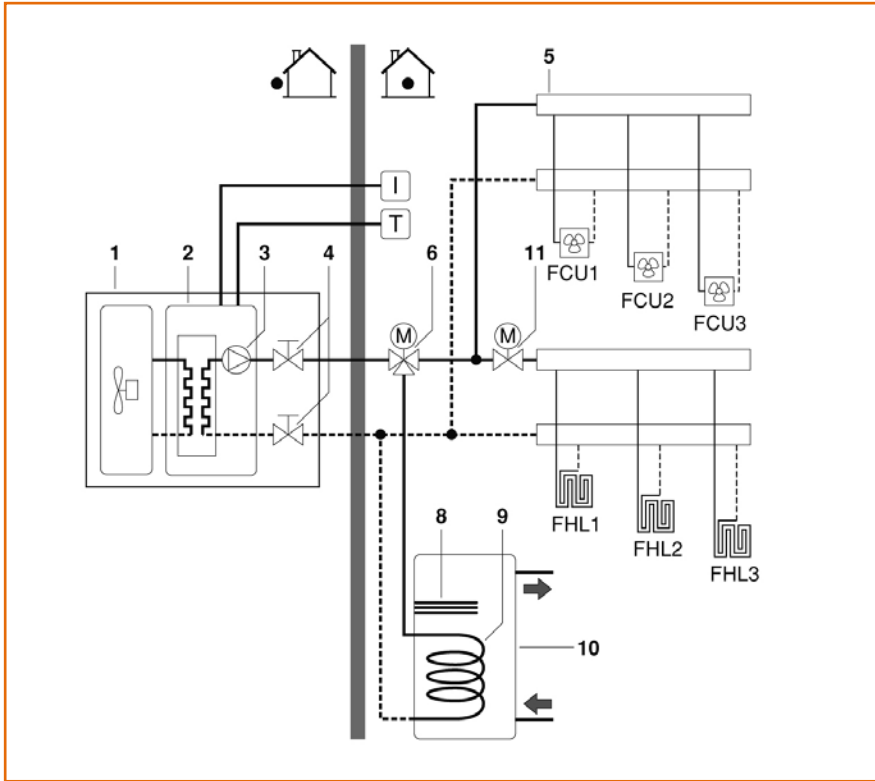

1. Unit
2. Heat exchanger
3. Pump
4. Shut-off valve
5. Collector\*
6. Motorized 3-way valve
8. Booster heater
9. Heat exchanger coil
10. Domestic hot water tank
11. Motorized 2-way valve\*

- FCU1...3 Fan coil unit\*  
 FHL1...3 Floor heating loop\*  
 T Room thermostat with cooling/heating switch\*  
 I User interface

### 4. Application "heating/cooling" without a room thermostat

but with a heating only room thermostat controlling the underfloor heating and a cooling/heating thermostat controlling the fan coil units.

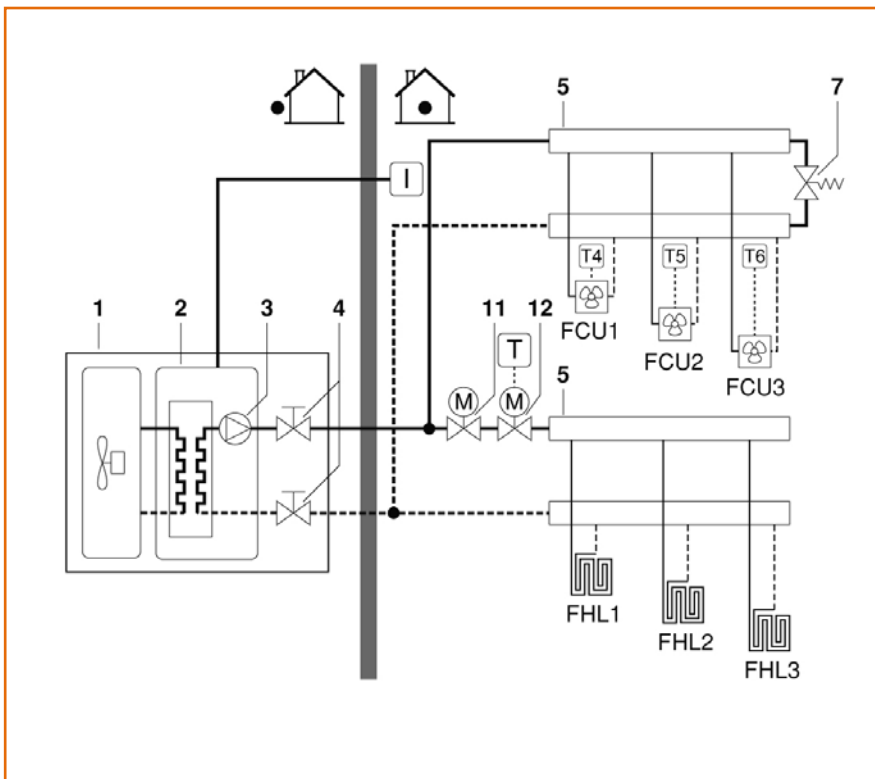

1. Unit
2. Heat exchanger
3. Pump
4. Shut-off valve
5. Collector\*
7. By-pass valve\*
11. Motorized 2-way valve to shut off the floor heating loops during cooling operation\*
12. Motorized 2-way valve for activation of the room thermostat\*

- FCU1...3 Fan coil unit with thermostat\*  
 FHL1...3 Floor heating loop\*  
 T Heating only room thermostat\*  
 T4..6 Individual room thermostat for fan coil heated/cooled room\*  
 I User interface

\* Field Supply

# OUTDOOR SPLIT TYPE

# 6. TECHNICAL SPECIFICATIONS

## OUTDOOR UNIT



ERLQ018/024/030BAVJU



ERLQ036/048/054BAVJU

			ERLQ018BAVJU	ERLQ024BAVJU	ERLQ030BAVJU	ERLQ036BAVJU	ERLQ048BAVJU	ERLQ054BAVJU	
Nominal capacity (1)	Heating	Btu/hr	19,620	23,340	28,760	38,200	47,800	54,600	
	Cooling	Btu/hr	24,570	27,840	28,560	47,600	59,100	60,600	
Nominal input (1)	Heating	kW	1.35	1.66	2.21	2.58	3.30	3.97	
	Cooling	kW	2.36	2.87	3.06	3.91	5.94	6.94	
COP			4.25	4.12	3.81	4.34	4.24	4.03	
EER			10.41	9.7	9.33	12.17	9.95	8.73	
Fan	Motor	Model	Brushless DC motor			Brushless DC motor			
		Output	53			70			
Operation range	Heating	°F (°C)	-4 - 77 (-20 - 25)			-4 - 95 (-20 - 35)			
	Cooling	°F (°C)	50 - 110 (10 - 43)			50 - 114.8 (10 - 46)			
	Domestic water	°F (°C)	-4 - 110 (-20 - 43)*			-4 - 109.4* (-20 - 43)			
Sound power level	Heating	dBA	61	61	62	64	64	66	
	Cooling	dBA	63	63	63	64	66	69	
Sound pressure level	Heating	dBA	48	48	49	49	51	53	
	Cooling	dBA	48	48	50	50	52	54	
Air Flow Rate (nominal at 230V) (cfm)	Heating	m³/min	N/A	N/A	N/A	3178	3178	3178	
	Cooling	m³/min	N/A	N/A	N/A	3390	3531	3425	
Piping connections	Liquid (OD)	Type	Flare connection			Flare connection			
		Diameter (OD)	in.	ø 1/4	ø 1/4	ø 1/4	ø 3/8	ø 3/8	ø 3/8
	Gas	Type	Flare connection			Flare connection			
		Diameter (OD)	in.	ø 5/8	ø 5/8	ø 5/8	ø 5/8	ø 5/8	ø 5/8
	Drain	Type	Socket			Hole			
		Diameter (OD)	in.	ø 7/10	ø 7/10	ø 7/10	ø 1-1/32	ø 1-1/32	ø 1-1/32
	Piping Length	Minimum	ft.	10	10	10	16.4	16.4	16.4
		Maximum	ft.	98	98	98	246	246	246
		Equivalent	ft.	-	-	-	312	312	312
	Installation Height Difference	Chargeless	ft.	33	33	33	98.4	98.4	98.4
		Maximum	ft.	66	66	66	98.4	98.4	98.4
	Refrigerant charge	Charge	lbs.	3.75			8.15		
Additional		oz./ft.	0.21			Refer to chart in installation instructions			
Power supply			208-230V/1Ph/60Hz			208-230V/1Ph/60Hz			
Minimum Circuit Amps (MCA)		A	18	18	18	26.5	26.5	26.5	
Maximum Overcurrent Protection (MOP)		A	20	20	20	30	30	30	
Dimensions (Net)		HxWxD	in. 28 9/10 x 32 1/2 x 11 8/10			46 1/16 x 35 7/16 x 12 5/8			
Weight	Net	lbs.	123	123	123	227	227	227	
	Gross	lbs.	134	134	134	251.3	251.3	251.3	

Measuring conditions: Heating Ta DB/WB 44.6°F/42.8°F (7/6°C) - LWC 95°F (35°C) (DT=9°F (5°C))

- Cooling Ta 95°F (35°C) - LWE 64.4°F (18°C) (DT=9°F (5°C))

\* Booster heater operation from 95°F (35°C) onwards

(1) These conditions are based on under floor heating/cooling application

# OUTDOOR MONOBLOC TYPE

## OUTDOOR UNIT



			HEATING ONLY			REVERSIBLE			
SINGLE PHASE			EDLQ036BA6VJU	EDLQ048BA6VJU	EDLQ054BA6VJU	EBLQ036BA6VJU	EBLQ048BA6VJU	EBLQ054BA6VJU	
Nominal capacity (3)	Heating	Btu/hr	38,200	47,700	54,600	38,200	47,700	54,600	
	Cooling	Btu/hr	-	-	-	43,800	54,500	57,000	
Nominal input (3)	Heating	kW	2.53	3.33	3.93	2.53	3.33	3.93	
	Cooling	kW	-	-	-	3.91	5.79	6.43	
COP			4.32	4.2	4.07	4.32	4.2	4.07	
EER			-	-	-	11.21	9.42	8.88	
Operation range	Heating	°F (°C)	5 - 95 <sup>(1)</sup> (-15 - 35)			5 - 95 <sup>(1)</sup> (-15 - 35)			
	Cooling	°F (°C)	-			50 - 114.8 (10 - 46)			
	Domestic water	°F (°C)	5 - 95 <sup>(1)(2)</sup> (-15 - 35)			5 - 95 <sup>(1)(2)</sup> (-15 - 35)			
Sound power level	Heating	dBA	64	64	66	64	64	66	
	Cooling	dBA	-	-	-	65	66	69	
Sound pressure level	Heating	dBA	51	51	52	51	51	52	
	Cooling	dBA	-	-	-	50	52	54	
Refrigerant charge		R-410A	lbs. 6.5			6.5			
Power supply			208-230V/1Ph/60Hz			208-230V/1Ph/60Hz			
Minimum Circuit Amps (MCA)		A	26.5			26.5			
Maximum Overcurrent Protection (MOP)		A	30			30			
Dimensions (Net)		HxWxD	in. 55 7/8 x 56 1/2 x 15 1/32			55 27/32 x 56 1/2 x 15 1/32			
Weight	Net	lbs.	397			397			
	Gross	lbs.	441			441			
Leaving water temperature range	Heating	°F (°C)	59 - 131 (15 - 55)			59 - 131 (15 - 55)			
	Cooling	°F (°C)	N/A			41 - 71.6 (5 - 22)			
Expansion vessel	Volume	gal.	2.64			2.64			
	Max. water pressure	PSI	43.5			43.5			
	Pre Pressure	PSI	14.5			14.5			
Water Piping connections diameter		in.	1 1/4 Female BSP			1 1/4 Female BSP			
Safety valve		PSI	< 43.5			< 43.5			
Total water volume		gal.	1.45			1.45			
Pump (Nominal ESP)	Heating	PSI/FtHd	7.6 / 17.6	6.3 / 14.6	5.0 / 11.6	7.6 / 17.6	6.3 / 14.6	5.0 / 11.6	
	Cooling	PSI/FtHd	N/A	N/A	N/A	8.1 / 18.7	7.1 / 16.4	6.7 / 15.7	
	Water volume	gal.	0.27			0.27			
Water side Heat exchanger	Water flow rate Min./Max	GPM	4.23 / 15.32			4.23 / 15.32			
	Water flow rate Nom.	Heating	GPM	8.48	10.59	12.13	8.48	10.59	12.13
		Cooling	GPM	N/A	N/A	N/A	9.72	12.13	12.68
Factory mounted Back Up Heater	Capacity	kW	6			6			
	Capacity Steps		2			2			
	Max Overcurrent Protection (MOP)		28.6			28.6			
	Minimum Circuit Amps (MCA)		30			30			
	Power supply		208-230V/1Ph/60Hz			208-230V/1Ph/60Hz			

Measuring conditions: Heating Ta DB/WB 44.6°F/42.8°F (7/6°C) - LWC 95°F (35°C) - Cooling Ta 95°F (35°C) - LWE 64.4°F (18°C)

(1) E(D/B)L\* models can reach -4°F (-20°C) but without capacity guarantee

(2) Booster heater operation from 95°F (35°C) onwards

(3) These conditions are based on under floor heating/cooling application

(4) For further information pertaining to the hydronic specs of the MonoBloc system, refer to the engineering databook



# HYDROBOX (FOR USE WITH ERLQ018/024/030BAVJU)



## HYDROBOX

			EKHBH030BA3VJU	EKHBX030BA3VJU	EKHBH030B6VJU	EKHBX030B6VJU
Function			Heating only		Reversible	
Leaving water temperature range	Heating	°F (°C)	(59) 77 - 131* ((15) 25 - 55)		(59) 77 - 131* ((15) 25 - 55)	
	Cooling	°F (°C)	-	41 - 71.6 (122) (5 - 22 (50))	-	41 - 71.6 (122) (5 - 22 (50))
Drain valve			Yes			
Material			Epoxy polyester painted galvanized steel			
Color			Neutral white (RAL 9010)			
Dimensions (Net)	HxWxD	in.	36 5/16 x 19 3/4 x 14 7/32	36 5/16 x 19 3/4 x 14 7/32	36 5/16 x 19 3/4 x 14 7/32	36 5/16 x 19 3/4 x 14 7/32
Weight	Net	lbs.	101		101	
	Gross	lbs.	130		130	
Factory mounted heater	Capacity	kW	3	3	6	6
	Capacity Steps		1	1	2	2
	Max Overcurrent Protection (MOP)		20 A	20 A	30 A	30 A
	Minimum Circuit Amps (MCA)		14.3 A	14.3 A	28.6 A	28.6 A
	Power supply		208-230V/1Ph/60Hz		208-230V/1Ph/60Hz	

When connected to all outdoor units	Main components	Expansion vessel	Volume	gal.	2.64		2.64		
				Max. water pressure	PSI	43.5		43.5	
		Pre Pressure	PSI	14.5		14.5			
Water circuit	Piping connections diameter		in.	1" Male BSP		1" Male BSP			
		Piping	in.	1		1			
		Safety valve	PSI	43.5		43.5			
		Total water volume	gal.	5.5		5.5			
Refrigerant circuit	Gas side diameter		in.	ø 5/8		ø 5/8			
		Liquid side diameter	in.	ø 1/4		ø 1/4			
Operation range	Waterside	Heating	°F (°C)	(59) 77 - 131* ((15) 25 - 55)		(59) 77 - 131* ((15) 25 - 55)			
		Cooling	°F (°C)	-	41 - 71.6 (122) (5 - 22 (50))	-	41 - 71.6 (122) (5 - 22 (50))		
When connected to ERLQ018	Main components	Pump	Nominal ESP unit	Heating	PSI/FHd	7.1/16.4		7.1/16.4	
			Cooling	PSI/FHd	-	7.4/17.1	-	7.4/17.1	
		Water side Heat exchanger	Water volume	gal.	0.18		0.18		
			Water flow rate Min./Max	GPM	3.17/11.09		3.17/11.09		
			Water flow rate Nom.	Heating	GPM	4.35		4.35	
Cooling	GPM	-		3.88	-	3.88			
When connected to ERLQ024	Main components	Pump	Nominal ESP unit	Heating	PSI/FHd	6.5/15.0		6.5/15.0	
			Cooling	PSI/FHd	-	8.5/19.6	-	8.5/19.6	
		Water side Heat exchanger	Water volume	gal.	0.18		0.18		
			Water flow rate Min./Max	GPM	3.17/11.09		3.17/11.09		
			Water flow rate Nom.	Heating	GPM	5.18		5.18	
Cooling	GPM	-		4.44	-	4.44			
When connected to ERLQ030	Main components	Pump	Nominal ESP unit	Heating	PSI/FHd	5.5/12.7		5.5/12.7	
			Cooling	PSI/FHd	-	7.0/16.2	-	7.0/16.2	
		Water side Heat exchanger	Water volume	gal.	0.18		0.18		
			Water flow rate Min./Max	GPM	3.17/11.09		3.17/11.09		
			Water flow rate Nom.	Heating	GPM	6.37		6.37	
Cooling	GPM	-		4.60	-	4.60			

\*Back up heater operation between 59°F (15°C) and 77°F (25°C)

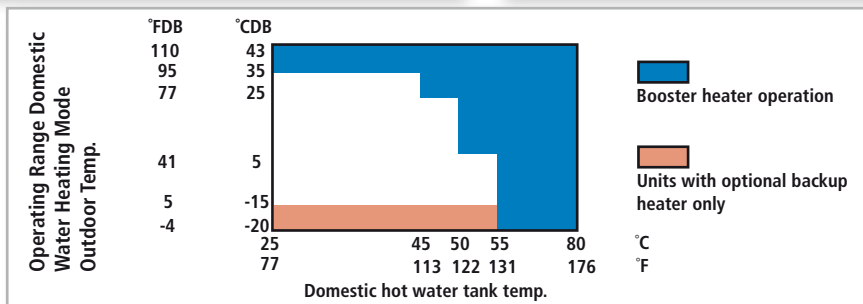
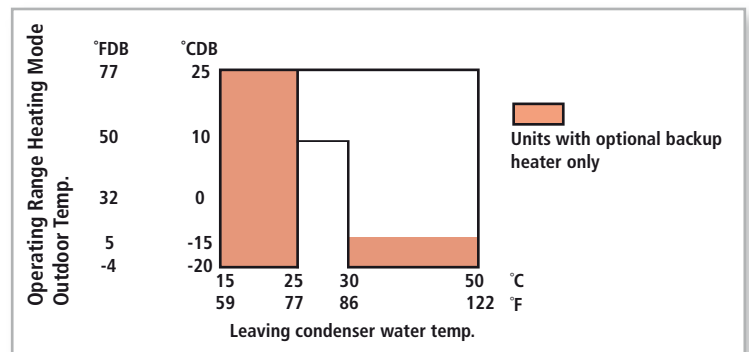
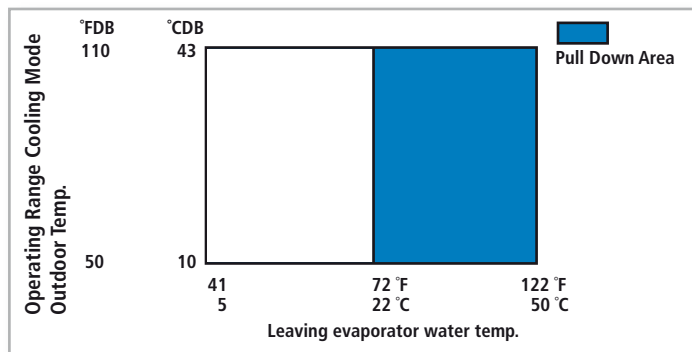

# HYDROBOX (FOR USE WITH ERLQ036/048/054BAVJU)



## HYDROBOX

			EKHBH054BA3VJU	EKHBX054BA3VJU	EKHBH054B6VJU	EKHBX054B6VJU
Function			Heating only	Reversible	Heating only	Reversible
Leaving water temperature range	Heating	°F (°C)	(59) 77 - 131* ((15) 25 - 55)		(59) 77 - 131* ((15) 25 - 55)	
	Cooling	°F (°C)	-	41 - 71.6 (5 - 22)	-	41 - 71.6 (5 - 22)
Drain valve	yes					
Material	Epoxy polyester painted galvanized steel					
Color	Neutral white (RAL 9010)					
Dimensions (Net)	HxWxD	in.	36 5/16 x 19 3/4 x 14 7/32	36 5/16 x 19 3/4 x 14 7/32	36 5/16 x 19 3/4 x 14 7/32	36 5/16 x 19 3/4 x 14 7/32
	Net	lbs.	123		123	
Weight	Gross	lbs.	152		152	
	Capacity	kW	3	3	6	6
Factory mounted heater	Capacity Steps		1	1	2	2
	Max Overcurrent Protection (MOP)		20 A	20 A	30 A	30 A
	Minimum Circuit Amps (MCA)		14.3 A	14.3 A	28.6 A	28.6 A
	Power supply		208-230V/1Ph/60Hz	208-230V/1Ph/60Hz	208-230V/1Ph/60Hz	208-230V/1Ph/60Hz

When connected to all outdoor units	Main components	Expansion vessel	Volume		gal.		2.64				
			Max. water pressure	PSI	43.5		43.5				
Water circuit	Piping connections diameter	Piping	Safety valve	Total water volume	gal.	1 1/4 Male BSP		1 1/4 Male BSP			
						43.5		43.5			
						1.45		1.45			
						ø 5/8		ø 5/8			
Refrigerant circuit	Liquid side diameter	ø 3/8		ø 3/8							
		ø 3/8		ø 3/8							
Operation range	Waterside	Heating	°F (°C)	59 - 131 (15 - 55)		59 - 131 (15 - 55)					
		Cooling	°F (°C)	-	41 - 71.6 (5 - 22)	-	41 - 71.6 (5 - 22)				
When connected to ERLQ036	Main components	Pump	Nominal ESP unit	Heating	PSI/FPHd	7.6/17.6		7.6/17.6			
			Cooling	PSI/FPHd	-	8.1/18.7	-	8.1/18.7			
		Water side Heat exchanger	Water volume		gal.	0.26		0.26			
			Water flow rate Min./Max		GPM	4.23/15.32		4.23/15.32			
		Water flow rate Nom.	Heating	GPM	8.48		8.48				
			Cooling	GPM	-	7.58	-	7.58			
		When connected to ERLQ048	Main components	Pump	Nominal ESP unit	Heating	PSI/FPHd	6.3/14.6		6.3/14.6	
					Cooling	PSI/FPHd	-	7.1/16.4	-	7.1/16.4	
Water side Heat exchanger	Water volume			gal.	0.26		0.26				
	Water flow rate Min./Max			GPM	4.23/15.32		4.23/15.32				
Water flow rate Nom.	Heating			GPM	10.59		10.59				
	Cooling			GPM	-	9.46	-	9.46			
When connected to ERLQ054	Main components			Pump	Nominal ESP unit	Heating	PSI/FPHd	5.0/11.7		5.0/11.7	
					Cooling	PSI/FPHd	-	6.7/15.7	-	6.7/15.7	
		Water side Heat exchanger	Water volume		gal.	0.26		0.26			
			Water flow rate Min./Max		GPM	4.23/15.32		4.23/15.32			
		Water flow rate Nom.	Heating	GPM	12.13		12.13				
			Cooling	GPM	-	9.93	-	9.93			

\*Back up heater operation between 59°F (15°C) and 77°F (25°C)

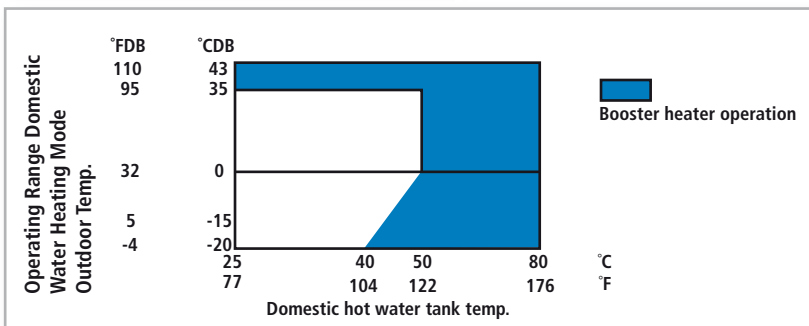
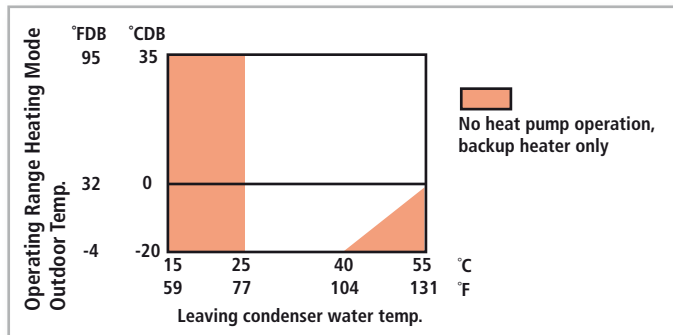
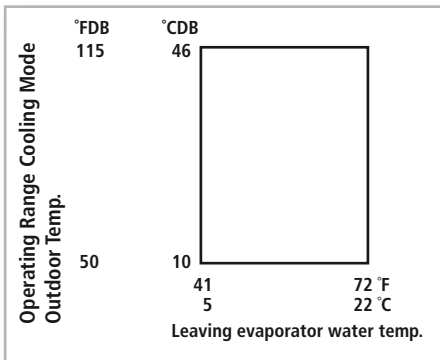

## DOMESTIC HOT WATER TANK



			EKHWS050BA3VJU	EKHWS080BA3VJU
Water volume	gal.		52.8	79.2
Max.water temperature	°F (°C)		185 (85)	
Max.water pressure	PSI		145	
Insulation (Polyurethane foam) Min. thickness	in.		1 5/8	
Height	in.		45 3/8	63
Diameter	in.		22 7/8	
Booster heater	kW		3	
Piping connections	Water inlet H/E Diameter	in.	ø 3/4 FBSP	
	Water outlet H/E Diameter	in.	ø 3/4 FBSP	
	Cold water in Diameter	in.	ø 3/4 FBSP	
	Hot water out Diameter	in.	ø 3/4 FBSP	
Minimum Circuit Amps (MCA)	A		14.3	
Maximum Overcurrent Protection (MOP)	A		20	
Power supply	208-230V/1Ph/60Hz			
Material inside tank	Stainless steel (DIN 1.4521) - 316L			
Material outside casing	Epoxy-coated mild steel			
Color	Neutral white			
Dimensions (Net)	HxWxD	in.	45 9/32 x 22 27/32 x 22 27/32	63 x 22 27/32 x 22 27/32
Empty weight	lbs.		99	129.8

Note: 3-Way Valve is factory included with the Domestic Hot Water Tank for field installation

## SOLAR KIT



			EKSOLHWBAVJU
Heat exchanger	pressure drop	psi	3.12
	max.inlet temp	°F (°C)	230 (110)
	heat exchange capacity	W/K	1,400
	Logarithmic mean temperature difference (LMTD)	K	5
Pump	Number of speeds		3
	Power input	W	46
Water circuit	Piping connections diameter	in.	3/4 FBSP
	max.	°F	95 (35)
Ambient temperature	min.	°F	33.8 (1)
	Power supply	208-230V/1Ph/60Hz	
Power supply intake	from indoor unit		
Dimensions (Net)	HxWxD	in.	30 1/32 x 12 x 10 1/32

## ROOM THERMOSTAT



thermostat

			EKRTWA
Ambient temperature	Storage	°F (°C)	-4 - 140 (-20 - 60)
	Operation	°F (°C)	32 - 122 (0 - 50)
Temperature setpoint range	Heating	°F (°C)	39.2 - 98.6 (4 - 37)
	Cooling	°F (°C)	39.2 - 98.6 (4 - 37)
Clock	yes		
Regulation function	proportional band		
Dimensions (Net)	HxWxD	in.	3 27/64 x 4 59/64 x 1 11/32
Weight (Net)	lbs.		0.47

# FAN COIL UNIT



Capacity		018	024	030	036	048	054
Model Number (No Electric Heat Options)		EFWT024AEVLU**	EFWT024AEVLU	EFWT036AEVLU**	EFWT036AEVLU	EFWT048AEVLU	EFWT060AEVLU
Model Number (With Electric Heat Options)		EFWT024AEVJU**	EFWT024AEVJU	EFWT036AEVJU**	EFWT036AEVJU	EFWT048AEVJU	EFWT060AEVJU
Cooling Performance (chilled water cooling):							
Nominal Capacity	Btu/hr	19,100	22,600	28,600	32,000	42,700	52,400
Nominal Sensible Capacity	Btu/hr	14,200	17,700	22,400	25,800	34,700	42,400
EWT Range	°F	40 - 50°F					
Nominal Flow Rate	GPM	4.5	5.0	6.0	6.0	8.0	10.0
Nominal Pressure drop	Ft Hd	5.5	7.7	4.8	5.5	5.4	7.9
Heating Performance (hot water heating):							
Nominal Capacity	Btu/hr	19,300	25,000	31,900	34,800	50,200	60,900
EWT Range	°F	100 - 125°F					
Nominal Flow Rate	GPM	3.0	4.5	4.5	4.5	8.0	10.0
Nominal Pressure drop	Ft Hd	2.5	5.5	3.0	3.0	5.4	7.9
Airflow Rate:							
Nominal	CFM	600	800	1050	1200	1600	2000
Total External Static Pressure	WG "	0.3" WG Std, 0.5" WG Max					
Blower Speed setting		*C" FACTORY SETTING	*A" FACTORY SETTING	*B" FACTORY SETTING	*A" FACTORY SETTING	*A" FACTORY SETTING	*A" FACTORY SETTING
Motor rating	HP	1/3 HP		1/2 HP		3/4 HP	1 HP
Airflow arrangement		Upflow, Horizontal L, Horizontal R (Possible)					
Electrical Data (No Electric Heat Options):							
Power supply		120V / 1 / 60Hz					
Minimum Circuit Amps (MCA)		6.0	6.0	10.0	10.0	14.0	15.0
Maximum overcurrent protection (MOP)	A	15	15	15	15	15	15
Electrical Data (With Electric Heat Options):							
Power supply		208-230V/1Ph/60Hz					
Minimum Circuit Amps (MCA)		3.0	3.0	4.0	4.0	6.0	9.0
Maximum overcurrent protection (MOP)	A	15	15	15	15	15	15
Electrical Heater Options 10 to 25kW		5kW, 10kW	5kW, 10kW	5kW, 10kW, 15kW	5kW, 10kW, 15kW	15kW, 20kW, 25kW	15kW, 20kW, 25kW
Electrical Heat Integral Disconnect		FACTORY INSTALLED SERVICE SWITCH OVER 10KW (NO DISCONNECT)					
Physical Data:							
Dimension	HXWXD	40 x 20 x 20		40 x 23 x 20		48 x 21-1/4 x 28	
Weight	lbs.	115		170		230	290
Insulation type / R-Rating		1/2" JM TUF-SKIN					
Installation Clearances		U.L. LISTED FOR INSTALLATION WITH ZERO INCHES CLEARANCE TO COMBUSTABLE MATERIALS					
Connection type:							
Inlet / Outlet Connections	in.	7/8	7/8	7/8	7/8	1-1/8	1-1/8
Connection Type		Sweat	Sweat	Sweat	Sweat	Sweat	Sweat
Feature:							
Thermostat Connection		24V	24V	24V	24V	24V	24V
Air Filter (MERV 8 Throwaway)		18 x 20 x 1		20 x 22 x 1		20 x 25 x 1	

**Notes:**

1. Cooling Capacity is based on 50°F Entering Water Temp and 80°F DB/67°F WB Entering Air Conditions.
2. Heating Capacity is based on 110°F Entering Water Temp and 70°F DB Entering Air Conditions.
3. Refer to detailed capacity tables for further information pertaining to the entire entering water temperature range and for flow rates and pressure drop.
4. Refer to engineering data book for further information on electric heat options.
5. Std efficiency models with PSC motor are available on request.

## OPTION LIST

	MODEL NUMBER	NOTES
Condensate Kit	EKHBDP	For Cooling Mode Applications
Digital I/O PCB	EKRP1HBAAU	Unit On/Off Alarm On/Off Solar Input
BSP to NPT Connection Adaptors	DACA-DHWRA-1	DHW Recirculation Loop 1/2"
	DACA-DHWTA-1	DHW Tank Inlet/Outlet 3/4"
	DACA-THXA-1	DHW He-Ex 1"
	DACA-3WVTA-1	3-Way Valve 1 1/4"
	DACA-3WVTH-1	3-Way Valve 1"
	DACA-HBA-1	EKHB_054 Hydrobox Inlet/Outlet 1 1/4"
	DACA-HBA-2	EKHB_030 Hydrobox Inlet/Outlet 1"
	DACA-HBA-3	EDLQ/EBLQ Inlet/Outlet 1 1/4"
DACA-MP-1	DHW Tank Plug 3/4"	
Wall Mounting Bracket for Consensing Unit	DACA-WB-3	Unit Weight - Up to 500 lbs.
3rd Party DHW Tank Connection Kit	DACA-DHW-KIT-1	For Tanks up to 119G



# DAIKIN UNIQUE BENEFITS

## altherma



### ➤ DID YOU KNOW...

with a Daikin Altherma™ heat pump, the temperature of the domestic water can go up to 185°F (85°C), the temperature of the hot water for heating ranges between 59°F (15°C) and 131°F (55°C) and the temperature of the cold water for cooling between 41°F (5°C) and 72°F (22.2°C).

#### **Control customized to your customer**

The water temperature changes in function with the outside temperature so that your customer can enjoy a stable level of heating at any time. As the installer, you set up the system according to the desires of your customer. You input four temperatures to determine the “heating curve” and in doing so, you perfectly tune the Daikin Altherma system to the type of home.

#### **Automatic re-start after power interruption**

In the event of a power interruption of up to two hours, the system automatically resumes with the previously set parameters.

#### **Quiet operation**

The outdoor unit makes hardly any noise thereby leaving your customer’s (and the neighbor’s) peace and quiet undisturbed. You can even set the outdoor unit to produce 10dB(A) less noise during the night.

#### **Electric back-up heating**

Every Daikin Altherma system is equipped with a back-up heater (heating capacity of 3 or 6 kW). This unit can be used for supplemental heating during extremely cold outdoor temperatures or as a back-up in case of any problems with the outdoor unit. Your customer can then enjoy comfortable heating at any moment.

The operation of the back-up heater can be coupled to the outside temperature. The back-up heater will then only operate when outside temperatures are extremely low.

Daikin Altherma's "simulator" software program allows quick and easy indication of the benefits of a Daikin Altherma system.

By specifying a number of parameters such as the location, the surface area to be heated, the required heating and cooling capacity, the entry and exit water temperatures of the distribution network and the local energy prices, the program displays the following simulation details.

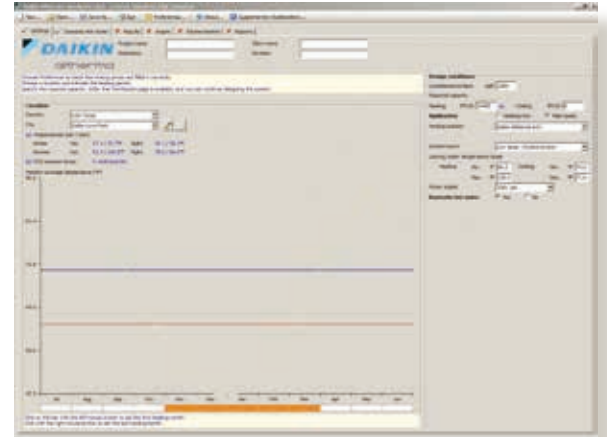

1. Material list with technical specification

2. Simulation graphics:

- a) Required and available heating and cooling capacity with indication of the SPF (or Seasonal COP) and Annual EER based on the defined climate conditions.
- b) Duration of the heating and cooling operation periods as a function of the outside temperature
- c) The annual energy cost compared with a heating system using gas or fuel oil
- d) The annual amount CO2 emitted in tonnes compared with a heating system using gas or fuel oil
- e) The monthly energy consumption in kWh
- f) The monthly energy cost in dollars
- g) The total amount of thermal energy in kWh as a function of the outside temperature
- h) The radiated heat per ft2 (in Btu/ft2) per month

All data is collected in a separate report. If you are interested in this software, contact your local Daikin Altherma distributor

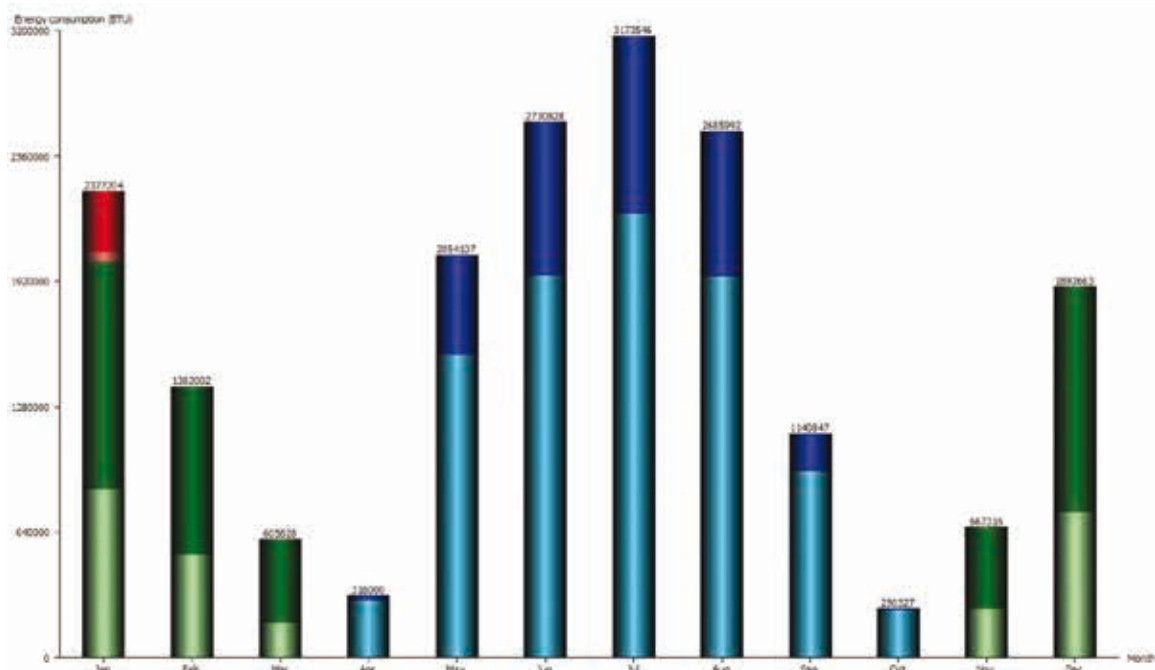

# OTHER RESIDENTIAL SOLUTIONS AVAILABLE

## THE DAIKIN EDGE FOR RESIDENTIAL LIVING

Daikin is the only company in the world dedicated to manufacturing both air-conditioning systems and refrigerants. Each component has been designed to work flawlessly with the next – delivering optimal performance – from the time a project begins to the moment of experiencing absolute comfort.

From single zone to whole house solutions, Daikin’s advanced residential systems provide energy efficiency, reliability, and individual zone control for practically any home.

EFFICIENCY AND FEATURES	<b>Quaternary Wall Mount Systems</b> <ul style="list-style-type: none"> <li>Up to SEER 26.1</li> <li>Dehumidify to RH setting</li> <li>Flash streamer - Air purifier</li> <li>9 MBH - 15 MBH Heat pump</li> </ul>	<b>2, 3, 4 and 8 Multi-Zone Systems</b> <ul style="list-style-type: none"> <li>Connect up to eight units on a single outdoor unit</li> <li>Individual room control</li> <li>18 MBH - 48 MBH Heat pump</li> <li>2 and 3 Zone systems in non ducted combinations Energy Star rated</li> </ul>	FEATURES AND FLEXIBILITY
	<b>LV Series Wall Mount Systems</b> <ul style="list-style-type: none"> <li>Up to SEER 24.5</li> <li>Intelligent eye feature</li> <li>Weekly Timer</li> <li>9 MBH - 24 MBH Heat pump</li> </ul>	<b>SkyAir Systems</b> <ul style="list-style-type: none"> <li>Up to SEER 19.3</li> <li>4 indoor unit styles (wall mount, concealed DC duct, roundflow ceiling cassette, ceiling suspended)</li> <li>Intelligent controls</li> </ul>	
	<b>KE Series Wall Mount Systems</b> <ul style="list-style-type: none"> <li>Up to SEER 18 and HSPF 8.5</li> <li>9 MBH - 24 MBH Heat pump and Cooling only</li> </ul>	<b>VRVIII-S Multi Zone System</b> <ul style="list-style-type: none"> <li>Up to 8 Zones</li> <li>10 indoor unit styles</li> <li>Intelligent and centralized controls</li> <li>Long piping lengths</li> <li>Up to 35.1 SEER</li> <li>130% connection ratio</li> </ul>	
	<b>LV Series Slim Duct Systems</b> <ul style="list-style-type: none"> <li>Up to SEER 15.5</li> <li>Built In solution, concealed and slim in size</li> <li>9 MBH - 12 MBH Heat pump</li> </ul>	<b>Inverter Ducted Unitary System</b> <ul style="list-style-type: none"> <li>Traditional US ducted made better with inverter technology</li> <li>Up to SEER 20.0</li> <li>18 MBH - 42 MBH Heat pump</li> </ul>	
			
<div style="display: flex; justify-content: space-around; align-items: center;"> <div style="text-align: center;">  <p>SINGLE ZONE</p> </div> <div style="text-align: center;">  <p>MULTI-ZONE</p> </div> <div style="text-align: center;">  <p>WHOLE HOUSE</p> </div> </div>			

**WARNINGS:**

- Always use a licensed installer or contractor to install this product. Do not try to install the product yourself. Improper installation can result in water or refrigerant leakage, electrical shock, fire or explosion.
- Use only those parts and accessories supplied or specified by Daikin. Ask a licensed contractor to install those parts and accessories. Use of unauthorized parts and accessories or improper installation of parts and accessories can result in water or refrigerant leakage, electrical shock, fire or explosion.
- Read the User's Manual carefully before using this product. The User's Manual provides important safety instructions and warnings. Be sure to follow these instructions and warnings.
- For any inquiries, contact your local Daikin sales office.

