



# JCM Industries, Inc.

P. O. Box 1220 - Nash, Texas 75569-1220  
Toll Free 800-527-8482, Fax Toll Free 800-874-9524  
Outside U.S. 903-832-2581, Fax 903-838-6260  
[www.jcmindustries.com](http://www.jcmindustries.com)

Following is the JCM Industries, Inc. **July 19, 2021 Price List**. This price list cancels all previous prices and prices remain subject to change without notice.

With this increase, the following remain the same:

- Full Freight Allowance is \$3,000.00 net order
- All Tapped Universal Clamp Couplings are Non-Returnable Items
- All 2" CC Tapped Products are Non-Returnable Items
- JCM 502 Service Saddles are Non-Returnable Items
- Tapping Sleeves with 3" and smaller flanged outlets are Non-Returnable Items

## Reminder of changes To JCM Industries Product Line

### JCM Discontinued Items...

JCM 210 OVERSIZED Ductile Iron Couplings  
JCM 212 OVERSIZED Ductile Iron Transition Couplings  
JCM 214 OVERSIZED Ductile Iron Pipe End Cap Couplings  
JCM 215 OVERSIZED Long Ductile Iron Coupling  
In these product sizes:

0535, 0740, 0960, 1200, 1420

### ...Now available in the NEW FABRICATED STAINLESS STEEL COUPLING PRODUCT LINE

JCM 262 Fabricated Stainless Steel Couplings (straight and transition couplings)  
JCM 3262 All 304 Stainless Steel Couplings  
JCM 6262 All 316 Stainless Steel Couplings

0535, 0740, 0960, 1200, 1420

### New Fabricated Stainless Steel Couplings offer:

Great availability  
Strong, yet Lightweight (reducing shipping costs)  
Improved Corrosion Resistant  
Customization for both pipe diameters and length  
Available for American Iron and Steel/Buy American criteria

### Also available in the oversized ranges listed above:

JCM 362 Fabricated Stainless Steel Flanged Coupling Adapter  
JCM 4362 All 304 Stainless Steel Flanged Coupling Adapter  
JCM 6362 All 316 Stainless Steel Flanged Coupling Adapter

### New 650 Fabricated Mechanical Wall Anchor for HDPE

BIDIRECTIONAL RESTRAINT - Two-way serration system to counteract lateral pipe movement from either direction.  
Serrated Restraint - prevents both push/pull-back and radial slipping of the pipe. Serrations are designed to bite into the exterior pipe wall without damaging the pipe.

For more information on JCM Products, please contact our sales team at 1-800-527-8482 or [sales@jcmindustries.com](mailto:sales@jcmindustries.com)



**JCM Industries, Inc.  
Distributor Discount Structure  
Effective July 19, 2021**

**Discounts are applicable to JCM Pipe Fittings and Fabrications  
Price List Effective July 19, 2021**

Cancels all previous prices

<b><u>List Prices</u></b>	<b><u>Discount</u></b>
0 - \$1,000.00	30%
\$1,001.00 - \$10,000.00	45%
\$10,001.00 and above	53%

**Freight Allowance: \$3,000.00 Net Order of Products with Prices Listed 7/19/2021**

**PRICE LIST EFFECTIVE**  
**July 19, 2021**  
**Cancels All Previous Prices**  
**Prices Subject to Change Without Notice**

# **JCM INDUSTRIES, INC.**

**Fittings and Fabrications**  
**for**  
**REPAIR, CONNECTION, BRANCHING**  
**ALL TYPES OF PIPE**



**JCM INDUSTRIES, INC.**  
**P.O. BOX 1220**  
**NASH, TEXAS 75569-1220**  
**[www.jcmindustries.com](http://www.jcmindustries.com)**  
**[sales@jcmindustries.com](mailto:sales@jcmindustries.com)**

**CONTACT JCM:**  
**Toll Free (800) 527-8482**  
**Fax Toll Free (800) 874-9524**  
**Outside U.S.(903) 832-2581**  
**Fax Outside U.S. (903) 838-6260**



## Terms and Conditions of Sale

### (1) GENERAL

All orders and contracts are subject to acceptance by JCM Industries, Inc. at Nash, Texas. The terms as hereinafter written shall supersede the terms of the customer order in the event of contradiction or inconsistency. Prices, terms and conditions published by JCM Industries, Inc. are subject to change without notice.

### (2) TERMS OF PAYMENT

Minimum net billing is fifty U. S. dollars (\$50.00) on all orders. To encourage early payment a one percent (1%) Cash Discount will be allowed on all invoices paid not later than fifteen (15) days from invoice date. Payment of full invoice amount is due within thirty (30) days from invoice date. Past due accounts are subject to the maximum legal rate of interest. Payment is to be in U.S. dollars.

### (3) TAX

All sales, use or other taxes imposed on any transaction between JCM Industries, Inc. and the Buyer shall be paid in full by Buyer. Such taxes will be added to the amount shown payable on the invoice.

### (4) BIDS AND QUOTATIONS

Specific bids and quotations will be honored for thirty (30) days from written quotation unless otherwise specified therein. Buyer may with the express written consent of JCM Industries, Inc. make changes in the specifications for material or work covered by the contract. In such event the contract price and delivery dates shall be equitably adjusted. JCM Industries, Inc. shall be entitled to payment for reasonable costs and expenses incurred by it for works and materials rendered unnecessary as a result of such changes and for works and materials required to effect said changes, plus JCM Industries, Inc. usual profit thereon.

### (5) FREIGHT, SHIPMENT AND TITLE

All sales are made F.O.B. JCM Industries, Inc. shipping point. JCM Industries, Inc. shall have the right to select the carrier and route of shipment. Title for products shipped by JCM Industries, Inc. passes to Buyer upon delivery to the carrier.

### (6) INSPECTION AND CLAIMS

All products and parts shall be finally inspected and accepted within ten (10) days after receipt. All claims whatsoever by Buyer (including claims for shortages) excepting only those provided for under the Warranty and Limitation of Liability clauses hereof must be made within said ten (10) day period or they are waived. Title and risk of loss or damage to products shipped by JCM Industries, Inc. passes to the Buyer upon delivery to the carrier. JCM Industries, Inc. will not file claims against carriers for Buyer but will render reasonable assistance to Buyer in filing any such claim.

### (7) RETURNS AND CANCELLATIONS

Returns will be accepted only with prior written authorization by JCM Industries, Inc. All returns made without prior written authorization will be refused or returned to the shipper at his expense. Authorized returns are subject to a fifty percent (50%) or a minimum twenty-five dollars (\$25.00) handling charge. No credit will be allowed for products which cannot be made resalable, products manufactured to Buyer's specifications nor any obsolete products. Any returned material requiring reconditioning will be subject to charges equal to those necessary to make the products resalable. Material or work which remains to be furnished may be canceled by Buyer only with the express written consent of JCM Industries, Inc. In the event of such cancellation, JCM Industries, Inc. shall be entitled to payment for the cost and expenses incurred by it in connection with the material or work so canceled, plus an amount determined by applying JCM Industries, Inc. usual rate of profit for similar items to such costs and expenses, or fifteen percent (15%) of the contract price.

### (8) WARRANTY - LIMITATION OF LIABILITY - EXCLUSION OF WARRANTIES

All products manufactured by JCM Industries, Inc. are carefully inspected prior to shipment. Each product is warranted against defects in materials and workmanship. In the event a product is found to be defective in materials or workmanship the Buyer's exclusive remedy under this warranty is expressly limited to replacement, repair or repayment of the purchase price at the option of JCM Industries, Inc. The net invoiced price is the limit of liability. No claims or any consequential or special damages will be allowed. Any defective parts of products must be held for inspection by JCM Industries, Inc. and returned to JCM Industries, Inc. Nash, Texas, promptly upon request. THE FOREGOING WARRANTIES AND REMEDIES ARE EXCLUSIVE, AND ARE IN LIEU OF ALL OTHER WARRANTIES (WHETHER WRITTEN, ORAL OR IMPLIED) INCLUDING WARRANTY OF MERCHANTABILITY AND WARRANTY OF FITNESS FOR A PARTICULAR PURPOSE. ALL CLAIMS FOR BREACH OF WARRANTY SHALL BE PRESENTED TO SELLER WITHIN THIRTY (30) DAYS AFTER DISCOVERY OF THE DEFECT IN THE GOODS, OR BE BARRED.

### (9) DELIVERY

Delivery dates indicated in order confirmations are approximate and are based on prompt receipt of all necessary information regarding the products covered by the contract. JCM Industries, Inc. will use its best efforts to meet the indicated delivery dates, but cannot be held responsible for its failure to do so due to fire, war, civil commotion, strikes, failure of transportation, any act of God, or other causes beyond its control. In the event of any delay in delivery caused by Buyer, JCM Industries, Inc. will store and handle all items ordered at Buyer's risk and will invoice Buyer for the unpaid portion of the contract price, on or after the date on which the products is ready for delivery. This amount will become due and payable in full within thirty (30) days from invoice date. A monthly storage and extra handling charge of one percent (1%) per month or any fraction thereof of the contract price covering the stored product shall be billable as a separate item.

### (10) PRODUCT IMPROVEMENT

Products produced by JCM Industries, Inc. are engineered to meet service requirements. From time to time products will be improved at the discretion of JCM Industries, Inc. When this occurs, previous designs will not be replaced in the field unless they have been proven defective.

### (11) CONTRAVENING LAW

Should any term or provision contained in the contract contravene or be invalid under applicable law, the contract shall not fail by reason thereof but shall be construed in the same manner as if such term or provision had not appeared therein.

### (12) DEFAULT

Notwithstanding anything herein above to the contrary, all sums due and owing and not paid within thirty (30) days from invoice date shall bear interest at the rate of eighteen (18%) percent per annum from the date incurred until paid. Buyer agrees to pay not only all invoiced amounts, but also interest as provided above and all costs and expenses of collecting the above, including but not limited to court costs, attorney fees reasonable in relation to the work expended, and expenses and costs related to recovery and protection of the goods sold; all sums payable to JCM Industries, Inc. at its offices in Nash, Bowie County, Texas. To secure the payment of all the above sums, principal, interest, and expenses and costs, Buyer hereby grants to JCM Industries, Inc., a security interest in all goods sold to Buyer by JCM Industries, Inc., and all proceeds from, products of, accessions to, and documents of title concerning such goods.

### (13) GENERAL

This Agreement and all sales transactions made pursuant to this Agreement shall be governed by the laws of the State of Texas, and to the extent applicable any federal laws having application within the State of Texas. It is provided that in no event whatsoever shall interest be contracted for, charged, or collected in excess of the maximum interest allowable by law.

**JCM INDUSTRIES, INC. PRICE CATALOG INDEX**  
**JULY 19, 2021**

**General Information**

Terms and Conditions of Sale .....	Inside Front Cover
Industry Comparison Guide.....	100-101
Pipe O.D. Guide.....	Back Cover

**JCM REPAIR FITTINGS..... Page**

101 Universal Clamp Couplings – Standard Range.....	2
102 Universal Clamp Couplings – Extended Range.....	3
103-164 Tapped Universal Clamp Couplings.....	17
105 – 135 Collar Leak Clamps.....	4
106 Bell Joint Leak Clamps – IPS PVC Pipe.....	5
108 Sewer Clamp Couplings.....	6
110 Patch Clamps.....	7
111 Full Repair Clamps.....	8
112 – 113 Heavy Duty Patch Clamps.....	9
114 Fabricated Mechanical Joint Repair Sleeve.....	20-21
116 Fabricated Repair Sleeve Concrete Steel Cylinder Pipe.....	22-23
118 Fabricated Repair Sleeve.....	24-25
121 Gas Repair Clamp.....	10
131 All Stainless Steel UCC – Standard Range.....	12
132 All Stainless Steel UCC – Extended Range.....	13
136 Heavy Duty Repair Clamp.....	26
143 Bell Joint Leak Clamp.....	5
151 All Stainless Steel Gas Repair Clamp.....	11
159 Abandoned Corporation Cap.....	18-19
161 All Stainless Steel Fabricated Lug Repair Clamp.....	14
162 All Stainless Steel Fab Lug Repair Clamp Ext Range.....	15
168 – 169 All Stainless Steel Fab Lug Lightweight Clamp.....	16
171 UCC Removeable Lug – Standard Range.....	2
172 UCC Removeable Lug – Extended Range.....	3
JCM Bolt Options.....	42

**JCM CONNECTION FITTINGS..... Page**

201 Steel Couplings.....	27-28
202 Long Steel Couplings.....	29
203 Steel Transition Coupling.....	30
204 Steel Reducing Coupling.....	30
210 Ductile Iron Couplings.....	31-32
211 Ductile Iron Couplings for Steel, IPS PVC, IPS HDPE.....	32
212 Ductile Iron Transition Couplings.....	33
214 Ductile Iron End Cap Couplings.....	34
215 Long Ductile Iron Coupling.....	35
219 Restrained Ductile Iron Coupling.....	36
220 Galvanized Compression Coupling.....	36
225 Insulating Adapter Gasket.....	36
200 Series Transition Gaskets.....	37
230 – 231 Stainless Steel Stiffener for HDPE Pipe.....	38
241 Standard Length Optimum Range Coupling.....	39
242 Long Length Optimum Range Coupling.....	39
250 Mechanical Joint Coupling.....	49
262 Fabricated Stainless Steel Coupling.....	40-41

301 Ductile Iron Flanged Coupling Adapters.....	43
303 Fabricated Steel Flanged Coupling Adapter.....	44
304 Reducing Fabricated Steel Flanged Coupling Adapter.....	45
306 Fabricated Ductile Flanged Coupling Adapter.....	46
307 Fabricated Ductile Reducing Flanged Coupling Adapter.....	46
309 Fabricated Dismantling Joint.....	47
362 Fabricated Stainless Steel Flanged Coupling Adapter.....	48

**JCM TAPPING/BRANCHING FITTINGS..... Page**

401 Single Strap Service Saddle.....	51
402 Double Strap Service Saddle.....	52
403 Wide Body Service Saddle – SS Strap.....	51
404 Service Saddle with Double Stainless Steel Straps.....	52
405 Coated Wide Body Service Saddle – SS Strap.....	53
406 Coated Service Saddle with Double SS Straps.....	54
407 Coated Single Strap Service Saddle.....	53
408 Coated Double Strap Service Saddle.....	54
425 Service Saddle for Concrete Steel Cylinder Pipe.....	58
502 Stainless Steel Service Saddle.....	55

411 Fabricated Tapping Sleeve – Plain End Outlet.....	59
412 Fabricated Tapping Sleeve – Flanged Outlet.....	59-61
413 Fabricated Tapping Cross.....	59
414 Fabricated Mechanical Joint Tapping Sleeve.....	88
415 Fabricated Tapping Sleeve for Concrete Steel Cyl Pipe.....	89-90
416 Weld On Tapping Outlet.....	81
417 Weld On Tapping Sleeve.....	81
418 Fabricated Threaded Outlet Tapping Sleeve.....	56
419 Fabricated Tapping Slv – Mechanical Joint Outlet.....	62-64
422 Fabricated Tapping Slv – PVC, HDPE, Steel Pipe.....	68-69
429 Fab Tap Slv – Mech. Joint Outlet – PVC, HDPE, Steel.....	70-71
432 All Stainless Steel Tap Slv – Full Gasket.....	72-73
438 All Stainless Steel Threaded Outlet Tap Slv.....	57
439 All Stainless Steel Tap Slv – SS MJ Outlet – Full Gskt.....	74-75
440 Line Stop Fittings.....	85-87
452 All Stainless Steel Tap Slv – Outlet Seal Gasket.....	76-78
459 All Stainless Steel Tap Slv – MJ Outlet – Outlet Gskt.....	65-67
462 SS Tapping Sleeve – Carbon Stl Flange – Full Gasket.....	72-73
464 SS Tapping Sleeve – Carbon Stl Flange – Outlet Gskt.....	76-78
465 SS Tapping Sleeve – Carbon MJ Outlet – Outlet Gskt.....	65-67
469 SS Tapping Sleeve – Carbon MJ Outlet – Full Gasket.....	74-75

**JCM RESTRAINERS..... Page**

600 Sur-Grip Restrainers.....	91-92
607 Fab Weld On Restrainer Anchor Loops.....	94
617 Fab Weld On Restrainer Anchor Loops – Assembly.....	94
630 – 631 Fab Restrainers for Asbestos Cement Pipe.....	93
650 HDPE Mechanical Wall Anchor.....	95

**JCM FABRICATIONS, TOOLS AND ACCESSORIES..... Page**

801 – 802 Expansion Joints.....	97-98
800 Fabricated Tees, Spools and Wall Fittings.....	96
Tools, Sockets, OD Tapes.....	99

**JCM TAPPING SLEEVES FOR HDPE..... Page**

General Information.....	82
Tapping Sleeves.....	83-84

# JCM 101 Universal Clamp Couplings

## JCM 171 Removeable Lug Universal Clamp Couplings

Clamp Width - Inches  
# Approximate Weight - Lbs

Nom Pipe Size (IN)	Clamp OD Range (IN)	Clamp Number	6	7	12	15	18	24	30
1-1/2	1.88 - 2.15	0190	\$129.20 7#		\$224.40 14#				
2 - 2-1/2	2.35 - 2.63 2.70 - 3.13	0238 0275	129.20 8#	136.00 9#	224.40 15#	\$270.10 19#			
3	3.46 - 3.70 3.73 - 4.13	0350 0400	162.80 8#	171.20 10#	259.40 16#	323.70 20#			
4	4.45 - 4.75 4.74 - 5.14 4.95 - 5.35 5.22 - 5.62	0450 0480 0500 0525	168.50 9#	177.70 11#	280.60 18#	339.60 22#	410.10 25#	549.80 36#	717.80 44#
6	5.95 - 6.35 6.56 - 6.96 6.85 - 7.25 7.05 - 7.45 7.45 - 7.85	0600 0663 0690 0710 0745	200.00 10#	210.60 12#	337.10 19#	386.70 24#	503.30 29#	686.80 38#	824.30 48#
8	7.95 - 8.35 8.54 - 8.94 8.99 - 9.39 9.27 - 9.67 9.90 - 10.30	0800 0863 0905 0940 1000	235.10 11#	247.30 13#	396.50 21#	453.30 27#	577.70 32#	737.80 42#	921.60 53#
10*	10.60 - 11.00 11.04 - 11.44 11.34 - 11.74 11.75 - 12.15 12.00 - 12.40	1075 1110 1140 1175 1200		323.70 25#	507.10 36#	584.60 28#	813.20 52#	1,054.70 70#	1,254.80 78#
12*	12.60 - 13.02 13.10 - 13.50 13.40 - 13.80 13.70 - 14.10 14.00 - 14.40	1275 1320 1340 1370 1400		367.90 26#	584.30 37#	666.10 40#	917.40 58#	1,213.00 74#	1,430.70 110#
<b>Number of Bolts</b>			2	2	4	4	6	8	10

JCM Universal Clamp Couplings meet or exceed ANSI/AWWA C230 as applicable.

### How to Order:

1. Determine O.D. of Pipe
2. Select proper clamp O.D. range and width.
3. Determine Model Number. Model 101 of Standard Clamp, Model 171 for Removeable Lug Clamp
4. Specify clamp number. Example: For Cast Iron Pipe, 6.90 O.D., 6" wide, order: 101-0690-6 or 171-0690-6

\*Clamp widths 7" & 15" use 5/8" bolts

Available Options: Special sizes/ranges not listed, Conductive Buttons, Specialty Gaskets

For threaded outlet clamps, see JCM Tapped Clamps

Clamps do not prevent lateral movement of pipe. Applications in which the pipe may move out of the clamp, proper anchorage must be provided.

### MATERIAL SPECIFICATIONS

- Band:** 18-8 Type 304 Certifiable Prime Stainless Steel
- Lugs:** Ductile Iron ASTM A-536, 60-40-18
- Bolts:** Corrosion resistant low alloy per ASTM A242, ANSI A21.11, AWWA C-111. National coarse rolled thread and heavy hex nut.
- Gasket:** Virgin Styrene-Butadiene Rubber (SBR) - Compounded for use with water, salt solutions, mild acids and bases. Per ASTM D-2000 M4AA 607. Standard temperature range from -40° to 150°F (-40° to 65° C) constant, maximum intermittent 180° F (82° C). Corrosion resistant shop coat paint primer.
- Coating:**
- Pressure Rating:** Pressure holding capabilities vary according to application. For specific pressure ratings, contact JCM Industries Technical Services.



Certified to  
NSF/ANSI/CAN 61  
& NSF/ANSI 372

# JCM 102 Extended Range Universal Clamp Couplings JCM 172 Removeable Lug Extended Range Universal Clamp Couplings

## Double Band Clamps

Clamp Width - Inches  
# Approximate Weight - Lbs

Nom Pipe Size (IN)	Clamp OD Range (IN)	Clamp Number	6	7	12	15	18	24	30
4	4.44 - 5.24	0450	\$ 243.60	\$ 265.20	\$ 414.40	\$ 502.50	\$ 636.10	\$ 784.90	\$ 1,030.90
	4.74 - 5.57	0480	16#	20#	32#	40#	48#	64#	80#
6	6.62 - 7.42	0663	283.60	310.00	456.40	583.00	760.50	901.00	1,182.90
	6.84 - 7.64	0690	16#	20#	32#	40#	48#	64#	80#
8	8.62 - 9.42	0863	332.80	349.80	513.90	664.30	852.90	987.30	1,356.60
	8.99 - 9.79	0905	17#	21#	34#	43#	51#	68#	85#
10	10.72 - 11.72	1075			692.70		1,042.80	1,393.30	1,772.30
	11.04 - 12.24	1110			55#		82#	110#	129#
12	12.72 - 13.92	1275			736.60		1,100.30	1,537.20	1,936.40
	13.14 - 14.34	1320			58#		85#	106#	132#
14	15.20 - 16.20	1530			1,025.80		1,660.30	2,183.50	2,996.60
					58#		87#	106#	145#
14-16	16.00 - 17.00	1600			1,084.50		1,727.50	2,427.00	3,189.30
	17.20 - 18.20	1740			61#		89#	108#	148#
16-18	18.40 - 19.40	1846			1,124.90		1,786.80	2,555.90	3,317.90
					62#		119#	124#	158#
18-20	19.40 - 20.40	1950			1,144.10		1,855.30	3,042.10	3,376.30
	20.40 - 21.40	2050			63#		119#	126#	158#
20-22	21.40 - 22.40	2160			1,211.60		1,974.00	3,229.70	3,573.60
	22.50 - 23.60	2260			67#		122#	134#	168#
<b>Number of Bolts</b>			4	4	8	8	12	16	20

## JCM 102 Multi-Band Clamps - Larger, custom sizes and widths available

24	23.80 - 25.00	2400			\$ 1,951.50		\$ 2,820.70	\$ 4,724.10	\$ 5,722.90
	25.50 - 26.70	2580			93#		151#	186#	250#
	27.90 - 29.10	2800							
24-30	29.80 - 31.00	3000			2,359.10		3,486.40	4,964.20	6,515.70
	31.70 - 32.90	3200			105#		147#	196#	265#
36	37.85 - 39.20	3830			2,584.00		3,881.30	5,575.30	7,367.40
					151#		175#	234#	292#

JCM Universal Clamp Couplings meet or exceed ANSI/AWWA C230 as applicable.

### How to Order:

1. Determine O.D. of Pipe
2. Select proper clamp O.D. range and width.
3. Determine Model Number. Model 102 of Standard Clamp, Model 172 for Removeable Lug Clamp
4. Specify clamp number. Example: For Cast Iron Pipe, 6.90 O.D., 6" wide, order: 102-0690-6 or 172-0690-6

Clamps do not prevent lateral movement of pipe. Applications in which the pipe may move out of the clamp, proper anchorage must be provided.

Available Options: Special sizes/ranges not listed, Conductive Buttons, Specialty Gaskets

For threaded outlet clamps, see JCM Tapped Clamps

### Material Specifications

- Band:** 18-8 Type 304 Certifiable Prime Stainless Steel  
**Lugs:** Ductile Iron ASTM A-536, 60-40-18  
**Bolts:** Corrosion resistant low alloy per ASTM A242, ANSI A21.11, AWWA C-111. National coarse rolled thread and heavy hex nut.  
**Gasket:** Virgin Styrene-Butadiene Rubber (SBR) - Compounded for use with water, salt solutions, mild acids and bases. Per ASTM D-2000 M4AA 607. Standard temperature range from -40° to 150°F (-40° to 65° C) constant, maximum intermittent 180° F (82° C).  
**Coating:** Corrosion resistant shop coat paint primer.  
**Pressure Rating:** Pressure holding capabilities vary according to application. For specific pressure ratings, contact JCM Industries Technical Services.



Certified to  
NSF/ANSI CAN 61  
& NSF/ANSI 372

## JCM 105 Collar Leak Clamps

### JCM 135 All Stainless Steel Collar Leak Clamps

Nom Pipe Size (IN)	Clamp OD Range (IN)	Clamp Width	Clamp Number	Model 105 List Price Each	Appr Wt Lbs	Model 135 List Price Each	Appr Wt Lbs
2	2.38	6	0238-6	\$ 143.90	7.3	\$ 217.30	5.3
	2.38	7	0238-7	151.60	9.3	228.00	6
2-1/2	2.88	6	0288-6	150.50	7.7	224.90	5.7
	2.88	7	0288-7	162.90	9.9	236.50	6
3	3.50	6	0350-6	166.40	8.9	243.70	6
	3.50	7	0350-7	182.40	10	260.70	7
4	4.50	6	0450-6	187.20	9.1	268.80	6
	4.50	7	0450-7	195.80	11	285.20	7
5	5.56	6	0556-6	201.70	9.4	286.90	6.5
	5.56	7	0556-7	211.20	11	304.00	7
6	6.63	6	0663-6	231.20	10	320.70	7.5
	6.63	7	0663-7	235.90	12	335.90	8.5
8	8.63	6	0863-6	257.30	11	353.80	8.7
	8.63	7	0863-7	272.00	13	371.80	9.5

#### BELL END CLASS 160, 200, SCH 40 COUPLING AND BELL END

JCM Universal Clamp Couplings meet or exceed ANSI/AWWA C230 as applicable.

### JCM 105 Collar Leak Clamp for Plastic Irrigation Pipe - PIP

Nom Pipe Size (IN)	Clamp OD Range (IN)	Clamp Width	Pipe Wall Thickness	Clamp Number	List Price Each	Appr Wt Lbs
4	4.125	6	0.125	105-0413-6	\$ 187.20	9.1
6	6.140	6	0.150	105-0614-6	231.20	9.8
8	8.160	6	0.199	105-0816-6	257.30	13.0
10	10.200	6	0.249	105-1020-6	385.40	14.1
12	12.240	6	0.290	105-1224-6	438.20	18.0
15	15.300	6	0.375	105-1530-6	535.40	25.0

Other widths available upon request

For Quick, Permanent repairs of solvent weld PVC pipe joints.



**JCM 105/135 Collar Leak Clamps** provide a simple, quick solution to troublesome leaks in PVC solvent weld pipe systems - without having to cut out fittings or modifying your system. These heavy duty clamps have many features which assure a successful repair, even under the most adverse conditions.

#### Material Specifications

**Lugs:** Model 105 - Ductile Iron per ASTM A536

Model 135 - CF8 Cast stainless steel, equal to 304 stainless.

**Band:** Stainless Steel 18-8 Type 304 per ASTM A240 as applicable.

**Gasket:** Compounded for use with sewage, water, salt solutions, mild acids, and bases.

**Bolts & Nuts:** Model 105 - Corrosion resistant, high strength low alloy A242 (ANSI/AWWA C111/A21.11);

Model 135 - Stainless steel, 18-8 Type 304

**Finish:** Model 105 - Corrosion resistant shop coat paint primer.





## JCM 106 Bell Joint Leak Clamps - IPS PVC, IPS HDPE



**JCM 106 Bell Joint Leak Clamps** - For quick repair or water tight joint assurance for rubber joint PVC pipe, solvent weld pipe or coupled pipe specify JCM 106 Bell Joint Leak Clamps. These clamps are engineered to provide a simple, dependable repair or assured joint. In addition, the JCM 106 eliminates possible notching of PVC pipe and offers maximum versatility and corrosion resistance.

Nom Pipe Size (IN)	Clamp OD Range (IN)	Catalog Number	List Price Each	Appr Wt Each Lbs	Max Bell OD	Max Lip OD	Overall Length*	Max Std Cplg Length
4	4.50	106-0450	\$ 303.80	12	6.13	5.43	11.5	7
6	6.63	106-0663	333.70	17	8.25	7.56	11.5	7
8	8.63	106-0863	461.40	21	10.88	9.56	11.5	7

Dimensions shown in inches

\*Dimension will change with use of studs

## JCM 143 Pipe Sizes 4" - 12" Cast Iron Pipe, Ductile Iron Pipe, C-900 PVC

Strong - Split, interlocking rings provide a solid base for maximum gasket compression. Heavy duty ductile iron components for the life of the pipeline. Clamp comes complete to repair cast iron, ductile iron and C-900 PVC in its nominal size. Simple transfer from shelf to job site to pipe joint without confusion. Install under pressure to repair leaking joint or install as a leak preventative on older pipe joints that have been excavated or disturbed during other pipeline maintenance (a low-cost, long-term insurance policy).

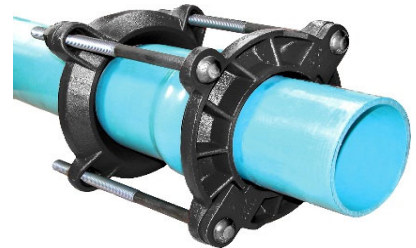

## JCM 143 Pipe Sizes 14" and Larger for Ductile Iron/Cast Iron Pipe, C900, HDPE Fused Couplings

Fabricated Bell Joint Leak Clamps with split, bolt-on designed provides a positive seal for large diameter Ductile Iron and Cast Iron leaking bells. Designed for long-term service and immediate delivery

## JCM 143 Bell Joint Leak Clamps - CI, DI, C900, DI/HDPE

Nom Pipe Size (IN)	Clamp OD Range (IN)	Catalog Number	Max Bell OD (IN)	List Price Each	Appr Wt Each Lbs
4	4.80 - 5.00	143-0480	8.69	\$ 300.80	23
6	6.90 - 7.10	143-0690	11.13	332.10	27
8	9.05 - 9.30	143-0905	13.50	460.10	43
10	11.10 - 11.40	143-1110	15.50	619.60	51
12	13.20 - 13.50	143-1320	17.88	715.00	59
14	15.30	143-1530	20.56	2,574.60	150
16	17.40	143-1740	23.25	2,960.00	160
18	19.50	143-1950	25.75	3,181.90	220
20	21.60	143-2160	27.94	3,472.70	318
24	25.80	143-2580	32..38	4,065.70	380
30	32.00	143-3200	38.88	4,939.90	500
36	38.30	143-3830	45.31	6,158.50	691



JCM 143 Bell Joint Leak Clamp 14" and Larger - Fabricated Steel

Sizes 14" and larger based on working ranges of industry standard pipe tolerances +/-

To ensure exact fit when ordering provide specific bell/spigot outside diameters.

Larger Sizes & Other Ranges Available, Contact JCM Sales Team 1-800-527-8482 or 903-832-2581.

## JCM 108 Universal Clamp Coupling for Sewer Pipe

For quick, economical, permanent connection of sewer pipe, straight connections of the same type of pipe, or transition from one type of pipe to another.

The JCM 108 Universal Clamp Coupling for sewer pipe is designed to connect and repair all types of gravity flow sewer pipe. Each clamp coupling has a wide range of sizes to accommodate the manufacturing tolerances of this type of pipe. This assures a simple and proper installation even under the most adverse field conditions. JCM 108 Universal Clamp Couplings are furnished standard to join pipe of the same outside diameter. Transition gasket material is furnished with the clamp coupling when a transition is indicated.

JCM 108 UCC for Sewer Pipe is Priced on Application. For quotation, contact the JCM Inside Sales Team at 1-800-527-8482 or 1-903-832-2581.

108 Straight Clamp Coupling



Repair or connection of similar OD pipe

108 Transition Clamp Coupling



Repair or connection of different OD Pipes

138 All Stainless Clamp Coupling



For hot or acidic soil conditions.  
Available in both straight and transition

1. Determine type of pipe and outside diameters of each end to be joined.
2. Determine and advise of any special factors involved - such as pressure sewer line or unusual line content.
3. Order Universal Clamp Coupling as follows:

A. For repairing or joining pipe with same O.D., refer to JCM 101, 102 Universal Clamp Couplings and order clamp to fit O.D. of pipe.

B. Joining ends with different O.D.'s, provide O.D.'s and type of pipe to JCM Inside Sales Team.

JCM 108 Universal Clamp Couplings for sewer pipe are fabricated to fit these types of pipe:

- SDR35 PVC Sewer Pipe
- Clay Pipe
- Cast Iron Soil Pipe
- Asbestos Cement
- C-900 PVC, IPS PVC

### Material Specifications

**Lugs:** Model 108 - Ductile Iron per ASTM A536 **Finish:** Shopcoat Primer

Model 138 - CF8 Cast stainless steel, equal to 304 stainless.

**Band:** Stainless Steel 18-8 Type 304 per ASTM A240 as applicable.

**Gasket:** Compounded for use with sewage, water, salt solutions, mild acids, and bases.

**Bolts & Nuts:** Model 108 - Corrosion resistant, high strength low alloy A242 (ANSI/AWWA C111/A21.11);

Model 138 - Stainless steel, 18-8 Type 304

### Transition Gasket

**Material (Ra-Seal):** Pliable butyl rubber sealant for temperature range -65° to 180° F.

# JCM 110 Patch Clamps

Nom Pipe Size (IN)	Pipe OD Range (IN)	Clamp Number	Width Inches	E-Galv Bolt List Price	SS Bolt Add (SS) List Price	All Stainless Add (AS) List Price	Wt Ea Lbs	Ctn Qty
1/2	0.84	0084	3	\$ 15.00	\$ 25.90	\$ 55.60	0.6	20
			6	27.10	49.40	99.90	1.2	10
3/4	1.05	0105	3	15.20	26.20	56.40	0.6	16
			6	28.70	50.70	100.20	1.5	8
1	1.32	0132	3	16.80	28.10	59.00	0.6	16
			6	30.40	52.60	104.30	1.4	8
1-1/4	1.66	0166	3	17.70	28.30	59.30	1.5	12
			6	31.30	53.80	106.10	2.3	6
1-1/2	1.9	0190	3	18.30	28.80	66.90	1.5	12
			6	34.00	56.40	127.80	2.3	6
2	2.38	0238	3	20.30	31.00	67.80	1.7	8
			6	36.20	59.00	132.30	2.3	4
			9	55.50	89.60	206.70	3.4	2
2-1/2	2.88	0288	12	73.30	118.30	275.60	4.5	2
			3	26.10	36.30	71.70	1.7	8
			6	49.50	71.80	130.60	2.4	4
3	3.5	0350	9	73.60	107.50	208.80	3.6	2
			12	99.90	144.70	277.70	4.8	2
			3	26.70	37.60	73.30	1.8	8
4	4.5	0450	6	53.40	75.90	134.10	2.2	4
			9	87.70	121.50	209.80	4.8	2
			12	118.70	163.80	280.20	6.4	2
5	5.56	0556	3	30.50	42.30	74.90	1.8	8
			6	56.70	80.50	133.70	3.2	4
			9	105.90	141.50	213.40	4.8	2
6	6.63	0663	12	142.70	191.40	283.60	6.4	2
			3	34.60	46.70	77.80	1.8	8
			6	68.90	74.00	136.80	4	4
8	8.63	0863	9	116.70	152.00	215.80	5.1	-
			12	155.80	204.40	287.50	6.8	-
			3	36.40	48.40	80.20	1.9	8
10	10.75	1075	6	69.40	93.40	139.30	4	4
			9	120.70	156.30	218.20	5.7	-
			12	161.30	209.80	291.40	7.6	-
12	12.75	1275	3	42.80	54.60	82.70	2.2	8
			6	83.10	88.00	141.50	5	4
			9	132.10	167.50	220.70	6.6	-
12	12.75	1275	12	204.40	253.30	293.20	8.8	-



## Double Band Clamps for Steel Pipe Sizes

10	10.75	1075	3	\$ 78.80	\$ 102.80	\$ 135.90	7	-
			6	163.40	211.50	244.30	15	-
			9	267.90	339.10	372.00	21	-
12	12.75	1275	12	349.90	445.30	476.60	27	-
			3	91.00	115.10	149.10	8.5	-
			6	175.50	223.40	256.10	18	-
12	12.75	1275	9	281.70	353.50	386.30	27	-
			12	366.80	455.90	487.60	40	-

### Material Specifications:

**Lugs:**  
ASTM A536 Ductile Iron  
Optional CF8 Stainless Steel

**Gasket:**  
Buna N

## Copper Tube Sizes

1/2	0.63	0063	3	\$ 15.00	\$ 25.90	\$ 55.60	0.6	20
			6	27.10	49.40	99.90	1.2	10
3/4	0.88	0084	3	15.00	25.90	55.60	0.6	16
			6	27.10	49.40	99.90	1.2	8
1	1.13	0105	3	15.20	26.20	56.40	0.6	16
			6	28.70	50.70	100.20	1.4	8
1-1/4	1.38	0132	3	16.80	28.10	59.00	0.7	12
			6	30.40	52.60	104.30	1.4	6
1-1/2	1.63	0166	3	17.70	28.30	59.30	1.1	12
			6	31.30	53.80	106.10	2.2	6
2	2.13	0213	3	20.30	31.00	67.80	1.1	8
			6	36.10	58.70	132.30	2.3	4

**Band:**  
304 Stainless Steel

**Hardware:**  
Electro-galvanized steel  
Optional 304 Stainless Steel



### How to Order

- Determine clamp size, material options and width required.
- Order by clamp number. For Stainless Steel Bolt(s), add (SS) to clamp number.  
For ALL Stainless Steel, add (AS) to clamp number.

Example:

All Stainless Steel clamp for 4" IPS/PVC with 4.50 OD 3" wide, order 110-0450-3AS

# JCM 111 Full-Repair Clamp

Steel Pipe Sizes - IPS  
Copper Tube Sizes - CTS

Nom Pipe Size (IN)	Clamp OD Range (IN)	Type of Pipe	Width Inches	Clamp Number	E-Galv Bolt List Price	SS Bolt Add (SS) List Price	All Stainless Add (AS) List Price	Wt Ea Lbs	Ctn Qty
1/2"	0.84	IPS	3	111-0084-3	\$ 40.20	\$ 50.00	\$ 105.10	0.7	20
			6	111-0084-6	79.90	99.90	184.40	1.4	10
3/4"	1.05	IPS	3	111-0105-3	40.40	50.00	106.70	0.8	16
			6	111-0105-6	80.30	100.50	186.00	1.5	8
	0.88	CTS	3	111-0088-3	40.40	48.30	105.10	0.8	16
			6	111-0088-6	80.30	100.50	184.40	1.5	8
1"	1.32	IPS	3	111-0132-3	43.00	52.70	109.30	1.3	16
			6	111-0132-6	85.00	105.40	199.20	2.5	8
	1.13	CTS	3	111-0113-3	43.00	52.70	109.30	1.3	16
			6	111-0113-6	85.00	105.40	199.20	2.5	8
1-1/4"	1.66	IPS	3	111-0166-3	44.20	54.60	120.90	1.3	12
			6	111-0166-6	87.50	108.10	200.60	2.5	6
1-1/2"	1.63	CTS	3	111-0166-3	44.20	54.60	120.90	0.9	12
			6	111-0166-6	87.50	108.10	200.60	1.8	6
	1.90	IPS	3	111-0190-3	44.70	55.00	120.90	1.3	12
			6	111-0190-6	88.00	108.70	200.60	2.6	6
2"	2.38	IPS	3	111-0238-3	49.20	59.20	126.50	1.3	8
			6	111-0238-6	90.90	111.50	213.80	3.8	4

## How to Order

1. Determine clamp size, material options and width required.
2. Order by clamp number.

For Stainless Steel Bolt(s), add (SS) to clamp number.

For ALL Stainless Steel, add (AS) to clamp number.

Example:

All Stainless Steel clamp for 2" IPS/PVC with 2.38 OD 3" wide, order 111-0238-3AS

## Material Specifications

**Lug:** Ductile Iron ASTM A536. Optional CF8 Cast Stainless Steel, equal to 304.

**Gasket:** Buna - N

**Band:** Stainless Steel 18-8 Type 304

**Hardware:** Electro-galvanized steel. Optional 304 Stainless Steel

**JCM 111 Full-Repair Clamps** are a fast economical means of permanently repairing steel pipe with extensive corrosion, splits, punctures or pin holes. These clamps have a heavy, full circumferential Buna-N gasket with a hardened recessed armor. This provides extra sealing capability for heavily damaged pipe and pipe with reduced diameter due to corrosion.



Certified to  
NSF/ANSI CAN 61  
& NSF/ANSI 372

## JCM 112 Heavy Duty Patch Clamp

Nom Pipe Size (IN)	Clamp OD Range (IN)	Clamp Number	Width Inches	List Price Each	Wt Ea Lbs
1-1/2	1.90 - 2.00	112-0190-6	6	\$ 116.10	6
		112-0190-12	12	202.00	12
2	2.38 - 2.50	112-0238-6	6	116.90	6
		112-0238-12	12	202.00	12
2-1/2	2.88 - 3.00	112-0288-6	6	116.90	6
		112-0288-12	12	202.00	12
3	3.50 - 3.88	112-0350-6	6	146.60	6
		112-0350-12	12	233.30	13
3-1/2	4.00 - 4.35	112-0400-6	6	146.60	7
		112-0400-12	12	233.30	14
4	4.50 - 4.85	112-0450-6	6	151.70	8
		112-0450-12	12	252.50	15
5	5.56 - 6.00	112-0556-6	6	180.00	8
		112-0556-12	12	308.50	15
6	6.63 - 6.90	112-0663-6	6	183.40	8
		112-0663-12	12	308.50	16
8	8.63 - 9.05	112-0863-6	6	211.70	8
		112-0863-12	12	356.90	17
10	10.00 - 10.30	112-1000-6	6	211.70	9
		112-1000-12	12	356.90	18
	10.75 - 11.10	112-1075-6	6	291.20	9
		112-1075-12	12	456.60	18
12	12.00 - 12.30	112-1200-6	6	291.20	9
		112-1200-12	12	456.60	18
	12.75 - 13.05	112-1275-6	6	331.10	10
		112-1275-12	12	456.60	20

## JCM 113 Multi-Band Patch Clamp

10	10.00 - 10.75	113-1000-6	6	\$ 310.60	17
		113-1000-12	12	623.30	34
12	12.00 - 12.75	113-1200-6	6	331.40	19
		113-1200-12	12	663.00	38
14	14.00 - 14.75	113-1400-6	6	461.60	20
		113-1400-12	12	923.10	40
16	16.00 - 16.75	113-1600-6	6	488.00	23
		113-1600-12	12	975.90	46
18	18.00 - 18.75	113-1800-6	6	488.00	24
		113-1800-12	12	975.90	49
20	20.00 - 20.75	113-2000-6	6	530.40	26
		113-2000-12	12	1,029.70	52
22	22.00 - 22.75	113-2200-6	6	545.10	27
		113-2200-12	12	1,090.40	54
24	24.00 - 24.75	113-2400-6	6	878.20	28
		113-2400-12	12	1,756.10	56
30	30.00 - 30.75	113-3000-6	6	1,061.70	29
		113-3000-12	12	2,123.10	58
36	36.00 - 36.75	113-3600-6	6	1,097.00	31
		113-3600-12	12	2,193.90	62

Larger and custom sizes available, contact JCM Industries, Inc.

For complete breaks, see JCM Universal Clamp Couplings



**112 and 113 Heavy Duty Patch Clamps** provide fast, permanent repair of pin holes, punctures or splits in steel and other types of pipe where a beam break is not involved. The clamps are readily available for all sizes of pipe 1-1/2" and larger.

# JCM 121 Gas Repair Clamps

Meets the Department of Transportation Code 192

Nom Pipe Size (IN)	Clamp OD Range (IN)	Clamp Number	Clamp Width - Inches						
			# Approximate Weight - Lbs						
			6	7	12	15	18	24	30
1-1/2	1.88 - 2.15	121-0190	\$ 142.10 8#		\$ 247.00 15#				
2 - 2-1/2	2.35 - 2.63	121-0238	\$ 142.10 8#	\$ 149.60 9#	\$ 247.00 15#	\$ 297.20 19#			
	2.70 - 3.13	121-0275							
3	3.46 - 3.70	121-0350	179.20 8#	188.40 10#	285.30 16#	355.90 20#			
	3.73 - 4.13	121-0400							
4	4.45 - 4.75	121-0450	185.50	195.30	308.70	373.60	\$ 451.10	\$ 604.80	\$ 789.40
	4.74 - 5.14	121-0480							
	4.95 - 5.35	121-0500	9#	11#	18#	22#	26#	36#	44#
6	5.95 - 6.35	121-0600	219.80	231.80	370.80	425.40	553.90	755.50	906.80
	6.56 - 6.96	121-0663							
	6.85 - 7.25	121-0690	10#	12#	19#	24#	29#	38#	48#
8	7.95 - 8.35	121-0800		272.00	436.20	498.70	635.40	811.60	1,013.60
	8.54 - 8.94	121-0863							
	8.99 - 9.39	121-0905		13#	21#	27#	32#	42#	53#
	9.90 - 10.30	121-1000							
10*	10.60 - 11.00	121-1075		355.90	560.40	643.20	894.60	1,160.30	1,380.30
	11.04 - 11.44	121-1110							
	12.00 - 12.40	121-1200		18#	34#	36#	50#	68#	72#
12*	12.60 - 13.02	121-1275		404.70	642.90	732.70	1,009.20	1,334.30	1,573.90
	13.10 - 13.50	121-1320							
	14.00 - 14.40	121-1400		20#	37#	40#	52#	74#	80#
<b>Number of Bolts</b>			2	2	4	4	6	8	10

### How to Order:

1. Determine O.D. of Pipe
2. Select proper clamp O.D. range and width.
3. Specify clamp number. Example: For Cast Iron Pipe, 6.90 O.D., 6" wide, order: 121-0690-6

Clamps do not prevent lateral movement of pipe.

Applications in which the pipe may move out of the clamp, proper anchorage must be provided.

\*Clamp widths 7" & 15" use 5/8" bolts

Available Options: Special size/range not listed, Conductive Buttons, Specialty Gaskets

For threaded outlet clamps, see JCM Tapped Clamps

### Pressure Rating of 121 & 123 Gas Clamps:

Cast Iron Pipe:

2" through 8" 100 PSI Gas

10" through 12" 60 PSI Gas

Steel Pipe:

2" through 8" 100 PSI Gas

10" through 12" 60 PSI Gas

Do Not use for the repair of Polyethylene Gas Pipe. Suitable for reshaping and marking squeeze off locations.

### Material Specifications

**Band:** 18-8 Type 304 Certifiable Prime Stainless Steel

**Lugs:** Ductile Iron ASTM A-536, 60-40-18

**Bolts:** Corrosion resistant low alloy per ASTM A242, ANSI A21.11, AWWA C-111. National coarse rolled thread and heavy hex nut.

**Gasket:** Buna N Gasket for natural gas service

**Coating:** Corrosion resistant shop coat paint primer.



# JCM 151 All Stainless Gas Repair Clamps

Meets the Department of Transportation Code 192

Nom Pipe Size (IN)	Clamp OD Range (IN)	Clamp Number	Clamp Width - Inches						
			6	7	12	15	18	24	30
1-1/2	1.88 - 2.15	151-0190	\$ 208.00 8#		\$ 337.60 15#				
2 - 2-1/2	2.35 - 2.63 2.70 - 3.13	151-0238 151-0275	\$ 208.00 5#	\$ 221.00 6#	\$ 337.60 10#	\$ 406.30 12#			
3	3.46 - 3.70 3.73 - 4.13	151-0350 151-0400	240.60 6#	269.60 7#	408.90 11#	483.50 13#			
4	4.45 - 4.75 4.74 - 5.14 4.95 - 5.35	151-0450 151-0480 151-0500	281.90 6#	297.00 7#	484.10 12#	531.10 14#	\$ 735.20 18#	\$ 932.60 24#	\$ 1,263.60 28#
6	5.95 - 6.35 6.56 - 6.96 6.85 - 7.25	151-0600 151-0663 151-0690	331.40 7#	344.80 8#	569.10 13#	628.90 16#	872.50 21#	1,096.70 26#	1,414.40 31#
8	7.95 - 8.35 8.54 - 8.94 8.99 - 9.39 9.90 - 10.30	151-0800 151-0863 151-0905 151-1000		380.90 9#	637.20 15#	646.20 19#	981.00 24#	1,220.90 30#	1,561.40 38#
10*	10.60 - 11.00 11.04 - 11.44 12.00 - 12.40	151-1075 151-1110 151-1200		514.70 14#	899.30 24#	926.20 28v#	1,340.90 36#	1,705.00 48#	2,019.70 56#
12*	12.60 - 13.02 13.10 - 13.50 14.00 - 14.40	151-1275 151-1320 151-1400		578.60 16#	1,000.00 27#	1,063.70 33#	1,461.00 41#	1,915.70 54#	2,314.70 66#
<b>Number of Bolts</b>			2	2	4	4	6	8	10

## How to Order:

1. Determine O.D. of Pipe
2. Select proper clamp O.D. range and width.
3. Specify clamp number. Example: For Cast Iron Pipe, 6.90 O.D., 6" wide, order: 151-0690-6

Clamps do not prevent lateral movement of pipe.

Applications in which the pipe may move out of the clamp, proper anchorage must be provided.

\*Clamp widths 7" & 15" use 5/8" bolts

Available Options: Special size/range not listed, Conductive Buttons, Specialty Gaskets

For threaded outlet clamps, see JCM Tapped Clamps

## Pressure Rating of 151 & 153 Gas Clamps:

Cast Iron Pipe:

2" through 8" 100 PSI Gas

10" through 12" 60 PSI Gas

Steel Pipe:

2" through 8" 100 PSI Gas

10" through 12" 60 PSI Gas

Do Not use for the repair of Polyethylene Gas Pipe. Suitable for reshaping and marking squeeze off locations.



## Material Specifications

- Lugs:** Model CF8 Cast stainless steel, equal to 304 stainless.
  - Band:** Stainless Steel 18-8 Type 304 per ASTM A240 as applicable.
  - Gasket:** Buna N Gasket for natural gas service
  - Hardware:** Stainless steel, 18-8 Type 304
- All 316 Stainless Steel Clamp Available Upon Request

# JCM 131 All Stainless Steel Universal Clamp Couplings Cast Lug

## Single Band Clamps

Clamp Width - Inches  
# Approximate Weight - Lbs

Nom Pipe Size (IN)	Clamp OD Range (IN)	Clamp Number	6	7	12	15	18	24	30
1-1/2	1.88 - 2.15	131-0190	\$ 189.00 6#		\$ 298.20 10#				
2 - 2-1/2	2.35 - 2.63	131-0238	189.00	200.80	306.80	\$ 369.20			
	2.70 - 3.13	131-0275	5#	6#	10#	12#			
3	3.46 - 3.70	131-0350	218.90	245.10	371.70	439.60			
	3.73 - 4.13	131-0400	6#	7#	11#	13#			
4	4.45 - 4.75	131-0450							
	4.74 - 5.14	131-0480	256.50	269.90	440.10	482.70	\$ 668.50	\$ 847.90	\$ 1,148.70
	4.95 - 5.35	131-0500	6#	7#	12#	14#	18#	24#	28#
	5.22 - 5.62	131-0525							
6	5.95 - 6.35	131-0600							
	6.56 - 6.96	131-0663							
	6.85 - 7.25	131-0690	301.40	313.60	517.40	571.60	793.10	997.00	1,285.90
	7.05 - 7.45	131-0710	7#	8#	16#	16#	21#	30#	31#
8	7.45 - 7.85	131-0745							
	7.95 - 8.35	131-0800							
	8.54 - 8.94	131-0863							
	8.99 - 9.39	131-0905	346.20	360.40	587.60	680.60	891.80	1,109.90	1,419.40
10*	9.27 - 9.67	131-0940	8#	12#	17#	20#	24#	30#	38#
	9.90 - 10.30	131-1000							
	10.60 - 11.00	131-1075							
	11.04 - 11.44	131-1110							
12*	11.34 - 11.74	131-1140		468.40	817.30	841.80	1,219.00	1,550.10	1,836.10
	11.75 - 12.15	131-1175		15#	26#	31#	39#	42#	60#
	12.00 - 12.40	131-1200							
	12.60 - 13.02	131-1275							
12*	13.10 - 13.50	131-1320							
	13.40 - 13.80	131-1340		526.00	909.10	967.00	1,328.30	1,741.50	2,104.20
	13.70 - 14.10	131-1370		17#	28#	34#	42#	56#	100#
	14.00 - 14.40	131-1400							
<b>Number of Bolts</b>			2	2	4	4	6	8	10

JCM Universal Clamp Couplings meet or exceed ANSI/AWWA C230 as applicable.

### How to Order:

1. Determine O.D. of Pipe
2. Select proper clamp O.D. range and width.
3. Specify clamp number. Example: For Cast Iron Pipe, 6.90 O.D., 6" wide, order: 131-0690-6

\*Clamp widths 7" & 15" use 5/8" bolts

Available Options: Special sizes/ranges not listed, Conductive Buttons, Specialty Gaskets

For threaded outlet clamps, see JCM Tapped Clamps

Clamps do not prevent lateral movement of pipe. Applications in which the pipe may move out of the clamp, proper anchorage must be provided.

### Material Specifications

**Lugs:** Model CF8 Cast stainless steel, equal to 304 stainless.

**Band:** Stainless Steel 18-8 Type 304 per ASTM A240 as applicable.

**Gasket:** Compounded for use with sewage, water, salt solutions, mild acids, and bases.

**Bolts & Nuts:** Stainless steel, 18-8 Type 304

All 316 Stainless Steel Clamp Available Upon Request





# JCM 132 All Stainless Steel Extended Range Universal Clamp Couplings

Nom Pipe Size (IN)	Clamp OD Range (IN)	Clamp Number	Clamp Width - Inches						
			6	7	12	15	18	24	30
4	4.44 - 5.24	132-0450	\$ 386.70	\$ 412.40	\$ 677.80	\$ 789.00	\$ 1,034.50	\$ 1,355.20	\$ 1,687.90
	4.74 - 5.57	132-0480	9#	11#	24#	24#	27#	44#	48#
6	6.62 - 7.42	132-0663	434.10	467.30	723.70	888.60	1,190.30	1,443.50	1,877.50
	6.84 - 7.64	132-0690	10#	12#	25#	26#	30#	38#	55#
8	8.62 - 9.42	132-0863	497.80	518.10	804.70	1,004.00	1,306.30	1,607.20	2,096.00
	8.99 - 9.79	132-0905	11#	13#	26#	29#	33#	40#	55#
10	10.72 - 11.72	132-1075			1,127.90		1,703.50	2,235.80	2,820.70
	11.04 - 12.24	132-1110			32#	-	59#	64#	80#
12	12.72 - 13.92	132-1275							
	13.14 - 14.34	132-1320			1,219.20		1,774.40	2,437.70	3,011.70
	13.65 - 14.65	132-1365			41#		51#	68#	85#
14	15.20 - 16.20	132-1530			1,650.20		2,723.50	3,291.40	4,872.60
					36#		67#	72#	89#
14-16	16.00 - 17.00	132-1600			1,724.70		2,705.50	3,444.80	5,084.20
	17.20 - 18.20	132-1740			37#	-	56#	74#	92#
16-18	18.40 - 19.40	132-1846			1,772.30		2,787.50	3,553.40	5,240.90
					39#		59#	78#	97#
18-20	19.40 - 20.40	132-1950			1,800.60		2,870.10	3,604.20	5,309.40
	20.40 - 21.40	132-2050			41#		62#	82#	103#
20-22	21.40 - 22.40	132-2160			1,881.30		3,012.40	3,768.70	5,553.10
	22.50 - 23.60	132-2260			45#		67#	90#	111#
<b>Number of Bolts</b>			4	4	8	8	12	16	20

## JCM 132 Multi-Band Clamps - Larger, custom sizes and widths available

24	23.80 - 25.00	132-2400			\$ 2,985.20		\$ 4,334.60	\$ 5,935.10	\$ 8,790.80
	25.50 - 26.70	132-2580							
	27.90 - 29.10	132-2800			59#		88#	108#	146#
24-30	29.80 - 31.00	132-3000			3,489.60		5,160.40	6,980.00	9,758.40
	31.70 - 32.90	132-3200			64#		95#	128#	158#
36	37.85 - 39.20	132-3830			3,762.50		5,656.60	7,748.30	10,814.30
					82#		123#	164#	232#

### How to Order:

1. Determine O.D. of Pipe
2. Select proper clamp O.D. range and width.
3. Specify clamp number. Example: For Cast Iron Pipe, 6.90 O.D., 6" wide, order: 132-0690-6

Clamps do not prevent lateral movement of pipe.

Applications in which the pipe may move out of the clamp, proper anchorage must be provided.

Available Options: Special sizes/ranges not listed, Conductive Buttons, Specialty Gaskets

For threaded outlet clamps, see JCM Tapped Clamps



### JCM 132 All Stainless Steel Extd. Range Clamp Coupling -

for systems in hot soils or corrosive environments. Provides extra corrosion resistance of all stainless steel. Clamp sizes 10" and larger incorporate 3/4" lugs and bolts for extra bolting power.

All 316 Stainless Steel Clamp Available Upon Request

# JCM 161 Fabricated Lug Stainless Steel Universal Clamps

Clamp Width - Inches

## Single Band Clamps

# Approximate Weight - Lbs

Nom Pipe Size (IN)	Clamp OD Range (IN)	Clamp Number	7	12	15	18	24	30
2	2.35 - 2.63	161-0238	\$ 158.20	\$ 259.50	\$ 301.00			
	2.70 - 3.13	161-0275	5#	8#	10#			
3	3.46 - 3.70	161-0350	189.50	300.40	345.40			
	3.73 - 4.13	161-0400	6#	9#	11#			
4	4.45 - 4.75	161-0450						
	4.74 - 5.14	161-0480	199.60	309.20	350.90	\$ 509.60	\$ 625.50	\$ 701.30
	4.95 - 5.35	161-0500	7#	10#	12#	17#	20#	24#
	5.22 - 5.62	161-0525						
6	5.95 - 6.35	161-0600						
	6.56 - 6.96	161-0663						
	6.85 - 7.25	161-0690	236.30	376.50	419.80	650.10	756.50	838.70
	7.05 - 7.45	161-0710	9#	13#	17#	20#	26#	34#
8	7.45 - 7.85	161-0745						
	7.95 - 8.35	161-0800						
	8.54 - 8.94	161-0863						
	8.99 - 9.39	161-0905	273.60	435.50	511.20	728.90	860.10	1,023.40
	9.27 - 9.67	161-0940	11#	16#	21#	25#	32#	44#
10	9.90 - 10.30	161-1000						
	10.60 - 11.00	161-1075						
	11.04 - 11.44	161-1110						
	11.34 - 11.74	161-1140	350.20	547.00	630.20	788.40	1,122.20	1,255.80
12	11.75 - 12.15	161-1175	15#	18#	24#	30#	36#	50#
	12.00 - 12.40	161-1200						
	12.60 - 13.02	161-1275						
	13.10 - 13.50	161-1320						
12	13.40 - 13.80	161-1340	407.30	655.50	780.30	1,063.10	1,145.50	1,555.20
	13.70 - 14.10	161-1370	17#	24#	30#	34#	46#	56#
	14.00 - 14.40	161-1400						
	<b>Number of Bolts</b>			2	3	4	6	8

JCM Universal Clamp Couplings meet or exceed ANSI/AWWA 230 as applicable

### How to Order:

1. Determine O.D. of Pipe
2. Select proper clamp O.D. range and width.
4. Specify clamp number. Example: For Cast Iron Pipe, 6.90 O.D., 6" wide, order: 161-0690-6

Clamps do not prevent lateral movement of pipe. Applications in which the pipe may move out of the clamp, proper anchorage must

Available Options: Special sizes/ranges not listed, Conductive Buttons, Specialty Gaskets

For threaded outlet clamps, see JCM Tapped Clamps

### Material Specifications



**Bolt Assembly:** 18-8 Type 304 Stainless Steel

**Band:** 18-8 Type 304 Stainless Steel

**Bolts and Nuts:** 18-8 Type 304 Stainless Steel

**Gasket:** Virgin Styrene-Butadiene Rubber (SBR) - Compounded for use with water, salt solutions, mild acids and bases. Per ASTM D-2000 M4AA 607. Standard temperature range from -40° to 150° F (-40° to 65°C) constant, maximum intermittent 180°F (82°C). For applications on high temperatures or chemical pipelines, contact JCM Industries Technical Services.

JCM 100 Series Universal Clamp Couplings are ANSI/NSF Standard 61, Annex G and ANSI/NSF Standard 372 Certified.

Meets or exceeds ANSI/AWWA C230 Standard for Stainless-Steel Full-Encirclement Repair and Service Connection Clamps as applicable.



# JCM 162 Double Band Fabricated Lug Stainless Steel Universal Clamps

Clamp Width - dimensions in inches  
# Approximate Weight - Lbs

## Double Band Clamps

Nom Pipe Size (IN)	Clamp OD Range (IN)	Clamp Number	7	12	15	18	24	30
4	4.44 - 5.24	162-0450	\$ 270.50	\$ 427.70	\$ 485.90	\$ 706.60	\$ 850.50	\$ 953.40
	4.74 - 5.57	162-0480	9#	13#	16#	25#	27#	34#
6	6.62 - 7.42	162-0663	319.70	509.40	568.50	880.60	1,036.30	1,144.90
	6.84 - 7.64	162-0690	11#	14#	19#	28#	30#	40#
8	8.62 - 9.42	162-0863	370.30	589.60	691.40	990.10	1,173.90	1,399.60
	8.99 - 9.79	162-0905	13#	19#	23#	36#	41#	45#
10	10.72 - 11.72	162-1075		754.30	857.70	1066.00	1,535.20	1,717.80
	11.04 - 12.24	162-1110		28#	32#	43#	56#	64#
12	12.72 - 13.92	162-1275		892.40	1,082.00	1,423.60	1,580.80	2,161.60
	13.14 - 14.34	162-1320		30#	40#	52#	60#	80#
	13.65 - 14.65	162-1365						
14	15.20 - 16.20	162-1530		1,069.60	1,314.30	1,716.20	2,177.00	2,403.90
				34#	43#	55#	79#	86#
14-16	16.00 - 17.00	162-1600		1,241.80	1,451.10	2,078.30	2,465.10	2,939.30
	17.20 - 18.20	162-1740		36#	46#	59#	87#	92#
16-18	18.40 - 19.40	162-1846		1,343.80	1,549.30	2,256.30	2,629.70	3,059.70
				38#	49#	61#	90#	96#
18-20	19.40 - 20.40	162-1950		1,512.50	1,719.60	2,490.70	3,072.30	3,521.80
	20.40 - 21.40	162-2050		43#	52#	63#	94#	101#
20-22	21.40 - 22.40	162-2160		1,873.80	2,272.00	2,865.40	3,236.50	4,339.00
	22.50 - 23.60	162-2260		47#	59#	67#	99#	106#
<b>Number of bolts</b>			4	6	8	8	12	16

JCM Universal Clamp Couplings meet or exceed ANSI/AWWA 230 as applicable

### How to Order:

1. Determine O.D. of Pipe
2. Select proper clamp O.D. range and width.
4. Specify clamp number. Example: For Cast Iron Pipe, 6.90 O.D., 6" wide, order: 162-0690-6

Clamps do not prevent lateral movement of pipe. Applications in which the pipe may move out of the clamp, proper anchorage must be provided.

Available Options: Special sizes/ranges not listed, Conductive Buttons, Specialty Gaskets

For threaded outlet clamps, see JCM Tapped Clamps

### Material Specifications

**Bolt Assembly:** 18-8 Type 304 Stainless Steel

**Band:** 18-8 Type 304 Stainless Steel

**Bolts and Nuts:** 18-8 Type 304 Stainless Steel

**Gasket:** Virgin Styrene-Butadiene Rubber (SBR) - Compounded for use with water, salt solutions, mild acids and bases. Per ASTM D-2000 M4AA 607. Standard temperature range from -40° to 150° F (-40° to 65° C) constant, maximum intermittent 180° F (82° C). For applications on high temperatures or chemical pipelines, contact JCM Industries Technical Services.

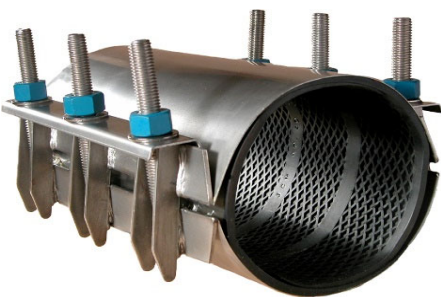

Certified to  
NSF/ANSI/CAN 61  
& NSF/ANSI 372

JCM 100 Series Universal Clamp Couplings are ANSI/NSF Standard 61, Annex G and ANSI/NSF Standard 372 Certified.

Meets or exceed ANSI/AWWA C230 Standard for Stainless-Steel Full-Encirclement Repair and Service Connection Clamps as applicable.

# JCM 168 Light Weight Fabricated Lug Stainless Steel Universal Clamps

Clamp Width - Inches  
# Approximate Weight - Lbs

## Single Band Clamps

Nom Pipe Size (IN)	Clamp OD Range (IN)	Clamp Number	7	12	15	18	24	30
4	4.00 - 4.40	168-0420						
	4.45 - 4.75	168-0450	\$ 174.80	\$ 270.50	\$ 307.70	\$ 446.80	\$ 548.40	\$ 614.80
	4.74 - 5.14	168-0480	7#	10#	12#	17#	20#	24#
6	6.00 - 6.40	168-0630						
	6.56 - 6.96	168-0663	206.90	330.80	368.30	570.00	663.10	735.60
	6.85 - 7.25	168-0690	9#	13#	17#	20#	26#	34#
8	8.20 - 8.60	168-0840						
	8.54 - 8.94	168-0863	239.90	381.70	448.10	639.20	753.80	897.10
	8.99 - 9.39	168-0905	11#	16#	21#	25#	32#	44#
10	10.30 - 10.70	168-1050						
	10.60 - 11.00	168-1075	306.90	479.60	552.20	690.80	983.70	1,100.70
	11.04 - 11.44	168-1110	15#	18#	24#	30#	36#	50#
12	12.30 - 12.70	168-1250						
	12.60 - 13.02	168-1275	357.20	574.60	683.70	931.80	1,004.00	1,363.00
	13.10 - 13.50	168-1320	17#	20#	27#	17#	40#	56#
<b>Number of Bolts</b>			2	3	4	4	6	8

### How to Order:

1. Determine O.D. of Pipe
2. Select proper clamp O.D. range and width.
3. Specify clamp number. Example: For Cast Iron Pipe, 6.90 O.D., 6" wide, order: 168-0690-6

Clamps do not prevent lateral movement of pipe. Applications in which the pipe may move out of the clamp, proper anchorage must be provided.

Available Options: Special sizes/ranges not listed, Conductive Buttons, Specialty Gaskets



### Material Specifications

**Bolt Assembly:** 18-8 Type 304 Stainless Steel

**Band:** 18-8 Type 304 Stainless Steel

**Bolts and Nuts:** 18-8 Type 304 Stainless Steel

**Gasket:** Virgin Styrene-Butadiene Rubber (SBR) - Compounded for use with water, salt solutions, mild acids and bases. Per ASTM D-2000 M4AA 607. Standard temperature range from -40 ° to 150 ° F (-40° to 65 °C) constant, maximum intermittent 180 °F (82 °C). For applications on high temperatures or chemical pipelines, contact JCM Industries Technical Services.



JCM 100 Series Universal Clamp Couplings are ANSI/NSF Standard 61, Annex G and ANSI/NSF Standard 372 Certified.

Meets or exceeds ANSI/AWWA C230 Standard for Stainless Steel Full-Encirclement Repair and Service Connection Clamps as applicable.

## JCM Tapped Universal Clamp Couplings

JCM Universal Clamp Couplings are available with tapped outlets for repair of direct tap pull outs and broken or split pipe requiring a service outlet.

### How To Order

1. Select standard model, size and width clamp to fit pipe.  
Select size and type of tapped outlet from outlet guide below. Note minimum widths and range/sizes.
2. Change model number to corresponding Tapped Outlet Clamp Model Number.
3. Add Outlet Tap Code to clamp number. Add-On outlet price to standard clamp list price.

For standard clamp to fit 6" Cast Iron Pipe with 12" width, with 2" IP outlet, order:

103-0690-12X14IP

**All Tapped Outlet Clamp Models are Non-Returnable Items**

Standard Clamp Model		Tapped Outlet Clamp Model
101 Universal Clamp Coupling	Converts to	103 Tapped Univ Clamp Cplg
102 Ext Range Univ Clamp Cplg	Converts to	104 Tapped UCC Extd Range
131 All Stainless Steel UCC	Converts to	133 Tapped All Stainless Steel UCC
132 Extd Range UCC	Converts to	134 Tapped All Stainless Steel Extd Range
121 Gas Repair Clamp	Converts to	123 Gas Service Clamp
151 All Stainless Gas Repair Clamp	Converts to	153 Tapped All Stainless Gas Service Clamp
161 All SS Fab. Lug Repair Clamp	Converts to	163 All SS Tapped Fabricated Lug UCC
162 All SS Fab. Lug Extd Rng Clamp	Converts to	164 All SS Tapped Fab Lug Extd Range UCC
171 Removeable Lug UCC	Converts to	173 Tapped UCC Removeable Lug
172 Removeable Lug Extd Rng UCC	Converts to	174 Tapped UCC Extd Range Removeable Lug

Clamp Range/Size (IN)	Minimum Clamp Width (IN)	Thread Type	Tap Size	IP Order Tap Code	CC Order Tap Code	Add-On to Standard Clamp List Price
2.38 - 4.80	6*	IP or CC	3/4	06	07	\$ 90.70
			1	08	09	90.70
2.38 - 14.00	7-1/2*	IP or CC	3/4	06	07	90.70
			1	08	09	90.70
4.50 - 14.00	12	IP or CC	1-1/4	10	11	156.50
4.50 - 14.00	12	IP or CC	1-1/2	12	13	156.50
4.50 - 14.00	12	IP	2	14	n/a	156.50
4.50 - 14.00	12	CC	2	n/a	15	184.90

\*Taps larger than 1" not available in these widths.

**All Tapped Clamp Models are Non-Returnable Items.**  
**Confirm sizes before ordering.**



103, 123, 173



133, 153



163

## JCM 159 Abandoned Corporation Cap



**159 Type 1**



**159 Type 2 & 3**

JCM Introduces the Model 159 Cap Sleeve for Abandoned Corporation Services. This sleeve quickly and efficiently installs over the abandoned corporation stop, permanently sealing the service area. This cap ensures a long term, watertight seal for the discarded corporation service and prevents any potential infiltration to the system.

Available in standard pipe sizes and ranges and can be manufactured to fit unusual or exotic pipe diameters.

Available in material options that best withstand the pipeline environment with gasket alternatives to accommodate the pipeline content.

JCM 159 Cap Sleeve is offered in three configurations to best serve the pipeline setting:

- Type 1 - All Stainless Steel (304 or 316) with Full Circumferential Gasket
- Type 2 - Carbon Steel (shopcoat or epoxy coat) with Outlet Seal Gasket
- Type 3 - All Stainless Steel (304 or 316) with Outlet Seal Gasket

The JCM Cap Sleeve is rated for 250 PSI working pressure. For higher pressures, contact JCM Engineered and Technical Services Team.



## JCM 159 Abandoned Corporation Cap

### Type 1 All Stainless Steel (304) with Full Circumferential Gasket

Nom Size (IN)	Pipe O.D. Range (IN)	Sleeve Number	Cap ID Size (IN)	Cap Height (IN)	Sleeve Width	List Price Each	Appox Wt Lbs
4	4.74 - 5.00	159-0480x3 T1	3.25	5.0	15	\$ 1,691.20	38
6	6.83 - 7.16	159-0690x3 T1	3.25	5.0	15	1,707.80	42
	7.05 - 7.40	159-0720x3 T1				1,707.80	42
8	8.98 - 9.37	159-0905x3 T1	3.25	5.0	15	1,784.10	45
	9.27 - 9.69	159-0940x3 T1				1,784.10	45
10	11.00 - 11.40	159-1110x3 T1	3.25	5.0	15	2,034.10	47
	11.36 - 11.80	159-1140x3 T1				2,034.10	47
12	13.10 - 13.50	159-1320x3 T1	3.25	5.0	15	2,297.30	50
	13.70 - 14.09	159-1392x3 T1				2,297.30	50
	14.08 - 14.40	159-1420x3 T1				2,297.30	50

6	6.83 - 7.16	159-0690x6 T1	6.36	8.0	15	\$ 1,760.20	49
	7.05 - 7.40	159-0720x6 T1				1,760.20	49
8	8.98 - 9.37	159-0905x6 T1	6.36	8.0	15	1,925.80	54
	9.27 - 9.69	159-0940x6 T1				1,925.80	54
10	11.00 - 11.40	159-1110x6 T1	6.36	8.0	15	2,203.30	58
	11.36 - 11.80	159-1140x6 T1				2,203.30	58
12	13.10 - 13.50	159-1320x6 T1	6.36	8.0	15	2,545.00	62
	13.70 - 14.09	159-1392x6 T1				2,545.00	62
	14.08 - 14.40	159-1420x6 T1				2,545.00	62

## JCM 159 Abandoned Corporation Cap

### Type 2 Carbon Steel with Outlet Seal Gasket

Nom Size (IN)	Pipe O.D. Range (IN)	Sleeve Number	Cap ID Size (IN)	Cap Height (IN)	Sleeve Width	List Price Each	Appox Wt Lbs
4	4.80	159-0480x3 T2	3.07	5.0	9	\$ 758.50	29
6	6.83 - 7.16	159-0690x3 T2	3.07	5.0	12	809.20	50
	7.05 - 7.40	159-0720x3 T2				809.20	50
8	8.98 - 9.37	159-0905x3 T2	3.07	5.0	12	879.90	80
	9.27 - 9.69	159-0940x3 T2				879.90	80
10	11.03 - 11.47	159-1110x3 T2	3.07	5.0	12	917.70	90
	11.36 - 11.80	159-1140x3 T2				917.70	90
12	13.13 - 13.60	159-1320x3 T2	3.07	5.0	12	937.80	100
	13.60 - 14.09	159-1392x3 T2				937.80	100
	14.08 - 14.56	159-1420x3 T2				937.80	100
6	6.83 - 7.16	159-0690x6 T2	6.13	8.0	12	\$ 903.60	60
	7.05 - 7.40	159-0720x6 T2				903.60	60
8	8.98 - 9.37	159-0905x6 T2	6.13	8.0	12	929.60	80
	9.27 - 9.69	159-0940x6 T2				929.60	80
10	11.03 - 11.47	159-1110x6 T2	6.13	8.0	12	981.50	90
	11.36 - 11.80	159-1140x6 T2				981.50	90
12	13.13 - 13.60	159-1320x6 T2	6.13	8.0	12	1,022.80	120
	13.60 - 14.09	159-1392x6 T2				1,022.80	120
	14.08 - 14.56	159-1420x6 T2				1,022.80	120

Type 2 Fitting furnished shop coat/ally bolts. Epoxy coating and stainless hardware available.

## JCM 159 Abandoned Corporation Cap

### Type 3 All Stainless Steel (304) with Outlet Seal Gasket

Nom Size (IN)	Pipe O.D. Range (IN)	Sleeve Number	Cap ID Size (IN)	Cap Height (IN)	Sleeve Width	List Price Each	Appox Wt Lbs
4	4.80	159-0480x3 T3	3.25	5.0	9	\$ 1,429.70	30
6	6.83 - 7.16	159-0690x3 T3	3.25	5.0	9	1,515.80	70
	7.05 - 7.40	159-0720x3 T3				1,515.80	70
8	8.98 - 9.37	159-0905x3 T3	3.25	5.0	9	1,640.80	82
	9.27 - 9.69	159-0940x3 T3				1,640.80	82
10	11.03 - 11.47	159-1110x3 T3	3.25	5.0	9	1,834.20	91
	11.36 - 11.80	159-1140x3 T3				1,834.20	91
12	13.13 - 13.60	159-1320x3 T3	3.25	5.0	9	1,859.00	98
	13.60 - 14.09	159-1392x3 T3				1,859.00	98
	14.08 - 14.56	159-1420x3 T3				1,859.00	98
6	6.83 - 7.16	159-0690x6 T3	6.36	8.0	12	\$ 1,750.60	82
	7.05 - 7.40	159-0720x6 T3				1,750.60	82
8	8.98 - 9.37	159-0905x6 T3	6.36	8.0	12	1,840.10	88
	9.27 - 9.69	159-0940x6 T3				1,840.10	88
10	11.03 - 11.47	159-1110x6 T3	6.36	8.0	12	1,972.30	94
	11.36 - 11.80	159-1140x6 T3				1,972.30	94
12	13.13 - 13.60	159-1320x6 T3	6.36	8.0	12	2,060.80	101
	13.60 - 14.09	159-1392x6 T3				2,060.80	101
	14.08 - 14.56	159-1420x6 T3				2,060.80	101

Sleeves furnished standard with 3/4" test port on cap.

## JCM 114 Fabricated Mechanical Joint Repair Sleeve

For the repair of cast iron bells, split or leaking coupling and weld joints, flanged pipe joints or straight runs of pipe without costly shutdown or disruption to critical service.

**No Shutdown or Interruption of Critical Service** - by implementing a split fabricated mechanical joint design, the JCM 114 prevents costly down time and service disruption.

**True Mechanical Joint Design** - heavy fabricated steel body and pusher gland construction prevents the warpage and distortion experienced by repair sleeves using the split steel coupling designs.

**Custom Built For Specific Application** - this versatile mechanical joint fitting is built to meet the specific requirements of special applications. Eliminates lost time due to field or factory modifications.

**Strong and Lightweight** - the 114 sleeves are ideal for installations where strength, weight and continued service are critical. The reduced weight of high strength steel aids in installation and handling as well as minimizing weight load on the pipe.

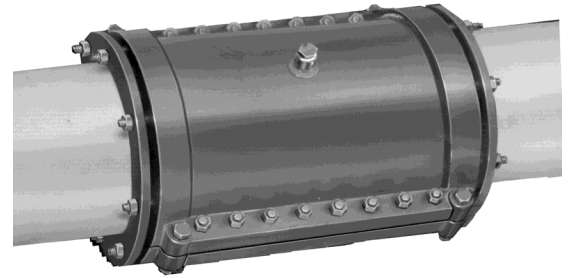

**Available in Three Styles** - the 114 MJ Split Repair Sleeve for use on straight runs of pipe and the 114 MJ Bell Repair Sleeve which is fabricated to accommodate the **specific dimensions of the bell, collar or coupling to be repaired**. The JCM 114 MJ Repair Sleeve can also be **fabricated to accommodate two different O.D.'s of pipe**.

**Optional Materials** - the 114 is available in carbon steel with special coatings and fasteners, or is available fabricated of 304 stainless steel or 316 stainless steel.

**Sizes & Configurations** - the 114 is available for pipe sizes 4" and larger. Custom design and product submittal for unique or problematic applications provided by JCM Engineering Group.

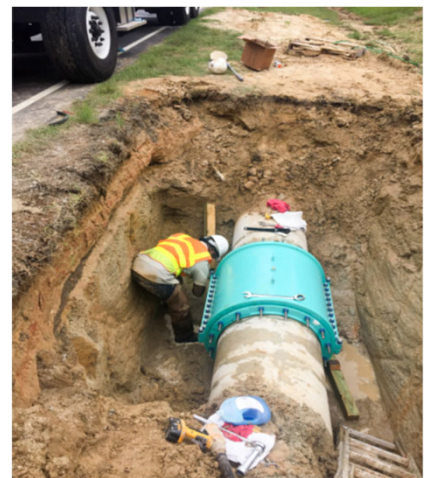



## JCM 114 Fabricated Mechanical Joint Repair Sleeve

### JCM 114 Mechanical Joint Repair Sleeve

Mechanical Joint Split Repair Sleeve			
Nominal Pipe Size	Repair Sleeve Number	Effective Length	Overall Length
3	114-0396-16	16	26
4	114-0480-16	16	26
6	114-0690-16	16	26
8	114-0905-18	18	28
10	114-1110-18	18	28
12	114-1320-18	18	28
14	114-1530-24	24	34
16	114-1740-24	24	34
18	114-1950-24	24	34
20	114-2160-27	27	37
24	114-2580-29	29	40

Other sizes available. Contact JCM.

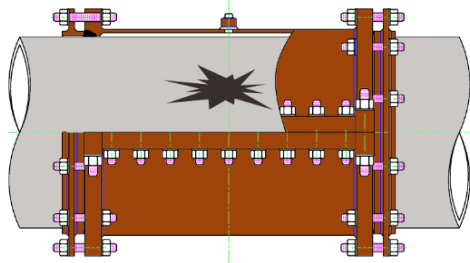

Mechanical Joint Bell Repair Sleeve			
Repair Sleeve Number	Inside Diameter	Effective Length	Overall Length
114-0396-16BR	9	16	26
114-0480-16BR	10.25	16	26
114-0690-16BR	12.25	16	26
114-0905-18BR	15	18	28
114-1110-18BR	17	18	28
114-1320-18BR	20	18	28
114-1530-24BR	22	24	35
114-1740-24BR	25	24	34
114-1950-24BR	28	24	34
114-2160-27BR	30	27	37
114-2580-29BR	34	29	40

Other sizes available. Contact JCM.

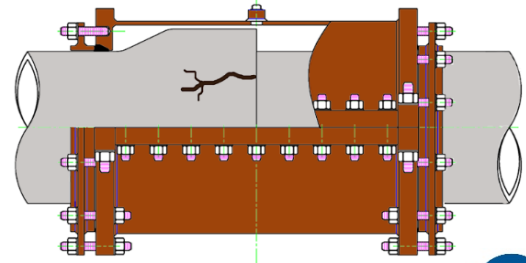

Data shown is the standard dimensions for JCM 114 MJ Split Repair Sleeves and Bell Repair Sleeves over pipe joint configurations or couplings. Other sizes are available per supplied requirements (fitting length and/or inside diameter clearance).

Note: Overall outside lengths are approximate and based on normal hardware installation. Exact measurements should be obtained from field when confined spaces are a concern, to confirm that joint configurations have proper clearance, or when special sizes are required. The standard working pressure rating is 150PSI, higher working pressures available upon request.

### Material Specifications

- Body:** Carbon Steel per ASTM A36, ASTM A516 Grade 70 or equal. Optional 304 or 316 Stainless Steel.
- Glands:** ASTM A36 Steel or equal. Optional 304 or 316 Stainless Steel.
- Gaskets:** Nitrile - Compounded for use with water, salt solutions, mild acids and bases.
- Bolts:** Corrosion resistant, high strength low alloy ASTM A242, A193 B5, B7. Optional A193 B8 304 stainless steel or 316 stainless steel.
- Finish:** Heavy coat of corrosion resistant shop coat primer. Optional Fusion Epoxy Coating available

## JCM 116 Repair Sleeve for Concrete Steel Cylinder Pipe and Large Diameter Pipe

The JCM 116 Repair Sleeve for Concrete Steel Cylinder Pipe provides a quick easy means of repairing and reinforcing damaged concrete steel cylinder pipe of all sizes. This repair sleeve permits repairs to be made on any side of the pipe - without requiring complete stripping of the concrete. The standard repair gasket seals around a 12" damaged area. Larger repair sizes are available. This sleeve is especially recommended for larger sizes of pipe and where the concrete and pipe require reinforcement.

**Minimal Pipe Excavation** - JCM 116 Repair Sleeve requires limited pipe exposure around the damaged area. Full section joint exposure is eliminated.

**Wide Supportive Body** - reinforces pipe which is weakened due to structural interruption. The body's grout seal assembly provides a system for replacement of the critical corrosion retarding concrete encasement. By restoring the concrete casing, the steel cylinder is protected from corrosive elements.

**Eliminates Excessive Concrete Coating Removal** - concrete removal is limited to the damaged area only, preventing further pipe structural damage.

**Epoxy Coated Repair Plate** - the internal repair plate is fusion epoxy coated to provide a quality repair protected against corrosion in the pipe interior.

**Eliminates Welding On Thin Cylinders** - JCM 116 directly repairs the damaged cylinder making a watertight seal, preventing the line contents from infiltrating the concrete-steel interface.

**Availability** - The JCM 116 Repair Sleeve for Concrete Steel Cylinder Pipe is available from JCM on both an emergency and a contingency basis. Timely delivery and installation prevents extensive pipe damage, content loss and environmental violations.

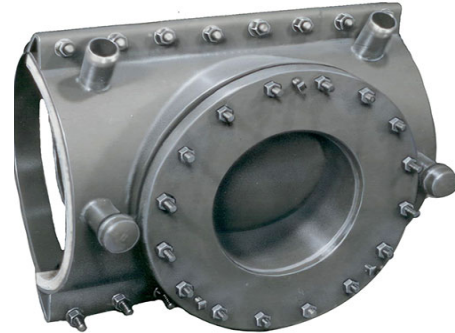

## JCM 116 Repair Sleeve for Large Diameter Pipe

The JCM 116 Repair Sleeve is also recommended for repairs on large diameter pipe including cast iron, ductile iron, steel, and other types of large diameter rigid pipe. The direct concentration of bolting pressure to the repair gland area enables the 116 to repair the damaged area while maintaining the pipeline's pressure capability.

**JCM 116 Repair Sleeves for Concrete Steel Cylinder Pipe are Priced on Application. For quotation, contact the JCM Engineered and Technical Sales Team at 1-800-527-8482 or 1-903-832-2581**



## JCM 116 Repair Sleeve for Concrete Steel Cylinder Pipe

The JCM 116 Repair sleeve provides fast, economical and permanent repairs to Concrete Pressure Pipe. Sealing around the damaged area on the steel cylinder, the JCM 116 prevents the line contents from leaking between the concrete/steel cylinder interface, and eliminates further possible damage caused by corrosion. The adjustable, separate gland seals directly on the steel cylinder over the damaged area requiring removal of the mortar coating only in the repair area. Universal grouting horns are located to accommodate re-grouting of the damaged area at any position on the pipe.

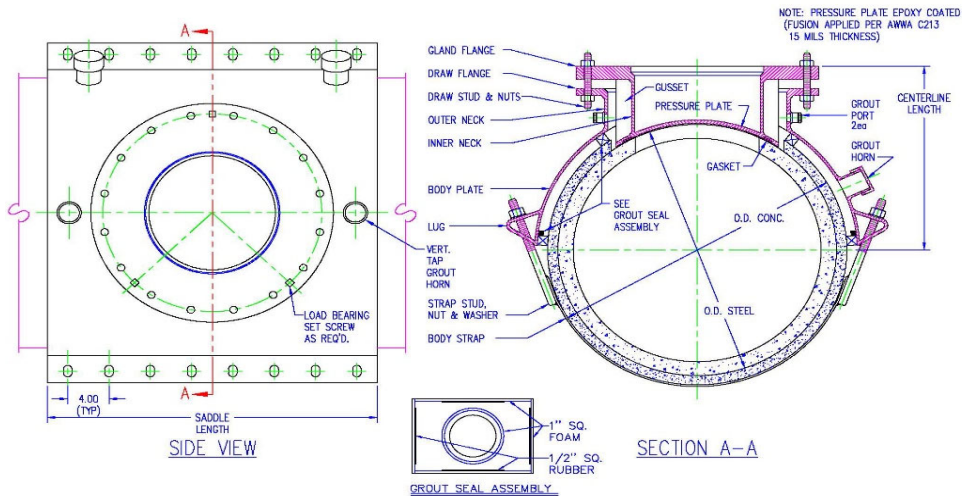

### HOW TO ORDER

For pricing and engineering, the following information must be furnished:

- Type of pipe (also manufacturer and class if known)
- Diameter of damaged area
- Outside Diameter of Concrete and Cylinder
- Line Content and Pressure
- Any special requirements or options

### JCM 116 Repair Sleeve for Concrete Pressure Pipe - Typical Specification

JCM 116 Fabricated Repair Sleeves for Concrete Steel Cylinder Pipe shall be able to repair and reinforce damaged concrete steel cylinder pipe without requiring complete stripping of the concrete. The repair sleeves shall have a separate gland which permits installation and reinforcement of the pipe prior to the cutting of the prestress wires. The repair gland shall have a fusion epoxy coated pressure plate and a broad gasket set in a retaining groove of the pressure plate which is gusseted to eliminate flexing. Repair Sleeves shall be JCM 116 Repair Sleeves or approved equal. Repair Sleeves shall be ANSI/NSF Standard 61, Annex G and ANSI/AWWA 372 Certified.

- Body:** ASTM A36 Steel, A516 GR 70 or equal.
- Bolts:** Corrosion resistant, high strength low alloy A242. Optional Stainless Steel, 18-8 Type 304.
- Draw Hardware:** B7 Material
- Coating:** Heavy coat of corrosion resistant shop coat primer on sleeve, gland and straps. Pressure plate of gland is epoxy coated (fusion applied per ANSI/AWWA C-213). Optional epoxy coating on entire sleeve
- Gasket:** Nitrile rubber compounded for use with water, salt solutions, mild acids, bases and sewage.

## JCM 118 Fabricated Repair Sleeves

The JCM 118 Repair Sleeve is designed to provide immediate repairs to large diameter pipe in systems which require high working pressure capability. Engineered specifically for the internal pressure forces involved with large pipe and its working characteristics, the JCM 118 is available in pipe sizes up through 120" and larger with several design options for the specific application.

### Features built into the design of the JCM 118 include:

**Reinforcement of the Pipe Wall** - strong, yet lightweight steel (pressure vessel quality) directly reinforces the pipe wall on the circumference of the pipe.

**Heavy Duty Design** - large fitting components, spacious bolt holes and heavy hardware combine to make installations in less than ideal environments easy and fast. The JCM 118 especially lends itself for easier underwater and low visibility installation applications.

**Maximum Gasket Sealing** - heavy duty materials provides high levels of bolt torque transferred directly to gasket sealing compression. Higher bolt torques maintain greater working pressures.

**Minimal Pipe Excavation** - the JCM 118 sleeve requires limited pipe exposure around the damaged area. Full section joint exposure of underground pipelines is eliminated.

**Low Profile Stance** - the hydro-mechanical lip gasket is trapped both internally and externally in a recessed groove that provides a low profile stance on the pipe eliminating the chance of gasket displacement or "blow-out" in high pressure applications.

**Availability** - The JCM 118 Repair Sleeve is available from JCM on both an emergency and a contingency basis. Timely delivery and installation prevents extensive pipe damage, content loss and environmental violations.



Simple and fast repair. The damaged area falls within the "Inside Diameter (I.D.) of the gasket" trapping (encompassing) the hole within the gasket area. Repair Sleeve gasket loads faster and provides greater gasket compression on the pipe.

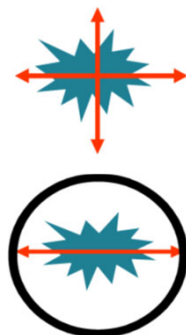

### Suitable for these types of damage



### Available with or without threaded outlet. Carbon steel, stainless steel (304 or 316)

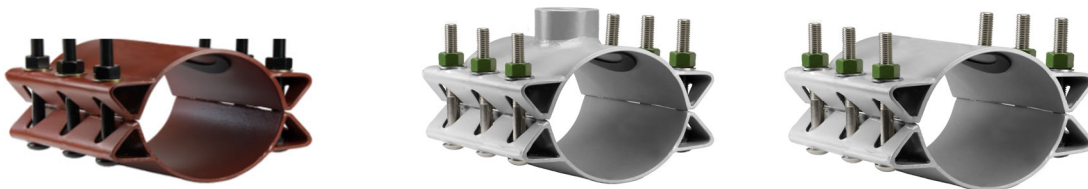

## JCM 118 Fabricated Repair Sleeves

Nom Pipe Size (IN)	Sleeve OD Range (IN)	Clamp Number	Maximum Repair Area (IN)	Minimum Sleeve Width (IN)
3	3.5	118-0350 x 00	3	9
	3.96	118-0396 x 00	3	9
4	4.5	118-0450 x 00	4	9
	4.8	118-0480 x 00	4	9
6	6.63	118-0663 x 00	6	12
	6.83 - 7.16	118-0690 x 00	6	12
	7.05 - 7.40	118-0720 x 00	6	12
	7.40 - 7.73	118-0745 x 00	6	12
8	8.63	118-0863 x 00	8	16
	8.98 - 9.37	118-0905 x 00	8	16
	9.27 - 9.69	118-0940 x 00	8	16
	9.83 - 10.25	118-1000 x 00	8	16
10	10.64 - 10.86	118-1075 x 00	10	20
	11.03 - 11.47	118-1110 x 00	10	20
	11.36 - 11.80	118-1140 x 00	10	20
	11.76 - 12.24	118-1200 x 00	10	20
12	12.62 - 12.88	118-1275 x 00	12	24
	13.13 - 13.60	118-1320 x 00	12	24
	13.60 - 14.09	118-1392 x 00	12	24
	14.08 - 14.56	118-1420 x 00	12	24
14	14.59 - 15.08	118-1475 x 00	12	24
	15.23 - 15.80	118-1530 x 00	12	24
	15.73 - 16.22	118-1600 x 00	12	24
	16.30 - 16.73	118-1650 x 00	12	24
16	16.74 - 17.26	118-1684 x 00	12	24
	17.33 - 17.87	118-1740 x 00	12	24
	17.88 - 18.43	118-1800 x 00	12	24
	18.62 - 19.19	118-1875 x 00	12	24
18	18.87 - 19.45	118-1920 x 00	12	24
	19.41 - 20.01	118-1950 x 00	12	24
	20.00 - 20.60	118-2000 x 00	12	24
	20.29 - 20.94	118-2050 x 00	12	24
20	20.93 - 21.57	118-2130 x 00	12	24
	21.51 - 22.15	118-2160 x 00	12	24
	22.16 - 22.81	118-2254 x 00	12	24
	22.78 - 23.45	118-2294 x 00	12	24
	23.46 - 24.16	118-2400 x 00	12	24
24	24.15 - 24.85	118-2450 x 00	12	24
	24.82 - 25.52	118-2502 x 00	12	24
	25.71 - 26.41	118-2580 x 00	12	24
	26.55 - 27.25	118-2715 x 00	12	24
30	27.26 - 27.96	118-2746 x 00	12	24
	28.14 - 28.84	118-2834 x 00	12	24
	29.78 - 30.48	118-3000 x 00	12	24
30	30.48 - 31.18	118-3075 x 00	12	24
	31.52 - 32.22	118-3200 x 00	12	24
Custom Sizes Available Contact JCM Industries			Other Sizes Available	Other Widths Available

Standard fitting  
furnished no outlet.  
Optional outlets below.

For Optional Outlet Replace (x) 00 with order code below	
Outlet Size	Order Code IP
3/4	6
1	8
1-1/4	10
1-1/2	12
2	14
2-1/2	16
3	17
4	18

Options Available:

Epoxy Coating  
Fabricated of All Stainless Steel  
(304 or 316)

Stainless Steel Hardware  
Electro Coated Hardware



Certified to  
NSF/ANSI/CAN 61  
& NSF/ANSI 372

For All Stainless Steel fabrication, indicate 304 or 316 stainless steel.

## JCM 136 Heavy Duty Repair Clamps

The JCM 136 Heavy Duty Stainless Steel Repair Clamp incorporates the corrosion resistance of stainless steel, the full circumferential gasketing of a Universal Clamp Coupling and the triangular bolting configuration of the 432 Stainless Steel Tapping Sleeve to provide a repair clamp coupling with high working pressure capabilities.

All Stainless Steel Construction - provides superior corrosion resistance in harsh or acidic environments. The JCM 136 is available fabricated of 304 or 316 stainless steel.

Heavy Duty Stainless Material - the JCM 136 has a minimum standard material of 14 gauge certifiable prime material. This strong, yet flexible stainless shell conforms to uneven or unusual pipe surfaces and provides complete compression of the gasket on the pipe wall.

Tapping Sleeve Bolting System - with a triangular lug design, allows for pass-through, replaceable bolts. This lug configuration eliminates alignment problems and allows tightening from either side of the pipe.

Full Circumferential Gasket - provides a water tight seal on the full circumference of the pipe. The gridded 1/4" thick gasket is of a durometer hardness that allows the rubber to conform to and fill the pits and voids of uneven pipe surfaces.

The JCM 136 Heavy Duty Stainless Repair Clamp is available for all types and sizes of pipe. Options for this fitting includes: 304 Stainless Steel, 316 Stainless Steel, SBR, EPDM or Buna-N Gaskets, 304 Stainless Hardware, 316 Stainless Hardware. Call the JCM Inside Sales Team for product recommendations.

### JCM 136 Heavy Duty Stainless Steel Repair Clamp Coupling

All Stainless Steel Body  
Full Circumferential Gasket 1/4" Thick  
Recessed Stainless Steel Bridge Plates  
Heavy Duty Stainless Bolting System  
Available in common nominal pipe sizes  
Custom sizes available upon request  
Available 304 or 316 fabrication  
Available with threaded outlet

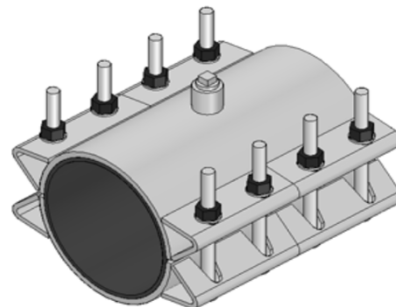
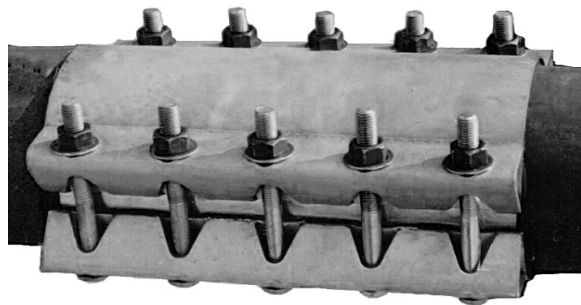

## JCM 201 Steel Couplings for Steel Pipe Sizes

Nom Pipe Size (IN)	Pipe OD Range (IN)	Sleeve Length X Thickness	No. of Bolts	Catalog Number	Carton Quantity	List Price Each	E Epoxy Coat Add to List	SS Stainless Steel Hardware Add to List	Appr Wt Each Lbs
1/2	0.84	.157 x 3-1/2	2	201-008401	12	\$ 46.10	P. O. A.	\$ 31.20	1
3/4	1.05	.157 x 5	2	201-010501	12	51.20	P. O. A.	31.20	2
1	1.32	.157 x 5	2	201-013201	12	53.00	P. O. A.	31.20	3-1/2
1-1/4	1.66	.138 x 5	2	201-016601	6	55.70	P. O. A.	31.20	4
1-1/2	1.90	.157 x 5	2	201-019001	6	66.60	P. O. A.	31.20	4-1/2
2	2.38	.157 x 5	2	201-023800	6	76.00	P. O. A.	31.20	5
2	2.38	.157 x 5	3	201-023801	1	101.60	P. O. A.	93.20	7
2-1/2	2.88	.197 x 5	3	201-028801	1	117.90	P. O. A.	93.20	8
3	3.50	.157 x 5	4	201-035001	1	137.50	P. O. A.	124.30	10
3	3.50	.157 x 7	4	201-035002	1	161.50	P. O. A.	198.90	12
4	4.50	.157 x 5	4	201-045001	1	163.20	P. O. A.	124.30	12
4	4.50	.157 x 7	4	201-045002	1	187.40	P. O. A.	198.90	15
5	5.56	1/4 x 5	4	201-055601	1	281.00	P. O. A.	124.30	16
6	6.63	1/4 x 5	6	201-066301	1	222.80	P. O. A.	186.40	18
6	6.63	1/4 x 7	6	201-066302	1	244.10	P. O. A.	298.70	22
8	8.63	1/4 x 5	6	201-086301	1	263.10	P. O. A.	186.40	20
8	8.63	1/4 x 7	6	201-086302	1	289.20	P. O. A.	298.70	26
10	10.75	1/4 x 5	8	201-107501	1	343.00	P. O. A.	248.20	32
10	10.75	5/16 x 7	8	201-107507	1	476.40	P. O. A.	248.20	46
12	12.75	1/4 x 5	8	201-127501	1	395.40	P. O. A.	397.90	51
12	12.75	5/16 x 7	8	201-127507	1	582.70	P. O. A.	397.90	62
14	14.00	3/8 x 7	8	201-140007	1	653.10	P. O. A.	397.90	89
16	16.00	3/8 x 7	10	201-160007	1	864.40	P. O. A.	452.30	95
18	18.00	3/8 x 7	10	201-180007	1	903.00	P. O. A.	452.30	102
20	20.00	3/8 x 7	12	201-200007	1	1,436.40	P. O. A.	P. O. A.	115
22	22.00	3/8 x 7	14	201-220007	1	1,822.00	P. O. A.	P. O. A.	126
24	24.00	3/8 x 7	14	201-240007	1	1,678.70	P. O. A.	P. O. A.	132
28	28.00	3/8 x 7	16	201-280007	1	P. O. A.	P. O. A.	P. O. A.	140
30	30.00	3/8 x 7	17	201-300007	1	P. O. A.	P. O. A.	P. O. A.	158
36	36.00	1/2 x 10	18	201-360009	1	P. O. A.	P. O. A.	P. O. A.	250
42	42.00	1/2 x 10	20	201-420009	1	P. O. A.	P. O. A.	P. O. A.	315
48	48.00	1/2 x 10	22	201-480009	1	P. O. A.	P. O. A.	P. O. A.	375

Other Sizes Available Upon Request

\*For Sizes 2" through 12" See JCM 210 Ductile Iron Couplings

Note: Applications in which pipe may move out of the coupling, proper anchorage of the pipe must be provided.

JCM 201 Bolted Couplings meet or exceed the ANSI/AWWA C219 Standard as applicable.

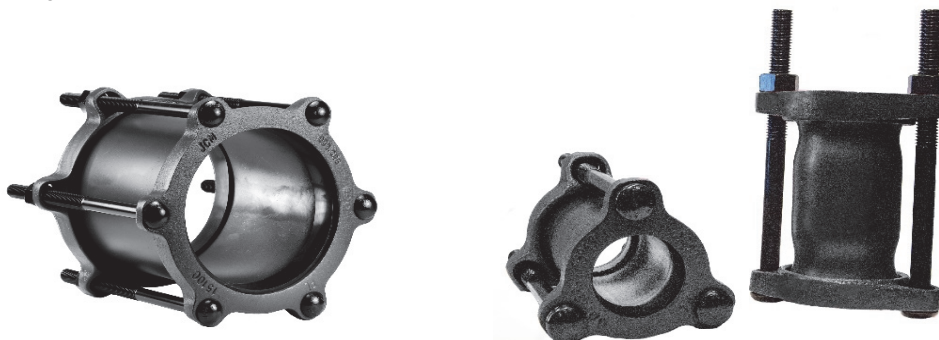

## JCM 201 Steel Couplings 14" and Larger

Nom Pipe Size (IN)	Pipe OD Range (IN)	Sleeve Length X Thickness	No. of Bolts	Catalog Number	Carton Quantity	Price Each	E Epoxy Coat Add to List	SS Stainless Steel Hardware Add to List	Appr Wt Each Lbs
14	15.30	3/8 X 7	8	201-153007	1	\$ 967.90	\$ 45.90	\$ 397.80	85
14	15.65	3/8 X 7	10	201-156507	1	982.20	45.90	452.30	85
14	16.75	3/8 X 7	10	201-167507	1	1,049.40	45.90	503.30	89
16	17.40	3/8 X 7	10	201-174007	1	1,052.40	45.90	503.30	90
16	17.80	3/8 X 7	10	201-178007	1	1,064.80	45.90	503.30	90
16	18.88	3/8 X 7	10	201-188807	1	1,177.80	45.90	503.30	95
18	19.50	3/8 X 7	12	201-195007	1	1,123.30	45.90	598.10	113
18	19.92	3/8 X 7	12	201-199207	1	1,144.80	45.90	598.10	115
20	21.60	3/8 X 7	12	201-216007	1	1,534.90	P.O.A.	P.O.A.	126
20	22.06	3/8 X 7	14	201-220607	1	1,821.80	P.O.A.	P.O.A.	126
24	25.80	3/8 X 7	15	201-258007	1	2,105.10	P.O.A.	P.O.A.	141
24	26.32	3/8 X 7	15	201-263207	1	2,130.40	P.O.A.	P.O.A.	147
30	31.74	3/8 X 7	18	201-317407	1	P.O.A.	P.O.A.	P.O.A.	200
30	32.00	3/8 X 7	18	201-320007	1	3,686.80	P.O.A.	P.O.A.	210
36	38.30	1/2 X 10	21	201-383009	1	3,317.90	P.O.A.	P.O.A.	278
42	44.50	1/2 X 10	24	201-445009	1	3,806.70	P.O.A.	P.O.A.	338
48	50.80	1/2 X 10	27	201-508009	1	P.O.A.	P.O.A.	P.O.A.	375

Other Sizes Available Upon Request

\*For Sizes 2" through 12" See JCM 210 Ductile Iron Couplings

Note: Applications in which pipe may move out of the coupling, proper anchorage of the pipe must be provided.

JCM 201 Bolted Couplings meet or exceed the ANSI/AWWA C219 Standard as applicable.

### Material Specifications

**Middle Rings:** 1/2" - 1-1/2" Steel per ASTM A36  
2" - 12" Steel per ASTM A36  
14" and larger Steel per ASTM A36

**Followers:** 1/2" - 1-1/2" Ductile Iron ASTM A536  
2" - 12" Ductile Iron ASTM A536  
14" and larger Steel per ASTM A36

**Bolts:** 1/2" - 1-1/2" ASTM A242 high strength, low alloy electro coat per Powercron 590-534 black cationic electrocoat.

Nominal sizes 2" and larger: minimum 5/8" bolts ASTM A242/ANSI/AWWA C111/A21.11 corrosion resistant, high strength low alloy; heavy hex nuts A563 per ANSI/AWWA C219. Available Options: Electro-coated Powercron 590-534; Stainless Steel 18-8 Type 304

**Gaskets:** Nitrile Butadiene Rubber (NBR, Buna-N) per ASTM D2000. Molded virgin rubber. Gasket temperature range -40°F to 212°F (-40°C - 100°C) Recommended for water, salt solutions, mild acids, bases, sewage and natural gas. Available Options: EPDM

**Finish:** 1/2" through 12" ECoat (electrocoat epoxy). 14" and Larger heavy coat of corrosion resistant shop coat primer. Optional fusion applied epoxy per ANSI/AWWA C213.

**Pressure:** Rated for 250 PSI working pressure when installed per manufacturer's instructions. Please contact JCM concerning pressure rating on specific sizes.





## JCM 202 Long Steel Couplings for Steel Pipe Sizes

Nom Pipe Size (IN)	Pipe OD Range (IN)	Sleeve Length X Thickness	No. of Bolts	Catalog Number	List Price Each	Appr Wt Each Lbs
2	2.38	.157 X 12	3	202-023811	\$ 201.60	15
2-1/2	2.88	.197 X 12	3	202-028811	212.80	20
3	3.50	.157 X 12	4	202-035011	271.10	16
4	4.50	.157 X 12	4	202-045011	339.90	22
6	6.63	1/4 X 16	6	202-066311	683.20	45
8	8.63	1/4 X 16	6	202-086311	909.20	54
10	10.75	1/4 X 16	8	202-107511	1,123.30	81
12	12.75	1/4 X 16	8	202-127511	1,310.40	119

Smaller and Larger Sizes available upon request

Note: Applications in which pipe may move out of the coupling, correct anchorage of the pipe must be provided

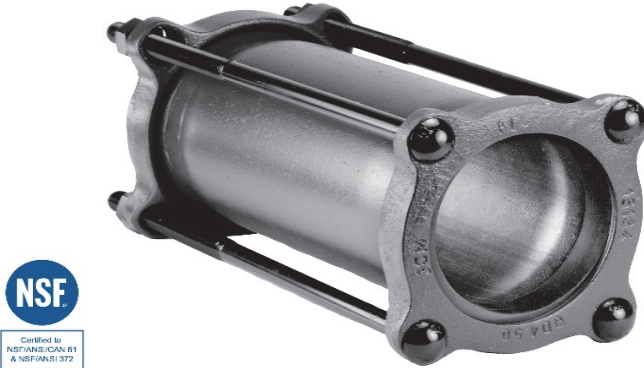

### Material Specifications

**Middle Rings:** 2" - 12" Steel per ASTM A36

14" and larger Steel per ASTM A36

**Followers:** 2" - 12" Ductile Iron ASTM A536

14" and larger Steel per ASTM A36

**Bolts:** Nominal sizes 2" and larger: minimum 5/8" bolts ASTM A242/ANSI/AWWA C111/A21.11 corrosion resistant, high strength low alloy; heavy hex nuts A563 per ANSI/AWWA C219. Available Options: Electro-coated Powercron 590-534; Stainless Steel 18-8 Type 304

**Gaskets:** Nitrile Butadiene Rubber (NBR, Buna-N) per ASTM D2000. Molded virgin rubber. Gasket temperature range -40°F to 212°F (-40°C - 100°C) Recommended for water, salt solutions, mild acids, bases, sewage and natural gas. Available Options: EPDM

**Finish:** Ecoat - Electrocoat epoxy. Optional fusion applied epoxy per ANSI/AWWA C213.

**Pressure:** Rated for 250 PSI working pressure when installed per manufacturer's instructions. Please contact JCM concerning pressure rating on specific sizes.

## JCM 203 Steel Transition Couplings

The JCM 203 Steel Transition Coupling provides a simple means of joining plain end pipe of the same nominal size but different outside diameter dimensions. The couplings are especially useful in joining old cast iron pipe to ductile iron pipe. Listed are the most common sizes. Other sizes are available upon request. Also see JCM 212 Ductile Iron Couplings.

Nom Pipe Size (IN)	From Pipe OD Range (IN)	Transition to OD Range (IN)	Catalog Number	List Price Each	Appr Wt Each Lbs
14	15.65	15.30	203-1565-1530	\$ 1,143.70	85
16	17.80	17.40	203-1780-1740	1,233.50	95
18	19.92	19.50	203-1992-1950	1,386.10	115
20	22.06	21.60	203-2206-2160	2,018.30	125
24	26.32	25.80	203-2632-2580	2,366.70	145

## JCM 204 Steel Reducing Couplings

The JCM 204 Steel Reducing Coupling is the simplest means of connecting any combination of two sizes or types of pipe. There is practically no limit to the pipe sizes that can be connected - either to reduce or increase in size. One common use is joining large steel pipe to ductile iron or C900 (905) PVC pipe. Listed are the most common sizes. Other sizes are available upon request.

Nom Pipe Size (IN)	From Pipe OD Range (IN)	Transition to OD Range (IN)	Catalog Number	List Price Each	Appr Wt Each Lbs
14	15.30	14.00	204-1530-1400	\$ 2,610.70	170
	15.65	14.00	204-1565-1400	2,669.90	170
	16.75	15.30	204-1675-1530	2,724.60	190
16	17.40	16.00	204-1740-1600	2,767.70	195
	17.80	16.00	204-1780-1600	2,829.90	195
	18.88	17.40	204-1888-1740	2,874.70	205
18	19.50	18.00	204-1950-1800	2,968.00	215
	19.92	18.00	204-1992-1800	3,030.30	215
20	21.60	20.00	204-2160-2000	3,235.50	230
	22.06	20.00	204-2206-2000	3,327.40	230
24	25.80	24.00	204-2580-2400	3,554.20	264
	26.32	24.00	204-2632-2400	3,665.30	264

**OTHER SIZES AVAILABLE UPON REQUEST**

Applications in which pipe may move out of the coupling, correct anchorage of the pipe must be provided.



**203**



**204**



## JCM 210 Ductile Iron Couplings



### JCM 200 Series Ductile Iron Couplings - 210, 211, 212, 214, 215, 219

**Sleeve & Flanges:** Ductile Iron Per ASTM A536 65-45-12

**Gaskets:** Styrene-Butadiene Rubber (SBR) has good physical properties. Compounded for use with water, salt solutions, mild acids and bases; has excellent abrasion resistance. Per ASTM D-2000. Standard temperature range from -40° to 150°F (-40° to 65° C) constant, maximum intermittent 180° F (82°C). For applications on high temperatures or chemical pipelines, contact JCM Industries Technical Services. The material is not recommended for use on oil, ozone or weather resistant applications.

**Bolts:** 5/8" Corrosion resistant, high strength low alloy oval neck track head bolts per ASTM A242/ANSI 21.11/AWWA C111 and heavy hex nuts per A563 or equal.

Optional Hardware: Stainless Steel 18-8 Type 304 or 316

Epoxy Coated Alloy Hardware, Powercron 590-534 black cationic electrocoat.

**Coating:** Corrosion resistant shop coat paint primer. Optional fusion applied epoxy coating per ANSI/AWWA C-213. Other coatings available upon request.

**Working Pressure:** Fittings are rated for 150 PSI working pressure when installed per manufacturer's instructions. Inspection of pipe integrity is the responsibility of the end user. For higher working pressure applications, contact JCM Industries.

**214 Pipe End Cap:** ASTM A36, A285 Grade C or equal. Fabricated with threaded outlet. Option solid cap available.

JCM 200 Series Steel Couplings are ANSI/NSF Standard 61, Annex G and ANSI/NSF 372 Certified.

JCM 210 Series Bolted Couplings meet or exceed the ANSI/AWWA C219 Standard as applicable.

## JCM 210 Ductile Iron Couplings - STANDARD SIZE - CI, DI, C-900/905, DI HDPE

Nom Pipe Size (IN)	Pipe OD Range (IN)	Sleeve Length	No. of Bolts	Catalog Number	List Price Each	E Epoxy Coat Add to List	SS Stainless Steel Hardware Add to List	EB Electro Coat Hardware Add to List	Appr Wt Each Lbs
2	2.34 - 2.63	5	2	210-0250	\$ 82.90	\$ 28.70	\$ 60.30	\$ 16.60	8
2-1/4, 2-1/2	2.62 - 2.92	5	2	210-0288	109.60	28.70	60.30	16.60	9
3	3.80 - 4.17	6	3	210-0396	134.30	28.70	96.90	19.00	15
4	4.80 - 5.10	6	4	210-0480	166.50	38.10	129.10	22.40	20
6	6.90 - 7.20	6	5	210-0690	227.10	38.10	161.10	29.30	28
8	9.05 - 9.40	6	6	210-0905	287.70	38.10	193.60	34.40	39
10	11.10 - 11.40	6	7	210-1110	396.60	38.10	226.00	40.00	46
12	13.20 - 13.50	6	8	210-1320	476.80	38.10	257.80	44.90	62
14	15.30 - 15.70	7	9	210-1530	1,189.40	46.90	405.80	60.40	100
16	17.40 - 17.80	7	10	210-1740	1,638.10	46.90	461.10	67.40	132
18	19.10 - 19.70	7	12	210-1950	1,880.70	46.90	553.50	80.70	140
20	21.35 - 21.75	7	12	210-2160	2,011.20	46.90	553.50	80.70	215
24	25.70 - 26.00	10	14	210-2580	2,655.90	46.90	648.30	117.70	285

## JCM 211 Ductile Iron Couplings - IPS PVC, IPS HDPE, STEEL PIPE

Nom Pipe Size (IN)	Pipe OD Range (IN)	Sleeve Length	No. of Bolts	Catalog Number	List Price Each	E Epoxy Coat Add to List	SS Stainless Steel Hardware Add to List	EB Electro Coat Hardware Add to List	Appr Wt Each Lbs
2	2.38	5	2	210-0250	\$ 82.90	\$ 28.70	\$ 60.30	\$ 16.60	8
2-1/4, 2-1/2	2.88	5	2	210-0288	109.60	28.70	60.30	16.60	9
3	3.50	6	3	211-0350	141.00	28.70	96.90	19.00	15
4	4.50	6	4	211-0450	187.50	38.10	129.10	22.40	20
6	6.63	6	5	211-0663	262.10	38.10	161.10	29.30	28
8	8.63	6	6	211-0863	332.90	38.10	193.60	34.40	38
10	10.75	6	7	211-1075	422.30	38.10	226.00	40.00	46
12	12.75	6	8	211-1275	507.80	38.10	257.80	44.90	64
16	16.00	7	10	211-1600	1,159.10	46.90	461.10	67.40	132
18	18.00	7	12	211-1800	1,620.40	46.90	553.50	80.70	140
20	20.00	7	12	211-2000	1,860.80	46.90	553.50	80.70	150
24	24.00	7	13	211-2400	2,087.10	46.90	648.30	117.70	165

Note: Applications in which pipe may move out of the coupling, proper anchorage of the pipe must be provided.

### Optional Coating and Bolts

Shopcoat Primer/Stainless Steel Hardware	(SS)
Shopcoat Primer/Electro-coated Hardware	(EB)
Epoxy Coating/Alloy Hardware	(E)
Epoxy Coat/Stainless Steel Hardware	(ES)
Epoxy Coat/Electro-coated Hardware	(EE)

### Add codes catalog number



## JCM 212 Ductile Iron Transition Couplings

Nom Pipe Size (IN)	Pipe OD Range (IN)	To Pipe OD Range (IN)	Catalog Number	List Price Each	E Epoxy Coat Add to List	SS Stainless Steel Hardware Add to List	EB Electro Coat Hardware Add to List	No. of Bolts	Sleeve Length	Appr Wt Each Lbs
2, 2-1/2	2.62 - 2.92	2.38 - 2.50	212-0288-0238	\$ 120.30	\$ 28.70	\$ 60.30	\$ 16.60	2	5	9
3	3.80 - 4.17	3.50	212-0396-0350	147.60	28.70	96.90	18.90	3	6	15
4	4.50	4.00	212-0450-0400	187.50	38.10	129.10	22.40	4	6	20
4	4.50	4.22	212-0450-0422	187.50	38.10	129.10	22.40	4	6	20
4	4.80 - 5.10	4.00	212-0480-0400	187.50	38.10	129.10	22.40	4	6	20
4	4.80 - 5.10	4.22	212-0480-0422	187.50	38.10	129.10	22.40	4	6	20
4	4.80 - 5.10	4.50	212-0480-0450	183.80	38.10	129.10	22.40	4	6	20
6	6.63	6.00	212-0663-0600	294.90	38.10	161.10	29.30	5	6	26
6	6.63	6.30	212-0663-0630	294.90	38.10	161.10	29.30	5	6	26
6	6.90 - 7.20	6.00	212-0690-0600	294.90	38.10	161.10	29.30	5	6	26
6	6.90 - 7.20	6.30	212-0690-0630	294.90	38.10	161.10	29.30	5	6	26
6	6.90 - 7.20	6.63	212-0690-0663	249.50	38.10	161.10	29.30	5	6	26
8	8.63	8.00	212-0863-0800	368.70	38.10	193.60	34.40	6	6	38
8	8.63	8.40	212-0863-0840	368.70	38.10	193.60	34.40	6	6	38
8	9.05 - 9.40	8.00	212-0905-0800	368.70	38.10	193.60	34.40	6	6	38
8	9.05 - 9.40	8.40	212-0905-0840	368.70	38.10	193.60	34.40	6	6	38
8	9.05 - 9.40	8.63	212-0905-0863	315.90	38.10	193.60	34.40	6	6	38
10	10.75	10.50	212-1075-1050	436.70	38.10	226.00	40.00	7	6	46
10	11.10 - 11.40	10.50	212-1110-1050	436.70	38.10	226.00	40.00	7	6	46
10	11.10 - 11.40	10.75	212-1110-1075	409.50	38.10	226.00	40.00	7	6	46
12	12.75	12.50	212-1275-1250	559.10	38.10	257.80	44.90	8	6	64
12	13.20 - 13.50	12.50	212-1320-1250	536.70	38.10	257.80	44.90	8	6	64
12	13.20 - 13.50	12.75	212-1320-1275	524.80	38.10	257.80	44.90	8	6	64
24	26.10 - 26.32	25.70-26.00	212-2635-2580	2,500.70	46.90	648.30	117.70	14	10	285

Note: Applications in which pipe may move out of the coupling, proper anchorage of the pipe must be provided.

### Optional Coating and Bolts

- Shopcoat Primer/Stainless Steel Hardware (SS)
- Shopcoat Primer/Electro-coated Hardware (EB)
- Epoxy Coating/Alloy Hardware (E)
- Epoxy Coat/Stainless Steel Hardware (ES)
- Epoxy Coat/Electro-coated Hardware (EE)

### Add codes to base catalog number



Certified to  
NSF/ANSI/CAN 61  
& NSF/ANSI 372

## JCM 214 Pipe End Cap Couplings (with 2" IP Outlet)

Nom Pipe Size (IN)	Pipe OD Range (IN)	Catalog Number	List Price Each	E Epoxy Coat Add to List	SS Stainless Steel Hardware Add to List	EB Electro Coat Hardware Add to List	No. of Bolts	Sleeve Length	Appr Wt Each Lbs
3*	3.50	214-0350	\$ 234.30	\$ 28.70	\$ 96.90	\$ 19.00	3	6	19
3*	3.80 - 4.17	214-0396	234.30	28.70	96.90	19.00	3	6	19
4	4.50	214-0450	239.40	38.10	129.10	22.40	4	6	25
4	4.80 - 5.10	214-0480	239.40	38.10	129.10	22.40	4	6	25
6	6.63	214-0663	358.80	38.10	161.10	29.50	5	6	32
6	6.90 - 7.20	214-0690	358.80	38.10	161.10	29.50	5	6	32
8	8.63	214-0863	494.60	38.10	193.60	34.40	6	6	51
8	9.05 - 9.40	214-0905	494.60	38.10	193.60	34.40	6	6	49
10	10.75	214-1075	801.60	38.10	226.00	40.00	7	6	64
10	11.10 - 11.40	214-1110	801.60	38.10	226.00	40.00	7	6	64
12	12.75	214-1275	808.00	38.10	257.80	44.90	8	6	88
12	13.20 - 13.50	214-1320	865.90	38.10	257.80	44.90	8	6	86

\*Pipe sizes 3.50 & 3.96 have 1-1/2" IPS outlet.

Other outlet sizes available. Price on inquiry.

Note: Applications in which pipe may move out of the coupling, proper anchorage of the pipe must be provided.

Requires thrust blocks or restraint. Restrained ends available sizes 4" -12". Add (R) to end of catalog number to indicate restrained ends. (Not for use A/C pipe, HDPE or PVC pipe). Price on inquiry.

### Optional Coating and Bolts

Shopcoat Primer/Stainless Steel Hardware	(SS)
Shopcoat Primer/Electro-coated Hardware	(EB)
Epoxy Coating/Alloy Hardware	(E)
Epoxy Coat/Stainless Steel Hardware	(ES)
Epoxy Coat/Electro-coated Hardware	(EE)

### Add codes to base catalog number



Certified to  
NSF/ANSI/CAN 61  
& NSF/ANSI 372

## JCM 215 Long Ductile Iron Couplings

Nom Pipe Size (IN)	Pipe OD Range (IN)	Catalog Number	List Price Each	E Epoxy Coat Add to List	SS Stainless Steel Hardware Add to List	EB Electro Coat Hardware Add to List	No. of Bolts	Sleeve Length	Appr Wt Each Lbs
2	2.34 - 2.63	215-0250	\$ 177.90	\$ 28.70	\$ 94.00	\$ 19.00	2	10	16
2-1/2	2.62 - 2.92	215-0288	198.50	28.70	94.00	19.00	2	10	18
3	3.50	215-0350	254.40	28.70	141.20	19.00	3	12	30
3	3.80 - 4.17	215-0396	248.20	28.70	141.20	19.00	3	12	30
4	4.50	215-0450	411.70	38.10	188.30	26.10	4	12	35
4	4.80 - 5.10	215-0480	388.80	38.10	188.30	26.10	4	12	35
6	6.63	215-0663	529.10	38.10	235.20	31.10	5	12	48
6	6.90 - 7.20	215-0690	492.20	38.10	235.20	31.10	5	12	48
8	8.63	215-0863	730.20	38.10	282.30	38.00	6	12	65
8	9.05 - 9.40	215-0905	682.40	38.10	282.30	38.00	6	12	65
10	10.75	215-1075	808.60	38.10	329.30	43.50	7	12	79
10	11.10 - 11.40	215-1110	781.80	38.10	329.30	43.50	7	12	79
12	12.75	215-1275	893.10	38.10	376.20	50.00	8	12	111
12	13.20 - 13.50	215-1320	860.30	38.10	376.20	50.00	8	12	111

Note: Applications in which pipe may move out of the coupling, correct anchorage of the pipe must be provided.

### Optional Coating and Bolts

Shopcoat Primer/Stainless Steel Hardware	(SS)
Shopcoat Primer/Electro-coated Hardware	(EB)
Epoxy Coating/Alloy Hardware	(E)
Epoxy Coat/Stainless Steel Hardware	(ES)
Epoxy Coat/Electro-coated Hardware	(EE)

### Add codes to base catalog number



## JCM 219 Restrained Ductile Iron Couplings

Nom Pipe Size (IN)	Pipe OD Range (IN)	Catalog Number	List Price Each	No. of Bolts	No. of Set Screws Each End	Appr Wt Each Lbs
3	3.80 - 4.17	219-0396	P.O.A.	4	4	19
4	4.80 - 5.10	219-0480	P.O.A.	4	4	22
6	6.90 - 7.20	219-0690	P.O.A.	8	8	38
8	9.05 - 9.40	219-0905	P.O.A.	8	8	46
10	11.10 - 11.40	219-1110	P.O.A.	12	12	67
12	13.20 - 13.50	219-1320	P.O.A.	12	12	81

Larger sizes available upon request.

Restrained ends are not for use on Asbestos Cement, HDPE or PVC pipe.



## JCM 220 Galvanized Compression Fittings

Nom Pipe Size (IN)	Pipe OD Range (IN)	Overall Length	Catalog Number	List Price Each	Ctn Qty	Ctn Wt	Appr Wt Each Lbs
1/2	0.84	4-1/8	220-0084-L	\$ 20.20	12	11	0.8
3/4	1.05	4-1/4	220-0105-L	22.60	12	14	1.08
1	1.32	4-1/2	220-0132-L	30.30	12	19	1.42
1-1/4	1.66	4-3/4	220-0166-L	36.80	12	23	1.92
1-1/2	1.90	5	220-0190-L	42.00	12	28	2.33
2	2.38	5-1/4	220-0238-L	59.00	12	40	3.38

Pressure rating: 150 PSI

Not suitable for gas service



## 225 Insulating Adapter Gaskets

Nom Pipe Sizes	Pipe Range	Catalog Number	List Price Each
1/2 IP X 1/2 CT	.84 to .63	225-0084-0063	\$ 12.60
3/4 IP X 3/4 CT	1.05 to .80	225-0105-0080	17.90
1 IP X 1 CT	1.32 to 1.13	225-0132-0113	17.90
1-1/4 IP X 1-1/4 CT	1.66 to 1.38	225-0166-0138	24.00
1-1/2 IP X 1-1/2 CT	1.90 to 1.63	225-0190-0163	25.90
2 IP X 2 CT	2.38 to 2.13	225-0238-0213	36.60



Gasket: NBR



## JCM G212 Gaskets for Standard Size Couplings

Nom. Pipe Size (IN)	Fits Coupling Sleeve	Pipe OD Range (IN)	Gasket OD Range	Catalog Number	List Price Each
2	288	2.62 - 2.92	CI, 2-1/2" PVC, STEEL	G212-0288	\$ 7.10
		2.38 - 2.50	2" PVC, STEEL, CI	G212-0288-0238*	15.40
3	396	3.80 - 4.17	CI, DI, A/C 150, C-900 PVC	G212-0396	8.30
		3.50	IPS PVC, STEEL	G212-0396-0350*	11.80
4	480	4.74 - 5.10	CI, DI, A/C 150, C-900 PVC	G212-0480	9.50
		4.50	IPS PVC, STEEL, HDPE	G212-0480-0450	20.20
		4.22	SDR 35	G212-0480-0422	44.90
		4.00	STEEL TUBING	G212-0480-0400	44.90
6	690	6.84 - 7.26	CI, DI, A/C 150, C-900 PVC	G212-0690	13.00
		6.63	IPS PVC, STEEL, HDPE	G212-0690-0663	29.60
		6.30	SDR 35	G212-0690-0630	51.90
		6.00	STEEL TUBING	G212-0690-0600	51.90
8	905	8.99 - 9.42	CI, DI, A/C 150, C-900 PVC	G212-0905	17.70
		8.63	IPS PVC, STEEL, HDPE	G212-0905-0863	40.20
		8.40	SDR 35	G212-0905-0840	60.20
		8.00	STEEL TUBING	G212-0905-0800	60.20
10	1110	11.04 - 11.40	CI, DI, C-900 PVC	G212-1110	39.00
		10.75	IPS PVC, STEEL, HDPE	G212-1110-1075	51.90
		10.50	SDR 35	G212-1110-1050	62.50
12	1320	13.14 - 13.50	CI, DI, C-900 PVC	G212-1320	40.90
		12.75	IPS PVC, STEEL, HDPE	G212-1320-1275	62.50
		12.50	SDR 35	G212-1320-1250	97.60

\*This size gasket does not have extended lip.

## JCM Transition Gaskets for Oversized Fabricated Couplings

Nom. Pipe Size (IN)	Fits Coupling Sleeve	Pipe OD Range (IN)	Gasket OD Range	Catalog Number	List Price Each
4	535	5.06 - 5.40	A/C	G212-0535	\$ 15.40
		4.80 - 5.10	CI, DI, C-900 PVC	G212-0535-0480	33.00
		4.50	IPS PVC, STEEL, HDPE	G212-0535-0450	30.70
6	740	7.17 - 7.55	A/C	G212-0740	23.60
		6.90 - 7.10	CI, DI, C-900 PVC	G212-0740-0690	35.50
		6.63	IPS PVC, STEEL, HDPE	G212-0740-0663	39.00
8	960	9.32 - 9.75	A/C	G212-0967	23.60
		9.05 - 9.30	CI, DI, C-900 PVC	G212-0967-0905	48.40
		8.63	IPS PVC, STEEL, HDPE	G212-0967-0863	56.70
10	1200	11.60 - 12.05	A/C	G212-1200	40.20
		11.10 - 11.30	CI, DI, C-900 PVC	G212-1200-1110	62.40
		10.75	IPS PVC, STEEL, HDPE	G212-1200-1075	77.80
12	1420	13.92 - 14.40	A/C	G212-1420	46.10
		13.20 - 13.50	CI, DI, C-900 PVC	G212-1420-1320	98.00
		12.75	IPS PVC, STEEL, HDPE	G212-1420-1275	121.50



Certified to  
NSF/ANSI/CAN 61  
& NSF/ANSI 372

## JCM 230 HDPE Stiffener 6" width

Nom Pipe Size (IN)	Stiffener Width (IN)	230 Stiffener Catalog Number	List Price Each	Appr Wt Each
4	6	230-04-xxxx	\$ 94.30	2
6	6	230-06-xxxx	101.50	4
8	6	230-08-xxxx	110.50	5
10	6	230-10-xxxx	119.60	7
12	6	230-12-xxxx	130.40	11
14	6	230-14-xxxx	134.90	12
16	6	230-16-xxxx	148.90	16
18	6	230-18-xxxx	157.10	18
20	6	230-20-xxxx	166.50	19
22	6	230-22-xxxx	191.00	20
24	6	230-24-xxxx	238.70	23
30	6	230-30-xxxx	285.80	28
36	6	230-36-xxxx	381.20	31



## JCM 231 HDPE Stiffener 12" width

Nom Pipe Size (IN)	Stiffener Width (IN)	231 Stiffener Catalog Number	List Price Each	Appr Wt Each
4	12	231-04-xxxx	\$ 187.70	7
6	12	231-06-xxxx	202.50	10
8	12	231-08-xxxx	220.70	13
10	12	231-10-xxxx	239.40	19
12	12	231-12-xxxx	260.80	20
14	12	231-14-xxxx	269.30	28
16	12	231-16-xxxx	297.80	33
18	12	231-18-xxxx	313.90	37
20	12	231-20-xxxx	334.10	39
22	12	231-22-xxxx	381.20	40
24	12	231-24-xxxx	476.80	42
30	12	231-30-xxxx	572.10	46
36	12	231-36-xxxx	762.10	48

Actual inside pipe diameter provided by the customer

Smallest I.D./O.D. available 3.50 - Sizes larger than 36" available upon request

Nominal Size Stiffeners 4" - 22" are 17 Gauge Stainless Steel Material

Nominal Size Stiffeners 24" - 36" are 12 Gauge Stainless Steel Material

Available for Steel Size and Ductile Iron Size HDPE in SDR11,13.5, 17, 21, 26, 32.5

Material Specifications: ASTM A240 - TP 304 Stainless Steel.

Optional 316 Stainless Steel available, contact JCM for price and availability

Flared end available up to 35.00 size, larger sizes incorporate tab stop.

### HOW TO ORDER

1. Select nominal pipe size of HDPE
2. Select width of stiffener. For 6" width, Model 230. For 12" width, Model 231
3. Insert ACTUAL HDPE PIPE I.D. (provided by end user) @ XXXX.

The pipe I.D. determines the stiffener O.D. and completes the order number

**EXAMPLE:** To order a 304 stainless, 12" wide stiffener, for IPS size 8" nominal SDR 17 Pipe with an actual pipe I.D. of 7.55, order number: 231-08-0755

Stiffeners are Non-Returnable Items. To ensure proper fit/size, JCM recommends the actual pipe in the field be measured.

## JCM 241 Standard Length Optimum Range Ductile Iron Couplings

Nom Pipe Size (IN)	Pipe OD Range (IN)	Sleeve Length	No. of Bolts	Catalog Number	List Price Each	E Epoxy Coat Add to List	SS Stainless Steel Hardware Add to List	EB Electro Coat Hardware Add to List	Appr Wt Each Lbs
3	3.45 - 4.20	6	3	241-0420	\$ 226.80	\$ 29.60	\$ 159.90	\$ 23.10	22
4	4.22 - 5.60	6	4	241-0550	302.40	39.30	212.40	24.30	30
6	6.28 - 7.60	6	5	241-0760	434.80	39.30	265.70	31.90	39
8	8.40 - 9.75	6	6	241-0960	542.10	39.30	312.80	39.20	45
10	10.50 - 12.12	6	8	241-1200	638.80	39.30	425.40	51.00	62
12	12.50 - 14.38	6	8	241-1430	817.30	39.30	425.40	51.00	71

Applications in which pipe may move out of the coupling, correct anchorage of the pipe must be provided.

**New! Other widths available upon request. Contact the JCM Sales Team for price and availability!**

## JCM 242 Long Length Optimum Range Ductile Iron Couplings

Nom Pipe Size (IN)	Pipe OD Range (IN)	Sleeve Length	No. of Bolts	Catalog Number	List Price Each	E Epoxy Coat Add to List	SS Stainless Steel Hardware Add to List	EB Electro Coat Hardware Add to List	Appr Wt Each Lbs
3	3.45 - 4.20	10	3	242-0420	\$ 270.70	\$ 29.60	\$ 145.20	\$ 23.10	26
4	4.22 - 5.60	10	4	242-0550	347.40	39.40	193.60	26.80	35
6	6.28 - 7.60	10	5	242-0760	472.70	39.40	242.00	31.90	46
8	8.40 - 9.75	10	6	242-0960	602.20	39.40	290.60	39.20	55
10	10.50 - 12.12	10	8	242-1200	728.50	39.40	387.00	51.70	85
12	12.50 - 14.38	10	8	242-1430	940.30	39.40	387.10	51.70	100
14	15.05 - 16.93	10	10	242-1690	1,971.20	47.70	470.40	53.00	115
16	17.32 - 19.20	10	11	242-1920	2,056.80	54.50	519.30	57.10	147

Applications in which pipe may move out of the coupling, correct anchorage of the pipe must be provided.

**New! Other widths available upon request. Contact the JCM Sales Team for price and availability!**

### Optional Coating and Bolts

Shopcoat Primer/Stainless Steel Hardware	(SS)
Shopcoat Primer/Electro-coated Hardware	(EB)
Epoxy Coating/Alloy Hardware	(E)
Epoxy Coat/Stainless Steel Hardware	(ES)
Epoxy Coat/Electro-coated Hardware	(EE)

### Add codes to base catalog number



241



242

## JCM 262 Fabricated Stainless Steel Couplings

The JCM 262 Fabricated Stainless Steel Coupling provides an economical solution to joining two plain end pieces of pipe. Constructed of Carbon Steel End Rings with resilient Fusion Plastic Coating, a 304 Stainless Steel middle ring and alloy hardware, electrocoated with Powercron 590-534, the JCM 262 is prepared for the harshest of elements, corrosive line content - or both!

For American Iron and Steel (AIS) Compliance, contact JCM Sales Team for price and availability.

Nom Pipe Size	From OD Range (IN)	To OD Range (IN)	Catalog Number	No of Bolts	Effective Length (IN)	Overall Length (IN)	Bolt Size & Length (IN)	List Price	Appr Wt Ea (LBS)
3	3.80 - 4.17	3.50	262-0396-0350	3	5.63	7.5	5/8 X 9	\$ 344.60	16
3	3.80 - 4.17	3.80 - 4.17	262-0396	3	5.63	7.5	5/8 X 9	340.40	16
4	4.5	4.50	262-0450	4	5.63	7.5	5/8 X 9	388.70	18
4	4.5	4.00	262-0450-0400	4	5.63	7.5	5/8 X 9	413.40	18
4	4.5	4.22	262-0450-0422	4	5.63	7.5	5/8 X 9	413.40	18
4	4.80 - 5.10	4.80 - 5.10	262-0480	4	5.63	7.5	5/8 X 9	367.30	18
4	4.80 - 5.10	4.00	262-0480-0400	4	5.63	7.5	5/8 X 9	402.70	18
4	4.80 - 5.10	4.22	262-0480-0422	4	5.63	7.5	5/8 X 9	402.70	18
4	4.80 - 5.10	4.5	262-0480-0450	4	5.63	7.5	5/8 X 9	378.00	18
6	6.63	6.63	262-0663	5	5.63	7.5	5/8 X 9	535.50	21
6	6.63	6.00	262-0663-0600	5	5.63	7.5	5/8 X 9	557.80	21
6	6.63	6.30	262-0663-0630	5	5.63	7.5	5/8 X 9	557.80	21
6	6.90 - 7.20	6.90 - 7.20	262-0690	5	5.63	7.5	5/8 X 9	502.40	21
6	6.90 - 7.20	6.00	262-0690-0600	5	5.63	7.5	5/8 X 9	541.40	21
6	6.90 - 7.20	6.30	262-0690-0630	5	5.63	7.5	5/8 X 9	541.40	21
6	6.90 - 7.20	6.63	262-0690-0663	5	5.63	7.5	5/8 X 9	518.40	21
8	8.63	8.63	262-0863	6	5.63	7.5	5/8 X 9	695.80	28
8	8.63	8.00	262-0863-0800	6	5.63	7.5	5/8 X 9	715.80	28
8	8.63	8.40	262-0863-0840	6	5.63	7.5	5/8 X 9	715.80	28
8	9.05 - 9.40	9.05 - 9.40	262-0905	6	5.63	7.5	5/8 X 9	650.80	28
8	9.05 - 9.40	8.00	262-0905-0800	6	5.63	7.5	5/8 X 9	693.30	28
8	9.05 - 9.40	8.40	262-0905-0840	6	5.63	7.5	5/8 X 9	693.30	28
8	9.05 - 9.40	8.63	262-0905-0863	6	5.63	7.5	5/8 X 9	673.30	28
10	10.75	10.75	262-1075	7	5.63	7.5	5/8 X 9	825.60	37
10	10.75	10.50	262-1075-1050	7	5.63	7.5	5/8 X 9	836.00	37
10	11.10 - 11.40	11.10 - 11.40	262-1110	7	5.63	7.5	5/8 X 9	799.40	37
10	11.10 - 11.40	10.50	262-1110-1050	7	5.63	7.5	5/8 X 9	823.00	37
10	11.10 - 11.40	10.75	262-1110-1075	7	5.63	7.5	5/8 X 9	812.50	37
12	12.75	12.75	262-1275	8	5.63	7.5	5/8 X 9	987.60	44
12	12.75	12.50	262-1275-1250	8	5.63	7.5	5/8 X 9	1,023.10	44
12	13.20 - 13.50	13.20 - 13.50	262-1320	8	5.63	7.5	5/8 X 9	945.20	44
12	13.20 - 13.50	12.50	262-1320-1250	8	5.63	7.5	5/8 X 9	1,001.80	44
12	13.20 - 13.50	12.75	262-1320-1275	8	5.63	7.5	5/8 X 9	966.40	44

Note: Applications in which pipe may move out of the coupling, proper anchorage of the pipe must be provided.

Custom sizes & lengths available upon request. Contact JCM Industries, Inc.

Purchase orders for the JCM Industries, Inc 262 type coupling signify an agreement between the manufacturer and customer that both parties agree to the JCM test procedure for meeting ANSI/AWWA C219 Standard for Bolted, Sleeve-Type Couplings for Plain-End Pipe. All couplings are pneumatically tested to a minimum of 25 PSI. Additional testing for certification purposes available upon request with additional charge.

## JCM 262 Oversized Fabricated Stainless Steel Couplings

The JCM 262 Oversized Fabricated Stainless Steel Coupling provides an economical solution for joining old cast iron, larger classes of asbestos cement and other types of oversized pipe. The JCM 262 Coupling uses the popular and economical JCM G212 Transition Gasket System. Making transitions of the same nominal pipe size easy with just the change of gasket. The JCM 262 Oversized Coupling is constructed of same corrosion resistant materials - Carbon Steel End Rings with resilient Fusion Plastic Coating, a 304 Stainless Steel middle ring and alloy hardware, electrocoated with Powercron 590-534, the JCM 262 is prepared for the harshest of elements, corrosive line content - or both!

**For American Iron and Steel (AIS) Compliance, contact JCM Sales Team for price and availability.**

Nom. Pipe Size	From OD Range (IN)	To OD Range (IN)	Catalog Number	No of Bolts	Effective Length (IN)	Overall Length (IN)	Bolt Size & Length (IN)	List Price	Appr Wt Ea (LBS)
4	5.10 - 5.40	5.10 - 5.40	262-0535	4	5.63	7.5	5/8 X 9	\$ 440.80	18
4	5.10 - 5.40	4.50	262-0535-0450	4	5.63	7.5	5/8 X 9	456.10	18
4	5.10 - 5.40	4.80	262-0535-0480	4	5.63	7.5	5/8 X 9	458.50	18
6	7.20 - 7.55	7.20 - 7.55	262-0740	5	5.63	7.5	5/8 X 9	602.90	21
6	7.20 - 7.55	6.63	262-0740-0663	5	5.63	7.5	5/8 X 9	614.70	21
6	7.20 - 7.55	6.90	262-0740-0690	5	5.63	7.5	5/8 X 9	618.70	21
8	9.40 - 9.75	9.40 - 9.75	262-0960	6	5.63	7.5	5/8 X 9	781.00	28
8	9.40 - 9.75	8.63	262-0960-0863	6	5.63	7.5	5/8 X 9	805.80	28
8	9.40 - 9.75	9.05	262-0960-0905	6	5.63	7.5	5/8 X 9	814.10	28
10	11.60 - 12.05	11.60 - 12.05	262-1200	7	5.63	7.5	5/8 X 9	959.30	37
10	11.60 - 12.05	10.75	262-1200-1075	7	5.63	7.5	5/8 X 9	981.70	37
10	11.60 - 12.05	11.10	262-1200-1110	7	5.63	7.5	5/8 X 9	997.00	37
12	13.92 - 14.40	13.92 - 14.40	262-1420	8	5.63	7.5	5/8 X 9	1,134.10	44
12	13.92 - 14.40	12.75	262-1420-1275	8	5.63	7.5	5/8 X 9	1,185.90	44
12	13.92 - 14.40	13.20	262-1420-1320	8	5.63	7.5	5/8 X 9	1,209.60	44

Note: Applications in which pipe may move out of the coupling, proper anchorage of the pipe must be provided.

Custom sizes & lengths available upon request. Contact JCM Industries, Inc.

Purchase orders for the JCM Industries, Inc 262 type coupling signify an agreement between the manufacturer and customer that both parties agree to the JCM test procedure for meeting ANSI/AWWA C219 Standard for Bolted, Sleeve-Type Couplings for Plain-End Pipe. All couplings are pneumatically tested to a minimum of 25 PSI. Additional testing for certification purposes available upon request with additional charge.



**JCM 262 Fabricated Stainless Steel Coupling**



### JCM 4262 All 304 Stainless Steel Coupling JCM 6262 All 316 Stainless Steel Coupling



JCM 4262 All 304 Stainless Steel Coupling and 6262 All 316 Stainless Steel Couplings are available in sizes listed above - constructed of all stainless steel materials for harshest environments.

Contact JCM Industries for Price and Availability

Available American Iron and Steel (AIS) Compliant upon request

## JCM Product Bolt Options

Hardware sold in complete assembly only. Assembly includes bolt, nut and appropriate washers.

### JCM Product Model

Alloy Hardware Assemblies	Product Size	Bolt Size	Order Number	Price Each
210 - 211 - 212 Ductile Couplings	0238 - 0288	5/8 x 7-1/2	46034	\$ 8.00
210 - 211 - 212 Ductile Couplings - Electro Coated	0238 - 0288	5/8 x 7-1/2	46016	11.40
210 - 211 - 212 Ductile Couplings	0350 - 1420	5/8 x 9	46035	8.90
210 - 211 - 212 Ductile Couplings - Electro Coated	0350 - 1420	5/8 x 9	45111	14.70
210 - 211 - 212 Ductile Couplings	1530 - 1780	5/8 x 11	46036	13.50
210 - 211 - 212 - 241 Ductile Couplings - Electro Coated	1530 - 1780	5/8 x 11	46019	16.80
215 Long Ductile Iron Coupling	0250 - 1420	5/8 x 15	46039	17.40
215 - 242 Ductile Iron Couplings - Electro Coated	0250 - 1430	5/8 x 15	46020	21.70
241 Optimum Range Ductile Coupling	0420 - 1430	5/8 x 11	46036	13.50
242 Optimum Range Ductile Coupling	0420 - 1430	5/8 x 15	46039	17.40
412 Fabricated Tapping Sleeve	0690 - 0745	5/8 x 6-1/2	46014	11.40
412 Fabricated Tapping Sleeve	0905 - 0940	3/4 x 8-3/4	46012	19.10
412 Fabricated Tapping Sleeve	1000 - 3200	3/4 x 10	46013	21.60

304 Stainless Steel Hardware Assemblies	Product Size	Bolt Size	Order Number	Price Each
201 Steel Couplings	0084 - 0190	1/2 x 7-1/2	46042	\$ 20.40
201 Steel Coupling 5" Middle Ring	0230 - 1275	5/8 x 9	46031	41.00
201 Steel Coupling 7" Middle Ring	0350 - 3200	5/8 x 11	46033	65.30
201 Steel Coupling 10" Middle Ring	3600 - 5080	5/8 x 15	46038	60.50
210 - 211 - 212 Ductile Couplings	0238 - 0288	5/8 x 7-1/2	46009	37.90
210 - 211 - 212 Ductile Couplings	0350 - 1420	5/8 x 9	46031	41.00
210 - 211 - 212 Ductile Couplings	1530 - 1780	5/8 x 11	46033	65.30
215 Long Ductile Iron Coupling	0250 - 1420	5/8 x 15	46038	60.20
241 Optimum Range Ductile Coupling	0420 - 1430	5/8 x 11	46033	65.30
242 Optimum Range Ductile Coupling	0420 - 1430	5/8 x 15	46038	60.20
412 - 419 Fabricated Tapping Sleeve	0690 - 0745	5/8 x 6-1/2	46008	35.30
412 - 419 Fabricated Tapping Sleeve	0905 - 0940	3/4 x 8-3/4	46010	60.80
412 - 419 Fabricated Tapping Sleeve	1000 - 3200	3/4 x 10	46011	71.00
422 - 429 Tapping Sleeve PVC/Steel/HDPE	0450 - 0905	5/8 x 6-1/2	46008	35.30
422 - 429 Tapping Sleeve PVC/Steel/HDPE	1075 - 1320	5/8 x 7-1/2	46009*	37.90
432 - 462 - 439 Stainless Tap Sleeve	0450 - 1000	5/8 x 6-1/2	46008	35.30
432 - 462 - 439 Stainless Tap Sleeve	1075 - 1320	5/8 x 7-1/2	46009*	37.90
432 - 462 - 439 Stainless Tap Sleeve	1392 - 2632	5/8 x 7-1/2	46009*	37.90
452 - 464 - 465 - 459 Tapping Sleeve Outlets 3" - 8"	0690 - 0940	5/8 x 6-1/2	46008	35.30
452 - 464 - 465 - 459 Tapping Sleeve Outlets 3" - 12"	1000 - 1420	5/8 x 7-1/2	46009*	37.90
452 - 464 - 465 - 459 Tapping Sleeve All Outlets	1475 - 3200	3/4 x 10	46040*	65.30

\*Indicates Double Washer Assembly

## JCM 301 Flanged Coupling Adapters

Nom Pipe Size (IN)	Pipe OD Range (IN)	Catalog Number	List Price Each	Qty Optional Set Screws	Price Each with Restraining Set Screws	Appr Wt Each Lbs
3	3.50	301-0350	\$ 253.60	4	\$ 359.70	20
	3.80 - 4.17	301-0396	253.60	4	359.70	20
4	4.00	301-0400	354.10	N/A	N/A	30
	4.50	301-0450	329.10	4	422.60	30
	4.80 - 5.10	301-0480	329.10	4	422.60	30
6	6.00	301-0600	442.60	N/A	N/A	34
	6.63	301-0663	420.10	8	525.20	34
	6.90 - 7.20	301-0690	420.10	8	525.20	34
8	8.00	301-0800	597.80	N/A	N/A	44
	8.63	301-0863	576.80	8	672.80	44
	9.05 - 9.40	301-0905	576.80	8	672.80	44
10	10.75	301-1075	1,044.70	12	1,173.60	67
	11.10 - 11.40	301-1110	1,044.70	12	1,173.60	67
12	12.75	301-1275	1,158.30	12	1,352.40	95
	13.20 - 13.50	301-1320	1,158.30	12	1,352.40	95

\*Set Screws are not for use on Asbestos Cement, HDPE or PVC pipe.

Add (R) to end of Catalog Number to indicate optional set screws.

Applications in which pipe may move out of the coupling, proper anchorage of the pipe must be provided.



**301 FCA**



**301 FCA Restrained**

### Material Specifications JCM 301 Flanged Coupling Adapters

- Sleeve & Flanges:** Sleeve - Ductile Iron Per ASTM A536 80-55-06.  
Flange - Ductile Iron with ANSI Class 125 & 150 bolt pattern
- Gaskets:** Styrene-Butadiene Rubber (SBR). Compounded for use with water, salt solutions, mild acids and bases; has excellent abrasion resistance. Per ASTM D-2000. Standard temperature range from -40° to 150°F (-40° to 65 °C) constant, maximum intermittent 180°F (82° C). Not recommended for use on oil, ozone or weather resistant applications.
- Bolts:** 5/8" Corrosion resistant, high strength low alloy oval neck track head bolts per ASTM A242/ANSI 21.11/AWWA C111 and heavy hex nuts per A563 or equal. Optional Hardware: Stainless Steel 18-8 Type 304 or 316 or Epoxy Coated Alloy Hardware, Powercron 590-534 black cationic electrocoat.
- Coating:** Corrosion resistant shop coat paint primer. Optional fusion applied epoxy coating per ANSI/AWWA C-213. Other coatings available upon request.
- Working Pressure:** Fittings are rated for 150 PSI working pressure when installed per manufacturer's instructions. For higher working pressure applications, contact JCM Industries.
- Set Screws:** Mild Carbon - with square head for future disassembly or removal.
- RESTRAINED FITTINGS USING SET SCREWS ARE NOT RECOMMENDED FOR ASBESTOS CEMENT, PVC, HDPE, FIBERGLASS OR ANY OTHER TYPES OF NON-RIGID OR BRITTLE PIPE MATERIALS.

JCM 300 Series Flanged Adapters are ANSI/NSF Standard 61, Annex G and ANSI/NSF 372 Certified.  
JCM 300 Series Flanged Adapters meet or exceed the ANSI/AWWA C219 Standard as applicable.

## JCM 303 Flanged Coupling Adapters - Standard 125/150 Bolt Pattern

Nom Pipe Size (IN)	Pipe OD Range (IN)	Nominal Flange Size	Catalog Number	List Price Each	Appr Wt Each Lbs
3	3.50	3	303-0350 X 3	\$ 505.90	19
4	4.50	4	303-0450 X 4	545.30	25
4	4.80 - 5.00	4	303-0480 X 4	617.00	26
5	5.56	5	303-0556 X 5	679.40	32
6	6.63	6	303-0663 X 6	771.10	38
6	6.90 - 7.10	6	303-0690 X 6	796.00	40
8	8.63	8	303-0863 X 8	957.60	50
8	9.05 - 9.30	8	303-0905 X 8	986.30	52
10	10.75	10	303-1075 X 10	1,201.20	58
10	11.10 - 11.40	10	303-1110 X 10	1,230.00	61
12	12.75	12	303-1275 X 12	1,429.60	78
12	13.20 - 13.50	12	303-1320 X 12	1,452.50	84
14	14.00	14	303-1400 X 14	1,653.30	90
14	15.30	14	303-1530 X 14	1,717.50	110
14	15.65	14	303-1565 X 14	1,754.50	110
16	16.00	16	303-1600 X 16	1,850.00	113
16	17.40	16	303-1740 X 16	2,079.40	130
16	17.80	16	303-1780 X 16	2,133.40	137
18	18.00	18	303-1800 X 18	2,197.80	137
18	19.50	18	303-1950 X 18	2,499.00	144
18	19.92	18	303-1992 X 18	2,577.90	144
20	20.00	20	303-2000 X 20	2,631.80	158
20	21.60	20	303-2160 X 20	3,001.20	162
20	22.06	20	303-2206 X 20	3,055.20	162
24	24.00	24	303-2400 X 24	3,234.60	192
24	25.80	24	303-2580 X 24	3,461.50	220
24	26.32	24	303-2632 X 24	3,639.10	220
30	32.00	30	303-3200 X 30	P.O.A.	442
36	38.30	36	303-3830 X 36	P.O.A.	602
42	44.50	42	303-4450 X 42	P.O.A.	771

FLANGES: Standard 125/150 bolt pattern. Other flange patterns available upon request.

Other sizes available upon request.

Epoxy coating and stainless steel bolts are available as an extra.

NOTE: Applications in which pipe may move out of the coupling, correct anchorage of the pipe must be provided.

### Material Specifications



303

#### Sizes 3" - 12"

**Middle Ring:** Steel per ASTM A-36

**Follower:** Ductile Iron ASTM A536

#### Sizes 14" and Larger

**Middle Ring:** Steel per ASTM A-36

**Follower:** Steel per ASTM A-36

**Flange:** AWWA C207 Class D Flange with ANSI 150 lb. drilling.

**Gaskets:** Nitrile Butadiene Rubber (NBR, Buna-N) per ASTM D2000. Molded virgin rubber. Gasket temperature range -40°F to 212°F (-40°C - 100°C) Recommended for water, salt solutions, mild acids, bases, sewage and natural gas. Available Options: EPDM

**Bolts:** Nominal sizes 2" and larger: minimum 5/8" bolts ASTM A242/ANSI 21.11/AWWA C-111 corrosion resistant, high strength low alloy; heavy hex nuts A563 per ANSI/AWWA C219. Available Options: epoxy coated, Powercron 590-534; Stainless Steel 18-8 Type 304, Stainless Steel 18-8 Type 316.

**Finish:** Heavy coat of corrosion resistant shop coat primer. Optional fusion epoxy coating per AWWA C213.

JCM 300 Series FCA's are ANSI/NSF Standard 61, Annex G and ANSI/NSF 372 Certified.  
JCM 300 Series FCA's meet or exceed the ANSI/AWWA C219 Standard as applicable.





## JCM 304 Fabricated Flanged Coupling Adapters - Reducing

Nom Pipe Size (IN)	Pipe OD Range (IN)	Catalog Number	(X) Add Flange Size	List Price Each
4	4.50	304-0450	X	P.O.A.
4	4.80 - 5.00	304-0480	X	P.O.A.
5	5.56	304-0556	X	P.O.A.
6	6.63	304-0663	X	P.O.A.
6	6.90 - 7.10	304-0690	X	P.O.A.
8	8.63	304-0863	X	P.O.A.
8	9.05 - 9.30	304-0905	X	P.O.A.
10	10.75	304-1075	X	P.O.A.
10	11.10 - 11.40	304-1110	X	P.O.A.
12	12.75	304-1275	X	P.O.A.
12	13.20 - 13.50	304-1320	X	P.O.A.
14	14.00	304-1400	X	P.O.A.
14	15.30	304-1530	X	P.O.A.
14	15.65	304-1565	X	P.O.A.
16	16.00	304-1600	X	P.O.A.
16	17.40	304-1740	X	P.O.A.
16	17.80	304-1780	X	P.O.A.
18	18.00	304-1800	X	P.O.A.
18	19.50	304-1950	X	P.O.A.
18	19.92	304-1992	X	P.O.A.
20	20.00	304-2000	X	P.O.A.
20	21.60	304-2160	X	P.O.A.
20	22.06	304-2206	X	P.O.A.
24	24.00	304-2400	X	P.O.A.
24	25.80	304-2580	X	P.O.A.
24	26.32	304-2632	X	P.O.A.

Standard Available Flange Sizes
2
3
4
6
8
10
12
14
16
18
20
24

Other sizes available upon request

**FLANGES:** Standard 125/150 bolt pattern. Other flange patterns available upon request.

**304 Flanged Adapters** are priced on application. Contact JCM Sales Team 800-527-8482 or 903-832-2581



304

### Material Specifications

#### Sizes 3" - 12"

**Middle Ring:** Steel per ASTM A-36

**Follower:** Ductile Iron ASTM A536

#### Sizes 14" and Larger

**Middle Ring:** Steel per ASTM A-36

**Follower:** Steel per ASTM A-36

**Flange:** AWWA C207 Class D Flange with ANSI 150 lb. drilling.

**Gaskets:** Nitrile Butadiene Rubber (NBR, Buna-N) per ASTM D2000. Molded virgin rubber. Gasket temperature range -40°F to 212°F (-40°C - 100°C) Recommended for water, salt solutions, mild acids, bases, sewage and natural gas. Available Options: EPDM

**Bolts:** Nominal sizes 2" and larger: minimum 5/8" bolts ASTM A242/ANSI 21.11/AWWA C-111 corrosion resistant, high strength low alloy; heavy hex nuts A563 per ANSI/AWWA C219. Available Options: epoxy coated, Powercron 590-534; Stainless Steel 18-8 Type 304, Stainless Steel 18-8 Type 316.

**Finish:** Heavy coat of corrosion resistant shop coat primer. Optional fusion epoxy coating per AWWA C213.

JCM 300 Series FCA's are ANSI/NSF Standard 61, Annex G and ANSI/NSF 372 Certified. JCM 300 Series FCA's meet or exceed the ANSI/AWWA C219 Standard as applicable.



Certified to  
NSF/ANSI CAN 61  
& NSF/ANSI 372

## JCM 306 Flanged Coupling Adapters

Nom Pipe Size (IN)	Pipe OD Range (IN)	Nominal Flange Size	Catalog Number	List Price Each	Overall Length	Appr Wt Each Lbs
3	3.50	3	306-0350 X 3	\$ 477.30	12	32
	3.80 - 4.17	3	306-0396 X 3	477.30	12	32
4	4.50	4	306-0450 X 4	539.30	12	42
	4.80 - 5.10	4	306-0480 X 4	539.30	12	42
6	6.63	6	306-0663 X 6	755.50	12	59
	6.90 - 7.20	6	306-0690 X 6	755.50	12	59
8	8.63	8	306-0863 X 8	953.40	12	86
	9.05 - 9.40	8	306-0905 X 8	953.40	12	86
10	10.75	10	306-1075 X 10	1,220.90	12	115
	11.10 - 11.40	10	306-1110 X 10	1,220.90	12	115
12	12.75	12	306-1275 X 12	1,373.90	12	163
	13.20 - 13.50	12	306-1320 X 12	1,373.90	12	163

Epoxy coating and stainless steel bolts available as an extra.

Integral retainer set screws are available as an extra. Add (R) to end of catalog number. Price on application.

NOTE: Restraining set screws are not for use on Asbestos Cement, HDPE or PVC pipe.

NOTE: Applications in which pipe may move out of the coupling, proper anchorage of the pipe must be provided.

## JCM 307 Flanged Coupling Adapters

Nom Pipe Size (IN)	Pipe OD Range (IN)	Catalog Number	(X) Add Flange Size	Overall Length	List Price Each
3	3.50	307-0350	X	12	P.O.A.
	3.80 - 4.17	307-0396	X	12	P.O.A.
4	4.50	307-0450	X	12	P.O.A.
	4.80 - 5.10	307-0480	X	12	P.O.A.
6	6.63	307-0663	X	12	P.O.A.
	6.90 - 7.20	307-0690	X	12	P.O.A.
8	8.63	307-0863	X	12	P.O.A.
	9.05 - 9.40	307-0905	X	12	P.O.A.
10	10.75	307-1075	X	12	P.O.A.
	11.10 - 11.40	307-1110	X	12	P.O.A.
12	12.75	307-1275	X	12	P.O.A.
	13.20 - 13.50	307-1320	X	12	P.O.A.

Epoxy coating and stainless steel bolts available as an extra.

Integral retainer set screws are available as an extra. Add (R) to end of catalog number. Price on application.

NOTE: Restraining set screws are not for use on Asbestos Cement, HDPE or PVC pipe.

NOTE: Applications in which pipe may move out of the coupling, proper anchorage of the pipe must be provided.



Certified to  
NSF/ANSI/CAN 61  
& NSF/ANSI 372



306



307

## JCM 309 Dismantling Joint

Nom Pipe Size (IN)	Catalog Number	Flange AWWA Class D	Nominal (Mid Range) (IN)	Open Max (IN)	Closed Min (IN)	Bolts		Restraint Rods/Straps			Approx Wt Ea Lbs
						Qty	Size	Qty	Size	Length	
3	309-3	3	11.00	12.00	10.00	4	5/8 x 6-1/2	2	5/8	16	34
4	309-4	4	11.00	12.00	10.00	4	5/8 x 6-1/2	2	5/8	16	47
6	309-6	6	11.50	12.50	10.50	6	5/8 x 6-1/2	2	3/4	18	65
8	309-8	8	11.50	13.00	10.50	6	5/8 x 6-1/2	2	3/4	18	102
10	309-10	10	12.00	13.00	11.00	8	5/8 x 6-1/2	2	7/8	18	125
12	309-12	12	12.00	13.00	11.00	8	5/8 x 6-1/2	2	7/8	18	150
14	309-14	14	13.00	14.50	11.50	8	5/8 x 6-1/2	4	1	24	175
16	309-16	16	13.00	14.50	11.50	10	5/8 x 6-1/2	4	1	24	212
18	309-18	18	13.50	15.00	12.00	10	5/8 x 6-1/2	6	1-1/8	24	250
20	309-20	20	13.50	15.00	12.00	12	5/8 x 6-1/2	6	1-1/8	24	380
24	309-24	24	14.75	16.50	13.00	14	5/8 x 6-1/2	6	1-1/4	28	425
30	309-30	30	14.75	16.50	13.00	16	5/8 x 6-1/2	6	1-1/4	24	590

Sizes 14" and larger incorporate a strap restraint configuration. Other sizes available upon request.

Other flanges available upon request.

309 Dismantling Joints are priced on application. Contact JCM Sales Team.

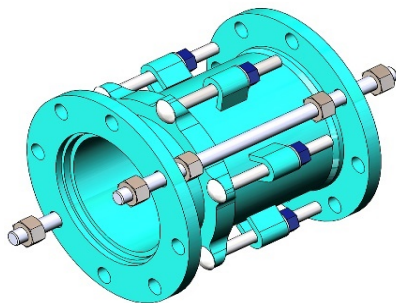

**309 Dismantling Joints** simplify installations and replacement of flanged fittings in retrofitting applications. JCM 309 Dismantling Joints provide the solution for adding, repairing or replacing flanged fittings within a flanged pipe system. Adjustable, slip joint design accommodates either wide gaps or close quarter installations and eliminates the need for precise measurements between flange connections. Restraint system standard.

Available in sizes 3" and larger, for ductile iron or flanged steel pipe systems.

Standard flanges ANSI/AWWA C207 Class D Flange with 150 lb. drilling. Other flanges available upon request.

Dismantling joints do not provide for lateral pipe movement.

309 Dismantling Joints rated for 150PSI. Higher pressure ratings available, contact JCM Industries.

### Material Specifications

**Flanged Adapter Body:** ASTM A36 or Ductile Iron ASTM A536.

**Follower Flange:** AISI C1012, ASME SA36, or Ductile Iron ASTM A536.

**Flange Extension:** Schedule 40 Steel Pipe

**Bolts:** Corrosion resistant, high strength low alloy ASTM A242, A193 B5, B7. Optional A193 B8 304 stainless steel or 316 stainless steel.

**Finish:** Heavy coat of corrosion resistant metal primer. Optional Fusion Applied Epoxy Coating per ANSI/AWWA C213 available. Other coatings available.

**Gasket:** Nitrile - Specially compounded new rubber polymer for superior shelf life and resistance to permanent set. Recommended for water, salt solutions, mild acids, bases.

**Standard Flange:** ASME/ANSI B16.1 Class 125 Compatible Steel Ring Flange

JCM 300 Series fittings are ANSI/NSF Standard 61, Annex G and ANSI/NSF Standard 372 Certified. JCM 300 Series fittings meet ANSI/AWWA Standard C219 as applicable.



## JCM 362 Fabricated Stainless Steel Flanged Coupling Adapter

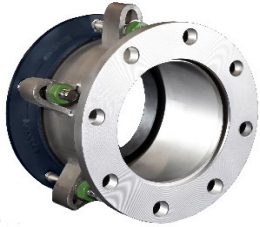

The JCM 362 Fabricated Stainless Steel Flanged Adapter provides an economical solution to joining two plain end pieces of pipe. Constructed of Carbon Steel End Ring with resilient Fusion Plastic Coating, a 304 Stainless Steel middle ring, flange and hardware. The JCM 362 is prepared for the harshest of elements or corrosive line content - or both!

**For American Iron and Steel (AIS) Compliance, contact JCM Sales Team for price and availability.**

Nom Pipe Size	From OD Range (IN)	To Flange (IN)	Catalog Number	No of Bolts	Bolt Size (IN)	List Price	Appr Wt Ea (LBS)
4	4.50	4	362-0450	4	5/8	P.O.A.	20
4	4.80 - 5.10	4	362-0480	4	5/8	P.O.A.	20
6	6.63	6	362-0663	5	5/8	P.O.A.	26
6	6.90 - 7.20	6	362-0690	5	5/8	P.O.A.	26
8	8.63	8	362-0863	6	5/8	P.O.A.	36
8	9.05 - 9.40	8	362-0905	6	5/8	P.O.A.	36
10	10.75	10	362-1075	7	5/8	P.O.A.	47
10	11.10 - 11.40	10	362-1110	7	5/8	P.O.A.	47
12	12.75	12	362-1275	8	5/8	P.O.A.	56
12	13.20 - 13.50	12	362-1320	8	5/8	P.O.A.	56

## JCM 362 Oversized Fabricated Stainless Steel Flanged Adapters

The JCM 362 Oversized Fabricated Stainless Steel Flanged Adapters provides an economical solution for joining old cast iron, larger classes of asbestos cement and other types of oversized pipe. The 362 Oversized Fabricated Stainless Steel Flanged Adapter uses the popular and economical JCM G212 Transition Gasket System. Making transitions of the same nominal pipe size easy with just the change of gasket.

**For American Iron and Steel (AIS) Compliance, contact JCM Sales Team for price and availability.**

Nom. Pipe Size	From OD Range (IN)	To Flange (IN)	Catalog Number	No of Bolts	Bolt Size (IN)	List Price	Appr Wt Ea (LBS)
4	5.10 - 5.40	4	362-0535	4	5/8	P.O.A.	20
6	7.20 - 7.55	6	362-0740	5	5/8	P.O.A.	26
8	9.40 - 9.75	8	362-0960	6	5/8	P.O.A.	36
10	11.60 - 12.05	10	362-1200	7	5/8	P.O.A.	47
12	13.92 - 14.40	12	362-1420	8	5/8	P.O.A.	56

Note: Applications in which pipe may move out of the coupling, proper anchorage of the pipe must be provided.

Custom sizes & lengths available upon request. Contact JCM Industries, Inc.

Purchase orders for the JCM Industries, Inc 362 type FCA coupling signify an agreement between the manufacturer and customer that both parties agree to the JCM test procedure for meeting ANSI/AWWA C219 Standard for Bolted, Sleeve-Type Couplings for Plain-End Pipe. All couplings are pneumatically tested to a minimum of 25 PSI. Additional testing for certification purposes available upon request with additional charge.

**For All 304 Stainless Steel FCA - order Catalog Number Model 4362**

**For All 316 Stainless Steel FCA - order Catalog Number Model 6362**



**JCM 4362 All 304 Stainless Steel FCA  
JCM 6362 All 316 Stainless Steel FCA**

## JCM 250 Fabricated Mechanical Joint Coupling

Available American Iron and Steel Compliant



Fabricated mechanical joint coupling available to meet the American Iron and Steel (EPA - AIS) domestic materials/construction requirements. This coupling can be manufactured to fit the requirements of the application, the pipe diameters and elevated pressure ratings. Fabricated of Carbon Steel (optional Stainless Steel), the JCM 250 MJ Coupling is the solution to the domestic coupling need. Sizes 4" and 24". Larger sizes available upon request.

### **Fabricated Construction Ensures:**

True Mechanical Joint Design  
Available for Exotic & Non-Standard Diameters  
4" - 24" Rated for 250 PSI Working Pressure  
Custom lengths  
Custom diameters  
American Iron and Steel Compliant - upon request

### **Material Specifications:**

**Body:** ASTM A36 Steel, ASTM A285 Grade C Steel or equal.  
Optional stainless steel available.

**Pusher Glands:** ASTM A36 Steel or ASTM A536 Ductile Iron.  
Optional stainless steel available.

**Bolts:** Corrosion resistant, high strength low alloy A242, ANSI/AWWA C111/A21.11.  
Optional stainless steel available.

**Gasket:** Nitrile rubber compounded for use with water, salt solutions, mild acids and bases.

**Finish:** Heavy coat of corrosion resistant shop coat primer.  
Optional fusion epoxy coating per ANSI/AWWA C213.

### **For Quotation and How to Order**

The following information must be furnished.

- Type of Pipe
- Pipe Outside Diameter
- Length Requirements
- Line Content
- Line Pressure
- Finish or Coating Requirements

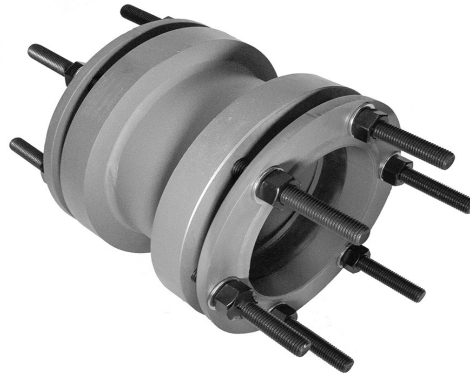

JCM 250 Mechanical Joint Couplings are Priced on Application.

For quotation, contact the JCM Inside Sales Team at 1-800-527-8482 or 1-903-832-2581.

## JCM 400 Series Service Saddle Material Specifications

**Body:** Wrap around design of Ductile Iron, ASTM A-536 annealed to 60-40-18. Body has a gasket cavity, which provides internal as well as external gasket retention.

**Gasket:** Nitrile Butadiene Rubber (NBR, Buna-N) per ASTM D2000. Molded virgin rubber with a pressure activated hydromechanical design. Gasket is bonded into a cavity for internal and external retention. Gasket temperature range -40°F to 212°F (-40°C – 100°C) Gasket suitable for water, salt solutions, mild acids, bases, and sewage. Optional EPDM gasket available.

**Coating:** **401, 402, 403, 404, 407**

Casting is coated with shop primer coating

**405, 406, 407, 408**

Casting is coated with fusion bonded high density blue plastic, 12 mils minimum thickness, with a dielectric strength of over 12,000 volts. Water absorption less than .20% (less than nylon) prevents undercutting and blistering.

**Straps:** **401, 402, 407, 408**

Nominal sizes 2" through 12" have corrosion resistant, forged AISI C-1018 steel straps, zinc plated with dichromate seal. Nominal sizes 14" through 24" have two (2) 2-1/2" wide fabricated steel straps for additional stability and strength coated for corrosion resistance.

**403, 404, 405, 406**

Stainless steel, 18-8 Type 304, passivated for corrosion resistance. Nuts coated with Xylan antiseize compound to reduce friction and galling. Nominal Sizes 2" – 3" with 1/2" UNC roll thread, 1/2" stainless washers and heavy hex nuts, nominal sizes 4" and larger with 5/8" UNC roll thread, 5/8" stainless washers and heavy hex nuts. Optional 316 stainless steel available.

**Bolts, Nuts, Washers:** **403, 404, 405, 406**

Stainless steel, 18-8 Type 304, passivated for corrosion resistance. Nuts coated with Xylan antiseize compound to reduce friction and galling. Nominal Sizes 2" – 3" with 1/2" UNC roll thread, 1/2" stainless washers and heavy hex nuts, nominal sizes 4" and larger with 5/8" UNC roll thread, 5/8" stainless washers and heavy hex nuts. Optional 316 stainless steel available.

**Standards:** JCM 400 Series Service Saddles meet or exceed ANSI/AWWA C800 Standard for Underground Service Line Valve and Fittings.

JCM 400 Series Service Saddles are ANSI/NSF Standard 61, Annex G and ANSI/NSF 372 Certified

JCM Industries endorses observance of Uni-Bell Handbook of PVC Pipe/AWWA Manual M23 Design and Installation of PVC Pipe and endorses the recommendations they make for tapping PVC Pipe. Service Fittings are available to adhere to those recommendations.

**JCM 401 Single Strap Service Saddle with Electro Galvanized Strap**  
**JCM 403 Wide Body Service Saddle with Stainless Steel Strap**

Nom Pipe Size (IN)	Pipe OD Range (IN)	Appr Wt Each Lbs	Ctn Qty	JCM 401 Service Saddle			JCM 403 Service Saddle		
				Catalog Number x Tap Code	3/4" - 1" Price Each	1-1/4" 1-1/2" 2", 2-1/2" Price Each	Catalog Number x Tap Code	3/4" - 1" Price Each	1-1/4" 1-1/2" 2", 2-1/2" Price Each
2	2.35 - 2.63	2.5	12	401-0238 X --	\$ 35.70	N/A	403-0238 X --	\$ 66.20	N/A
2-1/2	2.70 - 3.13	3	12	401-0288 X --	37.80	N/A	403-0288 X --	66.20	N/A
3	3.25 - 3.50	3	12	401-0350 X --	39.70	N/A	403-0350 X --	68.00	N/A
3 - 4	3.80 - 4.13	3	12	N/A	N/A	N/A	403-0413 X --	71.20	N/A
4	4.25 - 4.50	4.5	10	401-0450 X --	43.70	\$ 65.50	403-0450 X --	71.20	\$ 93.90
4	4.50 - 4.80	4.5	10	401-0480 X --	47.60	65.50	403-0480 X --	71.20	93.90
4	4.74 - 5.45	4.5	10	401-0545 X --	47.60	69.30	403-0545 X --	74.00	97.90
6	6.50 - 6.63	4.5	10	401-0663 X --	51.30	74.40	403-0663 X --	87.40	101.30
6	6.63 - 6.90	4.5	10	401-0690 X --	54.90	80.50	403-0690 X --	90.90	102.10
6	6.84 - 7.60	4.5	10	401-0745 X --	54.90	80.50	403-0745 X --	90.90	102.10
8	8.50 - 8.63	5	10	401-0863 X --	63.10	88.50	403-0863 X --	94.90	121.50
8	8.63 - 9.05	5	10	401-0905 X --	64.80	104.30	403-0905 X --	97.00	123.50
8	8.99 - 9.79	5	10	401-0963 X --	64.80	104.30	403-0963 X --	97.00	123.50
10	10.60 - 10.75	5.5	6	401-1075 X --	78.60	123.50	403-1075 X --	115.10	158.30
10	10.75 - 11.10	5.5	6	401-1110 X --	78.60	123.50	403-1110 X --	115.10	158.30
10	11.10 - 11.40	5.5	6	401-1140 X --	78.60	123.50	403-1140 X --	115.10	158.30
10	11.00 - 12.25	5.5	6	401-1225 X --	78.60	123.50	403-1225 X --	115.10	158.30
12	12.60 - 12.75	6	6	401-1275 X --	86.30	127.70	403-1275 X --	128.20	179.20
12	12.75 - 13.20	6	6	401-1320 X --	86.30	127.70	403-1320 X --	128.20	179.20
12	12.75 - 13.50	6	6	401-1350 X --	86.30	127.70	403-1350 X --	128.20	179.20
12	13.10 - 14.38	6	4	401-1426 X --	86.30	127.70	403-1426 X --	128.20	179.20

Outlet Sizes	Tap Codes IP	Tap Codes CC
1/2"	4	--
3/4"	6	7
1"	8	9
1-1/4"	10	11
1-1/2"	12	13
2"	14	15
2-1/2"	16	--

2" CC Threaded Saddles are Non-Returnable Items



401



403



Body for outlets 1-1/4" & larger



**HOW TO ORDER**

- Determine O.D. of pipe, outlet size and thread type.
- Select desired saddle type and tap order code.
- Look under saddle listing to determine order number. Add tap code after base catalog number.  
**EXAMPLE:** For 6" C.I. Pipe with O.D. of 6.90 with 1" IP thread, order: 401-0745 x 08IP. For stainless steel strap, order: 403-0745 x 08IP.

**JCM 402 Double Strap Service Saddle with Electro Galvanized Strap**  
**JCM 404 Service Saddle with Double Stainless Steel Straps**

Nom Pipe Size (IN)	Pipe OD Range (IN)	Appr Wt Each Lbs	Ctn Qty	JCM 402 Service Saddle			JCM 404 Service Saddle		
				Catalog Number x Tap Code	3/4" - 1" Price Each	1-1/4" 1-1/2" 2", 2-1/2" Price Each	Catalog Number x Tap Code	3/4" - 1" Price Each	1-1/4" 1-1/2" 2", 2-1/2" Price Each
2	2.35 - 2.63	4	6	*402-0238 X --	\$ 50.30	N/A	*404-0238 X --	\$ 111.80	N/A
2-1/2	2.70 - 3.13	5	6	*402-0288 X --	54.70	N/A	*404-0288 X --	113.50	N/A
3	3.25 - 3.50	7	6	**402-0350 X --	59.00	\$ 80.50	**404-0350 X --	121.10	\$ 138.30
3 - 4	3.80 - 4.13	7	6	**402-0413 X --	64.80	84.30	**404-0413 X --	122.70	144.40
4	4.25 - 4.50	10	4	402-0450 X --	64.80	84.30	404-0450 X --	122.70	144.40
4	4.50 - 4.80	10	4	402-0480 X --	71.40	91.30	404-0480 X --	123.50	147.10
4	4.74 - 5.45	10	4	402-0545 X --	71.40	91.30	404-0545 X --	123.50	147.10
5	5.50 - 5.56	10	4	N/A	N/A	N/A	404-0556 X --	139.50	155.50
6	6.50 - 6.63	10	4	402-0663 X --	74.80	95.20	404-0663 X --	138.10	155.50
6	6.63 - 6.90	10	4	402-0690 X --	85.00	106.30	404-0690 X --	138.80	157.20
6	6.84 - 7.60	10	4	402-0745 X --	85.00	106.30	404-0745 X --	138.80	157.20
8	8.50 - 8.63	12	4	402-0863 X --	87.30	113.80	404-0863 X --	173.70	195.40
8	8.63 - 9.05	13	4	402-0905 X --	93.50	117.40	404-0905 X --	177.00	195.40
8	8.99 - 9.79	13	4	402-0963 X --	93.50	117.40	404-0963 X --	177.00	195.40
10	10.60 - 10.75	14	3	402-1075 X --	124.70	152.00	404-1075 X --	202.00	228.70
10	10.75 - 11.10	14	3	402-1110 X --	124.70	152.00	404-1110 X --	202.00	228.70
10	11.10 - 11.40	14	3	402-1140 X --	124.70	152.00	404-1140 X --	202.00	228.70
10	11.00 - 12.25	14	3	402-1225 X --	124.70	152.00	404-1225 X --	202.00	228.70
12	12.60 - 12.75+	16	3	N/A	N/A	N/A	404-1275 X --	236.40	259.50
12	12.75 - 13.20	16	3	402-1320 X --	145.20	185.20	404-1320 X --	236.40	259.50
12	12.75 - 13.50	16	3	402-1350 X --	145.20	185.20	404-1350 X --	236.40	259.50
12	13.10 - 14.38	16	2	402-1426 X --	145.20	185.20	404-1426 X --	236.40	285.30
12 - 14	14.00 - 15.20	15	1	402-1520 X --	197.40	237.40	404-1520 X --	282.70	318.30
14	C-905 15.30	15	1	402-1530 X --	209.00	254.40	404-1530 X --	315.60	318.30
14 - 16	15.20 - 16.60	15	1	402-1660 X --	209.00	254.40	404-1660 X --	315.60	323.40
16	C-905 17.40	16	1	402-1740 X --	227.00	281.80	404-1740 X --	320.70	323.40
16 - 18	17.30 - 18.88	16	1	402-1888 X --	227.00	281.80	404-1888 X --	320.70	425.20
18	C-905 19.50	18	1	402-1950 X --	272.90	313.60	404-1950 X --	419.50	425.20
18 - 20	19.00 - 20.50	18	1	402-2050 X --	272.90	313.60	404-2050 X --	419.50	425.20
18 - 20	20.50 - 21.50	18	1	402-2125 X --	272.90	313.60	404-2125 X --	419.50	438.70
20	C-905 21.60	20	1	402-2160 X --	286.80	334.30	404-2160 X --	433.00	438.70
20	21.35 - 22.60	20	1	402-2260 X --	286.80	334.30	404-2260 X --	433.00	438.70
20	22.50 - 23.70	20	1	402-2370 X --	286.80	334.30	404-2370 X --	433.00	496.90
24	23.75 - 25.25	20	1	402-2525 X --	301.40	348.10	404-2525 X --	492.00	496.90
24	C-905 25.80	20	1	402-2580 X --	301.40	348.10	404-2580 X --	492.00	496.90
24	25.50 - 26.50	20	1	402-2650 X --	301.40	348.10	404-2650 X --	492.00	496.90

Outlet Sizes	Tap Codes IP	Tap Codes CC
1/2"	4	--
3/4"	6	7
1"	8	9
1-1/4"	10	11
1-1/2"	12	13
2"	14	15
2-1/2"	16	--



Certified to NSF/ANSI/CAN 61 & NSF/ANSI 372



402



404



Body Outlets 1-1/4" - 2-1/2"

\*Outlets Not available in 1-1/4", 1-1/2", 2" or 2-1/2"

\*\*Outlets Not available in 2" CC or 2-1/2" IP

+ For HDPE IPS Pipe

2" CC Threaded Saddles are Non-Returnable Items



**JCM 405 Single Strap Service Saddle with Stainless Steel Strap**  
**JCM 407 Wide Body Service Saddle with Electro Galvanized Strap**

Nom Pipe Size (IN)	Pipe OD Range (IN)	Appr Wt Each Lbs	Ctn Qty	JCM 405 Service Saddle			JCM 407 Service Saddle		
				Catalog Number x Tap Code	3/4" - 1" Price Each	1-1/4" 1-1/2" 2", 2-1/2" Price Each	Catalog Number x Tap Code	3/4" - 1" Price Each	1-1/4" 1-1/2" 2", 2-1/2" Price Each
2	2.35 - 2.63	2.5	12	405-0238 X --	\$ 80.00	N/A	407-0238 X --	\$ 48.30	N/A
2-1/2	2.70 - 3.13	3	12	405-0288 X --	81.30	N/A	407-0288 X --	50.40	N/A
3	3.25 - 3.50	3	12	405-0350 X --	81.30	N/A	407-0350 X --	53.00	N/A
3 - 4	3.80 - 4.13	3	12	405-0413 X --	83.10	N/A	N/A	N/A	N/A
4	4.25 - 4.50	4.5	10	405-0450 X --	83.10	\$ 100.50	407-0450 X --	\$ 56.30	\$ 76.40
4	4.50 - 4.80	4.5	10	405-0480 X --	83.40	100.50	407-0480 X --	60.00	76.40
4	4.74 - 5.45	4.5	10	405-0545 X --	83.40	106.60	407-0545 X --	60.00	80.50
6	6.50 - 6.63	4.5	10	405-0663 X --	93.80	112.40	407-0663 X --	63.20	86.40
6	6.63 - 6.90	4.5	10	405-0690 X --	94.70	113.90	407-0690 X --	66.80	91.90
6	6.84 - 7.60	4.5	10	405-0745 X --	94.70	113.90	407-0745 X --	66.80	91.90
8	8.50 - 8.63	5	10	405-0863 X --	110.30	131.10	407-0863 X --	76.00	100.30
8	8.63 - 9.05	5	10	405-0905 X --	112.90	133.40	407-0905 X --	79.40	115.50
8	8.99 - 9.79	5	10	405-0963 X --	112.90	133.40	407-0963 X --	79.40	115.50
10	10.60 - 10.75	5.5	6	405-1075 X --	124.10	156.60	407-1075 X --	95.70	139.30
10	10.75 - 11.10	5.5	6	405-1110 X --	124.10	156.60	407-1110 X --	95.70	139.30
10	11.10 - 11.40	5.5	6	405-1140 X --	124.10	156.60	407-1140 X --	95.70	139.30
10	11.00 - 12.25	5.5	6	405-1225 X --	124.10	156.60	407-1225 X --	95.70	139.30
12	12.60 - 12.75	6	6	405-1275 X --	142.90	182.60	407-1275 X --	102.20	142.00
12	12.75 - 13.20	6	6	405-1320 X --	142.90	182.60	407-1320 X --	102.20	142.00
12	12.75 - 13.50	6	6	405-1350 X --	142.90	182.60	407-1350 X --	102.20	142.00
12	13.10 - 14.38	6	4	405-1426 X --	142.90	182.60	407-1426 X --	102.20	142.00

Outlet Sizes	Tap Codes IP	Tap Codes CC
1/2"	4	--
3/4"	6	7
1"	8	9
1-1/4"	10	11
1-1/2"	12	13
2"	14	15
2-1/2"	16	--



**405**



**407**



2" CC Threaded Saddles are Non-Returnable Items

**HOW TO ORDER**

1. Determine O.D. of pipe, outlet size and thread type.
2. Select desired saddle type and tap order code.
3. Look under saddle listing to determine order number. Add tap code after base catalog number.  
**EXAMPLE:** For 6" C.I. Pipe with O.D. of 6.90 with 1" IP thread, order: 405-0745 x 08IP. For electro galvanized strap, order: 407-0745 x 08IP.

# JCM 406 Coated Saddle with Double Stainless Steel Straps

# JCM 408 Coated Saddle with Electro Galvanized Straps

Nom Pipe Size (IN)	Pipe OD Range (IN)	Appr Wt Each Lbs	Ctn Qty	JCM 406 Service Saddle			JCM 408 Service Saddle		
				Catalog Number x Tap Code	3/4" - 1" Price Each	1-1/4" 1-1/2" 2", 2-1/2" Price Each	Catalog Number x Tap Code	3/4" - 1" Price Each	1-1/4" 1-1/2" 2", 2-1/2" Price Each
2	2.35 - 2.63	4	6	*406-0238 X --	\$ 138.80	N/A	*408-0238 X --	\$ 62.50	N/A
2-1/2	2.70 - 3.13	5	6	*406-0288 X --	142.70	N/A	*408-0288 X --	66.30	N/A
3	3.25 - 3.50	7	6	**406-0350 X --	142.70	\$ 161.30	**408-0350 X --	70.80	92.10
3 - 4	3.80 - 4.13	7	6	**406-0413 X --	144.00	169.90	**408-0413 X --	76.30	95.20
4	4.25 - 4.50	10	4	406-0450 X --	144.00	169.90	408-0450 X --	76.30	95.20
4	4.50 - 4.80	10	4	406-0480 X --	144.00	169.90	408-0480 X --	83.40	102.40
4	4.74 - 5.45	10	4	406-0545 X --	144.00	169.90	408-0545 X --	83.40	102.40
5	5.50 - 5.56	10	4	406-0556 X --	164.90	195.50	N/A	N/A	N/A
6	6.50 - 6.63	10	4	406-0663 X --	164.90	193.60	408-0663 X --	87.70	107.50
6	6.63 - 6.90	10	4	406-0690 X --	164.90	193.60	408-0690 X --	98.10	118.60
6	6.84 - 7.60	10	4	406-0745 X --	164.90	193.60	408-0745 X --	98.10	118.60
8	8.50 - 8.63	12	4	406-0863 X --	195.30	220.40	408-0863 X --	100.10	118.60
8	8.63 - 9.05	13	4	406-0905 X --	195.30	227.50	408-0905 X --	106.30	129.40
8	8.99 - 9.79	13	4	406-0963 X --	195.30	227.50	408-0963 X --	106.30	129.40
10	10.60 - 10.75	14	3	406-1075 X --	230.20	260.30	408-1075 X --	147.10	173.40
10	10.75 - 11.10	14	3	406-1110 X --	230.20	260.30	408-1110 X --	147.10	173.40
10	11.10 - 11.40	14	3	406-1140 X --	230.20	260.30	408-1140 X --	147.10	173.40
10	11.00 - 12.25	14	3	406-1225 X --	230.20	260.30	408-1225 X --	147.10	173.40
12	12.60 - 12.75+	16	3	406-1275 x --	265.50	298.30	N/A	N/A	N/A
12	12.75 - 13.20	16	3	406-1320 X --	265.50	298.30	408-1320 X --	167.50	205.60
12	12.75 - 13.50	16	3	406-1350 X --	265.50	298.30	408-1350 X --	167.50	205.60
12	13.10 - 14.38	16	2	406-1426 X --	265.50	298.30	408-1426 X --	167.50	205.60
12 - 14	14.00 - 15.20	15	1	406-1520 X --	316.00	352.10	408-1520 X --	233.30	271.70
14	C-905 15.30	15	1	406-1530 X --	330.60	373.90	408-1530 X --	244.10	288.10
14 - 16	15.20 - 16.60	15	1	406-1660 X --	330.60	373.90	408-1660 X --	244.10	288.10
16	C-905 17.40	16	1	406-1740 X --	358.70	390.50	408-1740 X --	261.50	314.80
16 - 18	17.30 - 18.88	16	1	406-1888 X --	358.70	390.50	408-1888 X --	261.50	314.80
18	C-905 19.50	18	1	406-1950 X --	459.40	489.10	408-1950 X --	306.10	346.00
18 - 20	19.00 - 20.50	18	1	406-2050 X --	459.40	489.10	408-2050 X --	306.10	346.00
18 - 20	20.50 - 21.50	18	1	406-2125 X --	459.40	489.10	408-2125 X --	319.20	346.00
20	C-905 21.60	20	1	406-2160 X --	504.30	550.20	408-2160 X --	319.20	365.50
20	21.35 - 22.60	20	1	406-2260 X --	504.30	550.20	408-2260 X --	319.20	365.50
20	22.50 - 23.70	20	1	406-2370 X --	504.30	550.20	408-2370 X --	319.20	365.50
24	23.75 - 25.25	20	1	406-2525 X --	564.00	610.90	408-2525 X --	333.90	379.50
24	C-905 25.80	20	1	406-2580 X --	564.00	610.90	408-2580 X --	333.90	379.50
24	25.50 - 26.50	20	1	406-2650 X --	564.00	610.90	408-2650 X --	333.90	379.50

Outlet Sizes	Tap Codes IP	Tap Codes CC
1/2"	4	--
3/4"	6	7
1"	8	9
1-1/4"	10	11
1-1/2"	12	13
2"	14	15
2-1/2"	16	--

2" CC Threaded Saddles are Non-Returnable Items



406

\*Outlets Not available in 1-1/4", 1-1/2", 2" or 2-1/2"  
 \*\*Outlets Not available in 2" CC or 2-1/2" IP  
 + For HDPE IPS Pipe



408

## JCM 502 Stainless Steel Service Saddle - 304 Stainless Steel

Nom Pipe Size (IN)	Pipe OD Range (IN)	Saddle Width	Catalog Number x Tap Code	Outlets 3/4" & 1" Price Each	Outlets 1-1/4" - 2" Price Each	Appr Wt Each Lbs
2	2.38	8	502-0238 x --	\$ 185.20	N/A	5
2-1/2	2.63 - 2.88	8	502-0288 x --	185.20	N/A	5
3	3.13 - 3.50	8	502-0350 x --	205.50	N/A	5.5
3 - 4	3.80 - 4.13	8	502-0413 x --	206.60	N/A	5.5
4	4.50 - 4.80	8	*502-0480 x --	216.20	\$ 260.10	7
	4.80 - 5.20		502-0500 x --	216.20	260.10	
6	6.63 - 6.90	8	502-0690 x --	226.90	269.70	7
	6.90 - 7.30		502-0710 x --	226.90	269.70	
8	8.63 - 9.05	8	502-0905 x --	232.20	277.20	10
	9.05 - 9.45		502-0940 x --	232.20	277.20	
10	10.75 - 11.10	8	502-1110 x --	255.80	299.60	10
	11.70 - 12.10		502-1175 x --	255.80	299.60	
12	12.75 - 13.20	8	502-1320 x --	261.10	303.90	17
	14.00 - 14.40		502-1400 x --	261.10	303.90	

OUTLET SIZE	TAP CODES	TAP CODES
	IP	CC
3/4"	6	7
1"	8	9
1-1/4"	10	11
1-1/2"	12	13
2"	14	15

Saddle Sizes	Outlets Available	IP/CC
0238 - 0413	3/4" - 1"	IP/CC
0480 - 1320	3/4" - 2"	IP/CC

2" CC Threaded Saddles are Non-Returnable Items

\*502-0480 - 2"CC OUTLET (15CC) NOT AVAILABLE

**502 Service Saddles are Non Returnable Items**



Custom ranges available.

Not available in 316 stainless steel.

Recommended for IPS PVC, C900 PVC, Ductile Iron, Cast Iron, Steel and other types of pipe.

Not recommended for High Density Polyethylene Pipe (HDPE).

## JCM 418 Fabricated Threaded Outlet Tapping Sleeve (IPS Outlet)

Nom Pipe Size (IN)	Pipe OD Range (IN)	Sleeve Number x Outlet Size	Outlet Sizes 3/4" thru 2-1/2" Price Each	Outlet Sizes 3" & 4" Price Each	Appr Wt Each Lbs
2*	2.38	**418-0238 X --	P.O.A.	N/A	12
2*	2.50	**418-0250 X --	P.O.A.	N/A	12
3	3.50	418-0350 X --	P.O.A.	P.O.A.	25
3	3.96	418-0396 X --	P.O.A.	P.O.A.	25
4	4.50	418-0450 X --	\$ 469.00	\$ 674.00	25
4	4.80	418-0480 X --	469.00	674.00	25
6	6.63	418-0663 X --	485.00	686.00	30
6	6.90	418-0690 X --	485.00	686.00	30
8	8.63	418-0863 X --	626.00	708.00	40
8	9.05	418-0905 X --	626.00	708.00	40
10	10.75	418-1075 X --	648.00	837.00	58
10	11.10	418-1110 X --	648.00	837.00	58
12	12.75	418-1275 X --	676.00	855.00	60
12	13.20	418-1320 X --	676.00	855.00	60
14	14.59 - 15.08	418-1475 X --	701.00	883.00	64
14	15.23 - 15.80	418-1530 X --	701.00	883.00	67
14	16.30 - 16.73	418-1650 X --	701.00	883.00	67
16	17.33 - 17.87	418-1740 X --	720.00	903.00	68
16	18.62 - 19.19	418-1875 X --	720.00	903.00	68
18	19.41 - 20.01	418-1950 X --	758.00	947.00	72
18	20.93 - 21.57	418-2130 X --	758.00	947.00	77
20	21.51 - 22.15	418-2160 X --	797.00	963.00	80
20	23.46 - 24.16	418-2400 X --	797.00	963.00	87
24	25.71 - 26.41	418-2580 X --	828.00	993.00	95
24	28.14 - 28.84	418-2834 X --	828.00	993.00	104
30	31.52 - 32.22	418-3200 X --	899.00	1,073.00	151
36	38.10 - 38.75	418-3830 X --	1,079.00	1,217.00	165
42	44.10 - 44.70	418-4450 X --	1,123.00	1,261.00	180
48	50.40 - 51.00	418-5080 X --	1,233.00	1,370.00	229
54	56.60 - 57.25	418-5710 X --	1,385.00	1,526.00	260

\*2" Steel & Cast Iron Pipe Only

\*\*Outlets available 3/4" - 1-1/2" IP/CC, 2" IP

Outlet Sizes	Tap Codes IP	Tap Codes CC
3/4"	6	7
1"	8	9
1-1/4"	10	11
1-1/2"	12	13
2"	14	15
2-1/2"	16	N/A
3	17	N/A
4	18	N/A



Other sizes available upon request

Available Options (additional charge)

Epoxy Coating

Stainless Steel Hardware

CC threaded outlet - additional charge, contact JCM for pricing.

CC threaded outlet not available American Iron & Steel Compliant

2" CC threaded outlet sleeves are Non Returnable Items



Certified to  
NSF/ANSI/CAN 61  
& NSF/ANSI 372

### JCM 438 All Stainless Fabricated Threaded Outlet Tapping Sleeve (IPS Outlet)

Nom Pipe Size (IN)	Pipe OD Range (IN)	Sleeve Number x Outlet Size	Outlet Sizes 3/4" thru 2-1/2" List Price Each	Outlet Sizes 3" & 4" List Price Each	Appr Wt Each Lbs
3	3.50	438-0350 X --	P.O.A.	P.O.A.	25
3	3.96	438-0396 X --	P.O.A.	P.O.A.	25
4	4.50	438-0450 X --	\$ 990.00	\$ 1,148.00	25
4	4.80	438-0480 X --	990.00	1,148.00	25
6	6.63	438-0663 X --	1,074.00	1,227.00	27
6	6.90	438-0690 X --	1,074.00	1,227.00	27
8	8.63	438-0863 X --	1,128.00	1,286.00	40
8	9.05	438-0905 X --	1,128.00	1,286.00	40
10	10.75	438-1075 X --	1,189.00	1,398.00	41
10	11.10	438-1110 X --	1,189.00	1,398.00	41
12	12.75	438-1275 X --	1,259.00	1,464.00	42
12	13.20	438-1320 X --	1,259.00	1,464.00	42
14	14.59 - 15.08	438-1475 X --	1,478.00	1,689.00	54
14	15.23 - 15.80	438-1530 X --	1,478.00	1,689.00	57
14	16.30 - 16.73	438-1650 X --	1,478.00	1,689.00	60
16	17.33 - 17.87	438-1740 X --	1,543.00	1,751.00	64
16	18.62 - 19.19	438-1875 X --	1,543.00	1,751.00	68
18	19.41 - 20.01	438-1950 X --	1,607.00	1,821.00	72
18	20.93 - 21.57	438-2130 X --	1,607.00	1,821.00	77
20	21.51 - 22.15	438-2160 X --	1,681.00	1,895.00	80
20	23.46 - 24.16	438-2400 X --	1,681.00	1,895.00	87
24	25.71 - 26.41	438-2580 X --	1,821.00	2,027.00	95
24	28.14 - 28.84	438-2834 X --	1,821.00	2,027.00	104
30	31.52 - 32.22	438-3200 X --	1,973.00	2,184.00	115
36	38.10 - 38.75	438-3830 X --	2,175.00	2,389.00	139
42	44.10 - 44.70	438-4450 X --	2,357.00	2,568.00	160
48	50.40 - 51.00	438-5080 X --	3,010.00	3,219.00	225
54	56.60 - 57.25	438-5710 X --	3,242.00	3,454.00	285

\*\*Outlets available 3/4" - 1-1/2" IP/CC, 2" IP

Outlet Sizes	Tap Codes IP	Tap Codes CC
3/4"	6	7
1"	8	9
1-1/4"	10	11
1-1/2"	12	13
2"	14	15
2-1/2"	16	N/A
3	17	N/A
4	18	N/A



Other sizes available upon request

Available in all 316 Stainless Steel - Model Number 6438, contact JCM for pricing

Available Options (additional charge)

CC threaded outlet - additional charge, contact JCM for pricing.

CC threaded outlet not available American Iron & Steel Compliant

2" CC threaded outlet sleeves are Non Returnable Items



Certified to NSF/ANSI CAN 61 & NSF/ANSI 372

## JCM 425 Service Saddle for Concrete Steel Cylinder Pipe & Large Diameter Pipe

Nom Pipe Size (IN)	Concrete OD Range (IN)	Steel Cylinder OD* (IN)	Catalog Number x Tap Code	List Price Each	Appr Wt Each Lbs
16	19.25 - 20.15	17.25 - 20.15	425-2015 X --	\$ 628.00	100
18	21.75 - 22.75	19.50 - 22.75	425-2275 X --	707.00	100
20	23.64 - 24.65	21.70 - 24.65	425-2465 X --	721.00	100
24	27.62 - 29.15	25.75 - 29.15	425-2915 X --	746.00	115
30	33.88 - 35.75	31.88 - 35.75	425-3575 X --	1,004.00	115
36	39.75 - 41.00	37.75 - 41.00	425-4100 X --	1,097.00	138
36	41.50 - 43.00	40.50 - 43.00	425-4300 X --	1,097.00	138
42	45.75 - 47.25	43.75 - 47.25	425-4725 X --	1,156.00	140
42	48.00 - 49.50	46.00 - 49.50	425-4950 X --	1,156.00	140
48	51.50 - 53.00	49.50 - 53.00	425-5300 X --	1,331.00	145
48	55.38 - 56.50	53.40 - 56.50	425-5650 X --	1,331.00	145

Outlet Sizes	Tap Codes IP	Tap Codes CC
3/4"	6	7
1"	8	9
1-1/4"	10	11
1-1/2"	12	13
2"	14	15
2-1/2"	16	--

2" CC Threaded Saddles are Non-Returnable Items

\* Longer bolts are required for making taps on pipe with less than 1/4" coating



425 for Standard CSCP



425 for Embedded CSCP



Service Saddle for 3/4" through 2" Taps and Connections on Concrete Steel Cylinder Pipe, Reinforced Concrete Pipe, Large Diameter Cast Iron and Ductile Iron.

The JCM 425 Service Saddle is specifically designed for making safe, dependable taps into Concrete Steel Cylinder Pipe, Concrete Coated Steel Pipe and large diameter Ductile Iron Pipe. The threaded outlet, available in sizes 3/4" through 2" IP or CC, provides critical reinforcement to branch connections for service lines. These saddles can also be used to install air and vacuum valves, pitot tubes, injection lines and other equipment.

The following are important features and benefits this saddle offers:

**Provides critical reinforcement of pipe prior to removal of the prestress wire from the outlet area.** This is a required feature to maintain pipe integrity on larger taps and many small taps. The separate bolt-in outlet makes possible this essential installation step.

**Adjustable outlet** accommodates variation in concrete coating from no coating to a thickness of 1-1/8". Special outlets are available for embedded cylinder pipe and thicker coatings of concrete.

**High and low pressure performance** are assured by a broad, pressure-activated gasket. Permanently set in a retaining cavity, the contoured gasket produces a positive initial seal which increases with increases in line pressure.

### Grout Diapers for Service Saddles

These diapers make the recommended grouting of the service saddle a very quick procedure. Diapers are 11" wide with two 5/8" straps and are constructed of one layer of Tytar backed by a 6 mil ply of polyethylene film. Order by pipe size.

Order No.	Saddle Size	List Price Each
89106	16" - 24"	\$ 70.60
89107	30" - 36"	\$ 93.00
89108	42" - 48"	\$ 127.30

## JCM 412 Fabricated Steel Tapping Sleeves

Built in range assures proper fit on more than one class of pipe - reducing inventory requirements and the chance of not having the right size sleeve.

Ease of assembly eliminates extra equipment, time and specially trained personnel.

Ready availability means taps can be made without long delays - even taps on special sizes of pipe - or services requiring high pressure flanges.

Direct reinforcement of the pipe by the sleeve eliminates flexing or deflection of pipe opposite the tap. Less weight than heavy cast iron sleeves reduces the load on the pipe.

Most important, JCM Fabricated Tapping Sleeves assure a safe dependable tap. A large gasket cross section provides a positive initial seal which increases with increases in line pressure.



### Material Specifications

**Body:** Carbon Steel per ASTM A36, A516 GR 70 or equal.

**Flange:** Per ANSI/AWWA Standard C207 Class D, ANSI 150 lb. Drilling, recessed for tapping valve per MSS-SP60. Optional flanges available upon request.

**Bolts:** Sleeve sizes 7.45 and smaller = 5/8", sleeve sizes 9.05 and larger = 3/4"  
Electro Coated Powercron 590-534, high strength low alloy oval neck track head bolts per ASTM A242 and nuts (per ASTM A563) or equal.  
Optional Stainless Steel Type 304 or Stainless Steel Type 316

**Gasket:** Nitrile Butadiene Rubber (NBR, Buna-N) per ASTM D2000. Molded virgin rubber with a pressure activated hydromechanical design. Gasket is bonded into a cavity for internal and external retention. Gasket temperature range -40°F to 212°F (-40°C - 100°C) Gasket suitable for water, salt solutions, mild acids, bases, and sewage. Optional gasket materials available. Contact JCM Industries, Inc.

#### Service

**Rating:** 2" to 12" Outlets: 175 PSI. Higher service rating available for specific applications and sizes. Higher test and working pressure ratings available upon request, contact JCM Industries.

**Finish:** Heavy coat of corrosion resistant shop coat primer. Optional fusion applied epoxy coating, minimum 12 mils thickness per ANSI/AWWA Standard C213 Fusion Bonded Epoxy Coatings and Linings for Steel Water Pipe and Fittings.

JCM 400 Series Tapping Sleeves are ANSI/NSF Standard 61, Annex G & ANSI/NSF 372 Certified.  
JCM 400 Series Tapping Sleeves meet MSS-SP124 and ANSI/AWWA Standard C223 Fabricated Steel and Stainless Steel Tapping Sleeves.

## JCM 412 Fabricated Tapping Sleeve - Carbon Steel

Nom Pipe Size (IN)	Pipe OD Range (IN)	Sleeve Number	X	Outlet Sizes	Shopcoat Alloy Bolts List Price Ea	Epoxy Coat Alloy Bolts List Price Ea	Epoxy Coat 304 SS Bolts List Price Ea	Appr Wt Each Lbs
6.63 (SEE 422)								
6**	6.83 - 7.16	412-0690	X	3	\$ 809.00	\$ 934.00	\$ 1,129.00	50
	7.05 - 7.40	412-0720		4	809.00	934.00	1,129.00	55
	7.40 - 7.73	412-0745		6	905.00	1,059.00	1,234.00	63
8.63 (SEE 422)								
8	8.98 - 9.37	412-0905	X	3	881.00	950.00	1,154.00	83
	9.27 - 9.69	412-0940		4	881.00	950.00	1,154.00	85
		6		930.00	1,085.00	1,237.00	88	
10	9.83 - 10.25	*412-1000	X	8	1,180.00	1,356.00	1,589.00	125
	10.64 - 10.86	412-1075		3	919.00	1,010.00	1,202.00	90
	11.03 - 11.47	412-1110		4	919.00	1,010.00	1,202.00	108
	11.36 - 11.80	412-1140		6	982.00	1,109.00	1,294.00	120
	11.76 - 12.24	412-1200		8	1,224.00	1,434.00	1,622.00	135
12	12.62 - 12.88	412-1275	X	10	1,618.00	1,849.00	2,091.00	173
				3	939.00	1,085.00	1,267.00	98
				4	939.00	1,085.00	1,267.00	111
				6	1,023.00	1,188.00	1,382.00	146
	13.60 - 14.09	412-1392	8	1,302.00	1,533.00	1,747.00	155	
14.08 - 14.56	412-1420	10	1,729.00	2,116.00	2,358.00	248		
14	14.59 - 15.08	412-1475	X	12	1,973.00	2,300.00	2,555.00	216
				3	984.00	1,158.00	1,307.00	113
				4	984.00	1,158.00	1,307.00	115
				6	1,085.00	1,259.00	1,435.00	146
	15.73 - 16.22	412-1600	8	1,385.00	1,633.00	1,830.00	155	
16.30 - 16.73	412-1650	10	1,824.00	2,233.00	2,393.00	190		
16	16.74 - 17.26	412-1684	X	12	2,072.00	2,418.00	2,654.00	250
				3	1,032.00	1,180.00	1,351.00	113
				4	1,032.00	1,180.00	1,351.00	115
				6	1,141.00	1,325.00	1,501.00	150
	17.88 - 18.43	412-1800	8	1,413.00	1,717.00	1,910.00	181	
18.62 - 19.19	412-1875	10	1,906.00	2,296.00	2,532.00	230		
18	18.87 - 19.45	412-1920	X	12	2,190.00	2,518.00	2,755.00	280
				3	1,059.00	1,217.00	1,377.00	120
				4	1,059.00	1,217.00	1,377.00	122
				6	1,190.00	1,363.00	1,517.00	137
	20.29 - 20.94	412-2050	8	1,524.00	1,724.00	1,947.00	180	
20.93 - 21.57	412-2130	10	1,967.00	2,369.00	2,602.00	221		
20	21.51 - 22.15	412-2160	X	12	2,238.00	2,595.00	2,808.00	245
				3	1,150.00	1,247.00	1,476.00	131
				4	1,150.00	1,247.00	1,476.00	150
				6	1,296.00	1,411.00	1,640.00	157
				8	1,657.00	1,837.00	2,098.00	208
	24.15 - 24.85	412-2450	10	2,132.00	2,454.00	2,701.00	245	
24.82 - 25.52	412-2502	12	2,352.00	2,635.00	3,022.00	310		
24	25.71 - 26.41	412-2580	X	3	1,209.00	1,420.00	1,585.00	160
				4	1,209.00	1,420.00	1,585.00	160
				6	1,367.00	1,593.00	1,763.00	180
				8	1,759.00	2,059.00	2,289.00	215
	27.26 - 27.96	412-2746	10	2,361.00	2,774.00	3,065.00	280	
28.14 - 28.84	412-2834	12	2,557.00	2,954.00	3,265.00	360		
30	29.78 - 30.48	412-3000	X	3	1,325.00	1,518.00	1,733.00	163
				4	1,325.00	1,518.00	1,733.00	165
				6	1,505.00	1,701.00	1,924.00	220
	31.52 - 32.22	412-3200	8	1,965.00	2,243.00	2,476.00	226	
*Range not available with size on size outlet.				10	2,502.00	3,036.00	3,351.00	295
**Sizes incorporate (8) - 5/8" bolts.				12	2,734.00	3,156.00	3,449.00	400

Size on size outlets require a 1/2" undersize shell cutter.

JCM 412 Tapping Sleeves furnished with test plugs unless otherwise specified.

Tapping Sleeves with outlets 3" and smaller are Non Returnable Items



## JCM 412 Large Diameter Fabricated Tapping Sleeve - Carbon Steel

Nom Pipe Size (IN)	Pipe OD Range (IN)	Sleeve Number	X	Outlet Size	Shopcoat Alloy Bolts	Epoxy Coat Alloy Bolts	Epoxy Coat 304 SS Bolts	Appr Wt Each Lbs	
36	35.75 - 36.25	412-3600	X	3	P.O.A.	P.O.A.	P.O.A.	322	
				4	P.O.A.	P.O.A.	P.O.A.	326	
	38.05 - 38.55	412-3830		6	P.O.A.	P.O.A.	P.O.A.	342	
				8	P.O.A.	P.O.A.	P.O.A.	354	
					10	P.O.A.	P.O.A.	P.O.A.	445
					12	P.O.A.	P.O.A.	P.O.A.	561
42	41.75 - 42.25	412-4200	X	3	P.O.A.	P.O.A.	P.O.A.	390	
				4	P.O.A.	P.O.A.	P.O.A.	390	
	44.25 - 44.75	412-4450		6	P.O.A.	P.O.A.	P.O.A.	450	
				8	P.O.A.	P.O.A.	P.O.A.	475	
					10	P.O.A.	P.O.A.	P.O.A.	520
					12	P.O.A.	P.O.A.	P.O.A.	630
48	47.75 - 48.25	412-4800	X	3	P.O.A.	P.O.A.	P.O.A.	412	
				4	P.O.A.	P.O.A.	P.O.A.	412	
	50.55 - 51.05	412-5080		6	P.O.A.	P.O.A.	P.O.A.	465	
				8	P.O.A.	P.O.A.	P.O.A.	500	
					10	P.O.A.	P.O.A.	P.O.A.	540
					12	P.O.A.	P.O.A.	P.O.A.	690
54	53.75 - 54.25	412-5400	X	3	P.O.A.	P.O.A.	P.O.A.	425	
				4	P.O.A.	P.O.A.	P.O.A.	425	
	56.25 - 56.75	412-5650		6	P.O.A.	P.O.A.	P.O.A.	490	
				8	P.O.A.	P.O.A.	P.O.A.	530	
	56.85 - 57.35	412-5710		10	P.O.A.	P.O.A.	P.O.A.	560	
				12	P.O.A.	P.O.A.	P.O.A.	731	

### Larger Pipe and Outlet Sizes Available

JCM 412 Tapping Sleeves furnished with test plugs unless otherwise specified.



### JCM 412 Fabricated Steel Tapping Sleeves

Built-in benefits make these heavy fabricated steel sleeves increasingly popular for making larger taps on all types of pipe. By placing the design emphasis on eliminating problems inherent with older pipe and field installations, JCM Fabricated Tapping Sleeves have taken the complexity out of tapping larger pipe.

**JCM 411 Fabricated Tapping Sleeve with Plain Outlet** - built with the same robust design and materials as the 412 - with a plain outlet that can be provided butt cut or beveled for welding. Contact JCM for details.

**JCM 413 Fabricated Tapping Cross** - designed for double outlets 180° across. Contact JCM for details.



## JCM 419 Fabricated Tapping Sleeve - Carbon Steel



### Material Specifications

**Body:** Carbon Steel per ASTM A36, A516 GR 70 or equal.

**Outlet:** Carbon Steel meets ANSI 21.11/AWWA C111 Standard Dimensions  
Outlets 3" & 4" = 1/4" test outlet, outlets 6" and larger = 3/4" test outlet

**Bolts:** Sleeve sizes 7.45 and smaller = 5/8", sleeve sizes 9.05 and larger = 3/4"

Electro Coated Powercron 590-534, high strength low alloy oval neck track head bolts per ASTM A242 and nuts (per ASTM A563) or equal.

Optional Stainless Steel Type 304 or Stainless Steel Type 316

**Gasket:** Nitrile Butadiene Rubber (NBR, Buna-N) per ASTM D2000. Molded virgin rubber with a pressure activated hydromechanical design. Gasket is bonded into a cavity for internal and external retention. Gasket temperature range -40°F to 212°F (-40°C - 100°C) Gasket suitable for water, salt solutions, mild acids, bases, and sewage. Optional gasket materials available. Contact JCM Industries, Inc.

### Service

**Rating:** 4" – 12"\* pipe sizes: 250 PSI working pressure, hydrostatic test pressure of 300 PSI  
\*12 x 12 w/Stainless Bolts: 200 PSI working pressure, hydrostatic test pressure of 250 PSI  
14" – 24" pipe sizes: 200 PSI working pressure, hydrostatic test pressure of 250 PSI

**Finish:** Heavy coat of corrosion resistant shop coat primer. Optional fusion applied epoxy coating, minimum 12 mils thickness per ANSI/AWWA Standard C213 Fusion Bonded Epoxy Coatings and Linings for Steel Water Pipe and Fittings.

JCM 400 Series Tapping Sleeves are ANSI/NSF Standard 61, Annex G & ANSI/NSF 372 Certified.  
JCM 400 Series Tapping Sleeves meet MSS-SP124 and ANSI/AWWA Standard C223 Fabricated Steel and Stainless Steel Tapping Sleeves.



## JCM 419 Fabricated Tapping Sleeve - Carbon Steel

Nom Pipe Size (IN)	Pipe OD Range (IN)	Sleeve Number	X	Outlet Sizes Available	Shopcoat Alloy Bolts List Price Ea	Epoxy Coat Alloy Bolts List Price Ea	Epoxy Coat 304 SS Bolts List Price Ea	Appr Wt Each Lbs
6.63 (SEE 429)								
6**	6.83 - 7.16	419-0690	X	3	\$ 899.00	\$ 1,022.00	\$ 1,224.00	73
	7.05 - 7.40	419-0720		4	899.00	1,022.00	1,224.00	76
	7.40 - 7.73	419-0745		6	1,066.00	1,222.00	1,399.00	82
8.63 (SEE 429)								
8	8.98 - 9.37	419-0905	X	3	967.00	1,043.00	1,249.00	83
	9.27 - 9.69	419-0940		4	967.00	1,043.00	1,249.00	85
		6		1,090.00	1,250.00	1,408.00	97	
10	9.83 - 10.25	*419-1000	X	8	1,429.00	1,605.00	1,841.00	127
	10.64 - 10.86	419-1075		3	1,008.00	1,104.00	1,296.00	90
	11.03 - 11.47	419-1110		4	1,008.00	1,104.00	1,296.00	92
	11.36 - 11.80	419-1140		6	1,142.00	1,266.00	1,462.00	96
	11.76 - 12.24	419-1140		8	1,476.00	1,688.00	1,875.00	125
		419-1200		10	1,898.00	2,128.00	2,379.00	168
12	12.62 - 12.88	419-1275	X	3	1,029.00	1,177.00	1,362.00	97
	13.13 - 13.60	419-1320		4	1,029.00	1,177.00	1,362.00	100
	13.60 - 14.09	419-1392		6	1,188.00	1,353.00	1,548.00	104
	14.08 - 14.56	419-1420		8	1,553.00	1,785.00	2,006.00	140
		10		2,008.00	2,394.00	2,644.00	176	
	12	2,287.00		2,611.00	2,871.00	216		
14	14.59 - 15.08	419-1475	X	3	1,074.00	1,250.00	1,399.00	110
	15.23 - 15.80	419-1530		4	1,074.00	1,250.00	1,399.00	115
	15.73 - 16.22	419-1600		6	1,250.00	1,424.00	1,601.00	116
	16.30 - 16.73	419-1650		8	1,639.00	1,887.00	2,084.00	150
		10		2,102.00	2,511.00	2,682.00	190	
	12	2,383.00		2,729.00	2,973.00	220		
16	16.74 - 17.26	419-1684	X	3	1,123.00	1,270.00	1,443.00	110
	17.33 - 17.87	419-1740		4	1,123.00	1,270.00	1,443.00	115
	17.88 - 18.43	419-1800		6	1,305.00	1,487.00	1,670.00	157
	18.62 - 19.19	419-1875		8	1,660.00	1,967.00	2,167.00	162
		10		2,188.00	2,576.00	2,819.00	220	
12	2,501.00	2,833.00	3,071.00	230				
18	18.87 - 19.45	419-1920	X	3	1,149.00	1,309.00	1,472.00	120
	19.41 - 20.01	419-1950		4	1,149.00	1,309.00	1,472.00	122
	20.00 - 20.60	419-2000		6	1,355.00	1,528.00	1,685.00	126
	20.29 - 20.94	419-2050		8	1,772.00	1,975.00	2,205.00	180
	20.93 - 21.57	419-2130		10	2,243.00	2,651.00	2,888.00	240
12	2,550.00	2,907.00	3,130.00	245				
20	21.51 - 22.15	419-2160	X	3	1,242.00	1,337.00	1,569.00	130
	22.16 - 22.81	419-2254		4	1,242.00	1,337.00	1,569.00	133
	22.78 - 23.45	419-2294		6	1,457.00	1,570.00	1,807.00	140
	23.46 - 24.16	419-2400		8	1,907.00	2,087.00	2,358.00	185
	24.15 - 24.85	419-2450		10	2,413.00	2,731.00	2,986.00	245
	24.82 - 25.52	419-2502		12	2,661.00	2,946.00	3,340.00	255
24	25.71 - 26.41	419-2580	X	3	1,302.00	1,511.00	1,674.00	140
	26.55 - 27.25	419-2715		4	1,302.00	1,511.00	1,674.00	143
	27.26 - 27.96	419-2746		6	1,531.00	1,753.00	1,931.00	160
	28.14 - 28.84	419-2834		8	2,008.00	2,308.00	2,547.00	215
		10		2,643.00	3,051.00	3,354.00	280	
12	2,871.00	3,268.00	3,586.00	312				
30	29.78 - 30.48	419-3000	X	3	1,416.00	1,610.00	1,830.00	160
	30.48 - 31.18	419-3075		4	1,416.00	1,610.00	1,830.00	165
	31.52 - 32.22	419-3200		6	1,669.00	1,866.00	2,094.00	175
		8		2,211.00	2,495.00	2,707.00	226	
10	2,780.00	3,316.00	3,637.00	295				
12	3,045.00	3,468.00	3,767.00	310				

\*Range not available with size on size outlet.

\*\*Sizes incorporate (8) - 5/8" bolts.

Size on size outlets require a 1/2" undersize shell cutter.

JCM 419 Tapping Sleeves furnished with test plugs unless otherwise specified.

Tapping Sleeves with outlets 3" and smaller are Non Returnable Items



## 419 Large Diameter Fabricated Tapping Sleeve - Carbon Steel

Nom Pipe Size (IN)	Pipe OD Range (IN)	Sleeve Number	X	Outlet Sizes Available	Shopcoat Alloy Bolts List Price Ea	Epoxy Coat Alloy Bolts List Price Ea	Epoxy Coat 304 SS Bolts List Price Ea
36	35.75 - 36.25	419-3600	X	3	P.O.A.	P.O.A.	P.O.A.
				4	P.O.A.	P.O.A.	P.O.A.
	38.05 - 38.55	419-3830		6	P.O.A.	P.O.A.	P.O.A.
				8	P.O.A.	P.O.A.	P.O.A.
				10	P.O.A.	P.O.A.	P.O.A.
				12	P.O.A.	P.O.A.	P.O.A.
42	41.75 - 42.25	419-4200	X	3	P.O.A.	P.O.A.	P.O.A.
				4	P.O.A.	P.O.A.	P.O.A.
	44.25 - 44.75	419-4450		6	P.O.A.	P.O.A.	P.O.A.
				8	P.O.A.	P.O.A.	P.O.A.
				10	P.O.A.	P.O.A.	P.O.A.
				12	P.O.A.	P.O.A.	P.O.A.
48	47.75 - 48.25	419-4800	X	3	P.O.A.	P.O.A.	P.O.A.
				4	P.O.A.	P.O.A.	P.O.A.
	50.55 - 51.05	419-5080		6	P.O.A.	P.O.A.	P.O.A.
				8	P.O.A.	P.O.A.	P.O.A.
				10	P.O.A.	P.O.A.	P.O.A.
				12	P.O.A.	P.O.A.	P.O.A.
54	53.75 - 54.25	419-5400	X	3	P.O.A.	P.O.A.	P.O.A.
				4	P.O.A.	P.O.A.	P.O.A.
	56.25 - 56.75	419-5650		6	P.O.A.	P.O.A.	P.O.A.
				8	P.O.A.	P.O.A.	P.O.A.
	56.85 - 57.35	419-5710		10	P.O.A.	P.O.A.	P.O.A.
				12	P.O.A.	P.O.A.	P.O.A.
<b>Larger Pipe and Outlet Sizes Available</b>				10	P.O.A.	P.O.A.	P.O.A.
				12	P.O.A.	P.O.A.	P.O.A.



419 Shopcoat



419 Epoxy Coat



Certified to  
NSF/ANSI/CAN 61  
& NSF/ANSI 372

**JCM 459 Stainless Steel Tapping Sleeve - Stainless MJ - Outlet Seal Gasket**  
**JCM 465 Stainless Tapping Sleeve - Carbon MJ - Outlet Seal Gasket**



**JCM 459 All Stainless Steel Tapping Sleeve with Stainless Steel MJ Outlet**

**JCM 465 Stainless Steel Tapping Sleeve with Carbon Steel MJ Outlet**

**Material Specifications**

**Body:** Stainless Steel 18-8 Type 304.

**Bolts:** Stainless Steel 18-8 Type 304.  
Sleeve sizes 14.20 and smaller = 5/8", sizes 14.75 and larger = 3/4"

**459 Outlet:** CF8 Cast Stainless Steel - equivalent to 18-8 Type 304 Stainless Steel meets ANSI 21.11/AWWA C111 Standard Dimensions  
Outlets 3" & 4" furnished with 1/4" test outlet  
Outlets 6" and larger furnished with 3/4" test outlet

**465 Outlet:** Carbon Steel Mechanical Joint Outlet shall meet the ANSI 21.11/AWWA C111 Standard for Mechanical Joint Dimensions. Outlet shall be furnished with load bearing alignment set pins to prevent movement of the tapping assembly before or during the tapping process. Coated for corrosion resistance.

**Branch**

**Outlet:** Schedule 10 Stainless Steel Pipe Type 304

**Gasket:** Nitrile Butadiene Rubber (NBR, Buna-N) per ASTM D2000. Molded virgin rubber with a pressure activated hydro mechanical design. Gasket is bonded into a cavity for internal and external retention. Gasket temperature range -40°F to 212°F (-40°C - 100°C) Gasket suitable for water, salt solutions, mild acids, bases, and sewage.

**Service**

**Rating:** 4" – 12"\* pipe sizes: 250 PSI working pressure, hydrostatic test pressure of 300 PSI  
\*12 x12 size and 14" – 24" pipe sizes: 200 PSI working pressure, hydrostatic test pressure of 250 PSI

JCM 400 Series Tapping Sleeves are ANSI/NSF Standard 61, Annex G & ANSI/NSF Standard 372 Certified.

JCM 400 Series Tapping Sleeves meet MSS-SP124 and ANSI/AWWA Standard C223 Fabricated Steel and Stainless Steel Tapping Sleeves.



**JCM 459 Stainless Steel Tapping Sleeve - Stainless MJ - Outlet Seal Gasket**

**JCM 465 Stainless Tapping Sleeve - Carbon MJ - Outlet Seal Gasket**

Nom Pipe Size (IN)	Pipe OD Range (IN)	Sleeve Number	X	Outlet Sizes Available	459 Stainless Outlet List Price Each	465 Carbon Outlet List Price Each	Appr Wt Each Lbs
4	4.50	0450	X	3	\$ 1,508.00	\$ 1,386.00	29
	4.80	0480		4	1,508.00	1,386.00	32
6**	6.63	0663	X	3	1,597.00	1,386.00	50
	6.83 - 7.16	0690		4	1,597.00	1,386.00	53
	7.05 - 7.40	0720		6	1,861.00	1,555.00	55
	7.40 - 7.73	0745					
8	8.63	0863	X	3	1,723.00	1,479.00	52
	8.98 - 9.37	0905		4	1,723.00	1,479.00	54
	9.27 - 9.69	0940		6	2,062.00	1,634.00	60
10	9.83 - 10.25	*1000	X	8	2,650.00	2,015.00	118
	10.64 - 10.86	1075		3	1,958.00	1,629.00	89
	11.03 - 11.47	1110		4	1,958.00	1,629.00	92
	11.36 - 11.80	1140		6	2,192.00	1,751.00	96
	11.76 - 12.24	1200		8	2,739.00	2,154.00	125
				10	3,834.00	3,075.00	168
12	12.62 - 12.88	1275	X	3	2,037.00	1,650.00	90
	13.13 - 13.60	1320		4	2,037.00	1,650.00	94
	13.60 - 14.09	1392		6	2,343.00	1,829.00	98
	14.08 - 14.56	1420		8	2,922.00	2,250.00	112
				10	4,044.00	3,162.00	135
14	1475	1530	X	12	5,793.00	4,035.00	156
				3	P.O.A.	P.O.A.	110
				4	P.O.A.	P.O.A.	115
				6	P.O.A.	P.O.A.	116
				8	P.O.A.	P.O.A.	150
				10	P.O.A.	P.O.A.	190
16	16.74 - 17.26	1684	X	12	P.O.A.	P.O.A.	220
	17.33 - 17.87	1740		3	P.O.A.	P.O.A.	110
	17.88 - 18.43	1800		4	P.O.A.	P.O.A.	115
	18.62 - 19.19	1875		6	P.O.A.	P.O.A.	120
				8	P.O.A.	P.O.A.	162
10	P.O.A.	P.O.A.	210				
18	18.87 - 19.45	1920	X	12	P.O.A.	P.O.A.	230
	19.41 - 20.01	1950		3	P.O.A.	P.O.A.	118
	20.00 - 20.60	2000		4	P.O.A.	P.O.A.	122
	20.29 - 20.94	2050		6	P.O.A.	P.O.A.	126
	20.93 - 21.57	2130		8	P.O.A.	P.O.A.	180
20	2160	2254	X	10	P.O.A.	P.O.A.	240
				12	P.O.A.	P.O.A.	245
				3	P.O.A.	P.O.A.	127
				4	P.O.A.	P.O.A.	133
				6	P.O.A.	P.O.A.	140
				8	P.O.A.	P.O.A.	185
24	24.15 - 24.85	2450	X	10	P.O.A.	P.O.A.	245
	24.82 - 25.52	2502		12	P.O.A.	P.O.A.	255
	25.71 - 26.41	2580		3	P.O.A.	P.O.A.	136
	26.55 - 27.25	2715		4	P.O.A.	P.O.A.	143
	27.26 - 27.96	2746		6	P.O.A.	P.O.A.	160
30	3000	3075	X	8	P.O.A.	P.O.A.	215
				10	P.O.A.	P.O.A.	280
				12	P.O.A.	P.O.A.	312
				3	P.O.A.	P.O.A.	152
				4	P.O.A.	P.O.A.	165
30	3048 - 31.18	3200	X	6	P.O.A.	P.O.A.	175
				8	P.O.A.	P.O.A.	226
				10	P.O.A.	P.O.A.	295
				12	P.O.A.	P.O.A.	310

\*Range not available with size on size outlet.

\*\*Sizes incorporate (8) - 5/8" bolts.

Size on size outlets require a 1/2" undersize shell cutter.

JCM 459 464 Tapping Sleeves furnished with test plugs unless otherwise specified.

Tapping Sleeves with outlets 3" and smaller are Non Returnable Items

**JCM 459 Stainless Steel Tapping Sleeve - Stainless MJ - Outlet Seal Gasket**  
**JCM 465 Stainless Tapping Sleeve - Carbon MJ - Outlet Seal Gasket**

Nom Pipe Size (IN)	Pipe OD Range (IN)	Sleeve Number	X	Outlet Sizes Available	459 Stainless Outlet List Price Each	465 Carbon Outlet List Price Each
				3	P.O.A.	P.O.A.
				4	P.O.A.	P.O.A.
36	35.75 - 36.25	3600	X	6	P.O.A.	P.O.A.
	38.05 - 38.55	3830		8	P.O.A.	P.O.A.
				10	P.O.A.	P.O.A.
				12	P.O.A.	P.O.A.
				3	P.O.A.	P.O.A.
				4	P.O.A.	P.O.A.
42	41.75 - 42.25	4200	X	6	P.O.A.	P.O.A.
	44.25 - 44.75	4450		8	P.O.A.	P.O.A.
				10	P.O.A.	P.O.A.
				12	P.O.A.	P.O.A.
				3	P.O.A.	P.O.A.
				4	P.O.A.	P.O.A.
48	47.75 - 48.25	4800	X	6	P.O.A.	P.O.A.
	50.55 - 51.05	5080		8	P.O.A.	P.O.A.
				10	P.O.A.	P.O.A.
				12	P.O.A.	P.O.A.
				3	P.O.A.	P.O.A.
54	53.75 - 54.25	5400	X	4	P.O.A.	P.O.A.
	56.25 - 56.75	5650		6	P.O.A.	P.O.A.
	56.85 - 57.35	5710		8	P.O.A.	P.O.A.
<b>Larger Pipe and Outlet Sizes Available</b>				10	P.O.A.	P.O.A.
				12	P.O.A.	P.O.A.



Certified to NSF/ANSI/CAN 61 & NSF/ANSI 372



**459**

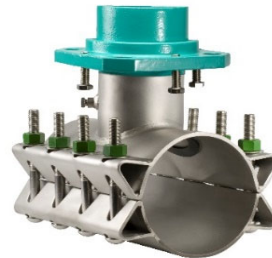

**465**

# 422 Tapping Sleeve for IPS PVC, IPS HDPE, Steel and C900, DIPS HDPE

## Material Specifications

### Body:

ASTM A36 Carbon Steel or equal.

### Bolts:

5/8" Corrosion resistant, high strength low alloy oval neck track head bolt per ASTM A242/ANSI/AWWA C111/A21.11 and heavy hex nut per A563 Electro-coated, Powercron 590-534.  
Optional: Stainless Steel 18-8 304 or 316 available.

### Flange:

AWWA C207 Class D, ANSI 150 lb. Drilling, recessed for tapping valve MSS-SP60.

### Gasket:

Nitrile Butadiene Rubber (NBR, Buna-N) per ASTM D2000. Molded virgin rubber with a pressure activated hydro mechanical design. Gasket is bonded into a cavity for internal and external retention. Gasket temp. range - 40°F to 180°F (-40°C - 82°C). Gasket suitable for water, salt solutions, mild acids, bases, and sewage.

### Finish:

Fusion bonded epoxy coating, minimum 12 mils thickness per ANSI/AWWA C213.

### Service Rating:

4" to 12" Outlets: 175 PSI. Higher service rating available for specific applications and sizes.

JCM 400 Series Tapping Sleeves are ANSI/NSF Standard 61, Annex G & ANSI/NSF 372 Certified.

JCM 400 Series Tapping Sleeves meet MSS-SP124 and ANSI/AWWA Standard C223 Fabricated Steel and Stainless Steel Tapping Sleeves.

Not recommended for cast iron or ductile iron pipe, for CIP/DIP see JCM 412 Fabricated Tapping Sleeve.

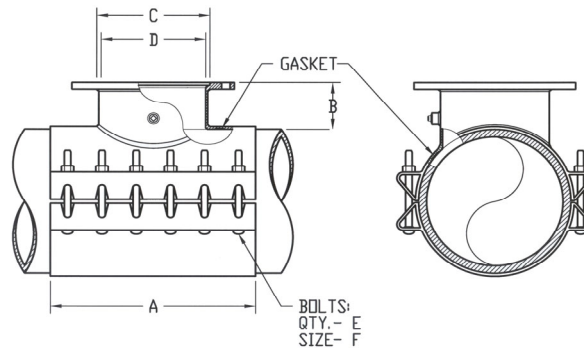

JCM 422 TAPPING SLEEVE DIMENSIONS						
Flange Size	A	B	C	D	E	F
3	9*	5	4-1/32	3-1/2	6	5/8
4	9*	5	5-1/32	4	6	5/8
6	12.00	5	7-1/32	6-1/8	8	5/8
8	15.00	5-1/8	9-1/32	8-1/8	10	5/8
10	21.00	5-1/2	11-1/16	10-1/4	14	5/8
12	24.00	5-3/4	13-1/16	12-1/4	16	5/8

NOTE: 422 Tapping Sleeves require a standard 1/2" undersize cutter

\*10" & 12" Nominal pipe sizes - dimension A is 12".





## 422 Tapping Sleeve for IPS PVC, IPS HDPE, Steel and C900, DIPS HDPE

Tapping Sleeves with outlets 3" and smaller are Non Returnable Items

	Nom Pipe Size (IN)	Pipe OD Range (IN)	Sleeve Number	X	Outlet Sizes Available	Ecoat Alloy Bolts List Price	304 SS Bolts List Price	Appr Wt Each Lbs	
<b>2" STEEL &amp; CAST IRON ONLY</b>	2	2.38	422-0238	X	2	P.O.A.	P.O.A.	12	
		2.50	422-0250	X	2	P.O.A.	P.O.A.	12	
<b>PVC PIPE IPS Size SDR 26, 21 Sch 40 Class 200, Class 160 IPS HDPE Steel Pipe</b>	3	3.50	422-0350	X	3	P.O.A.	P.O.A.	18	
	4	4.50	422-0450	X	3	\$ 759.00	\$ 927.00	33	
					4	759.00	927.00	35	
	5	5.56	422-0556	X	3	883.00	1,087.00	32	
					4	883.00	1,087.00	35	
	6	6.63	422-0663	X	3	784.00	983.00	38	
					4	784.00	983.00	40	
					6	884.00	1,108.00	60	
	8	8.63	422-0863	X	3	821.00	1,007.00	43	
					4	821.00	1,007.00	45	
					6	908.00	1,124.00	56	
						8	1,146.00	1,416.00	71
	10	10.75	422-1075	X	3	839.00	1,119.00	90	
					4	839.00	1,119.00	92	
					6	914.00	1,210.00	96	
					8	1,155.00	1,517.00	125	
						10	1,508.00	1,974.00	134
						3	884.00	1,207.00	98
	12	12.75	422-1275	X	4	884.00	1,207.00	100	
					6	963.00	1,288.00	104	
8					1,228.00	1,641.00	140		
10					1,700.00	2,180.00	176		
					12	1,872.00	2,376.00	216	

### FOR C900 PVC, DIPS HDPE ONLY

<b>FOR C900 PVC, DI HDPE ONLY Not recommended for Cast Iron or Ductile Iron Pipe</b>	3	3.96	422-0396	X	3	P.O.A.	P.O.A.	20	
	4	4.80	422-0480	X	3	\$ 759.00	\$ 927.00	33	
					4	759.00	927.00	35	
	6	6.90	422-0690	X	3	784.00	983.00	38	
					4	784.00	983.00	40	
					6	884.00	1,108.00	60	
	8	9.05	422-0905	X	3	821.00	1,007.00	43	
					4	821.00	1,007.00	45	
					6	908.00	1,124.00	56	
						8	1,146.00	1,416.00	71
	10	11.10	422-1110	X	3	839.00	1,119.00	90	
					4	839.00	1,119.00	92	
					6	914.00	1,210.00	96	
					8	1,155.00	1,517.00	125	
						10	1,508.00	1,974.00	134
						3	884.00	1,207.00	98
	12	13.20	422-1320	X	4	884.00	1,207.00	100	
					6	963.00	1,288.00	104	
					8	1,228.00	1,641.00	140	
					10	1,700.00	2,180.00	176	
					12	1,872.00	2,376.00	216	

422 Tapping Sleeves furnish standard epoxy coated, electro coated bolts with test plugs.

422 Tapping Sleeve require 1/2" undersized cutter.



# 429 Tapping Sleeve for IPS PVC, IPS HDPE, Steel and C900, DIPS HDPE

## Material Specifications

### Body:

ASTM A36 Carbon Steel or equal.

### Bolts:

5/8" Corrosion resistant, high strength low alloy oval neck track head bolt per ASTM A242/ANSI/AWWA C111/A21.11 and heavy hex nut per A563 Electro-coated, Powercron 590-534.  
Optional: Stainless Steel 18-8 304 or 316 available.

### MJ Outlet:

Carbon Steel meets ANSI 21.11/AWWA C-111 Standard Dimensions.

### Gasket:

Nitrile Butadiene Rubber (NBR, Buna-N) per ASTM D2000. Molded virgin rubber with a pressure activated hydro mechanical design. Gasket is bonded into a cavity for internal and external retention. Gasket temp. range - 40°F to 180°F (-40°C - 82°C). Gasket suitable for water, salt solutions, mild acids, bases, and sewage.

### Finish:

Fusion bonded epoxy coating, minimum 12 mils thickness per ANSI/AWWA C213.

### Service Rating:

Sleeves 4" – 12"\* nominal pipe sizes: 250 PSI working pressure, hydrostatic test pressure of 300 PSI.

JCM 400 Series Tapping Sleeves are ANSI/NSF Standard 61, Annex G & ANSI/NSF 372 Certified.  
JCM 400 Series Tapping Sleeves meet MSS-SP124 and ANSI/AWWA Standard C223 Fabricated Steel and Stainless Steel Tapping Sleeves.

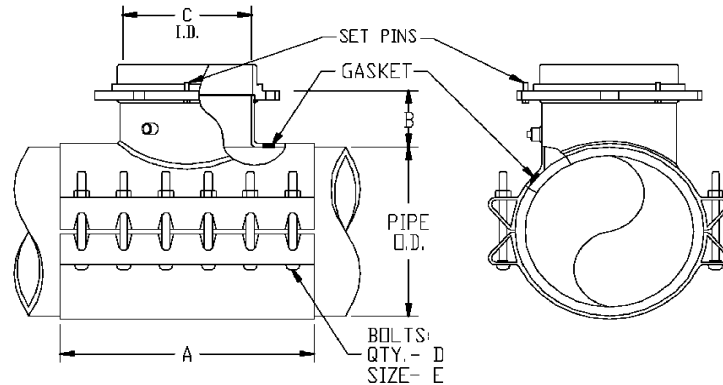

JCM 429 TAPPING SLEEVE DIMENSIONS					
Outlet Size	A	B	C	D	E
3	9*	5-1/16	3.32	6	5/8
4	9*	5-3/16	4.26	6	5/8
6	12.00	5-5/16	6.36	8	5/8
8	15.00	5-7/16	8.33	10	5/8
10	21.00	5-7/16	10.42	14	5/8
12	24.00	5-7/16	12.39	16	5/8

\*10" & 12" Nominal Pipe Sizes - dimension A = 12"



# JCM 429 MJ Outlet Tapping Sleeve for IPS PVC, IPS HDPE, Steel and C900, DIPS HDPE

Tapping Sleeves with outlets 3" and smaller are Non Returnable Items

	Nom Pipe Size (IN)	Pipe OD Range (IN)	Sleeve Number	X	Outlet Sizes Available	Ecoat Alloy Bolts List Price	304 SS Bolts List Price	Appr Wt Each Lbs
<b>PVC PIPE</b> IPS Size SDR 26, 21 Sch 40 Class 200, Class 160 IPS HDPE Steel Pipe	4	4.50	429-0450	X	3	\$ 844.00	\$ 1,020.00	29
					4	844.00	1,020.00	31
	5	5.56	429-0556	X	3	1,010.00	1,200.00	31
					4	1,010.00	1,200.00	33
	6	6.63	429-0663	X	3	862.00	1,079.00	32
					4	862.00	1,079.00	35
					6	1,035.00	1,271.00	44
	8	8.63	429-0863	X	3	907.00	1,097.00	35
					4	907.00	1,097.00	38
					6	1,056.00	1,288.00	49
					8	1,380.00	1,664.00	64
	10	10.75	429-1075	X	3	919.00	1,207.00	89
					4	919.00	1,207.00	92
					6	1,061.00	1,373.00	96
					8	1,387.00	1,767.00	125
					10	1,764.00	2,253.00	168
	12	12.75	429-1275	X	3	966.00	1,301.00	96
					4	966.00	1,301.00	100
					6	1,111.00	1,450.00	104
					8	1,458.00	1,889.00	140
10					1,952.00	2,459.00	176	
12					2,159.00	2,686.00	216	

## FOR C900 PVC, DIPS HDPE ONLY

<b>FOR C900 PVC, DI HDPE ONLY</b> Not recommended for Cast Iron or Ductile Iron Pipe	4	4.80	429-0480	X	3	\$ 844.00	\$ 1,020.00	29
					4	844.00	1,020.00	31
	6	6.90	429-0690	X	3	862.00	1,079.00	32
					4	862.00	1,079.00	35
					6	1,035.00	1,271.00	44
	8	9.05	429-0905	X	3	907.00	1,097.00	35
					4	907.00	1,097.00	38
					6	1,056.00	1,288.00	49
					8	1,380.00	1,664.00	64
	10	11.10	429-1110	X	3	919.00	1,207.00	89
					4	919.00	1,207.00	92
					6	1,061.00	1,373.00	96
					8	1,387.00	1,767.00	125
					10	1,764.00	2,253.00	168
	12	13.20	429-1320	X	3	966.00	1,301.00	96
					4	966.00	1,301.00	100
					6	1,111.00	1,450.00	104
					8	1,458.00	1,889.00	140
					10	1,952.00	2,459.00	176
					12	2,159.00	2,686.00	216

429 Tapping Sleeves furnish standard epoxy coated, electro coated bolts with test plugs.

429 Tapping Sleeve require 1/2" undersized cutter.



Certified by NSF/ANSI 41 & NSF/ANSI 372

**JCM 432 All Stainless Steel Tapping Sleeve**  
**JCM 462 Stainless Steel Tapping Sleeve - Carbon Steel Flange**  
**Full Circumferential Gasket**

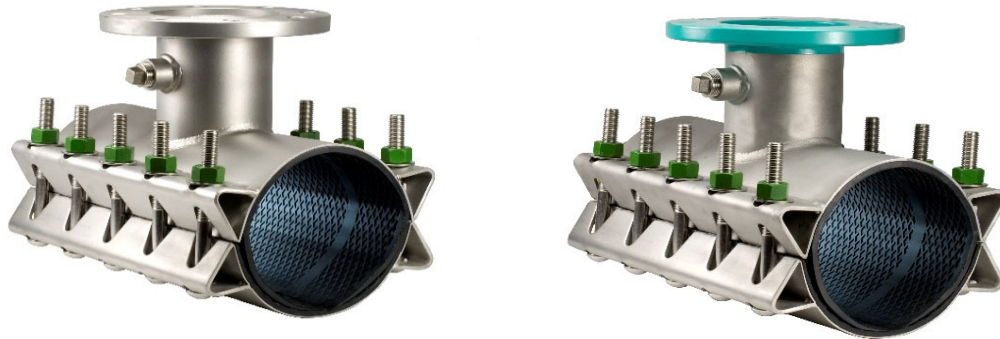

**JCM 432 All Stainless Steel Tapping Sleeve with Stainless Steel Flange**  
**JCM 462 Stainless Steel Tapping Sleeve with Carbon Steel Flange**  
**Material Specifications**

**Body:** Stainless Steel, 18-8 Type 304

**Bolts:** Stainless Steel, 18-8 Type 304

**Branch Outlet:** Schedule 10 Stainless Steel Pipe

**Gasket:** Full circumferential Virgin Styrene-Butadiene Rubber (SBR) - Compounded for use with water, salt solutions, mild acids and bases. Per ASTM D-2000 M4AA 607. Standard temperature range from -40° to 150°F (-40° to 65°C) constant, maximum intermittent 180° F (82°C). For applications on high temperatures or chemical pipelines, contact JCM Industries Technical Services.

**432 Flange Outlet:** 304 Stainless Steel, per ANSI/AWWA Standard C288, ANSI 150lb. Drilling, recessed for tapping valve per MSS-SP 60.

**462 Flange Outlet:** Carbon Steel per ANSI/AWWA C207 Class D, ANSI 150 lb. Drilling, recessed for tapping valve per MSS-SP60. Coated for corrosion resistance.

JCM 400 Series Tapping Sleeves are ANSI/NSF Standard 61, Annex G & ANSI/NSF 372 Certified. JCM 400 Series Tapping Sleeves meet MSS-SP124 and ANSI/AWWA Standard C223 Fabricated Steel and Stainless Steel Tapping Sleeves.

<b>JCM 432 &amp; 462 TAPPING SLEEVE DIMENSIONS</b>						
Outlet Size	A	B	C	D	E	F
2	15	4	3-1/32	2.16	10	5/8
3	15	5	4-1/32	3.26	10	5/8
4	15	5	5-1/32	4.26	10	5/8
6	15	5	7-1/32	6.35	10	5/8
8	21	5-18	9-1/32	8.32	14	5/8
10	27	5-1/2	11-1/16	10.42	18	5/8
12	30	5-3/4	13-1/16	12.39	20	5/8

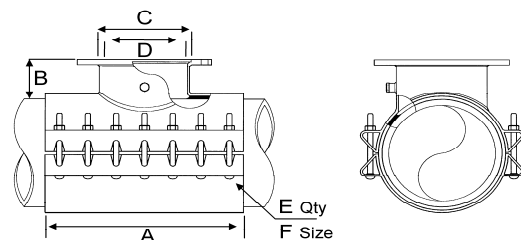

**JCM 432 All Stainless Steel Tapping Sleeve - Full Circumferential Gasket**

**JCM 462 Stainless Steel Tapping Sleeve/Carbon Steel Flange - Full Circumferential Gasket**

Nom Pipe Size (IN)	Pipe OD Range (IN)	Sleeve Number	X	Outlet Sizes Available	432 Stainless Flange List Price	462 Carbon Flange List Price	Sleeve Width	Number of Bolts	Appr Wt Each Lbs	
4	4.40 - 4.60	0450	X							
	4.50 - 4.80	0465		2	\$ 1,724.00	\$ 1,202.00	15	10	35	
	4.74 - 5.00	0480		3	1,724.00	1,202.00	15	10	38	
	5.10 - 5.30	0520		4	1,724.00	1,202.00	15	10	40	
6	6.56 - 6.90++	0663	X	2	1,741.00	1,247.00	15	10	42	
	6.83 - 7.16	0690		3	1,741.00	1,247.00	15	10	42	
	7.05 - 7.40	0720		4	1,741.00	1,247.00	15	10	47	
	7.40 - 7.73	0745		6	1,795.00	1,421.00	15	10	49	
8	8.54 - 8.74	0863	X	2	1,818.00	1,334.00	15	10	45	
	8.60 - 9.05++	0900		3	1,818.00	1,334.00	15	10	45	
	8.98 - 9.37	0905		4	1,818.00	1,334.00	15	10	51	
	9.27 - 9.69	0940		6	1,964.00	1,414.00	15	10	54	
				8	2,409.00	1,894.00	21	14	78	
10	9.83 - 10.25	1000+	X	2	2,074.00	1,463.00	15	10	46	
	10.64 - 10.86	1075+		3	2,074.00	1,463.00	15	10	46	
	10.75 - 11.15++	1100+		4	2,074.00	1,463.00	15	10	55	
	11.00 - 11.40	1110		6	2,246.00	1,576.00	15	10	60	
	11.36 - 11.80	1140		8	2,744.00	1,915.00	21	14	81	
	11.76 - 12.24	1200		10	4,010.00	3,271.00	27	18	138	
12	12.62 - 12.88	1275	X	2	2,343.00	1,632.00	15	10	47	
	12.75 - 13.20++	1300*		3	2,343.00	1,632.00	15	10	47	
	13.10 - 13.50	1320		4	2,343.00	1,632.00	15	10	60	
	13.70 - 14.09	1392		6	2,595.00	1,757.00	15	10	64	
	14.08 - 14.40	1420		8	3,255.00	2,635.00	21	14	105	
					10	4,137.00	3,410.00	27	18	150
14			X	12	4,588.00	3,699.00	30	20	160	
	15.20 - 15.60	1530		2	2,766.00	2,740.00	15	10	74	
	15.80 - 16.20	1600		3	2,766.00	2,740.00	15	10	74	
	16.38 - 16.78	1650		4	2,766.00	2,740.00	15	10	80	
					6	3,015.00	2,957.00	15	10	85
					8	3,624.00	3,531.00	21	14	144
16			X	10	4,592.00	4,520.00	27	18	162	
	17.40 - 17.80	1740		12	5,156.00	5,034.00	30	20	171	
	17.75 - 18.15	1800		2	3,314.00	2,740.00	15	10	78	
	18.58 - 18.98	1875		3	3,314.00	2,740.00	15	10	78	
					4	3,314.00	2,740.00	15	10	78
					6	3,749.00	2,957.00	15	10	90
18			X	8	4,076.00	3,531.00	21	14	130	
	19.30 - 19.70	1950		10	5,107.00	4,520.00	27	18	163	
	19.80 - 20.20	1990		12	5,591.00	5,034.00	30	20	193	
	21.20 - 21.40	2130		3	3,314.00	3,295.00	15	10	80	
20			X	4	3,314.00	3,295.00	15	10	80	
	21.40 - 21.80	2160		6	3,749.00	3,711.00	15	10	90	
	21.90 - 22.30	2206		8	4,352.00	4,273.00	21	14	130	
	22.30 - 22.70	2250		3	3,494.00	3,475.00	15	10	85	
24			X	4	3,494.00	3,475.00	15	10	85	
	23.45 - 23.85	2360		6	3,754.00	3,720.00	15	10	96	
	25.60 - 26.00	2580		8	4,399.00	4,317.00	21	14	136	
	26.20 - 26.60	2632		3	3,682.00	3,664.00	15	10	105	
				4	3,682.00	3,664.00	15	10	105	
				6	4,015.00	3,982.00	15	10	125	
				8	4,801.00	4,726.00	21	14	150	

(+) THIS SIZE NOT AVAILABLE WITH A SIZE ON SIZE OUTLET.

(++) RECOMMENDED FOR IPS PVC, STEEL, C-900 PVC, DUCTILE IRON PIPE DIAMETERS.

(++) NOT RECOMMENDED FOR OVERSIZED CAST IRON PIPE. FOR OVERSIZED CAST IRON SEE NEXT LARGER RANGE.

(\*) NOT AVAILABLE WITH 10" & 12" OUTLETS

For larger sizes and outlets, see JCM 412 Tapping Sleeve or JCM 452 All Stainless Steel Tapping Sleeve  
Tapping Sleeves with outlets 3" and smaller are Non Returnable Items

**JCM 439 All Stainless Steel Mechanical Joint Outlet Tapping Sleeve**  
**JCM 469 Stainless Steel with Carbon Steel MJ Outlet Tapping Sleeve**  
**Full Circumferential Gasket**

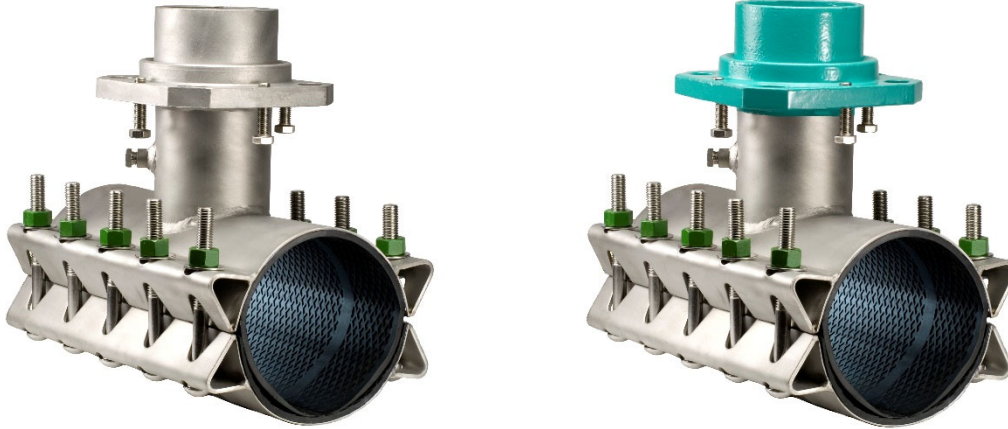

**JCM 439 All Stainless Steel Tapping Sleeve with Mechanical Joint Outlet**  
**JCM 469 Stainless Steel Tapping Sleeve with Carbon Steel Mechanical Joint Outlet**  
**Material Specifications**

**Body:** Stainless Steel, 18-8 Type 304

**Bolts:** Stainless Steel, 18-8 Type 304

**Branch Outlet:** Schedule 10 Stainless Steel Pipe

**Gasket:** Full circumferential Virgin Styrene-Butadiene Rubber (SBR) - Compounded for use with water, salt solutions, mild acids and bases. Per ASTM D-2000 M4AA 607. Standard temperature range from -40° to 150°F (-40° to 65°C) constant, maximum intermittent 180° F (82°C). For applications on high temperatures or chemical pipelines, contact JCM Industries Technical Services.

**439 MJ Outlet:** CF8 Cast Stainless Steel or 304 Stainless Steel, meets ANSI 21.11/AWWA C111 Standard for Mechanical Joint Dimensions

**469 MJ Outlet:** Carbon Steel meets ANSI 21.11/AWWA C111 Standard for Mechanical Joint Dimensions.  
 Carbon steel outlet coated for corrosion resistance.

JCM 400 Series Tapping Sleeves are ANSI/NSF Standard 61, Annex G & ANSI/NSF 372 Certified.  
 JCM 400 Series Tapping Sleeves meet MSS-SP124 and ANSI/AWWA Standard C223 Fabricated Steel and Stainless Steel Tapping Sleeves.

<b>JCM 439 &amp; 469 TAPPING SLEEVE DIMENSIONS</b>						
<b>Outlet Size</b>	<b>A</b>	<b>B</b>	<b>C</b>	<b>D</b>	<b>E</b>	<b>F</b>
3	15	5-1/16	3.32	10	5/8	3
4	15	5-3/16	4.26	10	5/8	4
6	15	5-5/16	6.36	10	5/8	6
8	21	5-7/16	8.33	14	5/8	8
10	27	5-7/16	10.42	18	5/8	10
12	30	5-7/16	12.39	20	5/8	12

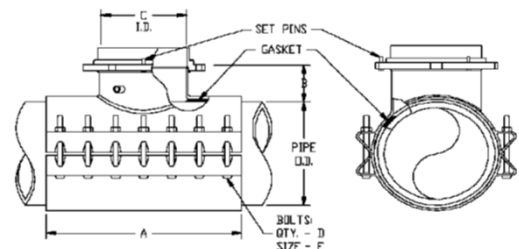

**JCM 439 All Stainless Steel MJ Outlet Tapping Sleeve - Full Circumferential Gasket**  
**JCM 469 Stainless Steel Tapping Sleeve/Carbon Steel MJ Outlet - Full Circumferential Gasket**

Nom Pipe Size (IN)	Pipe OD Range (IN)	Sleeve Number	X	Outlet Sizes Available	439 Stainless Steel List Price Each	469 Carbon Steel List Price Each	Sleeve Width	Number of Bolts	Appr Wt Each Lbs
4	4.40 - 4.60	0450	X						
	4.50 - 4.80	0465		3	\$ 1,878.00	\$ 1,659.00	15	10	38
	4.74 - 5.00	0480		4	1,878.00	1,659.00	15	10	40
	5.10 - 5.30	0520							
6	6.56 - 6.90++	0663	X	3	1,878.00	1,659.00	15	10	42
	6.83 - 7.16	0690		4	1,878.00	1,659.00	15	10	47
	7.05 - 7.40	0720		6	2,025.00	1,750.00	15	10	55
	7.40 - 7.73	0745							
8	8.54 - 8.74	0863	X	3	1,935.00	1,799.00	15	10	45
	8.60 - 9.05++	0900		4	1,935.00	1,799.00	15	10	51
	8.98 - 9.37	0905		6	2,174.00	1,886.00	15	10	66
	9.27 - 9.69	0940		8	3,017.00	2,235.00	21	14	107
10	9.83 - 10.25	1000+	X	3	2,213.00	2,083.00	15	10	46
	10.64 - 10.86	1075+		4	2,213.00	2,083.00	15	10	55
	10.75 - 11.15++	1100+		6	2,474.00	2,194.00	15	10	63
	11.00 - 11.40	1110		8	3,068.00	2,606.00	21	14	111
	11.36 - 11.80	1140		10	4,771.00	4,497.00	27	18	138
	11.76 - 12.24	1200							
12	12.62 - 12.88	1275	X	3	2,464.00	2,342.00	15	10	47
	12.75 - 13.20++	1300*		4	2,464.00	2,342.00	15	10	60
	13.10 - 13.50	1320		6	2,802.00	2,529.00	15	10	70
	13.70 - 14.09	1392		8	3,552.00	3,105.00	21	14	120
	14.08 - 14.40	1420		10	4,499.00	4,059.00	27	18	144
				12	4,854.00	4,497.00	30	20	161
14	15.20 - 15.60	1530	X	3	2,884.00	2,794.00	15	10	74
	15.80 - 16.20	1600		4	2,884.00	2,794.00	15	10	80
	16.38 - 16.78	1650		6	3,225.00	3,097.00	15	10	85
				8	3,922.00	3,763.00	21	14	144
				10	4,951.00	4,769.00	27	18	162
				12	5,425.00	5,312.00	30	20	175
16	17.40 - 17.80	1740	X	3	3,429.00	3,343.00	15	10	78
	17.75 - 18.15	1800		4	3,429.00	3,343.00	15	10	78
	18.58 - 18.98	1875		6	3,962.00	3,834.00	15	10	109
				8	4,378.00	4,214.00	21	14	126
				10	5,468.00	5,282.00	27	18	163
				12	5,858.00	5,677.00	30	20	193
18	19.30 - 19.70	1950	X	3	3,429.00	3,343.00	15	10	80
	19.80 - 20.20	1990		4	3,429.00	3,343.00	15	10	80
	21.20 - 21.40	2130		6	3,962.00	3,834.00	15	10	90
				8	4,653.00	4,487.00	21	14	130
20	21.40 - 21.80	2160	X	3	3,615.00	3,520.00	15	10	85
	21.90 - 22.30	2206		4	3,615.00	3,520.00	15	10	85
	22.30 - 22.70	2250		6	3,964.00	3,841.00	15	10	92
				8	4,700.00	4,532.00	21	14	136
24	23.45 - 23.85	2360	X	3	3,801.00	3,705.00	15	10	105
	25.60 - 26.00	2580		4	3,801.00	3,705.00	15	10	105
	26.20 - 26.60	2632		6	4,227.00	4,100.00	15	10	125
				8	5,099.00	4,933.00	21	14	180

(+) THIS SIZE NOT AVAILABLE WITH A SIZE ON SIZE OUTLET.

(++) RECOMMENDED FOR IPS PVC, STEEL, C-900 PVC, DUCTILE IRON PIPE DIAMETERS.

(++) NOT RECOMMENDED FOR OVERSIZED CAST IRON PIPE. FOR OVERSIZED CAST IRON SEE NEXT LARGER RANGE.

(\*) NOT AVAILABLE WITH 10" & 12" OUTLETS

For larger sizes and outlets, see JCM 419 Tapping Sleeve or JCM 459 All Stainless Steel Tapping Sleeve

Tapping sleeves with outlets 3" and smaller are Non Returnable Items

**452 Stainless Steel Tapping Sleeve - Stainless Flange - Outlet Seal Gasket**  
**464 Stainless Tapping Sleeve - Carbon Flange - Outlet Seal Gasket**



**452**



**464**

**JCM 452 All Stainless Steel Tapping Sleeve with Stainless Steel Flange**  
**JCM 464 Stainless Steel Tapping Sleeve with Carbon Steel Flange**  
**Material Specifications**

**Body:** Stainless Steel 18-8 Type 304.

**Bolts:** Stainless Steel 18-8 Type 304.  
 Sleeve sizes 14.20 and smaller = 5/8", sizes 14.75 and larger = 3/4"

**452 Flange:** 304 Stainless Steel or equivalent, per ANSI/AWWA C228 Class SD. Flange outlets shall be indexed per MSS-SP60 to accept tapping valve and have the equivalent O.D. and drilling as Class 125 Cast-Iron Flanges (ANSI/ASME B16.1) and Class 150 Steel-Ring Flanges (ANSI/ASME B16.5). Other flanges available upon request.

**464 Flange:** Flanged outlet shall be carbon steel per ANSI/AWWA C207 Class D, ANSI 150 lb. Drilling, recessed for tapping valve per MSS-SP60, coated for corrosion resistance. Other flanges available upon request.

**Branch**

**Outlet:** Schedule 10 Stainless Steel Pipe Type 304

**Gasket:** Nitrile Butadiene Rubber (NBR, Buna-N) per ASTM D2000. Molded virgin rubber with a pressure activated hydro mechanical design. Gasket is bonded into a cavity for internal and external retention. Gasket temperature range -40°F to 212°F (-40°C - 100°C) Gasket suitable for water, salt solutions, mild acids, bases, and sewage.

**Service**

**Rating:** 2" - 12" Outlets: 175 PSI, per ANSI/AWWA C228.  
 For higher service ratings, contact JCM Technical Services.

JCM 400 Series Tapping Sleeves are ANSI/NSF Standard 61, Annex G & ANSI/NSF Standard 372 Certified.

JCM 400 Series Tapping Sleeves meet MSS-SP124 and ANSI/AWWA Standard C223 Fabricated Steel and Stainless Steel Tapping Sleeves, ANSI/AWWA Standard C228 Stainless Steel Pipe Flanges for Water Service as applicable.





**JCM 452 Stainless Steel Tapping Sleeve - Stainless Flange - Outlet Seal Gasket**  
**JCM 464 Stainless Tapping Sleeve - Carbon Flange - Outlet Seal Gasket**

Nom Pipe Size (IN)	Pipe OD Range (IN)	Sleeve Number	X	Outlet Sizes Available	452 Stainless Flange List Price Each	464 Carbon Flange List Price Each	Appr Wt Each Lbs
4	4.5	0450	X	3	\$ 1,430.00	\$ 1,321.00	36
	4.8	0480		4	1,430.00	1,321.00	36
6**	6.63	0663	X	3	1,516.00	1,403.00	38
	6.83 - 7.16	0690		4	1,516.00	1,403.00	38
	7.05 - 7.40	0720		6	1,751.00	1,555.00	46
	7.40 - 7.73	0745					
8	8.63	0863	X	3	1,642.00	1,506.00	40
	8.98 - 9.37	0905		4	1,642.00	1,506.00	40
	9.27 - 9.69	0940		6	1,840.00	1,641.00	58
10	9.83 - 10.25	*1000	X	8	2,529.00	2,006.00	12
	10.64 - 10.86	1075		3	1,834.00	1,657.00	74
	11.03 - 11.47	1110		4	1,834.00	1,657.00	75
	11.36 - 11.80	1140		6	1,973.00	1,762.00	80
	11.76 - 12.24	1200		8	2,427.00	2,154.00	125
				10	3,462.00	3,078.00	168
12	12.62 - 12.88	1275	X	3	1,859.00	1,683.00	76
	13.13 - 13.60	1320		4	1,859.00	1,683.00	78
	13.60 - 14.09	1392		6	2,061.00	1,837.00	82
	14.08 - 14.56	1420		8	2,535.00	2,258.00	110
				10	3,561.00	3,164.00	176
14	14.59 - 15.08	1475	X	12	5,564.00	3,974.00	216
	15.23 - 15.80	1530		3	P.O.A.	P.O.A.	113
	15.73 - 16.22	1600		4	P.O.A.	P.O.A.	115
	16.30 - 16.73	1650		6	P.O.A.	P.O.A.	116
				8	P.O.A.	P.O.A.	150
16	16.74 - 17.26	1684	X	10	P.O.A.	P.O.A.	190
	17.33 - 17.87	1740		12	P.O.A.	P.O.A.	220
	17.88 - 18.43	1800		3	P.O.A.	P.O.A.	113
	18.62 - 19.19	1875		4	P.O.A.	P.O.A.	115
				6	P.O.A.	P.O.A.	120
18	18.87 - 19.45	1920	X	8	P.O.A.	P.O.A.	162
	19.41 - 20.01	1950		10	P.O.A.	P.O.A.	210
	20.00 - 20.60	2000		12	P.O.A.	P.O.A.	230
	20.29 - 20.94	2050		3	P.O.A.	P.O.A.	120
	20.93 - 21.57	2130		4	P.O.A.	P.O.A.	122
20	21.51 - 22.15	2160	X	6	P.O.A.	P.O.A.	126
	22.16 - 22.81	2254		8	P.O.A.	P.O.A.	180
	22.78 - 23.45	2294		10	P.O.A.	P.O.A.	220
	23.46 - 24.16	2400		12	P.O.A.	P.O.A.	245
	24.15 - 24.85	2450		3	P.O.A.	P.O.A.	143
	24.82 - 25.52	2502		4	P.O.A.	P.O.A.	143
24	25.71 - 26.41	2580	X	6	P.O.A.	P.O.A.	160
	26.55 - 27.25	2715		8	P.O.A.	P.O.A.	215
	27.26 - 27.96	2746		10	P.O.A.	P.O.A.	280
	28.14 - 28.84	2834		12	P.O.A.	P.O.A.	307
				3	P.O.A.	P.O.A.	163
30	29.78 - 30.48	3000	X	4	P.O.A.	P.O.A.	165
	30.48 - 31.18	3075		6	P.O.A.	P.O.A.	175
	31.52 - 32.22	3200		8	P.O.A.	P.O.A.	226
				10	P.O.A.	P.O.A.	295
				12	P.O.A.	P.O.A.	350

\*Range not available with size on size outlet.

\*\*Sizes incorporate (8) - 5/8" bolts.

Size on size outlets require a 1/2" undersize shell cutter.

JCM 452 Tapping Sleeves furnished with test plugs unless otherwise specified.

Tapping Sleeves with outlets 3" and smaller are Non Returnable Items

**452 Stainless Steel Tapping Sleeve - Stainless Flange - Outlet Seal Gasket**

**464 Stainless Tapping Sleeve - Carbon Flange - Outlet Seal Gasket**

Nom Pipe Size (IN)	Pipe OD Range (IN)	Sleeve Number	X	Outlet Sizes Available	452 Stainless Flange List Price Each	464 Carbon Flange List Price Each	Appr Wt Each Lbs
				3	P.O.A.	P.O.A.	322
				4	P.O.A.	P.O.A.	326
36	35.75 - 36.25	3600	X	6	P.O.A.	P.O.A.	342
	38.05 - 38.55	3830		8	P.O.A.	P.O.A.	354
				10	P.O.A.	P.O.A.	445
				12	P.O.A.	P.O.A.	561
				3	P.O.A.	P.O.A.	390
				4	P.O.A.	P.O.A.	390
42	41.75 - 42.25	4200	X	6	P.O.A.	P.O.A.	450
	44.25 - 44.75	4450		8	P.O.A.	P.O.A.	475
				10	P.O.A.	P.O.A.	520
				12	P.O.A.	P.O.A.	630
				3	P.O.A.	P.O.A.	412
				4	P.O.A.	P.O.A.	412
48	47.75 - 48.25	4800	X	6	P.O.A.	P.O.A.	465
	50.55 - 51.05	5080		8	P.O.A.	P.O.A.	500
				10	P.O.A.	P.O.A.	540
				12	P.O.A.	P.O.A.	690
				3	P.O.A.	P.O.A.	425
54	53.75 - 54.25	5400	X	4	P.O.A.	P.O.A.	425
	56.25 - 56.75	5650		6	P.O.A.	P.O.A.	490
	56.85 - 57.35	5710		8	P.O.A.	P.O.A.	530
<b>Larger Pipe and Outlet Sizes Available</b>				10	P.O.A.	P.O.A.	560
				12	P.O.A.	P.O.A.	731



**452**



**464**



**JCM 412 Fabricated Carbon Steel Flanged Outlet Tapping Sleeve**  
**JCM 452/464 Stainless Steel Fabricated Outlet Tapping Sleeve**  
 Dimensional Data for Pipe Sizes up through 30" Nominal Pipe Size.  
 For other sizes, contact JCM Industries at 1-800-527-8482

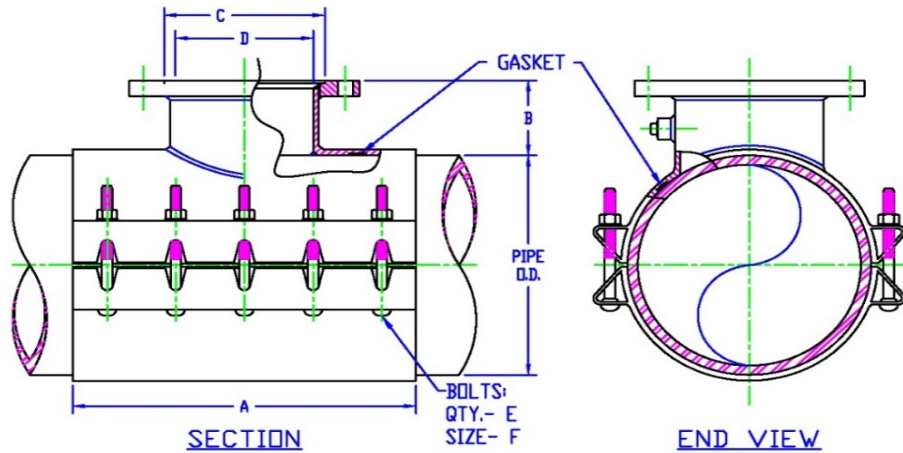

<b>JCM 412/452/464 Fabricated Tapping Sleeves</b>						
Outlet	A	B	C	D	E	F
3	12	5	4-1/32	3.50	6*	3/4*
4	12	5	5-1/32	4.50	6*	3/4*
6	12	5	7-1/32	6.63**	6*	3/4*
8	16	5-1/8	9-1/32	8.13	8	3/4
10	20	5-1/2	11-1/16	10.25	10	3/4
12	24	5-3/4	13-1/16	12.25	12	3/4

\*Nominal Pipe Size 6" and smaller, E = 8, F = 5/8"  
 \*\*Nominal Pipe Size 6" and smaller, dimension D = 6-1/8

<b>JCM 452/464 Tapping Sleeve Nominal Sizes 12" and Smaller</b>						
Outlet	A	B	C	D	E	F
3	12*	5	4-1/32	3.26	6	3/4
4	12*	5	5-1/32	4.26	6	3/4
6	12	5	7-1/32	6.36	6	3/4
8	16**	5-1/8	9-1/32	8.33	8	3/4
10	20***	5-1/2	11-1/16	10.42	10	3/4
12	24	5-3/4	13-1/16	12.39	12	3/4

\*Nominal Pipe Sizes 12" and smaller & 4 X4, dimension A = 9  
 \*\*Nominal Pipe Sizes 12" and smaller, dimension A = 15  
 \*\*\*Nominal Pipe Sizes 12" and smaller, dimension A = 21

**JCM 419 Fabricated Carbon Steel Mechanical Joint Outlet Tapping Sleeve**  
**JCM 459/465 Stainless Steel Mechanical Joint Outlet Tapping Sleeve**  
 Dimensional Data for Pipe Sizes up through 30" Nominal Pipe Size.  
 For other sizes, contact JCM Industries at 1-800-527-8482

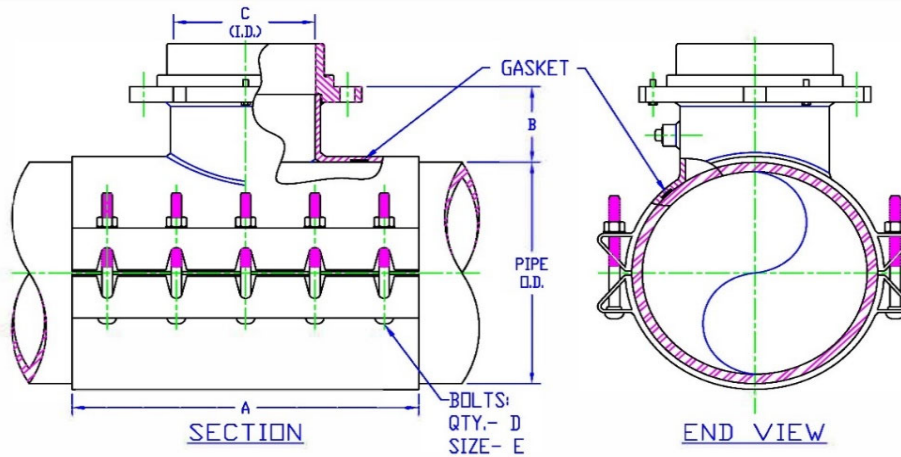

<b>JCM 419 Fabricated MJ Outlet Tapping Sleeve</b>					
Outlet	A	B	C	D	E
3	12	5-1/16	3.32	6*	3/4*
4	12	5-3/16	4.26	6*	3/4*
6	12	5-5/16	6.36	6*	3/4*
8	16	5-7/16	8.33	8	3/4
10	20	5-7/16	10.42	10	3/4
12	24	5-7/16	12.39	12	3/4

\*Nominal Pipe Sizes 6": D = 8, E = 5/8"

<b>JCM 459/465 Stainless Steel MJ Outlet Tapping Sleeve</b>					
Outlet	A	B	C	D	E
3	12*	5	3.32	6	3/4
4	12*	5-1/8	4.26	6	3/4
6	12	5-1/4	6.36	6	3/4
8	16**	5-3/8	8.33	8	3/4
10	20***	5-3/8	10.42	10	3/4
12	24	5-3/8	12.39	12	3/4

\*Nominal Pipe Sizes 12" and smaller and 4 x 4: A = 9  
 \*\*Nominal Pipe Sizes 12" and smaller: A = 15  
 \*\*\*Nominal Pipe Sizes 10" & 12": A = 21  
 Nominal Pipe Sizes 12" and smaller: D = 8 (4" & 6"), 10 (8"), 14 (10") 16 (12"), E = 5/8"  
 Dimensions for JCM 459 Tapping Sleeve are applicable to the JCM 6459 All 316 Stainless Steel Tapping Sleeve

## JCM Fabricated Weld On Tapping Outlets

Carbon Steel and All Stainless Steel (304 & 316) Construction Available

JCM Weld On Fittings are fabricated in compliance with the AWWA M11 Manual for Steel Pipe - Fittings Design, Appurtenances - other modifications available.

Outlets, partial sleeves and complete sleeves are readily available for steel pipe 4" and larger with size on size and reducing outlets. Outlets and partial sleeves are also available for tank and bulkhead use.

Various configurations of this design are available. Featured below are the most popular.

Nominal Pipe Size (IN)	Catalog Number (Pipe OD)	Outlet Sizes
4	0450	x 3 x 4
6	0663	x 3 x 4 x 6
8	0863	x 3 x 4 x 6 x 8
10	1075	x 3 x 4 x 6 x 8 x 10
12	1275	x 3 x 4 x 6 x 8 x 10 x 12

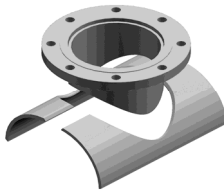

416 Type 2 Half-Wrapper

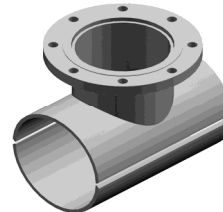

417 Type 1



416 Type 2 Collar

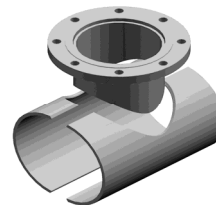

417 Type 2

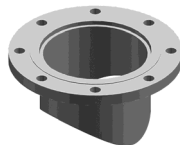

416 Type 3 Nozzle

Weld On fittings are priced on application, contact JCM Sales Team 1-800-527-8482 or 903-832-2581.

Larger sizes available upon request.

Furnish fitting type and pipe O.D.

Sleeves are fabricated to the exact O.D. of the pipe.

### How To Order:

1. Determine nominal pipe O.D. and outlet size.
2. Determine sleeve type required.
3. Specify sleeve type, pipe O.D. and outlet size.

Example: For Steel Pipe with 8.63 O.D. with 6" flanged outlet, full sleeve style, order: 417-0863x6 Type 1

Standard flange ANSI/AWWA C207 Class D, ANSI 150lb. Drilling, recessed for tapping valve MSS-SP60.

AWWA fittings are supplied with test outlet unless otherwise requested.

Available Upon Request

ANSI Flanges, Weld Neck Flanges and others

Outlets Beveled for Welding

Crotch-Plate (Wye Branch Design)

All Stainless Steel Fabrications (304, 316)

Test Ports

Custom Pipe Diameters



Certified to  
NSF/ANSI/ICAN 61  
& NSF/ANSI 372

## **JCM INDUSTRIES, INC,**

### **General Application Information**

### **Fittings and Fabrications for High Density Polyethylene Pipe**

JCM Products for repairing, connecting and tapping Polyethylene pipe have been tested and evaluated for their suitability and design capability. In each case JCM products have performed satisfactorily in respect to their design application. Test criteria range from short-term for special applications to long-term 1000 hour evaluations with the most common applications. Temperature and pressure cycles are also incorporated to fully address the pipe characteristics and full range of occurrences. Special monitoring equipment is utilized to produce accurate test data and for historical reference.

High Density Polyethylene Pipe (HDPE) has several unique characteristics which are taken into consideration in the following guidelines. The disregard of these guidelines and/or the installation instructions supplied with each fitting may cause unsatisfactory results and void the expressed product warranty.

HDPE Pipe considered for use must be manufactured to the recommendations set forth in the ANSI/AWWA Standard C906 and complies with criteria in reference to size.

HDPE has a high coefficient of thermal expansion and contraction along with a low modulus of elasticity. This sensitivity to pressure and temperature causes HDPE to expand and contract more than traditional water and sewer piping materials. The potential pipe expansion or contraction must be considered when assembling bolt on fittings.

HDPE will relax ("creep") at lower stress levels than other piping materials. Due to these special characteristics, the following parameters should be adhered to when utilizing JCM products for HDPE (ANSI/AWWA C901, C906).

- HDPE and bolt-on fitting connections are vulnerable to forces experienced with expansion/contraction of the pipe and require special consideration. Restraint must be considered when joining plain end pipe to ensure against pipe pull out. HDPE is manufactured with a smooth pipe wall surface resulting in a low coefficient of friction that can enable fittings to slide, shift, move, rotate and/or travel on the pipe after installation. JCM products are limited in the tolerance of axial movement of the pipe.

- JCM products for HDPE are designed for underground pressurized fluid service and are pressure rated to match the pipe SDR pressure rating or with a maximum service rating of 150 PSI (Temperature 35° - 75° F/Maximum test pressure limited to rated pipe pressure or fitting, whichever is lower). For above ground applications, contact JCM Industries Technical Services.

- Pipe stiffeners must be used when joining, or connecting to, HDPE. Pipe systems must be engineered to prevent movement causing fittings to slide or rotate on the pipe. Cutting HDPE can cause the pipe to ovate or "neck" down and become egg shaped. This pipe movement can interfere with the assembly of bolt on fittings.

Thirty years of successful performance has been one of the most stringent proving grounds for JCM products and their application with Polyethylene Pipe. Generally speaking, most common potable water pressure applications utilize HDPE SDR 17 through 11. For applications on thinner wall pipe, special applications, higher pressure ratings and product usage recommendations, please contact JCM.

Note: JCM recommends fusion joints as a primary method of connection. When correctly implemented, fused joints are self-restraining and leak proof. In some instances conditions are not conducive to properly fuse the joint per manufacturers' recommendations. Mechanical fittings to join or repair HDPE are a secondary and limiting choice. The information included on this page is provided to address the known factors when repairing, joining or tapping HDPE with mechanical fittings.

Effective 01/02/18

**JCM 418 Carbon Steel Threaded Outlet Tapping Sleeve for HDPE Pipe**  
**JCM 438 Stainless Steel Threaded Outlet Tapping Sleeve for HDPE Pipe**

JCM Products for tapping PE pipe have been tested and evaluated for their suitability and design capability. In each case JCM products have performed satisfactorily in respect to their design application.

High Density Polyethylene Pipe (HDPE) has several unique characteristics which must be taken into consideration. HDPE has a high coefficient of thermal expansion and a low modulus of elasticity. This sensitivity to pressure and temperature causes HDPE to expand and contract more than traditional water and sewer piping materials. HDPE will also relax ("creep") at lower stress levels than other piping materials.

In consideration of the unique characteristics, JCM provides fabricated tapping fittings that are sized specifically with applicable ranges for HDPE.

**JCM Outlet Seal Threaded Outlet Tapping Sleeves for HDPE Pipe**  
**Model Numbers 418, 438**

**Ranges and Part Numbers provided specifically for High Density Polyethylene Pipe.**

Nom Pipe Size (IN)	Pipe OD Range (IN)	Sleeve Number x Outlet Size
14	13.60 - 14.09	1392
	14.99 - 15.49	1520
16	15.68 - 16.18	1590
	17.05 - 17.55	1730
18	17.64 - 18.14	1790
	19.11 - 19.61	1940
20	19.60 - 20.10	1990
	21.17 - 21.67	2150
21	20.60 - 21.10	2090
	21.60 - 22.10	2190
24	23.46 - 24.16	2400
	25.30 - 25.80	2570
27	26.50 - 27.00	2690
	27.50 - 28.00	2790
30	29.50 - 30.00	2990
	31.50 - 32.00	3190
36	35.50 - 36.00	3590
	37.80 - 38.30	3820
42	41.50 - 42.00	4190
	44.00 - 44.50	4440
48	47.50 - 48.00	4790
	50.30 - 50.80	5070
54	53.50 - 54.00	5390
	57.06 - 57.56	5746
60	59.50 - 60.00	5990
	61.11 - 61.61	6151

**Available Threaded Outlet Sizes 3/4" thru 4"**



**How to Order:**

- 1) Determine outside diameter of HDPE Pipe (IPS, DI), provide SDR#.
- 2) Select sleeve material (carbon, stainless) and proper size outlet.
- 3) Select model number (418, 438). For full product description see JCM Catalog.
- 4) Select proper sleeve O.D. Range and sleeve number.
- 5) Specify Model Number-Sleeve Number x Outlet Size  
 Example: For 24" HDPE SDR 17 IPS O.D. pipe, 2" threaded outlet, carbon steel, order:  
 418-2400X14IP  
 Example: For 24" HDPE SDR 17 IPS O.D. Pipe, 2" threaded outlet, All Stainless Steel, order:  
 438-2400X14IP

Note: 2" CC Threaded Outlet Sleeves are Non Returnable Items

## JCM Outlet Seal Tapping Sleeves for HDPE Pipe

Model Numbers 412, 419, 452, 464, 459, 465

Ranges and Part Numbers provided specifically for High Density Polyethylene Pipe  
For sizes not listed, contact JCM Inside Sales Team at 800-527-8482 or 903-832-2581



Nom Pipe Size (IN)	Pipe OD Range (IN)	Sleeve Number x Outlet Size	Flange Outlet Sizes Available
14	13.60 - 14.09	1392	2" and Larger Outlets Available Contact JCM Industries
	14.99 - 15.49	1520	
16	15.68 - 16.18	1590	
	17.05 - 17.55	1730	
18	17.64 - 18.14	1790	
	19.11 - 19.61	1940	
20	19.60 - 20.10	1990	
	21.17 - 21.67	2150	
21	20.60 - 21.10	2090	
22	21.60 - 22.10	2190	
24	23.46 - 24.16	2400	
	25.30 - 25.80	2570	
27	26.50 - 27.00	2690	
28	27.50 - 28.00	2790	
30	29.50 - 30.00	2990	
	31.50 - 32.00	3190	
36	35.50 - 36.00	3590	
	37.80 - 38.30	3820	
42	41.50 - 42.00	4190	
	44.00 - 44.50	4440	
48	47.50 - 48.00	4790	
	50.30 - 50.80	5070	
54	53.50 - 54.00	5390	
	57.06 - 57.56	5746	
60	59.50 - 60.00	5990	
	61.11 - 61.61	6151	

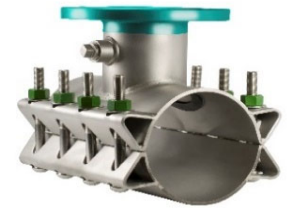

2" Mechanical Joint Outlets Not Available

JCM Flanged and Mechanical Joint Outlet Tapping Sleeves furnished with test plugs unless otherwise specified.

### How to Order:

Determine outside diameter of HDPE Pipe (IPS, DI), provide SDR#.

Select sleeve material (carbon, stainless) and proper outlet material & type (flange, mechanical joint).

Select model number. For full product description, see JCM Catalog.

Select proper sleeve O.D. Range and sleeve number.

Specify Model Number-Sleeve Number x Outlet Size.

Example: For 24" HDPE SDR 17 IPS O.D. pipe, with 8" flanged outlet, carbon steel, order: 412-2400 x 8

Example: For 24" HDPE SDR 17 IPS O.D. Pipe, with 8" mechanical joint outlet, All Stainless Steel, order: 459-2400 x 8



JCM 440 Type 1 Line Stop All Stainless Full Circumferential Gasket - Threaded Plug  
 JCM 440 Type 11 Line Stop All Stainless Full Circumferential Gasket - Push Plug/Pin  
 JCM 440 Type 4 Line Stop Full Circumferential Gasket Carbon Outlet - Threaded Plug  
 JCM 440 Type 14 Line Stop Full Circumferential Gasket Carbon Outlet - Push Plug/Pin

Nom Pipe Size (IN)	Pipe OD Range (IN)	Sleeve Number	X	Outlet Sizes Available	Stainless Steel Outlet	Stainless Steel Outlet	Carbon Steel Outlet	Carbon Steel Outlet	Appr Wt Each Lbs
					Threaded Plug Type Code	Push Plug/Pin Type Code	Threaded Plug Type Code	Push Plug/Pin Type Code	
4	4.40 - 4.60	440-0450	x	4	T1	T11	T4	T14	56
	4.50 - 4.80	440-0465			T1	T11	T4	T14	
	4.74 - 5.00	440-0480			T1	T11	T4	T14	
	5.10 - 5.30	440-0520			T1	T11	T4	T14	
6	6.56 - 6.76	440-0663	x	4	T1	T11	T4	T14	63
	6.84 - 7.10	440-0690			T1	T11	T4	T14	
	7.05 - 7.25	440-0720		6	T1	T11	T4	T14	85
	7.40 - 7.65	440-0745			T1	T11	T4	T14	
8	8.54 - 8.74	440-0863	x	6	T1	T11	T4	T14	117
	8.60 - 9.05	440-0900			T1	T11	T4	T14	
	8.98 - 9.30	440-0905		8	T1	T11	T4	T14	170
	9.27 - 9.50	440-0940			T1	T11	T4	T14	
10	9.83 - 10.25	440-1000	x	8	T1	T11	T4	T14	163
	10.64 - 10.86	440-1075			T1	T11	T4	T14	
	11.03 - 11.40	440-1110		10	T1	T11	T4	T14	192
	11.36 - 11.80	440-1140			T1	T11	T4	T14	
11.85 - 12.15	440-1200		T1	T11	T4	T14			
12	12.62 - 12.85	440-1275	x	8	T1	T11	T4	T14	144
	12.75 - 13.20	440-1300			T1	T11	T4	T14	
	13.12 - 13.50	440-1320		12	T1	T11	T4	T14	300
	13.70 - 14.09	440-1392			T1	T11	T4	T14	
14.10 - 14.35	440-1420		T1	T11	T4	T14			

U.S. Patent No. 8,176,929

Recommended for: cast iron, ductile iron, asbestos cement, PVC and other types of pipe susceptible to breakage.

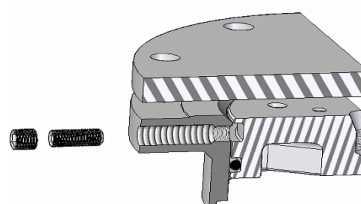
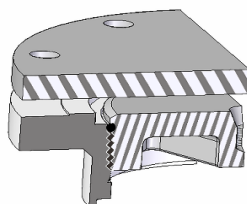

**Threaded Plug  
Type 1, 4**

**Push Plug/Pin  
Type 11, 14**

Price List Effective July 19, 2021. Cancels all previous prices. Prices are subject to change without notice.

**JCM 440 Type 2 Line Stop Carbon Steel - Outlet Gasket - Threaded Plug**  
**JCM 440 Type 12 Line Stop Carbon Steel - Outlet Gasket - Push Plug/Pin**  
**JCM 440 Type 3 Line Stop All Stainless Steel - Outlet Seal Gasket - Threaded Plug**  
**JCM 440 Type 13 Line Stop All Stainless Steel - Outlet Seal Gasket - Push Plug/Pin**  
**JCM 440 Type 5 Line Stop Stainless Body - Carbon Steel Outlet - Outlet Seal Gasket - Threaded Plug**  
**JCM 440 Type 15 Line Stop Stainless Body - Carbon Steel Outlet - Outlet Seal Gasket - Push Plug/Pin**

Nom Pipe Size (IN)	Pipe OD Range (IN)	Sleeve Number	x	Outlet Sizes Available	Carbon Steel	Carbon Steel	All Stainless Steel	All Stainless Steel	Stainless with Carbon Outlet	Stainless with Carbon Outlet	Appr Wt Each Lbs
					Threaded Plug Type Code	Push Plug/Pin Type Code	Threaded Plug Type Code	Push Plug/Pin Type Code	Threaded Plug Type Code	Push Plug/Pin Type Code	
4	4.5	440-0450	x	4	T2	T12	T3	T13	T5	T15	48
	4.8	440-0480			T2	T12	T3	T13	T5	T15	
	5.2	440-0520			T2	T12	T3	T13	T5	T15	
	5.56	440-0556			T2	T12	T3	T13	T5	T15	
6	6.63	440-0663	x	6	T2	T12	T3	T13	T5	T15	92 114
	6.84 - 7.10	440-0690			T2	T12	T3	T13	T5	T15	
	7.05 - 7.25	440-0720			T2	T12	T3	T13	T5	T15	
	7.40 - 7.65	440-0745			T2	T12	T3	T13	T5	T15	
8	8.63	440-0863	x	8	T2	T12	T3	T13	T5	T15	120 172
	8.98 - 9.30	440-0905			T2	T12	T3	T13	T5	T15	
	9.27 - 9.50	440-0940			T2	T12	T3	T13	T5	T15	
	9.83 -10.25	440-1000			T2	T12	T3	T13	T5	T15	
10	10.64 - 10.86	440-1075	x	10	T2	T12	T3	T13	T5	T15	179 267
	11.03 - 11.40	440-1110			T2	T12	T3	T13	T5	T15	
	11.36 - 11.80	440-1140			T2	T12	T3	T13	T5	T15	
	11.85 - 12.15	440-1200			T2	T12	T3	T13	T5	T15	
12	12.62 - 12.85	440-1275	x	12	T2	T12	T3	T13	T5	T15	194 324
	13.12 - 13.50	440-1320			T2	T12	T3	T13	T5	T15	
	13.70 - 14.09	440-1392			T2	T12	T3	T13	T5	T15	
	14.10 - 14.35	440-1420			T2	T12	T3	T13	T5	T15	
14	14.59 - 15.08	440-1475	x	12	T2	T12	T3	T13	T5	T15	328
	15.23 - 15.80	440-1530			T2	T12	T3	T13	T5	T15	
	15.73 - 16.22	440-1600			T2	T12	T3	T13	T5	T15	
	16.30 - 16.73	440-1650			T2	T12	T3	T13	T5	T15	
16	16.74 - 17.26	440-1684	x	12	T2	T12	T3	T13	T5	T15	338
	17.33 - 17.87	440-1740			T2	T12	T3	T13	T5	T15	
	17.88 - 18.43	440-1800			T2	T12	T3	T13	T5	T15	
	18.62 - 19.19	440-1875			T2	T12	T3	T13	T5	T15	
18	18.87 - 19.45	440-1920	x	12	T2	T12	T3	T13	T5	T15	353
	19.41 - 20.01	440-1950			T2	T12	T3	T13	T5	T15	
	20.00 - 20.60	440-2000			T2	T12	T3	T13	T5	T15	
	20.29 - 20.94	440-2050			T2	T12	T3	T13	T5	T15	
20	20.93 - 21.57	440-2130	x	12	T2	T12	T3	T13	T5	T15	363
	21.51 - 22.15	440-2160			T2	T12	T3	T13	T5	T15	
	22.16 - 22.81	440-2254			T2	T12	T3	T13	T5	T15	
	22.78 - 23.45	440-2294			T2	T12	T3	T13	T5	T15	
	23.46 - 24.16	440-2400			T2	T12	T3	T13	T5	T15	
	24.15 - 24.85	440-2450			T2	T12	T3	T13	T5	T15	
24.82 - 25.52	440-2502	T2	T12	T3	T13	T5	T15				

U.S. Patent No. 8,176,929

Other sleeve ranges and outlet sizes available upon request.



Threaded Plug



Push Plug/Pin

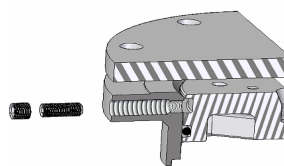
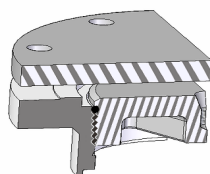

Type 2, 3, 5

Type 12, 13, 15

**JCM 440 Type 6 - Full Body- Threaded Plug**  
**JCM 440 Type 16 - Full Body - Push Plug/Pin**  
**JCM 440 Type 7 - Outlet Only - Threaded Plug**  
**JCM 440 Type 17 - Outlet Only - Push Plug/Pin**

Nom Pipe Size (IN)	Pipe OD Range (IN)	Sleeve Number	X	Outlet Sizes Available	Type 6 Type 16 Full Body		Type 7 Type 17 Outlet Only	
					Threaded Plug Type Code	Push Plug/Pin Type Code	Threaded Plug Type Code	Push Plug/Pin Type Code
4	4.50	440-0450	X	4	T6	T16	T7	T17
6	6.63	440-0663	X	4	T6	T16	T7	T17
				6	T6	T16	T7	T17
8	8.63	440-0863	X	6	T6	T16	T7	T17
				8	T6	T16	T7	T17
10	10.75	440-1075	X	8	T6	T16	T7	T17
				10	T6	T16	T7	T17
12	12.75	440-1275	X	8	T6	T16	T7	T17
				12	T6	T16	T7	T17
14	14.00	440-1400	X	12	T6	T16	T7	T17
16	16.00	440-1600	X	12	T6	T16	T7	T17
18	18.00	440-1800	X	12	T6	T16	T7	T17
20	20.00	440-2000	X	12	T6	T16	T7	T17

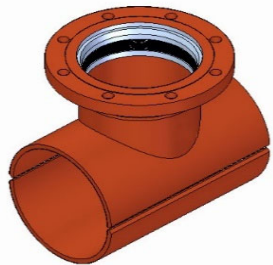

**Full Body**

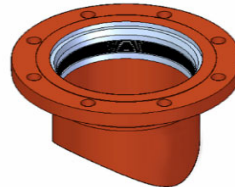

**Outlet Only**

**Threaded Plug**

**Push Plug/Pin**

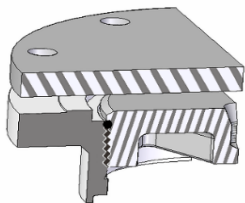

**Type 6, 7**

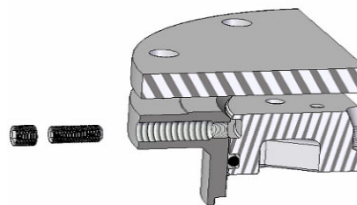

**Type 16, 17**

## JCM 414 Mechanical Joint Fabricated Tapping Sleeve



The JCM 414 Fabricated Mechanical Joint Tapping Sleeve is recommended for taps on pipe that will not accommodate a direct top seal tapping sleeve. The 414 utilizes a **true mechanical joint sleeve design** that completely encompasses the tap area, eliminating any potential leaks due to pipe cracks or breaks. Side gaskets are internally and externally trapped in a recessed groove machined into the bolting lug bars that completely compress the gaskets creating the watertight seal on the sides of the sleeve. The end gaskets are compressed into the sleeve housing with mechanical joint pusher glands, providing the water tight seal on the ends of the sleeve and completing the full encapsulation of the tap area.

### Features of the Fabricated 414 Tapping Sleeve

**High Strength Steel** eliminates stress cracked casting or flange possibility. Side And End Gaskets provide complete seal around the pipe.

**Fabricated Sleeves** provide more strength with significantly reduced weight than a cast sleeve. The lighter sleeve reduces the load on the pipe and aids in installation and handling. For applications in corrosive environments, the JCM 414 is available fabricated in all stainless steel.

**Accommodates Non-Standard Pipe Characteristics** - Oversize, undersize or irregularities in the pipe O.D. can be accommodated within the fitting increasing performance and safety factor. The JCM 414 is available in larger sizes, non-standard sizes and with many special options (special flanges, special laying lengths, etc.)

**Improved Availability** - Fabricated sleeves with non-standard sizes have a delivery schedule of three to five weeks, significantly less than a cast sleeve's six to nine months.

### How To Order

For pricing and engineering, the following information must be furnished:

- Type of pipe
- Outside diameter of pipe
- Irregular or non-standard pipe characteristics
- Line contents and pressure
- Outlet Size (14" and larger, furnish manufacturer of valve and cutter size)
- Coating and hardware
- Material requirements - options
- Special requirements

JCM 414 Fabricated Mechanical Joint Tapping Sleeves meet or exceed ANSI/AWWA C111/A21.11 as applicable. JCM 400 Series Tapping Sleeves are ANSI/NSF Standard 61, Annex G & ANSI/NSF 372 Certified. JCM 400 Series Tapping Sleeves meet MSS-SP124 and ANSI/AWWA Standard C223 Fabricated Steel and Stainless Steel Tapping Sleeves.

JCM 414 Mechanical Joint Tapping Sleeves are Priced on Application. For quotation, contact the JCM Inside Sales Team at 1-800-527-8482 or 1-903-832-2581.



## JCM 415 Tapping Sleeve for Concrete Steel Cylinder Pipe



The JCM 415 Tapping Sleeve for Concrete Steel Cylinder Pipe is the standard in the industry for fast safe taps on Concrete Pressure Pipe. Designed to meet the AWWA M-9 Manual, the JCM 415 is the leading sleeve preferred by PCCP tapping contractors. These fabricated tapping sleeves are designed to reinforce the pipe and provide for easy installation with maximum safety factor. There are many unique features as well as options available on these sleeves. Unique to these sleeves are the following:

**Separate Body and Tapping Gland (outlet)** - By separating the outlet gland from the sleeve body the sleeve reinforces the pipe prior to removal of the critical prestress wire from the outlet area.

**Broad Cross Section Gasket** - The 7/8" wide gasket with a hydromechanical lip provides a broad sealing surface which produces an initial seal that increases with increases in line pressure. The broad, flat gasket is very advantageous for sealing on beveled cylinder welds.

**Gusseted Pressure Plate** - The gusseted pressure plate eliminates problems caused by flexing of the cylinder or tapping sleeve pressure plate. This grooved plate is contoured to fit the cylinder and retains the broad profile gasket to provide an extra margin of safety at this critical point.

**Combination Gland/Draw Flange** - The combination gland/draw flange on 4" - 12" outlet sizes facilitates tapping with a 25" travel tapping machine. Larger outlets utilize separate flanges for each function to make bolt take-up on large flanges more accessible.

**Load Bearing Set Screws** - The JCM 415 Tapping Sleeve is furnished with load bearing set screws on the gland flange that are tightened after the gland is installed. These set screws tighten against the sleeve draw flange, transferring any load on the outlet away from the steel cylinder and onto the sleeve.

**Grout Seal Assembly** - Type I 415 Tapping Sleeve, the standard sleeve, is furnished with straps and a grout seal assembly under the sleeve. These two design features facilitate fitting oversize, undersize and out-of-round pipe by providing the means to pour cement grout into a cavity to make a perfect sleeve fit. This feature is in accordance with AWWA M-9 Manual as recommended by the manufacturers of concrete pressure pipe. Epoxy coated sleeves and sleeves with a solid back sit directly on the pipe, precluding the use of the grout seal assembly.

**Epoxy Coated Waterway** - The tapping sleeve's waterway is fusion applied epoxy coated to provide a quality connection protected against corrosion in the critical waterway

### How To Order

For pricing and engineering, the following information must be furnished:

- Type of pipe (also manufacturer and class if known)
- Type of sleeve
- Outside diameter of pipe and cylinder O.D.
- Line content and pressure
- Outlet size (on outlets 14" and larger furnish manufacturer of valve and cutter size)
- Material requirements or options
- Any special requirements or options.

**FOR SLEEVES FOR REINFORCED CONCRETE PIPE ASK FOR JCM 412 TAPPING SLEEVES FOR REINFORCED CONCRETE PIPE.**



## 415 Tapping Sleeve for Concrete Steel Cylinder Pipe

Many agencies have special requirements which are modifications of our standard design. JCM's manufacturing flexibility makes it possible for us to offer a great many modifications without delay in product availability. Some of the more popular options on these sleeves are:

- A solid back half in lieu of straps (Type II) for Pretension Concrete Cylinder Pipe.
- Entire sleeve and outlet epoxy coated with stainless steel straps.
- Different locations of the grouting holes.

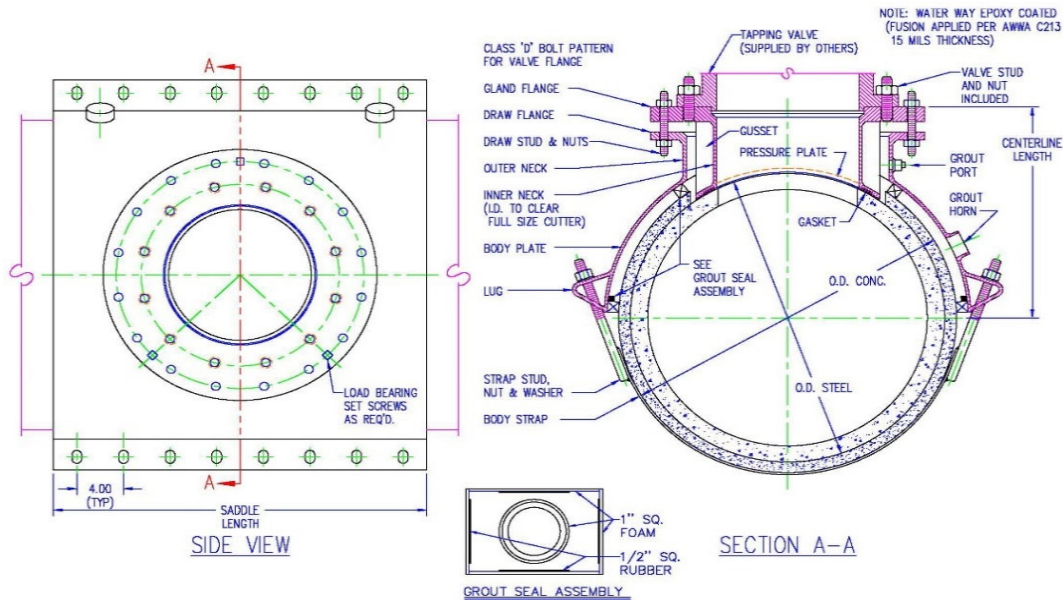

### Meets criteria set forth in the AWWA M9 Manual for Concrete Pressure Pipe

JCM Industries recommends a template of the outside diameter of the pipe surface on all taps with an outlet of 24" or larger, on all taps where the outlet is more than 60% of the pipe size, on pipe which out-of-roundness is suspected and on high-pressure taps where the fit of the sleeve is critical to the high pressure performance. Instructions for this procedure are available from JCM upon request.

JCM 415 Tapping Sleeves for Concrete Steel Cylinder Pipe are Priced on Application. For quotation, contact the JCM Inside Sales Team at 1-800-527-8482 or 1-903-832-2581.

## JCM 610 Sur-Grip Fitting Restrainer

Anchors IPS, C-900 PVC Pipe, HDPE & Ductile Iron Pipe to mechanical joint and fittings provided with anchor lugs.

Nom Pipe Size (IN)	Pipe OD Range (IN)	Catalog Number	Serrated Ring Body Width	T-Head Bolts		List Price Each	Appr Wt Each Lbs	
				Bolt Size	Qty			
4	4.50	610-0450	2-1/2"	3/4 X 9-1/2	2	\$ 166.00	12	
4	4.80	610-0480	2-1/2"	3/4 X 9-1/2	2	166.00	12	
6	6.63	610-0663	2-1/2"	3/4 X 9-1/2	2	177.00	15	
6	6.90	610-0690	2-1/2"	3/4 X 9-1/2	2	177.00	15	
8	8.63	610-0863	2-3/4"	3/4 X 9-1/2	2	280.00	22	
8	9.05	610-0905	2-3/4"	3/4 X 9-1/2	2	280.00	22	
10	11.10	Contact JCM for Information						
12	13.20	610-1320	2-3/4"	3/4 X 9-1/2	4	402.00	41	

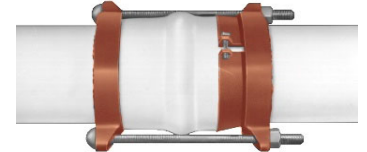

## JCM 620 Sur-Grip Bell Joint Restrainer

Anchors IPS PVC, C-900 PVC Pipe and Ductile Iron Pipe over the bell, flexible couplings and other low profile joints

Nom Pipe Size (IN)	Pipe OD Range (IN)	Catalog Number	Serrated Ring Body Width	Compression Follower Ring Width	Follower Ring Qty	Bolts		List Price Each	Appr Wt Each Lbs
						Bolt Size	Qty		
4	4.50	620-0450	2-1/2"	1-3/8"	2	3/4 X 12	2	\$ 183.00	16
4	4.80	620-0480	2-1/2"	1-3/8"	2	3/4 X 12	2	183.00	16
6	6.63	620-0663	2-1/2"	1-1/2"	2	3/4 X 12	2	217.00	21
6	6.90	620-0690	2-1/2"	1-1/2"	2	3/4 X 12	2	217.00	21
8	8.63	620-0863	2-3/4"	1-3/4"	2	3/4 X 14	2	361.00	32
8	9.05	620-0905	2-3/4"	1-3/4"	2	3/4 X 14	2	361.00	32
10	11.10	620-1110	Contact JCM for Information						
12	13.20	620-1320	2-3/4"	1-3/4"	2	3/4 X 18-1/2	4	570.00	63

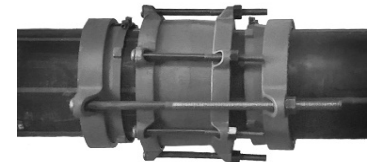

## JCM 621 Sur-Grip Restrainer

Anchors IPS PVC, C-900 PVC Pipe and Ductile Iron Pipe over flexible couplings and other low profile joints. Provides serrated restraint on both sides of joint.

Nom Pipe Size (IN)	Pipe OD Range (IN)	Catalog Number	Serrated Ring Body Width	Compression Follower Ring Width	Follower Ring	Bolts		List Price Each	Appr Wt Each Lbs
						Bolt Size	Qty		
4	4.50	621-0450	2-1/2"	1-3/8"	2	3/4 X 12	2	\$ 332.00	17
4	4.80	621-0480	2-1/2"	1-3/8"	2	3/4 X 12	2	332.00	17
6	6.63	621-0663	2-1/2"	1-1/2"	2	3/4 X 12	2	355.00	24
6	6.90	621-0690	2-1/2"	1-1/2"	2	3/4 X 12	2	355.00	24
8	8.63	621-0863	2-3/4"	1-3/4"	2	3/4 X 14	2	559.00	38
8	9.05	621-0905	2-3/4"	1-3/4"	2	3/4 X 14	2	559.00	38
10	11.10	621-1110	Contact JCM for Information						
12	13.20	621-1320	2-3/4"	1-3/4"	2	3/4 X 18-1/2	4	803.00	72

JCM 610/620 Sur-Grip Restrainers - rated for 235 PSI on DR-18 PVC Pipe, and equal to the pipe rating on other classes. JCM 610 and 620 Sur-Grip Restrainers are rated for 350 PSI on Ductile Iron Pipe with a 2:1 safety factor.

## JCM 610 Sur-Grip Restrainer - 14" - 30" for use with C900 (C905) PVC Pipe

Anchors PVC Pipe to Mechanical Joint and other types of fittings provided with anchor lugs.

Nom Pipe Size (IN)	Pipe OD Range (IN)	Catalog Number	Body Width (IN)	Restraining Rods		Bolts		List Price Each	Appr Wt Each Lbs
				Size	Qty	Bolt Size	Qty		
14	15.30	610-1530	5	3/4 X 14	6	1 X 9	4	\$ 669.00	60
16	17.40	610-1740	5	3/4 X 14	6	1 X 9	4	733.00	63
18	19.50	610-1950	5	3/4 X 14	8	1 X 9	4	800.00	73
20	21.60	610-2160	7	3/4 X 16	8	1 X 9	6	1,155.00	120
24	25.80	610-2580	7	3/4 X 16	12	1 X 9	6	1,393.00	175
30	32.00	610-3200	10	1 X 18	14	1 X 9	8	P. O. A.	330



## JCM 611 Sur-Grip PVC Fitting Restrainer - 14" - 30" for use with C900 (C905) PVC Fittings and Pipe

Anchors Long Bell PVC Gasketed Fittings to C-905 PVC Pipe. JCM 611 PVC Fitting Restrainers

For price and availability, provide the O.D., manufacturer and SDR of the PVC fitting

Nom Pipe Size	Base Catalog Number	Provide OD of PVC Fitting	List Price Each
14	611-1530	XXXX	P.O.A.
16	611-1740	XXXX	P.O.A.
18	611-1950	XXXX	P.O.A.
20	611-2160	XXXX	P.O.A.
24	611-2580	XXXX	P.O.A.
30	611-3200	XXXX	P.O.A.

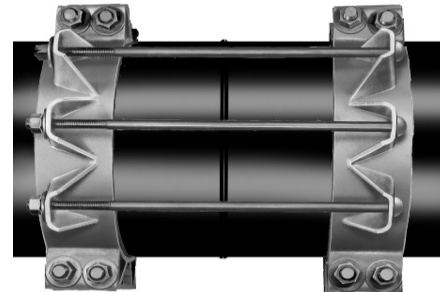
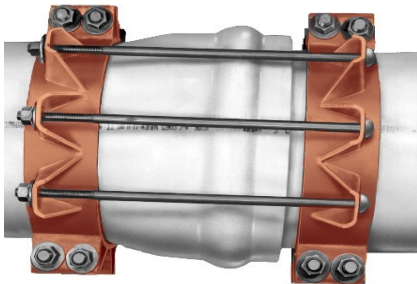
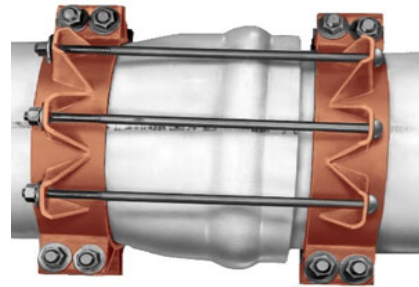

## JCM 621 Sur-Grip Bell/Joint Restrainer - 14" - 30" for use with C900 (C905) PVC Pipe, HDPE

Anchors over the bell-spigot & fused joint connection, the JCM 621 prevents joint separation on pressure pipe.

Nom Pipe Size (IN)	Pipe OD Range (IN)	Catalog Number	Body Width (IN)	Restraining Rods		Bolts		List Price Each	Appr Wt Each Lbs
				Size	Qty	Bolt Size	Qty		
14	15.30	621-1530	5	3/4 X 26	6	1 X 9	8	\$ 1,203.00	113
16	17.40	621-1740	5	3/4 X 26	6	1 X 9	8	1,355.00	120
18	19.50	621-1950	5	3/4 X 26	8	1 X 9	8	1,475.00	137
20	21.60	621-2160	7	3/4 X 32	8	1 X 9	12	2,105.00	230
24	25.80	621-2580	7	3/4 X 32	12	1 X 9	12	2,689.00	280
30	32.00	621-3200	10	1 X 36	14	1 X 9	16	P. O. A.	660

JCM 610, 611 and 621 Sur-Grip Restrainers sizes 14" - 30" are available for HDPE IPS Diameters. For quotation, contact JCM Inside Sales Team. JCM 610, 611 and 621 Sur-Grip Restrainers sizes 14" - 30" are not for use on ductile iron, cast iron, asbestos cement, steel or any other rigid types of pipe. For application recommendations, contact JCM Inside Sales Team at 1-800-527-8482 or 903-832-2581.



## 630 Fitting Restrainer for Asbestos Cement Pipe

For use with fittings, hydrants, flanged coupling adapters, meter and mechanical joints.

Nom Pipe Size (IN)	Pipe OD Range (IN)	Catalog Number	Body Width (IN)	Tie Rods		Shopcoat Alloy Bolts List Price	Epoxy Coat Alloy Bolts List Price	Epoxy Coat 304 SS Bolts List Price	Appr Wt Each Lbs
				Size	Qty				
4	4.80 - 5.10	630-0500	9	3/4 x 16	2	\$ 357.00	\$ 553.00	\$ 689.00	43
6	7.05 - 7.40	630-0720	8	3/4 x 16	2	442.00	639.00	774.00	50
8	9.27 - 9.60	630-0940	8	3/4 x 16	2	469.00	675.00	809.00	70
10	11.76 - 12.24	630-1200	8	3/4 x 16	4	660.00	877.00	1,102.00	82
12	14.08 - 14.56	630-1420	8	3/4 x 16	4	802.00	1,029.00	1,252.00	110
14	16.30 - 16.73	630-1650	12	3/4 x 16	6	1,209.00	1,447.00	1,741.00	125
16	18.62 - 19.19	630-1875	12	3/4 x 16	6	1,378.00	1,625.00	1,918.00	175

Rated for 150PSI

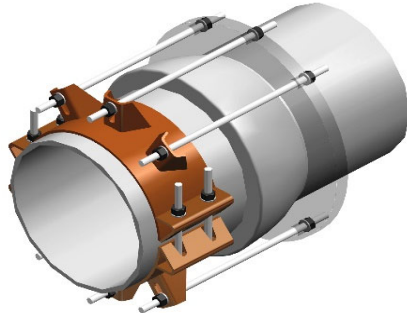

## 631 Coupling Restrainer for Asbestos Cement Pipe

Restrainer for use over A/C coupling, MJ couplings and mechanical couplings.

Tie rods (36" long), nuts and washers are included with restrainer.

Nom Pipe Size (IN)	Pipe OD Range (IN)	Catalog Number	Body Width (IN)	Tie Rods		Shopcoat Alloy Bolts List Price	Epoxy Coat Alloy Bolts List Price	Epoxy Coat 304 SS Bolts List Price	Appr Wt Each Lbs
				Size	Qty				
4	4.80 - 5.10	631-0500	9	3/4 x 36	2	\$ 829.00	\$ 1,220.00	\$ 1,580.00	68
6	7.05 - 7.40	631-0720	8	3/4 x 36	2	998.00	1,388.00	1,886.00	73
8	9.27 - 9.60	631-0940	8	3/4 x 36	2	1,131.00	1,540.00	1,902.00	130
10	11.76 - 12.24	631-1200	8	3/4 x 36	4	1,447.00	1,880.00	2,508.00	160
12	14.08 - 14.56	631-1420	8	3/4 x 36	4	1,570.00	2,023.00	2,649.00	182
14	16.30 - 16.73	631-1650	12	3/4 x 36	6	2,154.00	2,631.00	3,570.00	195
16	18.62 - 19.19	631-1875	12	3/4 x 36	6	2,313.00	2,809.00	3,749.00	315

For optional Epoxy Coating add (E) to end of Catalog Number.

For optional Epoxy Coating and stainless steel bolts add (ESS) to end of Catalog Number.

Rated for 150PSI

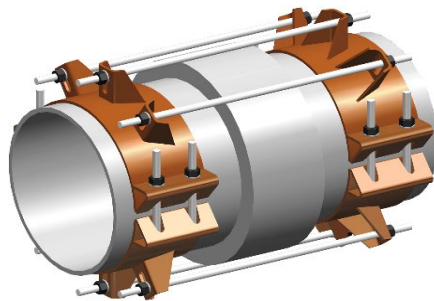

## JCM 607 Fabricated Weld On Restrainer/Joint Anchor Loops

The JCM 607 Fabricated Weld On Restrainer/Joint Anchor Loops are designed to provide permanent restraint for fittings installed on carbon and stainless steel pipelines. The JCM 607 Fabricated Weld On Restrainer/Joint Anchor Loops are available fabricated of carbon steel, 304 or 316 stainless steel and can be custom designed to the specific application.

The JCM 607 consists of an appropriate number of anchor loops (dependent upon pipe size) that are permanently field welded directly to the pipeline. JCM 607's can be installed to provide restraint directly to the fitting (when anchor loops on the fitting are present) or with restraining tie rods that extend across the fitting to the opposite side pipe restraint product (JCM or third party restrainer). Quantity and size of anchor loops tie rods are determined by nominal pipe size, opposite restraint product or by customer provided information. Tie rods provided by JCM is optional.

Standard working pressure allowable: 150PSI, for higher working pressures contact JCM Industries Engineered/Technical Sales.

For quotation or ordering, the following information is required:

- Type of Pipe
- Nominal Size of Pipe
- Outside Diameter of Pipe
- Dimensions of fitting to restrain or restrain over
- Material of construction
- Pressure rating requirements
- Number & Size of restraining tie rods
- Mating Third Party Restrainer - manufacturer or bolting pattern/size
- Any special coatings, materials or customer required modifications

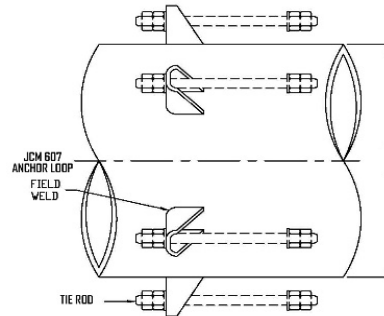

**Price on Application - contact JCM Industries Sales Team**

## JCM 617 Fabricated Weld On Restrainer/Joint Anchor Assembly

The JCM 617 Fabricated Weld On Restrainer Assembly is designed to provide permanent restraint for fittings installed in carbon and stainless steel pipelines. The JCM 617 Weld On Restrainers are available fabricated of carbon steel, 304 or 316 stainless steel and can be custom designed to the specific application.

The JCM 617 consists of an appropriate number of bolting lugs/loops (dependent upon size) that are welded to (2) rolled half rings that are permanently welded to the pipeline. JCM 617's can be installed to provide restraint directly to the fitting (when anchor loops are present) or with restraining tie rods that extend across the fitting to the opposite side pipe restraint product (JCM or third party restrainer). Quantity and size of tie rods are determined by nominal pipe size, opposite restraint product or by customer provided information. Tie rods provided by JCM is optional.

Standard working pressure allowable: 150PSI, for higher working pressures contact JCM Industries Engineered/Technical Sales.

For quotation or ordering, the following information is required:

- Type of Pipe
- Nominal Size of Pipe
- Outside Diameter of Pipe
- Dimensions of fitting to restrain or restrain over
- Material of construction
- Pressure rating requirements
- Number & Size of restraining tie rods
- Mating Third Party Restrainer - manufacturer or bolting pattern/size
- Any special coatings, materials or customer required modifications

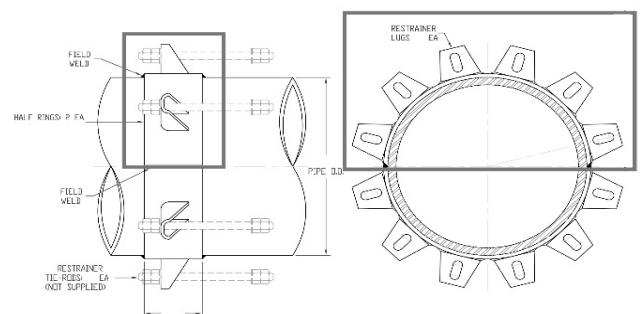

**Price on Application - contact JCM Industries Sales Team**

# JCM 650 HDPE Mechanical Wall Anchor Restraint

## Bi-Directional Lateral Restraint of HDPE Pipe

BIDIRECTIONAL RESTRAINT - Two-way serration system to counteract lateral pipe movement from either direction. Serrated Restraint - prevents both push/pull-back and radial slipping of the pipe. Serrations are designed to bite into the exterior pipe wall without damaging the pipe.

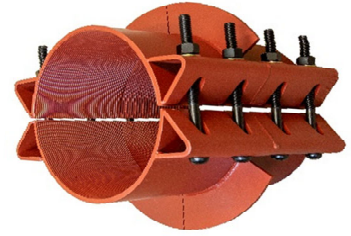

Nom Size (IN)	Pipe OD Size (A)	Body Plate Thickness (B)	Body Width (C)	Qty & Ring Thickness (D)	Number of Bolts (E)	Size of Bolts (E)	List Price (EA)
12	1320	3/8	16	4-5/16	8	3/4	P.O.A.
12	1275	3/8	16	4-5/16	8	3/4	P.O.A.
14	1400	3/8	10	4-5/16	8	1	P.O.A.
14	1530	3/8	10	4-5/16	8	1	P.O.A.
16	1600	3/8	10	6-5/16	8	1	P.O.A.
16	1740	3/8	10	6-5/16	8	1	P.O.A.
18	1800	3/8	10	6-5/16	8	1	P.O.A.
18	1950	3/8	10	6-5/16	8	1	P.O.A.
20	2000	3/8	14	8-5/16	8	1	P.O.A.
20	2160	1/2	14	8-3/8	12	1	P.O.A.
20	2200	1/2	14	8-3/8	12	1	P.O.A.
24	2400	1/2	14	10-3/8	12	1	P.O.A.
24	2480	1/2	14	10-3/8	12	1	P.O.A.
24	2580	1/2	14	10-3/8	12	1	P.O.A.
26	2600	1/2	14	10-3/8	12	1	P.O.A.
27	2700	1/2	14	12-3/8	12	1	P.O.A.
30	3000	1/2	20	12-3/8	16	1	P.O.A.
30	3200	1/2	20	12-3/8	16	1	P.O.A.
36	3600	1/2	20	14-3/8	16	1	P.O.A.
36	3830	1/2	20	16-3/8	16	1	P.O.A.

Dimensions shown in inches (IN)





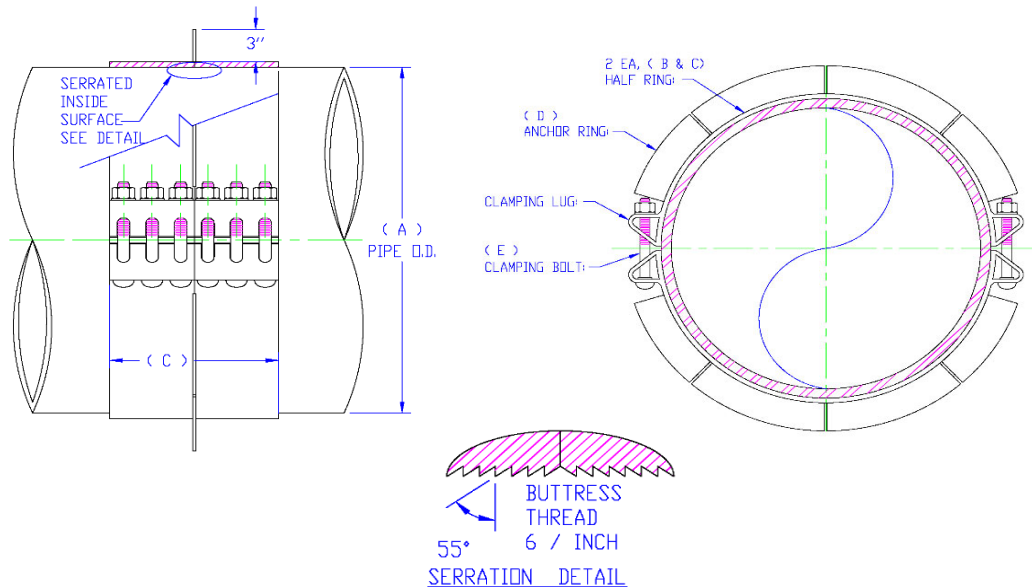

JCM 650 Priced on Application - Call 1-800-527-8482

### OPTIONS

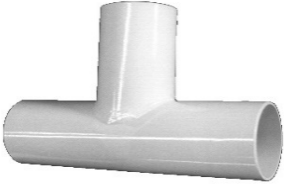
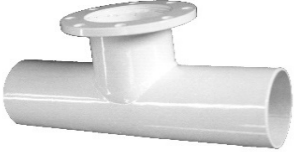
- Carbon Steel
- Shopcoat
- Epoxy
- Stainless Steel
- 304 or 316
- Hardware Options
- Alloy
- 304 Stainless
- 316 Stainless

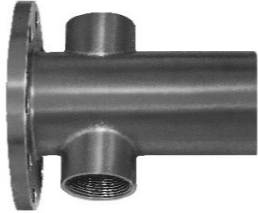

## JCM Fabricated Spools and Bypass Tees

<p><b>820</b></p>  <p><b>822</b></p>  <p><b>823</b></p> 	<p><b>820 Fabricated Plain End Tee</b>  <b>822 Fabricated Flanged x Plain End Tee</b>  <b>823 Bypass Tee (Flg x Flg x Flg)</b>          Sizes 3" and Larger, Available size on size and reducing</p> <p>Custom fabricated tees for cutting in services, replacing existing piping and for installing bypasses. The ability to meet exact length requirements, epoxy coated for extra corrosion resistance and quick shipment make these tee's real problem solvers.</p> <p>How To Order</p> <ol style="list-style-type: none"> <li>1. Determine Nominal Pipe and Flange Size</li> <li>2. Determine Outlet Tee/ Flange Size</li> <li>3. Determine Exact Laying Length Requirements</li> </ol> <p>Example: Flange x Flange Bypass Tee          6" Nominal Run with 4" Flanged Outlet, 10" in Length          Part Number: 823-6 x 6 x 4 x 10</p>
<p><b>831</b></p>  <p><b>832</b></p> 	<p><b>831 Flange x Flange Spool with Test Outlets</b>  <b>832 Flange x Flange Spool without Test Outlets</b>          Sizes 3" and Larger, Available size on size and reducing          Ideal for installing new meters and equipment where the laying length of the new equipment is shorter than the equipment being replaced. These flanged spools can make up the difference and add test outlets if necessary. Custom fabrication allows exact length requirements to be met.</p> <p>How To Order</p> <ol style="list-style-type: none"> <li>1. Determine Nominal Pipe and Flange Size</li> <li>2. Determine Size and Quantity of Test Outlets (for 831)</li> <li>3. Determine Exact Laying Length Requirements - minimum length available:</li> </ol> <p>Size on Size: 3" nominal size - 5-3/4", 4" - 12" nominal size - 6-3/4"          Example: 6" Nominal run with two (2) 3/4" Test Outlets, 10" in Length          831 Part Number: 831-6 x 6 x 3/4" x 10 with two (2) Test Outlets          832 Part Number: 832-6 x 6 x 10</p>
<p><b>833</b></p>  <p><b>834</b></p> 	<p><b>833 Flange x Plain End Spool with Test Outlets</b>  <b>834 Flange x Plain End Spool without Test Outlets</b>          Sizes 3" and Larger, Available size on size and reducing          Ideal for use on installations requiring field fit up. Plain end accommodates a flexible coupling for easy adjustment.</p> <p>How To Order</p> <ol style="list-style-type: none"> <li>1. Determine Nominal Pipe and Flange Size</li> <li>2. Determine Size and Quantity of Test Outlets (for 833)</li> <li>3. Determine Exact Laying Length Requirements - minimum length available:</li> </ol> <p>Size on Size: 3" nominal size - 8-3/4", 4" - 12" nominal size - 9-3/4"          Example: 6" Nominal run with two (2) 3/4" Test Outlets, 10" in Length          833 Part Number: 833-6 x 6 x 3/4" x 10 with two (2) Test Outlets          834 Part Number: 834-6 x 6 x 10</p>

## JCM Fabricated Expansion Joints

JCM Expansion Joints permit up to 10" of concentrated pipe movement that provides for normal expansion/contraction of pipelines subject to variations of both environmental and line content temperatures. JCM Expansion Joints are manufactured using a telescoping design that consists of a fabricated steel body, or housing, that accommodates an inserted internal "slip pipe" that moves in and out of the body. This free movement absorbs the linear, or axial, movement of the section of pipe. The fabricated steel body houses a "packing" area of alternating rings of lubricated flax and rubber that provides the water tight seal during the cycling of the joint. JCM Expansion Joints offer several design options including end connections, coatings, limit rods, stainless steel fabrication and others. JCM Expansion Joints are manufactured for each specific application allowing for the incorporation of special options or engineered features required for the installation.

**Heavy Duty Construction** - The heavy duty, durable exterior body provides the protective shell for the slip pipe and packing system. For corrosive or acidic environments, the expansion joint may be epoxy coated or fabricated of stainless steel.

**Externally Guided Slip Pipe** - The machined slip pipe furnishes a hard, corrosion resistant surface that reduces friction between the slip pipe and packing material. For corrosive environments or line contents, slip pipe is fabricated of stainless steel.

**Adjustable Packing Gland** - Alternating rings of lubricated flax and rubber are packed tightly into the packing area of the body by the adjustable packing gland. This packing gland maintains a consistent compression of the flax/rubber rings to ensure a tight, leak proof seal between the slip pipe and body.

**Lubricated Packing** - The rings of lubricated flax provide the "lubrication" to the slip pipe ensuring a smooth expanding/contracting movement while the square rubber rings secure the water tight seal. This packing area is easily accessible, without disruption of service, should repacking be required.

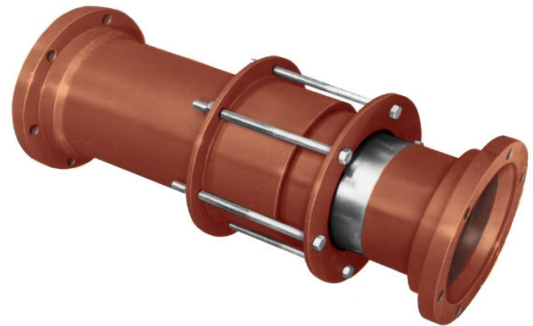

**How to Order** - For price and availability, the following information must be furnished

- Type of pipe
- Outside diameter of pipe
- Type of End Connections
- Line Contents
- Minimum and maximum temperatures
- Maximum working pressure
- Material and Coating specifications

JCM 802 Double End Expansion Joints are designed for special applications such as middle of line use where expansion joint body can be anchored. This fitting permits up to 10" total pipe movement, 5" on each end, with properly anchored body.

### Material Specifications

- Body Material:** ASTM A36 Carbon Steel or equal
- Body Flange:** ASTM A36 or equal
- Slip Pipe:** 18-8 Type 304 Stainless Steel per ANSI/AWWA C220, as applicable.
- Packing Gland:** ASTM A36, ASTM A285 Grade C, ASTM A53B or equal.
- Gasket and Flax:** Square packing Buna-N rubber, per ASTM D2000, 55 - 60 durometer, compounded for use with water, salt solutions, mild acids, bases and sewage. Flax: Gurlock waxed, braided cord (hemp).
  
- Bolts:** ASTM A193 B7, ASTM A194/ASTM A563 or Stainless Steel ASTM A193 B8/B8M, 304SS/316SS
- Limit Rods:** ASTM A193 B8/B8M/B7 or equal.
- Finish:** Heavy coat of corrosion resistant primer.

Meets or exceeds ANSI/AWWA C221 Fabricated Steel Mechanical Slip-Type Expansion Joints

## JCM Fabricated Expansion Joints

JCM Expansion Joints are available as Model 801 Single End design or Model 802 Double End Expansion Joint and are available with the following options:

- (1) Weld-On Ends without Limit Rods
  - (2) Weld-On Ends with Limit Rods
  - (3) Flanged Ends without Limit Rods
  - (4) Flanged Ends with Limit Rods
  - (5) Mechanical Joint Ends without Limit Rods
  - (6) Mechanical Joint Ends with Limit Rods
- Other end connections available  
Increased or decreased amounts of pipe movement capability

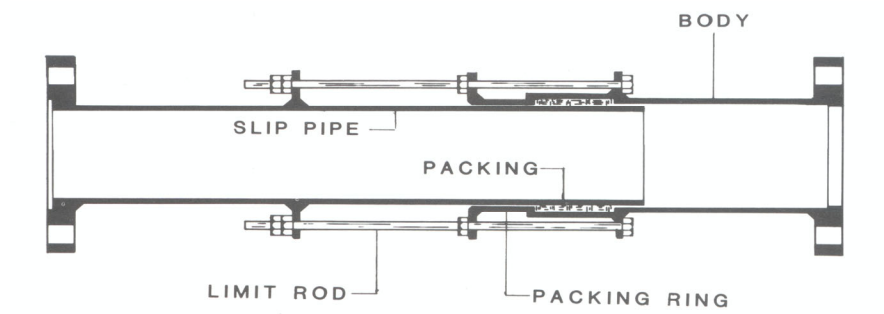

**JCM 801 Single End Expansion Joint**

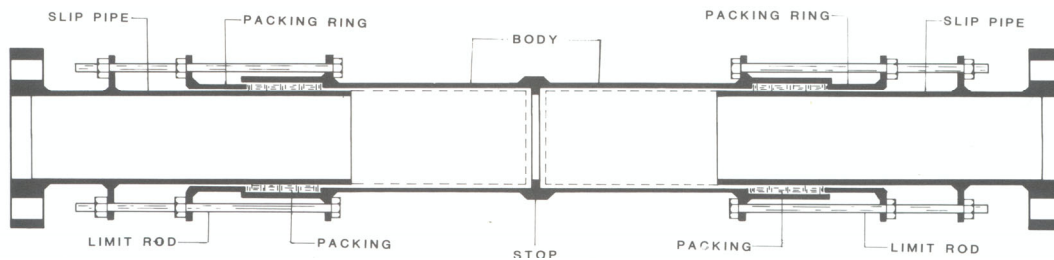

**JCM 802 Double End Expansion Joint**

### JCM Expansion Joint - Typical Specifications

Expansion Joints shall be of the externally guided, slip joint type, permitting up to 10" of concentrated pipe movement. The packing gland shall have alternate rings of lubricated flax and rubber specially compounded for use with water, salt solutions, mild acids, bases, natural gas and sewage. The body of the expansion joint shall have a shop coat primer. The slip pipe shall be stainless steel. Expansion Joints shall be JCM 801 or approved equal.



### JCM 900 Series Wrenches

Catalog Number	Socket Sizes	List Price Each	Nominal Nut Size	Length	Appr Wt Each Lbs
901	1-1/4" X 1-1/16"	\$ 161.00	3/4" & 5/8" HH	17"	2
902	7/8" X 3/4"	68.00	1/2" & 7/16" HH	9-1/4"	0.3
903	3/4" X 11/16"	67.00	7/16" & 3/8" HH	9-1/4"	0.3
904	1-1/8" X 15/16"	161.00	3/4" & 5/8" STD. HEX	17"	2

### JCM 900 Master Wrench Set

Catalog Number	Includes Wrench Models	List Price Each	Appr Wt Each Lbs
900	901, 902, 903, 904	\$ 422.00	20

### JCM 900 Series OD Tape and Deep Well Sockets

Catalog Number	Description	List Price Each	Appr Wt Each Lbs
920	10' Pipe Diameter Tape	\$ 27.00	0.3
910	Socket Set	284.00	7
911	15/16" Socket Only	87.00	1
912	1-1/16" Socket Only	89.00	1.5
913	1-1/8" Socket Only	92.00	1.75
914	1-1/4" Socket Only	94.00	2
906	Universal Hydrant Wrench	91.00	10

900

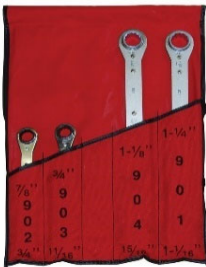

920



910



901, 904, 902, 903

906



JCM Industries Product Description	Smith-Blair	Dresser	Ford Meter Box	Romac	PowerSeal	Mueller	Cascade
REPAIR FITTINGS							
101 UCC - Standard Range	226	360	F1	CL1	3121	500	CDR1
102 UCC - Extended Range	227, 228	361	F2, F3	CL2, CL3	3122	510	CDR2 -3
103 Tapped UCC - Std. Range	238	360	F1	CL1	3131	501-509	CDRT
104 Tapped UCC - Ext. Range	239	361	F2, F3	CL2, CL3	3132	511, 519	CDR2T
131 All Stainless Steel UCC - Std. Range	256	364	FLS1	*SS1			
132 All Stainless Steel UCC - Ext. Range	257	360	FLS2	*SS2, *SS3			
133 Tapped All Stainless UCC - Std. Rng.	264			*SS1			
134 Tapped All Stainless UCC - Ext. Rng.	265			*SS2, *SS3			
136 Heavy Duty Stainless Repair Clamp	268				3122AS-HP	3122AS	
161 All SS Fabricated Clamp	261	8364	FS1	SS1	3121AS	540	CR1
162 All SS Fabricated Clamp - Ext. Rng.	262		FS2	SS2	3122AS		CR2
168 - 169 SS Fabricated Lightweight Clamp				LSS1, LSS2	3121ASLW		CSS1, CSS2
SERVICE SADDLES - TAPPING SLEEVES							
105 PVC Collar Leak UCC	229		FCC	CLC	3141	773	CCLC
106 Bell Joint - IPS PVC			FBC	517			
108 UCC Sewer Pipe				LSS1	3541		
110 Patch Clamp	245	118	FSLC	SC	3151A	220-221	
111 Full-Repair Clamp	244		FLSC-R	SCC	3152	230, 231	CFC
112 Heavy Duty Patch Clamp					3151HD	220	
113 Heavy Duty Patch Clamp	246	77, 79					
114 Mechanical Joint Repair Sleeve							
116 Repair Slv for CSCP							
143 Bell Joint Clamp - DI, CI, C-900 PVC	274		FBC	416, 516	3231, 3232		
159 Abandoned Corp Cap Sleeve			FACC		3436AS		CCAP
COUPLINGS - FLANGED ADAPTERS							
201 Steel Coupling	411 Reg	38	FC3-7	400	3538	MAXI	
202 Long Steel Coupling	411 Long	40	FLC	-	3540		
203 Steel Transition Coupling	413	162	FC5	TC400			
204 Steel Reducing Coupling	415	62	FC6	RC400	3562		
210 Ductile Iron Coupling	441	253, 153	FC1	501			CR CER
211 Ductile Iron Cplg - Stl, IPS PVC			FC1	501			
212 Ductile Iron Transition Cplg	433		FC2	501	3501		
214 Pipe End Cap Coupling	481, 482	31	FEC	EC501	3501EC		
215 Long Ductile Iron Couplings	442			501	3501LB		
219 Restrained Ductile Cplg							
220 Compression Coupling	525	65		702	3504		
225 Insulating Adapter Gasket		3065					
230 HDPE Pipe Stiffener			INSERT	206	3530		CPS
241 Standard - Optimum Coupling	461		FC2W	XR501	3506		
242 Long - Optimum Coupling	462		FC2W	XR501			
250 Mechanical Joint Coupling			MJC				



301 Cast Flanged Coupling Adapter	912	127	FFCA	FCA501	3521		CRFAER
303 Fabricated Flg Cplg Adapter	913	128	FCA	FC400	3528		
304 Reducing Fabricated FCA	914	128	FCA	FC400			
306 Fabricated FCA	913	128					
307 Reducing Fabricated FCA	914	128			3506R		
309 Fabricated Dismantling Joint	971		FDJ	DJ400-05	3563		
SERVICE SADDLES - TAPPING SLEEVES							
401 Single Strap Service Saddle	311	291	F101	101		DR1A	
402 Double Strap Service Saddle	313	291	F202	202		DR2A	
403 Wide Body Service Saddle - SS Strap	315	194		101S		DR1S	
404 Service Saddle - Double SS Straps	317		FS202	202S		DR2S	
405 Ctd Wide Service Saddle - SS Strap	315		FC101	101N	3415		CNS1
406 Ctd Service Saddle - Dbl SS Straps	317		FC202	202N	3417DI		CNS2
407 Ctd ServSdl - Electro Galv Strap	311			101NU	3411DI		CDS1
408 Ctd Serv Sdl - Dbl Elctro Galv Straps	313			202NU	3413DI		CDS2
502 Stainless Steel Service Saddle	372		FS313	306	3412AS		
411 Fab Tapping Sleeve - Plain End Outlet							
412 Fab Tapping Sleeve - Flanged Outlet	622	610	FTS	FTS420	3460		CFT
419 Fab Tap Slv - Mechanical Joint Outlet	622MJ				3460MJCS		
422 Fab Tapping Sleeve for PVC/Stl/HDPE		615		FTS419		*H612	CFTLP
429 Fab Tap Slv - PVC/Stl/HDPE - MJ Outlet							
414 Fab Mechanical Joint Tapping Sleeve	*623			*FTS425		*H615	
415 Tap Slv for CSCP	625			FTS435			
416 Fab Weld-On Tapping Outlet - Partial	626		FWS	FTS445	3428		CFT-WO
417 Fab Weld-On Tapping Sleeve	627				3428		
418 Fab Threaded Outlet Tap Slv	366						CFTTO
425 Service Saddle for CSCP	362				3465CS		
432 All Stainless Steel Tapping Sleeve	665	630	FTSS	SSTIII	3490AS	H304	CSTEX
438 All SS Threaded Outlet Tap Slv				STS420T			
439 All SS Tap Slv - MJ Outlet	665MJ			SST-MJ	3490MJAS		
440 Line Stop Fitting	680	640		*SST-X			
452 All SS Tap Slv - Outlet Seal Gasket			FTSAS	STS420	3460AS	*H300	CFTSS
462 All SS Tap Slv - Carbon Steel Flange	664	630	FTSS	SSTIII	3490CS	H304	
464 SS Tap Slv - Outlet Gskt - Carbon Flg			FTSAS				
465 SS Tap Slv - Outlet Seal Gskt - Carbon MJ	664MJ						
469 SS Tap Slv - Full Gskt- Carbon MJ			FTSAS	SST-III-MJ	3490MJCS		
459 All SS Tapping Sleeve - MJ Outlet			FTSAS		3460ASMJ		
FABRICATIONS							
801 Expansion Joint - Single End	611	63	FEJ 1	EJ400	3563		
802 Expansion Joint - Double End	612	63	FEJ 2	EJ400	3563		
	Smith-Blair	Dresser	Ford Meter Box	Romac	PowerSeal	Mueller	Cascade



# Pipe Outside Diameter Guide

**IMPORTANT:** This Pipe O.D. Guide is furnished for your convenience and is based on the latest pipe standards and information supplied by pipe manufacturers. Due to occasional changes and variances in outside diameters, the pipe O.D. should always be verified before ordering fittings.

## SMALL DIAMETER PIPE SIZES

NOMINAL PIPE SIZE (INCHES)	1/2	3/4	1	1-1/4	1-1/2	2	2-1/2
COPPER TUBING	.63	.88	1.13	1.38	1.63	2.13	2.63
STEEL & PLASTIC PIPE	.84	1.05	1.32	1.66	1.90	2.38	2.88

## STANDARD PRESSURE PIPE SIZES

NOMINAL PIPE SIZE (INCHES)	3	4	5	6	8	10	12	14	15	16	18	20	24	30
COPPER TUBING	3.13	4.13	5.13	6.13										
STEEL & PLASTIC PIPE (SDR 26,21 & SCHEDULE)	3.50	4.50	5.56	6.63	8.63	10.75	12.75	14.00		16.00	18.00	20.00	24.00	30.00
PLASTIC IRRIGATION PIPE (PIP)		4.13		6.14	8.16	10.20	12.24		15.30		18.70	22.05	24.80	
PLASTIC SEWER PIPE (SDR 35)		4.22		6.28	8.40	10.50	12.50		15.30		18.70		24.80	
PLASTIC (PVC) AWWA C-900/C-905/C-909		4.80		6.90	9.05	11.10	13.20	15.30		17.40	19.50	21.60	25.80	
POLYETHYLENE PIPE (IPS SIZE)	3.50	4.50		6.63	8.63	10.75	12.75	14.00		16.00	18.00	20.00	24.00	30.00
POLYETHYLENE PIPE (DIP SIZE)		4.80		6.90	9.05	11.10	13.20	15.30		17.40	19.50	21.60	25.80	32.00

DUCTILE IRON PIPE	3.96	4.80		6.90	9.05	11.10	13.20	15.30		17.40	19.50	21.60	25.80	32.00	
CAST IRON	CLASS 100 - 250 AWWA	3.96	4.80		6.90	9.05	11.10	13.20	15.30		17.40	19.50	21.60	25.80	32.00
	CLASS A AWWA PIT CAST	3.80	4.80		6.90	9.05	11.10	13.20	15.30		17.40	19.50	21.60	25.80	31.74
	CLASS B AWWA PIT CAST	3.96	5.00		7.10	9.05	11.10	13.20	15.30		17.40	19.50	21.60	25.80	32.00
	CLASS C - D AWWA PIT CAST	3.96	5.00		7.10	9.30	11.40	13.50	15.65		17.80	19.92	22.06	26.32	

ABESTOS CEMENT PIPE	Class 100	MACHINED END	3.74	4.64		6.91	9.11	11.24*	13.44*	15.07		17.15	19.90	22.12	26.48	33.12	
		FLINTITE ROUGH BARREL	3.94	4.90		7.13	9.33	11.30	13.42	15.45		17.60					
		FLUID-TITE ROUGH BARREL	3.93	5.05		7.16	9.32	11.46	13.70	15.36		17.50	20.44	22.50	27.17		
		PERMAFLEX ROUGH BARREL		4.84		7.15	9.35	11.47	13.74	15.55		17.55	20.50	22.70	27.15		
		RING-TITE ROUGH BARREL	3.95	4.92		7.19	9.39	11.47	13.74	15.51		17.65	20.44	22.68	27.12	33.80	
		MIN. STD. ROUGH BARREL		4.79		7.05	9.22	11.25	13.37	15.36		17.50					
		MAX. STD. ROUGH BARREL		5.26		7.40	9.57	11.77	14.04	15.80		17.94					
	Class 150	MACHINED END	3.84	4.81		6.91	9.11	11.66	13.92	16.22		18.46	20.94	23.28	27.96	35.00	
		FLINTITE ROUGH BARREL	4.40	5.06		7.13	9.33	11.88	14.14	16.48		18.72					
		FLUID-TITE ROUGH BARREL	4.03	5.14		7.12	9.32	11.85	14.11	16.41		18.65	21.20	23.54	28.22		
		PERMAFLEX ROUGH BARREL		5.00		7.20	9.40	11.92	14.20	16.50		18.75	21.30	23.64	28.32		
		RING-TITE ROUGH BARREL	4.13	5.07		7.17	9.37	11.92	14.18	16.48		18.72	21.30	23.64	28.32	35.42	
		MIN. STD. ROUGH BARREL		4.97		7.07	9.27	11.82	14.08	16.38		18.62					
		MAX. STD. ROUGH BARREL		5.32		7.37	9.62	12.12	14.38	16.73		18.97					
	Class 200	MACHINED END	3.84	4.81		6.91	9.11	11.66	13.92	16.22		18.46	22.18	24.66	29.62	37.06	
		FLINTITE ROUGH BARREL	4.17	5.32		7.26	9.44	11.88	14.14	16.53		18.84					
		FLUID-TITE ROUGH BARREL	4.18	5.32		7.36	9.46	11.88	14.11	16.44		18.74					
		PERMAFLEX ROUGH BARREL		5.32		7.25	9.50	11.95	14.20	16.55		18.90	22.54	25.02	29.98		
		RING-TITE ROUGH BARREL	4.17	5.33		7.32	9.50	11.92	14.18	16.59		18.90	22.54	25.02	29.98	37.48	
		MIN. STD. ROUGH BARREL		5.22		7.26	9.39	11.77	14.03	16.44		18.74					
		MAX. STD. ROUGH BARREL		5.57		7.60	9.79	12.12	14.38	16.88		19.19					
	NOMINAL PIPE SIZE (INCHES)		3	4	5	6	8	10	12	14	15	16	18	20	24	30	

\* Flintite ME is 10.89 for 10" and 12.99 for 12" sizes.



**JCM INDUSTRIES, INC.**  
 P.O. Box 1220 • Nash, Texas 75569-1220  
 Call Toll Free 800-527-8482, Fax Toll Free 800-874-9524  
 Outside U.S. Call 903-832-2581, Outside U.S. Fax 903-838-6260  
[www.jcmindustries.com](http://www.jcmindustries.com)

