

Alphabet Headbands

- One sheet per child
- Print up on white card stock.
- Have children color or paint.
- Cut out both strips.
- Connect both strips to make a band.
- Fit to child's head and staple together to form a hat.
- If needed, for additional strip, cut a strip from another sheet of card stock.

(There are 2 templates for each hat. One without the words, and one with the words. Print up the template you desire).

Alphabet Hats without Words

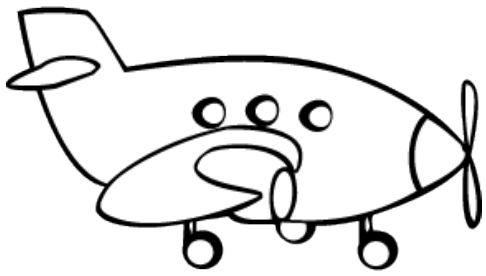

1 - 2 - 3 Learn Curriculum

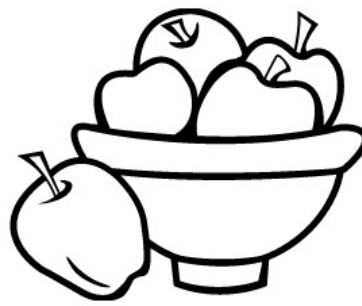

Graphics used: Graphics Factory

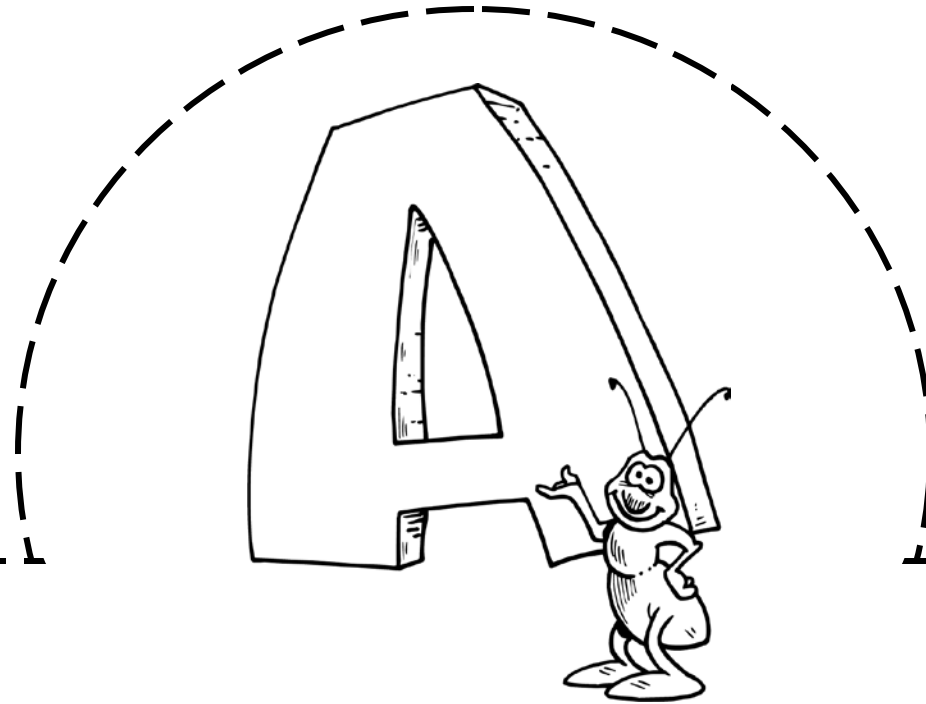
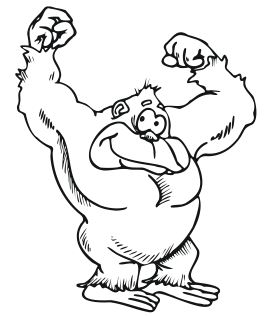

Words that start with the letter a



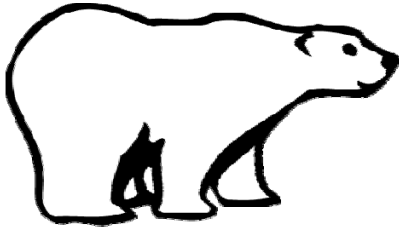

1 - 2 - 3 Learn Curriculum



Graphics used: Graphics Factory



Words that start with the letter b



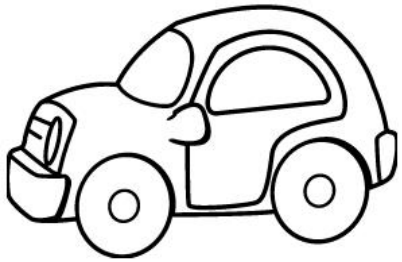

1 - 2 - 3 Learn Curriculum



Graphics used: Graphics Factory

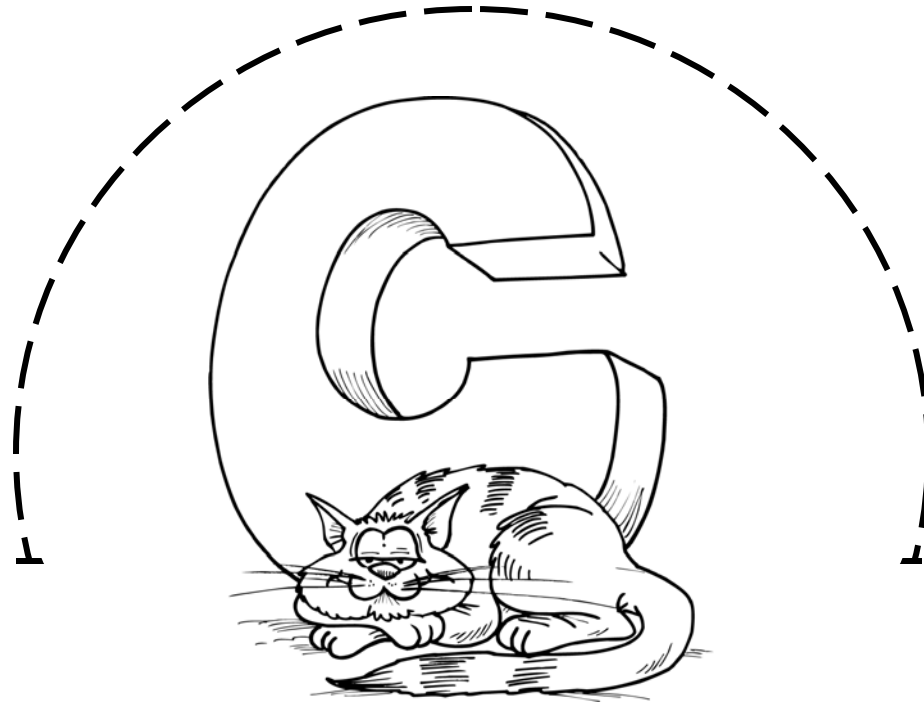
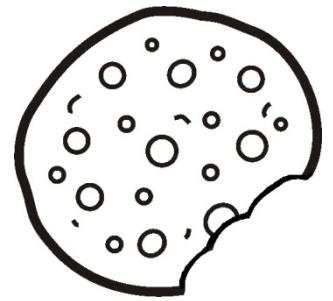

Words that start with the letter c

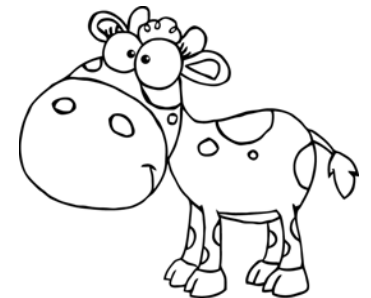



1 - 2 - 3 Learn Curriculum

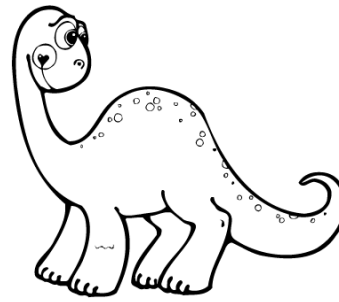

Graphics used: Graphics Factory

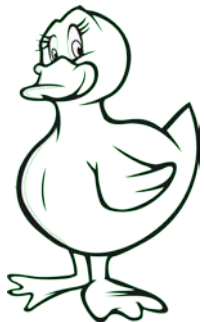
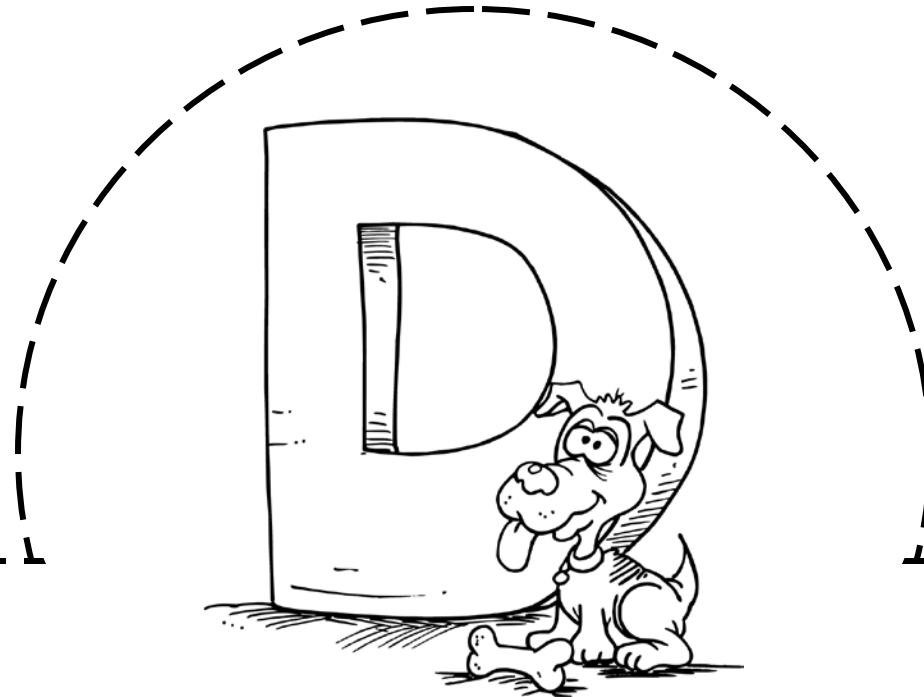

Words that start with the letter d





1 - 2 - 3 Learn Curriculum



Graphics used: Graphics Factory

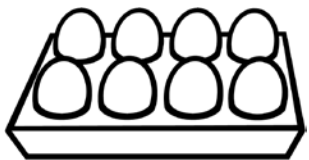
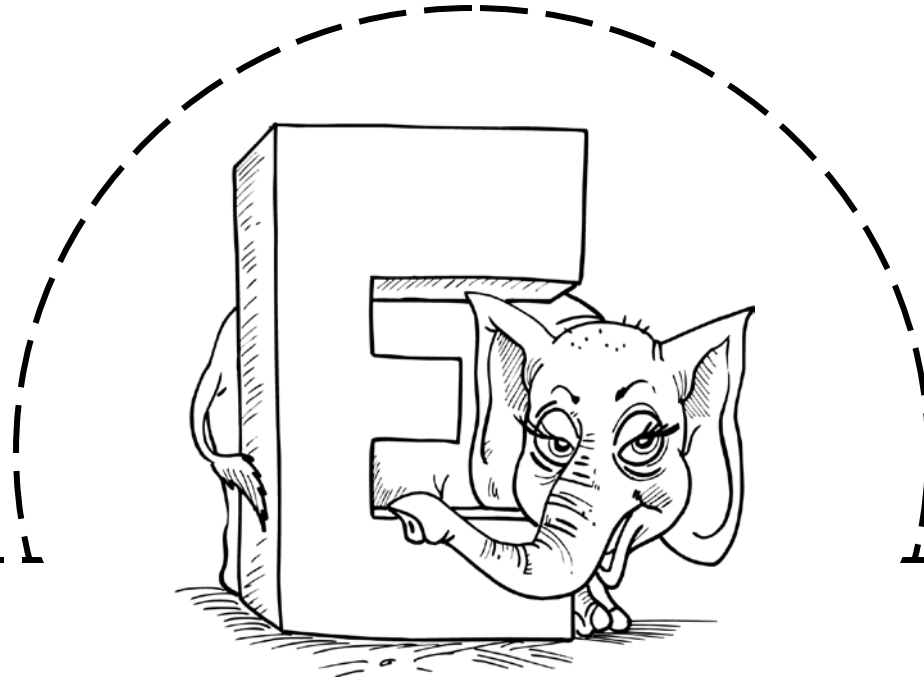
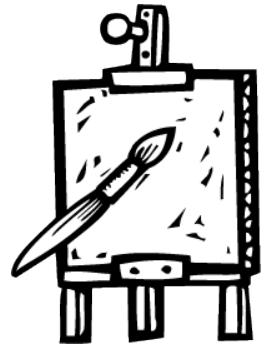

Words that start with the letter e

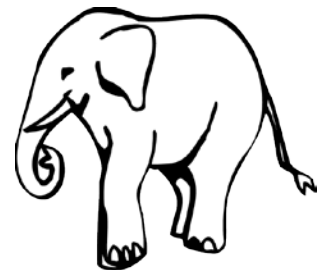

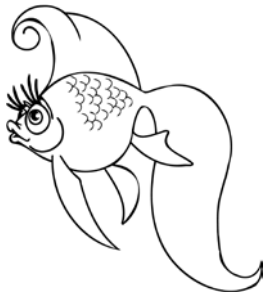

1 - 2 - 3 Learn Curriculum

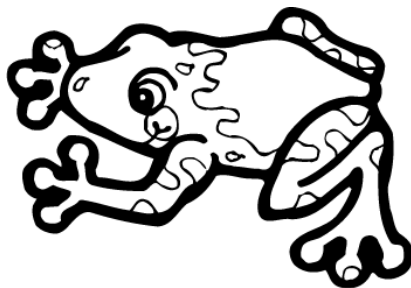

Graphics used: Graphics Factory

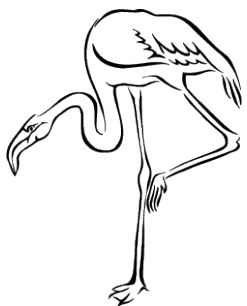
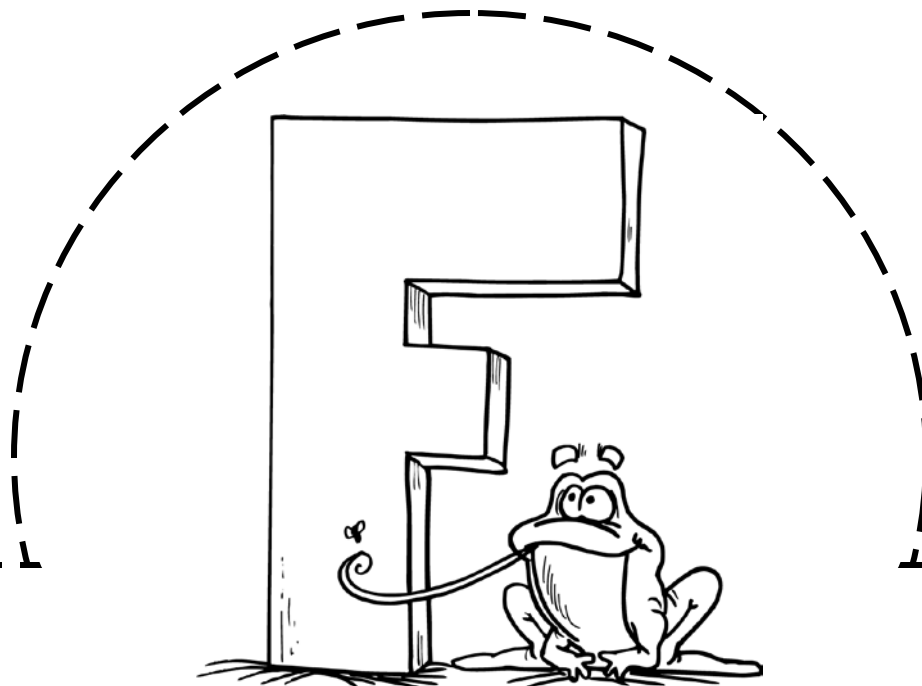
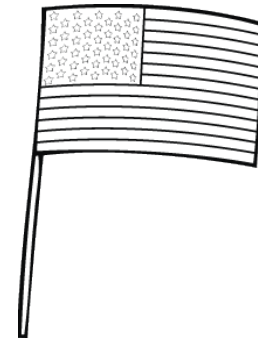

Words that start with the letter f





1 - 2 - 3 Learn Curriculum



Graphics used: Graphics Factory

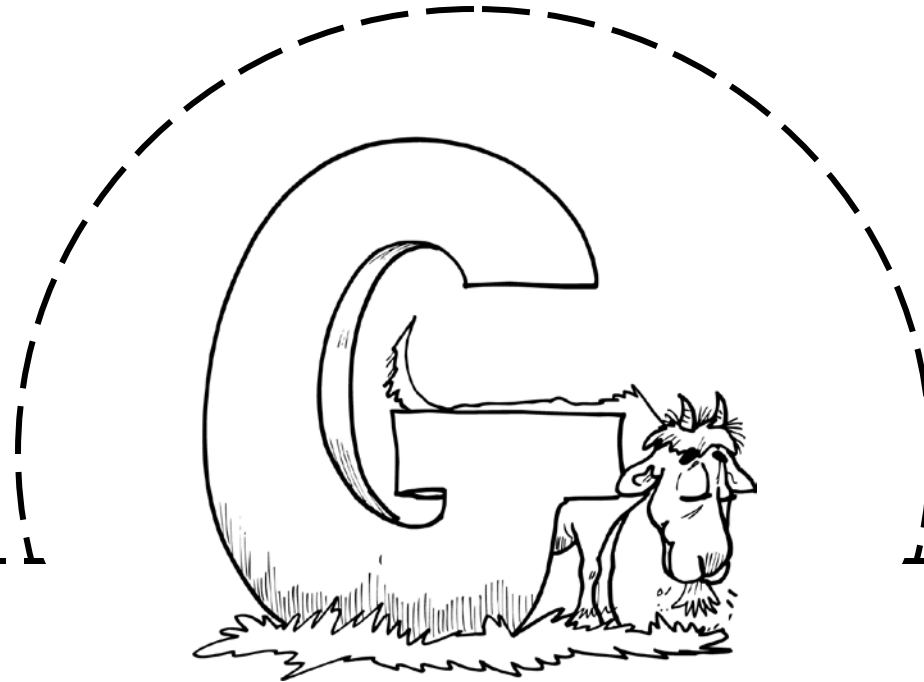
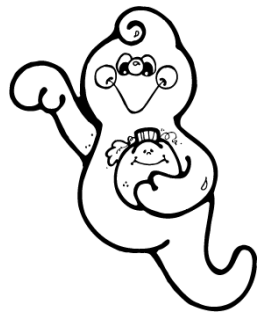

Words that start with the letter g



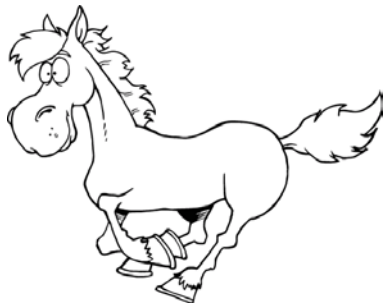

1 - 2 - 3 Learn Curriculum



Graphics used: Graphics Factory

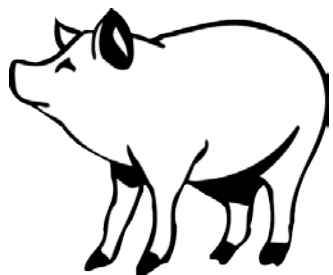
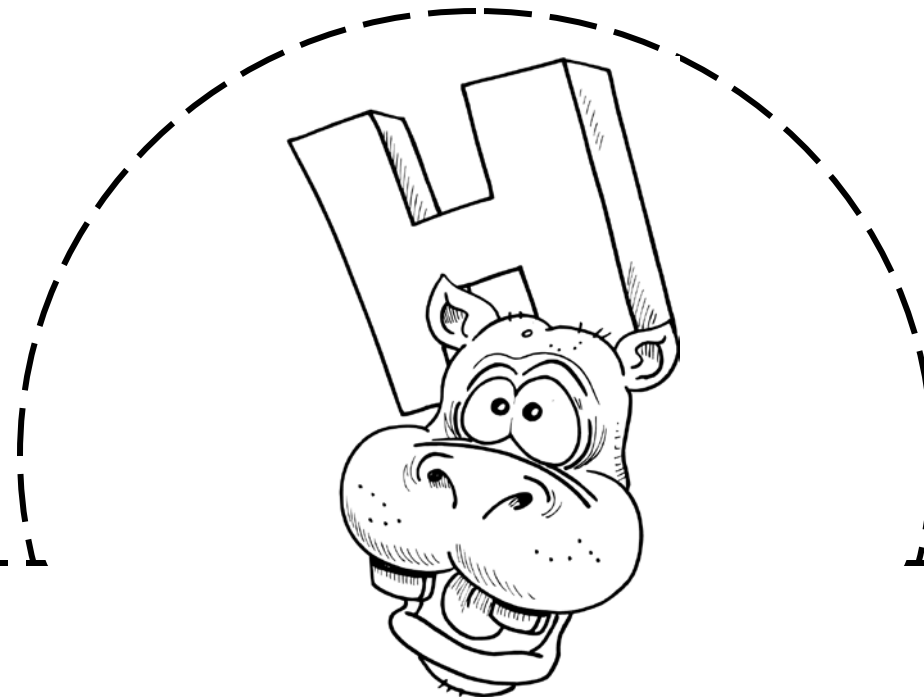

Words that start with the letter h

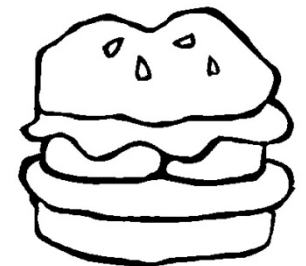

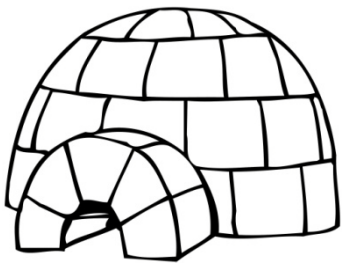

1 - 2 - 3 Learn Curriculum



Graphics used: Graphics Factory

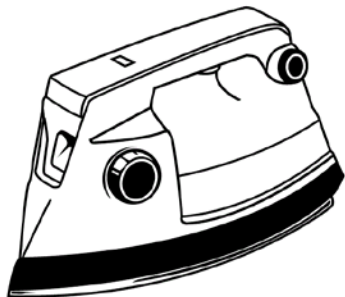
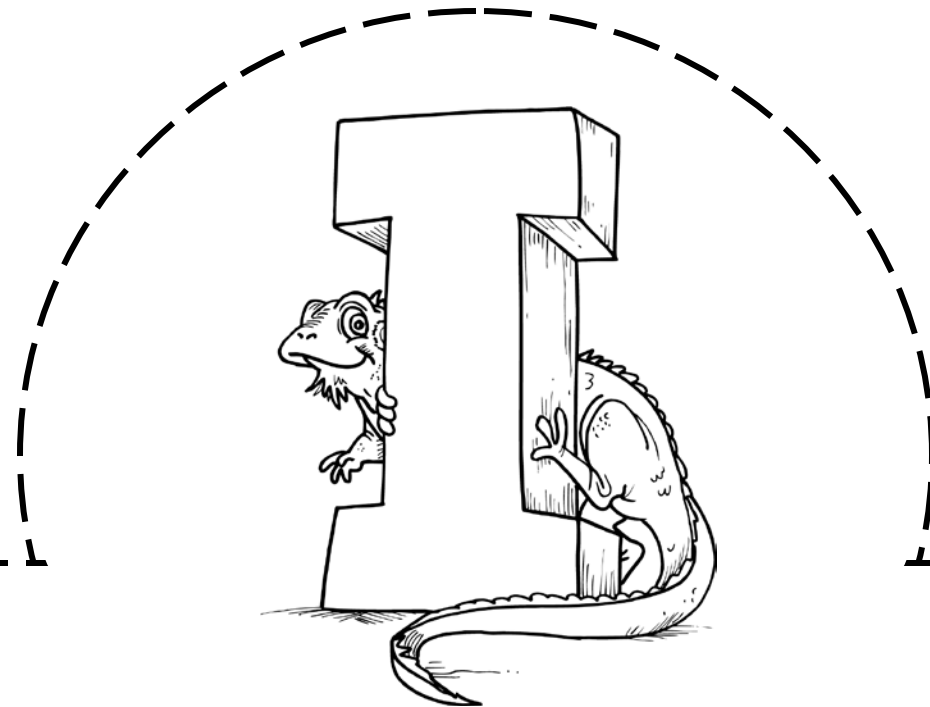
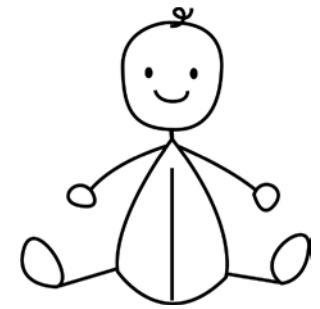

Words that start with the letter i





1 - 2 - 3 Learn Curriculum



Graphics used: Graphics Factory

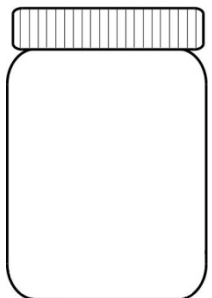
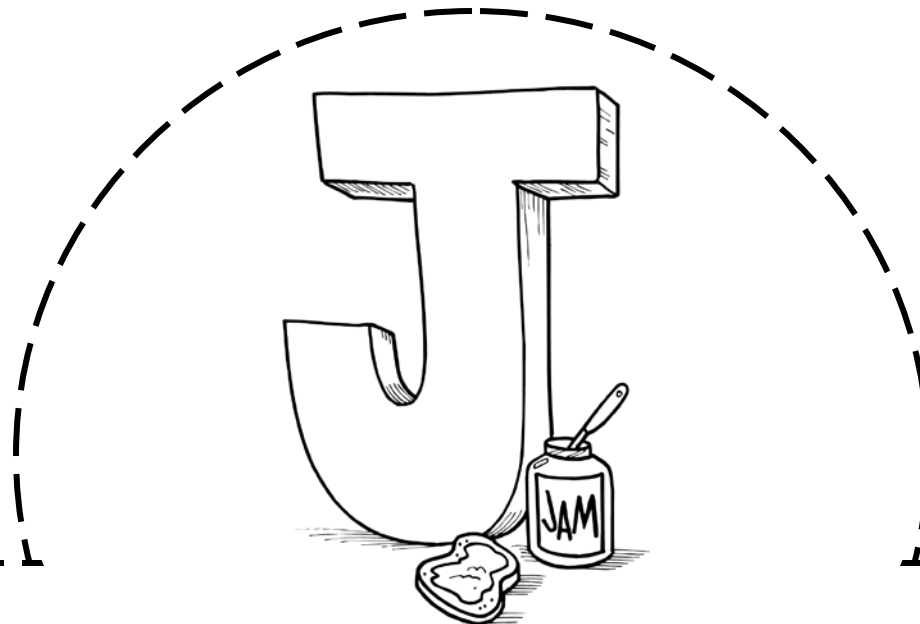

Words that begin with the letter j

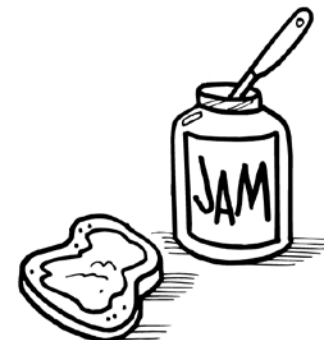

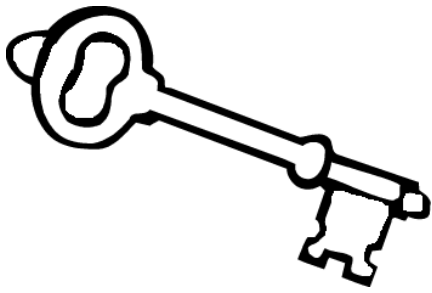

1 - 2 - 3 Learn Curriculum



Graphics used: Graphics Factory

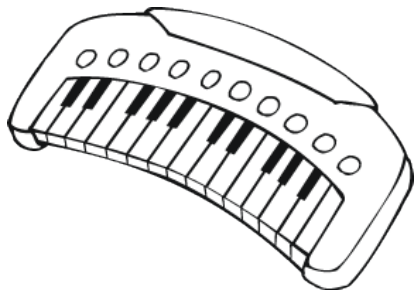
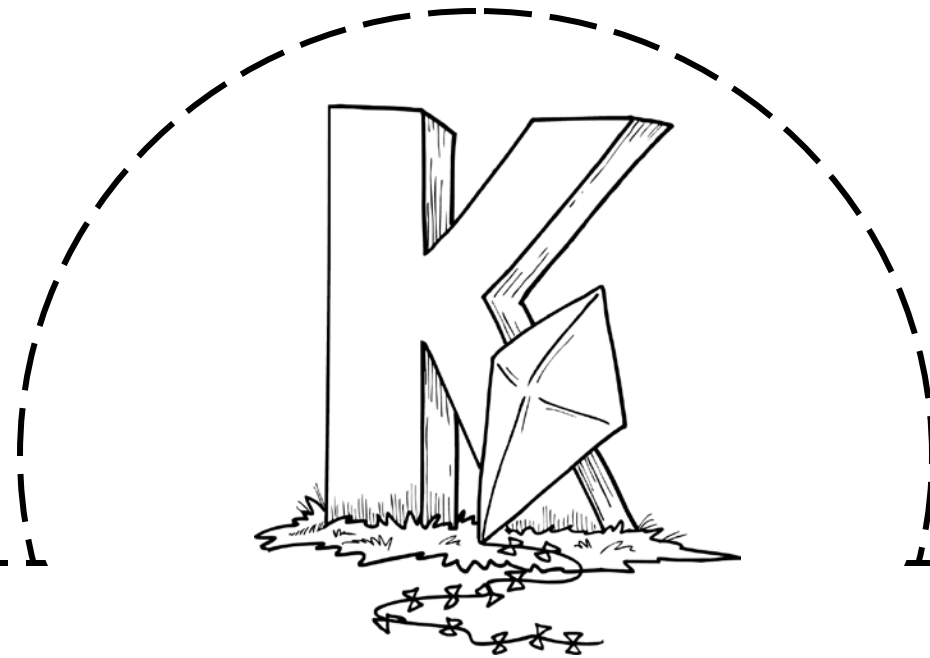
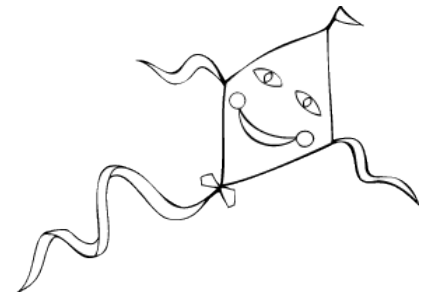

Words that begin with the letter k

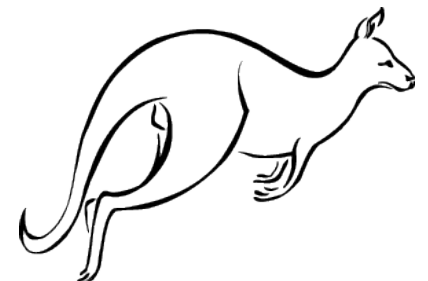

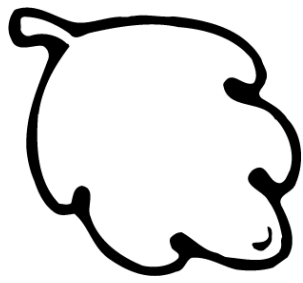

1 - 2 - 3 Learn Curriculum

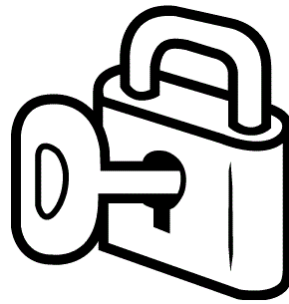

Graphics used: Graphics Factory

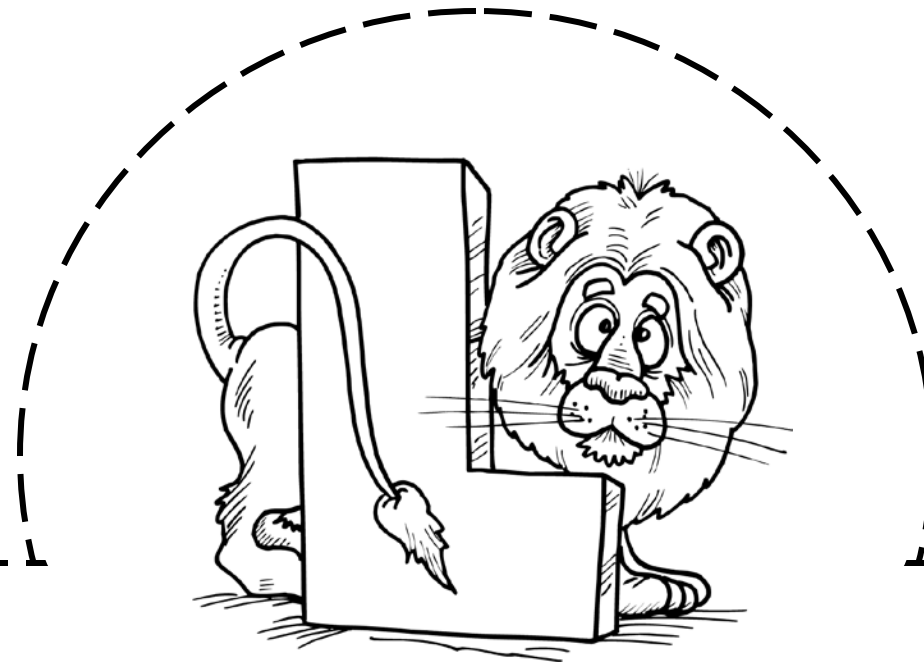
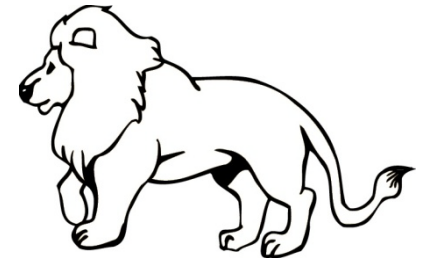

Words that begin with the letter l

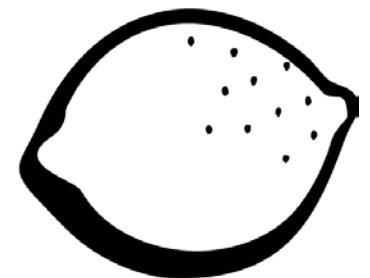



1 - 2 - 3 Learn Curriculum

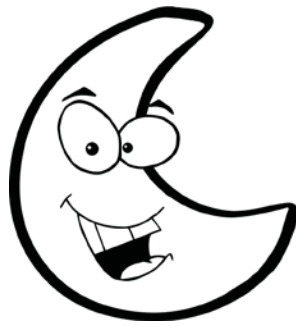

Graphics used: Graphics Factory

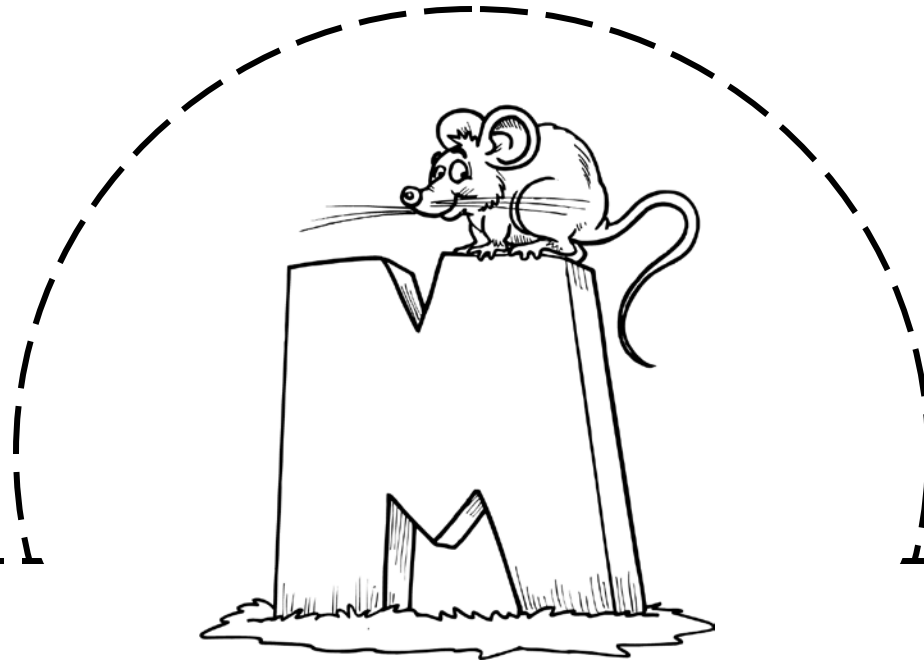

Words that begin with the letter m

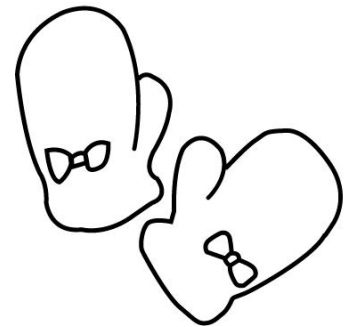



1 - 2 - 3 Learn Curriculum

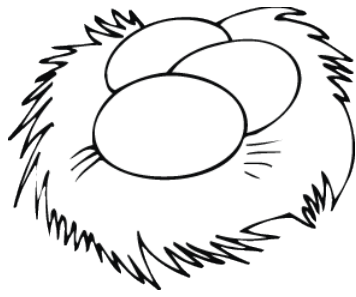

Graphics used: Graphics Factory

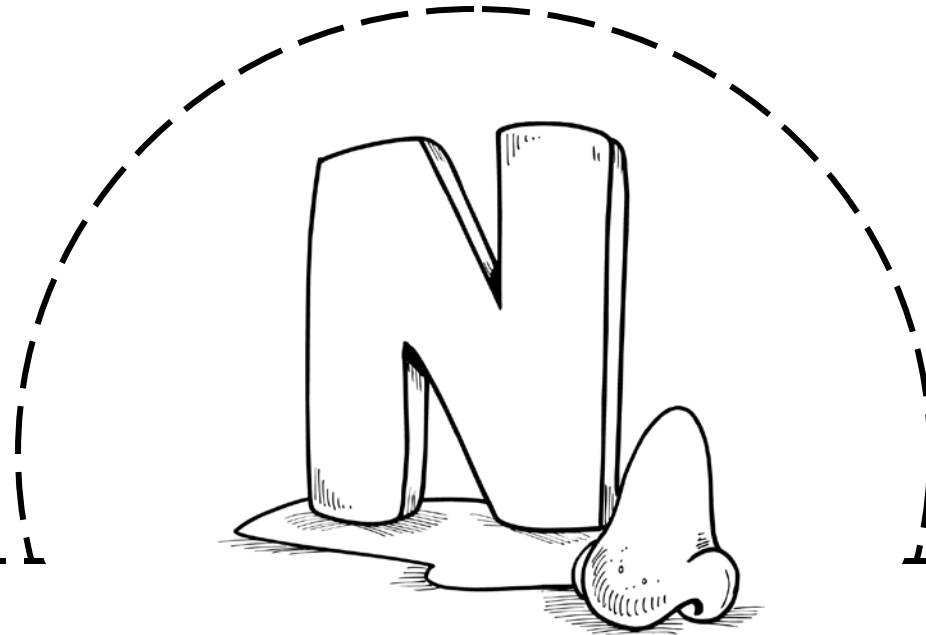
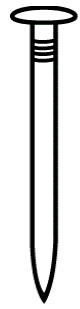

Words that begin with the letter n



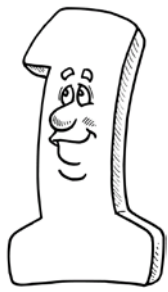

1 - 2 - 3 Learn Curriculum

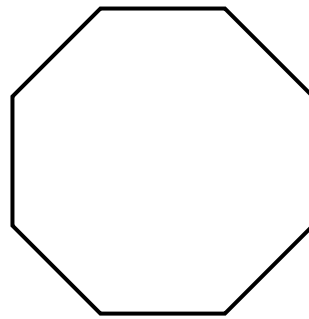

Graphics used: Graphics Factory

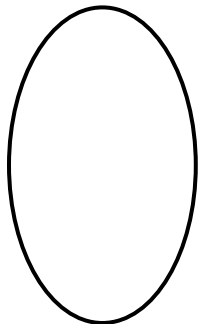
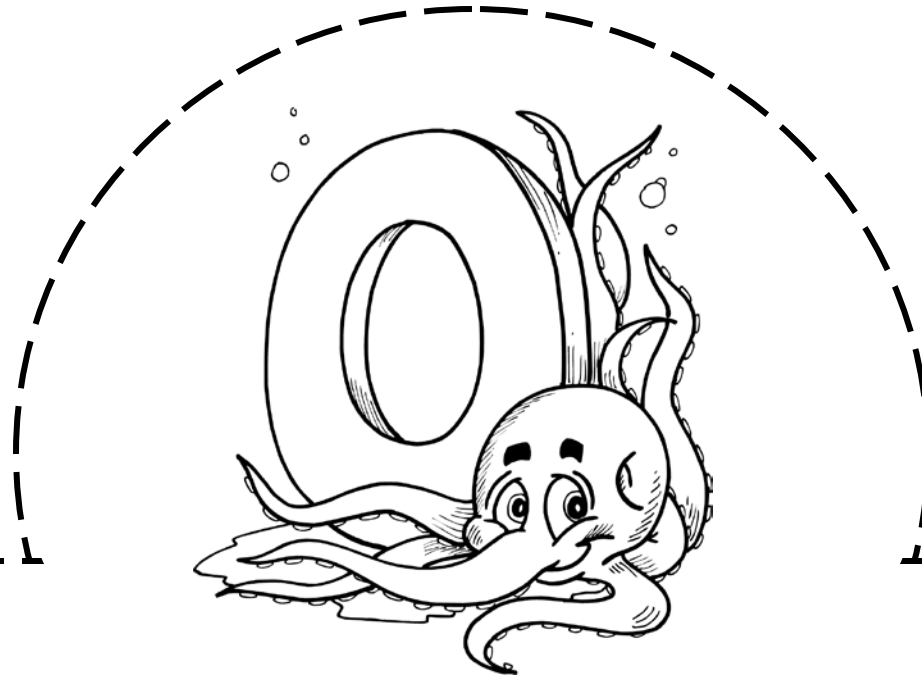
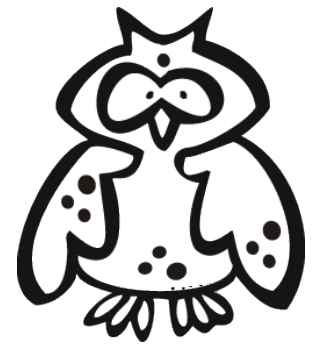

Words that begin with the letter o

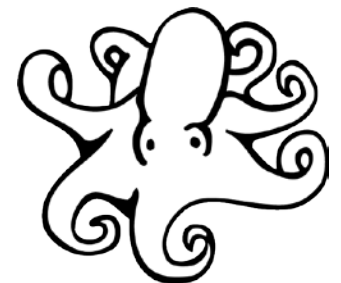

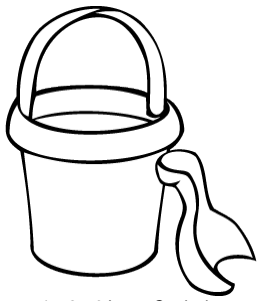

1 - 2 - 3 Learn Curriculum

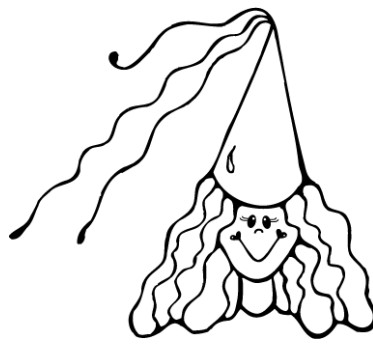

Graphics used: Graphics Factory

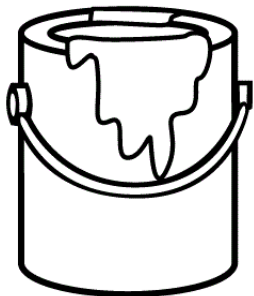
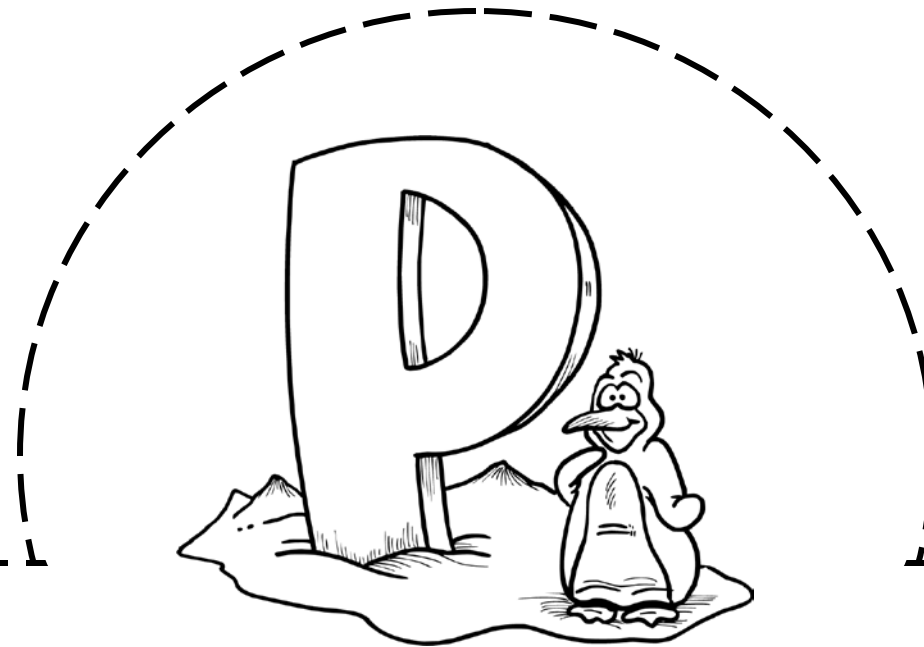

Words that begin with the letter p

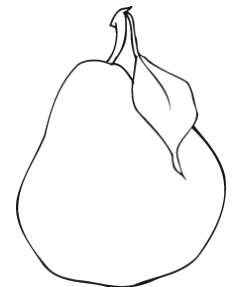



1 - 2 - 3 Learn Curriculum



Graphics used: Graphics Factory

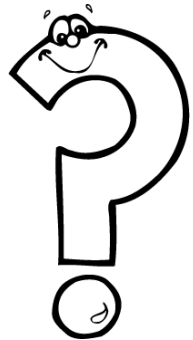

Words that begin with the letter q



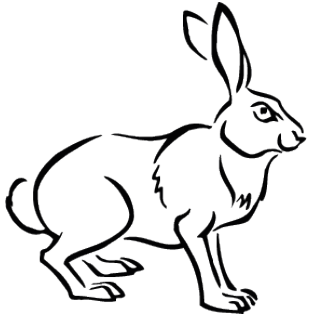

1 - 2 - 3 Learn Curriculum



Graphics used: Graphics Factory

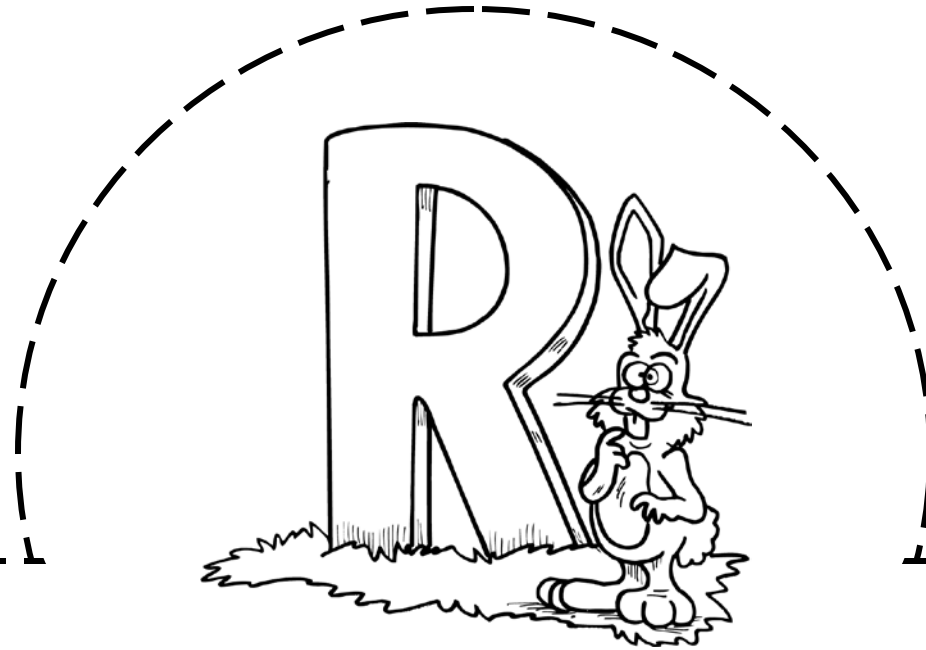

Words that begin with the letter r

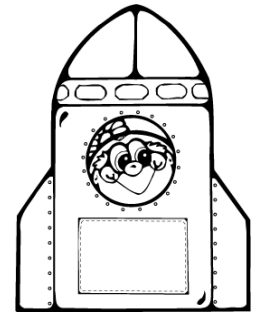

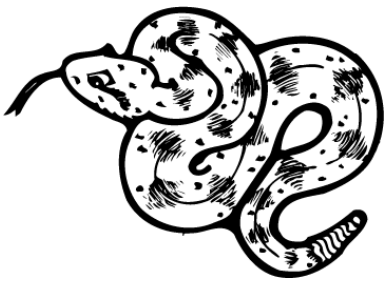

1 - 2 - 3 Learn Curriculum

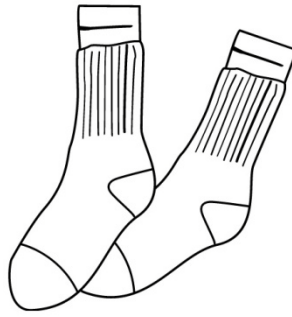

Graphics used: Graphics Factory

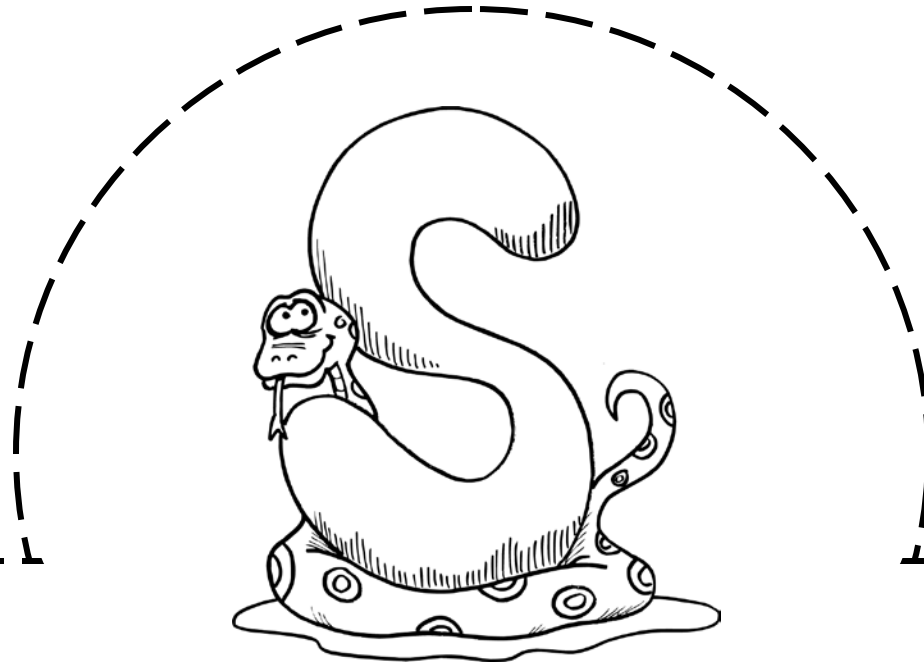

Words that begin with the letter s

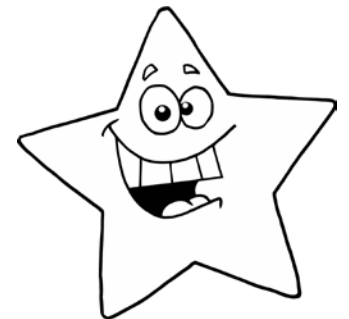
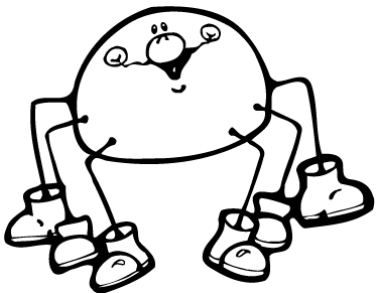

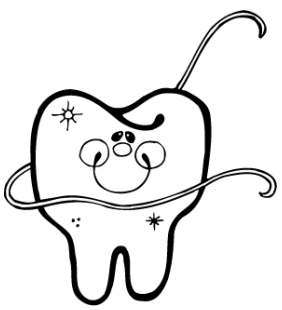

1 - 2 - 3 Learn Curriculum

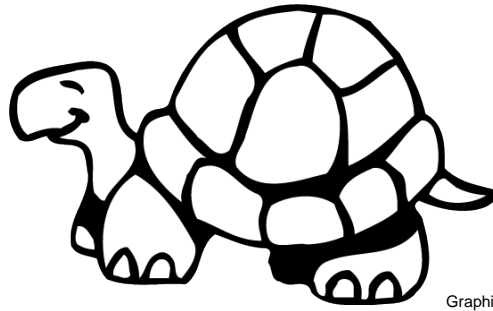

Graphics used: Graphics Factory

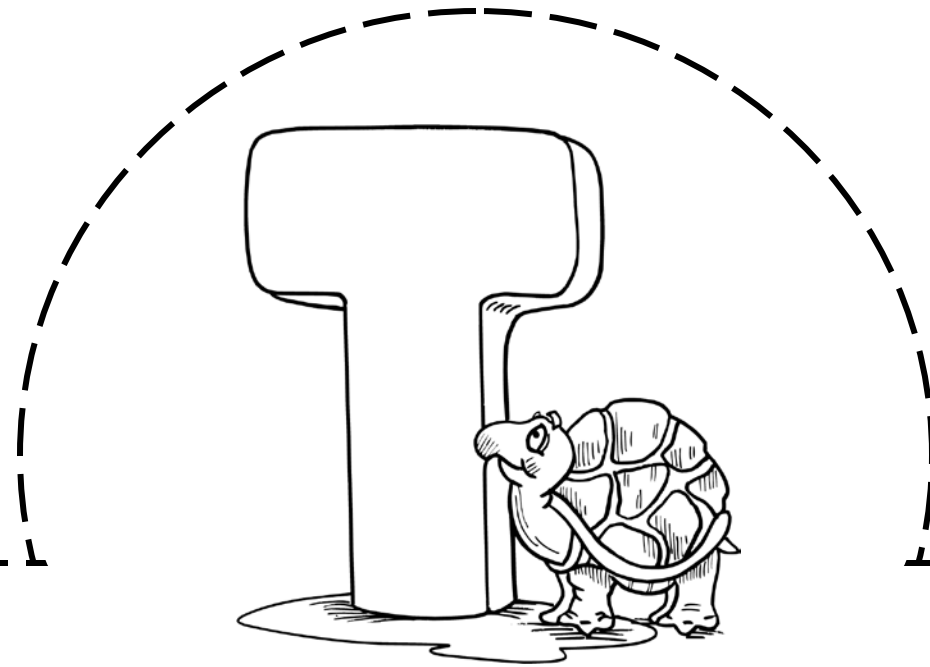
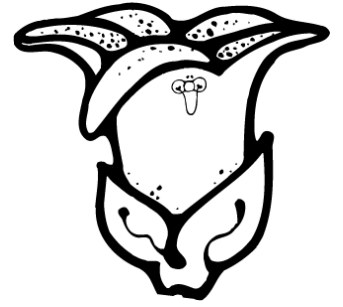

Words that begin with the letter t

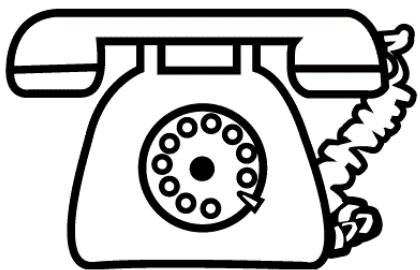



1 - 2 - 3 Learn Curriculum

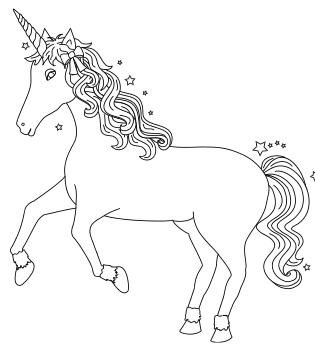

Graphics used: Graphics Factory

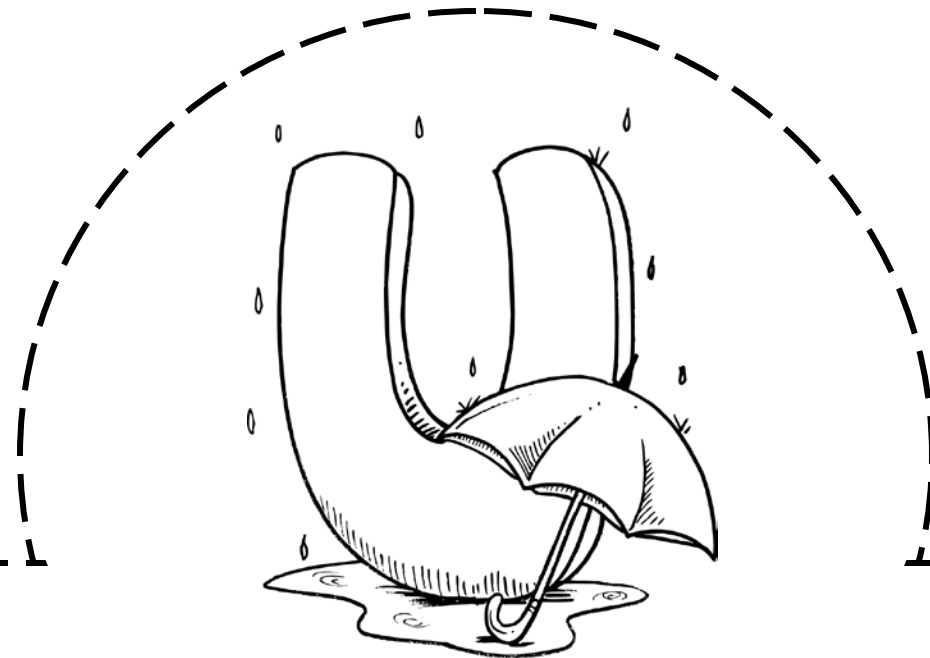
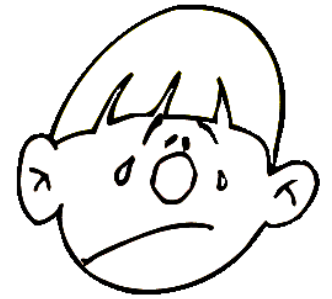

Words that begin with the letter u





1 - 2 - 3 Learn Curriculum

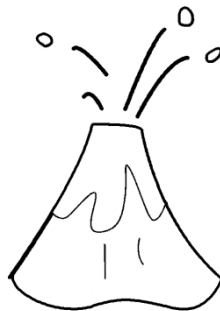

Graphics used: Graphics Factory



Words that begin with the letter v

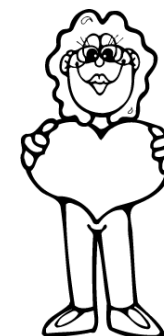



1 - 2 - 3 Learn Curriculum

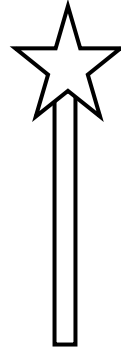

Graphics used: Graphics Factory

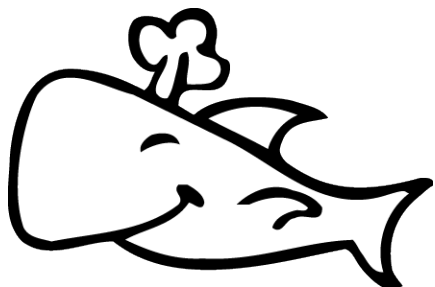
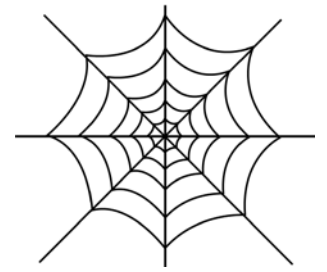

Words that begin with the letter w



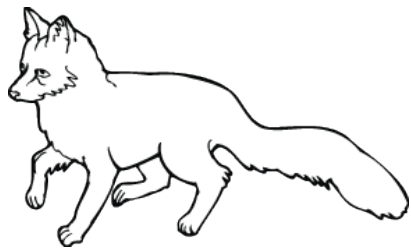

1 - 2 - 3 Learn Curriculum

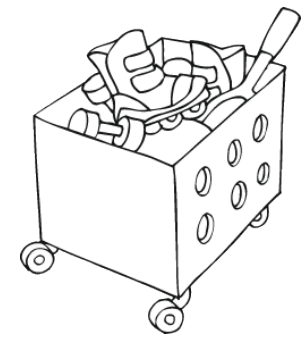

Graphics used: Graphics Factory

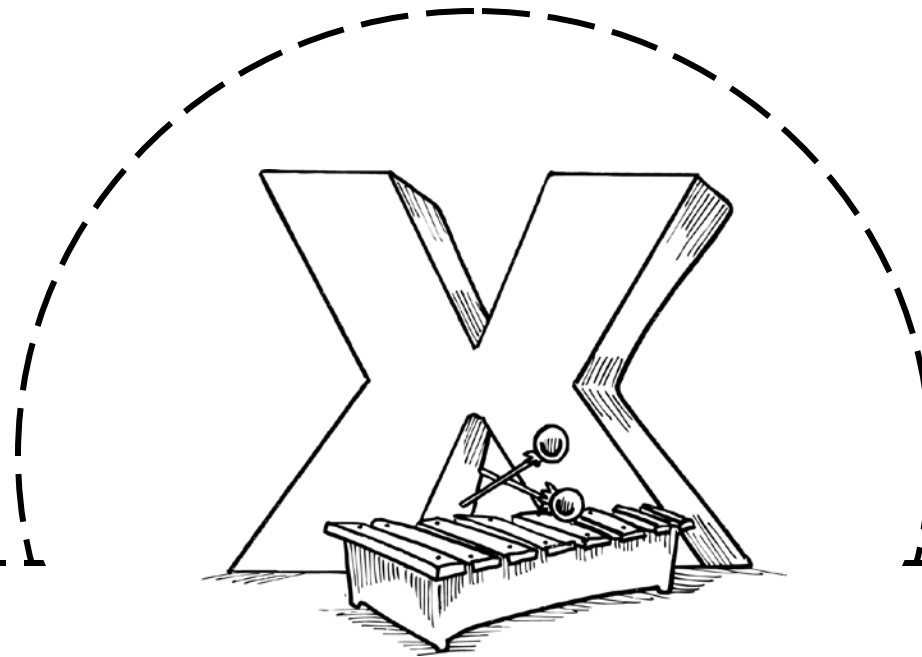

Words that begin with the letter x
or has an x in the word

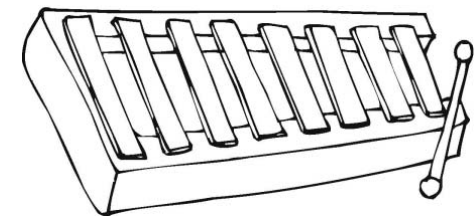

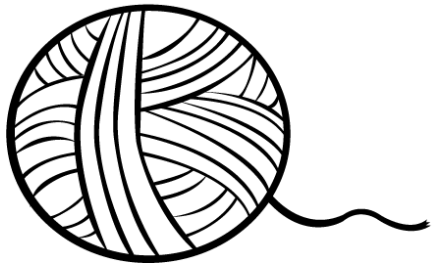

1 - 2 - 3 Learn Curriculum



Graphics used: Graphics Factory

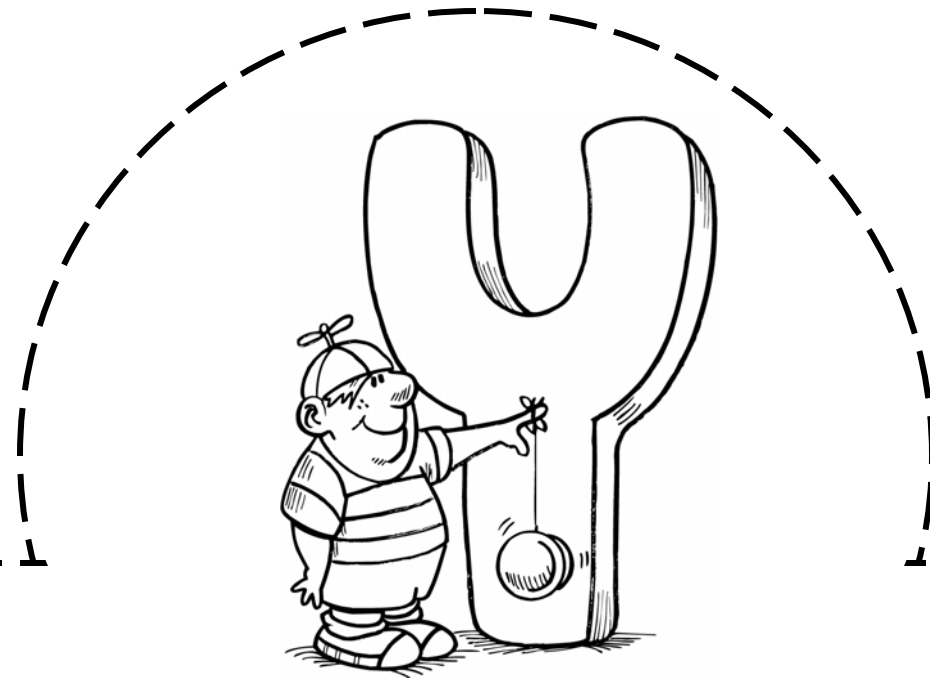

Words that begin with the letter y



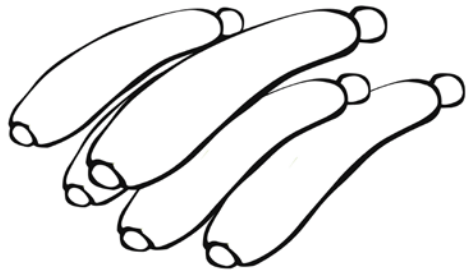

1 - 2 - 3 Learn Curriculum

Graphics used: Graphics Factory

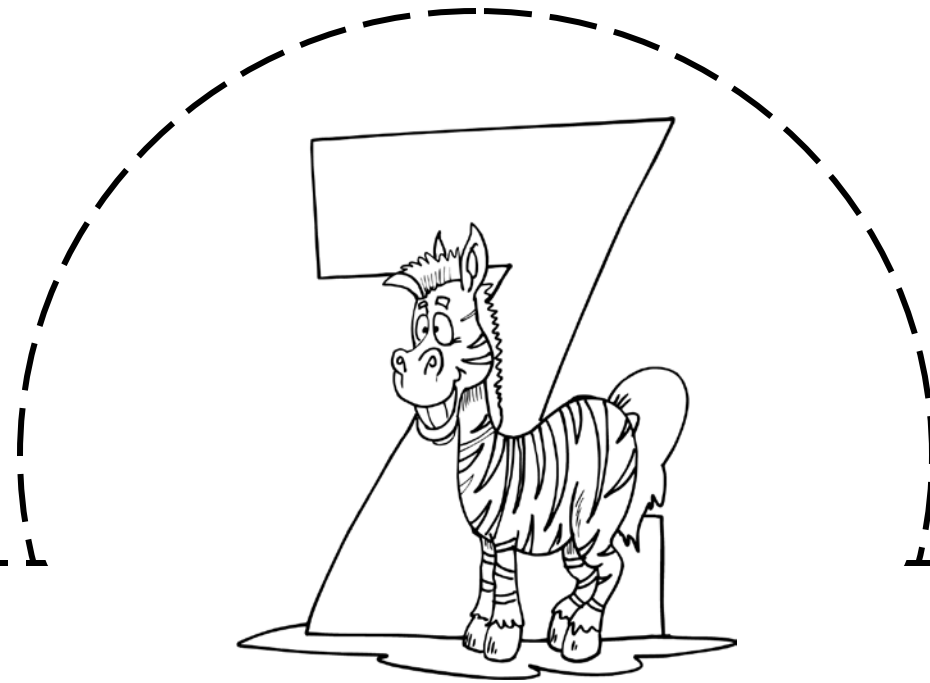

Words that begin with the letter z

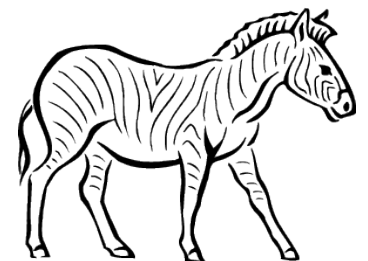

Alphabet Hats with Words

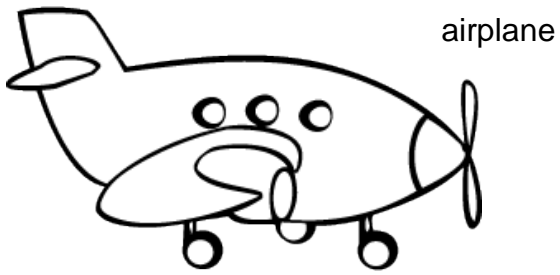

airplane

1 - 2 - 3 Learn Curriculum

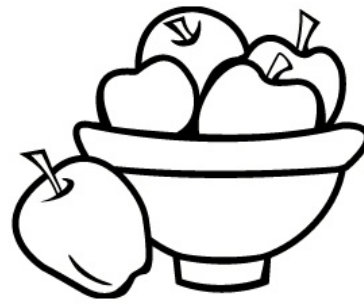

apples

Graphics used: Graphics Factory

ape

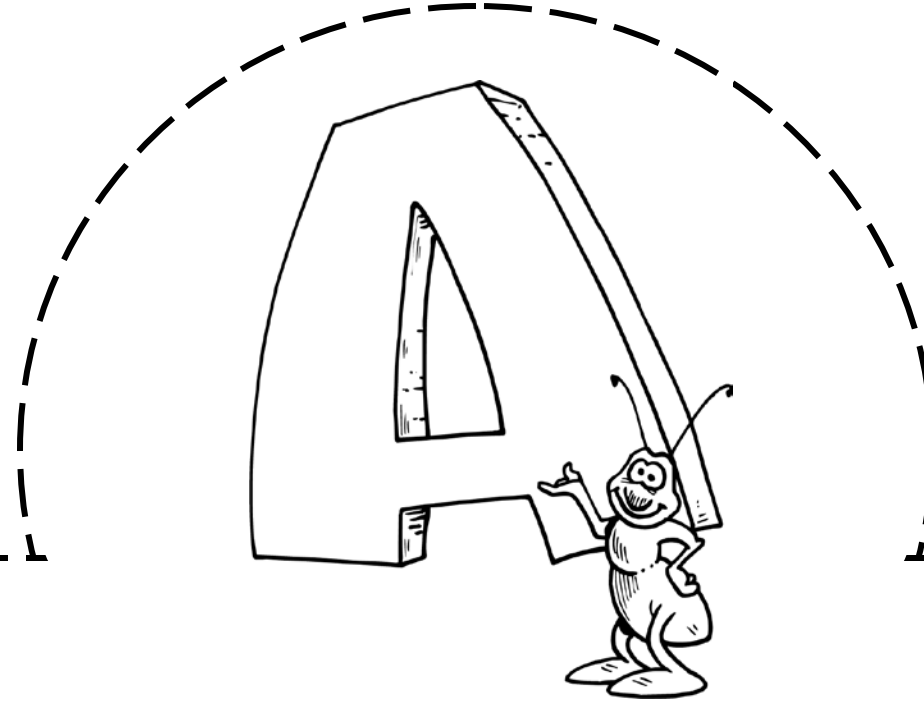

angel

Words that start with the letter a



alligator

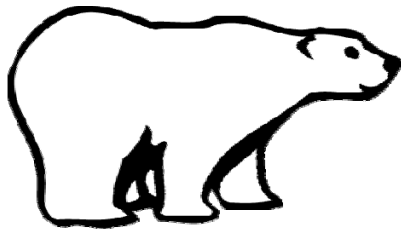

bear



banana



boy

1 - 2 - 3 Learn Curriculum

Graphics used: Graphics Factory

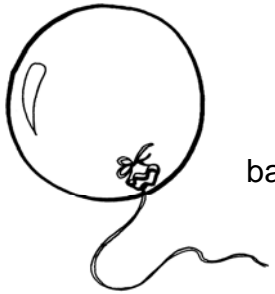

balloon



baseball

Words that start with the letter b

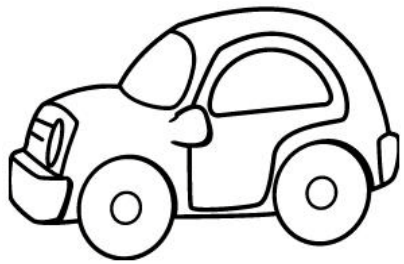

car



carrot

cookie

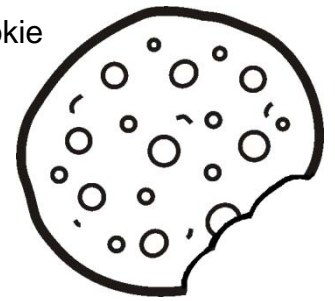

1 - 2 - 3 Learn Curriculum

Graphics used: Graphics Factory



cat

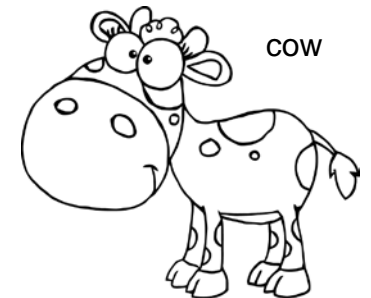

COW

Words that start with the letter c



dog

1 - 2 - 3 Learn Curriculum

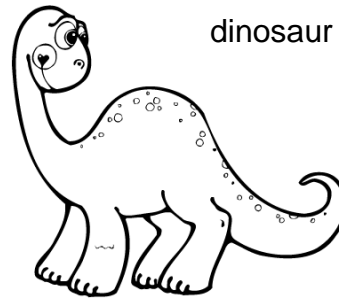

dinosaur

Graphics used: Graphics Factory

doll

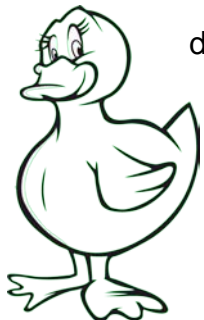
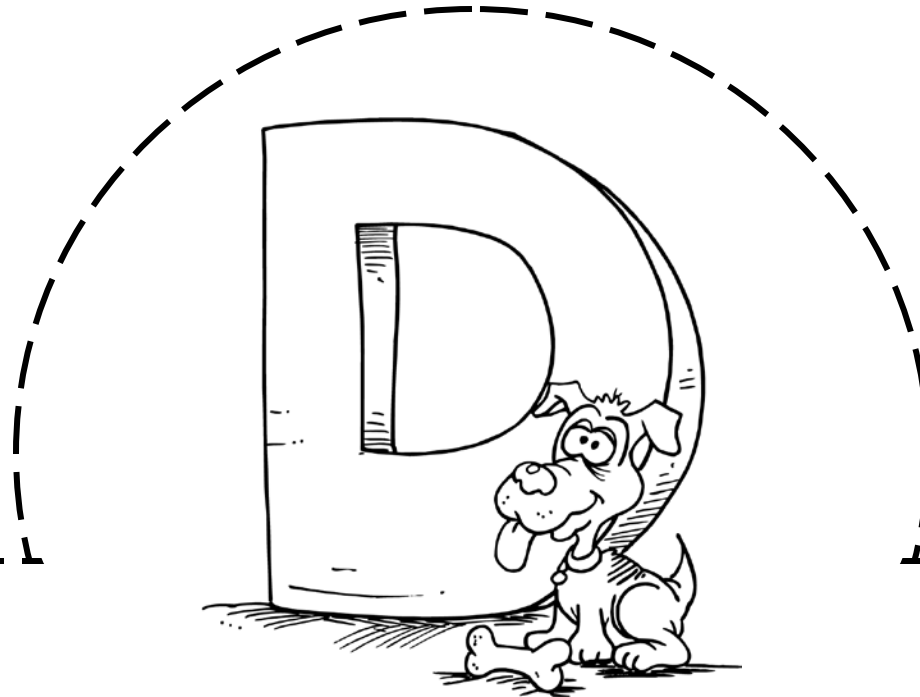
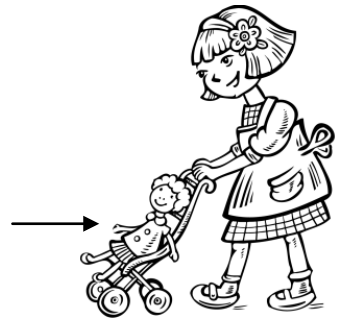

duck

Words that start with the letter d



daisy



earth

1 - 2 - 3 Learn Curriculum



Eskimo

Graphics used: Graphics Factory

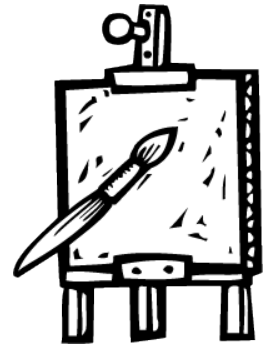

easel

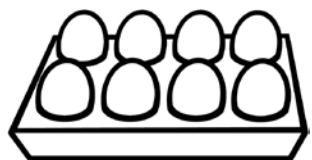
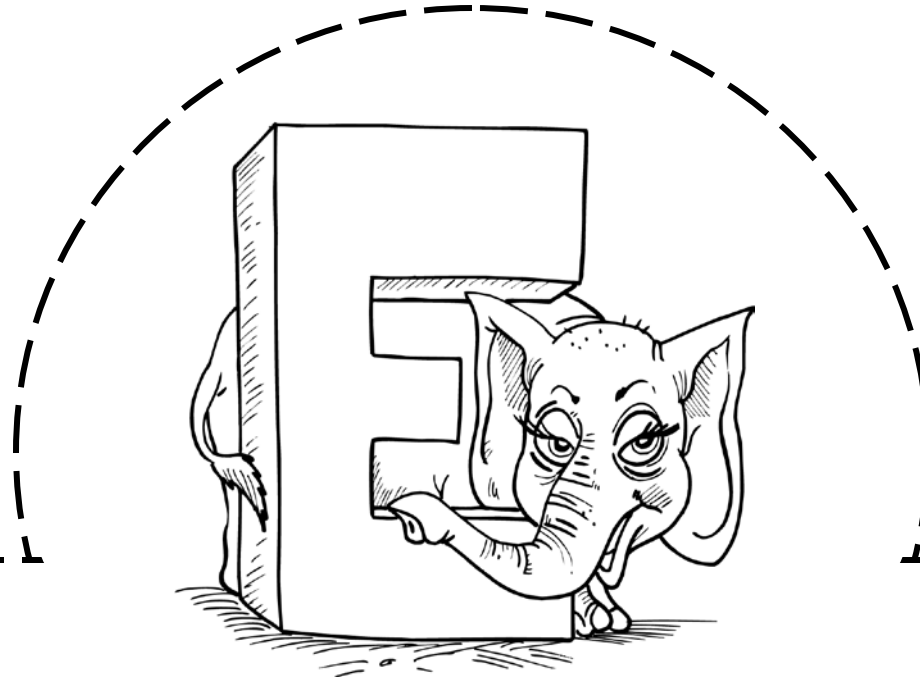

eggs

Words that start with the letter e

elephant

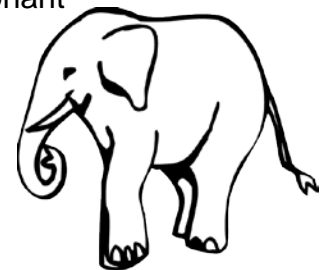



fish

1 - 2 - 3 Learn Curriculum



frog

Graphics used: Graphics Factory

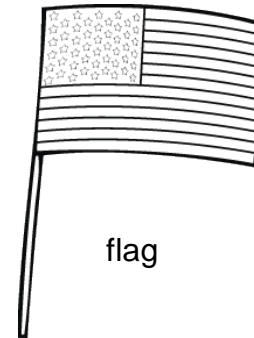

flag

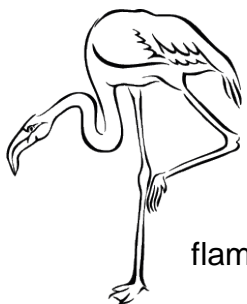
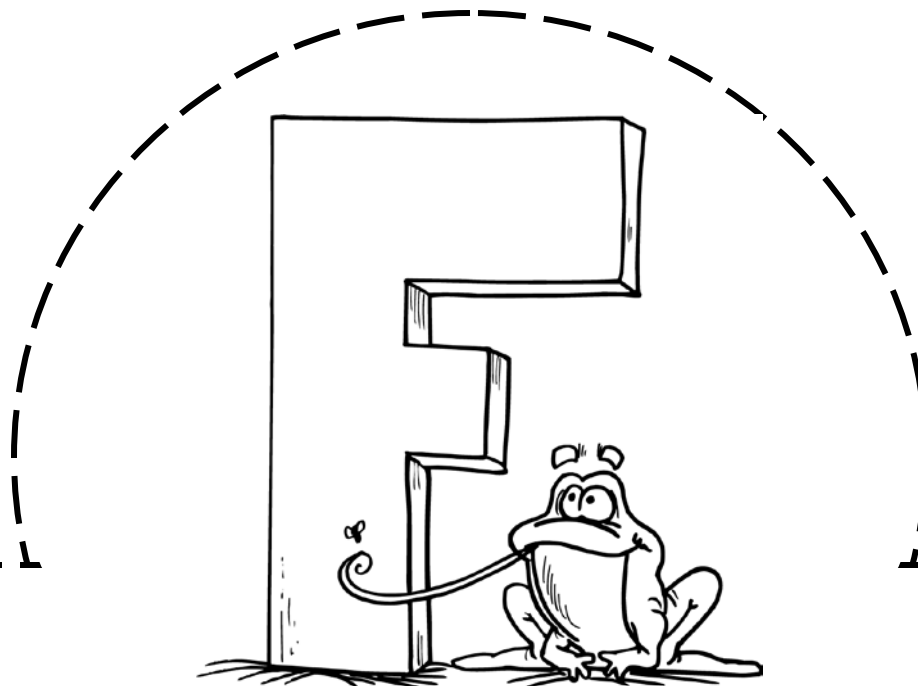

flamingo

Words that start with the letter f

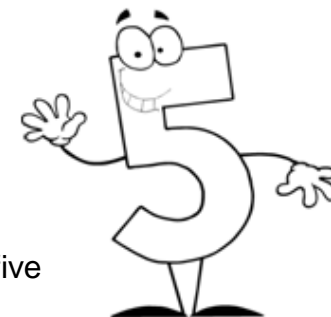

five

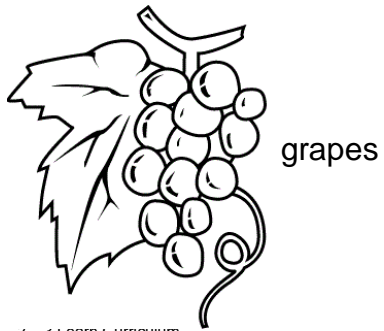

1 - 2 - 3 Learn Curriculum

girl



Graphics used: Graphics Factory

ghost

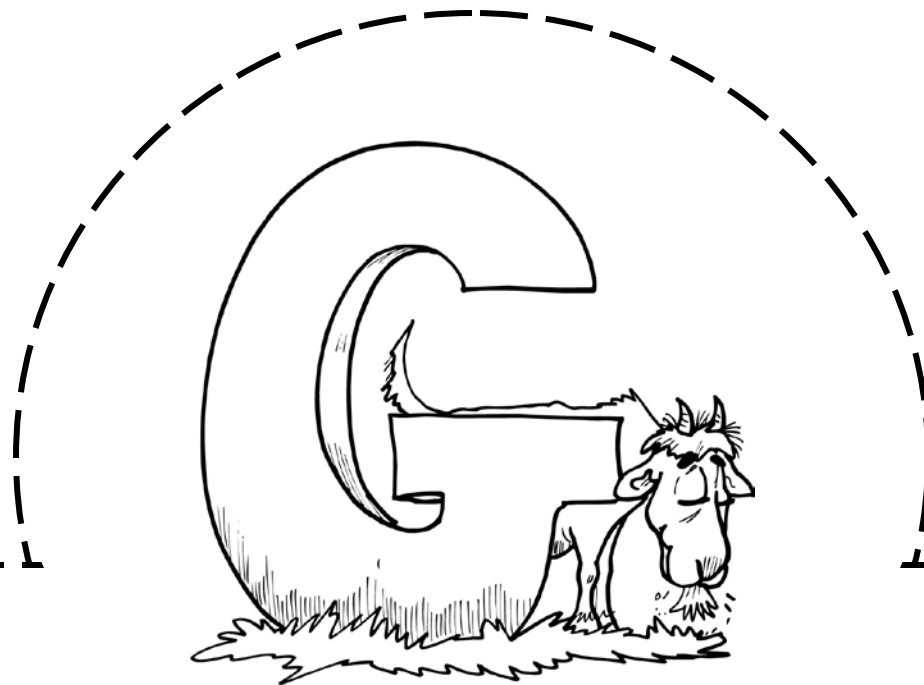

Words that start with the letter g

giraffe



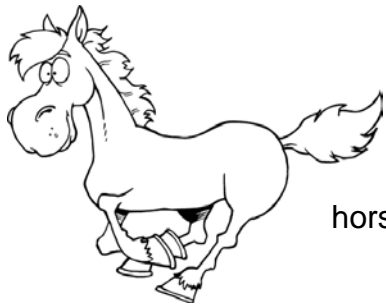

horse

1 - 2 - 3 Learn Curriculum

house



hat

Graphics used: Graphics Factory

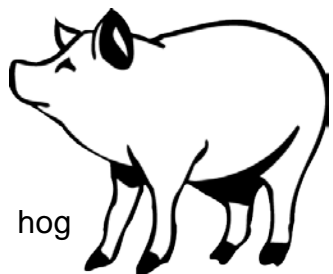
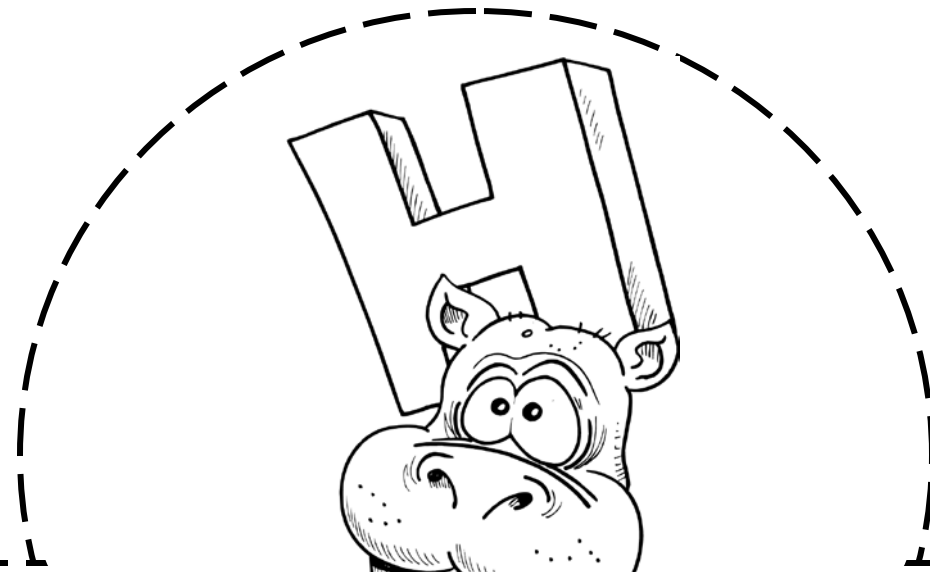

hog

hamburger

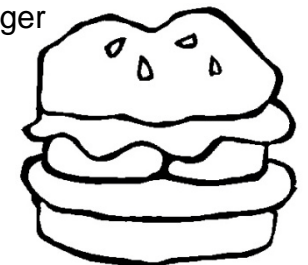

Words that start with the letter h

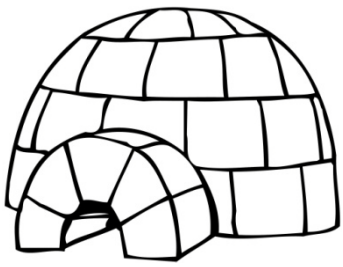

igloo

1 - 2 - 3 Learn Curriculum

ice cream
cone



infant

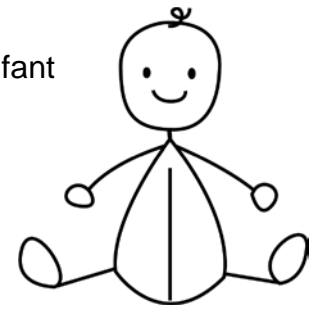

Graphics used: Graphics Factory

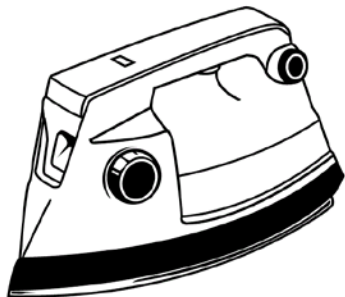
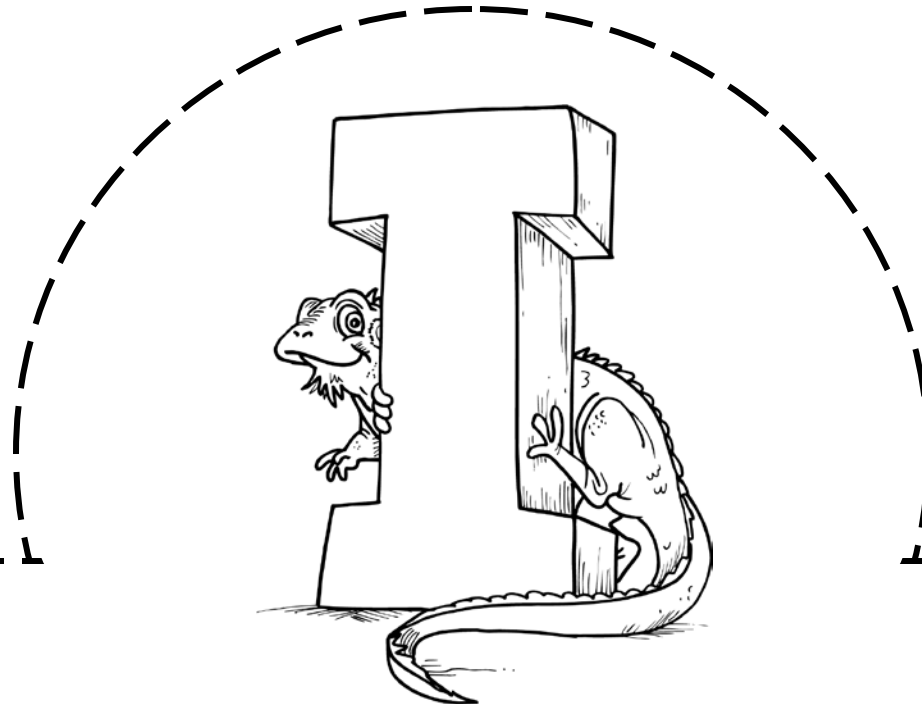

iron

Words that start with the letter i

insect



jump



1 - 2 - 3 Learn Curriculum

jacket



Graphics used: Graphics Factory

juice

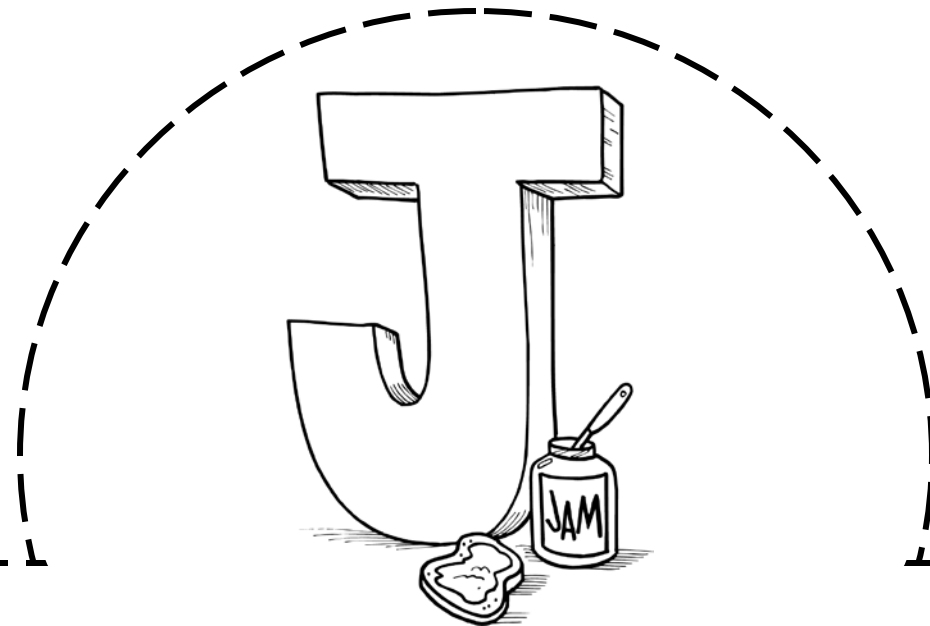

jar

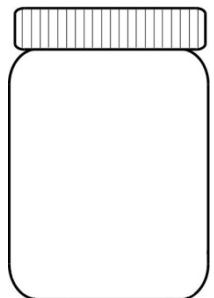

Words that begin with the letter j

jam

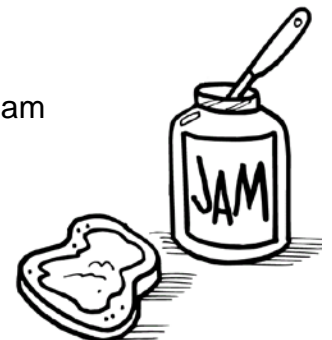

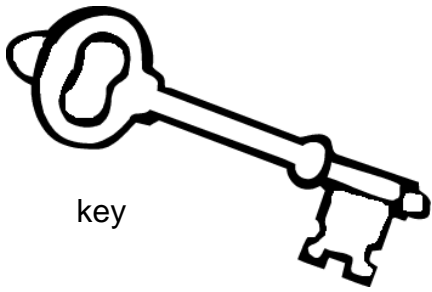

key

1 - 2 - 3 Learn Curriculum



kitten

Graphics used: Graphics Factory

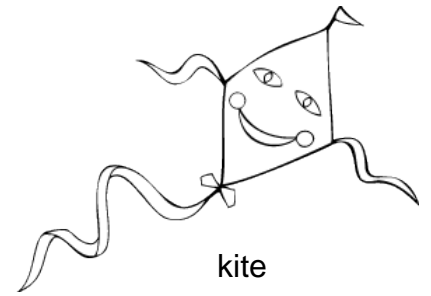

kite

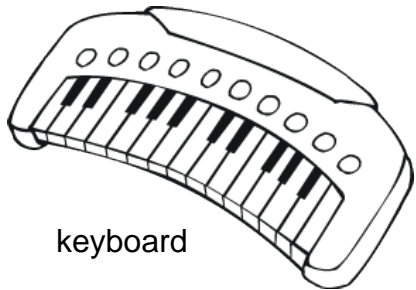
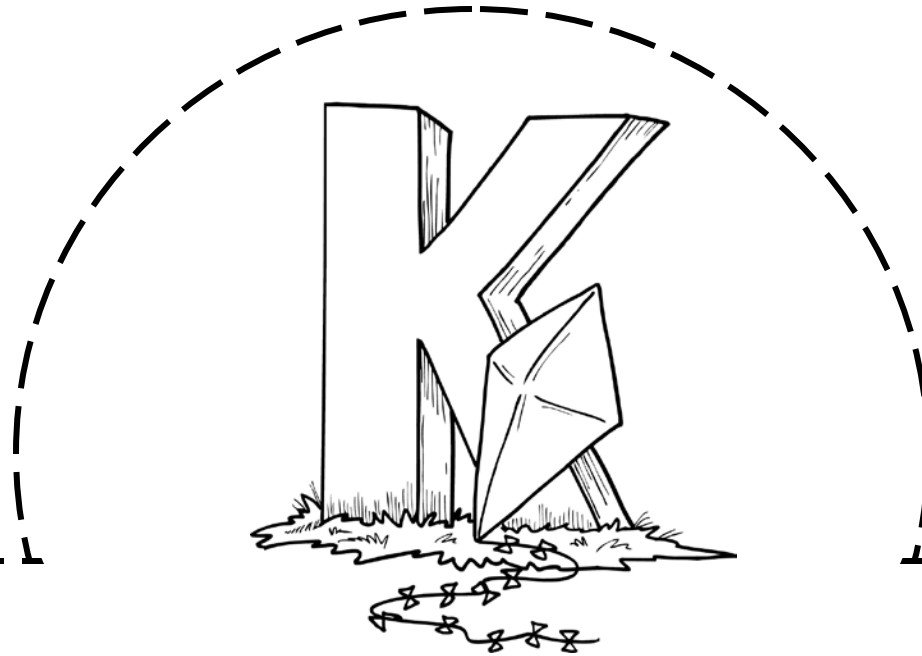

keyboard

Words that begin with the letter k

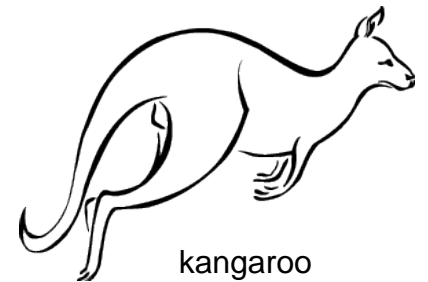

kangaroo

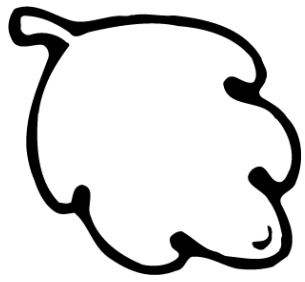

leaf

1 - 2 - 3 Learn Curriculum

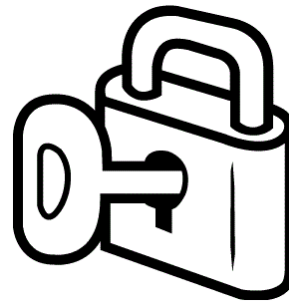

lock

Graphics used: Graphics Factory

lion

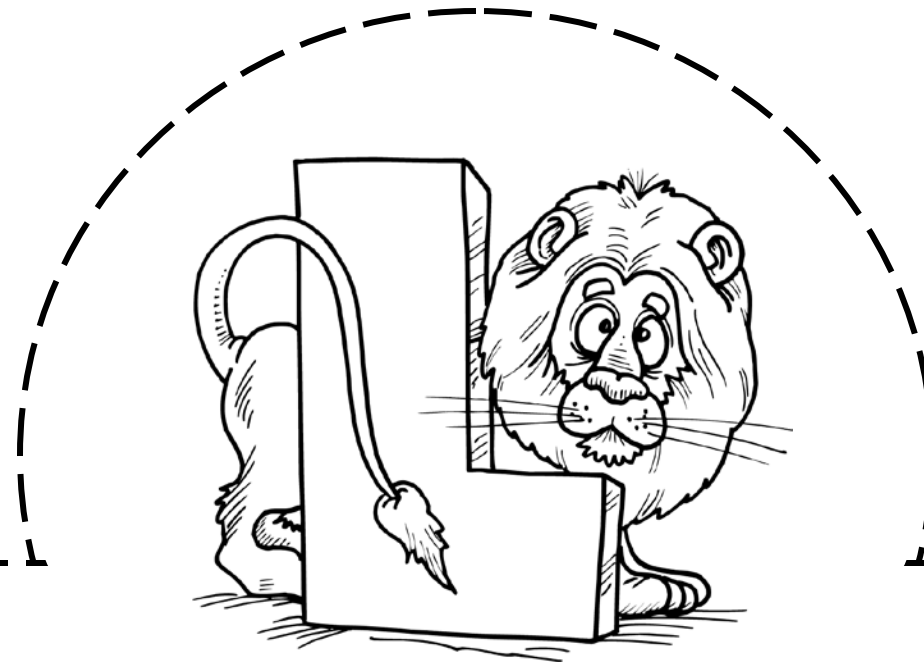
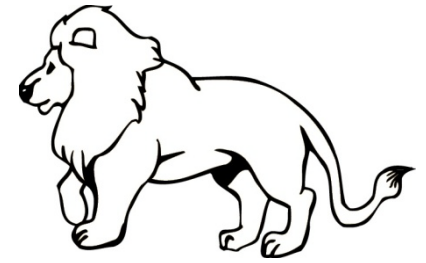

Words that begin with the letter l

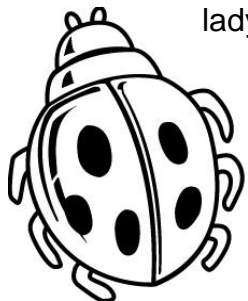

ladybug

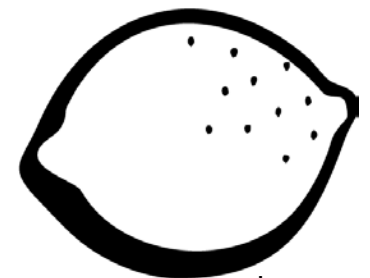

lemon

monkey

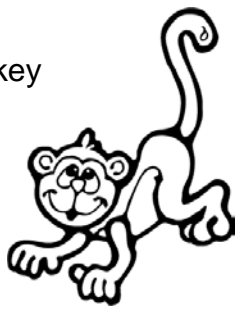

1 - 2 - 3 Learn Curriculum

moon

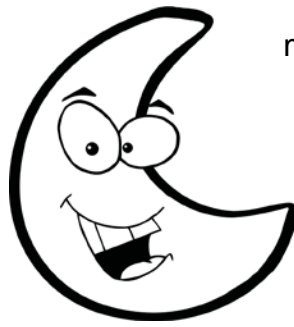

Graphics used: Graphics Factory

mom

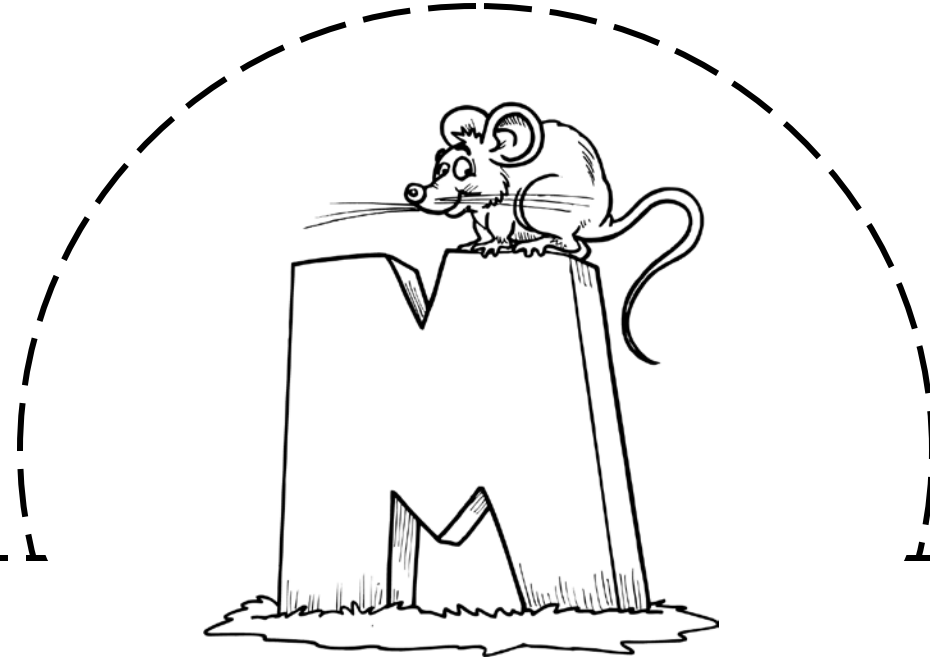

milk

Words that begin with the letter m

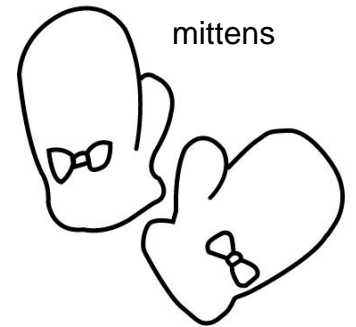

mittens

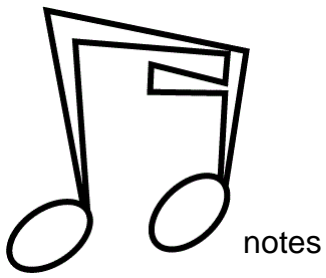

notes

1 - 2 - 3 Learn Curriculum

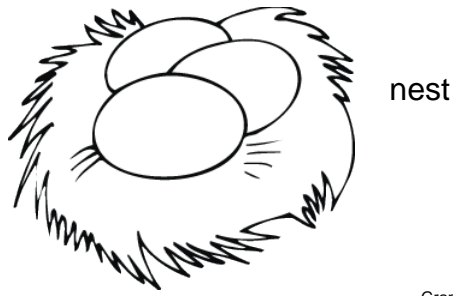

nest

Graphics used: Graphics Factory

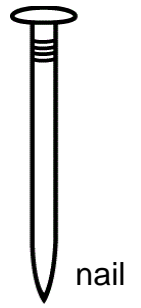

nail

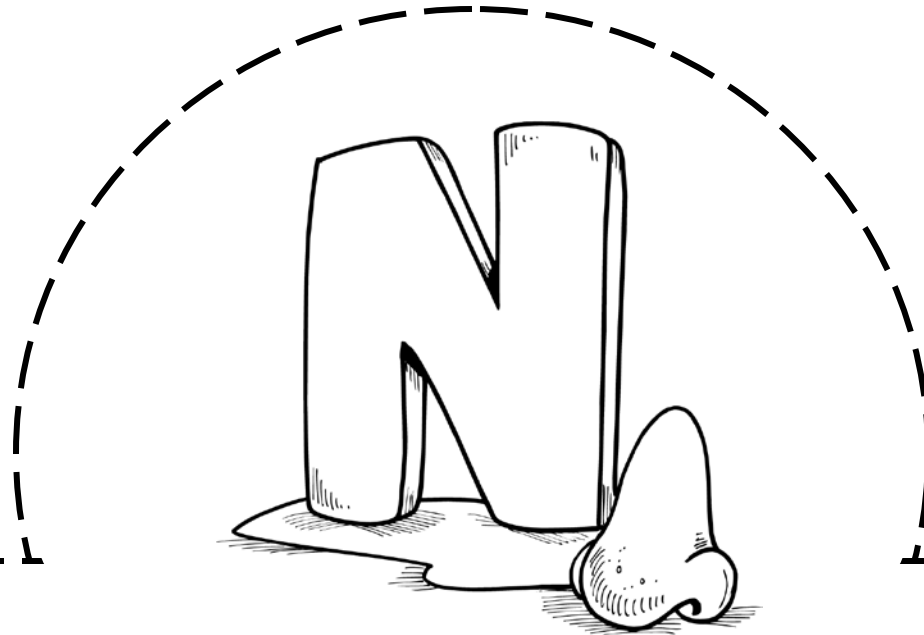

nurse

Words that begin with the letter n

numbers

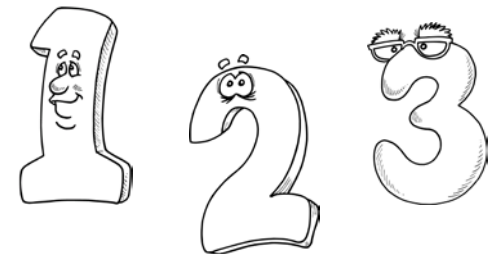

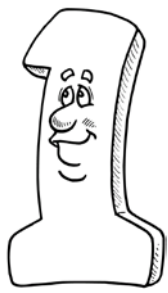

one

1 - 2 - 3 Learn Curriculum

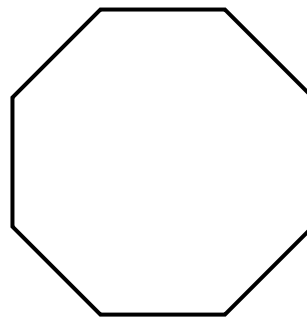

octagon

Graphics used: Graphics Factory

owl

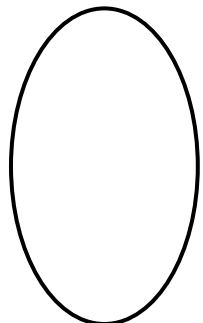
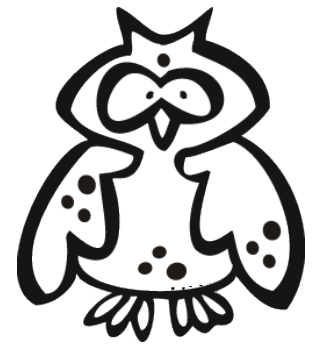

oval

Words that begin with the letter o

octopus

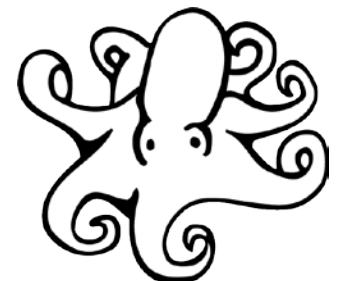

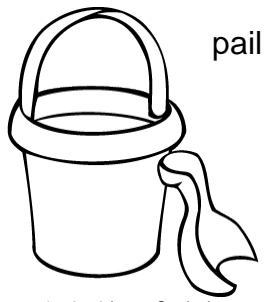

pail

1 - 2 - 3 Learn Curriculum

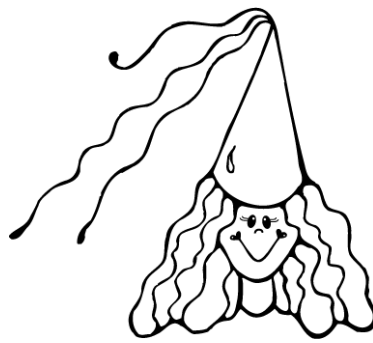

princess

Graphics used: Graphics Factory



penguin

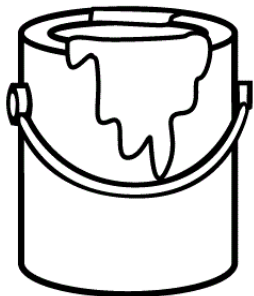
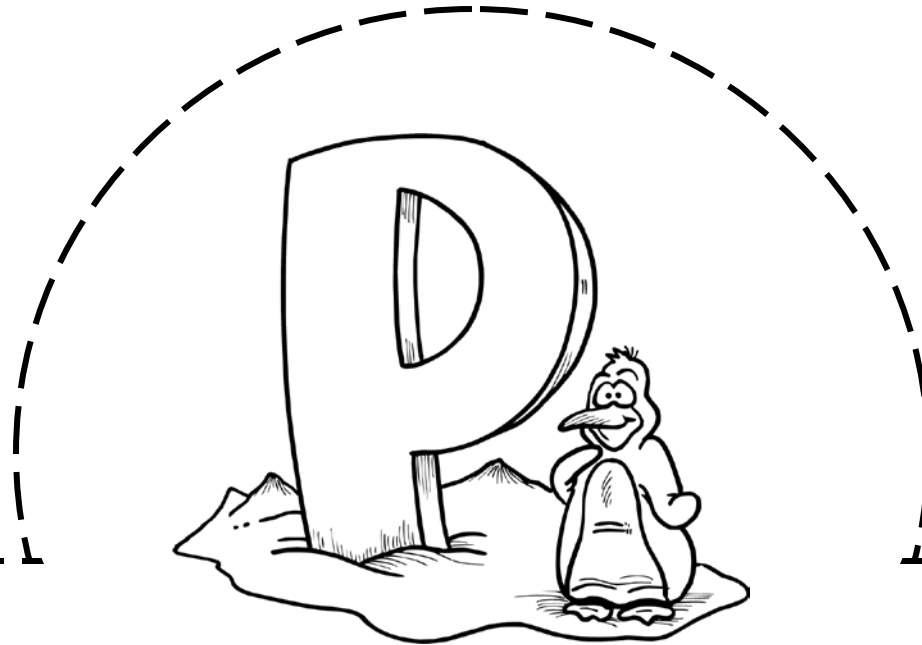

paint

Words that begin with the letter p

pear

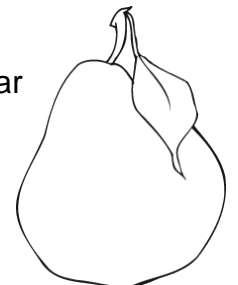



quiet

1 - 2 - 3 Learn Curriculum



queen bee

Graphics used: Graphics Factory

queen

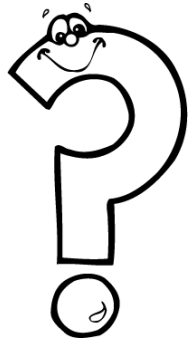
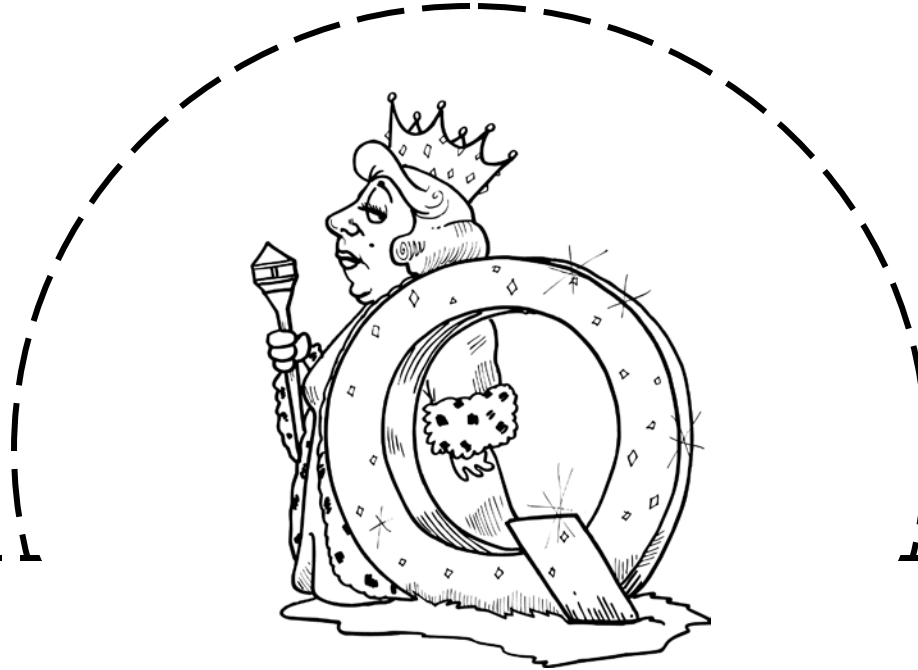

question mark

Words that begin with the letter q

quail



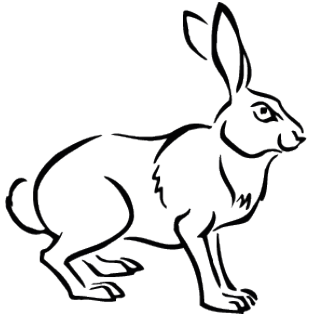

rabbit

1 - 2 - 3 Learn Curriculum



rectangle

Graphics used: Graphics Factory



rose

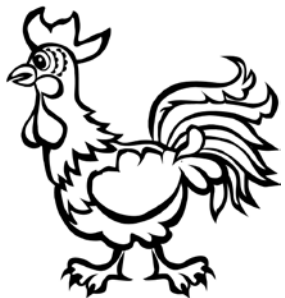
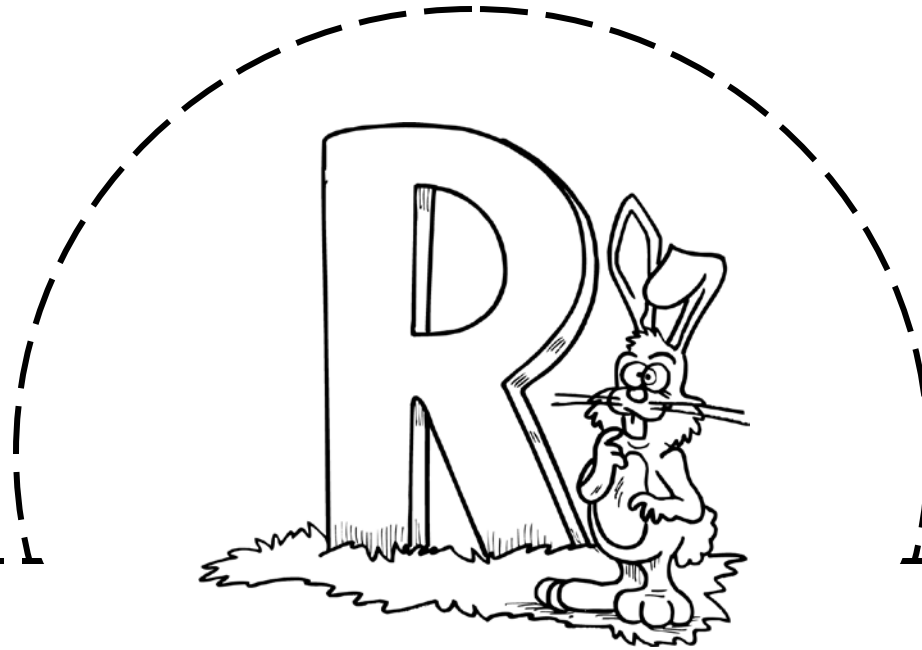

rooster

Words that begin with the letter r

rocket

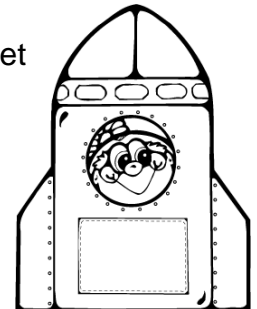

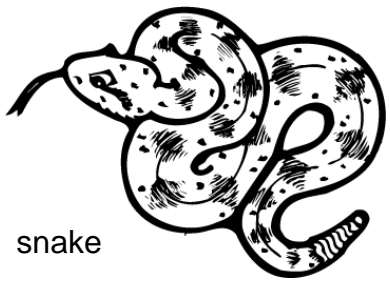

snake

1 - 2 - 3 Learn Curriculum

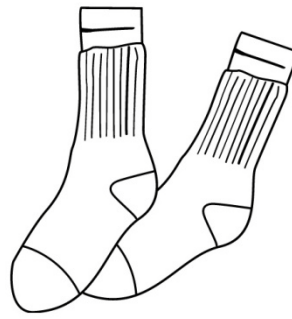

socks

Graphics used: Graphics Factory



sun

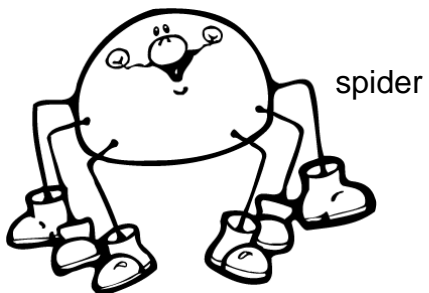
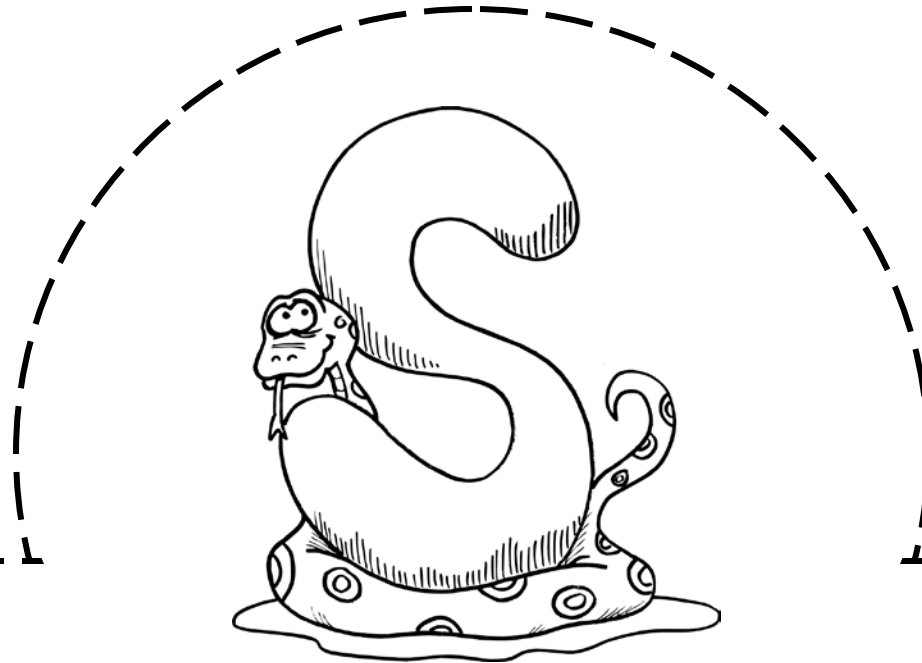

spider

Words that begin with the letter s

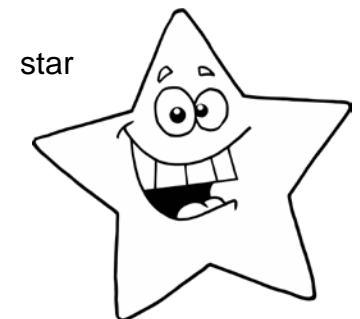

star

tooth

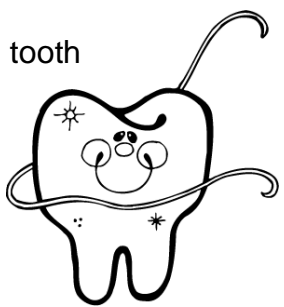

turtle

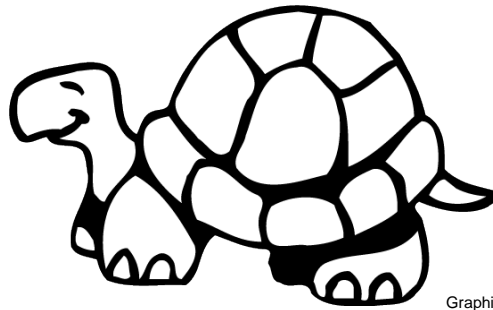

tulip



1 - 2 - 3 Learn Curriculum

Graphics used: Graphics Factory

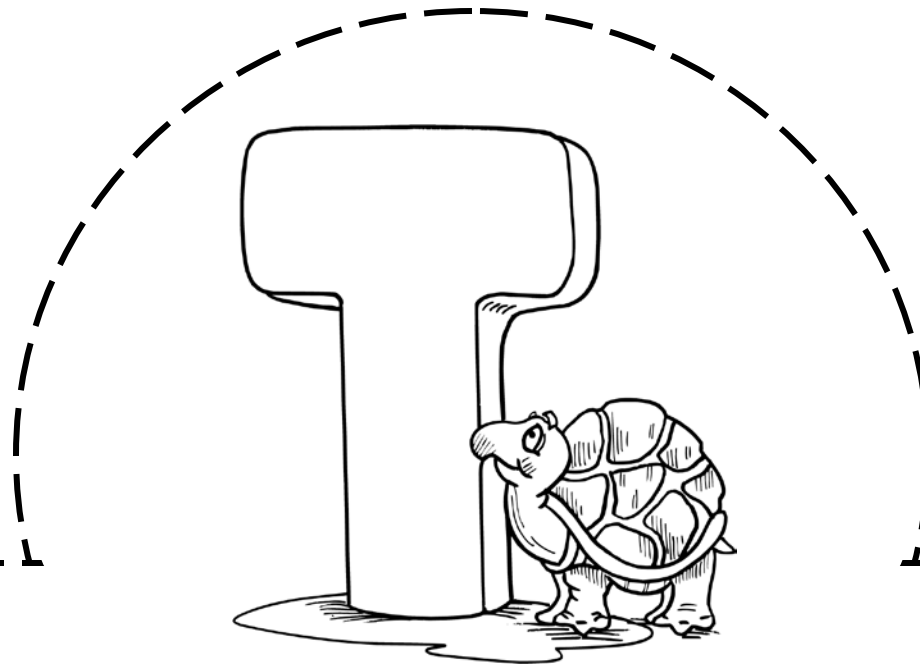

Words that begin with the letter t

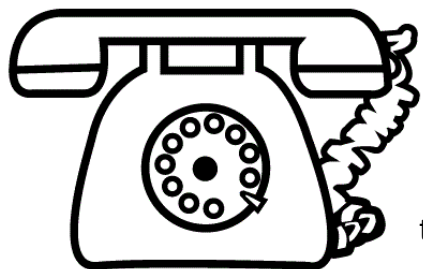

telephone

train

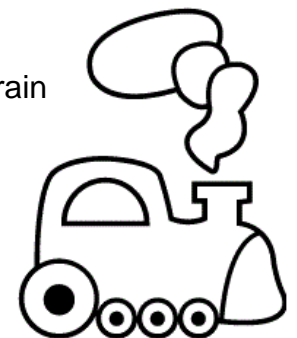



United States

1 - 2 - 3 Learn Curriculum

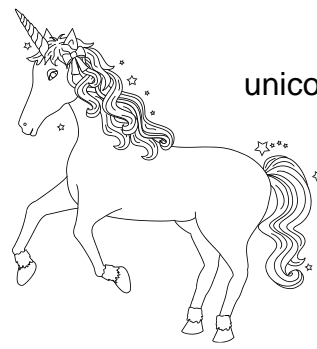

unicorn

Graphics used: Graphics Factory

unhappy

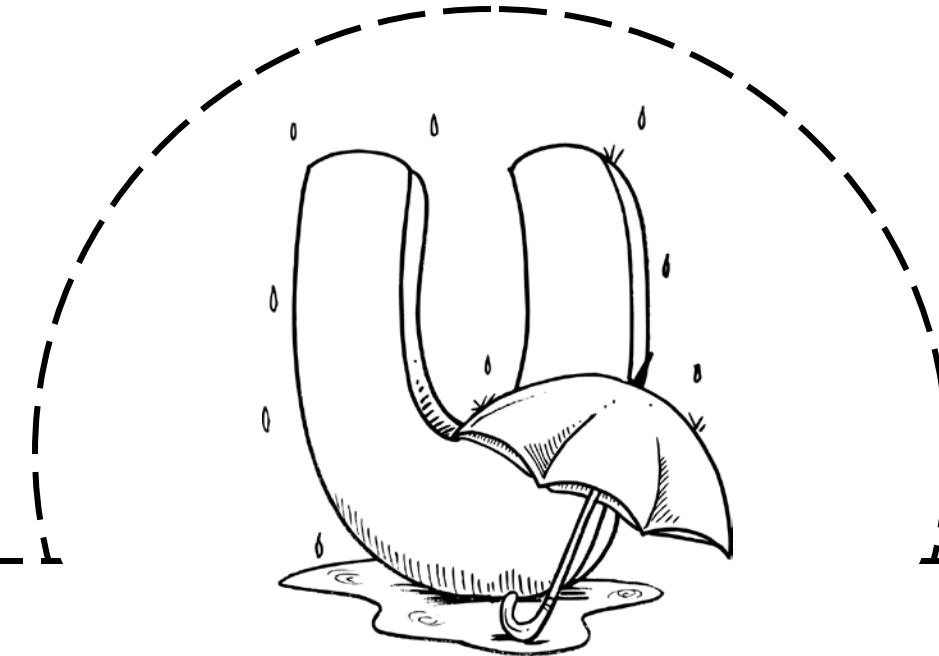
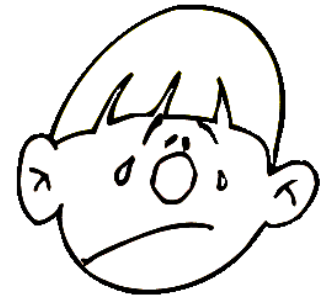

umbrella

Words that begin with the letter u



unicycle

violin



1 - 2 - 3 Learn Curriculum



volcano

Graphics used: Graphics Factory

vest

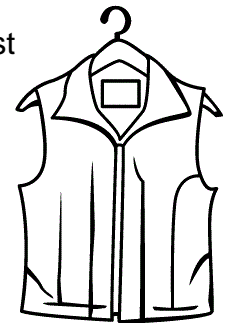

vacuum

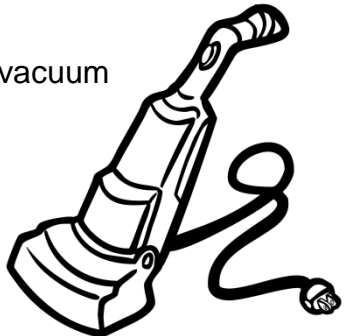

Words that begin with the letter v

valentine

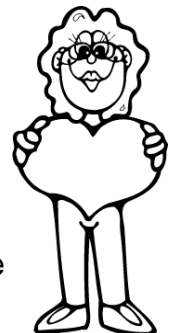

wagon



1 - 2 - 3 Learn Curriculum

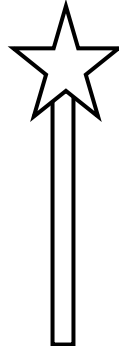

wand

Graphics used: Graphics Factory

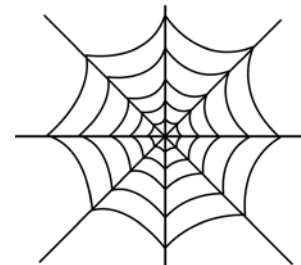

web



whale

watermelon

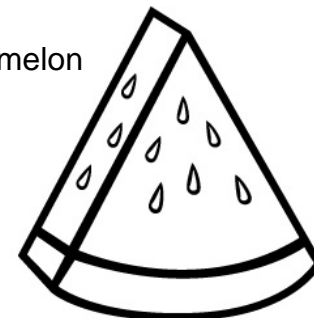

Words that begin with the letter w

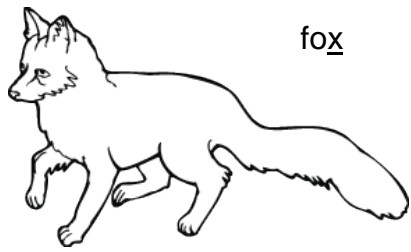

fox

box

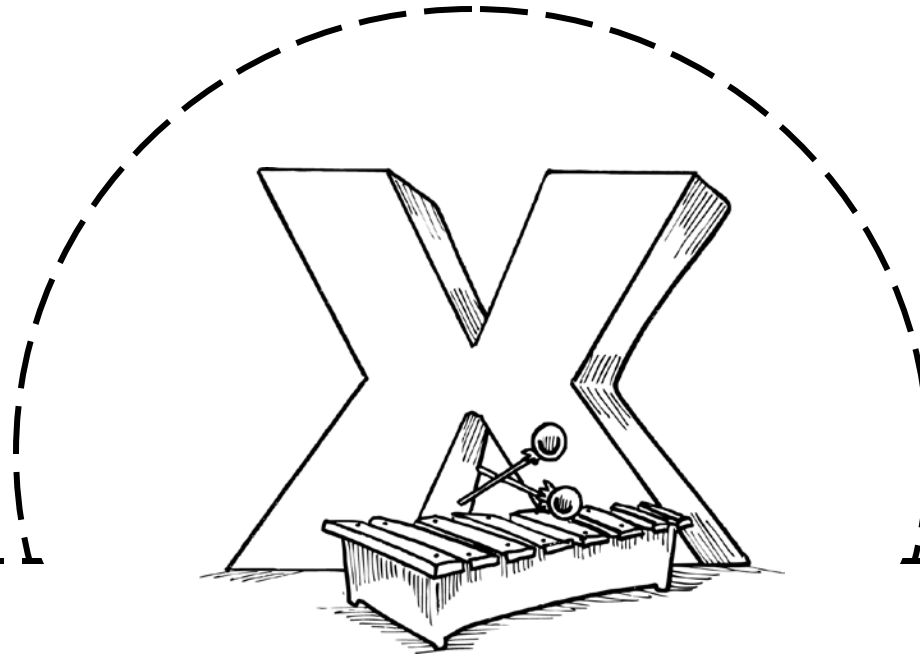
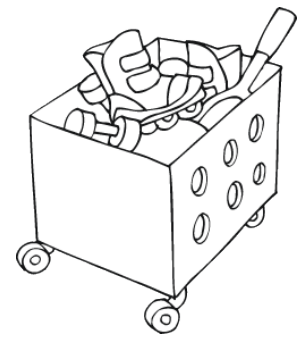

x-ray

Xylophone

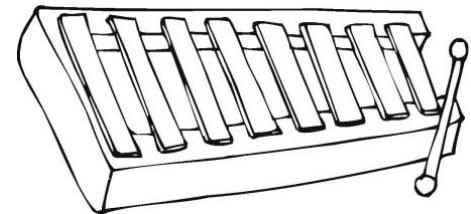

Words that begin with the letter x
or has an x in the word

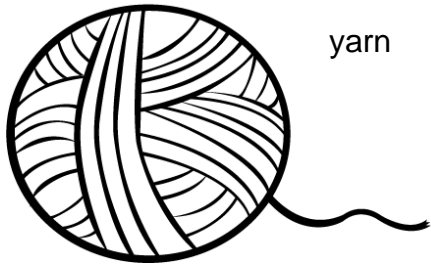

yarn



yacht



yawn

1 - 2 - 3 Learn Curriculum

Graphics used: Graphics Factory

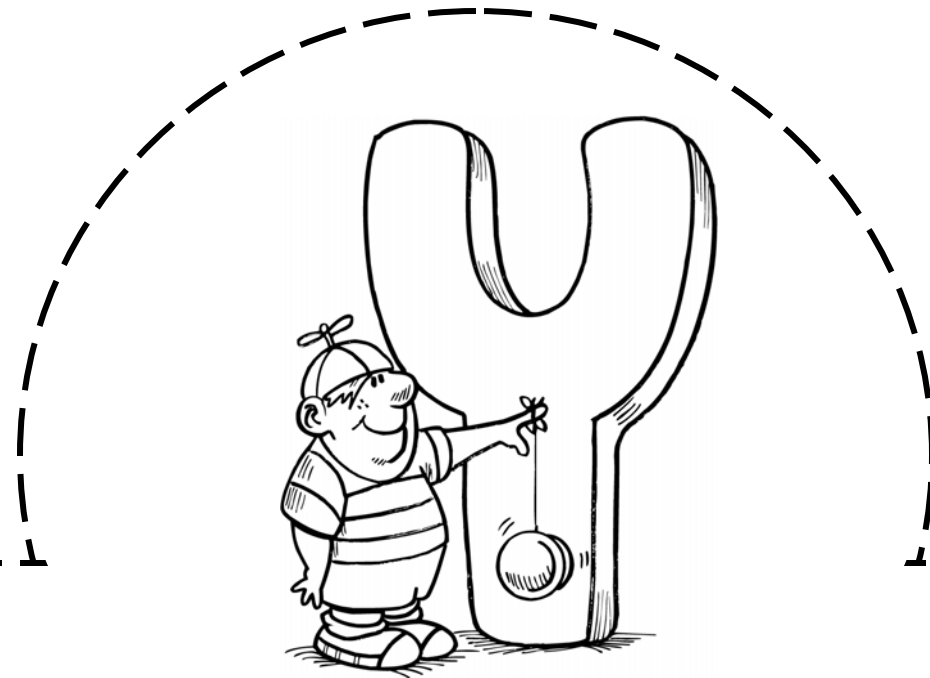

yo-yo



yogurt

Words that begin with the letter y

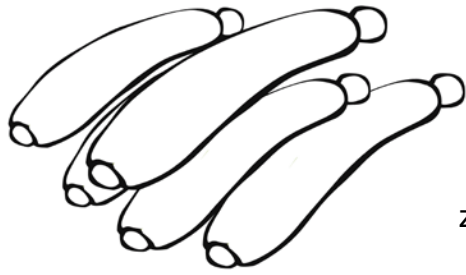

zucchini

1 - 2 - 3 Learn Curriculum

Graphics used: Graphics Factory

zero

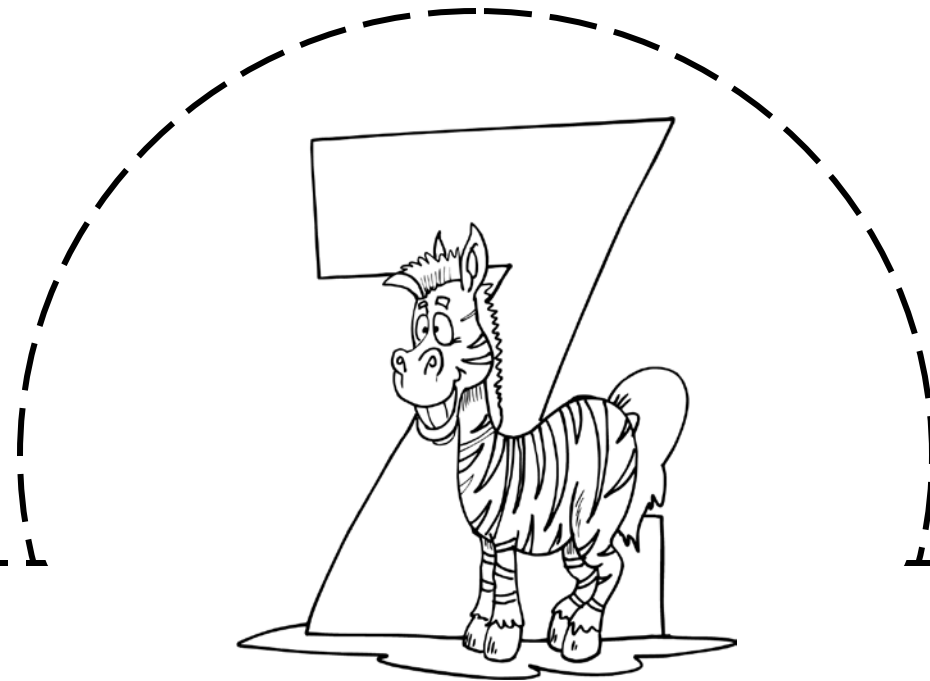

Words that begin with the letter z

zipper

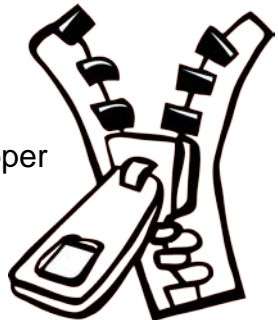

zebra

