

Day ^{by} DIN



News and know-how for informed professionals

Case History

An elegant dental practice blends energy savings
and personal comfort in harmony

Backup of the surge protection devices

Full compliance with the surge protection device
installation procedures ensures equipment protection
and service continuity



The new N/PE Quick-terminals. Flexible by Design.



The new N/PE Quick-terminals from ABB are looking towards the future. Extremely compact and flexible in terms of terminal size and extendability, these N/PE Quick-terminals are unmatched for safe, efficient and future oriented conductor connections. The new technology is suitable for the consumer units from the UK500, MISTRAL65 and A300 series, for all compact distribution boards, as well as for all meter cabinets, wallmounting cabinets and floorstanding cabinets. www.abb.com/lowvoltage



Backup of the surge protection devices: a question of safety. (62)

Day by DIN 1|14



Emanuele Tosatti
Product Marketing Manager
DIN-Rail Products

Dear Readers,
Welcome to our first 2014 issue of Day by DIN. This year the world of electricity celebrates an important birthday: to regulate the chaotic traffic of Cleveland, Ohio, a police officer named Lester Wire created the first electric traffic light, which was installed and switched on exactly a hundred years ago. With its red and green colors, the device is recorded as the first, surprisingly unpatented, electric traffic signal. Like for Mr. Wire's traffic light, colors will be definitely important for installers and panel builders in 2014, thanks to ABB. Red first, as the horizontal red stripe which shines

on the many new DIN-Rail products ABB will launch this year, for the benefit of all of you. Then green, as the green energy ABB solutions made to improve environmental impact and reduce worldwide energy consumption. Finally blue, "blue petrol" actually, the color ABB chose for the new offer of System pro *E* comfort MISTRAL® consumer units, designed to bring to your Customers' homes a techy and pleasant look!

What color will be your 2014? Tell us more: write to mail.daybydin@abb.com
Enjoy reading!

Would you like to receive all next issues of Day by DIN?

Subscribe now by filling the form that you find at the following link: <http://goo.gl/XXeMg> or by capturing the QR Code beside with your smartphone. You'll receive your personal printed copy of this issue and all the new ones coming in the future.





34

Case History

An elegant dental practice blends energy savings and personal comfort in harmony



44

Robot Frida

The flexible robot that works side by side with humans

News and facts

- 6 **Jump in the box**
Fresh news from ABB for your installation!
- 20 **In the news**
Literature on our latest products
- 28 **ABB Garage Nuggets**
ABB Garage Nuggets are short videos telling about ABB low voltage products and applications. All Nuggets are available on ABB YouTube channel. ABB Garage Nuggets: pearls of wisdom packed in a clear and simple format.
- 30 **Top five**
Market classification
- 54 **From Installer to Marketing Expert**
Customer Satisfaction
- 56 **Day by web**
I am feeling even luckier now!

The expert answers

- 32 **Good morning DIN-Rail**

Did you know that?

- 42 **Is it really just a box?**
- 50 **Is it possible to install S800 series in installation with rated voltage at 12V AC/DC?**

Doktor Wise

- 38 **Fraternal twins part 1: IEC 60898 and IEC 60947**
- 39 **Fraternal twins part 2: UL and UR**
- 40 **Protection in compliance with IEC EN 60947-2 Annex-M Standard**
Residual current relays with separate toroid
- 41 **Errors in the measuring chain**

Case History

- 34 **An elegant dental practice blends energy savings and personal comfort in harmony**
Centrally located in the heart of Rome, Italy, the Dental Practice Calesini combines the sophistication of historical environments with state of the art technology, relating both to the dentistry specialization and to KNX intelligent building control system.

Curiosity

- 42 **London to Paris the Stretch target of 2014**
- 44 **The flexible robot that works side by side with humans**
ABB two-armed robot Frida was created to improve industrial production flexibility, allowing integration of automated assembly and manual labor.

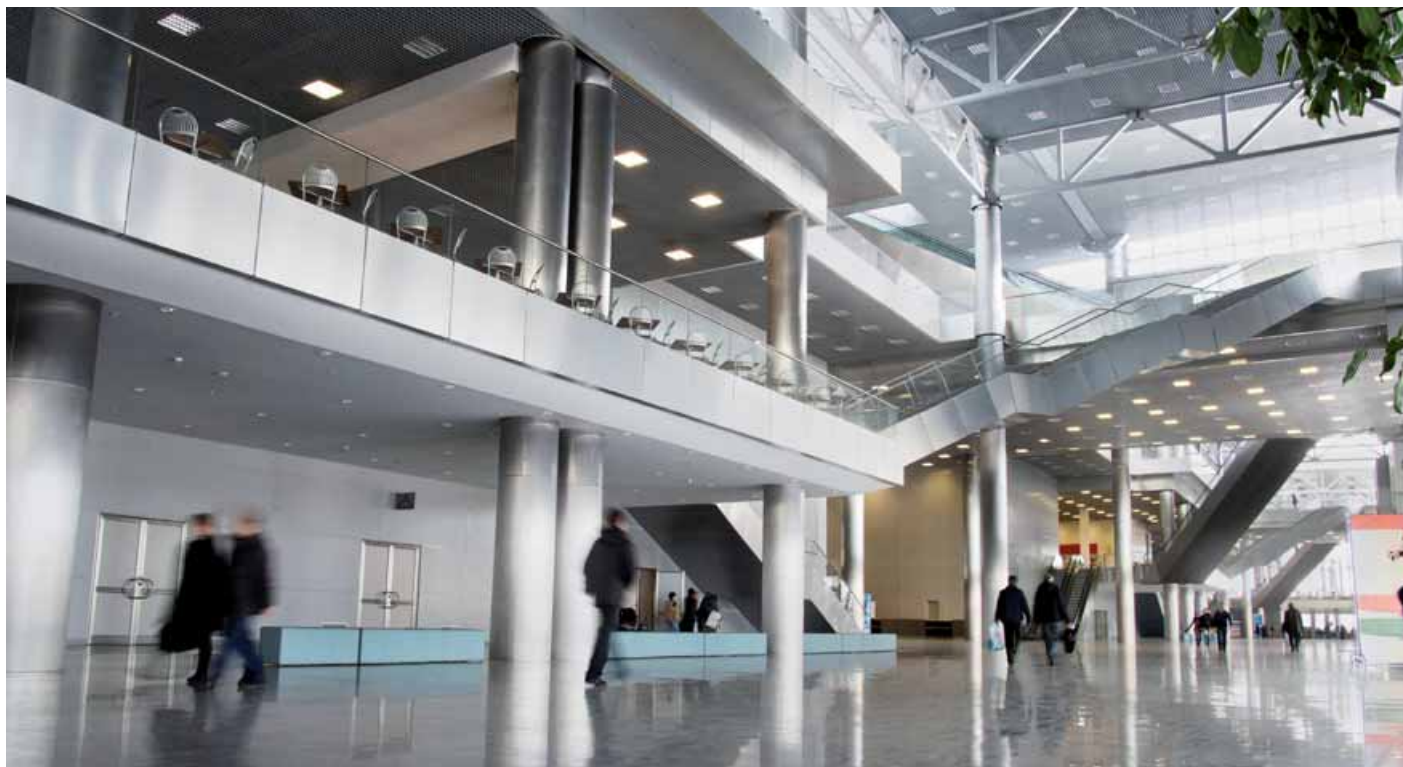

58

The emergency stop according to ABB

The emergency stop device is used to interrupt a system's power supply safely and immediately

Technical

48 Temperature rise, breakers and disconnectors behavior in photovoltaic application.

Assembly engineering in the PV industry differs in different aspects to well-known AC switchgear assembly. This article provides useful wiring advices to take in consideration when designing PV panels and especially the PV breakers and disconnectors.

52 Energy for free!

Can you afford to give away energy for free? Think if you were the owner of a petrol station and your pumps supplied petrol for free to customers if they just open the tap a bit. Okay it will take some time to fill the car but it is not measured and petrol is expensive.

58 The emergency stop according to ABB

The emergency stop device is used to interrupt a system's power supply safely and immediately. Its functioning, which must be guaranteed for the system entire life, must never allow the unexpected. There are several technical solutions for triggering an emergency shut off: here we will discover their advantages and disadvantages and illustrate the solution patented by ABB for this specific application.

62 Backup of the surge protection devices: a question of safety

Full compliance with the surge protection device installation procedures ensures equipment protection and service continuity

Time to relax

66 Connect the boxes

Train your brain

67 DINside View

How to produce easily the enclosures for remote measuring of energy consumptions.

Jump in the box

Innovation of the System pro *M* compact®'s measuring instrument range continues with the introduction of the new CT PRO XT and CT MAX current transformers and the new range of EQ Meters. These are some of the many news you will find our rich section of product launches.

Measurement

CT PRO XT, CT MAX

Functionality and safety for all types of application

The wide and complete range of ABB current transformers is updated with the new CT and CT XT PRO MAX series, cutting-edge products specifically designed for maximum installation ease, performance and reliability as regards safety thanks to the introduction of the innovative integrated electronic protection circuit of the secondary available in the CT PRO XT SELV e CT MAX SELV versions.

Ideal for use in primary and secondary sub-distribution panels and power centers, the new current transformers feature extremely compact dimensions, dual connectivity to the secondary winding, thanks to the screwless clamps available along with normal screw clamps, and a wide range of standard accessories to ensure installation in any type of application.

Brochure: 2CSC446012B0201



+ Benefits

- Ultra compact and easy to install
- Including installation supports suitable for all common mounting systems
- Dual connectivity to the secondary circuit thanks to the screwless clamps
- Maximum safety thanks to the electronic protection circuit of the secondary in the CT PRO XT SELV and CT MAX SELV versions
- Compliant for billing applications, suitable for excise duties certification

Command

T Series

Twilight Switches



The T Series twilight switches command lighting circuits in relation to the ambient light detected by the designated sensor. Their application is particularly useful in public areas (gardens, parking lots, entrances, courtyards, etc.), where they can reduce energy consumption.

The one-channel T1 version is factory preset at 10 Lux, it features a switching delay and 2 LED indicators, one for the threshold value indication and one for the status of the contact.

The connecting and start-up instructions are on the product's side to facilitate installation and future maintenance operations. The advanced T1 PLUS version is equipped with a reference selector that can be adjusted to 4 different scale values, thus making these high-Lux-value twilight switches ideal for daytime applications.

- 2...40 Lux
- 20...200 Lux
- 200...2000 Lux
- 2000...15000 Lux

The T1 PLUS version also allows adjustment of the switching delay in a time-range between 15-20s and 90-120s. As with the basic model, also the PLUS version is factory preset at 10 Lux and equipped with 2 LED indicators.

Brochure: 2CSC441022B0201



Benefits

- Two LED indicators: one for the contact status and one for the threshold value
- Sensor factory preset at 10 Lux
- Four different scales for more accurate adjustment of the brightness value on PLUS version
- IP65 protection degree on pole/wall version
- Connection and operating diagram on the product back on pole/wall version

Protection

DDA 200 B APR type

New RCD blocks fully compliant to the international Standard IEC 62423 2nd edition

The new DDA 200 B APR type is fully compliant to the international Standard IEC 62423 2nd edition. One of the main advantages of the new standard is the introduction of additional tests and very strict requirements against unwanted trippings, typically fulfilled by the ABB RCD APR range.

The new DDA 200 B APR type is suitable for coupling to all S 200 miniature circuit breakers up to 63A. RCD blocks B type are able to provide protection even in case of smooth direct earth fault currents and high frequency residual sinusoidal alternating currents.

Brochure: 2CSC427002B0201



Benefits

- Additional contacts for remote tripping of the device (on 40A - 63A)
- Wide range; only ABB can offer a complete range of RCD-blocks B type.
- LED on the device to indicate the correct functioning as a B type
- Using a DDA B type solution many RCBOs configurations are possible assembling it to the S 200 range

Command

SD 200 Switch Disconnectors

New state-of-the-art in switching

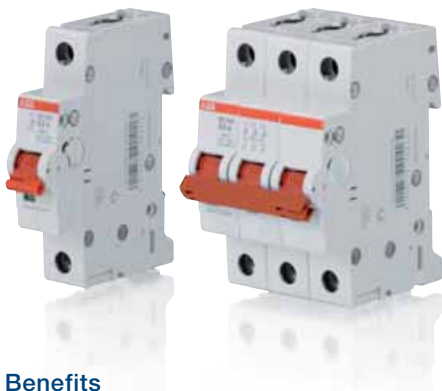

Benefits

- Performance at new level: rated voltages of 253/440V AC and short circuit current of 25 kA
- Wiring in full safety thanks to the new IP 20 finger safe terminals
- Full compatibility with MCB accessories
- Real CPI to verify the contact position
- The laser printing and the design of the devices allow a consistent optical appearance in the distribution board.

The SD 200 and SHD 200 extend the proven System pro M compact® series with new ranges of switch disconnectors which provide the state-of-the-art about safety and comfort. The new range is available with 1 to 4 poles with rated currents from 16 to 63A and provides disconnection properties according to IEC EN 60947-3.

The SD 200 offers performance on a new level. With a rated voltage of 253/440V AC, a rated conditional short circuit current of 25 kA, terminals with protection from misconnection and a "Real CPI" contact position indication, SD 200 is unique in its field of application. In addition, the range is fully compatible with all MCB accessories.

Product Note SD 200: 2CDC441015D0201

Product Note SHD 200: 2CDC441016D0201

Measurement

EQ meters complete range

Tells the story behind every kWh!

For any utility manager, landlord or anyone managing a company's or building's energy resources, a utility meter and the information it provides is not sufficient. One bill and no information of where or why energy is wasted. Sub-metering, on the other hand, provides a far more detailed picture of energy consumptions. Since the first ever DIN-Rail mounted electricity meter was produced in 1984, ABB has been providing meters with front line technology, and this time is the same. EQ meters range is leading the market for sub-metering into a higher level with its new improved and unique features; it provides a great benefit/cost ratio to the customer and its wide range, which includes three different series, is perfect to be installed in stand-alone applications, commercial or residential buildings and industries. Using the optional inbuilt interfaces for communication, the customer is able to visualize and control his energy consumption. EQ meters are designed with focus on providing accurate measures along the whole range, from low to high currents. Supplying reliable values and fulfilling the necessary approvals, the customer can always trust that the meter is telling the true story of the energy being measured. The meters are type approved according to IEC and MID.

MID approved meters are certified and have verified meter accuracy, which is a critical factor in establishing fairness in cost allocation and distribution among tenants.

Technical catalogue: 2CMC481003C0201



Benefits

- Wide range, one of the most complete electricity meter ranges from basic meters up to state-of-the-art advanced meter perfect for every situation.
- Great cost/benefit ratio, especially on the more advanced meters
- Fantastic measurement dynamics giving accurate measurements from the lowest to the highest currents.
- Fulfilling the necessary standards to be used for billing and cost distribution.

Consumer units

System pro *E* comfort MISTRAL65

Conceived for industrial applications,
but flexible and with a modern look

MISTRAL65 is the ABB's most innovative series of IP65 rated consumer units. Designed to reduce cabling times as well as allow total integration between modular DIN-rail MCBs, MCCBs and front panel devices. Thanks to the elegant and modern look it can be installed in commercial and residential environments where high level of IP protection is required.

Technical catalogues: 1SLC801013D0201



+ Benefits

- Wide choice of sizes: from 4 up to 72 mod.
- Made in thermoplastic material and available with 2 different self-extinguishing degrees and cable entries:
 - GWT 650°C (with smooth surfaces)
 - GWT 750°C (with knock-outs)
- Halogen free (version GWT 650°C)
- Available with terminals pre-installed
- Door available in 2 different finishing: blind door (RAL 7035) or the exclusive transparent "blue petrol".
- Door completely reversible and with opening up to 180°
- High mechanical strength: IK09
- High insulation protection degree: IP65
- High thermal resistance: BTP 70°C
- Elegant and unmistakable design.
- Wide range of accessories suitable for several applications (protection, control, monitoring, measurement, safety and energy efficiency, distribution system).
- Adjustable DIN-Rail distance: at 125 mm or 150 mm to optimize space.
- Several anchoring points for cable ties to optimize and make easier the wiring.
- Extractable DIN-Rail frame for an easier cabling on bench-work.
- Dedicated ranges of screwable and screwless terminals very easy to install thanks to snap-on system.



System pro *E* comfort MISTRAL[®] series. Create your own masterpiece.



Freedom is an essential factor for innovation, modernization and unlimited possibilities. The new System pro *E* comfort MISTRAL[®] series of consumer units offers you freedom in abundance. These innovative units incorporate all the great features you expect from ABB. Ample internal space, flexible configuration and a unified range of accessories make your job quicker and easier. Flush-fit and wall-mounted versions offer elegant design. And with IP41 and IP65 ratings, you can install the units in industrial, commercial and residential environments. For more information visit www.abb.com/lowvoltage

Consumer units

System pro *E* comfort MISTRAL41F

Elegant and versatile

System pro *E* comfort MISTRAL41F is the new generation of ABB's consumer units for flush mounting installation where the depth of the base box ensures a perfect balancing between internal space and the possibility of installation in thin walls. Even in plasterboard hollow wall. With a unique and elegant design, it fits any decorative requirements in residential environments. .

Technical catalogue: 1SLC801013D0201



+ Benefits

- Reduced thickness of the base box ensures the flush installation even in thin walls.
- The adjustable position of the DIN-Rail at two different depths allows the installation of most of the System pro *M* devices, such as the S 200, but also S800 and Tmax XT MCCBs.
- Symmetrical design allows the total reversibility of the front cover.
- The front cover assures a perfect horizontal levelling even if the housing box is slightly crooked.
- The screw covers can be removed without the risk to be missed, thanks to the hooking with the front cover.
- Multipurpose accessories and flanges allow the coupling (horizontal and vertical) of the housing box and a perfect management of any kind of entry conduits.
- Available in two versions of thermoplastics: GWT850°C (high fire resistant) for plasterboard walls and GWT650°C halogen free.
- Extractable DIN-Rail frame for a quick and convenient cabling
- High mechanical strength to impacts: IK08
- Door available in 2 different finishing: white (RAL9016) or the exclusive transparent “blue petrol”.
- Wide choice of sizes: from 4 up to 72 mod.
- Available in version without terminals or with the N/PE terminals pre-fitted.

Consumer units

System pro *E* comfort MISTRAL41W

Freedom and flexibility



The new System pro *E* comfort MISTRAL41W series of consumer units gives installers the freedom and flexibility to implement any type of electrical distribution system in residential buildings. The units are fast and easy to install and with their elegant design they look great anywhere. What's more, ample internal space, a choice of doors and a unified range of accessories offer endless possibilities to create high-quality work installers can be proud of.

Technical catalogue: 1SLC801013D0201



Benefits

- Door available in three versions: petrol blue, metal and opaque. Units without doors are also available.
- Door completely reversible and with opening up to 180°
- Concealed rear mounts for secure wall installation
- Symmetrical design allows reversible door that opens from the left or right.
- Unobtrusive cable entry and exit: Pre-cut knockout slots allow cable entry and exit from the top and bottom. When not used, the slots remain invisible on the outside maintaining the consumer unit's sleek look and feel.
- Lots of internal space makes cabling even easier.
- Cable clips and holes allow wires to be fastened to the frame with simple cable ties.
- Various snap-on terminal blocks for N and PE connection to be installed in the upper and lower part of the unit. Two versions offer screw or spring couplings.
- High resistance to fire and heat: GWT850°C / BPT70°C
- High resistance to mechanical impact: IK08
- Wide range of sizes available: from 2 up to 72 mod.

Enclosures

System pro *E* energy DL160

Design and functionality

With their attractive design and their functional features, the new compact distribution boards are more than captivating. The DL160 boards have been tested according to IEC 61439 and are available in all sizes as wall- or flush-mounted versions. Using a hollow-wall mounting set and a few touches, every flush-mounted compact distribution board can be installed into hollow-walls. All enclosures are earthed or double insulated and are available for 36 to 168 space units. The distribution boards have an IP43 rating. A screwable PE rail in the upper area is standard.

Brochure: 2CPC000101B0201



+ Benefits

- Attractive and modern design
- Complete range of products in both protection classes
- For wall-, flush- and hollow-wall mounting
- Complete distribution boards with integrated distribution board panels
- Empty enclosures prepared to be flexibly fitted with CombiLine-M modules
- Sheet steel and all-glass doors made of safety glazing
- Optimal cable entry using closing or membrane flanges
- CombiLine-M modules for Tmax MCCBs
- DIN-Rail spacing of the distribution board panels: 50 mm and/or 200 mm
- Generous wiring space on the left and right side
- Sophisticated wiring system
- Innovative N/PE Quick-terminals
- Safety through perforated package

Intelligent Building Control

ABB i-bus[®] KNX Power Supplies Basic

Cost efficient and reliable power supply

The new KNX Power Supply basic range provides the bus voltage for KNX installations and updates the existing offer. The KNX voltage output is short-circuit and overload protected, furthermore it is decoupled from the power supply by an integrated choke. A two colour LED indicates the device state. The connection to the KNX bus is established via a bus connection terminal. All other connections are made via 6 mm terminals equipped with a universal head screw. The power supplies are available in three different versions with bus loads of 160 mA, 320 mA and 640 mA. The 640 mA device is equipped with an additional output without choke. The new Power Supplies Basic will be available from April 2014.

Further information: www.abb.com/knx



Benefits

- Wide-range voltage input from 85 to 265V AC at 50/60 Hz for worldwide usage
- Compact size of 4 module widths within full range
- Increased efficiency factor

Intelligent Building Control

ABB i-bus[®] KNX Blower Actuators

Controlling blowers and fans in diverse applications



The new KNX Blower Actuators can be used in diverse ventilation applications. Therefore the devices feature outputs to control blowers or fans with up to three fan speeds via step or changeover control. The fan speed can be directly given, increased or decreased as well as controlled by the control value of a closed-loop controller.

Two devices are available:

- FCL/S 1.6.1.1: One fan control output and one additional switch output
- FCL/S 2.6.1.1: Two fan outputs plus two floating switch outputs.

Alternatively the second fan output can be configured as three independent switch contacts.

Further information: www.abb.com/knx



Benefits

- Comfortable 6 mm terminals equipped with a universal head screw
- Minimum dwell period can be independently configured for each fan speed
- Monitoring of control values being sent via KNX bus

ABB i-bus[®] KNX Security Panel GM/A 8.1

A professional alarm system for the KNX expert



With the new KNX Security Panel GM/A 8.1 ABB presents the first security system that is compatible with both, the international KNX standard (14543-3-x ISO / IEC) and the international standard for alarm systems (ISO / IEC 62642). Therefore the KNX Security Panel GM/A 8.1 is ready for a worldwide usage and expands business opportunities of nearly 40,000 KNX partners in 124 countries. The new system is the perfect solution for projects ranging from simple to high security requirements. This innovation is the result of more than 30 years of system and application knowledge in alarm technology and building automation at ABB. The KNX Security Panel will be available from August 2014.

Further information: www.abb.com/knx-alarm



Benefits

- Ethernet connection for programming, diagnostics and operation via a standard web browser as well as for integration into the building network
- Security sensors connected directly to panel inputs or via security bus
- Interfaces to newly developed keypads and for internal, external or remote alarming
- KNX interface for displaying alarm states and for controlling building functions via security sensors
- Universal usage for all threats in buildings like intrusion, personal attack, smoke, gas- and water leakage
- ABB provides complete product range for professional alarm systems



ABB i-bus[®] KNX Room Master. Your first step into the KNX world



Bridging the gap between conventional electrical installations and KNX world, Room Master devices offer electrical connections and control features required in defined functional areas like apartments, hotel rooms, schools or retail stores. With the internal connection of inputs and outputs, done by ETS software, planning, installation and putting into operation new electrical installations are substantially facilitated. The Room Master concept opens the door to KNX Intelligent Building Control with flexible, project specific expendabilities for residential and commercial properties. www.abb.com/knx

Protection

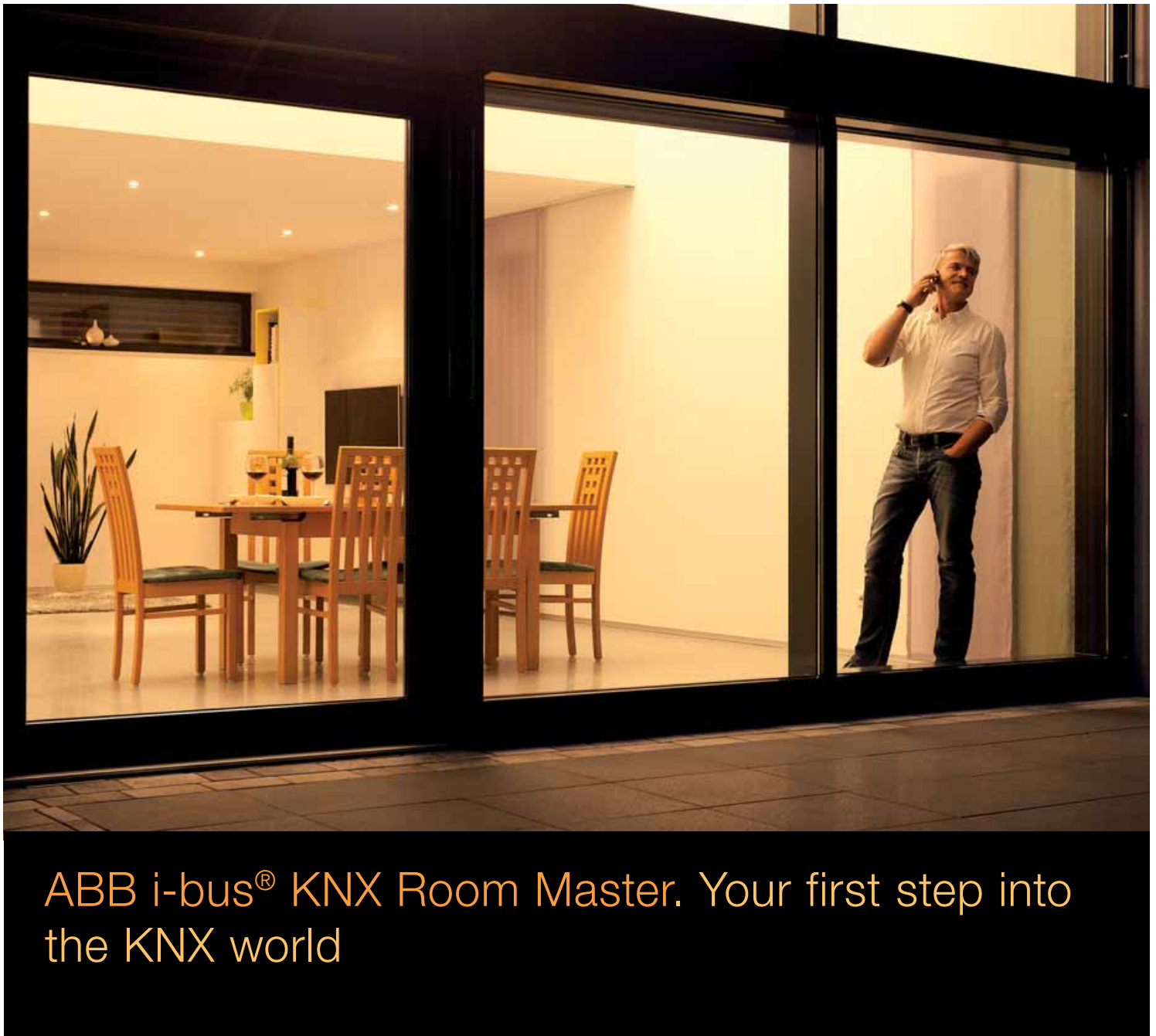
High Performance Miniature Circuit Breaker S800HV

High protection at high voltage!

The new High Performance Circuit Breaker S800HV is designed for voltages of 580/1000V AC. The S800HV is available as 1-, 2- and 3-pole version. S800HV range can be installed in combination with the S803HV-SCL-SR device, to increase the breaking capacity of the whole system up to 15kA. Due to the high rated operational voltage of 580/1000V AC the field of application is wide, such as transformer protection, motor protection, mining industry, opencast and underground, power distribution systems e. g. tunnels, lighting systems protection, protection of ventilation equipment, used for application supplied by long wires.

Product note: 2CCC413010L0201



Benefits

- Rated operational voltage of 580/1000V AC
- Rated current from 6A to 125A
- Rated short-circuit breaking capacity (Icu) of 4 kA from 6A to 63A and of 3kA from 8A to 125A rated current
- Possibility to increase the breaking capacity of the protection system up to 15 kA thanks to installation of S803HV-SCL-SR device in combination with S800HV series up to 63A.
- Fast modification on ring lug terminal is possible
- The small pole width of only 27 mm allows a space saving installation.

Power manager

SACE Emax 2

From circuit breaker to Power Manager



SACE Emax 2 is a new series of low voltage air circuit breakers up to 6300 A. With the ability to control and protect all electrical installations – from the traditional to the more complex – with minimum impact, the new SACE Emax 2 circuit breakers represent the evolution of a circuit breaker into a Power Manager.

Technical catalogue: 1SDC200023D0202



Benefits

True efficiency in plants

- Exclusive load management to reduce power absorption up to 20% and reduce energy bills
- Embedded multimeters with measurement to 0.5% Voltage, 1% Current and 2% Power, to monitor power even from afar
- All plant protections are now integrated to raise reliability and simplify projects
- Unique alarm tracking and network analyzer for the best continuity of service

The most competitive and efficient switchboards

- Up to a 25% cost savings in both footprint and copper
- Up to 15% time savings for terminal connection installation
- Up to 30% time savings for wiring connections
- Fast, safe installation of accessories and the breaker itself
- Direct communication modules for the 7 most common global network platforms, to eliminate the need for costly and difficult conversion components.



S800 B. High performance miniature circuit breakers. Simply innovative. Safety has never been easier



Limit downtime in industrial electrical systems while ensuring maximum safety for operators and ease of access to devices: S800 B high performance circuit breakers are efficient products at a reasonable cost and designed for overload and short-circuit protection in distribution systems with 16 kA breaking capacity. They comply with Standard CEI EN 60947-2 and feature 80 to 125 A rated current values with B, C, D and K characteristic curves. Thanks to a red/green signal, showing the position of internal moving contacts, and to a switch lever, that stops in the middle position in case of thermal or magnetic tripping, they show why tripping occurred at a glance, enabling prompt maintenance. Performance similar to moulded case circuit breakers but with the advantage of the compact dimension, S800 B are available from 1 to 4 poles versions. www.abb.com/lowvoltage

Power and productivity
for a better world™



In the news

Distribution and measurement, disconnection and protection: lots of new documents from ABB for those operating in the electrical business, helping them in their work.

Documents and software can be downloaded from <http://www.abb.com/abblibrary/DownloadCenter/>

Control

Wind blogs

ABB Conversation
Wind Power Blogs



Join the conversation on the trends and technologies shaping a better world. New blog posts are published in the category Renewable energy, Wind such as "How wind turbine OEMs could optimize their supply chain", or "Is the electrical drivetrain one of the most vulnerable parts of the wind turbine?",... Interested? You can find the full posts at: www.abb-conversations.com/?tag=wind Enjoy! And don't forget to share your own opinion in the comments section!



Protection

DDA 200 B APR type

Reliable in any fault situation



RCD blocks B APR type are able to provide protection in case of sinusoidal, direct pulsating, high frequency and smooth direct earth fault currents. DDA 200 B APR type are devices to be coupled with S 200 up to 63A with lower or equal rated current and together they provide protection against both earth-fault currents and overload or short-circuits. This brochure present all the main technical features and the benefits of these ABB new devices. You will find also information regarding main applications, order codes and wiring diagrams.

Brochure: 2CSC427002B0201



Measurement

CT Current Transformers

Ideal for measuring.
Designed to create efficiency.



The wide and complete range of current transformers is renewed with the introduction of the new series CT PRO XT and CT MAX, developed to ensure ease of installation and compactness in the same time, high performances and better protection thanks to the introduction of a new integrated electric circuit for the secondary protection available in for CT PRO XT SELV and CT MAX SELV.

Brochure: 2CSC446012B0201



DIN-Rail and Enclosures for residential

Compact Home residential catalogue

Your home will thank you

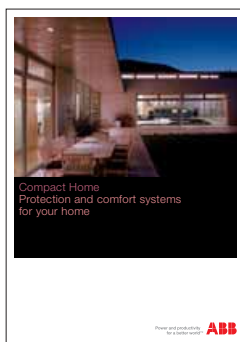

Thanks to its expertise, ABB offers the best solutions and most effective products for your customer's home. A comprehensive fully integrated range of highly reliable, easy-to-install DIN-Rail and Enclosure products. Inside this second edition you will find a wide DIN-Rail product portfolio for protection, command, alerts, comfort and energy efficiency. There is also a full section of consumer units, distribution boards and junction boxes for residential and small commercial. Moreover many application and solution examples for residential and small commercial segments are provided. If you use SH200 MCBs and FH200 RCCBs, Compact Home catalogue is your best choice.

Technical catalogue: 2CSC400030D0202



DIN-Rail products

System pro M compact®

DIN-Rail components for low voltage installation

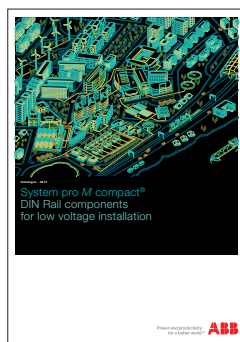

At its ninth edition in ten years, ABB's worldwide successful DIN-Rail Products catalogue for low voltage installation is fully redesigned, both in layout and in contents. Enjoy 2014 edition innovations:

- Browse products by need and application: products are now split in chapters by need, to speed up browsing and selection.
- "Page widgets": for enhanced navigation and for learning more about DIN-Rail components thanks to a wide offer of links, QR codes, cross references, tips, FAQs, frequently sold together, related documents.
- ...of course, plenty of new products: twelve brand new product families as CMS, S 200 M UC, SD200, M2M and S800 B.

Technical catalogue: 2CSC400002D0211



Consumer units

System pro E comfort MISTRAL®

Create your own masterpiece

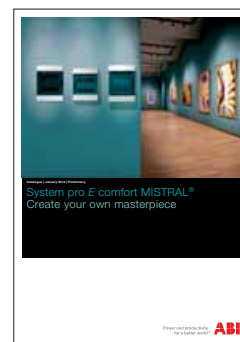

The new System pro E comfort MISTRAL series of consumer units gives you the freedom and flexibility to install almost any kind of electrical distribution system in industrial, commercial or residential environments. These innovative units have been designed from scratch to enhance the unique features you expect from ABB in terms of versatility, efficiency and safety. The new catalogue includes:

System pro E comfort MISTRAL41F

Elegant flush-mounting consumer unit for residential applications.

System pro E comfort MISTRAL41W

IP41 rated consumer unit for wall mounting installation, conceived for residential and commercial buildings.

System pro E comfort MISTRAL65

IP65 rated consumer unit designed for industrial application and environments where high level of IP protection is required. The 3 above ranges of the new System pro E comfort are available in manifold versions: without door, with blind or transparent "blue petrol" door, with or without terminals prefitted, with different thermoplastics (GWT rating) to fit any installation requirement. Moreover you will find in the catalogue information on: New Terminal blocks, Technical details on the new range, Table of resistance to chemical agents, Drawings and dimensions.

Technical catalogue: 1SLC801013D0201



Command

SD 200 - SHD 200

Peak performance
in safety and comfort

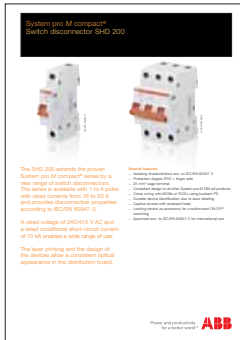

SD 200 and SHD 200 extend System pro M compact® series by a new switch disconnectors range which provides state-of-the-art safety and comfort.

The series are available with 1 to 4 poles with rated currents from 16 to 63A and provides disconnection properties according to IEC/EN 60947-3.

Discover in these product notes, the main features of this new product range, the order codes, the applications, accessories and many more useful information.

Product Notes: 2CDC441015D0201;
2CDC441016D0201



Command

T and TWA Series Twilight Switches

Savings and efficient
energy use for external
lighting

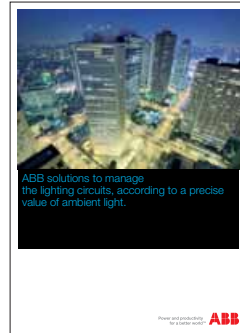

To control the automatic activation of a lighting circuit when the natural ambient light lessens and, accordingly, to ensure an efficient energy use, ABB offers a full and high-performance range of twilight switches designed to solve from the most common to the more complex applications where lighting circuit control is required.

Discover our solutions, their benefits and further information in the new Twilight Switches catalogue!

Brochure: 2CSC441022B0201





Switch disconnectors SD 200. Peak performance in safety and comfort.



Installation of switch disconnectors has never been safer and more comfortable than with the new SD 200 range. A colored real contact position indicator shows the operating status, while the optimized terminal with plane plates guarantees the right connection. However, the SD 200 has even more to offer than the highest installation comfort. The rated voltage of 253/440V AC and a rated conditional short circuit current of 25 kA qualify it for a uniquely wide range of uses. Of course, SD 200 switch disconnectors are fully compatible with all ABB System pro *M* compact® devices and accessories such as auxiliary contacts, shunt trips, under voltage releases or motor operating devices. For more information, see www.abb.com/lowvoltage



EQ meters. A step toward environmental improvement and fair cost allocation



Improving energy efficiency starts with metering. Find out where energy is being wasted and keep track of tenants' individual energy patterns. With EQ meters you gain control and can allocate costs to tenants or any type of energy users. Act responsibly and install an EQ meter today! Read more under Modular DIN-Rail Products on www.abb.com/lowvoltage

Measurement

New EQ meters Catalogue

For every sub-metering
application

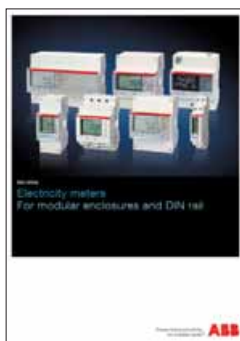

For any utility manager, landlord or anyone managing a company's or building's energy resources, a utility meter and the information it provides usually is not sufficient. One bill and no information of where or why the energy is wasted.

Sub-metering, on the other hand, provides a far more detailed picture of the energy consumption. It helps you identify specific areas where the energy consumption is too high and essentially where investments need to be made. With a sub meter you can look into the details of your energy consumption and take actions where it's needed the most.

Main catalog: 2CMC481003C0201



Measurement

EQ meters Brochure

Increased awareness



«You can't manage what you don't monitor" is an old saying and rule that applies to energy consumption. Managing energy is knowing exactly when, where and how it is being used. In order to implement "green" programs like LEED, BREEAM or ISO 50001 to reduce energy, this information is a necessity and it is provided by EQ meters from ABB. Property and facility managers will be able to meet local, national and international mandates, and allocate and distribute cost in an accurate and fair way.

Brochure: 2CMC481002B0201



Measurement

EQ meters Panorama

Reliable values of energy
consumption



EQ meters from ABB comes with a pedigree of quality and front line technology since the first ever DIN-Rail mounted meter produced by us in 1984. We drive the technology further and offer a wide modern range of electricity meters from small meters for basic usage up to advanced meters for demanding Customers. By using the flexible interface for communication you are able to see and control your consumption in a very efficient way. With the optional tariff handling functions EQ meters from ABB helps you on the way to accurate cost distribution even when complex tariff schemes are used. A lot of functions fit inside EQ meters from ABB despite its compact design and small dimensions. They are very easy to add or retrofit into you standard enclosure – the installers best friend.

Panorama: 2CMC481005B0201



Measurement

EQ meters
communication folder

Made for interaction



When you have a communication network for EQ meters, why not increase the scope and improve the cost/benefit ratio. By reading and using the extended information for the meter a facility manager or a production manager can act and reduce impact of poor demand planning or power quality.

EQ meters in A and B series has option built-in serial communication interfaces for Modbus RTU and M-Bus G13 is the new Ethernet gateway that will make data collection from a meter very convenient. It is connected via a RJ 45 to Ethernet on the supervisory side. Communication protocol JSON makes system integration more flexible and it is also equipped with a webserver that provides a detailed overview of all installed meters.

Folder: 2CMC481006B0201



Protection

High Performance
Circuit Breaker
S800HV-K

High protection at high voltage!

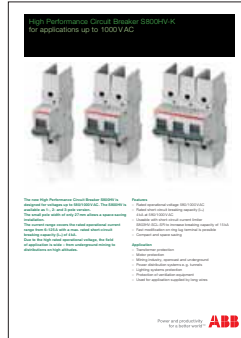

In the product note you will find all technical details, ordering data and derating table of the new High Performance Circuit Breaker S800HV and its accessories S803HV-SCL-SR.

Product note: 2CCC413010L0201



Solar segment

Solutions for solar
energy

Protection and isolation
in the DC side of PV
systems



Always ready to meet any new demand from the market, ABB has developed a whole range of reliable products dedicated to photovoltaic applications and able to meet all installation requirements, from the strings on the direct current side through to the alternate current grid connection point.

Brochure: 1SDC007350B0203



Power manager

SACE Emax 2

From circuit breaker
to Power Manager



The new SACE Emax 2 website is the direct link to our product information and marketing tools using a Personal Computer or your Mobile phone.

The web site is organized in six useful sections:

- Overview on the SACE Emax 2 family
- New Features of the innovative Ekip trip units for Load Management and Generator protection
- Benefits for the customer using Emax 2
- Extras where is possible to download all product documentations
- Service for all retrofitting kits information
- Utilities in which you can find marketing tools as infographics and demo simulator.

Web site: www.abb.com/Emax2

Technical catalogue: 1SDC200023D0202



Enclosures

System pro E Energy DL160

Design and functionality

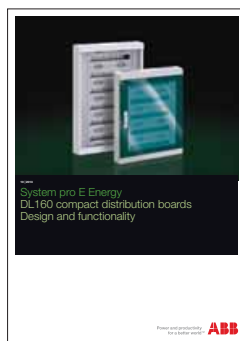

The new DL160 compact distribution boards are the perfect solution for best functionality and aesthetic design. The attractive door frame in combination with its sheet steel or all-glass door turns your DL160 into a true showpiece. In addition, its exemplary ease of assembly provides for an installation with just a flick of the wrist. This will save your time and costs.

Brochure: 2CPC000101B0201



ABB Garage Nuggets

ABB Garage Nuggets are short videos telling about ABB low voltage products and applications. All Nuggets are available on ABB YouTube channel. ABB Garage Nuggets: pearls of wisdom packed in a clear and simple format.

Video

ABB Garage Nugget#1

Seen from inside!
Hidden aspect of OVR T1 SPDs

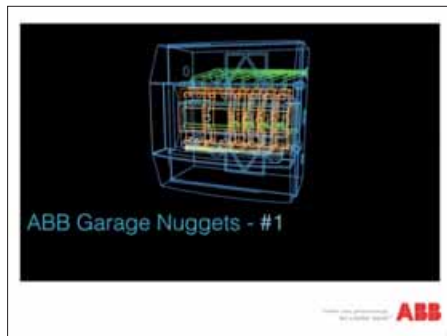

The first Nugget shows in detail the inner workings of the surge arresters OVR and their valuable preventive action, which prevents the propagation of lightning in the electrical system, thus protecting all appliances downstream.

Nugget 1: 2CSC430001E0201



Video

ABB Garage Nugget#2

Let's construct the safety on the extra low voltage



The second Nugget explores the possibility to ensure protection for direct and indirect contacts using power transformers and creating safety extra-low voltage circuits.

Nugget 2: 2CSC446013E0201



Video

ABB Garage Nugget#3

The importance of energy saving starting with a twilight switch



The third Nugget shows how the correct use of twilight switches is the ideal solution to cut consumption and pollutant emissions in several applications, from private house to public lighting systems.

Nugget 3: 2CSC441023E0201





CT PRO XT and CT MAX Current Transformers. Efficient by nature.



Measuring and monitoring the main network parameters are key operations to energy efficiency, cost reduction through consumption monitoring and service continuity. The new CT PRO XT and CT MAX series are members of the wide range of ABB current transformers and are targeted to this field of application. They are cutting-edge products, ideal for primary, secondary and power center sub-distribution panels. Specially designed to ensure very easy installation and maximum performance in terms of accuracy, the CT PRO XT and CT MAX transformers are a guarantee also about safety thanks to the introduction of the innovative electronic protection circuit of the secondary, integrated in the CT...SELV versions. www.abb.com/lowvoltage

Top 5

ABB UL-compliant solutions thought for American panel builders and worldwide equipment manufacturers who want to expand their business in the North American market. Discover our flagship products in this section.

E 90 CC

Uncompromising Performance



The E 90 CC fuse switch disconnectors have been designed in compliance with North American standards to allow manufacturers to sell their equipment in these countries.

The E 90 CC devices, usable up to 600V and 30A, can only be equipped with Class CC fuses thanks to the specially shaped handle which prevents insertion of other types of fuses, according to UL normative. The use of Class CC fuses is continuously growing in North America, due to the fact that end-user requirements in terms of safety and reliability for branch circuit protection have become more stringent in order to avoid any kind of damage to motors and linked equipment.

F200

UL 1053 Residual Current Protection



The F200 RCCBs up to 100A are approved as "Ground Fault Sensing and Relaying Equipment" according to the UL 1053 Standard, whereby the operating voltage is 277V for 2-poles RCCBs and 277/480V for the four-poles one. The marking is laser-printed directly on the residual current circuit breaker.

E 90 PV, E 9F PV

Protection for Photovoltaic Systems



E 90 PV fuse disconnectors were specifically designed for photovoltaic applications. Thanks to their rated voltage of up to 1000V DC, they are the ideal solution for protecting solar cells, inverters or surge arresters, in compliance with the UL Standard. In the case of maintenance operations, they provide secure disconnection of circuits and strings up to 1000V DC. Fitted with E 9F PV fuses in gPV curve and UL-marked, they guarantee protection up to 1000V DC.

Contactors AF

Command Devices



The new AF contactor range establishes a new industry benchmark and brings many benefits to its users. With a wide operating range (only four coils are needed to cover 24V AC / 20V DC to 500V AC/DC), product selection, management and inventory optimization is simplified. The compact size of the AF contactors helps improve assembly, installation and connection by making it both quicker and more safe. Also planning and administration is simpler, having fewer products to maintain.

With built-in safety features like the surge and noise protection, along with a reduction of the coils' energy consumption, it is easy to see why the AF technology has been so appreciated.

S 200, S 200 M, S 200 P

Miniature Circuit Breakers



The Miniature Circuit Breaker System pro *M compact*[®], S 200, S 200 M and S 200 P Series, in addition to holding various Marks and Approvals relating to IEC/EN Standards, are also certified in accordance with the UL 1077 Standard and can therefore be used as Supplementary Protectors for general use. The breaking power referring to the UL 1077 Standard is 6 kA for the S 200 and S 200 M Series circuit breakers and 10 kA for the S 200 P Series circuit breakers.

The single pole circuit breakers can be used in networks with a rated voltage of 277V AC and 60V DC, while the multi-pole versions networks are indicates for networks with a rated voltage of 480Y/277V AC and 110V DC.

Good morning DIN-Rail

ABB answers to many questions posted to our experts through email. Send your technical questions to mail.daybydin@abb.com, the most interesting ones will be published and answered on next issues of Day by DIN.

Valentina Surini: *Product Marketing Manager - DIN-Rail products*

How to identify a Group 2 medical location?

The room classification, to be carried out on the basis of the habitual use of the premises and the identification of the patient are, a must be carried out by medical personnel or in concert with the health care organization, which must indicate the types of medical treatments that may be performed.

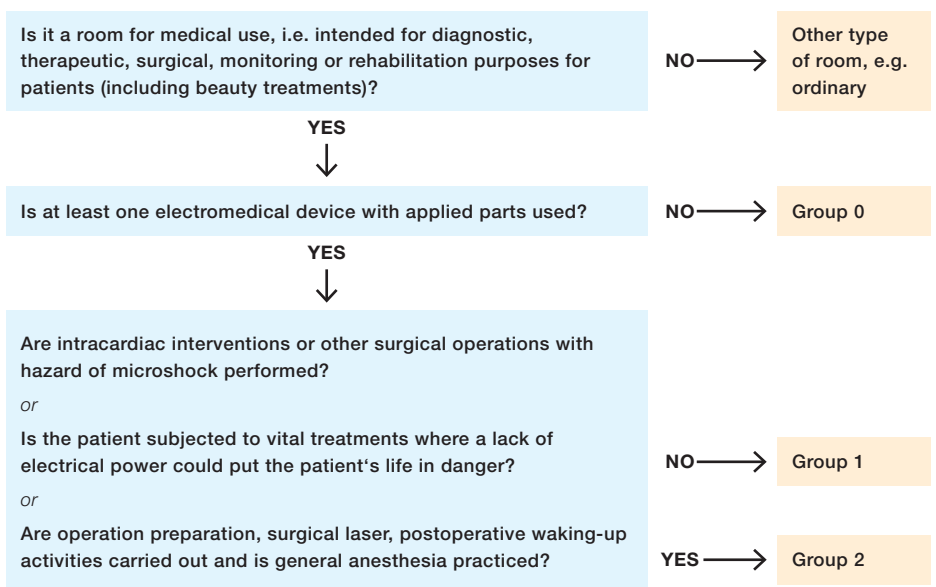

Definitions for Groups 0-1-2 medical locations

Group 0 Room: medical location where no applied parts are intended to be used. IEC 60364-7-710 - Art. 710.2.5



Group 1 Room: medical location where applied parts are intended to be used externally or invasively to any part of the body, except for the cardiac zone. IEC 60364-7-710 - Art. 710.2.6



Group 2 Room: medical location where applied parts are intended to be used in applications such as intracardiac procedures, operating theatres and vital treatment where discontinuity (failure) of the supply can cause danger to life. IEC 60364-7-710 - Art. 710.2.7



What are the proper mounting position and the correct actuating direction of circuit breakers?

Circuit breakers are normally mounted vertically or horizontally in switchboards. Installation in other positions is rather rare and, in case, it must be verified that installation condition is permitted by the manufacturer.

In any case, the installation of a circuit breaker must always observe the actuating direction conventionally established by the regulations, mainly by the EN 60447:2004 Standard, “Basic and safety principles for man-machine interface, marking and identification - Actuating principles” and by the IEC 60439-1 Standard, “Low-voltage switchgear and controlgear assemblies –

Part 1: Type-tested and partially type-tested assemblies”.

A circuit breaker mounted vertically (Figure 1) must close by moving the toggle upwards (open downwards); when mounted in a horizontal position (Figure 2), it must close by moving the toggle to the right.

If the circuit breaker is equipped with a rotary actuating device (Figure 3), the closure must occur clockwise.

A special case is the installation of a fuse switch. In this case, the device must be powered in such a way as to put the fuses out of voltage when it is in the open position, otherwise there is the risk of direct contact for the operator that replaces them.

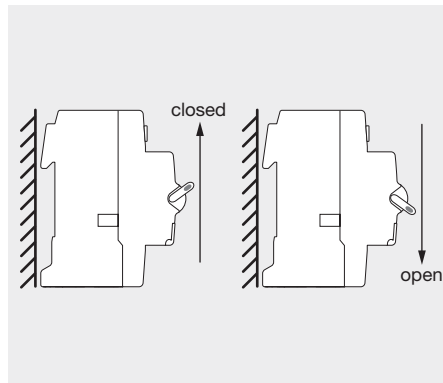

01

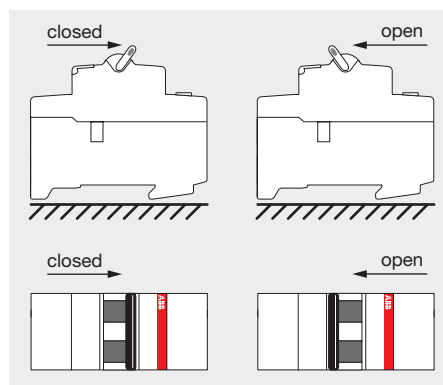

02

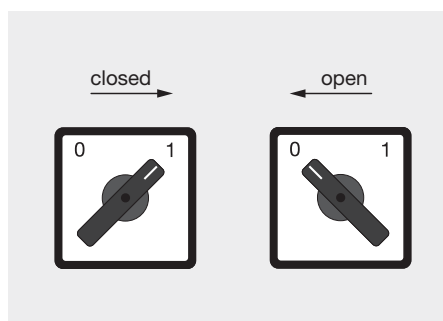

03



Valentina Surini
Product Marketing Manager
DIN-Rail Products



An elegant dental practice blends energy savings and personal comfort in harmony

Centrally located in the heart of Rome, Italy, the Dental Practice Calesini combines the sophistication of historical environments with state of the art technology, relating both to the dentistry specialization and to KNX intelligent building control system.

Thomas Rodenbusch-Mohr: *Product Marketing, KNX Intelligent Building Control*

The location, a 450-square-meter space in a building of great artistic value in the historical center of Rome, clearly reveals the dual objectives of excellence in the dental practice equipped for dental surgery: extreme sophistication of the premises and maximum technological innovation.

For this reason, great care was given to restoring the decorations of the coffered ceilings (some dating back to the 16th century), in order to win back what negligence had removed and enhance their value as historical heritage.

To improve management flexibility, security, comfort and energy monitoring the project was realized with ABB i-bus KNX, the intelligent building control system for home and building automation. The system can be fully controlled by the Busch-ComfortTouch allowing the intuitive operation of the dental practice.

A no less important criterion in selecting the ABB components was their aesthetic appeal, which met the needs and expectations of the client and of the architectural firm that prepared the interior design project.

The automation system is individually organized for each single room

The adoption of KNX standard as the mainstay element of the system testifies to the project's excellence and provides, among other aspects, the advantage of being able to freely use systems and components from multiple manufacturers, thus allowing implementation of the most appropriate solutions.

All functions of status supervision and alarm automation and management are controlled through ABB i-bus KNX with Busch-ComfortTouch with the Busch-ComfortTouch as main user interface. Located in the reception area, a key space linking the non-clinical entrance/waiting room areas and the clinical operations rooms, it allows activation of scenarios that combine lighting, music, climate control and other elements with a simple touch on the screen.

Automatic lighting and heating or cooling management triggered by the presence of persons; lighting adjustment in relation to natural light; heating or cooling interruption when the windows are open; zone-divided temperature adjustment; control of blinds with slat adjustment are only a few of the main functions that can be easily managed through the Busch-ComfortTouch.

Its screens are organized by rooms and not by functions, with system-transversal scenarios, to give priority to the overall comfort of the rooms for which all functions can be quickly monitored and set: lighting, access, cooling/heating, inclination of the blinds.

The single-room organization is reflected in the choice of components: virtually every room contains, in addition to SA/S 8.6.1 switch actuator, also a Busch-Prion control unit. Designed to manage the individual room through the circular menu shown on the 3,5" TFT display, it controls 15 functions including: lighting dimming, consumption monitoring, scenario recall, temperature adjustment, notification alarm, messages.

The touch panel is fully remotable

All important parameters and functions of intelligent building control system, of which the Busch-ComfortTouch screen is the convenient user interface, can be seen on the various terminals of the practice according to the different authorization levels. It is also quite easy to consult and supervise the entire system via tablet, smart phone or PC using the ABB IPR/S 2.1 IP router. By entering the IP address of the practice and provided, of course, that the appropriate password is available, you can manage the entire system remotely, for example opening the doors and setting the burglar alarm. Last but not least, note the possibility of real-time updated energy consumption data, which can be monitored thanks to the ZS/S 1.1 meter interface.



Professionals

Dental Surgery Practice

Studio Calesini Odontoiatria Specialistica
Dr. Gaetano Calesini
via della Croce, 77
00187 Rome

Architectural Design and Management

Ida Capra, Gianluca Graziani, Cristiana Sarapo
Architetti
viale Parioli 72/d
00197 Rome

Design, start-up, inspection testing and software creation

F.C. Automazioni srl
Giorgio Cecchini
via Gela, 79
00182 Rome

Sales representative

ABB S.p.A. – LP Division
Rome Branch
Guido Tiseo

The efficiency of KNX results in energy savings

The KNX system manages all components (including pumps and ventilation systems, not normally visible to the user and therefore at risk of being operated inefficiently and with higher consumption than necessary), activating them only if and when needed.

The integration of the various functions maximizes the return on the investments incurred by assigning more tasks to systems that usually perform only one. The burglar alarm sensors, for example, inform the boiler whether is necessary to warm the premises or tell the lighting to stay on.

The objectives, in terms of energy efficiency, are: energy savings of about 40% of the electrical energy for lighting and a significant reduction of the system's management and maintenance times and costs, since the most important parameters, and any faults and problems, are displayed on the Busch-ComfortTouch.

Enhancing the role of lighting

The lighting system can be adapted to the different needs of the individual rooms, by creating lighting scenarios that constantly regulate and correlate the brightness level upon detecting the presence of people. Natural light was given great importance and artificial lighting used carefully, always utilizing dimmable linear systems (ABB light controller LR/S 2.16.1) and for 90% with neon and LED light sources to ensure maximum energy efficiency.

The micro-LEDs integrated in the coffered ceilings provide effective lighting with a light source that is not immediately noticed, while the low-consumption artificial lighting installed in the grooves of the suspended ceilings or recessed in the dividing cabinets offer an optically non-invasive type of lighting.

The various systems controlled by the KNX system (see box on p. 37) are set to the default operating modes, aimed at comfort and energy savings, of the two scenarios relating to entering (opening) and leaving (closing) the practice.

ABB solutions meet a variety of different needs

Security system perfectly integrated into KNX

Using magnetic, mechanical and dual-technology sensors, the intrusion detection and alarm system controls the three entrances and all the windows, activating itself only when all are properly closed and there are no people present, with the obvious exception of those who insert the alarm. The intrusion detection system is inserted by approaching the transponder key to the control unit and waiting for its confirmation tone which indicates that the count of the exit time (30 sec) has started. Alternatively, the intrusion detection system can be activated/deactivated by inserting the code via the keypad or by remote control, enabled by suitable passwords and filters.

In addition to preventing and reporting a possible intrusion, the security system, when the burglar alarm mode is turned off, participates in the KNX system constantly monitoring and using the sensor states in order to power on and off the lights and the air conditioners in each room: the air conditioners are switched off when windows are opened, only to be turned on again when they are closed. Similarly, the presence sensors of the security system control the lights of the technical room and of all other rooms.

Access control with badge

The access control uses transponder badges that are anonymous, nonclonable, very handy and easily deactivated in case of loss; they do not need to be inserted into the transponder reader slot, but only swiped near it, also if kept in wallets or identification holders.

Each passage through access points of the practice is recorded in the system's memory, allowing the dedicated software to track its timetable for further processing. The passage logic and filters are customizable, so as to properly regulate the access hours of defined groups of badge holders and prohibit access to other groups. The access control uses a separate power supply for each of the two accesses (main and service) in order to ensure that at least one is always in operation.

Temperature adjustment in relation to the presence of persons

The automatic adjustment of the system follows the specifications of the client to combine the best environmental comfort with maximum energy savings and is easily managed via the Busch-ComfortTouch control unit placed in reception area. All cooling equipment can be managed individually in local mode, while the reception area, the owner's office and the anteroom of the hygiene room

can be managed also using the Busch-ComfortTouch.

The ComfortTouch® panel can also be used, in the specific air conditioning control screen, to change the fan speed and the operating mode, for example by activating only ventilation and dehumidification if the heat is very muggy. All rooms have default "comfort" scenarios for when the staff is present, and "sleep" scenarios - with the optimal temperature reduced by 4°C - when the staff is absent. This way it is only necessary to manage the seasonal selections: summer/winter and reversal of the thermostats.

Thanks to the proximity function, in the event of access the thermostat will automatically go into the comfort mode for a pre-set time of 4 minutes, after which, if no further presence of persons is detected, it imposes the reduction of energy consumption, passing into the sleep function.

Management of windows and blinds

To optimize the balance between external ambient light and internal artificial lighting, the KNX system manages both windows and blinds. The windows are moved by the JRA/S 2.230.1 actuator managed motors and controlled locally through the Busch-priOn control interfaces placed in each room or remotely through the Busch-ComfortTouch. The control panel contains general commands that allow all blinds to be moved simultaneously with different values and commands.

Morning opening

When the security system is disarmed, the KNX system automatically activates all presence sensors, opens the motorized main water valve, sets all air-conditioning and forced air inlet groups for recirculation to a default value and positions the blinds with slats at 50%, horizontally and completely lowered. The lighting in all unused rooms stays off until the first presence detection, which sends the automation system to full operation, with predefined scenarios for both occupied and empty rooms (minimum lighting level).

Evening closing

When the security system is armed, the closing procedure is initiated only when the proper closure of accesses, windows, safes and the owner's office has been verified.

In addition to preventing intrusions, the procedure is designed to ensure the security of the practice and to optimize energy savings. For this reason, the following operations are automatically activated: the water valve is shut off; the air conditioning, all air inlets, the exhausters of all bathrooms, the dental unit (i.e. the set of chair, sink, light, drill, compressor, etc.) and all the lighting, including the timed bathroom and passageway lights, are turned off. Lastly, all blinds are moved into the closed position with darkened slats.



The Busch-priOn control unit is available in various configurations.

Doktor Wise

The expert answers

The reliability of ABB experience in its responses to every need arising from the work of professionals of the sector. In this section ABB experts respond to the most frequently asked questions regarding the use of enclosures and DIN-Rail products, to solve problems and propose the most suitable solutions for every application.

Fraternal twins part 1: IEC 60898 and IEC 60947

Angelo Di Iorio: *Product Manager - DIN-Rail Products*



Is access to miniature circuit breakers restricted to instructed persons or can they be accessed by anyone?

Answering this question is the first step in understanding if you must refer to the IEC 60898-1 Standard or to the IEC 60947-2 Standard. Both of them apply to miniature circuit breakers, determining and regulating their use.

The circuit breakers that comply with the IEC EN 60898-1 Standard are intended to be used by uninstructed people.

The main difference between the two Standards is clearly indicated in the purpose of the two Standards.

The IEC 60898-1 Standard applies to circuit breakers for overcurrent protection of wiring systems in buildings and similar applications. It sets very precise limits in terms of mains frequency (50 Hz or 60 Hz), rated voltage (not exceeding 440V between phases), rated current (not exceeding 125A) and rated short-circuit capacity (not exceeding 25000A). The circuit breakers that comply with the IEC 60898-1 Standard are designed for use by uninstructed people and for not being maintained.

The IEC 60947-2 Standard applies to all cir-

cuit breakers for voltages up to 1000 V AC and 1500 V DC, whatever their rated current, construction and use may be. The circuit breakers that comply with the IEC 60947-2 Standard are intended to be used in residential, commercial and industrial sectors with the constraint that only instructed people are allowed access to the circuit breakers. The definition of an

instructed person, contained in section 826-18 of IEC 60050-826 IEC HD 60364-8 Standard, identifies a person who has technical knowledge or experience, or who has

received sufficient specific instructions to operate safely on the type of system on which, or near which, he/she must act.

The circuit breakers that comply with the IEC 60947-2 Standard may be used with the constraint that only instructed people are allowed access to the circuit breakers.

Therefore, in choosing the MCB's reference Standard one must take into account not only the type of system (industrial, commercial, residential), but above all

the persons who will have access to the circuit breakers.

In assessing the technical features, it is appropriate, for example, to refer to the IEC 60947-2 Standard for all circuit breakers that may be accessed only by instructed people (panels that are locked or placed in areas accessible only to instructed people). Conversely, the technical features according to the IEC 60898-1 Standard are to be taken into account (also in industrial environments) for all circuit breakers that may be accessed also by uninstructed people.

Fraternal twins part 2: UL and UR

Answer provided by

Valentina Surini: *Product Marketing Manager - DIN-Rail products*

Are the fuseholders with the UR and the UL approvals be interchangeable?

No, they are different products, which meet equally different needs.

UR-approved fuse holders comply with IEC Standards and they are intended to be equipped with 10.3 x 38 mm fuses. However, since they are UL-recognized, that is the meaning of UR approval, they can be used as components in UL-listed machines intended for the American market.

UL fuseholders, on the other hand, are devices specifically designed and tested according to American standards, suited to accommodate Class CC cylindrical fuses, which are products with special limitation characteristics. It is therefore not allowed to insert fuses complying with IEC 10.3 x 38 mm standards inside UL fuseholders.



Protection in compliance with IEC EN 60947-2 Annex-M Standard

Residual current relays with separate toroid

Marco Gallo: Product Manager - DIN-Rail products

The IEC 60947-2 Annex-M is the new reference Standard for the residual current protection with electronic residual current relays in low voltage electrical systems. Only the electronic residual current relays with separate toroid that comply with this standard are suitable for this type of protection and guaranteed by the manufacturer for this purpose. But what is it and how does a residual current relay work?

A residual current relay is a device that, connected to an external toroidal transformer which detects a fault current, controls the opening of its associated circuit breaker.

The illustration on the right shows the “residual current protection cycle”.

The standard sets forth that the manufacturer is responsible for respecting operating times when the product is compliant, thus relieving the installer from this responsibility. ABB therefore provides the following information:

- **Operating time**
The time that elapses between the occurrence of a fault and the opening of the relay contacts
- **Cumulative operating time**
The time that elapses between the occurrence of a fault and the opening of the associated circuit breaker

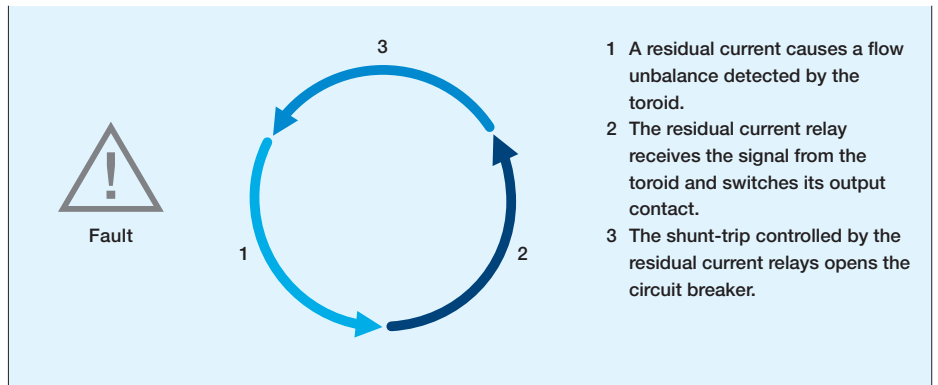

– **Non-operation time limit**

The delay, adjustable on the device, that defines how long the fault may last before the relay contacts switch. This value is important to ensure selectivity and to prevent unwanted tripping of the associated circuit breaker.

Responsibility of the manufacturer

ABB products are tested in the following configuration: ELR or RD3 +toroid+shunt-trip+MCCB/MCB.

Detailed technical documentation to facilitate installation and start-up must be provided.

The manufacturer must provide information on the associated circuit breakers, the toroids and the rated currents used during compliance testing.

The manufacturer is in charge of ensuring that the cumulative operating time of residual current relay + shunt-trip + circuit breaker comply with the standard’s requirements. The new ELR product range of front panel residual current relays and the modular RD3 products are tested according to this standard in conjunction with the Tmax series of molded case circuit breakers up to size T5 (630A).

Selection of the toroidal transformer according to IEC EN 60947-2 Annex-M

The toroid should be selected on the basis of the diameter of the hole through which all the active conductors of the line to be protected must pass and of the minimum value of the leakage current to be detected.

Table 1

Type	Toroid useful diameter [mm]	Maximum capacity [A]	Min measurable current [mA]
TRM	29	65	30
TR1	35	75	30
TR2	60	85	30
TR3	80	160	100
TR4	110	250	100
TR4/A	110	250	300
TR160	160	400	300
TR160/A	160	400	500
TR5	210	630	300
TR5/A	210	630	500

Table 1 simplifies the selection of toroidal transformers for the use of ELR and RD3 residual current relays with Tmax molded case circuit breakers up to size T5 (630A) in compliance with the Standard IEC EN 60947-2 Annex M.

Table 2

Type	Toroid useful diameter [mm]	Min measurable current [mA]	Max rated current [A]
TRM	29	30	160
TR1	35	30	250
TR2	60	30	400
TR3	80	100	800
TR4	110	100	1250
TR4/A	110	300	1250
TR160	160	300	2000
TR160/A	160	500	2000
TR5	210	300	3200
TR5/A	210	500	3200

Table 2 indicates the technical features of the toroidal transformers.

Errors in the measuring chain

Aron Svedin: Product Marketing Manager - DIN-Rail Products

Is it important to know the precision classification of a measuring instrument? How is it defined?

In which application scope is it more important to have this information?

As a rule, no measurement can be considered exact. It is therefore necessary to determine each time the range limits of the measured quantity value, defining the magnitude of the measurement error.

This magnitude of error could be different depending on where on the specified range of measurement is being measured. Usually the error is bigger in the lower end of the range.

As required by IEC standards, electric instruments are classified according to their degree of precision in the following categories.

0.05 - 0.1 - 0.2 - 0.3 - 0.5 - 1.0 - 1.5 - 2.5 - 5

These values represent the error as a percentage.

The assessment of the instrument precision is especially important in the context of energy metering as they often are used for billing. In particular, the accuracy of energy meters is expressed in precision classifications defined by specific standards:

Active energy meters class 2, 1, 0.5 S	IEC 62052-11, IEC 62053-21 IEC 62053-22
Reactive energy meters class 2	IEC 62053-23
Active energy meters class A, B, C	EN 50470-3

Different standards are characterized by different error limits. Because of different requirements in their definition, it is not possible to compare them directly, but it is possible, albeit in a simplified manner, to match the A, B, C classifications (from the least to the most precise) of the EN 50470 Standard to the 2, 1 and 0.5 classifications of the IEC 62052 and IEC 62053 Standards respectively.

What are the practical effects of an energy meter and its related current transformer's precision on the measuring chain and on the assessment of energy efficiency and savings?

It is particularly important to be aware of an instrument's precision classification in order to assess whether the measuring accuracy can be considered satisfactory.

This importance can be understood from the practical example below. Consider a system with an average power consumption of 100 kW and an average operating time of 2,000 hours per year.

In a measuring group consisting of an energy meter and current transformers, the error summation and its impact on the final measurement must be calculated using the following formula:

$$\epsilon_E = \sqrt[3]{\epsilon_c^2 + \epsilon_{ct}^2}$$

where:

- ϵ_E = percentage error measured energy
- ϵ_c = percentage error energy meter
- ϵ_{ct} = percentage error current transformer



EQ meters range

The table below shows how the change in the precision classification of the measuring instrument and of the related current transformers impacts on the overall system precision.

Choosing an instrument with a higher degree of precision provides a greater overall measuring accuracy and a lower probability of errors in consumption assessments.

The advantages are seen in the reduced energy expenditure in proportion to the reduction of the error itself. For this reason, the standards for the use of taxation-related measuring instruments (MID) regulate the use of meters and current transformers with precision degrees set forth within well defined limits.

Table 1

		No error	Example 1	Example 2	Example 3
ϵ_{ct}		0%	0,5%	1%	2%
ϵ_c		0%	0,5%	1%	2%
ϵ_E		0%	0,71%	1,41%	2,83%
Annual consumption measured with maximum error	kWh	200.000	201.420	202.820	205.650
Average energy cost	€/kWh	0,18	0,18	0,18	0,18
Total cost	€	36.000	36.256	36.507	37.017

London to Paris the Stretch target of 2014

A Group of ABB employees from Low Voltage Components Coventry have entered a team of seven riders into a challenging event that will see them cycle from London to Paris over four intense days of Cycling. The route leaving South London early on the 2nd July will be aiming to ride down the Chanselise on the 5th July finishing the event at the Eiffel Tower. The team will be covering more than 480km in four days taking on long days in the saddle and some strenuous hill climbs....

Day 1	London to Dover	145 km
Day 2	Calais to Arras	125 km
Day 3	Arras to Compiègne	125 km
Day 4	Compiègne to Paris	90 km

Who is Macmillan?

Macmillan provides support for people effected by Cancer either directly or can give support to friends and relatives of those affected. One in three of us will get cancer and it's the toughest thing most of

us will ever face. If you've been diagnosed with cancer, or a loved one has, you'll want a team of people in your corner supporting you every step of the way. Macmillan provides practical, medical and financial support and push for better cancer care.

The Team of Riders :

Tony Martson
Reeve Carter
Matt Hunter
Steve Wittingham
Alan Roadway
Kevin Lenton
Steve Hardwick

Some of our riders are riding for the challenge others riding to remember past family and friends, but all are riding in support of Macmillan Cancer Support.

Of course we can provide the horsepower and sweat but the success of the event relies on the generosity and support of us all if we are to achieve the £11.2k fundraising target. Please donate generously.



Matt Hunter
Local Business Unit Manager
Great Britain and Ireland

You can donate securely online the attached link:

www.justgiving.com/mpjhunter



Is it really just a box?

Enclosures and Design? Two aspects that people usually think are not combinable. But, ABB now shows the contrary and introduces an electrical distribution system that is easy and flexible to install and has a modern, elegant look.

In the past, the biggest challenge was to hide low voltage energy distribution systems behind inconspicuous "boxes" – grey or white, edgy and better not to be seen in public areas. Nobody wanted to have them in their living room or corridor but accepted it because it was necessary. Enclosures were only made to cover and protect the electrical components and to keep unskilled persons away from live parts.

Enclosures as design element!?

With "System pro E comfort Mistral" and "System pro E energy DL160" (please see also "Jump in the box" p. 10-14) ABB now introduces for different installation conditions new product ranges that have both, a sophisticated functionality and an attractive design. The doors are available in different colors and versions, for example in "petrol blue" that turns the boxes into a real eye catcher.

But, the new modern and aesthetic design is of course not the only advantages of ABB enclosures. The smart engineered "boxes" moreover perform advantages in handling and installing.

- Flexible N/PE Quick-terminals
- Extractable mounting frame
- Adjustable DIN-rail rows
- Innovative packaging
- Sealable panels
- Wide door opening angle (180°)
- Convenient cables management
- And many more

Good-to-know. Combination of functionality and design is not new for ABB.

The flush mounting consumer unit "UK500" is prepared to mount several design doors to highlight the room where it is installed in. If you are looking for doors in an elegant brushed stainless steel, as an eye-catching picture frame or as decoration in various colors – UK500 is the right decision.





ABB DIN-Rail socket outlet. Always connected!

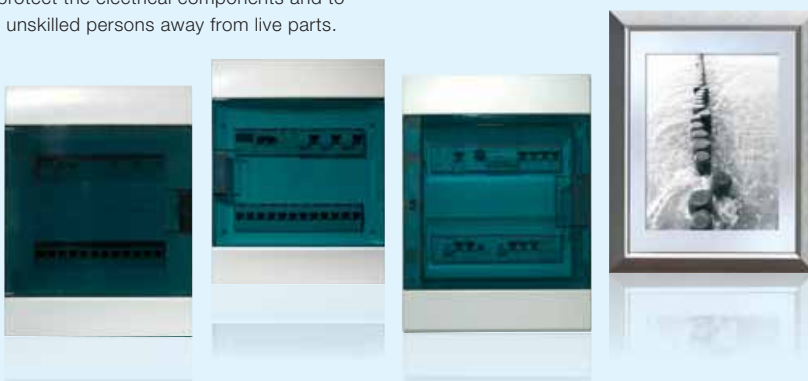

Always connected! 180 countries, 38 conforming models, 7 national standards: the ABB DIN-Rail socket outlets are not only easy to install and perfectly compliant with international regulations, but also represent a safe and effective solution for connecting non-modular devices, tools or electrical and electronic equipment inside switchboards and consumer units. Available in different colours for different applications and requirements, they are completed by a series of functions making them reliable and indispensable in many and various application situations, making maintenance and testing work easy in all four corners of the world. For a world which is always safely connected.

www.abb.com/lowvoltage



The flexible robot that works side by side with humans

ABB two-armed robot Frida was created to improve industrial production flexibility, allowing integration of automated assembly and manual labor. In this way, operators and robots can work together in the same spaces and interact in a functional manner. A further reason to design Frida with soft coatings and no sharp edges!

Guido Buttarelli: *Technical Consultant - Winning Associati*

The complete robot is composed of a flexible gripping system, a camera for locating the components and the ABB IRC5 robotic control unit. Its ultra compact size fully meets the ergonomic needs of operator designated areas.

The robot prototypes are made of two-armed portable cells with an integrated control system. They are easy to carry and can be easily mounted on workstations. Due to the intrinsic safety of the proposed solution, the parameters for an installation safety assessment are minimized. Under normal conditions, it is not necessary to protect the unit or delimit the robot's working area, allowing quick installation, commissioning and relocation operations.

The technologies employed ensure the following advantages:

- reliability in industrial assembly operations
- humanoid arms and appearance with integrated IRC5 control unit
- pairing with human labor force - safety, productivity and flexibility of the two arms, covered with soft padding
- lightweight and easy to assemble, quick work start-up
- agile movements based on ABB's industry-leading robotic technologies.

At the current development stage, several prototypes have left the research laboratory to be tested in pilot applications.

Automation joins manual assembly

Given the ever-increasing pace at which new products are placed on the market, the unpredictability of production volumes and the rapid technological development, traditional robotics is not able to create reconfigurable manufacturing systems that can be easily updated and adapted to new technologies. In some cases, manual assembly is preferable in order to minimize the initial investment costs, but it compromises future migration to automation technologies due to the safety standards.

To solve the conflict between full manual assembly and fully automated production lines, ABB has developed a new robot concept for handling small components in agile and flexible shared production systems. This concept will allow workers and robots to work together, side by side or face to face, through special interaction points.

The robot was designed for easy relocation to different assembly stations and for pairing with manual work operations at a minimal risk and without additional safety requirements, thus reducing the automation limits. Moreover, the robot construction investment costs have been kept low to provide a faster return on investment.

Thanks to the two seven-jointed arms and to the sophisticated integrated IRC5 control unit, the robot is able to perform extraordinarily agile movements and to comply with human labor cycle times also working in confined spaces without the clutter of cables. Through the kinemat-

ic redundancy of the arms, the robot's elbows can be operated independently from the central point of the tool to grip components placed on top of shelving - an agility unthinkable for a standard six-arm robot. Using special real-time algorithms to prevent collisions with other objects, it is possible to determine trajectories between the shock-proof arms without the need for human intervention.

To interact with the surrounding environment, the robot is equipped with a safe and flexible suction-cup gripping system and can be connected to video cameras in order to grip components with an even greater flexibility. Currently, however, the robot still has difficulty in performing certain tasks, such as handling trays and lifting containers. For this reason, ABB is studying appropriate solutions by testing prototype versions in various industrial applications.

Psychology also plays a role

Frida's applicability is innovative: the robot, in fact, was created to work side by side with human labor, as confirmed by the industrial design developed in the initial project phase. The trials with technicians, prototypes and pilot projects to demonstrate and test the functions and safety levels were complex and required careful analysis for a sensory system that could correctly reproduce human actions. In terms of safety, it was necessary to adopt not only a physical, but a psychological approach as well: even if the robot is reliable, human beings are in fact not willing



Frida solves the conflict between full manual assembly and fully automated production lines, allowing operators and robots to work together in shared spaces.

to work with a machine if its appearance does not communicate a sense of security. The key words (or values) below were chosen to describe the primary objectives for its appearance:

- precision
- lightweight
- reliability

It was also important to maintain the characteristic quality and design of the current ABB robot series. Color was another key point. Typically, ABB robots are orange, a color that indicates risk and danger.

However, this color choice would have been inappropriate for Frida, since it was designed to work and interact with human operators. Therefore, we chose colors that communicate good feelings (white) and reflect the softness of the padding (matte gray). The traditional orange color of the ABB robot was used instead in the semi-mobile joints, to convey a sense of precision.

Integration between ABB research centers and external experts

The project began in 2007 with the establishment of a specific ABB team, later joined by other teams in the Group's research and development centers: Sweden, Norway, Germany, China and the United States. The prototypes were manufactured and assembled in Sweden, with the exception of the gripping system which was manufactured in Germany and China. The project also included the participation of several students from universities worldwide.

Frida is the most significant example of how ABB is able to benefit not only from its internal network of experts, widespread and with a global reach, but from outside ideas and talents as well.

To understand how Frida works, please take a look at the descriptive photos and videos in the specific section of the ABB website:

www.abb.com/cawp/abbzh254/fcfdad9a72cfe08c1257862006bcfbf.aspx





SMISLINE TP. Touch proof system. Power and Safety.



Absolutely safe without protective equipment: SMISLINE TP ensures that load-free devices and components can be snapped on and off under voltage without the need for additional personal protective equipment to guard against electrical hazards. That opens up completely new prospects for you when it comes to installation, operation and flexibility. www.abb.com/lowvoltage

Temperature rise, breakers and disconnectors behavior in photovoltaic application.

Assembly engineering in the PV industry differs in different aspects to well-known AC switchgear assembly. This article provides useful wiring advices to take in consideration when designing PV panels and especially the PV breakers and disconnectors.

Adrien Fournier: *International Segment Manager, Wind & Solar*

There is no Simultaneity Factor for PV applications

Depending on the national installation rules, assembly engineering takes into consideration that not all AC consumers are active at the same time. By applying a simultaneity factor, upstream MCBs' rated currents are less than the sum of the downstream circuit breakers.

However, in PV applications, all strings produce the same solar power leading to a simultaneity factor of 1.

Ambient Temperature

The PV industry requires low voltage products operable in a large temperature range. Inverters and combiners can become very cold at night and very warm during daytime with a typical peak reached in the early afternoon.

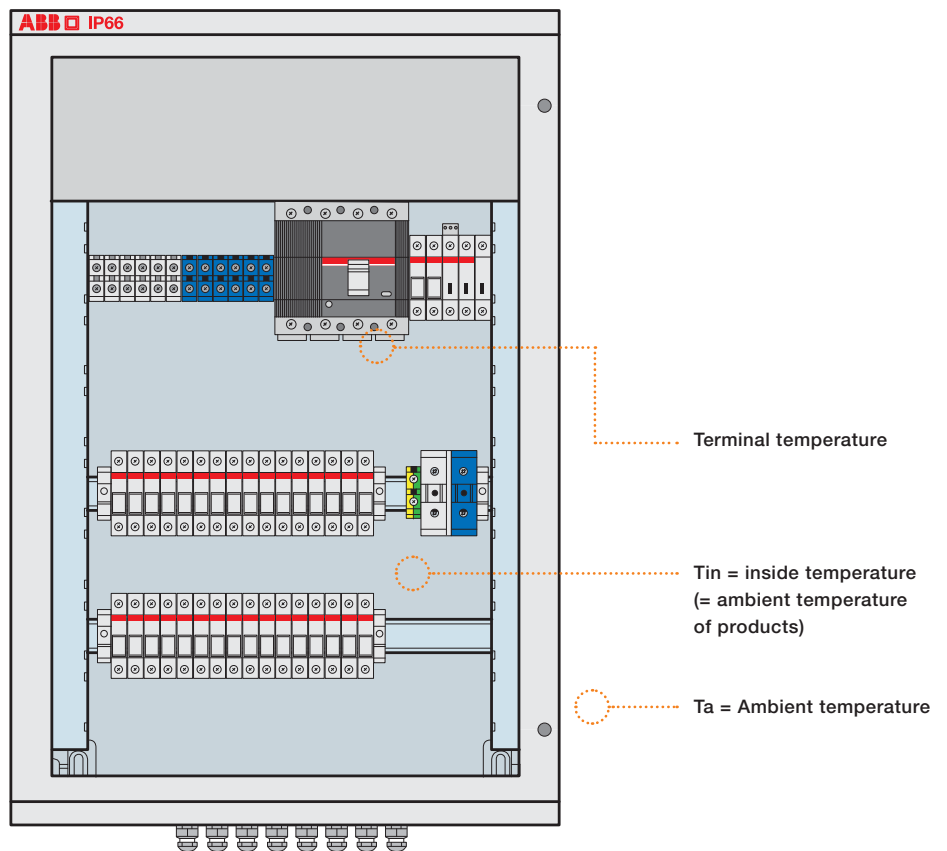



Therefore, PV breakers and disconnectors such as S800PV, TmaxPV and OTDC can be used not only in the temperature range given by the standards but also at temperatures down to -40°C and up till 70°C with regard to a certain uprating or derating factor. It's important to keep in mind that ambient temperature always refers to PV breakers or disconnectors, not the air temperature outside the combiner or inverter. The power loss as a result of internal contact resistance of PV breakers and disconnectors cabling connection and surrounding low voltage products lead to an internal heating of the enclosure. This fact must be considered when choosing the right enclosure size.

Combiner boxes should preferably be placed at locations where direct sun exposure is prohibited. Low environmental temperature usually increases the lifetime of components and the reliability of the application. A box directly put in the sun, can easily have an inside air temperature increase of 30 K. Under worst case conditions, (maximum environment temperature, maximum load, direct sunlight exposure, etc.) the internal box temperature can easily exceed 100°C .

A typical combiner containing a PV disconnector, 24 fuses for string protections (12 strings), connectors and cables, the total internal resistance of cables and components can be estimated at 0.01 ohm, which would result in a total dissipation of 100 W at 100A DC load. 100 Watt dissipation in a hermetically closed enclosure will definitely lead to a significant increase of the temperature inside the enclosure. The temperature might even exceed the temperature specifications of components inside the box. Therefore enclosure dimensions are a very important design issue.

It should also be noticed that temperature increase usually correlates with the load current square (I^2). E.g. if a 100A DC load would give a temperature rise of 30 K, 125A DC would probably result in a temperature increase of 45 K.

Pole Connection

When using three and four pole PV breakers or disconnectors, the poles must be wired in series in compliance with the assembly standards. Best practice has shown that the following variables must be considered:

- Jumper diameter (pole connector) has to comply with the cable diameter to meet the requirements of the assembly standards.
- Jumper length: Jumper length must be sufficient for PV breaker or disconnector heat dissipation as jumpers work as heat sinks. In addition, it is important to check the cable manufacturers' minimum bending radius data. Over-bending cables might affect the long term cable insulation.
- Jumper insulation: Photovoltaic cables often have extra insulation. This might lead to low heat radiation
- Tightening torque: it is necessary to respect mounting instruction for the correct terminal tightening torque value. If the tightening torque is not as specified by the manufacturer it will definitely lead to an increase of the electrical impedance, but also the thermal resistance will go up. On the long run, this might result in reliability problems or overheating
- Jumpers or equivalent busbars from different manufacturer than the PV breakers or disconnectors manufacturer may not be approved.

Enclosure Dimensioning

Against the background given above, dimensioning a PV enclosure differs from the dimensioning of a typical AC enclosure. The following variables affect the heating performance of an equipped PV enclosure.

- IP class: The tighter the enclosure, the worse the heat dissipation. For this reason, state-of-the-art inverters and combiners are equipped with heat exchangers or ventilation
- Transparent covers: Transparent enclosure covers are reported to influence the inside temperature by 40K within just a few minutes of direct solar radiation. In addition, not every transparent cover is 100% UV resistant
- Ground plate material: Metallic ground plates are reported to have positive effect on enclosure heat management.
- DIN-Rail size: Industrial DIN-Rails (15mm or higher) have a positive effect on low voltage product heat dissipation as they increase air space between the ground plate and the low voltage products
- Dimensions (volume) in general

PV breakers and disconnectors Mounting Distances

Due to the temperature related derating values of PV breakers and disconnectors, a distance between adjacent breakers or disconnectors should be considered with regard to the other variables in this context

Recommendation

It is strongly recommended to perform temperature tests on enclosure under maximum application conditions to verify the appropriate design of the enclosure. In addition, it is necessary to make sure that national and international installation standards are fulfilled.

Standards

The Installation of switches, switch-disconnectors and breaker shall comply with national and /or international standards. For the erection of panel boards these standards usually refer to IEC 61439-1 and IEC 61439-2 (low-voltage swichtgear and controlgear assemblies - part 1: general rules / - part 2: power switchgear and controlgear assemblies)

In these standards the requirements for cable dimensions, environmental conditions like max. allowed temperature, etc. are specified.

The applicant must make sure that the installation is compliant with these relevant standards e.g. IEC 61439-1 and IEC 61439-2.

Additional Information: Temperature Related First Aid

If an enclosure has not been assembled with regard to the special features described above, the following first aid advice might be helpful:

- Mounting PV breakers or disconnectors in vertical position has a positive derating effect
- Terminal tightening torque according to the mounting instructions optimizes the contact resistance between cable and terminal
- When available, the use of ring lug kits PV breakers and disconnectors usually allow the mounting of bigger cable diameters. This can have a positive effect on temperature related nuisance tripping.

Did you know that?

Is it possible to install S800 series in installation with rated voltage at 12V AC/DC?

After test made in ABB laboratories in Schaffhausen, Switzerland, it was confirmed that range of high performance MCB S800 (S800-S, -N, -C, -S-UC, -PV) are suitable to operate at a minimum voltage of 12V AC and 12V DC.

This further declaration, confirm the flexibility of use for S800 range in any kind of application, providing the highest performance for line protection and switching in a compact and sturdy DIN-Rail device.





Is it possible to switch off AC / DC?

Certainly.



The S200MUC impresses with its performance range and the accordingly large amount of approvals. Its high inbuilt short circuit breaking capacity across the entire model line, its flexible application for both direct and alternating currents and its approval and compliance in accordance with all major international and local standards make it truly unique. The miniature circuit breaker is a valuable addition to the existing System pro M compact® range which allows all known components to be combined effortlessly with the new model line. Whether warehousing and project engineering, planning and installation or maintaining your equipment, the S200 MUC is a simple and flexible solution. For more information, see www.abb.com/lowvoltage

Energy for free!

Can you afford to give away energy for free? Think if you were the owner of a petrol station and your pumps supplied petrol for free to customers if they just open the tap a bit. Okay it will take some time to fill the car but it is not measured and petrol is expensive.

This is what happens if you supply electricity and use the wrong electricity meter so you better take care. For the majority of us an electricity meter is just an “electricity meter” and we assume that meters are doing their job as they should. A meter is like a cash register in places where they are used for billing or cost sharing, they count money.

Every kWh which passes a meter is supposed to be accurate measured but when looking closer you can see that it is not always the case. Like all other technical equipment meters have their specification which indicates their abilities to perform to the task. The most commonly used quality indicator of a meter is the class of accuracy which actually indicates the inaccuracy of the meter. Outside the EU the IEC classifications Cl. 2, Cl. 1, Cl. 0,5 S and Cl. 0,2 S is commonly used. The figures in the classes indicate the maximum inaccuracy in percentage that is allowed for the meter according to the standard IEC 62053-21 and 62053-23. Within the European Union these classes range from A to C according to the MID directive. The EU classes A to C corresponds to the first three IEC classes. Now you think that meter always measure as stated and that is true but only within the area between the transitional current I_{tr} and the maximum current I_{max} of the meter. The transitional current is where the declared accuracy of a meter kicks in according to EN 50470-1.

Meter dynamics

The EN 50470-1 comprises factors to calculate the starting current I_{st} , minimum current I_{min} and the reference current I_{ref} from the transitional current I_{tr} of the meter. The reference current, is the same as the base current I_B according to IEC 62052-11. Also the IEC standard comprises factors for calculation. Thereby they indicate the behavior of the meter in the lower current range. A low reference current is better than a high in the lower measuring range. Between the mini-

imum current and the transitional current the meter is allowed to have more inaccuracy. For example is a class 1 meter in this area is allowed to have a half percent (0,5%) higher inaccuracy (see picture) and it can measure $\pm 1,5\%$. A smaller value of the transitional current will reduce the range where the meter measures less accurately. A direct connected class A meter with I_{max} 100 A and I_{ref} 20 A start measure correct first at 2 A. Between the meters starting current I_{st} and the minimum current I_{min} there is no demand for accuracy. This means up to 18,4 W can pass poorly measured at 230 V and a power factor of 1. It will go on every day and year. For an office with 10 h normal working hours and 14 h quiet hours it means about 160 kWh per year and over the meters expected lifetime of 10 years or more it is over 1600 kWh. Take that times your cost for 1 kWh and the number of meters you have and you can see what a cheap meters could cost you. For meters with comparable maximal current and the same accuracy class the one with the lowest reference/base current will always be the best one.

Conclusion

The meter with lowest reference/base current will perform best in the lower currents. Going back to the analogy with the petrol pump you may say that it just allows drops to pass without counting for payment. Can you afford to have a meter that gives away energy for free?



Mats Karlberg Oddy
Product Marketing Manager
DIN-Rail Products/Meters ABB

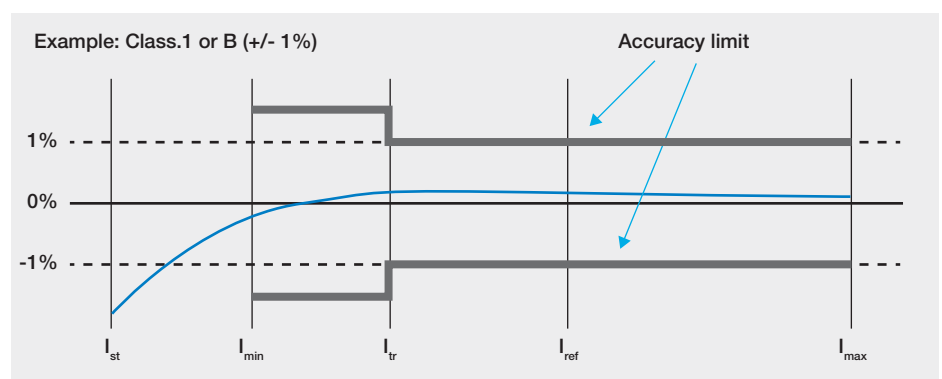



OVR PV. Excellent performances in maximum safety.
Always.



Born from the experience of ABB, the first to launch them on a market which continues to choose them, OVR PV photovoltaic SPD ensure absolute protection in the photovoltaic systems. OVR PV SPDs are equipped with a patented thermal disconnecter, with DC short circuit interruption performances, specifically designed in order to prevent the risks of overheating and fires in photovoltaic systems up to 1000 V. Thanks to this innovative technology, OVR PV SPDs are self-protected from the end of life short circuit up to 100 DC without the necessity of back up protection. This performance is guaranteed by the conformity to the UTE C61-740-51 guide.

www.abb.com/lowvoltage

From Installer to Marketing Expert

Federico Mai: *Marketing Communication Account ABB S.p.A. - ABB SACE Division*

Products, technical specifications, performance, features and application examples are essential items of knowledge to work as a professional electrical system installer. However, it is equally clear that in today's ever increasingly competitive market it becomes even more essential to acquire skills in areas that lie outside the technical sphere and allow you to stand out from the competition in order to increase your business volume: precisely for this reason this short section offers you information and tips, some "tasty tidbits" we might say. These are suggestions that we believe can help you better understand, and also apply to your work, certain marketing and communication concepts and practices that - with offer, product and price being equal - often make a difference in approaching a client by stimulating creative thinking for new ideas and solutions, or simply to help answer questions like, "Where do I start?" or "How do you do this?".

Customer Satisfaction

How to improve the quality of products and services offered by your company by identifying the needs and satisfaction level of customers

What is Customer Satisfaction?

The term Customer Satisfaction (hereinafter CS) generally means a structured process designed to measure the degree of customer satisfaction with a view to improve the products/services on offer; the term encompasses a set of techniques, tools and research methods developed since the 1990s.

The concept of satisfaction is closely linked to a customer's explicit and latent expectations and to his or her perception of the quality of the product/service purchased or used.

Caring about CS and its measurement requires a constant commitment of the management in directing all corporate behavior towards satisfying the needs of the customer, with the important result of a continuous improvement in the quality of products/services offered on the market.

Measuring CS can help achieve the following purposes:

- detect the degree of customer satisfaction with respect to the products/services currently offered;
- determine general and specific needs, wants and expectations of the various target and customer groups;
- foster the emergence of latent customer needs by listening to their comments and observations: they are generally not considered much in terms of products sold, their features and the normal provision of services activities;
- gather ideas and suggestions and encourage participation;
- verify the effectiveness of the corporate strategies adopted to achieve business objectives;
- improve communication, the level of dialog and the trust of customers.

The ultimate goal of CS is to improve the quality of products/services offered on the market. Measuring SC enables companies to get out of their self-reinforcing inwardness and to listen to Customers, redesigning products and services based on their real needs. This gives the Customer the leading role, not only as recipient of products and services, but also as a strategic resource to call upon when assessing their relevance to real needs.

Listening to customers and measuring their degree of satisfaction should be permanent and ongoing activities, to be planned and integrated into corporate strategies. CS should be framed within a comprehensive strategy action plan and must be carried out using accurate and appropriate methodologies.

Measuring CS should provide a means by which companies can redesign the operational content of their strategies for action and intervention, and should impact on specific products services with a view to improve quality and to initiate change and remodeling processes based on the feedback collected. Yet the moment you start to interact with the users of a particular product/service, you also need to be able to handle conflict and to listen, to give a reply to the requests that are being collected. Creating expectations in Customers can be a boomerang that flies back against those who generated them, if then you are not able to fulfill them. Therefore, CS is understood as an actual process and, in this sense, you should speak more correctly of CS Management. This process consists of several stages: from setting the measurement parameters to conducting the CS Survey, from analyz-



ing the data to implementing the improvement plan and the related communication measures.

The CS Survey: how to measure customer satisfaction

Measuring the quality of products/services is by now a fundamental and strategic aspect for companies, as it allows them to test their efficiency and effectiveness levels, as they are actually perceived by customers, with a view to redesign and improve performance.

As such, a CS Survey must first be properly planned, i.e. it is necessary to follow a proper process that allows you to clearly define objectives, instruments, actors and survey methods, to monitor the proper implementation of the project and of its support activities and the verification methods of the results obtained.

The basic methodological steps

In designing and implementing a CS Survey, you should follow certain basic steps that are chronologically related:

- **preparation of the survey design:** in this phase you define the intervention objectives, the methods to be used and the choice of the survey model. The result of this project phase is the preparation of the survey*;
- **completion of the preliminary investigation:** this preliminary stage allows you to collect data and information that allow you to better define the boundaries of the issues under investigation and to design more precise measuring tools. In this phase, in fact, use is made qualitative research tools, such as focus groups and interviews, in order

to highlight more accurately the quality dimensions to be taken into account in the CS Survey. At this stage, it is also useful to verify the existence of any information already available, both inside and outside the company, which could form a very useful knowledge base for setting the survey parameters. The result of this step is a summary of the main findings;

- **data collection:** in this phase, first of all an accurate identification of the survey sample is carried out (unless you opt for a diffusion within the entire reference universe identified), complying with appropriate criteria for statistical representativeness; next comes the construction of the survey tool, i.e. the questionnaire ** and then its diffusion through three main channels: self-compilation, telephone interview, personal interview. The results of this phase consist in the sampling plan (which materializes the sampling criteria applied), the service quality tree (which schematizes and defines the quality dimensions to be surveyed, starting from macro categorizations) and the survey tool;
- **processing and interpretation of the results:** in this phase, instead, the data is processed, i.e. the averages of the assessments given are calculated, providing synthetic information of the magnitude of the phenomenon studied, possibly associated with variability indicators that allow you to highlight the dispersion level of the data collected with respect to the average value. Subsequently, the data is interpreted with the purpose of highlighting strong

points, on which to implement maintenance strategies, and weak points that require, instead, action to improve the service. The result of this step consists in the research report itself, which, in addition to giving an account of the survey design and the methodology followed, has the purpose to illustrate and comment the quantitative findings obtained. The research report, which consists of both distribution tables and graphs, obtained based on the calculation of the averages and the variability indicators, and notes and description of the statistical results obtained, which are then correlated to the identification of possible improvement actions. The value of a CS Survey, in fact, is not so much to be seen in its contribution to knowledge, but much more so in its ability to offer solutions for improvement with respect to the main issues raised, thus redirecting the design of products or of service provision methods in order to make them more responsive to the needs and expectations of customers.

- **Presentation and exploitation of the results:** once the survey construction phase has been completed, it is necessary to plan and execute with precision also the reporting phase, defining with forethought to whom the results obtained must be returned, in what manner and for what purposes. In this regard, it is useful to consider the need to return the survey results - in their dual role, for knowledge's sake and, above all, in terms of providing proposals - to the actors who collaborated on its preparation. Internally, the presentation stage of the results takes on the value of an organizational self-diagnosis aimed at implementing improvement actions; externally, however, it embodies and exemplifies the company's customer focus by making its intervention strategies known to public opinion.

* and **: more details will follow in future issues of Day by DIN: stay tuned!

Day by web

I am feeling even luckier now!

Featuring 40 billion indexed pages and 330 million queries each and every day, Google is the internet entry door for most Earth inhabitants. "I'm feeling lucky" is what millions read every day, accessing the internet, on Google's homepage. These are some of the very few words appearing on homepage, as the number of characters is intentionally limited to keep page look and feel "easy". But do we really feel lucky? and how often? Not so much according to Google statistics: just one percent of keyword searches are followed by a click on "I'm feeling lucky", and this recently led Google to "instant" function, displaying search results while user types in.

No one knows if this news from ABB would make change Mountain View engineers' mind, but since few weeks the "I'm feeling lucky" button will be the best choice for ABB Customers.

ABB range of DIN-Rail Miniature Circuit Breakers S 200 are in fact now fully featured, among many more, in ABB.com website, and finding and printing the whole data sheet of - let's say - an S 201 B characteristic, 16 amperes is just a matter to insert product type on search engine bar, as the product page will appear as first result.

Even better, every single product page features now all the certificates, approvals, technical documents and 3D drawings available. Check it out now and enjoy simplicity: don't you feel luckier now?

Sources:

http://en.wikipedia.org/wiki/Google_Search
www.google.com

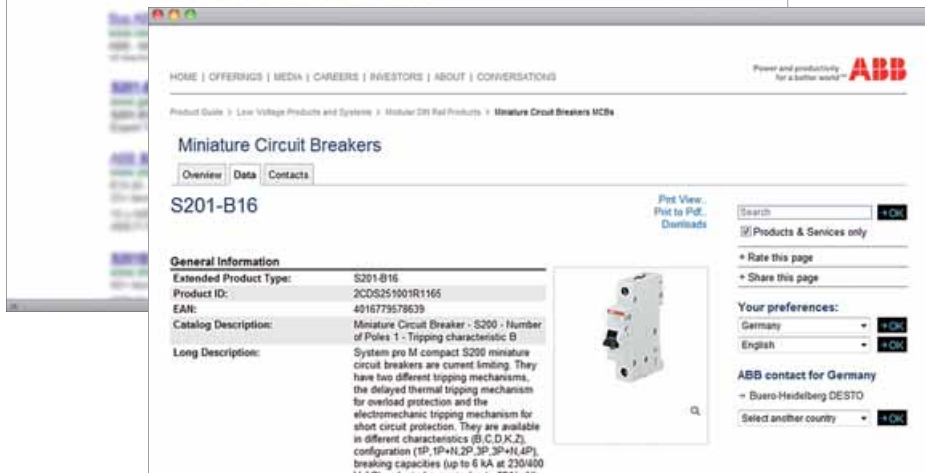

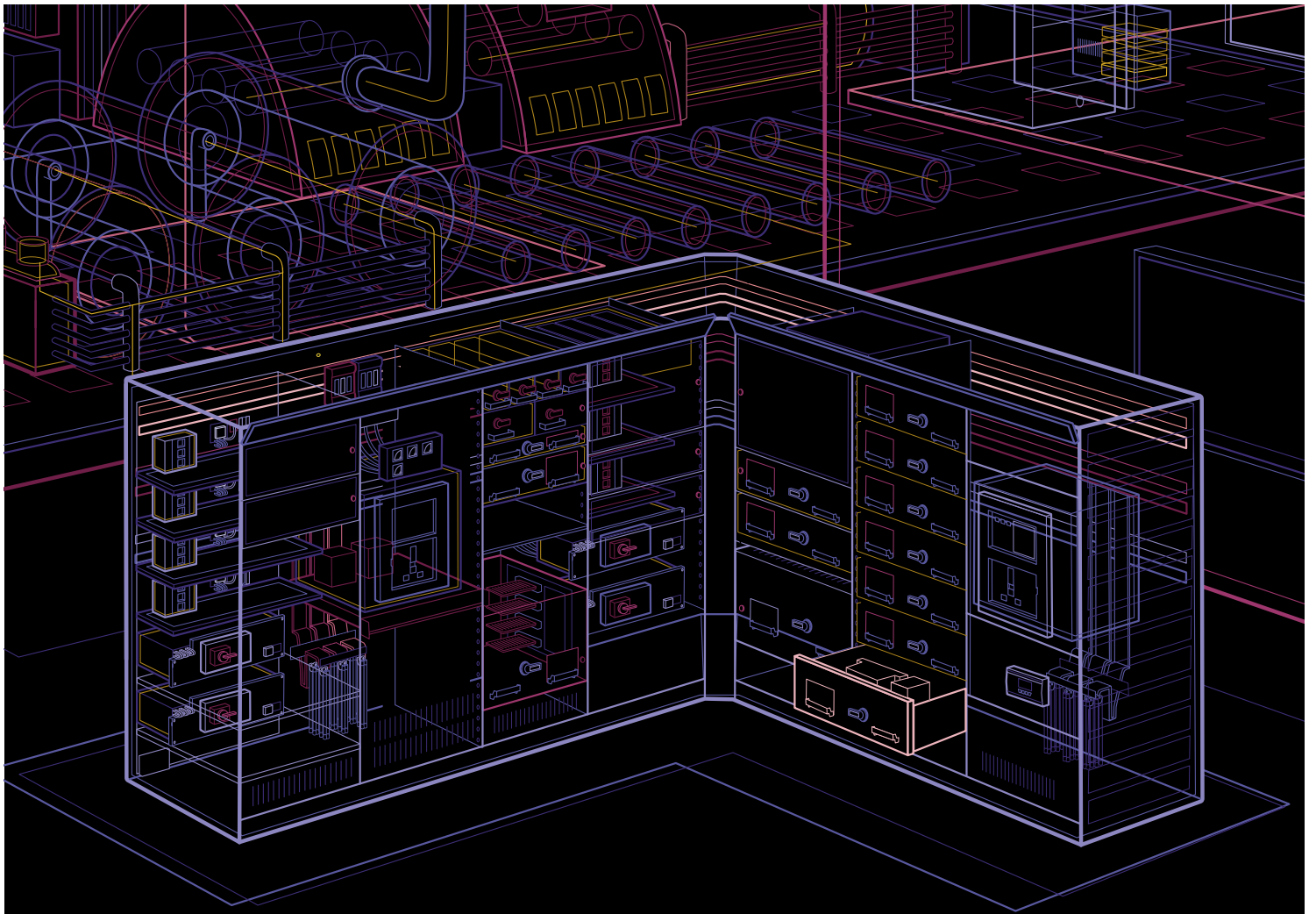

Simplify design. Connect to Control.



A reduction of the contactor's coil energy consumption by up to 80%. That means panels can be built smaller and transformers more compact. The new ABB contactor and motor protection range gives 'user friendliness' new meaning. With all the features of the AF technology along with access to drawings and coordination tables online, you can be sure to have your design and assembly process simplified. Connect to Control to see more. www.abb.com/connecttocontrol

The emergency stop according to ABB

The emergency stop device is used to interrupt a system's power supply safely and immediately. Its functioning, which must be guaranteed for the system entire life, must never allow the unexpected. There are several technical solutions for triggering an emergency shut off: here we will discover their advantages and disadvantages and illustrate the solution patented by ABB for this specific application.

Monica Meda: *Product Manager - DIN-Rail products*



The DDA 203 A AE residual current block

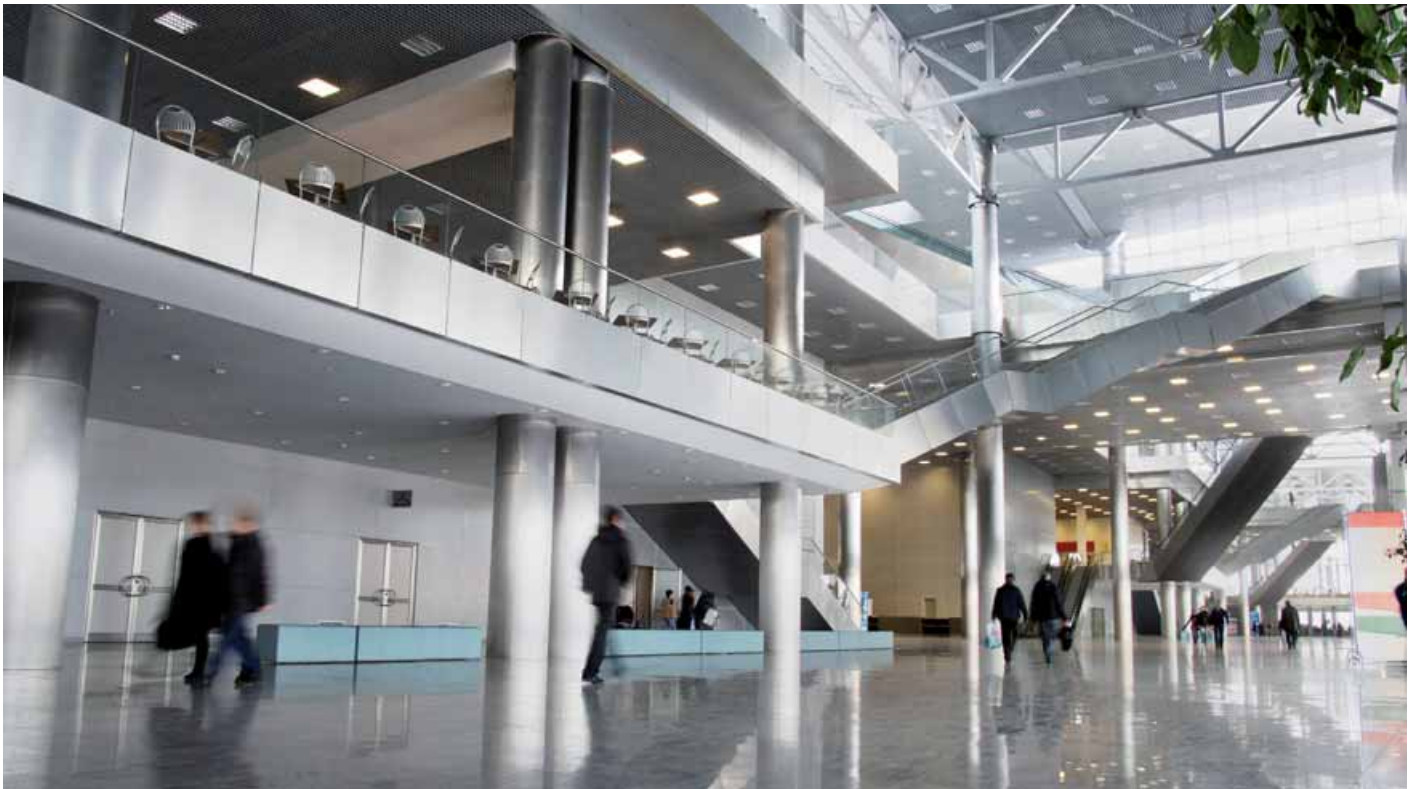

A reliable emergency circuit? With positive safety!

An emergency circuit typically has one or more buttons of the “normally closed” type connected in series in a full circlip. Each button is accompanied by a light indicator that signals correct operation when voltage is present.

This safety circuit is known as a “positive safety circuit” because an accidental breakage in the circuit is equivalent to operating an emergency control button. Power can be restored only when the emergency circuit has been repaired: this way the detection of the emergency signal is fully reliable.

The circuit opens - with a simple touch!

There are different methods for opening an electrical circuit remotely:

- with a shunt-trip coil. The shunt-trip coil is used to command the circuit opening at the push of a button. Its

operating mode, however (releases when powered), prevents its use for the construction of positive safety emergency circuits.

- with an undervoltage release. This type of device allows construction of a positive safety emergency circuit thanks to the opening of the circuit in case of supply voltage failure, whether due to pressure on a button or to the emergency circuit damages. However, the release permanent consumption (approximately 3 Watts) and the automatic circuit opening in case of supply voltage failure (including micro-interruptions) inspired ABB to develop an innovative solution to ensure the highest level of service and energy savings.

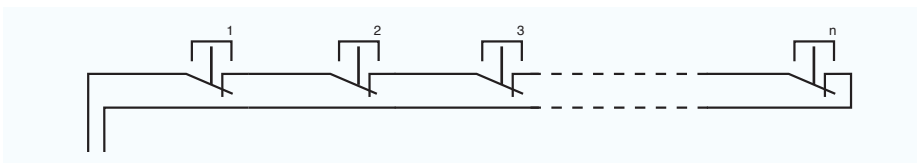

Positive safety emergency circuit

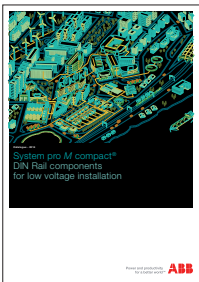
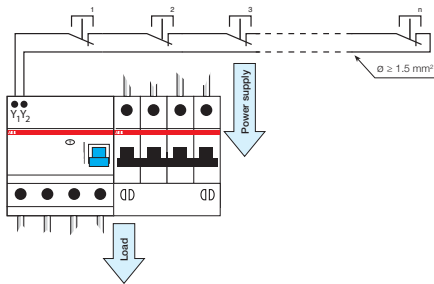

For more information, please consult or download the System Pro M compact® catalog
Code: 2CSC400002D0211

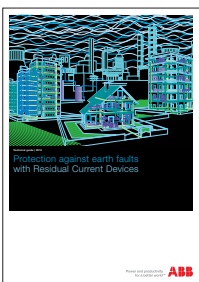

Please consult the Guide Protection against ground fault current with residual current circuit breakers
Code: 2CSC420004B0201



Monica Meda
Product Manager - DIN-Rail products

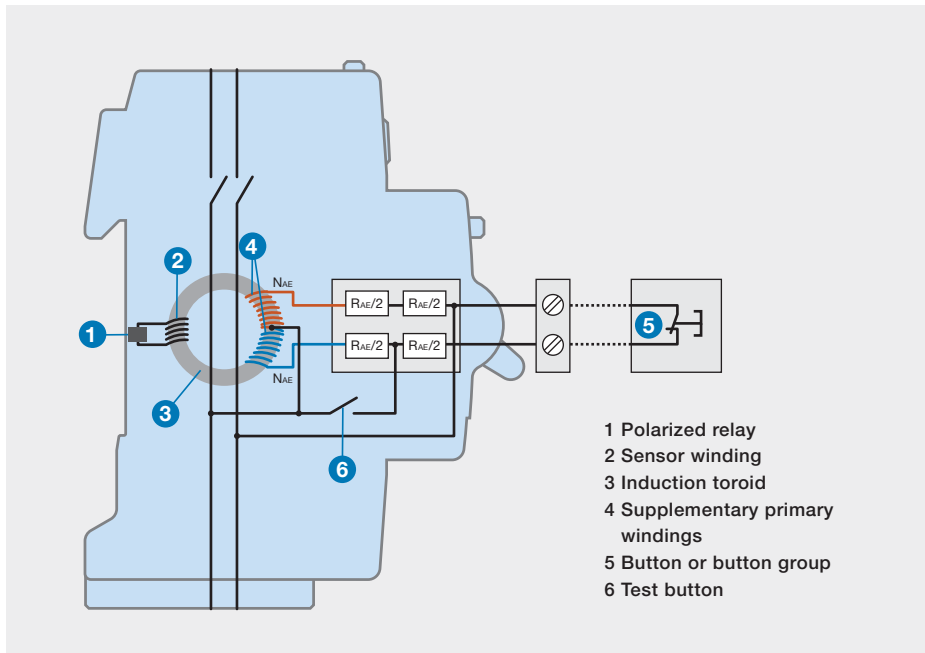

- 1 Polarized relay
- 2 Sensor winding
- 3 Induction toroid
- 4 Supplementary primary windings
- 5 Button or button group
- 6 Test button

DDA 200 AE, the emergency stop according to ABB

The residual current block DDA 200 AE Series combines the features of the residual current block and a positive safety emergency shut off with no additional accessories and a compact size.

The safety circuit wiring is very easy. Just connect it to Y1 and Y2 terminals in the upper-left corner of the product. Easier, safer!

An ABB patented operating principle

The residual current transformer is integrated with two primary circuits powered with the same voltage and having the same resistance; therefore, under normal conditions the same current would flow through, but since they are wound by the same number of coils in opposite directions they cancel each other out and do not produce any flow.

One of these two windings is also the remote control circuit: the emergency stop is obtained by interrupting the passage of current in this circuit. This clearly demonstrates the positive safety aspect: an accidental circuit breakage is equivalent to pressing an emergency actuator button.

Suitable for a variety of applications

The use of DDA AE blocks complies with the requirements of the IEC 60364-8 Standard; they are therefore suitable, among others, for escalators, lifts, hoists, electric entry barriers, machine tools, car wash equipment and conveyor belts.

The DDA 200 AE Series residual current blocks can be used in conjunction with the full range of the S 200 Series: the rated current up to 63A, the 2-3-4 pole versions and the sensitivity from 30 mA to 1A cover all applications.

Advantages

Compared to the devices commonly used in emergency circuits, the DDA AE blocks offer the following advantages:

- positive safety emergency shut off.
- continuity of service thanks to the absence of unwanted tripping if there is a reduction or temporary interruption of the mains voltage or of manual power supply shut off.
- no additional energy consumption.
- immediate and full operation even after long periods of system service shut down.



New DS202C. A type of protection that is not afraid of size



Thanks to the width of only 2 modules the DS202C RCBO series allow a saving of 50% of the space occupied in the switchgears compared to the traditional solution in 4 modules. Available in an advanced and complete technological range, the DS202C can be applied in the commercial sector, large scale industrial plants and naval applications. The new series fits in perfectly with the System pro M compact® modular range, starting with the identical form, that ensures the installation has an aesthetically coordinated appearance. And maximum protection in just 2 modules.

www.abb.com/lowvoltage

Power and productivity
for a better world™





Backup of the surge protection devices: a question of safety

Bertrand Berges: *Product Marketing Manager - DIN-Rail products/SPD*

Full compliance with the surge protection device installation procedures ensures equipment protection and service continuity



Failures caused by line surges can have catastrophic consequences

Line surges are the main cause of electronic device failures and production activity interruptions. The most dangerous power surges are caused by lightning, electrical operations on the distribution network and stray interferences. Today all sectors (residential, commercial and industrial) use electronic equipment, computer systems, automation and control systems supplied by the electricity production network. A failure of one of these systems, caused by a line surge, can have catastrophic consequences. operating time, service, data and production losses entail, in most cases, enormous costs that far outweigh the cost of surge protection devices.

Surge protection devices (SPD), commonly known as “arresters”, are designed to protect electrical systems and equipment against transient and impulse surges such as those caused by lightning and electrical operations.

Surge protection devices contain at least one non-linear component (a varistor or a spark gap) and their function is to divert the discharge or pulse current, limiting the surge in downstream equipment.

Once you have selected the SPD, it is necessary to carefully follow all of the criteria for its correct installation: among these, particularly important is the choice of the backup protection, which should always be provided for, as it ensures the arrester’s proper functioning and supports it when the end of life phase is reached.

The backup protection’s function is to open the circuit in case of failure or of a short circuit following the initial discharge.

Class 1 SPD

During the discharge, an electric arc is formed between the electrodes of the spark gap. After the passage of the discharge, the SPD must extinguish the electric arc and restore its insulation properties. This is done by means of the arc extinguishing



Bertrand Berges
Product Marketing Manager
DIN Rail Products

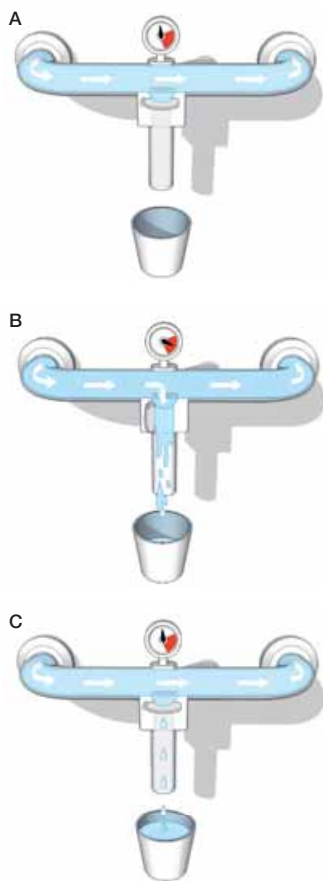

Figure 1
 A - Normal water pressure
 B - Sudden increase in pressure
 C - Worn state, valve starts to leak.

chamber. If this does not occur because the current value is too high ($I_f > I_{fi}$), the electric arc is maintained indefinitely endangering the electrical system and causing a real fire hazard. At this point the backup protection is tripped, opening the circuit and eliminating the short circuit. For this reason the backup protection ensures safety even if the arrester were to fail.

Class 2 SPD

Class 2 SPDs contain varistors. During its working life a varistor deteriorates gradually, reducing its insulating characteristics. The SPD's end of life occurs when the current flow (with the mains voltage) is high enough to provoke overheating such as to cause damage. At this point, the SPD should be disconnected from the mains to prevent fire hazards. This operation is performed by the thermal disconnecter integrated on each varistor, which disconnects it in the event of excessive heating. In certain cases, the varistor can reach its end of life in an instant (for example, after a series of discharges of strong intensity), generating a short circuit in the system. The thermal disconnecter may not be able to open the short circuit; the operation is thus performed by the backup fuse, which disconnects the SPD safely.

Using a hydraulic comparison, Class 2 SPDs may be considered as safety valves:

- when the pressure in the pipe (the voltage in the system) is normal, the valve is closed;
- when the pressure is increased (surge) that could rupture the pipes (electrical cables) or the devices connected to them, the safety valve opens the exhaust duct, draining a small amount of liquid (discharge current);
- when the normal pressure value is restored, the valve closes by itself (recovery of the insulation between phase conductors and ground).

After numerous pressure jumps, the safety valve will wear out and start to leak (the varistor is no longer able to isolate the mains). According to Joule's Law:

$$\text{Loss in Watts} = \text{Resistance} \times \text{Current}^2$$

thus...

$$R_{(large)} \times I_{(small)}^2 \times T_{(minutes)} = \text{Heat!}$$

The passage of this current through the varistor becomes problematic and leads to a dangerous heat level! (Figure 1)

Figure 2

Schematic representation	Function	Application
	Protection against indirect contact	The residual current circuit breaker is - compulsory for TT systems - indicated for TN-S, IT and TN-C-S systems - prohibited for TN-C systems Residual current circuit breakers (RCD) installed upstream of the SPDs should preferably be of type S. However, to avoid unwanted trips where possible, it is preferable to follow the scheme "3 +1" (or "1 +1" for single-phase) in which the RCD can be installed downstream of the SPD.
	Backup protection against faults or end of life	The backup RCD can be: - a circuit breaker - a fuse For Class 2 arresters, the choice depends, apart from the type of SPD, on the short circuit current of the system at the installation point.
	Thermal protection	All ABB's OVR surge protection devices are equipped with integrated thermal protection.

To prevent overheating of the varistor at the end of life, the SPD must be adequately protected with both a thermal disconnecter (integrated) and a backup protection device. The backup protection device must be quick enough to disconnect the varistor at the end of life, should the thermal disconnecter not have been able to isolate it from the mains before the heat generated causes tragic consequences.

The SPDs must be associated with a suitable backup protection device upstream and with a residual current protection device, depending on the distribution system (Figure 2).

The SPD can be protected using the line protection or by using a dedicated backup protection. The currents I_1 , I_2 and I in the various schemes are the rated currents of the protection devices (fuse or circuit breaker) (Figure 3).

Priority to protection: at the end of the SPD's life, the downstream system goes out of service and the line circuit breaker opens the circuit. To restore the power, you need to replace the used SPD (or cartridge).

Priority to service continuity: at its end of life the SPD becomes isolated from the downstream system (likewise if the backup protection device or the thermal disconnecter opens the circuit). The network's operation continues without immediate need to replace the SPD. However, in this configuration, the downstream system is no longer protected against surges until the SPD has been replaced. It is therefore necessary to replace the device as quickly as possible.

As a general rule, we recommend giving priority to service continuity, installing a backup protection device dedicated to the arrester. An SPD with a safety reserve increases the operational continuity.

The OVR Series

Surge protection devices, commonly known as arresters, are designed to protect electrical systems and equipment against transient and impulse surges.

Leveraging the technological expertise gained over decades of experience, ABB designs and manufactures a wide range of solutions for the protection of low voltage power networks and of telecommunication networks at its French plant in Bagnères-de-Bigorre, Upper Pyrenees.

The solutions cover the needs of primary distribution panels (OVR T1 Series), of small-sized systems (OVR T1 +2), of the installation at the system's origin (OVR T2) of photovoltaic installations (PV OVR), of single-phase TT systems (OVR PLUS) and of telephone equipment, computer systems and BUS systems (OVR TC).



Figure 3

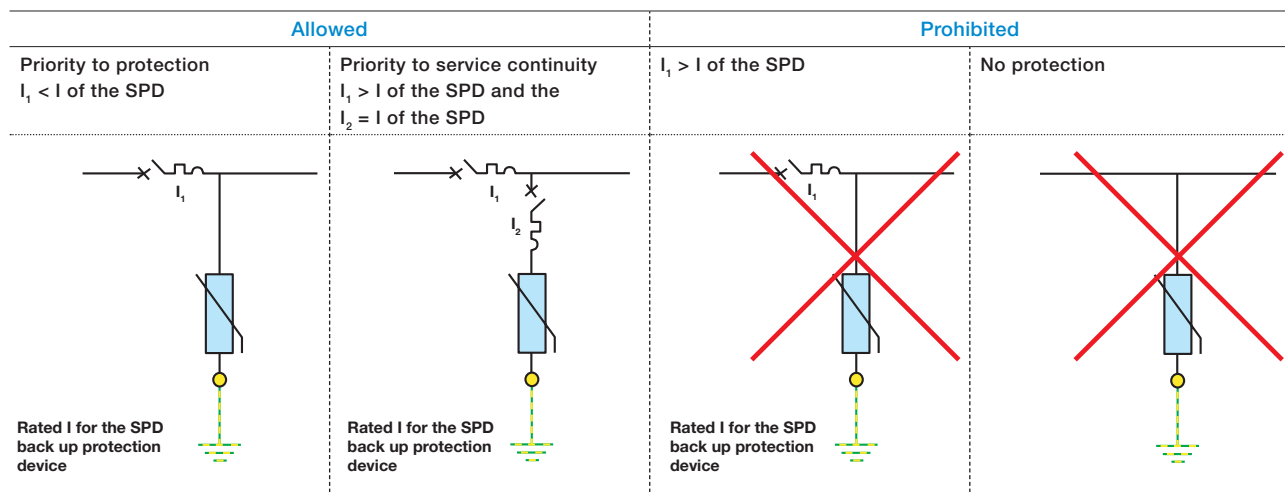

Note:
 - I_1 or I_2 : rated services of the circuit breaker(s) or fuse(s).
 - Back up I of the SPD : rated current of the recommended back up protection (given by the manufacturer)

Connect the boxes

Train your brain

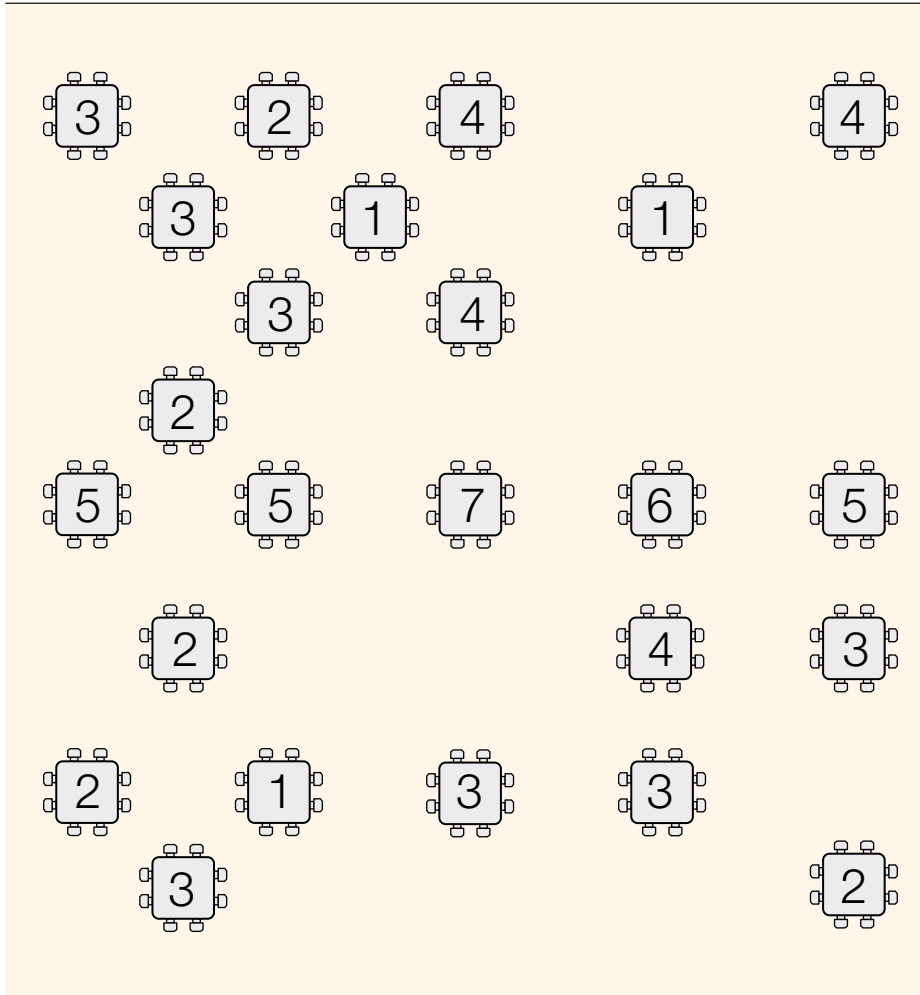

Task

You must complete an electrical system by connecting junction boxes with cable conduits.

An electrician has already installed all the junction boxes on the wall and laid down the required connections, but then he left the job unfinished without explanation.

Your task is therefore to connect all of the boxes indicated.

Instructions

- Each box must be connected to the others and the number of connections must correspond to that indicated on the box.
- Two different boxes can be connected with each other, but without exceeding two connections.
- Connections can be made either horizontally or vertically. Cross-connections are not allowed.
- There is only one correct solution and can be found purely by logical reasoning. No specific technical skills are required.

The solutions to Connect the boxes

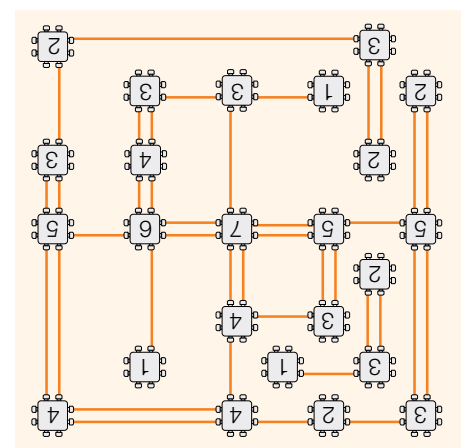

DINside View



How to produce easily the enclosures for remote measuring of energy consumptions.

Mr. Gilberto Ferrara, owner of GIL, a Company from Caselle Torinese - Italy - shows the lightness and rationality of a "full ABB" enclosure for remote monitoring of energy consumptions of electrical generators.

Send a photo of an application you have created using ABB DIN-Rail and switchgear front products to this email address: mail.daybydin@abb.com. We'll publish the most interesting ones.



T Line Twilight Switches. Understanding light to control efficiency.



Designed for automated lighting control, the new ABB T Line twilight switches can be used in all public areas where an optimal and efficient management of brightness and energy is required at sunset. The T1 versions are preset to 10 Lux and equipped with a switching delay and two LED indicators to display the setpoint value, while the advanced versions T1 PLUS, adjustable on four different scale values up to a maximum of 15,000 Lux, allow you to program the switching delay and are ideal for daytime applications. For installation on poles/walls, ABB offers the T1 POLE version, preset to 10 Lux, with integrated photoresistance and inputs for the wiring including cable gland seals.

www.abb.com/lowvoltage