

ANNEX I
SUMMARY OF PRODUCT CHARACTERISTICS

1. NAME OF THE MEDICINAL PRODUCT

Buvidal 8 mg prolonged-release solution for injection
Buvidal 16 mg prolonged-release solution for injection
Buvidal 24 mg prolonged-release solution for injection
Buvidal 32 mg prolonged-release solution for injection

2. QUALITATIVE AND QUANTITATIVE COMPOSITION

8 mg prolonged-release solution for injection

Each pre-filled syringe contains 8 mg buprenorphine

16 mg prolonged-release solution for injection

Each pre-filled syringe contains 16 mg buprenorphine

24 mg prolonged-release solution for injection

Each pre-filled syringe contains 24 mg buprenorphine

32 mg prolonged-release solution for injection

Each pre-filled syringe contains 32 mg buprenorphine

Excipient(s) with known effect

The 8 mg, 16 mg, 24 mg and 32 mg strengths contain small amounts of ethanol (alcohol), less than 100 mg per dose.

For the full list of excipients, see section 6.1.

3. PHARMACEUTICAL FORM

Prolonged-release solution for injection.
Yellowish to yellow clear liquid.

4. CLINICAL PARTICULARS

4.1 Therapeutic indications

Treatment of opioid dependence within a framework of medical, social and psychological treatment. Treatment is intended for use in adults and adolescents aged 16 years or over.

4.2 Posology and method of administration

Administration of Buvidal is restricted to healthcare professionals. Appropriate precautions, such as to conduct patient follow-up visits with clinical monitoring according to the patient's needs, should be taken when prescribing and dispensing buprenorphine. Take-home use or self-administration of the product by patients is not allowed.

Precautions to be taken before initiation of treatment

To avoid precipitating symptoms of withdrawal, treatment with Buvidal should be started when objective and clear signs of mild to moderate withdrawal are evident (see section 4.4). Consideration should be given to the types of opioid used (that is long- or short-acting opioid), time since last opioid use and the degree of opioid dependence.

- For patients using heroin or short-acting opioids, the initial dose of Buvidal must not be administered until at least 6 hours after the patient last used opioids.
- For patients receiving methadone, the methadone dose should be reduced to a maximum of 30 mg/day before starting treatment with Buvidal which should not be administered until at least 24 hours after the patient last received a methadone dose. Buvidal may trigger withdrawal symptoms in methadone-dependent patients.

Posology

Initiation of treatment in patients not already receiving buprenorphine

Patients not previously exposed to buprenorphine should receive a sublingual buprenorphine 4 mg dose and be observed for an hour before the first administration of weekly Buvidal to confirm tolerability to buprenorphine.

The recommended starting dose of Buvidal is 16 mg, with one or two additional 8 mg doses at least 1 day apart, to a target dose of 24 mg or 32 mg during the first treatment week. The recommended dose for the second treatment week is the total dose administered during the week of initiation.

Treatment with monthly Buvidal can be started after treatment initiation with weekly Buvidal, in accordance with the dose conversion in Table 1 and once patients have been stabilised on weekly treatment (four weeks or more, where practical).

Switching from sublingual buprenorphine products to Buvidal

Patients treated with sublingual buprenorphine may be switched directly to weekly or monthly Buvidal, starting on the day after the last daily buprenorphine sublingual treatment dose in accordance with the dosing recommendations in Table 1. Closer monitoring of patients is recommended during the dosing period after the switch.

Dose of daily sublingual buprenorphine	Dose of weekly Buvidal	Dose of monthly Buvidal
2-6 mg	8 mg	
8-10 mg	16 mg	64 mg
12-16 mg	24 mg	96 mg
18-24 mg	32 mg	128 mg
26-32 mg		160 mg

Patients may be switched from sublingual buprenorphine 26-32 mg directly to monthly Buvidal 160 mg with close monitoring during the dosing period after the switch.

The dose of buprenorphine in mg can differ between sublingual products, which needs to be taken into consideration on a product-by-product basis. The pharmacokinetic properties of Buvidal are described in section 5.2.

Maintenance treatment and dose adjustments

Buvidal can be administered weekly or monthly. Doses may be increased or decreased and patients can be switched between weekly and monthly products according to individual patient's needs and treating physician's clinical judgement as per recommendations in Table 1. Following switching, patients may need closer monitoring. Assessment of long-term treatment is based on 48-week data.

Supplemental dosing

A maximum of one supplemental Buvidal 8 mg dose may be administered at an unscheduled visit between regular weekly and monthly doses, based on individual patient's temporary needs. The maximum dose per week for patients who are on weekly Buvidal treatment is 32 mg with an additional 8 mg dose. The maximum dose per month for patients who are on monthly Buvidal treatment is 160 mg.

Missed doses

To avoid missed doses, the weekly dose may be administered up to 2 days before or after the weekly time point, and the monthly dose may be administered up to 1 week before or after the monthly time point.

If a dose is missed, the next dose should be administered as soon as practically possible.

Termination of treatment

If Buvidal treatment is discontinued, its prolonged-release characteristics and any withdrawal symptoms experienced by the patient must be considered, see section 4.4. If the patient is switched to treatment with sublingual buprenorphine, this should be done one week after the last weekly dose or one month after the last monthly dose of Buvidal according to the recommendations in Table 1.

Special populations

Elderly

The efficacy and safety of buprenorphine in elderly patients > 65 years have not been established. No recommendation on posology can be made.

In general, recommended dosing for elderly patients with normal renal function is the same as for younger adult patients with normal renal function. However, because elderly patients may have diminished renal/hepatic function, dose adjustment may be necessary (see Hepatic impairment and Renal impairment below).

Hepatic impairment

Buprenorphine should be used with caution in patients with moderate hepatic impairment (see section 5.2). In patients with severe hepatic impairment, the use of buprenorphine is contraindicated (see section 4.3).

Renal impairment

Modification of the buprenorphine dose is not required for patients with renal impairment. Caution is recommended when dosing patients with severe renal impairment (creatinine clearance < 30 ml/min) (see sections 4.4 and 5.2).

Paediatric population

The safety and efficacy buprenorphine in children and adolescents below 16 years of age have not been established (see section 4.4). No data are available.

Method of administration

Buvidal is intended for subcutaneous administration only. It should be injected slowly and completely into the subcutaneous tissue of different areas (buttock, thigh, abdomen, or upper arm), provided there is enough subcutaneous tissue. Each area can have multiple injection sites. Injection sites should be rotated for both weekly and monthly injections. A minimum of 8 weeks should be left before re-injecting a previously used injection site with the weekly dose. There is no clinical data supporting reinjection of the monthly dose into the same site. This is unlikely to be a safety concern. The decision to reinject at the same site should also be guided by the attending physicians' clinical judgement. Administered dose should be as a single injection and not divided. The dose must not be administered

intravascularly (intravenously), intramuscularly or intradermally (into the skin) (see section 4.4). See section 6.6 for administration instructions.

4.3 Contraindications

Hypersensitivity to the active substance or to any of the excipients listed in section 6.1

Severe respiratory insufficiency

Severe hepatic impairment

Acute alcoholism or *delirium tremens*

4.4 Special warnings and precautions for use

Administration

Care must be taken to avoid inadvertent injection of Buvidal. The dose must not be administered intravascularly (intravenously), intramuscularly or intradermally.

Intravascular such as intravenous injection would present a risk of serious harm as Buvidal forms a solid mass upon contact with body fluids, which potentially could cause blood vessel injury, occlusion, or thromboembolic events.

To minimise the risk of misuse, abuse and diversion, appropriate precautions should be taken when prescribing and dispensing buprenorphine. Healthcare professionals should administer Buvidal directly to the patient. Take-home use or self-administration of the product by patients is not allowed. Any attempts to remove the depot should be monitored throughout treatment.

Prolonged-release properties

The prolonged-release properties of the product should be considered during treatment including initiation and termination. In particular, patients with concomitant medicinal products and/or comorbidities, should be monitored for signs and symptoms of toxicity, overdose or withdrawal caused by increased or decreased levels of buprenorphine.

For pharmacokinetic properties, see section 5.2 and for treatment termination, see section 4.2.

Respiratory depression

A number of cases of death due to respiratory depression have been reported for patients being treated with buprenorphine, particularly when used in combination with benzodiazepines (see section 4.5) or when buprenorphine was not used according to prescribing information. Deaths have also been reported in association with concomitant administration of buprenorphine and other depressants such as alcohol, gabapentinoids (such as pregabalin and gabapentin) (see section 4.5) or other opioids. Buprenorphine should be used with care in patients with respiratory insufficiency (e.g. chronic obstructive pulmonary disease, asthma, cor pulmonale, decreased respiratory reserve, hypoxia, hypercapnia, pre-existing respiratory depression or kyphoscoliosis).

Buprenorphine may cause severe, possibly fatal, respiratory depression in children and non-opioid dependent persons who accidentally or deliberately use it.

CNS depression

Buprenorphine may cause drowsiness particularly when taken together with alcohol or central nervous system depressants such as benzodiazepines, tranquilisers, sedatives, gabapentinoids or hypnotics (see sections 4.5 and 4.7).

Dependence

Buprenorphine is a partial agonist at the mu-opiate receptor and chronic administration can produce opioid dependence.

Serotonin syndrome

Concomitant administration of Buvidal and other serotonergic agents, such as MAO inhibitors, selective serotonin re-uptake inhibitors (SSRIs), serotonin norepinephrine re-uptake inhibitors (SNRIs) or tricyclic antidepressants may result in serotonin syndrome, a potentially life-threatening condition (see section 4.5). If concomitant treatment with other serotonergic agents is clinically warranted, careful observation of the patient is advised, particularly during treatment initiation and dose increases.

Symptoms of serotonin syndrome may include mental-status changes, autonomic instability, neuromuscular abnormalities, and/or gastrointestinal symptoms. If serotonin syndrome is suspected, a dose reduction or discontinuation of therapy should be considered depending on the severity of the symptoms.

Hepatitis and hepatic events

Baseline liver function tests and documentation of viral hepatitis status are recommended prior to starting therapy. Patients who are positive for viral hepatitis, on certain concomitant medicinal products (see section 4.5) and/or who have existing liver dysfunction are at greater risk of liver injury. Regular monitoring of the liver function is recommended.

Cases of acute hepatic injury have been reported in opioid-dependent patients both in clinical studies and in post-marketing adverse reaction reports with medicinal products containing buprenorphine. The spectrum of abnormalities ranges from transient asymptomatic elevations in hepatic transaminases to case reports of cytolytic hepatitis, hepatic failure, hepatic necrosis, hepatorenal syndrome, hepatic encephalopathy and death. In many cases, the presence of pre-existing liver enzyme abnormalities, genetic disease, infection with hepatitis B or hepatitis C virus, alcohol abuse, anorexia, concomitant use of other potentially hepatotoxic medicinal products and ongoing injecting drug use may have a causative or contributory role. These underlying factors must be taken into consideration before prescribing buprenorphine and during treatment. When a hepatic event is suspected, further biological and aetiological evaluation is required. Depending on the findings, Buvidal may be discontinued. Monitoring beyond the weekly and monthly treatment period may be needed. If treatment is continued, hepatic function should be monitored closely.

Precipitation of opioid withdrawal syndrome

When initiating treatment with buprenorphine, it is important to be aware of the partial agonist profile of buprenorphine. Buprenorphine products have caused precipitated withdrawal symptoms in opioid-dependent patients when administered before the agonist effects resulting from recent opioid use or misuse have subsided. To avoid precipitated withdrawal, induction must be undertaken when objective signs and symptoms of mild to moderate withdrawal are evident (see section 4.2).

Discontinuation of treatment may result in a withdrawal syndrome that may be delayed in onset.

Hepatic impairment

Buprenorphine is extensively metabolised in the liver. Patients with moderate hepatic impairment should be monitored for signs and symptoms of precipitated opioid withdrawal, toxicity or overdose caused by increased levels of buprenorphine. Buprenorphine should be used with caution in patients with moderate hepatic impairment (see sections 4.2 and 5.2). Hepatic function should be monitored regularly whilst on treatment. The use of buprenorphine is contraindicated in patients with severe hepatic impairment (see section 4.3).

Renal impairment

Metabolites of buprenorphine accumulate in patients with renal failure. Caution is recommended when dosing patients with severe renal impairment (creatinine clearance < 30 ml/min), see sections 4.2 and 5.2.

QT prolongation

Caution should be exercised when co-administering Buvidal with other medicinal products that prolong the QT interval and in patients with a history of long QT syndrome or other risk factors for QT prolongation.

Acute pain management

For management of acute pain during continued use of Buvidal, a combination of use of opioids with high mu-opioid receptor affinity (e.g. fentanyl), non-opioid analgesics and regional anaesthesia might be necessary. Titration of oral or intravenous short-acting opioid pain medicinal products (immediate-release morphine, oxycodone or fentanyl) to the desired analgesic effect in patients treated with Buvidal might require higher doses. Patients should be monitored during treatment.

Use in children and adolescents

The safety and efficacy of buprenorphine in children below the age of 16 years have not been established (see section 4.2). Due to limited data in adolescents (aged 16 or 17 years), patients in this age group should be monitored closely during treatment.

Sleep-related breathing disorders

Opioids can cause sleep-related breathing disorders including central sleep apnoea (CSA) and sleep-related hypoxemia. Opioid use increases the risk of CSA in a dose-dependent fashion. In patients who present with CSA, consider decreasing the total opioid dosage.

Class effects

Opioids may cause orthostatic hypotension.

Opioids may elevate cerebrospinal fluid pressure, which may cause seizures. Therefore, opioids should be used with caution in patients with head injury, intracranial lesions, other circumstances where cerebrospinal pressure may be increased, or history of seizure.

Opioids should be used with caution in patients with hypotension, prostatic hypertrophy or urethral stenosis.

Opioid-induced miosis, changes in the level of consciousness or changes in the perception of pain as a symptom of disease may interfere with patient evaluation or obscure the diagnosis or clinical course of concomitant disease.

Opioids should be used with caution in patients with myxoedema, hypothyroidism, or adrenal cortical insufficiency (e.g. Addison's disease).

Opioids have been shown to increase intracholedochal pressure, and should be used with caution in patients with dysfunction of the biliary tract.

4.5 Interaction with other medicinal products and other forms of interaction

No interaction studies have been performed with Buvidal.

Buprenorphine should be used cautiously when co-administered with:

- benzodiazepines: This combination may result in death due to respiratory depression of central origin. Therefore, dosages must be closely monitored and this combination must be avoided in cases where there is a risk of misuse. Patients should be warned that it is extremely dangerous to self-administer non-prescribed benzodiazepines whilst taking this product, and should also be cautioned to use benzodiazepines concurrently with this product only as directed by their physician (see section 4.4).
- gabapentinoids: This combination may result in death due to respiratory depression. Therefore, dosages must be closely monitored and this combination must be avoided in cases where there is a risk of misuse. Patients should be cautioned to use gabapentinoids (such as pregabalin and gabapentin) concurrently with this product only as directed by their physician (see section 4.4).
- alcoholic drinks or medicinal products containing alcohol as alcohol increases the sedative effect of buprenorphine (see section 4.7).
- other central nervous system depressants: Other opioid derivatives (e.g. methadone, analgesics and antitussives); certain antidepressants, sedative H₁-receptor antagonists, barbiturates, anxiolytics other than benzodiazepines, antipsychotics, clonidine and related substances. These combinations increase central nervous system depression. The reduced level of alertness can make driving and using machinery hazardous (see section 4.7).
- opioid analgesics: Adequate analgesia may be difficult to achieve when administering a full opioid agonist in patients receiving buprenorphine. The potential for overdose also exists with a full agonist, especially when attempting to overcome buprenorphine partial agonist effects, or when buprenorphine plasma levels are declining (see section 4.4)
- naltrexone and nalmeferne: These are opioid antagonists that can block the pharmacological effects of buprenorphine. For opioid-dependent patients currently receiving buprenorphine treatment, naltrexone may precipitate a sudden onset of prolonged and intense opioid withdrawal symptoms. For patients currently receiving naltrexone treatment, the intended therapeutic effects of buprenorphine administration may be blocked by naltrexone.
- Buprenorphine is metabolised to norbuprenorphine primarily by CYP3A4. The effects on buprenorphine exposure in patients treated with Buvidal have not been studied. Interaction with co-administered inducers or inhibitors have been established in studies using transmucosal and transdermal buprenorphine. Buprenorphine is also metabolised to buprenorphine-3 β -glucuronide by UGT1A1.
 - CYP3A4 inhibitors may inhibit the metabolism of buprenorphine resulting in increased C_{max} and AUC of buprenorphine and norbuprenorphine. Buvidal avoids first-pass effects and CYP3A4 inhibitors (e.g. protease inhibitors like ritonavir, nelfinavir or indinavir, orazole antifungals such as ketoconazole or itraconazole, or macrolide antibiotics) are expected to have less effects on buprenorphine metabolism when co-administered with Buvidal as compared to when co-administered with sublingual buprenorphine. When switching from sublingual buprenorphine to Buvidal, patients may need to be monitored to ensure plasma buprenorphine levels are adequate. Patients already on Buvidal who start treatment with CYP3A4 inhibitors should be treated with weekly Buvidal and be monitored for signs and symptoms of overtreatment. Conversely, if a patient who is concomitantly treated with Buvidal and a CYP3A4 inhibitor stops treatment with the CYP3A4 inhibitor, the patient should be monitored for symptoms of withdrawal.
 - CYP3A4 inducers may induce the metabolism of buprenorphine resulting in decreased buprenorphine levels. Buvidal avoids first-pass effects and CYP3A4 inducers (e.g. phenobarbital, carbamazepine, phenytoin or rifampicin) are expected to have less effects on buprenorphine metabolism when co-administered with Buvidal as compared to when co-administered with sublingual buprenorphine. When switching from sublingual buprenorphine to Buvidal, patients may need to be monitored to ensure plasma buprenorphine levels are adequate. Patients already on Buvidal who start treatment with CYP3A4 inducers should be treated with weekly Buvidal and be monitored for signs and symptoms of withdrawal. Conversely, if a patient who is concomitantly treated with Buvidal and a CYP3A4 inducer stops treatment with the CYP3A4 inducer, the patient should be monitored for symptoms of overtreatment.

- UGT1A1 inhibitors may affect the systemic exposure of buprenorphine.
- monoamine oxidase inhibitors (MAOI): Possible exacerbation of the opioids effects, based on experience with morphine.
- Serotonergic medicinal products, such as MAO inhibitors, selective serotonin re-uptake inhibitors (SSRIs), serotonin norepinephrine re-uptake inhibitors (SNRIs) or tricyclic antidepressants as the risk of serotonin syndrome, a potentially life-threatening condition, is increased (see section 4.4).

4.6 Fertility, pregnancy and lactation

Pregnancy

There are no or limited data from the use of buprenorphine in pregnant women. Animal studies do not indicate reproductive toxicity (see section 5.3). Buprenorphine should be used during pregnancy only if the potential benefit outweighs the potential risk to the foetus.

Towards the end of pregnancy, buprenorphine may induce respiratory depression in the newborn infant even after a short period of administration. Long-term administration during the last three months of pregnancy may cause a withdrawal syndrome in the neonate (e.g. hypertonia, neonatal tremor, neonatal agitation, myoclonus or convulsions). The syndrome is generally delayed from several hours to several days after birth.

Due to the long half-life of buprenorphine, neonatal monitoring for several days after birth should be considered to prevent the risk of respiratory depression or withdrawal syndrome in neonates.

Breast-feeding

Buprenorphine and its metabolites are excreted in human breast milk and Buvidal should be used with caution during breast-feeding.

Fertility

There are no or limited data on effects of buprenorphine on human fertility. An effect of buprenorphine on fertility in animals has not been seen (see section 5.3).

4.7 Effects on ability to drive and use machines

Buprenorphine has minor to moderate influence on the ability to drive and use machines when administered to opioid-dependent patients. Buprenorphine may cause drowsiness, dizziness or impaired thinking, especially during treatment induction and dose adjustment. If used together with alcohol or central nervous system depressants, the effect is likely to be more pronounced (see sections 4.4. and 4.5).

The patient should be cautioned not to drive or operate hazardous machinery whilst taking this medicine until it is known how the patient is affected by the medicine. An individual recommendation should be given by the treating healthcare professional.

4.8 Undesirable effects

Summary of the safety profile

The adverse reactions most frequently reported for buprenorphine are headache, nausea, hyperhidrosis, insomnia, drug withdrawal syndrome and pain.

Tabulated list of adverse reactions

Table 2 presents adverse reactions reported for buprenorphine, including Buvidal. The following terms and frequencies are applied: very common ($\geq 1/10$), common ($\geq 1/100$ to $< 1/10$), uncommon ($\geq 1/1000$ to $< 1/100$) and frequency not known (cannot be estimated from available data).

Table 2. Adverse reactions listed by body system				
System Organ Class	Very common	Common	Uncommon	Not known
Infections and infestations		Infection Influenza Pharyngitis Rhinitis	Injection site cellulitis	
Blood and lymphatic system disorders		Lymphadenopathy		
Immune system disorders		Hypersensitivity		
Metabolism and nutrition disorders		Decreased appetite		
Psychiatric disorders	Insomnia	Anxiety Agitation Depression Hostility Nervousness Thinking abnormal Paranoia Medical dependence		Hallucinations Euphoric mood
Nervous system disorders	Headache	Somnolence Dizziness Migraine Paraesthesia Syncope Tremor Hypertonia Speech disorders		
Eye disorders		Lacrimonal disorder Mydriasis Miosis		
Ear and labyrinth disorders			Vertigo	
Cardiac disorders		Palpitations		
Vascular disorders		Vasodilation Hypotension		
Respiratory, thoracic and mediastinal disorders		Cough Dyspnoea Yawning Asthma Bronchitis		
Gastrointestinal disorders	Nausea	Constipation Vomiting Abdominal pain Flatulence Dyspepsia Dry mouth Diarrhoea Gastrointestinal disorder		

Table 2. Adverse reactions listed by body system				
System Organ Class	Very common	Common	Uncommon	Not known
Hepatobiliary disorders			Alanine aminotransferase increased Aspartate aminotransferase increased Hepatic enzymes increased	
Skin and subcutaneous tissue disorders		Rash Pruritus Urticaria	Rash macular	Erythema
Musculoskeletal and connective tissue disorders		Arthralgia Back pain Myalgia Muscle spasms Neck pain Bone pain		
Renal and urinary disorders				Urinary retention
Reproductive system and breast disorders		Dysmenorrhoea		
General disorders and administration site conditions	Hyperhidrosis Drug withdrawal syndrome Pain	Injection site pain Injection site pruritus Injection site erythema Injection site swelling Injection site reaction Injection site induration Injection site mass Oedema peripheral Asthenia Malaise Pyrexia Chills Neonatal withdrawal syndrome Chest pain	Injection site inflammation Injection site bruising Injection site urticaria	
Investigations		Abnormal liver function tests		
Injury, poisoning and procedural complications			Procedural dizziness	

Description of selected adverse reactions

Injection site reactions

In the double-blind, phase 3 efficacy trial, injection site-related adverse reactions were observed in 36 (16.9%) of the 213 patients (5% of the administered injections) in the Buvidal treatment group. The most common adverse reactions were injection site pain (8.9%), injection site pruritus (6.1%) and injection site erythema (4.7%). The injection site reactions were all mild or moderate in severity and most events were transient.

Reporting of suspected adverse reactions

Reporting suspected adverse reactions after authorisation of the medical product is important. It allows continued monitoring of the benefit/risk balance of the medicinal product. Healthcare professionals are asked to report any suspected adverse reactions via the national reporting system listed in [Appendix V](#).

4.9 Overdose

Symptoms

Respiratory depression, as a result of central nervous system depression, is the primary symptom requiring intervention in the case of buprenorphine overdose because it may lead to respiratory arrest and death. Preliminary symptoms of overdose may also include excessive sweating, somnolence, amblyopia, miosis, hypotension, nausea, vomiting and / or speech disorders.

Treatment

General supportive measures should be instituted, including close monitoring of respiratory and cardiac status of the patient. Symptomatic treatment of respiratory depression, following standard intensive care measures, should be instituted. A patent airway and assisted or controlled ventilation must be assured. The patient should be transferred to an environment within which full resuscitation facilities are available. If the patient vomits, precautions must be taken to prevent aspiration. Use of an opioid antagonist (i.e. naloxone) is recommended, despite the modest effect it may have in reversing the respiratory symptoms of buprenorphine compared with its effects on full agonist opioids.

The long duration of action of buprenorphine and the prolonged release from Buvidal, should be taken into consideration when determining length of treatment needed to reverse the effects of an overdose, (see section 4.4). Naloxone can be cleared more rapidly than buprenorphine, allowing for a return of previously controlled buprenorphine overdose symptoms.

5. PHARMACOLOGICAL PROPERTIES

5.1 Pharmacodynamic properties

Pharmacotherapeutic group: Other nervous system drugs, drugs used in opioid dependence, ATC code: N07BC01

Mechanism of action

Buprenorphine is an opioid partial agonist/antagonist which binds to the μ (mu) and κ (kappa) opioid receptors of the brain. Its activity in opioid maintenance treatment is attributed to its slowly reversible properties with the μ -opioid receptors which, over a prolonged period, might minimise the need of illicit opioids for patients with opioid dependence.

Opioid agonist ceiling effects were observed during clinical pharmacology studies in opioid-dependent persons.

Clinical efficacy

The efficacy and safety of Buvidal in the treatment of opioid dependence were established in a pivotal phase 3, randomised, double-blind, double-dummy, active-controlled, flexible-dose study in patients with moderate to severe opioid dependence. In this study, 428 patients were randomised to one of two treatment groups. Patients in the Buvidal group (n = 213) received weekly injections (16 mg to 32 mg) during the first 12 weeks followed by monthly injections (64 mg to 160 mg) during the last 12 weeks, plus daily doses of sublingual placebo tablets during the complete treatment period. Patients in the sublingual buprenorphine/naloxone group (n = 215) received weekly placebo injections during the first

12 weeks and monthly placebo injections during the last 12 weeks, plus daily sublingual buprenorphine/naloxone tablets during the complete treatment period (8 mg to 24 mg during the first 12 weeks and 8 mg to 32 mg during the last 12 weeks). During the 12 weeks with monthly injections, patients in both groups could receive one additional 8 mg weekly Buvidal dose per month, if needed. Patients attended 12 weekly visits during the first 12 weeks and 6 visits during the last 12 weeks (3 scheduled monthly visits and 3 random urine toxicology visits). At each visit, efficacy and safety outcome measures were assessed.

Of the 428 randomised patients, 69.0% (147/213) of the patients in the Buvidal treatment group and 72.6% (156/215) of the patients in the sublingual buprenorphine/naloxone treatment group completed the 24-week treatment period.

The study met the primary endpoint of non-inferiority in mean percentage of urine samples negative for illicit opioids during treatment weeks 1 to 24 for the Buvidal group compared with the sublingual buprenorphine/naloxone group (Table 3).

Superiority of Buvidal versus sublingual buprenorphine/naloxone was met (pre-specified test order) for the secondary endpoint cumulative distribution function (CDF) for percentage of opioid-negative urine samples during treatment weeks 4 to 24 (Table 3).

Table 3. Efficacy variables in a pivotal phase 3, randomised, double-blind, double-dummy, active-controlled, flexible-dose study in patients with moderate to severe opioid dependence					
Efficacy variable	Statistic	Buvidal	SL BPN/NX	Treatment difference (%)^a (95% CI)	P-value
Percentage of urine samples negative for illicit opioids	N	213	215		
	LS mean (%) (SE)	35.1 (2.48)	28.4 (2.47)	6.7	<0.001
	95% CI	30.3 - 40.0	23.5 - 33.3	-0.1 - 13.6	
CDF of percentage of urine samples negative for illicit opioids over weeks 4-24	N	213	215		
	Median	26.7	6.7	-	0.008 ^b

CDF = cumulative distribution function, CI = confidence interval, LS = least squares; SE = standard error, SL BPN/NX = sublingual buprenorphine/naloxone

^a Difference = Buvidal – SL BPN/NX.

^b The p-value was for superiority

A long-term, open-label, phase 3 safety study with flexible dosing of weekly and monthly Buvidal for 48 weeks was conducted. The study enrolled a total of 227 patients with moderate to severe opioid dependence, of which 190 patients were switched from sublingual buprenorphine (with or without naloxone), and 37 patients were new to buprenorphine treatment. During the 48-week treatment period, patients could be transitioned between weekly and monthly injections with Buvidal and between doses (8 mg to 32 mg weekly Buvidal and 64 mg to 160 mg monthly Buvidal) according to the physician's clinical judgement.

For patients who were switched from sublingual buprenorphine, the percentage of patients with illicit opioid-negative urine samples was 78.8% at baseline and 84.0% at the end of the 48-week treatment period. For the new-to-treatment patients, the percentage of patients with illicit opioid-negative urine samples was 0.0% at baseline and 63.0% at the end of the 48-week treatment period. Overall, 156 patients (68.7%) completed the 48-week treatment period.

5.2 Pharmacokinetic properties

Weekly Buvidal

Absorption

After injection, the buprenorphine plasma concentration increases with a median time to maximum plasma concentration (t_{max}) of about 24 hours. Buvidal has complete absolute bioavailability. Steady-state exposure is reached at the fourth weekly dose.

Dose-proportional increases in exposure are observed in the dose interval 8 mg to 32 mg.

Distribution

The apparent volume of distribution for buprenorphine is approximately 1900 L. Buprenorphine is approximately 96% protein-bound, primarily to alpha and beta globulin.

Biotransformation and elimination

Buprenorphine is oxidatively metabolised by 14-N-dealkylation to N-desalkyl-buprenorphine (also known as norbuprenorphine) via cytochrome P450 CYP3A4 and by glucuroconjugation of the parent molecule and the dealkylated metabolite. Norbuprenorphine is a μ -opioid agonist with weak intrinsic activity.

Subcutaneous administration of Buvidal results in significantly lower plasma concentrations of norbuprenorphine metabolite compared to administration of sublingual buprenorphine, due to avoidance of first-pass metabolism.

Elimination of buprenorphine from Buvidal is release-rate limited with a terminal half-life ranging from 3 to 5 days.

Buprenorphine is primarily eliminated in the faeces by biliary excretion of the glucuroconjugated metabolites (70%), the remainder being eliminated in the urine. Total clearance of buprenorphine is approximately 68 L/h.

Special populations

Elderly

No pharmacokinetic data in elderly patients (> 65 years) are available.

Renal impairment

Renal elimination plays a relatively small role ($\approx 30\%$) in the overall clearance of buprenorphine. No dose modification based on renal function is required, but caution is recommended when dosing subjects with severe renal impairment (see sections 4.2 and 4.4).

Hepatic impairment

Table 4 summarises the results of a clinical study in which exposure to buprenorphine was determined following administration of a buprenorphine/naloxone 2.0/0.5 mg sublingual tablet in healthy subjects and in subjects with different degrees of hepatic impairment.

Table 4. Effect of hepatic impairment (change relative to healthy subjects) on pharmacokinetic parameters of buprenorphine following sublingual buprenorphine/naloxone administration (2.0/0.5 mg) in healthy subjects, and in subjects with varied degrees of hepatic impairment			
Pharmacokinetic Parameter	mild hepatic impairment (Child-Pugh Class A) (n=9)	moderate hepatic impairment (Child-Pugh Class B) (n=8)	severe hepatic impairment (Child-Pugh Class C) (n=8)
Buprenorphine			
C_{max}	1.2-fold increase	1.1-fold increase	1.7-fold increase
AUC_{last}	Similar to control	1.6-fold increase	2.8-fold increase

Overall, buprenorphine plasma exposure increased approximately 3-fold in subjects with severely impaired hepatic function (see sections 4.2, 4.3 and 4.4).

Paediatric population

No pharmacokinetic data in paediatrics (less than 18 years) are available. Simulated buprenorphine exposure data in adolescents aged 16 years show lower C_{max} and AUC compared to observed values in adults for weekly and monthly Buvidal.

5.3 Preclinical safety data

Acute toxicity of buprenorphine was determined in mice and rats following oral and parenteral (intravenous, intraperitoneal) administration. Undesirable effects were based on the known pharmacological activity of buprenorphine.

Buprenorphine showed low tissue and biochemical toxicities when beagles were dosed subcutaneously for one month, rhesus monkeys orally for one month and rats and baboons intramuscularly for six months.

Teratology and reproduction toxicity studies in rats and rabbits by intramuscular administration concluded that buprenorphine is not embryotoxic or teratogenic and has no marked effects on weaning potential. In rats there were no adverse effects on fertility of general reproductive function. Chronic toxicity studies in rat and dog of the vehicle used for Buvidal revealed no special hazard for humans.

6. PHARMACEUTICAL PARTICULARS

6.1 List of excipients

Buvidal 8 mg, 16 mg, 24 mg, 32 mg

Soybean phosphatidylcholine
Glycerol dioleate
Ethanol anhydrous

6.2 Incompatibilities

This medicinal product must not be mixed with other medicinal products.

6.3 Shelf life

3 years

6.4 Special precautions for storage

Do not refrigerate or freeze.

6.5 Nature and contents of container

A 1 mL pre-filled syringe (glass, Type I) with plunger stopper (fluoropolymer-coated bromobutyl rubber) with needle (½-inch, 23 gauge, 12 mm) and needle shield (styrene butadiene rubber). The pre-filled syringe is assembled in a safety device for post-injection needlestick prevention. The needle shield of the safety syringe may contain rubber latex that may cause allergic reactions in latex-sensitive individuals.

Pack sizes

Pack contains 1 pre-filled syringe with stopper, needle, needle shield, safety device and 1 plunger rod.

6.6 Special precautions for disposal and other handling

Important information

- Administration should be made into the subcutaneous tissue
- Intravascular, intramuscular and intradermal administration must be avoided.
- Must not be used if the safety syringe is broken or the packaging is damaged.
- The needle shield of the syringe may contain rubber latex that may cause allergic reactions in latex sensitive individuals.
- Handle the safety syringe carefully to avoid a needle stick. The safety syringe includes a needle protection safety device that will activate at the end of the injection. Do not uncapped the safety syringe until you are ready to inject. Once uncapped, never try to recap the needle.
- Dispose of the used safety syringe right away after use. Do not re-use the safety syringe.

Before administration

Safety syringe parts:

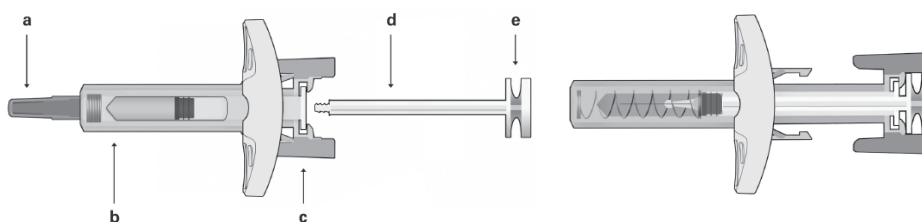

Figure 1: Safety Syringe: Before Use

a) Needle shield, b) Syringe Guard Body,
c) Syringe Guard Wings, d) Plunger,
e) Plunger Head

Safety Syringe: After Use

(With needle protection mechanism activated)

Please note that the smallest injection volume is barely visible in the viewing window as the spring of the safety device is “covering” part of the glass cylinder close to the needle.

Administration (see also section 4.2)

- Take the syringe out of the cardboard box: pick up the syringe by the syringe guard body.
- While holding the syringe by the needle shield, insert the plunger rod into the plunger stopper by gently rotating the plunger rod clockwise until secured (see Figure 2).

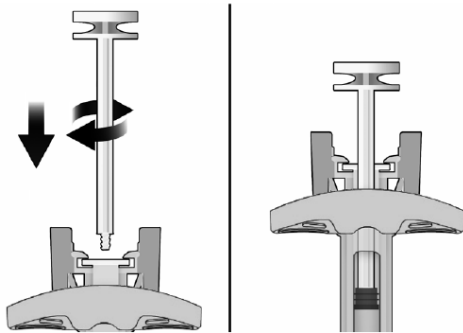

Figure 2: Before After

- Inspect the safety syringe closely:
 - Do not use the safety syringe after the expiration date shown on the cardboard box or on the syringe label.
 - A small air bubble may be seen, which is normal.
 - The liquid should be clear. Do not use the safety syringe if the liquid contains visible particles or is cloudy.

- Choose the injection site. Injections should be rotated between sites in the buttock, thigh, abdomen, or upper arm (see Figure 3) with a minimum of 8 weeks before re-injecting a previously used injection site. Injections on the waistline or within 5 cm of the navel should be avoided.

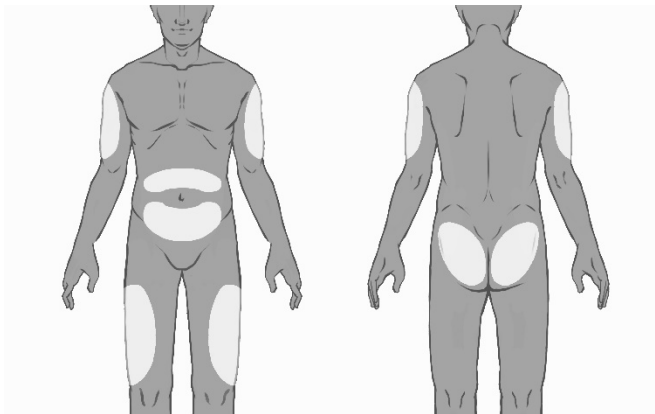

Figure 3:

- Put on gloves and clean the injection site with a circular motion using an alcohol wipe (not provided in the pack). Do not touch the cleaned area again before injecting.
- While holding the safety syringe by the syringe guard body as shown (see Figure 4), carefully pull the needle shield straight off. Immediately dispose of the needle shield (never try to recap the needle). A drop of liquid may be seen at the end of the needle. This is normal.

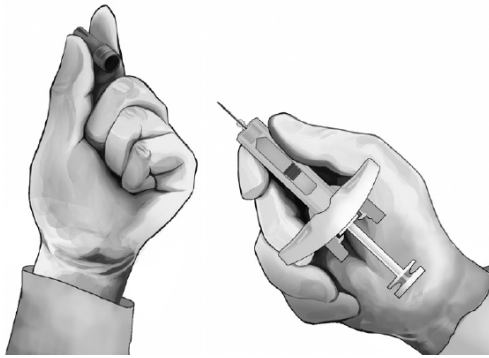

Figure 4:

- Pinch the skin at the injection site between the thumb and finger as shown (see Figure 5).
- Hold the safety syringe as shown and insert the needle at an angle of approximately 90° (see Figure 5). Push the needle all the way in.

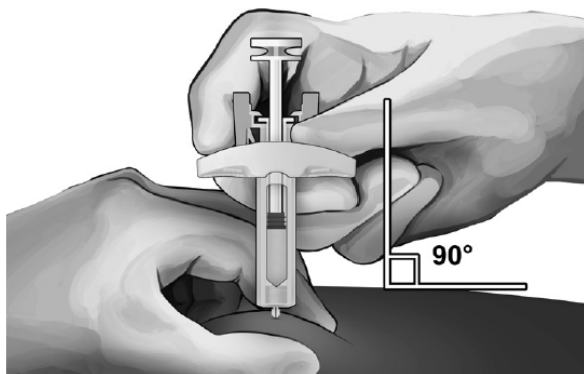

Figure 5:

- While holding the syringe as shown (see Figure 6), slowly depress the plunger until the plunger head latches between the syringe guard wings and all the solution is injected.

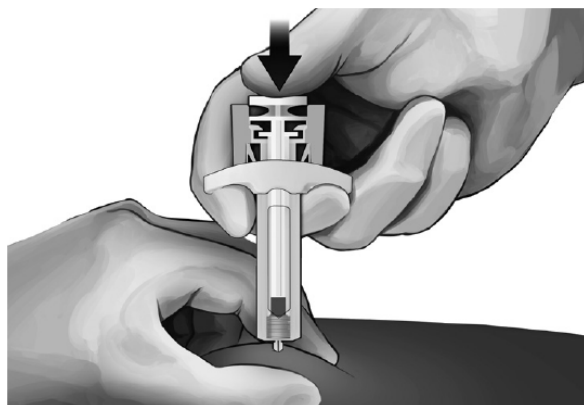

Figure 6:

- Gently pull the needle out of the skin. It is recommended that the plunger is kept fully depressed while the needle is carefully lifted straight out from the injection site (see Figure 7).

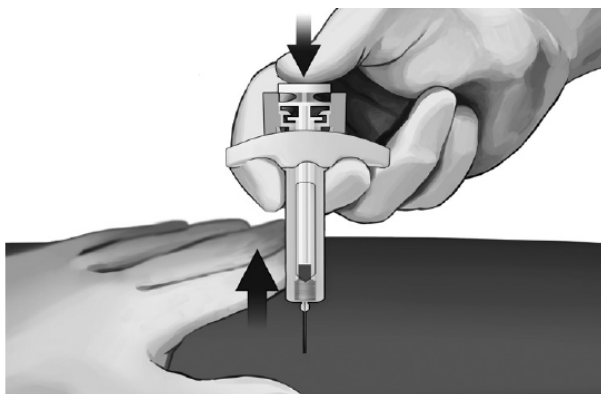

Figure 7:

- As soon as the needle has been completely removed from the skin, slowly take the thumb off the plunger and allow the syringe guard to automatically cover the exposed needle (see Figure 8). There may be a small amount of blood at the injection site, if required wipe with a cotton ball or gauze.



Figure 8:

Disposing of the syringe

Any unused medicinal product or waste material should be disposed of in accordance with local requirements.

7. MARKETING AUTHORISATION HOLDER

Camurus AB
Ideon Science Park
SE-223 70 Lund, Sweden
Phone: +800 2577 2577

8. MARKETING AUTHORISATION NUMBER(S)

Buvidal prolonged-release solution for injection (weekly)

EU/1/18/1336/001 [8 mg buprenorphine/0.16 mL]
EU/1/18/1336/002 [16 mg buprenorphine/0.32 mL]
EU/1/18/1336/003 [24 mg buprenorphine 0.48 mL]
EU/1/18/1336/004 [32 mg buprenorphine/0.64 mL]

9. DATE OF FIRST AUTHORISATION/RENEWAL OF THE AUTHORISATION

Date of first authorisation:
20 November 2018

10. DATE OF REVISION OF THE TEXT

Detailed information on this medicinal product is available on the website of the European Medicines Agency <http://www.ema.europa.eu>

1. NAME OF THE MEDICINAL PRODUCT

Buvidal 64 mg prolonged-release solution for injection
Buvidal 96 mg prolonged-release solution for injection
Buvidal 128 mg prolonged-release solution for injection
Buvidal 160 mg prolonged-release solution for injection

2. QUALITATIVE AND QUANTITATIVE COMPOSITION

64 mg prolonged-release solution for injection

Each pre-filled syringe contains 64 mg buprenorphine

96 mg prolonged-release solution for injection

Each pre-filled syringe contains 96 mg buprenorphine

128 mg prolonged-release solution for injection

Each pre-filled syringe contains 128 mg buprenorphine

160 mg prolonged-release solution for injection

Each pre-filled syringe contains 160 mg buprenorphine

For the full list of excipients, see section 6.1.

3. PHARMACEUTICAL FORM

Prolonged-release solution for injection.
Yellowish to yellow clear liquid.

4. CLINICAL PARTICULARS

4.1 Therapeutic indications

Treatment of opioid dependence within a framework of medical, social and psychological treatment. Treatment is intended for use in adults and adolescents aged 16 years or over.

4.2 Posology and method of administration

Administration of Buvidal is restricted to healthcare professionals. Appropriate precautions, such as to conduct patient follow-up visits with clinical monitoring according to the patient's needs, should be taken when prescribing and dispensing buprenorphine. Take-home use or self-administration of the product by patients is not allowed.

Precautions to be taken before initiation of treatment

To avoid precipitating symptoms of withdrawal, treatment with Buvidal should be started when objective and clear signs of mild to moderate withdrawal are evident (see section 4.4). Consideration should be given to the types of opioid used (that is long- or short-acting opioid), time since last opioid use and the degree of opioid dependence.

- For patients using heroin or short-acting opioids, the initial dose of Buvidal must not be administered until at least 6 hours after the patient last used opioids.
- For patients receiving methadone, the methadone dose should be reduced to a maximum of 30 mg/day before starting treatment with Buvidal which should not be administered until at least 24 hours after the patient last received a methadone dose. Buvidal may trigger withdrawal symptoms in methadone-dependent patients.

Posology

Initiation of treatment in patients not already receiving buprenorphine

Patients not previously exposed to buprenorphine should receive a sublingual buprenorphine 4 mg dose and be observed for an hour before the first administration of weekly Buvidal to confirm tolerability to buprenorphine.

The recommended starting dose of Buvidal is 16 mg, with one or two additional 8 mg doses at least 1 day apart, to a target dose of 24 mg or 32 mg during the first treatment week. The recommended dose for the second treatment week is the total dose administered during the week of initiation.

Treatment with monthly Buvidal can be started after treatment initiation with weekly Buvidal, in accordance with the dose conversion in Table 1 and once patients have been stabilised on weekly treatment (four weeks or more, where practical).

Switching from sublingual buprenorphine products to Buvidal

Patients treated with sublingual buprenorphine may be switched directly to weekly or monthly Buvidal, starting on the day after the last daily buprenorphine sublingual treatment dose in accordance with the dosing recommendations in Table 1. Closer monitoring of patients is recommended during the dosing period after the switch.

Table 1. Conventional sublingual buprenorphine daily treatment doses and recommended corresponding doses of weekly and monthly Buvidal		
Dose of daily sublingual buprenorphine	Dose of weekly Buvidal	Dose of monthly Buvidal
2-6 mg	8 mg	
8-10 mg	16 mg	64 mg
12-16 mg	24 mg	96 mg
18-24 mg	32 mg	128 mg
26-32 mg		160 mg

Patients may be switched from sublingual buprenorphine 26-32 mg directly to monthly Buvidal 160 mg with close monitoring during the dosing period after the switch.

The dose of buprenorphine in mg can differ between sublingual products, which needs to be taken into consideration on a product-by-product basis. The pharmacokinetic properties of Buvidal are described in section 5.2.

Maintenance treatment and dose adjustments

Buvidal can be administered weekly or monthly. Doses may be increased or decreased and patients can be switched between weekly and monthly products according to individual patient's needs and treating physician's clinical judgement as per recommendations in Table 1. Following switching, patients may need closer monitoring. Assessment of long-term treatment is based on 48-week data.

Supplemental dosing

A maximum of one supplemental Buvidal 8 mg dose may be administered at an unscheduled visit between regular weekly and monthly doses, based on individual patient's temporary needs.

The maximum dose per week for patients who are on weekly Buvidal treatment is 32 mg with an additional 8 mg dose. The maximum dose per month for patients who are on monthly Buvidal treatment is 160 mg.

Missed doses

To avoid missed doses, the weekly dose may be administered up to 2 days before or after the weekly time point, and the monthly dose may be administered up to 1 week before or after the monthly time point.

If a dose is missed, the next dose should be administered as soon as practically possible.

Termination of treatment

If Buvidal treatment is discontinued, its prolonged-release characteristics and any withdrawal symptoms experienced by the patient must be considered, see section 4.4. If the patient is switched to treatment with sublingual buprenorphine, this should be done one week after the last weekly dose or one month after the last monthly dose of Buvidal according to the recommendations in Table 1.

Special populations

Elderly

The efficacy and safety of buprenorphine in elderly patients > 65 years have not been established. No recommendation on posology can be made.

In general, recommended dosing for elderly patients with normal renal function is the same as for younger adult patients with normal renal function. However, because elderly patients may have diminished renal/hepatic function, dose adjustment may be necessary (see Hepatic impairment and Renal impairment below).

Hepatic impairment

Buprenorphine should be used with caution in patients with moderate hepatic impairment (see section 5.2). In patients with severe hepatic impairment, the use of buprenorphine is contraindicated (see section 4.3).

Renal impairment

Modification of the buprenorphine dose is not required for patients with renal impairment. Caution is recommended when dosing patients with severe renal impairment (creatinine clearance < 30 ml/min) (see sections 4.4 and 5.2).

Paediatric population

The safety and efficacy buprenorphine in children and adolescents below 16 years of age have not been established (see section 4.4). No data are available.

Method of administration

Buvidal is intended for subcutaneous administration only. It should be injected slowly and completely into the subcutaneous tissue of different areas (buttock, thigh, abdomen, or upper arm), provided there is enough subcutaneous tissue. Each area can have multiple injection sites. Injection sites should be rotated for both weekly and monthly injections. A minimum of 8 weeks should be left before re-injecting a previously used injection site with the weekly dose. There is no clinical data supporting reinjection of the monthly dose into the same site. This is unlikely to be a safety concern. The decision to reinject at the same site should also be guided by the attending physicians' clinical judgement. Administered dose should be as a single injection and not divided. The dose must not be administered intravascularly (intravenously), intramuscularly or intradermally (into the skin) (see section 4.4). See section 6.6 for administration instructions.

4.3 Contraindications

Hypersensitivity to the active substance or to any of the excipients listed in section 6.1
Severe respiratory insufficiency
Severe hepatic impairment
Acute alcoholism or *delirium tremens*

4.4 Special warnings and precautions for use

Administration

Care must be taken to avoid inadvertent injection of Buvidal. The dose must not be administered intravascularly (intravenously), intramuscularly or intradermally.

Intravascular such as intravenous injection would present a risk of serious harm as Buvidal forms a solid mass upon contact with body fluids, which potentially could cause blood vessel injury, occlusion, or thromboembolic events.

To minimise the risk of misuse, abuse and diversion, appropriate precautions should be taken when prescribing and dispensing buprenorphine. Healthcare professionals should administer Buvidal directly to the patient. Take-home use or self-administration of the product by patients is not allowed. Any attempts to remove the depot should be monitored throughout treatment.

Prolonged-release properties

The prolonged-release properties of the product should be considered during treatment including initiation and termination. In particular, patients with concomitant medicinal products and/or comorbidities, should be monitored for signs and symptoms of toxicity, overdose or withdrawal caused by increased or decreased levels of buprenorphine.

For pharmacokinetic properties, see section 5.2 and for treatment termination, see section 4.2.

Respiratory depression

A number of cases of death due to respiratory depression have been reported for patients being treated with buprenorphine, particularly when used in combination with benzodiazepines (see section 4.5) or when buprenorphine was not used according to prescribing information. Deaths have also been reported in association with concomitant administration of buprenorphine and other depressants such as alcohol, gabapentinoids (such as pregabalin and gabapentin) (see section 4.5) or other opioids. Buprenorphine should be used with care in patients with respiratory insufficiency (e.g. chronic obstructive pulmonary disease, asthma, cor pulmonale, decreased respiratory reserve, hypoxia, hypercapnia, pre-existing respiratory depression or kyphoscoliosis).

Buprenorphine may cause severe, possibly fatal, respiratory depression in children and non-opioid dependent persons who accidentally or deliberately use it.

CNS depression

Buprenorphine may cause drowsiness particularly when taken together with alcohol or central nervous system depressants such as benzodiazepines, tranquilisers, sedatives, gabapentinoids or hypnotics (see sections 4.5 and 4.7).

Dependence

Buprenorphine is a partial agonist at the mu-opiate receptor and chronic administration can produce opioid dependence.

Serotonin syndrome

Concomitant administration of Buvidal and other serotonergic agents, such as MAO inhibitors, selective serotonin re-uptake inhibitors (SSRIs), serotonin norepinephrine re-uptake inhibitors (SNRIs) or tricyclic antidepressants may result in serotonin syndrome, a potentially life-threatening condition (see section 4.5). If concomitant treatment with other serotonergic agents is clinically warranted, careful observation of the patient is advised, particularly during treatment initiation and dose increases.

Symptoms of serotonin syndrome may include mental-status changes, autonomic instability, neuromuscular abnormalities, and/or gastrointestinal symptoms. If serotonin syndrome is suspected, a dose reduction or discontinuation of therapy should be considered depending on the severity of the symptoms.

Hepatitis and hepatic events

Baseline liver function tests and documentation of viral hepatitis status are recommended prior to starting therapy. Patients who are positive for viral hepatitis, on certain concomitant medicinal products (see section 4.5) and/or who have existing liver dysfunction are at greater risk of liver injury. Regular monitoring of the liver function is recommended.

Cases of acute hepatic injury have been reported in opioid-dependent patients both in clinical studies and in post-marketing adverse reaction reports with medicinal products containing buprenorphine. The spectrum of abnormalities ranges from transient asymptomatic elevations in hepatic transaminases to case reports of cytolytic hepatitis, hepatic failure, hepatic necrosis, hepatorenal syndrome, hepatic encephalopathy and death. In many cases, the presence of pre-existing liver enzyme abnormalities, genetic disease, infection with hepatitis B or hepatitis C virus, alcohol abuse, anorexia, concomitant use of other potentially hepatotoxic medicinal products and ongoing injecting drug use may have a causative or contributory role. These underlying factors must be taken into consideration before prescribing buprenorphine and during treatment. When a hepatic event is suspected, further biological and aetiological evaluation is required. Depending on the findings, Buvidal may be discontinued. Monitoring beyond the weekly and monthly treatment period may be needed. If treatment is continued, hepatic function should be monitored closely.

Precipitation of opioid withdrawal syndrome

When initiating treatment with buprenorphine, it is important to be aware of the partial agonist profile of buprenorphine. Buprenorphine products have caused precipitated withdrawal symptoms in opioid-dependent patients when administered before the agonist effects resulting from recent opioid use or misuse have subsided. To avoid precipitated withdrawal, induction must be undertaken when objective signs and symptoms of mild to moderate withdrawal are evident (see section 4.2).

Discontinuation of treatment may result in a withdrawal syndrome that may be delayed in onset.

Hepatic impairment

Buprenorphine is extensively metabolised in the liver. Patients with moderate hepatic impairment should be monitored for signs and symptoms of precipitated opioid withdrawal, toxicity or overdose caused by increased levels of buprenorphine. Buprenorphine should be used with caution in patients with moderate hepatic impairment (see sections 4.2 and 5.2). Hepatic function should be monitored regularly whilst on treatment. The use of buprenorphine is contraindicated in patients with severe hepatic impairment (see section 4.3).

Renal impairment

Metabolites of buprenorphine accumulate in patients with renal failure. Caution is recommended when dosing patients with severe renal impairment (creatinine clearance < 30 ml/min), see sections 4.2 and 5.2.

QT prolongation

Caution should be exercised when co-administering Buvidal with other medicinal products that prolong the QT interval and in patients with a history of long QT syndrome or other risk factors for QT prolongation.

Acute pain management

For management of acute pain during continued use of Buvidal, a combination of use of opioids with high mu-opioid receptor affinity (e.g. fentanyl), non-opioid analgesics and regional anaesthesia might be necessary. Titration of oral or intravenous short-acting opioid pain medicinal products (immediate-release morphine, oxycodone or fentanyl) to the desired analgesic effect in patients treated with Buvidal might require higher doses. Patients should be monitored during treatment.

Use in children and adolescents

The safety and efficacy of buprenorphine in children below the age of 16 years have not been established (see section 4.2). Due to limited data in adolescents (aged 16 or 17 years), patients in this age group should be monitored closely during treatment.

Sleep-related breathing disorders

Opioids can cause sleep-related breathing disorders including central sleep apnoea (CSA) and sleep-related hypoxemia. Opioid use increases the risk of CSA in a dose-dependent fashion. In patients who present with CSA, consider decreasing the total opioid dosage.

Class effects

Opioids may cause orthostatic hypotension.

Opioids may elevate cerebrospinal fluid pressure, which may cause seizures. Therefore, opioids should be used with caution in patients with head injury, intracranial lesions, other circumstances where cerebrospinal pressure may be increased, or history of seizure.

Opioids should be used with caution in patients with hypotension, prostatic hypertrophy or urethral stenosis.

Opioid-induced miosis, changes in the level of consciousness or changes in the perception of pain as a symptom of disease may interfere with patient evaluation or obscure the diagnosis or clinical course of concomitant disease.

Opioids should be used with caution in patients with myxoedema, hypothyroidism, or adrenal cortical insufficiency (e.g. Addison's disease).

Opioids have been shown to increase intracholedochal pressure, and should be used with caution in patients with dysfunction of the biliary tract.

4.5 Interaction with other medicinal products and other forms of interaction

No interaction studies have been performed with Buvidal.

Buprenorphine should be used cautiously when co-administered with:

- benzodiazepines: This combination may result in death due to respiratory depression of central origin. Therefore, dosages must be closely monitored and this combination must be avoided in cases where there is a risk of misuse. Patients should be warned that it is extremely dangerous to self-administer non-prescribed benzodiazepines whilst taking this product, and should also be

cautioned to use benzodiazepines concurrently with this product only as directed by their physician (see section 4.4).

- gabapentinoids: This combination may result in death due to respiratory depression. Therefore, dosages must be closely monitored and this combination must be avoided in cases where there is a risk of misuse. Patients should be cautioned to use gabapentinoids (such as pregabalin and gabapentin) concurrently with this product only as directed by their physician (see section 4.4).
- alcoholic drinks or medicinal products containing alcohol as alcohol increases the sedative effect of buprenorphine (see section 4.7).
- other central nervous system depressants: Other opioid derivatives (e.g. methadone, analgesics and antitussives); certain antidepressants, sedative H₁-receptor antagonists, barbiturates, anxiolytics other than benzodiazepines, antipsychotics, clonidine and related substances. These combinations increase central nervous system depression. The reduced level of alertness can make driving and using machinery hazardous (see section 4.7).
- opioid analgesics: Adequate analgesia may be difficult to achieve when administering a full opioid agonist in patients receiving buprenorphine. The potential for overdose also exists with a full agonist, especially when attempting to overcome buprenorphine partial agonist effects, or when buprenorphine plasma levels are declining (see section 4.4)
- naltrexone and nalmefene: These are opioid antagonists that can block the pharmacological effects of buprenorphine. For opioid-dependent patients currently receiving buprenorphine treatment, naltrexone may precipitate a sudden onset of prolonged and intense opioid withdrawal symptoms. For patients currently receiving naltrexone treatment, the intended therapeutic effects of buprenorphine administration may be blocked by naltrexone.
- Buprenorphine is metabolised to norbuprenorphine primarily by CYP3A4. The effects on buprenorphine exposure in patients treated with Buvidal have not been studied. Interaction with co-administered inducers or inhibitors have been established in studies using transmucosal and transdermal buprenorphine. Buprenorphine is also metabolised to buprenorphine-3β-glucuronide by UGT1A1.
 - CYP3A4 inhibitors may inhibit the metabolism of buprenorphine resulting in increased C_{max} and AUC of buprenorphine and norbuprenorphine. Buvidal avoids first-pass effects and CYP3A4 inhibitors (e.g. protease inhibitors like ritonavir, nelfinavir or indinavir, or azole antifungals such as ketoconazole or itraconazole, or macrolide antibiotics) are expected to have less effects on buprenorphine metabolism when co-administered with Buvidal as compared to when co-administered with sublingual buprenorphine. When switching from sublingual buprenorphine to Buvidal, patients may need to be monitored to ensure plasma buprenorphine levels are adequate. Patients already on Buvidal who start treatment with CYP3A4 inhibitors should be treated with weekly Buvidal and be monitored for signs and symptoms of overtreatment. Conversely, if a patient who is concomitantly treated with Buvidal and a CYP3A4 inhibitor stops treatment with the CYP3A4 inhibitor, the patient should be monitored for symptoms of withdrawal.
 - CYP3A4 inducers may induce the metabolism of buprenorphine resulting in decreased buprenorphine levels. Buvidal avoids first-pass effects and CYP3A4 inducers (e.g. phenobarbital, carbamazepine, phenytoin or rifampicin) are expected to have less effects on buprenorphine metabolism when co-administered with Buvidal as compared to when co-administered with sublingual buprenorphine. When switching from sublingual buprenorphine to Buvidal, patients may need to be monitored to ensure plasma buprenorphine levels are adequate. Patients already on Buvidal who start treatment with CYP3A4 inducers should be treated with weekly Buvidal and be monitored for signs and symptoms of withdrawal. Conversely, if a patient who is concomitantly treated with Buvidal and a CYP3A4 inducer stops treatment with the CYP3A4 inducer, the patient should be monitored for symptoms of overtreatment.
 - UGT1A1 inhibitors may affect the systemic exposure of buprenorphine.
- monoamine oxidase inhibitors (MAOI): Possible exacerbation of the opioids effects, based on experience with morphine.
- Serotonergic medicinal products, such as MAO inhibitors, selective serotonin re-uptake inhibitors (SSRIs), serotonin norepinephrine re-uptake inhibitors (SNRIs) or tricyclic

antidepressants as the risk of serotonin syndrome, a potentially life-threatening condition, is increased (see section 4.4).

4.6 Fertility, pregnancy and lactation

Pregnancy

There are no or limited data from the use of buprenorphine in pregnant women. Animal studies do not indicate reproductive toxicity (see section 5.3). Buprenorphine should be used during pregnancy only if the potential benefit outweighs the potential risk to the foetus.

Towards the end of pregnancy, buprenorphine may induce respiratory depression in the newborn infant even after a short period of administration. Long-term administration during the last three months of pregnancy may cause a withdrawal syndrome in the neonate (e.g. hypertonia, neonatal tremor, neonatal agitation, myoclonus or convulsions). The syndrome is generally delayed from several hours to several days after birth.

Due to the long half-life of buprenorphine, neonatal monitoring for several days after birth should be considered to prevent the risk of respiratory depression or withdrawal syndrome in neonates.

Breast-feeding

Buprenorphine and its metabolites are excreted in human breast milk and Buvidal should be used with caution during breast-feeding.

Fertility

There are no or limited data on effects of buprenorphine on human fertility. An effect of buprenorphine on fertility in animals has not been seen (see section 5.3).

4.7 Effects on ability to drive and use machines

Buprenorphine has minor to moderate influence on the ability to drive and use machines when administered to opioid-dependent patients. Buprenorphine may cause drowsiness, dizziness or impaired thinking, especially during treatment induction and dose adjustment. If used together with alcohol or central nervous system depressants, the effect is likely to be more pronounced (see sections 4.4. and 4.5).

The patient should be cautioned not to drive or operate hazardous machinery whilst taking this medicine until it is known how the patient is affected by the medicine. An individual recommendation should be given by the treating healthcare professional.

4.8 Undesirable effects

Summary of the safety profile

The adverse reactions most frequently reported for buprenorphine are headache, nausea, hyperhidrosis, insomnia, drug withdrawal syndrome and pain.

Tabulated list of adverse reactions

Table 2 presents adverse reactions reported for buprenorphine, including Buvidal. The following terms and frequencies are applied: very common ($\geq 1/10$), common ($\geq 1/100$ to $< 1/10$), uncommon ($\geq 1/1000$ to $< 1/100$) and frequency not known (cannot be estimated from available data).

Table 2. Adverse reactions listed by body system				
System Organ Class	Very common	Common	Uncommon	Not known
Infections and infestations		Infection Influenza Pharyngitis Rhinitis	Injection site cellulitis	
Blood and lymphatic system disorders		Lymphadenopathy		
Immune system disorders		Hypersensitivity		
Metabolism and nutrition disorders		Decreased appetite		
Psychiatric disorders	Insomnia	Anxiety Agitation Depression Hostility Nervousness Thinking abnormal Paranoia Medical dependence		Hallucinations Euphoric mood
Nervous system disorders	Headache	Somnolence Dizziness Migraine Paraesthesia Syncope Tremor Hypertonia Speech disorders		
Eye disorders		Lacrimonal disorder Mydriasis Miosis		
Ear and labyrinth disorders			Vertigo	
Cardiac disorders		Palpitations		
Vascular disorders		Vasodilation Hypotension		
Respiratory, thoracic and mediastinal disorders		Cough Dyspnoea Yawning Asthma Bronchitis		
Gastrointestinal disorders	Nausea	Constipation Vomiting Abdominal pain Flatulence Dyspepsia Dry mouth Diarrhoea Gastrointestinal disorder		
Hepatobiliary disorders			Alanine aminotransferase increased Aspartate aminotransferase increased Hepatic enzymes increased	

Table 2. Adverse reactions listed by body system				
System Organ Class	Very common	Common	Uncommon	Not known
Skin and subcutaneous tissue disorders		Rash Pruritus Urticaria	Rash macular	Erythema
Musculoskeletal and connective tissue disorders		Arthralgia Back pain Myalgia Muscle spasms Neck pain Bone pain		
Renal and urinary disorders				Urinary retention
Reproductive system and breast disorders		Dysmenorrhoea		
General disorders and administration site conditions	Hyperhidrosis Drug withdrawal syndrome Pain	Injection site pain Injection site pruritus Injection site erythema Injection site swelling Injection site reaction Injection site induration Injection site mass Oedema peripheral Asthenia Malaise Pyrexia Chills Neonatal withdrawal syndrome Chest pain	Injection site inflammation Injection site bruising Injection site urticaria	
Investigations		Abnormal liver function tests		
Injury, poisoning and procedural complications			Procedural dizziness	

Description of selected adverse reactions

Injection site reactions

In the double-blind, phase 3 efficacy trial, injection site-related adverse reactions were observed in 36 (16.9%) of the 213 patients (5% of the administered injections) in the Buvidal treatment group. The most common adverse reactions were injection site pain (8.9%), injection site pruritus (6.1%) and injection site erythema (4.7%). The injection site reactions were all mild or moderate in severity and most events were transient.

Reporting of suspected adverse reactions

Reporting suspected adverse reactions after authorisation of the medical product is important. It allows continued monitoring of the benefit/risk balance of the medicinal product. Healthcare professionals are asked to report any suspected adverse reactions via the national reporting system listed in [Appendix V](#).

4.9 Overdose

Symptoms

Respiratory depression, as a result of central nervous system depression, is the primary symptom requiring intervention in the case of buprenorphine overdose because it may lead to respiratory arrest and death. Preliminary symptoms of overdose may also include excessive sweating, somnolence, amblyopia, miosis, hypotension, nausea, vomiting and / or speech disorders.

Treatment

General supportive measures should be instituted, including close monitoring of respiratory and cardiac status of the patient. Symptomatic treatment of respiratory depression, following standard intensive care measures, should be instituted. A patent airway and assisted or controlled ventilation must be assured. The patient should be transferred to an environment within which full resuscitation facilities are available. If the patient vomits, precautions must be taken to prevent aspiration. Use of an opioid antagonist (i.e. naloxone) is recommended, despite the modest effect it may have in reversing the respiratory symptoms of buprenorphine compared with its effects on full agonist opioids.

The long duration of action of buprenorphine and the prolonged release from Buvidal, should be taken into consideration when determining length of treatment needed to reverse the effects of an overdose, (see section 4.4). Naloxone can be cleared more rapidly than buprenorphine, allowing for a return of previously controlled buprenorphine overdose symptoms.

5. PHARMACOLOGICAL PROPERTIES

5.1 Pharmacodynamic properties

Pharmacotherapeutic group: Other nervous system drugs, drugs used in opioid dependence, ATC code: N07BC01

Mechanism of action

Buprenorphine is an opioid partial agonist/antagonist which binds to the μ (mu) and κ (kappa) opioid receptors of the brain. Its activity in opioid maintenance treatment is attributed to its slowly reversible properties with the μ -opioid receptors which, over a prolonged period, might minimise the need of illicit opioids for patients with opioid dependence.

Opioid agonist ceiling effects were observed during clinical pharmacology studies in opioid-dependent persons.

Clinical efficacy

The efficacy and safety of Buvidal in the treatment of opioid dependence were established in a pivotal phase 3, randomised, double-blind, double-dummy, active-controlled, flexible-dose study in patients with moderate to severe opioid dependence. In this study, 428 patients were randomised to one of two treatment groups. Patients in the Buvidal group (n = 213) received weekly injections (16 mg to 32 mg) during the first 12 weeks followed by monthly injections (64 mg to 160 mg) during the last 12 weeks, plus daily doses of sublingual placebo tablets during the complete treatment period. Patients in the sublingual buprenorphine/naloxone group (n = 215) received weekly placebo injections during the first 12 weeks and monthly placebo injections during the last 12 weeks, plus daily sublingual buprenorphine/naloxone tablets during the complete treatment period (8 mg to 24 mg during the first 12 weeks and 8 mg to 32 mg during the last 12 weeks). During the 12 weeks with monthly injections, patients in both groups could receive one additional 8 mg weekly Buvidal dose per month, if needed. Patients attended 12 weekly visits during the first 12 weeks and 6 visits during the last 12 weeks

(3 scheduled monthly visits and 3 random urine toxicology visits). At each visit, efficacy and safety outcome measures were assessed.

Of the 428 randomised patients, 69.0% (147/213) of the patients in the Buvidal treatment group and 72.6% (156/215) of the patients in the sublingual buprenorphine/naloxone treatment group completed the 24-week treatment period.

The study met the primary endpoint of non-inferiority in mean percentage of urine samples negative for illicit opioids during treatment weeks 1 to 24 for the Buvidal group compared with the sublingual buprenorphine/naloxone group (Table 3).

Superiority of Buvidal versus sublingual buprenorphine/naloxone was met (pre-specified test order) for the secondary endpoint cumulative distribution function (CDF) for percentage of opioid-negative urine samples during treatment weeks 4 to 24 (Table 3).

Table 3. Efficacy variables in a pivotal phase 3, randomised, double-blind, double-dummy, active-controlled, flexible-dose study in patients with moderate to severe opioid dependence					
Efficacy variable	Statistic	Buvidal	SL BPN/NX	Treatment difference (%)^a (95% CI)	P-value
Percentage of urine samples negative for illicit opioids	N	213	215		
	LS mean (%) (SE)	35.1 (2.48)	28.4 (2.47)	6.7	<0.001
	95% CI	30.3 - 40.0	23.5 - 33.3	-0.1 - 13.6	
CDF of percentage of urine samples negative for illicit opioids over weeks 4-24	N	213	215		
	Median	26.7	6.7	-	0.008 ^b

CDF = cumulative distribution function, CI = confidence interval, LS = least squares; SE = standard error, SL BPN/NX = sublingual buprenorphine/naloxone

^a Difference = Buvidal – SL BPN/NX.

^b The p-value was for superiority

A long-term, open-label, phase 3 safety study with flexible dosing of weekly and monthly Buvidal for 48 weeks was conducted. The study enrolled a total of 227 patients with moderate to severe opioid dependence, of which 190 patients were switched from sublingual buprenorphine (with or without naloxone), and 37 patients were new to buprenorphine treatment. During the 48-week treatment period, patients could be transitioned between weekly and monthly injections with Buvidal and between doses (8 mg to 32 mg weekly Buvidal and 64 mg to 160 mg monthly Buvidal) according to the physician's clinical judgement.

For patients who were switched from sublingual buprenorphine, the percentage of patients with illicit opioid-negative urine samples was 78.8% at baseline and 84.0% at the end of the 48-week treatment period. For the new-to-treatment patients, the percentage of patients with illicit opioid-negative urine samples was 0.0% at baseline and 63.0% at the end of the 48-week treatment period. Overall, 156 patients (68.7%) completed the 48-week treatment period.

5.2 Pharmacokinetic properties

Monthly Buvidal

Absorption

After injection, the buprenorphine plasma concentration increases with a median time to maximum plasma concentration (t_{max}) of 6-10 hours. Buvidal has complete absolute bioavailability. Steady-state exposure is reached at the fourth monthly dose.

Dose-proportional increases in overall exposure are observed in the dose interval 64 mg to 160 mg.

Distribution

The apparent volume of distribution for buprenorphine is approximately 1900 L. Buprenorphine is approximately 96% protein-bound, primarily to alpha and beta globulin.

Biotransformation and elimination

Buprenorphine is oxidatively metabolised by 14-N-dealkylation to N-desalkyl-buprenorphine (also known as norbuprenorphine) via cytochrome P450 CYP3A4 and by glucuroconjugation of the parent molecule and the dealkylated metabolite. Norbuprenorphine is a μ -opioid agonist with weak intrinsic activity.

Subcutaneous administration of Buvidal results in significantly lower plasma concentrations of norbuprenorphine metabolite compared to administration of sublingual buprenorphine, due to avoidance of first-pass metabolism.

Elimination of buprenorphine from Buvidal is release-rate limited with a terminal half-life ranging from 19 to 25 days.

Buprenorphine is primarily eliminated in the faeces by biliary excretion of the glucuroconjugated metabolites (70%), the remainder being eliminated in the urine. Total clearance of buprenorphine is approximately 68 L/h.

Special populations

Elderly

No pharmacokinetic data in elderly patients (> 65 years) are available.

Renal impairment

Renal elimination plays a relatively small role ($\approx 30\%$) in the overall clearance of buprenorphine. No dose modification based on renal function is required, but caution is recommended when dosing subjects with severe renal impairment (see sections 4.2 and 4.4).

Hepatic impairment

Table 4 summarises the results of a clinical study in which exposure to buprenorphine was determined following administration of a buprenorphine/naloxone 2.0/0.5 mg sublingual tablet in healthy subjects and in subjects with different degrees of hepatic impairment.

Table 4. Effect of hepatic impairment (change relative to healthy subjects) on pharmacokinetic parameters of buprenorphine following sublingual buprenorphine/naloxone administration (2.0/0.5 mg) in healthy subjects, and in subjects with varied degrees of hepatic impairment			
Pharmacokinetic Parameter	mild hepatic impairment (Child-Pugh Class A) (n=9)	moderate hepatic impairment (Child-Pugh Class B) (n=8)	severe hepatic impairment (Child-Pugh Class C) (n=8)
Buprenorphine			
C_{max}	1.2-fold increase	1.1-fold increase	1.7-fold increase
AUC_{last}	Similar to control	1.6-fold increase	2.8-fold increase

Overall, buprenorphine plasma exposure increased approximately 3-fold in subjects with severely impaired hepatic function (see sections 4.2, 4.3 and 4.4).

Paediatric population

No pharmacokinetic data in paediatrics (less than 18 years) are available. Simulated buprenorphine exposure data in adolescents aged 16 years show lower C_{max} and AUC compared to observed values in adults for weekly and monthly Buvidal.

5.3 Preclinical safety data

Acute toxicity of buprenorphine was determined in mice and rats following oral and parenteral (intravenous, intraperitoneal) administration. Undesirable effects were based on the known pharmacological activity of buprenorphine.

Buprenorphine showed low tissue and biochemical toxicities when beagles were dosed subcutaneously for one month, rhesus monkeys orally for one month and rats and baboons intramuscularly for six months.

Teratology and reproduction toxicity studies in rats and rabbits by intramuscular administration concluded that buprenorphine is not embryotoxic or teratogenic and has no marked effects on weaning potential. In rats there were no adverse effects on fertility of general reproductive function. Chronic toxicity studies in rat and dog of the vehicle used for Buvidal revealed no special hazard for humans.

6. PHARMACEUTICAL PARTICULARS

6.1 List of excipients

Buvidal 64 mg, 96 mg, 128 mg, 160 mg

Soybean phosphatidylcholine

Glycerol dioleate

N-Methylpyrrolidone

6.2 Incompatibilities

This medicinal product must not be mixed with other medicinal products.

6.3 Shelf life

3 years

6.4 Special precautions for storage

Do not refrigerate or freeze.

6.5 Nature and contents of container

A 1 mL pre-filled syringe (glass, Type I) with plunger stopper (fluoropolymer-coated bromobutyl rubber) with needle (½-inch, 23 gauge, 12 mm) and needle shield (styrene butadiene rubber). The pre-filled syringe is assembled in a safety device for post-injection needlestick prevention. The needle shield of the safety syringe may contain rubber latex that may cause allergic reactions in latex-sensitive individuals.

Pack sizes

Pack contains 1 pre-filled syringe with stopper, needle, needle shield, safety device and 1 plunger rod.

6.6 Special precautions for disposal and other handling

Important information

- Administration should be made into the subcutaneous tissue
- Intravascular, intramuscular and intradermal administration must be avoided.
- Must not be used if the safety syringe is broken or the packaging is damaged.
- The needle shield of the syringe may contain rubber latex that may cause allergic reactions in latex sensitive individuals.
- Handle the safety syringe carefully to avoid a needle stick. The safety syringe includes a needle protection safety device that will activate at the end of the injection. Do not uncapped the safety syringe until you are ready to inject. Once uncapped, never try to recap the needle.
- Dispose of the used safety syringe right away after use. Do not re-use the safety syringe.

Before administration

Safety syringe parts:

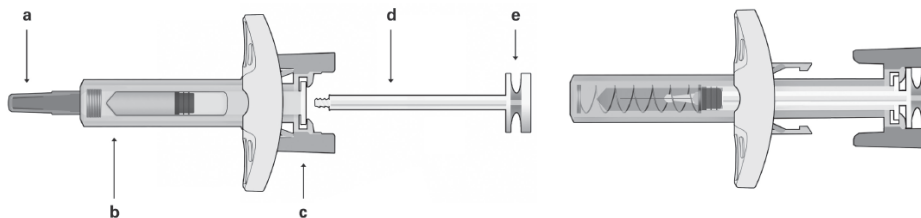

Figure 1: Safety Syringe: Before Use **Safety Syringe: After Use**
a) Needle shield, b) Syringe Guard Body, (With needle protection mechanism activated)
c) Syringe Guard Wings, d) Plunger,
e) Plunger Head

Please note that the smallest injection volume is barely visible in the viewing window as the spring of the safety device is “covering” part of the glass cylinder close to the needle.

Administration (see also section 4.2)

- Take the syringe out of the cardboard box: pick up the syringe by the syringe guard body.
- While holding the syringe by the needle shield, insert the plunger rod into the plunger stopper by gently rotating the plunger rod clockwise until secured (see Figure 2).

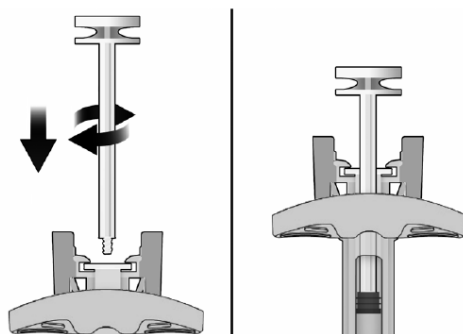

Figure 2: Before **After**

- Inspect the safety syringe closely:
 - Do not use the safety syringe after the expiration date shown on the cardboard box or on the syringe label.
 - A small air bubble may be seen, which is normal.
 - The liquid should be clear. Do not use the safety syringe if the liquid contains visible particles or is cloudy.
- Choose the injection site. Injections should be rotated between sites in the buttock, thigh, abdomen, or upper arm (see Figure 3) with a minimum of 8 weeks before re-injecting a previously used injection site. Injections on the waistline or within 5 cm of the navel should be avoided.

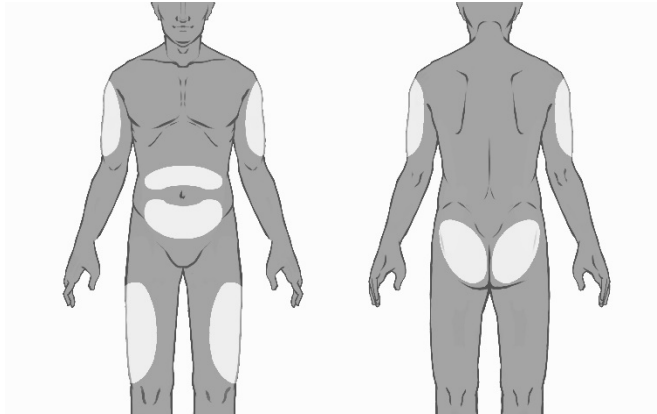

Figure 3:

- Put on gloves and clean the injection site with a circular motion using an alcohol wipe (not provided in the pack). Do not touch the cleaned area again before injecting.
- While holding the safety syringe by the syringe guard body as shown (see Figure 4), carefully pull the needle shield straight off. Immediately dispose of the needle shield (never try to recap the needle). A drop of liquid may be seen at the end of the needle. This is normal.

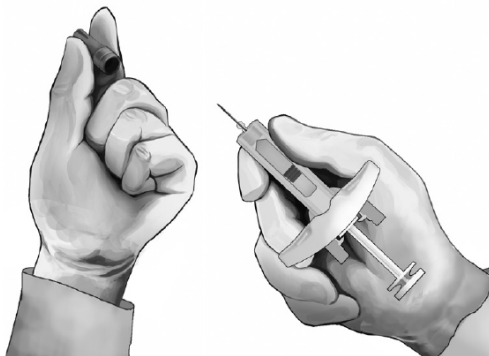

Figure 4:

- Pinch the skin at the injection site between the thumb and finger as shown (see Figure 5).
- Hold the safety syringe as shown and insert the needle at an angle of approximately 90° (see Figure 5). Push the needle all the way in.

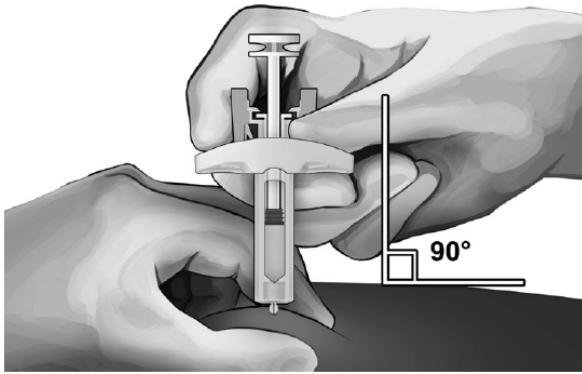

Figure 5:

- While holding the syringe as shown (see Figure 6), slowly depress the plunger until the plunger head latches between the syringe guard wings and all the solution is injected.

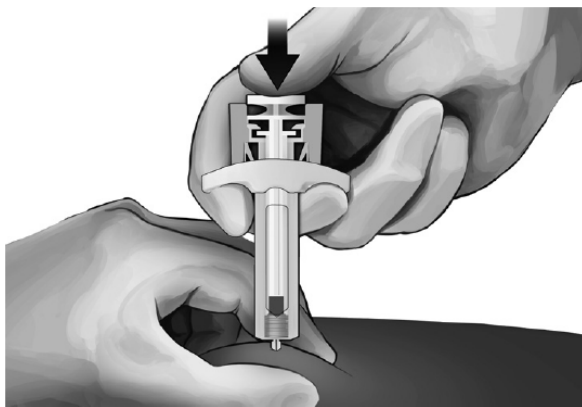

Figure 6:

- Gently pull the needle out of the skin. It is recommended that the plunger is kept fully depressed while the needle is carefully lifted straight out from the injection site (see Figure 7).

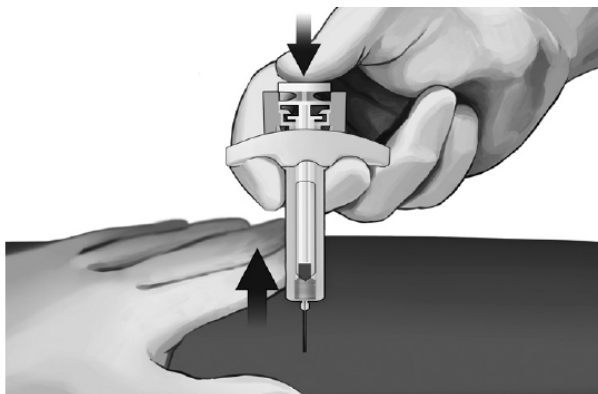

Figure 7:

- As soon as the needle has been completely removed from the skin, slowly take the thumb off the plunger and allow the syringe guard to automatically cover the exposed needle (see Figure 8). There may be a small amount of blood at the injection site, if required wipe with a cotton ball or gauze.



Figure 8:

Disposing of the syringe

Any unused medicinal product or waste material should be disposed of in accordance with local requirements.

7. MARKETING AUTHORISATION HOLDER

Camurus AB
Ideon Science Park
SE-223 70 Lund, Sweden
Phone: +800 2577 2577

8. MARKETING AUTHORISATION NUMBER(S)

Buvidal prolonged-release solution for injection (monthly)

EU/1/18/1336/005 [64 mg buprenorphine/0.18 mL]

EU/1/18/1336/006 [96 mg buprenorphine/0.27 mL]

EU/1/18/1336/007 [128 mg buprenorphine/0.36 mL]

EU/1/18/1336/009 [160 mg buprenorphine/0.45 mL]

9. DATE OF FIRST AUTHORISATION/RENEWAL OF THE AUTHORISATION

Date of first authorisation:
20 November 2018

10. DATE OF REVISION OF THE TEXT

Detailed information on this medicinal product is available on the website of the European Medicines Agency <http://www.ema.europa.eu>

ANNEX II

- A. MANUFACTURER(S) RESPONSIBLE FOR BATCH RELEASE**
- B. CONDITIONS OR RESTRICTIONS REGARDING SUPPLY AND USE**
- C. OTHER CONDITIONS AND REQUIREMENTS OF THE MARKETING AUTHORISATION**
- D. CONDITIONS OR RESTRICTIONS WITH REGARD TO THE SAFE AND EFFECTIVE USE OF THE MEDICINAL PRODUCT**

A. MANUFACTURER(S) RESPONSIBLE FOR BATCH RELEASE

Name and address of the manufacturer(s) responsible for batch release

Rechon Life Science AB
Soldatorpsvägen 5
Limhamn
21613
Sweden

B. CONDITIONS OR RESTRICTIONS REGARDING SUPPLY AND USE

Medicinal product subject to special and restricted medical prescription (See Annex I: Summary of Product Characteristics, section 4.2).

C. OTHER CONDITIONS AND REQUIREMENTS OF THE MARKETING AUTHORISATION

- **Periodic safety update reports (PSURs)**

The requirements for submission of PSURs for this medicinal product are set out in the list of Union reference dates (EURD list) provided for under Article 107c(7) of Directive 2001/83/EC and any subsequent updates published on the European medicines web-portal.

D. CONDITIONS OR RESTRICTIONS WITH REGARD TO THE SAFE AND EFFECTIVE USE OF THE MEDICINAL PRODUCT

- **Risk management plan (RMP)**

The marketing authorisation holder (MAH) shall perform the required pharmacovigilance activities and interventions detailed in the agreed RMP presented in Module 1.8.2 of the marketing authorisation and any agreed subsequent updates of the RMP.

An updated RMP should be submitted:

- At the request of the European Medicines Agency;
- Whenever the risk management system is modified, especially as the result of new information being received that may lead to a significant change to the benefit/risk profile or as the result of an important (pharmacovigilance or risk minimisation) milestone being reached.

ANNEX III
LABELLING AND PACKAGE LEAFLET

A. LABELLING

PARTICULARS TO APPEAR ON THE OUTER PACKAGING

OUTER CARTON
Pre-filled syringe

1. NAME OF THE MEDICINAL PRODUCT

Buvidal 8 mg prolonged-release solution for injection
buprenorphine

2. STATEMENT OF ACTIVE SUBSTANCE(S)

One pre-filled syringe contains 8 mg buprenorphine

3. LIST OF EXCIPIENTS

Excipients: Soybean phosphatidylcholine, glycerol dioleate, ethanol anhydrous

4. PHARMACEUTICAL FORM AND CONTENTS

Prolonged-release solution for injection
1 pre-filled syringe with safety device and 1 plunger rod

5. METHOD AND ROUTE(S) OF ADMINISTRATION

Read the package leaflet before use
Subcutaneous use
Once weekly
For single use only

6. SPECIAL WARNING THAT THE MEDICINAL PRODUCT MUST BE STORED OUT OF THE SIGHT AND REACH OF CHILDREN

Keep out of the sight and reach of children

7. OTHER SPECIAL WARNING(S), IF NECESSARY

8. EXPIRY DATE

EXP

9. SPECIAL STORAGE CONDITIONS

Do not refrigerate or freeze

10. SPECIAL PRECAUTIONS FOR DISPOSAL OF UNUSED MEDICINAL PRODUCTS OR WASTE MATERIALS DERIVED FROM SUCH MEDICINAL PRODUCTS, IF APPROPRIATE

11. NAME AND ADDRESS OF THE MARKETING AUTHORISATION HOLDER

Camurus AB
Ideon Science Park
SE-223 70 Lund, Sweden

12. MARKETING AUTHORISATION NUMBER(S)

EU/1/18/1336/001

13. BATCH NUMBER

Lot

14. GENERAL CLASSIFICATION FOR SUPPLY

15. INSTRUCTIONS ON USE

16. INFORMATION IN BRAILLE

Justification for not including Braille accepted.

17. UNIQUE IDENTIFIER – 2D BARCODE

2D barcode carrying the unique identifier included.

18. UNIQUE IDENTIFIER - HUMAN READABLE DATA

PC
SN
NN

MINIMUM PARTICULARS TO APPEAR ON SMALL IMMEDIATE PACKAGING UNITS
PRE-FILLED SYRINGE

1. NAME OF THE MEDICINAL PRODUCT AND ROUTE(S) OF ADMINISTRATION

Buvidal 8 mg prolonged-release solution for injection
buprenorphine
SC

2. METHOD OF ADMINISTRATION

3. EXPIRY DATE

EXP

4. BATCH NUMBER

Lot

5. CONTENTS BY WEIGHT, BY VOLUME OR BY UNIT

8 mg / 0.16 ml

6. OTHER

PARTICULARS TO APPEAR ON THE OUTER PACKAGING

OUTER CARTON
Pre-filled syringe

1. NAME OF THE MEDICINAL PRODUCT

Buvidal 16 mg prolonged-release solution for injection
buprenorphine

2. STATEMENT OF ACTIVE SUBSTANCE(S)

One pre-filled syringe contains 16 mg buprenorphine

3. LIST OF EXCIPIENTS

Excipients: Soybean phosphatidylcholine, glycerol dioleate, ethanol anhydrous

4. PHARMACEUTICAL FORM AND CONTENTS

Prolonged-release solution for injection
1 pre-filled syringe with safety device and 1 plunger rod

5. METHOD AND ROUTE(S) OF ADMINISTRATION

Read the package leaflet before use
Subcutaneous use
For single use only
Once weekly

6. SPECIAL WARNING THAT THE MEDICINAL PRODUCT MUST BE STORED OUT OF THE SIGHT AND REACH OF CHILDREN

Keep out of the sight and reach of children

7. OTHER SPECIAL WARNING(S), IF NECESSARY

8. EXPIRY DATE

EXP

9. SPECIAL STORAGE CONDITIONS

Do not refrigerate or freeze

10. SPECIAL PRECAUTIONS FOR DISPOSAL OF UNUSED MEDICINAL PRODUCTS OR WASTE MATERIALS DERIVED FROM SUCH MEDICINAL PRODUCTS, IF APPROPRIATE

11. NAME AND ADDRESS OF THE MARKETING AUTHORISATION HOLDER

Camurus AB
Ideon Science Park
SE-223 70 Lund, Sweden

12. MARKETING AUTHORISATION NUMBER(S)

EU/1/18/1336/002

13. BATCH NUMBER

Lot

14. GENERAL CLASSIFICATION FOR SUPPLY

15. INSTRUCTIONS ON USE

16. INFORMATION IN BRAILLE

Justification for not including Braille accepted.

17. UNIQUE IDENTIFIER – 2D BARCODE

2D barcode carrying the unique identifier included.

18. UNIQUE IDENTIFIER - HUMAN READABLE DATA

PC
SN
NN

**MINIMUM PARTICULARS TO APPEAR ON SMALL IMMEDIATE PACKAGING UNITS
PRE-FILLED SYRINGE**

1. NAME OF THE MEDICINAL PRODUCT AND ROUTE(S) OF ADMINISTRATION

Buvidal 16 mg prolonged-release solution for injection
buprenorphine
SC

2. METHOD OF ADMINISTRATION

3. EXPIRY DATE

EXP

4. BATCH NUMBER

Lot

5. CONTENTS BY WEIGHT, BY VOLUME OR BY UNIT

16 mg / 0.32 ml

6. OTHER

PARTICULARS TO APPEAR ON THE OUTER PACKAGING

OUTER CARTON
Pre-filled syringe

1. NAME OF THE MEDICINAL PRODUCT

Buvidal 24 mg prolonged-release solution for injection
buprenorphine

2. STATEMENT OF ACTIVE SUBSTANCE(S)

One pre-filled syringe contains 24 mg buprenorphine

3. LIST OF EXCIPIENTS

Excipients: Soybean phosphatidylcholine, glycerol dioleate, ethanol anhydrous

4. PHARMACEUTICAL FORM AND CONTENTS

Prolonged-release solution for injection
1 pre-filled syringe with safety device and 1 plunger rod

5. METHOD AND ROUTE(S) OF ADMINISTRATION

Read the package leaflet before use
Subcutaneous use
For single use only
Once weekly

6. SPECIAL WARNING THAT THE MEDICINAL PRODUCT MUST BE STORED OUT OF THE SIGHT AND REACH OF CHILDREN

Keep out of the sight and reach of children

7. OTHER SPECIAL WARNING(S), IF NECESSARY

8. EXPIRY DATE

EXP

9. SPECIAL STORAGE CONDITIONS

Do not refrigerate or freeze

10. SPECIAL PRECAUTIONS FOR DISPOSAL OF UNUSED MEDICINAL PRODUCTS OR WASTE MATERIALS DERIVED FROM SUCH MEDICINAL PRODUCTS, IF APPROPRIATE

11. NAME AND ADDRESS OF THE MARKETING AUTHORISATION HOLDER

Camurus AB
Ideon Science Park
SE-223 70 Lund, Sweden

12. MARKETING AUTHORISATION NUMBER(S)

EU/1/18/1336/003

13. BATCH NUMBER

Lot

14. GENERAL CLASSIFICATION FOR SUPPLY

15. INSTRUCTIONS ON USE

16. INFORMATION IN BRAILLE

Justification for not including Braille accepted.

17. UNIQUE IDENTIFIER – 2D BARCODE

2D barcode carrying the unique identifier included.

18. UNIQUE IDENTIFIER - HUMAN READABLE DATA

PC
SN
NN

**MINIMUM PARTICULARS TO APPEAR ON SMALL IMMEDIATE PACKAGING UNITS
PRE-FILLED SYRINGE**

1. NAME OF THE MEDICINAL PRODUCT AND ROUTE(S) OF ADMINISTRATION

Buvidal 24 mg prolonged-release solution for injection
buprenorphine
SC

2. METHOD OF ADMINISTRATION

3. EXPIRY DATE

EXP

4. BATCH NUMBER

Lot

5. CONTENTS BY WEIGHT, BY VOLUME OR BY UNIT

24 mg / 0.48 ml

6. OTHER

PARTICULARS TO APPEAR ON THE OUTER PACKAGING

OUTER CARTON
Pre-filled syringe

1. NAME OF THE MEDICINAL PRODUCT

Buvidal 32 mg prolonged-release solution for injection
buprenorphine

2. STATEMENT OF ACTIVE SUBSTANCE(S)

One pre-filled syringe contains 32 mg buprenorphine

3. LIST OF EXCIPIENTS

Excipients: Soybean phosphatidylcholine, glycerol dioleate, ethanol anhydrous

4. PHARMACEUTICAL FORM AND CONTENTS

Prolonged-release solution for injection
1 pre-filled syringe with safety device and 1 plunger rod

5. METHOD AND ROUTE(S) OF ADMINISTRATION

Read the package leaflet before use
Subcutaneous use
For single use only
Once weekly

6. SPECIAL WARNING THAT THE MEDICINAL PRODUCT MUST BE STORED OUT OF THE SIGHT AND REACH OF CHILDREN

Keep out of the sight and reach of children

7. OTHER SPECIAL WARNING(S), IF NECESSARY

8. EXPIRY DATE

EXP

9. SPECIAL STORAGE CONDITIONS

Do not refrigerate or freeze

10. SPECIAL PRECAUTIONS FOR DISPOSAL OF UNUSED MEDICINAL PRODUCTS OR WASTE MATERIALS DERIVED FROM SUCH MEDICINAL PRODUCTS, IF APPROPRIATE

11. NAME AND ADDRESS OF THE MARKETING AUTHORISATION HOLDER

Camurus AB
Ideon Science Park
SE-223 70 Lund, Sweden

12. MARKETING AUTHORISATION NUMBER(S)

EU/1/18/1336/004

13. BATCH NUMBER

Lot

14. GENERAL CLASSIFICATION FOR SUPPLY

15. INSTRUCTIONS ON USE

16. INFORMATION IN BRAILLE

Justification for not including Braille accepted.

17. UNIQUE IDENTIFIER – 2D BARCODE

2D barcode carrying the unique identifier included.

18. UNIQUE IDENTIFIER - HUMAN READABLE DATA

PC
SN
NN

**MINIMUM PARTICULARS TO APPEAR ON SMALL IMMEDIATE PACKAGING UNITS
PRE-FILLED SYRINGE**

1. NAME OF THE MEDICINAL PRODUCT AND ROUTE(S) OF ADMINISTRATION

Buvidal 32 mg prolonged-release solution for injection
buprenorphine
SC

2. METHOD OF ADMINISTRATION

3. EXPIRY DATE

EXP

4. BATCH NUMBER

Lot

5. CONTENTS BY WEIGHT, BY VOLUME OR BY UNIT

32 mg / 0.64 ml

6. OTHER

PARTICULARS TO APPEAR ON THE OUTER PACKAGING

OUTER CARTON
Pre-filled syringe

1. NAME OF THE MEDICINAL PRODUCT

Buvidal 64 mg prolonged-release solution for injection
buprenorphine

2. STATEMENT OF ACTIVE SUBSTANCE(S)

One pre-filled syringe contains 64 mg buprenorphine

3. LIST OF EXCIPIENTS

Excipients: Soybean phosphatidylcholine, glycerol dioleate, N-methylpyrrolidone

4. PHARMACEUTICAL FORM AND CONTENTS

Prolonged-release solution for injection
1 pre-filled syringe with safety device and 1 plunger rod

5. METHOD AND ROUTE(S) OF ADMINISTRATION

Read the package leaflet before use
Subcutaneous use
For single use only
Once monthly

6. SPECIAL WARNING THAT THE MEDICINAL PRODUCT MUST BE STORED OUT OF THE SIGHT AND REACH OF CHILDREN

Keep out of the sight and reach of children

7. OTHER SPECIAL WARNING(S), IF NECESSARY

8. EXPIRY DATE

EXP

9. SPECIAL STORAGE CONDITIONS

Do not refrigerate or freeze

10. SPECIAL PRECAUTIONS FOR DISPOSAL OF UNUSED MEDICINAL PRODUCTS OR WASTE MATERIALS DERIVED FROM SUCH MEDICINAL PRODUCTS, IF APPROPRIATE

11. NAME AND ADDRESS OF THE MARKETING AUTHORISATION HOLDER

Camurus AB
Ideon Science Park
SE-223 70 Lund, Sweden

12. MARKETING AUTHORISATION NUMBER(S)

EU/1/18/1336/005

13. BATCH NUMBER

Lot

14. GENERAL CLASSIFICATION FOR SUPPLY

15. INSTRUCTIONS ON USE

16. INFORMATION IN BRAILLE

Justification for not including Braille accepted.

17. UNIQUE IDENTIFIER – 2D BARCODE

2D barcode carrying the unique identifier included.

18. UNIQUE IDENTIFIER - HUMAN READABLE DATA

PC
SN
NN

**MINIMUM PARTICULARS TO APPEAR ON SMALL IMMEDIATE PACKAGING UNITS
PRE-FILLED SYRINGE**

1. NAME OF THE MEDICINAL PRODUCT AND ROUTE(S) OF ADMINISTRATION

Buvidal 64 mg prolonged-release solution for injection
buprenorphine
SC

2. METHOD OF ADMINISTRATION

3. EXPIRY DATE

EXP

4. BATCH NUMBER

Lot

5. CONTENTS BY WEIGHT, BY VOLUME OR BY UNIT

64 mg / 0.18 ml

6. OTHER

PARTICULARS TO APPEAR ON THE OUTER PACKAGING

OUTER CARTON
Pre-filled syringe

1. NAME OF THE MEDICINAL PRODUCT

Buvidal 96 mg prolonged-release solution for injection
buprenorphine

2. STATEMENT OF ACTIVE SUBSTANCE(S)

One pre-filled syringe contains 96 mg buprenorphine

3. LIST OF EXCIPIENTS

Excipients: Soybean phosphatidylcholine, glycerol dioleate, N-methylpyrrolidone

4. PHARMACEUTICAL FORM AND CONTENTS

Prolonged-release solution for injection
1 pre-filled syringe with safety device and 1 plunger rod

5. METHOD AND ROUTE(S) OF ADMINISTRATION

Read the package leaflet before use
Subcutaneous use
For single use only
Once monthly

6. SPECIAL WARNING THAT THE MEDICINAL PRODUCT MUST BE STORED OUT OF THE SIGHT AND REACH OF CHILDREN

Keep out of the sight and reach of children

7. OTHER SPECIAL WARNING(S), IF NECESSARY

8. EXPIRY DATE

EXP

9. SPECIAL STORAGE CONDITIONS

Do not refrigerate or freeze

10. SPECIAL PRECAUTIONS FOR DISPOSAL OF UNUSED MEDICINAL PRODUCTS OR WASTE MATERIALS DERIVED FROM SUCH MEDICINAL PRODUCTS, IF APPROPRIATE

11. NAME AND ADDRESS OF THE MARKETING AUTHORISATION HOLDER

Camurus AB
Ideon Science Park
SE-223 70 Lund, Sweden

12. MARKETING AUTHORISATION NUMBER(S)

EU/1/18/1336/006

13. BATCH NUMBER

Lot

14. GENERAL CLASSIFICATION FOR SUPPLY

15. INSTRUCTIONS ON USE

16. INFORMATION IN BRAILLE

Justification for not including Braille accepted.

17. UNIQUE IDENTIFIER – 2D BARCODE

2D barcode carrying the unique identifier included.

18. UNIQUE IDENTIFIER - HUMAN READABLE DATA

PC
SN
NN

MINIMUM PARTICULARS TO APPEAR ON SMALL IMMEDIATE PACKAGING UNITS
PRE-FILLED SYRINGE

1. NAME OF THE MEDICINAL PRODUCT AND ROUTE(S) OF ADMINISTRATION

Buvidal 96 mg prolonged-release solution for injection
buprenorphine
SC

2. METHOD OF ADMINISTRATION

3. EXPIRY DATE

EXP

4. BATCH NUMBER

Lot

5. CONTENTS BY WEIGHT, BY VOLUME OR BY UNIT

96 mg / 0.27 ml

6. OTHER

PARTICULARS TO APPEAR ON THE OUTER PACKAGING

OUTER CARTON
Pre-filled syringe

1. NAME OF THE MEDICINAL PRODUCT

Buvidal 128 mg prolonged-release solution for injection
buprenorphine

2. STATEMENT OF ACTIVE SUBSTANCE(S)

One pre-filled syringe contains 128 mg buprenorphine

3. LIST OF EXCIPIENTS

Excipients: Soybean phosphatidylcholine, glycerol dioleate, N-methylpyrrolidone

4. PHARMACEUTICAL FORM AND CONTENTS

Prolonged-release solution for injection
1 pre-filled syringe with safety device and 1 plunger rod

5. METHOD AND ROUTE(S) OF ADMINISTRATION

Read the package leaflet before use
Subcutaneous use
For single use only
Once monthly

6. SPECIAL WARNING THAT THE MEDICINAL PRODUCT MUST BE STORED OUT OF THE SIGHT AND REACH OF CHILDREN

Keep out of the sight and reach of children

7. OTHER SPECIAL WARNING(S), IF NECESSARY

8. EXPIRY DATE

EXP

9. SPECIAL STORAGE CONDITIONS

Do not refrigerate or freeze

10. SPECIAL PRECAUTIONS FOR DISPOSAL OF UNUSED MEDICINAL PRODUCTS OR WASTE MATERIALS DERIVED FROM SUCH MEDICINAL PRODUCTS, IF APPROPRIATE

11. NAME AND ADDRESS OF THE MARKETING AUTHORISATION HOLDER

Camurus AB
Ideon Science Park
SE-223 70 Lund, Sweden

12. MARKETING AUTHORISATION NUMBER(S)

EU/1/18/1336/007

13. BATCH NUMBER

Lot

14. GENERAL CLASSIFICATION FOR SUPPLY

15. INSTRUCTIONS ON USE

16. INFORMATION IN BRAILLE

Justification for not including Braille accepted.

17. UNIQUE IDENTIFIER – 2D BARCODE

2D barcode carrying the unique identifier included.

18. UNIQUE IDENTIFIER - HUMAN READABLE DATA

PC
SN
NN

MINIMUM PARTICULARS TO APPEAR ON SMALL IMMEDIATE PACKAGING UNITS
PRE-FILLED SYRINGE

1. NAME OF THE MEDICINAL PRODUCT AND ROUTE(S) OF ADMINISTRATION

Buvidal 128 mg prolonged-release solution for injection
buprenorphine
SC

2. METHOD OF ADMINISTRATION

3. EXPIRY DATE

EXP

4. BATCH NUMBER

Lot

5. CONTENTS BY WEIGHT, BY VOLUME OR BY UNIT

128 mg/0.36 ml

6. OTHER

PARTICULARS TO APPEAR ON THE OUTER PACKAGING

OUTER CARTON
Pre-filled syringe

1. NAME OF THE MEDICINAL PRODUCT

Buvidal 160 mg prolonged-release solution for injection
buprenorphine

2. STATEMENT OF ACTIVE SUBSTANCE(S)

One pre-filled syringe contains 160 mg buprenorphine

3. LIST OF EXCIPIENTS

Excipients: Soybean phosphatidylcholine, glycerol dioleate, N-methylpyrrolidone

4. PHARMACEUTICAL FORM AND CONTENTS

Prolonged-release solution for injection
1 pre-filled syringe with safety device and 1 plunger rod

5. METHOD AND ROUTE(S) OF ADMINISTRATION

Read the package leaflet before use
Subcutaneous use
For single use only
Once monthly

6. SPECIAL WARNING THAT THE MEDICINAL PRODUCT MUST BE STORED OUT OF THE SIGHT AND REACH OF CHILDREN

Keep out of the sight and reach of children

7. OTHER SPECIAL WARNING(S), IF NECESSARY

8. EXPIRY DATE

EXP

9. SPECIAL STORAGE CONDITIONS

Do not refrigerate or freeze

10. SPECIAL PRECAUTIONS FOR DISPOSAL OF UNUSED MEDICINAL PRODUCTS OR WASTE MATERIALS DERIVED FROM SUCH MEDICINAL PRODUCTS, IF APPROPRIATE

11. NAME AND ADDRESS OF THE MARKETING AUTHORISATION HOLDER

Camurus AB
Ideon Science Park
SE-223 70 Lund, Sweden

12. MARKETING AUTHORISATION NUMBER(S)

EU/1/18/1336/009

13. BATCH NUMBER

Lot

14. GENERAL CLASSIFICATION FOR SUPPLY

15. INSTRUCTIONS ON USE

16. INFORMATION IN BRAILLE

Justification for not including Braille accepted.

17. UNIQUE IDENTIFIER – 2D BARCODE

2D barcode carrying the unique identifier included.

18. UNIQUE IDENTIFIER - HUMAN READABLE DATA

PC
SN
NN

**MINIMUM PARTICULARS TO APPEAR ON SMALL IMMEDIATE PACKAGING UNITS
PRE-FILLED SYRINGE**

1. NAME OF THE MEDICINAL PRODUCT AND ROUTE(S) OF ADMINISTRATION

Buvidal 160 mg prolonged-release solution for injection
buprenorphine
SC

2. METHOD OF ADMINISTRATION

3. EXPIRY DATE

EXP

4. BATCH NUMBER

Lot

5. CONTENTS BY WEIGHT, BY VOLUME OR BY UNIT

160 mg / 0.45 ml

6. OTHER

B. PACKAGE LEAFLET

Package leaflet: Information for the user

Buvidal 8 mg prolonged-release solution for injection
Buvidal 16 mg prolonged-release solution for injection
Buvidal 24 mg prolonged-release solution for injection
Buvidal 32 mg prolonged-release solution for injection
Buvidal 64 mg prolonged-release solution for injection
Buvidal 96 mg prolonged-release solution for injection
Buvidal 128 mg prolonged-release solution for injection
Buvidal 160 mg prolonged-release solution for injection

buprenorphine

Read all of this leaflet carefully before you start receiving this medicine because it contains important information for you.

- Keep this leaflet. You may need to read it again.
- If you have any further questions, ask your doctor, pharmacist or nurse.
- If you get any side effects, talk to your doctor, pharmacist or nurse. This includes any possible side effects not listed in this leaflet. See section 4.

What is in this leaflet

1. What Buvidal is and what it is used for
2. What you need to know before you use Buvidal
3. How Buvidal is given
4. Possible side effects
5. How to store Buvidal
6. Contents of the pack and other information

1. What Buvidal is and what it is used for

Buvidal contains the active substance buprenorphine, which is a type of opioid medicine. It is used to treat opioid dependence in patients who are also receiving medical, social and psychological support. Buvidal is intended for use in adults and adolescents aged 16 years or over.

2. What you need to know before you receive Buvidal

You must not receive Buvidal

- if you are allergic to buprenorphine or any of the other ingredients of this medicine (listed in section 6)
- if you have serious breathing problems
- if you have serious liver problems
- if you are intoxicated with alcohol or have trembling, sweating, anxiety, confusion or hallucinations caused by alcohol

Warnings and precautions

Talk to your doctor before receiving Buvidal if you have:

- asthma or other breathing problems
- any liver disease such as hepatitis
- severe kidney impairment
- certain heart rhythm conditions (long QT syndrome or prolonged QT interval)

- low blood pressure
 - recently suffered a head injury or brain disease
 - a urinary disorder (especially linked to enlarged prostate in men)
 - thyroid problems
 - an adrenocortical disorder (e.g. Addison's disease)
 - gall bladder problems
 - depression or other conditions that are treated with antidepressants.
- The use of these medicines together with Buvidal can lead to serotonin syndrome, a potentially life-threatening condition (see "Other medicines and Buvidal").

Important things to be aware of

- **Breathing problems:** Some people have died from very slow or shallow breathing caused by taking buprenorphine with other central nervous system depressants (substances that slow down some brain activity) such as benzodiazepines, alcohol or other opioids.
- **Drowsiness:** This medicine may cause drowsiness especially when used with alcohol or other central nervous system depressants (substances that slow down some brain activity) such as benzodiazepines, other medicines that reduce anxiety or cause sleepiness, pregabalin or gabapentin.
- **Dependence:** This medicine can cause dependence.
- **Liver damage:** Liver damage can occur with buprenorphine, especially when it is misused. It can also occur because of viral infections (chronic hepatitis C), alcohol abuse, anorexia (eating disorder) or use of other medicines which harm your liver. Your doctor may ask you to have regular blood tests to check your liver. Tell your doctor if you have any liver problems before you start treatment with Buvidal.
- **Withdrawal symptoms:** This medicine can cause withdrawal symptoms if you take it less than 6 hours after you use a short-acting opioid (e.g. morphine, heroin) or less than 24 hours after you use a long-acting opioid such as methadone.
- **Blood pressure:** This medicine may cause your blood pressure to drop suddenly, causing you to feel dizzy if you get up too quickly from sitting or lying down.
- **Diagnosis of unrelated medical conditions:** This medicine may mask pain and make it difficult to diagnose some diseases. Do not forget to tell your doctor that you are being treated with this medicine.
- **Sleep-related breathing disorders:** Buvidal can cause sleep-related breathing disorders such as sleep apnoea (breathing pauses during sleep) and sleep related hypoxemia (low oxygen level in the blood). The symptoms can include breathing pauses during sleep, night awakening due to shortness of breath, difficulties to maintain sleep or excessive drowsiness during the day. If you or another person observe these symptoms, contact your doctor. A dose reduction may be considered by your doctor.

Children and adolescents

Buvidal is not for use in children below 16 years of age. You will be more closely monitored by your doctor if you are an adolescent (16-17 years old).

Other medicines and Buvidal

Tell your doctor if you are taking, have recently taken or might take any other medicines. Some medicines may increase the side effects of Buvidal and may cause very serious reactions.

It is especially important to tell your doctor if you are taking:

- **benzodiazepines** (used to treat anxiety or sleep disorders). Taking too much of a benzodiazepine together with Buvidal may lead to death because both medicines can cause very slow and shallow breathing (respiratory depression). If you need a benzodiazepine, your doctor will prescribe the correct dose.
- **gabapentinoids (gabapentin or pregabalin)** (used to treat epilepsy or neuropathic pain). Taking too much of a gabapentinoid may lead to death because both medicines can cause very

slow and shallow breathing (respiratory depression). You must use the dose that your doctor has prescribed for you.

- **alcohol or medicines containing alcohol.** Alcohol can worsen the sedative effect of this medicine.
- **other medicines that may make you feel sleepy** which are used to treat illnesses such as anxiety, sleeplessness, convulsions (fits) and pain. These medicines when taken together with Buvidal can slow down some brain activity and reduce alertness and how well you will drive and use machines.

Examples of medicines that can make you feel sleepy or less alert include:

- other opioids such as methadone, certain painkillers and cough medicines. These medicines may also increase the risk of opioid overdose
- antidepressants (used to treat depression)
- sedative antihistamines (used to treat allergic reactions)
- barbiturates (used to cause sleep or sedation)
- certain anxiolytics (used to treat anxiety disorders)
- antipsychotics (used to treat psychiatric disorders such as schizophrenia)
- clonidine (used to treat high blood pressure)
- **opioid painkillers.** These medicines may not work properly when taken together with Buvidal and they may increase the risk of overdose.
- **naltrexone and nalmefene** (used to treat addiction disorders) as they can stop Buvidal from working properly. You should not take them at the same time as this medicine.
- **certain antiretrovirals** (used to treat HIV infection) such as ritonavir, nelfinavir or indinavir as they may increase the effects of this medicine.
- **certain antifungal medicines** (used to treat fungal infections) such as ketoconazole, itraconazole as they may increase the effects of this medicine.
- **macrolide antibiotics** (used to treat bacterial infections) such as clarithromycin and erythromycin as they may increase the effects of this medicine.
- **certain antiepileptic medicines** (used to treat epilepsy) such as phenobarbital, carbamazepine and phenytoin as they may decrease the effect of Buvidal.
- **rifampicin** (used to treat tuberculosis). Rifampicin may decrease the effect of Buvidal.
- **monoamine oxidase inhibitors** (used to treat depression) such as phenelzine, isocarboxazid, iponiazid and tranylcypromine as they may increase the effects of this medicine.
- **anti-depressants** such as moclobemide, tranylcypromine, citalopram, escitalopram, fluoxetine, fluvoxamine, paroxetine, sertraline, duloxetine, venlafaxine, amitriptyline, doxepine, or trimipramine. These medicines may interact with Buvidal and you may experience symptoms such as involuntary, rhythmic contractions of muscles, including the muscles that control movement of the eye, agitation, hallucinations, coma, excessive sweating, tremor, exaggeration of reflexes, increased muscle tension, body temperature above 38°C. Contact your doctor when experiencing such symptoms.

Buvidal with alcohol

Taking alcohol with this medicine may increase drowsiness and may increase the risk of breathing problems.

Pregnancy and breast-feeding

If you are pregnant or breast-feeding, think you may become pregnant or are planning to have a baby, ask your doctor for advice before you are given this medicine. The risks of using Buvidal in pregnant women are not known. Your doctor will help you decide if you should continue taking the medicine during pregnancy.

Using this medicine during late pregnancy may cause drug withdrawal symptoms including breathing problems in your new-born baby. This may happen from several hours to several days after birth.

Check with your doctor before using Buvidal during breastfeeding as this medicine passes into breast milk.

Driving and using machines

Buvidal may make you sleepy and dizzy. This is more likely at the start of treatment and when your dose is being changed. These effects can be worse if you drink alcohol or take other sedative medicines. Do not drive, use any tools or machines, or perform dangerous activities until you know how this medicine affects you.

Buvidal contains alcohol

Buvidal 8 mg, 16 mg, 24 mg and 32 mg contain 95.7 mg of alcohol (ethanol) in each mL (10% w/w). The amount in 1 dose of this medicine is equivalent to less than 2 mL beer or 1 mL wine. The small amount of alcohol in this medicine will not have any noticeable effects.

3. How to use Buvidal

Buvidal must be given by healthcare professionals only.

Buvidal 8 mg, 16 mg, 24 mg and 32 mg are given weekly. Buvidal 64 mg, 96 mg, 128 mg and 160 mg are given monthly.

Your doctor will determine the best dose for you. During your treatment, the doctor may adjust the dose, depending on how well the medicine works.

Starting treatment

The first dose of Buvidal will be given to you when you show clear signs of withdrawal.

If you are dependent on short-acting opioids (e.g. morphine or heroin), the first dose of Buvidal will be given to you at least 6 hours after you last used an opioid.

If you are dependent on long-acting opioids (e.g. methadone), your dose of methadone will be reduced to below 30 mg per day before beginning with Buvidal. The first dose of this medicine will be given to you at least 24 hours after you last used methadone.

If you are not already receiving sublingual (under the tongue) buprenorphine (the same active substance as in Buvidal), the recommended starting dose is 16 mg, with one or two additional Buvidal 8 mg doses given at least 1 day apart during the first treatment week. This means a target dose of 24 mg or 32 mg during the first treatment week.

If you have not used buprenorphine before you will receive a 4 mg sublingual buprenorphine dose and be observed for an hour before the first Buvidal dose.

Buvidal for monthly treatment can be used, if appropriate for you, once stabilisation has been achieved with Buvidal for weekly treatment (four weeks treatment or more, where practical).

If you are already taking sublingual buprenorphine, you can start receiving Buvidal the day after your last treatment. Your doctor will prescribe the correct starting dose of Buvidal for you depending on the dose of sublingual buprenorphine you are now taking.

Continuing treatment and dose adjustment

During continued treatment with Buvidal, your doctor may decrease or increase your dose according to your need. You may be switched from weekly and monthly treatment and from monthly to weekly treatment. Your doctor will prescribe the correct dose for you.

During continued treatment, you might receive one additional Buvidal 8 mg dose between your weekly or monthly treatments if your doctor thinks this is appropriate for you.

The maximum dose per week if you are on weekly Buvidal treatment is 32 mg with an additional 8 mg dose. The maximum dose per month if you are on monthly Buvidal treatment is 160 mg.

Route of administration

Buvidal is given as a single injection under the skin (subcutaneously) in any of the allowed injection areas buttock, thigh, abdomen or upper arm. You can receive several injections in the same injection area, but the exact injection sites will be different for each weekly and monthly injection for a minimum period of 8 weeks.

If you use more buprenorphine than you should

If you have received more buprenorphine than you should you need to contact your doctor immediately since this can cause very slow and shallow breathing which can lead to death.

If you use too much buprenorphine, you must immediately seek medical attention as overdose may cause serious and life-threatening breathing problems. Symptoms of overdose may include breathing more slowly and weakly than usual, feeling more sleepy than normal, smaller pupils. If you start to feel faint as this may be a sign of low blood pressure, feeling sick, vomit and/or slurred speech.

If you miss a dose of Buvidal

It is very important to keep all your appointments to receive Buvidal. If you miss an appointment, ask your doctor when to schedule your next dose.

If you stop using Buvidal

Do not stop treatment without checking with the doctor who is treating you. Stopping treatment may cause withdrawal symptoms.

If you have any further questions on the use of this product, ask your doctor.

4. Possible side effects

Like all medicines, this medicine can cause side effects, although not everybody gets them.

Tell your doctor immediately or get urgent medical attention if you have side effects such as:

- sudden wheezing, difficulty breathing, swelling of the eyelids, face, tongue, lips, throat or hands; rash or itching especially over your whole body. These may be signs of a life-threatening allergic reaction.
- if you start to breathe more slowly or weakly than usual (respiratory depression).
- if you start to feel faint, as this may be a sign of low blood pressure.

Also tell your doctor immediately if you get side effects such as:

- severe tiredness, have no appetite or if your skin or eyes look yellow. These may be symptoms of liver damage.

Other side effects:

Very common side effects (may affect more than 1 in 10 people):

- Insomnia (inability to sleep)
- Headache
- Nausea (feeling sick)
- Sweating, drug withdrawal syndrome, pain

Common side effects (may affect up to 1 in 10 people):

- Infection, influenza, sore throat and painful swallowing, runny nose
- Swollen glands (lymph nodes)
- Hypersensitivity
- Decreased appetite
- Anxiety, agitation, depression, hostility, nervousness, abnormal thinking, paranoia

- Sleepiness, feeling dizzy, migraine, burning or tingling in hands and feet, fainting, tremor, increase in muscle tension, speech disorders
- Watery eyes, abnormal widening or narrowing of the pupil (the dark part of the eye)
- Palpitations
- Low blood pressure
- Cough, shortness of breath, yawning, asthma, bronchitis
- Constipation, vomiting (being sick), belly pain, flatulence (wind), indigestion, dry mouth, diarrhoea
- Rash, itching, hives
- Joint pain, back pain, muscle pain, muscle spasms, neck pain, bone pain
- Painful period
- Injection site reactions e.g. pain, itching, red skin, swelling and hardening of skin, swelling of the ankles, feet or fingers, weakness, feeling unwell, fever, chills, drug withdrawal syndrome in the new-born, chest pain
- Abnormal liver test results

Uncommon side effects (may affect up to 1 in 100 people):

- Skin infection at the injection site
- A feeling of dizziness or spinning (vertigo)

Not known (frequency cannot be estimated from the available data):

- Hallucinations, feeling happiness and excitement (euphoria)
- Abnormal redness of the skin
- Painful or difficult urination

Reporting of side effects

If you get any side effects, talk to your doctor. This includes any possible side effects not listed in this leaflet. You can also report side effects directly via **the national reporting system** listed in [Appendix V](#). By reporting side effects you can help provide more information on the safety of this medicine.

5. How to store Buvidal

Buvidal is for administration of healthcare professionals only. Take-home use or self-administration of the product by patients is not allowed.

Keep this medicine out of the sight and reach of children.

Do not use this medicine after the expiry date which is stated on the carton or the syringe label after EXP. The expiry date refers to the last day of that month.

Do not refrigerate or freeze.

Do not use this medicine if you notice visible particles or if it is cloudy.

Buvidal is for single use only. Any used syringe should be discarded.

Do not throw away any medicines via wastewater or household waste. Ask your pharmacist how to throw away medicines you no longer use. These measures will help protect the environment.

6. Contents of the pack and other information

What Buvidal contains

- The active substance is buprenorphine
- The other ingredients are soybean phosphatidylcholine, glycerol dioleate, ethanol anhydrous (only in weekly formulation) and N-methylpyrrolidone (only in monthly formulation).

The following syringes are available:

Weekly injection:

8 mg: Pre-filled syringe containing 8 mg buprenorphine in 0.16 mL solution

16 mg: Pre-filled syringe containing 16 mg buprenorphine in 0.32 mL solution
24 mg: Pre-filled syringe containing 24 mg buprenorphine in 0.48 mL solution
32 mg: Pre-filled syringe containing 32 mg buprenorphine in 0.64 mL solution

Monthly injection:

64 mg: Pre-filled syringe containing 64 mg buprenorphine in 0.18 mL solution
96 mg: Pre-filled syringe containing 96 mg buprenorphine in 0.27 mL solution
128 mg: Pre-filled syringe containing 128 mg buprenorphine in 0.36 mL solution
160 mg: Pre-filled syringe containing 160 mg buprenorphine in 0.45 mL solution

What Buvidal looks like and contents of the pack

Buvidal is a prolonged-release solution for injection. Each pre-filled syringe contains a yellowish to yellow clear liquid.

The following pack sizes are available:

Pre-filled syringes containing 8 mg, 16 mg, 24 mg, 32 mg, 64 mg, 96 mg, 128 mg and 160 mg solution for injection.

Each pack contains 1 pre-filled syringe with stopper, needle, needle shield, safety device and 1 plunger rod.

Marketing Authorisation Holder

Camurus AB
Ideon Science Park
SE-223 70 Lund, Sweden
Tel: +800 2577 2577

Manufacturer

Rechon Life Science AB
Soldatorpsvägen 5
216 13 Limhamn
Sweden

This leaflet was last revised in {MM/YYYY}.

Detailed information on this medicine is available on the European Medicines Agency web site:
<http://www.ema.europa.eu>.

The following information is intended for healthcare professionals only:

Instructions for Use for Healthcare Professionals

Contents:

- 1. Important information**
- 2. Before administration**
- 3. Administration**
- 4. Disposing of the syringe**

1. Important information

- Injection should be made into the subcutaneous tissue. Do not use if the safety syringe is broken or the packaging is damaged.
- The needle shields of the safety syringe may contain rubber latex that may cause allergic reactions in latex-sensitive individuals.
- Handle the safety syringe carefully to avoid a needle stick. The safety syringe includes a needle protection safety device that will activate at the end of the injection. The needle protection will help to prevent needle stick injuries.
- Do not uncapped the safety syringe until you are ready to inject. Once uncapped never try to recap the needle.
- Dispose of the used safety syringe right away after use. Do not reuse the safety syringe.

2. Before administration

Safety syringe parts

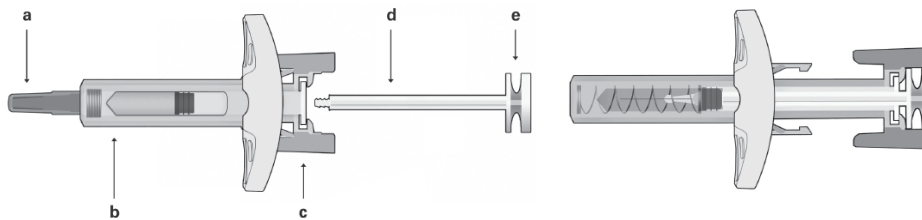

Figure 1 Safety Syringe: Before Use

- a) Needle shield
- b) Syringe Guard Body
- c) Syringe Guard Wings
- d) Plunger
- e) Plunger Head

Safety Syringe: After Use

(With needle protection mechanism activated)

Please note that the smallest injection volume is barely visible in the viewing window as the spring of the safety device “cover” part of the glass cylinder close to the needle.

3. Administration

- Take the syringe out of the cardboard box: pick up the syringe by the syringe guard body.
- While holding the syringe by the needle shield, insert the plunger rod into the plunger stopper by gently rotating the plunger rod clockwise until secured (see Figure 2).

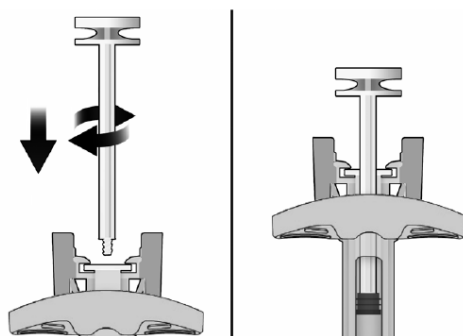

Figure 2 Before

After

- Inspect the safety syringe closely:
 - Do not use the safety syringe after the expiration date shown on the cardboard box or on the syringe label.
 - A small air bubble may be seen, which is normal.
 - The liquid should be clear. Do not use the safety syringe if the liquid contains particles or is cloudy.
- Choose the injection site. Injections should be rotated between sites in the buttock, thigh, abdomen, or upper arm (see Figure 3) with a minimum of 8 weeks before re-injecting a previously used injection site. Injections on the waistline or within 5 cm of the navel should be avoided.

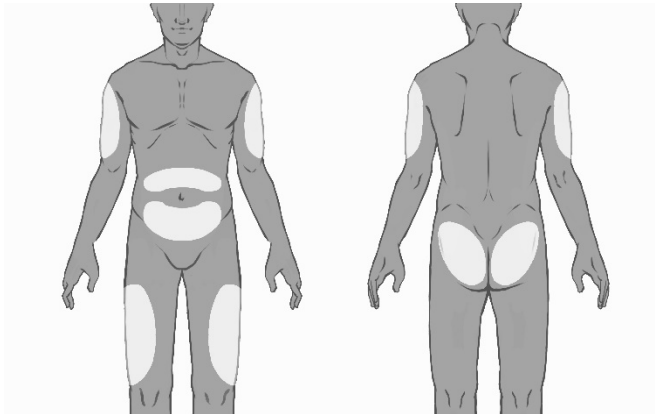

Figure 3

- Put on gloves and clean the injection site with a circular motion using an alcohol wipe (not provided in the pack). Do not touch the cleaned area again before injecting.
- While holding the safety syringe by the syringe guard body as shown (see Figure 4), carefully pull the needle shield straight off. Immediately dispose of the needle shield (never try to recap the needle). A drop of liquid may be seen at the end of the needle. This is normal.

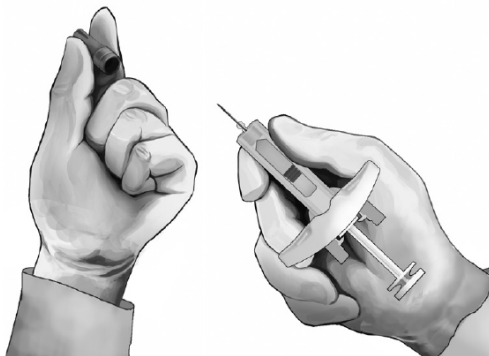

Figure 4

- Pinch the skin at the injection site between the thumb and finger as shown (see Figure 5).
- Hold the safety syringe as shown and insert the needle at an angle of approximately 90° (see Figure 5). Push the needle all the way in.

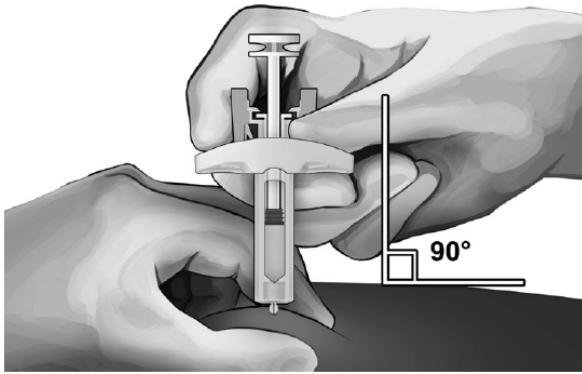

Figure 5

- While holding the syringe as shown (see Figure 6), slowly depress the plunger until the plunger head latches between the syringe guard wings and all the solution is injected.

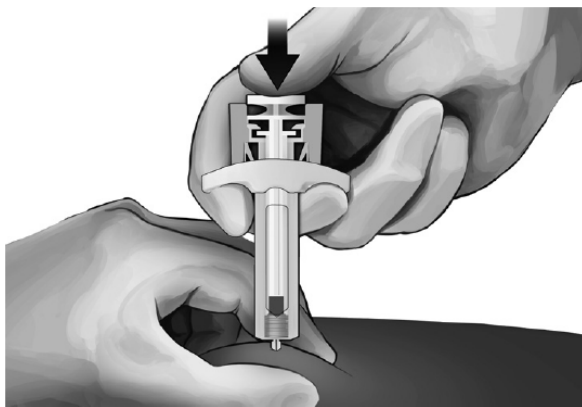

Figure 6

- Gently pull the needle out of the skin. It is recommended that the plunger is kept fully depressed while the needle is carefully lifted straight out from the injection site (see Figure 7).

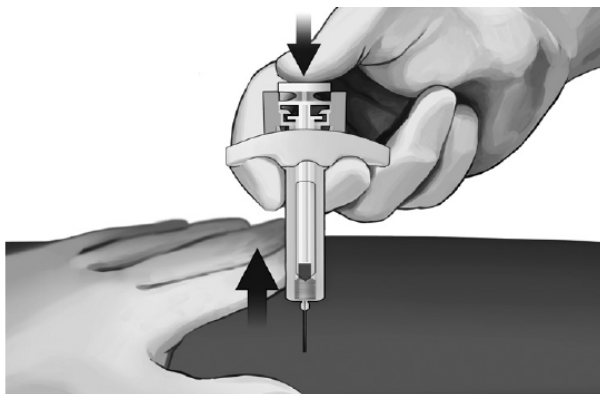

Figure 7

- As soon as the needle has been completely removed from the skin, slowly take the thumb off the plunger and allow the syringe guard to automatically cover the exposed needle (see Figure 8). There may be a small amount of blood at the injection site, if required wipe with a cotton ball or gauze.



Figure 8

4. Disposing of the syringe

Any unused medicinal product or waste material should be disposed of in accordance with local requirements.