

## Integrating Infratech Heaters with Lutron Residential Systems

---

### Overview

Lutron residential systems are capable of controlling 0–10 V<sub>AC</sub> devices and lighting loads via LMJ-5T-DV-B, LQSE-4T5-120-D, GRX-TVM2, or GRX-TVI-CPN3876. This document describes how to utilize LMJ-5T-DV-B, LQSE-4T5-120-D, GRX-TVM2, or GRX-TVI-CPN3876 to control Infratech heaters.

### Table of Contents

<b>1.0 Controlling Infratech Heaters Using 0–10 V<sub>AC</sub></b>	<b>2</b>
<b>2.0 LMJ-5T-DV-B Controlling Infratech Heaters in HomeWorks/RadioRA 2 Systems</b>	<b>2</b>
2.1 Installation	2
2.2 Database Design	4
2.2.1 HomeWorks Load Schedule	4
2.2.2 Adding an LMJ-5T-DV-B to a HomeWorks System	6
2.2.3 Assigning Infratech Heaters to an LMJ-5T-DV-B in a HomeWorks System	7
2.2.4 Adding an LMJ-5T-DV-B to a RadioRA 2 System	8
<b>3.0 LQSE-4T5-120-D Controlling Infratech Heaters in a HomeWorks System</b>	<b>10</b>
3.1 Installation	10
3.2 Database Design	11
3.2.1 Load Schedule	11
3.2.2 Adding Equipment	13
3.2.3 Assigning the Infratech Heaters to the Panel	15
<b>4.0 GRX-TVM2 Controlling Infratech Heaters in a HomeWorks System</b>	<b>16</b>
4.1 Installation	16
4.2 Database Design	17
4.2.1 Load Schedule	17
4.2.2 Adding Equipment	19
4.2.3 Assigning the Infratech Heaters to the Panel	21
<b>5.0 GRX-TVI-CPN3876 Controlling Infratech Heaters in HomeWorks, RadioRA 2, or Caséta Wireless Systems</b>	<b>22</b>
5.1 Installation	22
5.2 HomeWorks Database Design	23
5.2.1 HomeWorks Load Schedule	23
5.2.2 Adding Controls	25
5.2.3 Assigning Infratech Heaters to the Neutral Wire Dimmer	26
5.3 Adding a Neutral Wire Dimmer to a RadioRA 2 System for Control of an Infratech Heater via GRX-TVI-CPN3876	27
<b>6.0 Setting Trim Levels on Neutral Wire Dimmers</b>	<b>30</b>
6.1 Setting Trim Levels via HomeWorks Software	30
6.2 Setting Trim Levels via RadioRA 2 Software	31
6.3 Setting Trim Levels on a Caséta Wireless Dimmer (PD-10NXD)	32
6.3.1 Setting Low-End Trim	32
6.3.2 Setting High-End Trim	33
6.4 Setting Trim Levels When Using GRX-TVI-CPN3876	34

## 1.0 Controlling Infratech Heaters Using 0–10 V<sub>DC</sub>

Infratech heaters require a control device to source a 0–10 V<sub>DC</sub> signal. For more information on the ANSI standard for sourcing 0–10 V<sub>DC</sub> controls, refer to Application Note #587 (048587) at [www.lutron.com](http://www.lutron.com). In order to turn off an Infratech heater, the Lutron control will need to interrupt the 0–10 V<sub>DC</sub> signal using an EPC-1-D manufactured by LVS Controls (not sold by Lutron). An EPC-1-D is required because the relays used to turn on/off 0–10 V<sub>DC</sub> lighting are not rated to control Infratech heaters.

## 2.0 LMJ-5T-DV-B Controlling Infratech Heaters in HomeWorks/RadioRA 2 Systems

### 2.1 Installation

Items needed for this installation:

Item	Company	Function
LMJ-5T-DV-B	Lutron	Controls the 0–10 V <sub>DC</sub> load
EPC-1-D	LVS Controls	Interrupts the 0–10 V <sub>DC</sub> signal
Infratech relay module	Infratech	Interrupts line voltage to heaters
HomeWorks processor or RadioRA 2 main repeater	Lutron	Stores the database
HomeWorks hybrid repeater (if using a HomeWorks processor)	Lutron	Creates Clear Connect wireless signal

The diagram below demonstrates how an LMJ-5T-DV-B needs to be wired to the Infratech system.

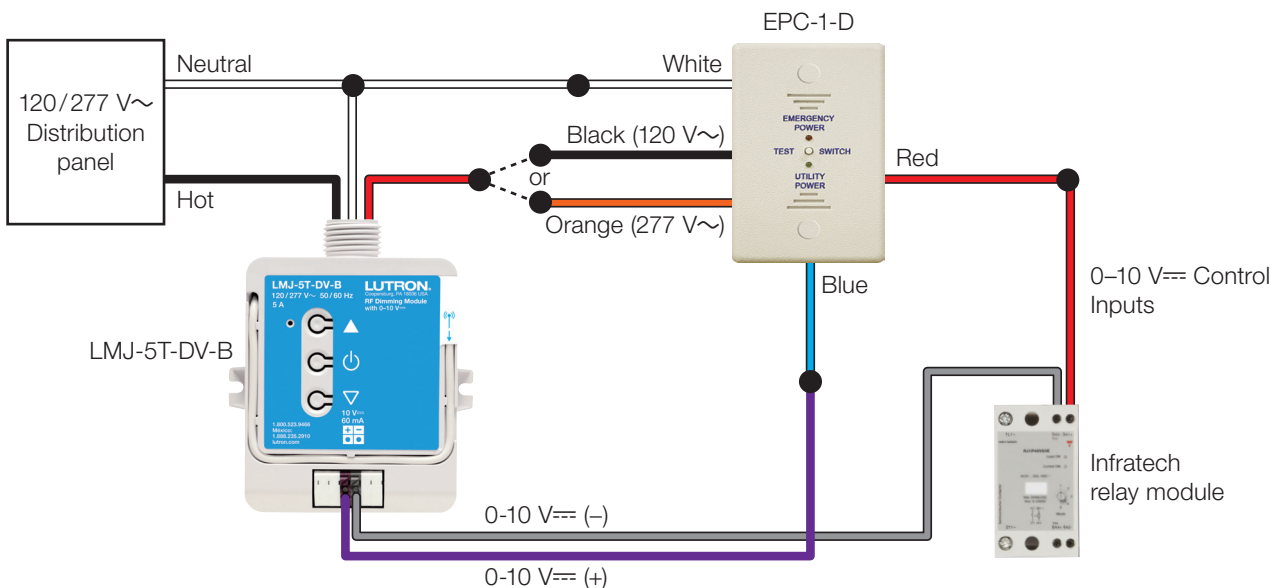

- The neutral wires of the LMJ-5T-DV-B and the EPC-1-D must originate in the same distribution panel. This neutral may only return loads supplied by the same circuit breaker as the LMJ-5T-DV-B and EPC-1-D (Split/Single Phase and Three Phase systems: This neutral may not be shared with other circuit breakers).
- Do not connect both the black and orange wires of the EPC-1-D to the red wire of the LMJ-5T-DV-B. Cap off the unused wire. This controls the switching portion of the Infratech system and controls the on/off function.

Continued on next page...

## 2.0 LMJ-5T-DV-B Controlling Infratech Heaters in HomeWorks/RadioRA 2 Systems (continued)

### 2.1 Installation (continued)

**Important Note:** LMJ-5T-DV-B is a wireless device and must be located within 30 ft (9 m) of a repeater. In a HomeWorks system, an RF link with a hybrid repeater is required.

#### Wired and RF Configuration (RadioRA 2 and HomeWorks)

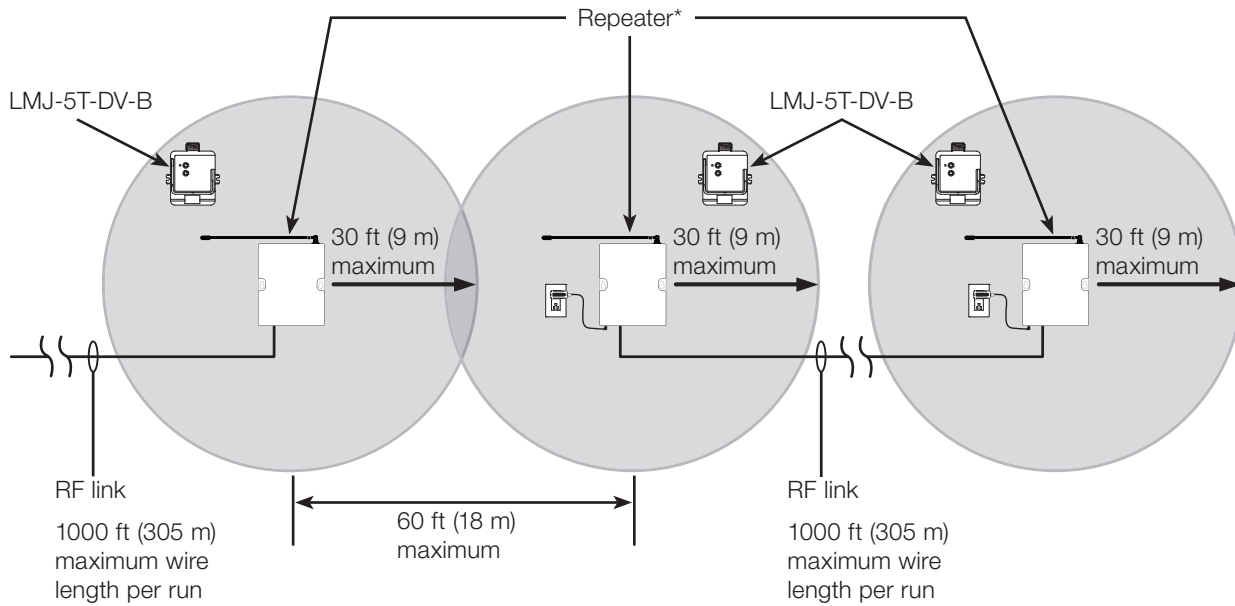

\* In HomeWorks systems, hybrid repeaters can be used to extend the wireless range. In RadioRA 2 systems, the repeater used can either be a main repeater (1 required) or auxiliary repeater (up to 4 permitted).

Continued on next page...

## 2.0 LMJ-5T-DV-B Controlling Infratech Heaters in HomeWorks/RadioRA 2 Systems (continued)

### 2.2 Database Design

#### 2.2.1 HomeWorks Load Schedule

**Important Note:** HomeWorks Designer version 7.0 or higher is required to use LMJ-5T-DV-B.

To begin building the load schedule, go to the **design** tab menu and select **loads**.

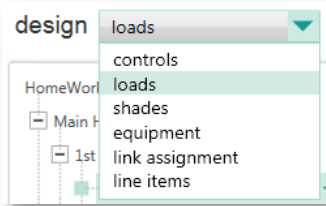

Select an area that will contain the Infratech heaters by clicking on that area name in the tree to the left. The selected area will be highlighted green.

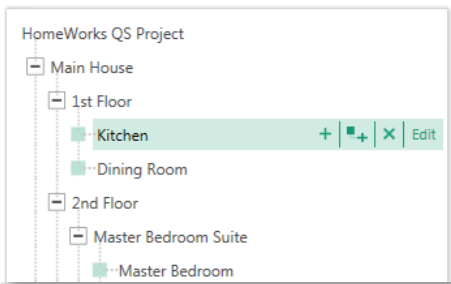

In the upper-right corner of the software window, click **Edit Fixtures**.

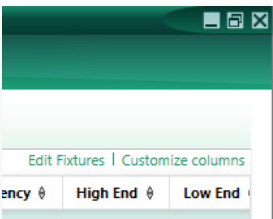

Continued on next page...

## 2.0 LMJ-5T-DV-B Controlling Infratech Heaters in HomeWorks/RadioRA 2 Systems (continued)

### 2.2 Database Design (continued)

#### 2.2.1 HomeWorks Load Schedule (continued)

The **System Fixtures** configuration window will appear which allows you to create fixture placeholders for easy placement into the load schedule. On the **Custom** tab, create a fixture placeholder for the 0–10 V== devices/loads that will be controlled by an LMJ-5T-DV-B. There are two options for 0–10 V== loads: **LED** or **Fluorescent**. Selecting either **LED** or **Fluorescent** will still control the Infratech heaters even though a lighting load is selected. Choosing either **LED** or **Fluorescent** changes the trim level that can be set to 1 on the low-end and 99 on the high-end. You may need to show **High End** and **Low End** by customizing the columns.

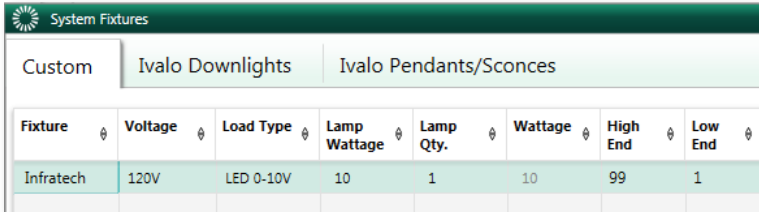

Fixture	Voltage	Load Type	Lamp Wattage	Lamp Qty.	Wattage	High End	Low End
Infratech	120V	LED 0-10V	10	1	10	99	1

Click **Done** to close the **System Fixtures** window and return to the load schedule for the selected area. Double-click in the **Fixture** field to reveal a drop-down menu with all currently created custom or Ivalo fixture options within the project. Select **Infratech** and the software will add a load schedule line item in the selected area for the Infratech heaters in that space.

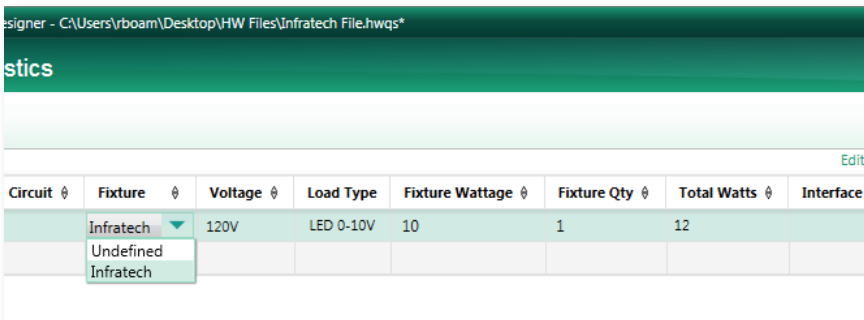

Circuit	Fixture	Voltage	Load Type	Fixture Wattage	Fixture Qty	Total Watts	Interface
	Infratech	120V	LED 0-10V	10	1	12	
	Undefined						
	Infratech						

Provide a zone name, zone description, and any other pertinent information. Repeat this process for each Infratech heater that is to be controlled by an LMJ-5T-DV-B.

Continued on next page...

## 2.0 LMJ-5T-DV-B Controlling Infratech Heaters in HomeWorks/RadioRA 2 Systems (continued)

### 2.2 Database Design (continued)

#### 2.2.2 Adding an LMJ-5T-DV-B to a HomeWorks System

Add the LMJ-5T-DV-B that the Infratech heaters will be assigned to. To add the LMJ-5T-DV-B to the database, go to the **design** tab drop down menu and select **controls**.

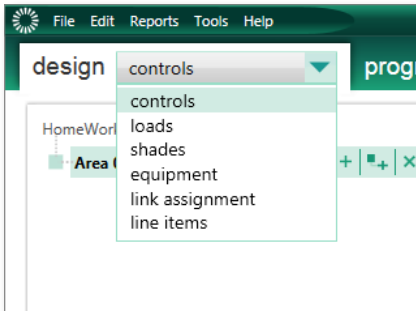

Select the area in which the LMJ-5T-DV-B is to be physically located using the area tree on the left side of the screen.

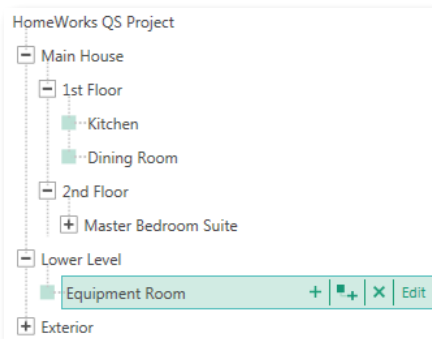

Use the **Controls** toolbox to add an LMJ-5T-DV-B to the area. If the LMJ-5T-DV-B is not currently available in the toolbox, click **Edit Toolbox** and add the LMJ-5T-DV-B to the toolbox.

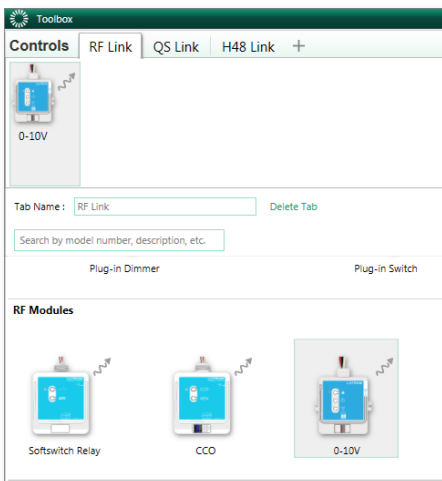

Continued on next page...

## 2.0 LMJ-5T-DV-B Controlling Infratech Heaters in HomeWorks/RadioRA 2 Systems (continued)

### 2.2 Database Design (continued)

#### 2.2.3 Assigning Infratech Heaters to an LMJ-5T-DV-B in a HomeWorks System

Go to the **design** tab drop down menu and select **controls**. To the right of the LMJ-5T-DV-B image, there will be assign links which will show the **Assign** window when clicked. Click on the **Assign** link for an LMJ-5T-DV-B controlling an Infratech heater.

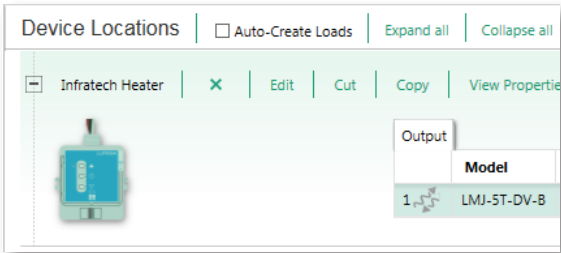

Find the appropriate Infratech heater to assign to the LMJ-5T-DV-B and click **Assign** for that zone.

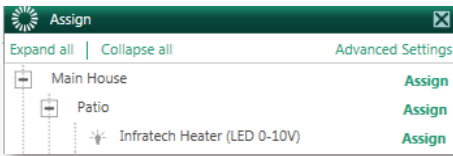

The zone will now be assigned to the selected output on the LMJ-5T-DV-B.

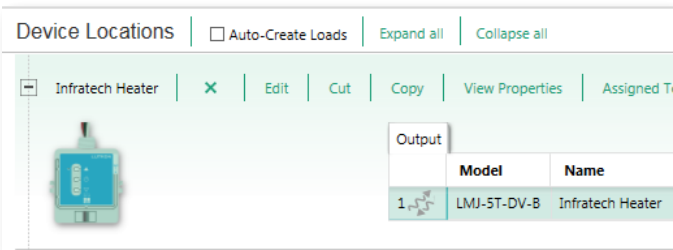

**Important Note:** If using the Lutron Connect app, the Infratech heater will appear as a lighting zone.

Continued on next page...

## 2.0 LMJ-5T-DV-B controlling Infratech Heaters in HomeWorks / RadioRA 2 Systems (continued)

### 2.2 Database Design (continued)

#### 2.2.4 Adding an LMJ-5T-DV-B to a RadioRA 2 System

**Important Note:** RadioRA 2 Inclusive version 7.5 or higher is required to use LMJ-5T-DV-B.

Select the room where the LMJ-5T-DV-B is located. To the right of the selected room, click the “+” above **Click here to add device location**.

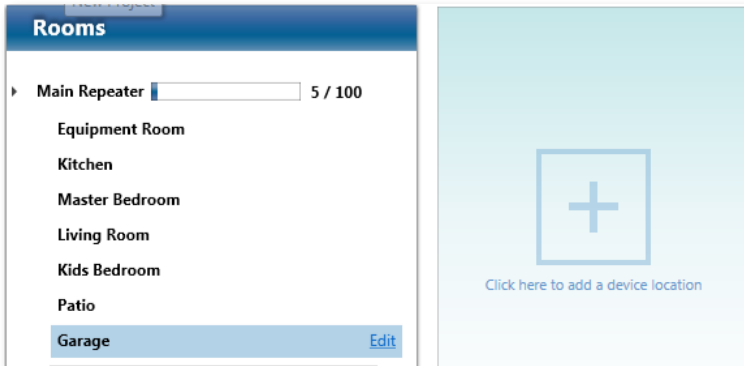

To add the LMJ-5T-DV-B that will control the Infratech heater to the database, click on the picture of the LMJ-5T-DV-B under **Available Devices > Dimmers & Switches**.



Continued on next page...



## 2.0 LMJ-5T-DV-B Controlling Infratech Heaters in HomeWorks/RadioRA 2 Systems (continued)

### 2.2 Database Design (continued)

#### 2.2.4 Adding an LMJ-5T-DV-B to a RadioRA 2 System (continued)

Once the LMJ-5T-DV-B is added, select **0-10V Dimmer** from the **Device Type** drop down menu.

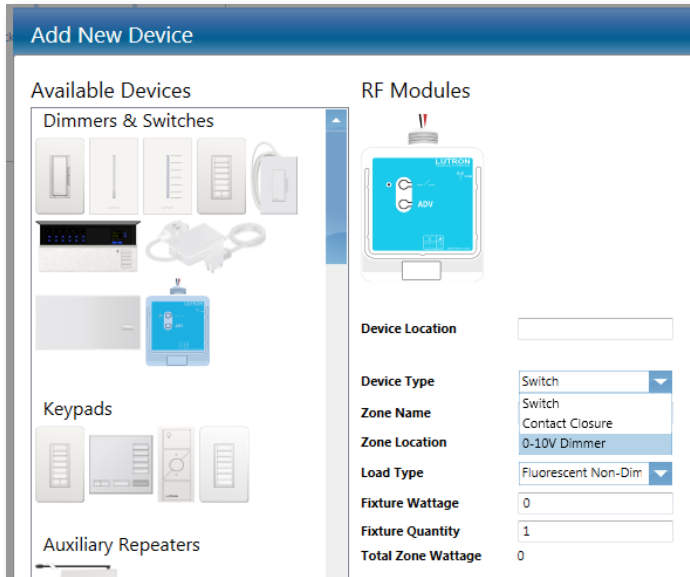

On the left side of the screen the model number will change to LMJ-5T-DV-B. Add the **Device Location**, **Zone Name**, and **Load Type** and click **Done**. This will add the Infratech heater to the area specified.

There are two options for 0–10 V<sub>AC</sub> loads: **LED** or **Fluorescent**. Selecting either **LED** or **Fluorescent** will still control the Infratech heaters even though a lighting load is selected. Choosing either **LED** or **Fluorescent** changes the trim level that can be set to 1 on the low-end and 99 on the high-end.

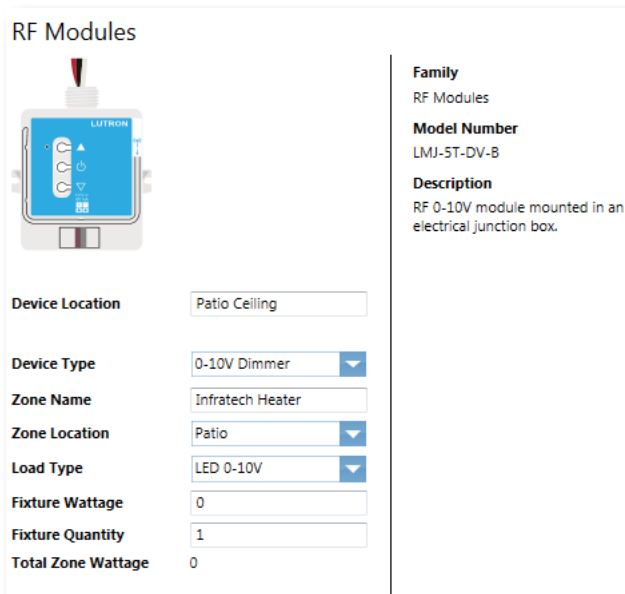

**Important Note:** If using the Lutron Connect app, the Infratech heater will appear as a lighting zone.

### 3.0 LQSE-4T5-120-D Controlling Infratech Heaters in a HomeWorks System

#### 3.1 Installation

Items needed for this installation:

Item	Company	Function
EPC-1-D	LVS Controls	Interrupts the 0–10 V <sub>DC</sub> signal
Infratech relay module	Infratech	Interrupts line voltage to heaters
LQSE-4T5-120-D	Lutron	Controls the 120 V <sub>AC</sub> switching and provides the 0–10 V <sub>DC</sub> to control load (Infratech heater).
HomeWorks System	Lutron	Stores the database

The diagram below demonstrates how a LQSE-4T5-120-D needs to be wired to the Infratech system.

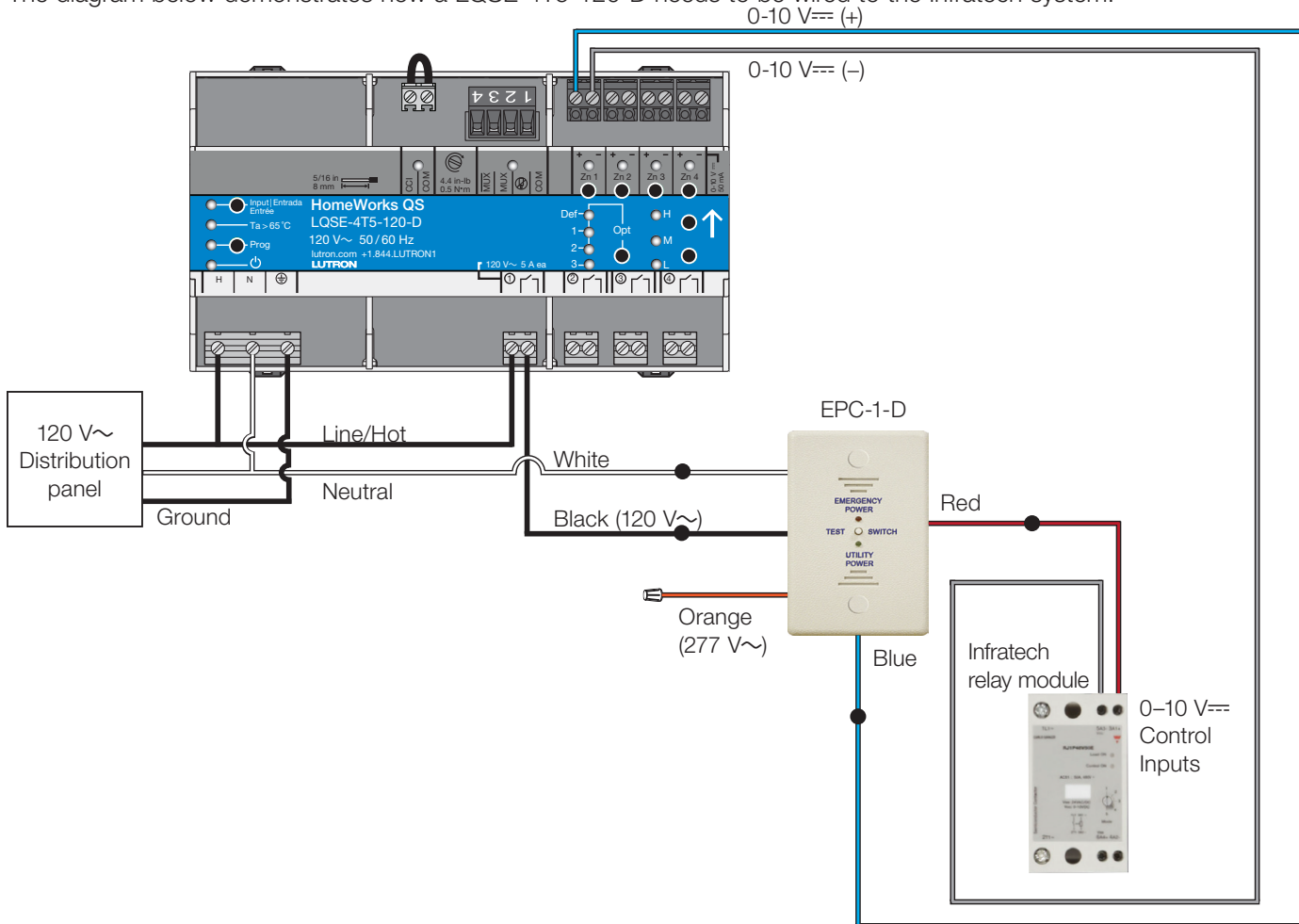

- The neutral wires of the LQSE-4T5-120-D and the EPC-1-D must originate in the same distribution panel. This neutral may only return loads supplied by the same circuit breaker as the LQSE-4T5-120-D and EPC-1-D (Split/Single Phase and Three Phase systems: This neutral may not be shared with other circuit breakers).
- Connect the black wire of the EPC-1-D to the output of the LQSE-4T5-120-D. Cap off the orange wire. This controls the switching portion of the Infratech system and controls the on/off function.
- Power switching and 0-10 V<sub>DC</sub> must be on the same zone (zone 1 shown).
- One LQSE-4T5-120-D can control up to 4 zones of Infratech heaters using separate EPC-1-D relays and Infratech relay modules.

Continued on next page...

## 3.0 LQSE-4T5-120-D Controlling Infratech Heaters in a HomeWorks System (continued)

### 3.2 Database Design

#### 3.2.1 Load Schedule

To begin building the load schedule, go to the **design** tab menu and select **loads**.

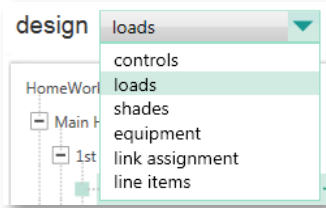

Select an area that will contain the Infratech heaters by clicking on that area name in the tree to the left. The selected area will be highlighted green.

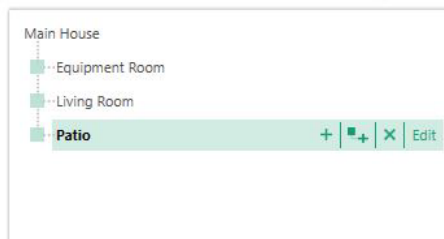

In the upper-right corner of the software window, click **Edit Fixtures**.

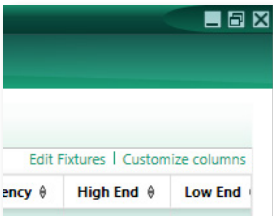

Continued on next page...

## 3.0 LQSE-4T5-120-D Controlling Infratech Heaters in a HomeWorks System (continued)

### 3.2 Database Design (continued)

#### 3.2.1 Load Schedule (continued)

The **System Fixtures** configuration window will appear which allows you to create fixture placeholders for easy placement into the load schedule. On the **Custom** tab, create a fixture placeholder for the 0-10 V== devices/loads that will be controlled by a LQSE-4T5-120-D. There are two options for 0-10 V== loads: **LED** or **Fluorescent**. Selecting either **LED** or **Fluorescent** will still control the Infratech heaters even though a lighting load is selected. Choosing either **LED** or **Fluorescent** changes the trim level that can be set to 1 on the low-end and 99 on the high-end.

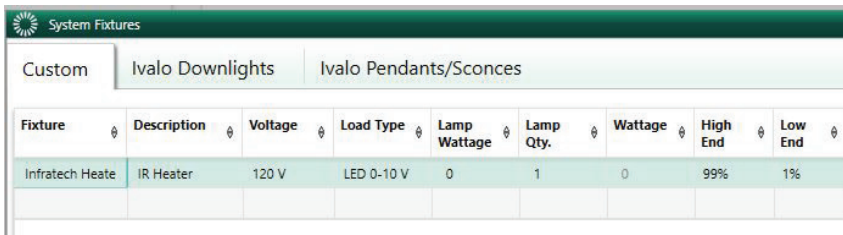

Fixture	Description	Voltage	Load Type	Lamp Wattage	Lamp Qty.	Wattage	High End	Low End
Infratech Heater	IR Heater	120 V	LED 0-10 V	0	1	0	99%	1%

Click **Done** to close the **System Fixtures** window and return to the load schedule for the selected area. Double-click in the **Fixture** field to reveal a drop-down menu with all currently created custom or Ivalo fixture options within the project. Select **Infratech Heater** and the software will add a load schedule line item in the selected area for the Infratech heaters in that space.

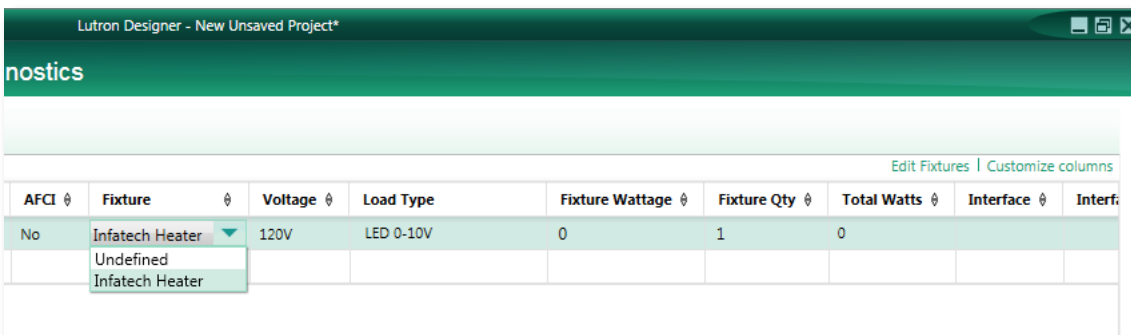

AFCI	Fixture	Voltage	Load Type	Fixture Wattage	Fixture Qty	Total Watts	Interface	Interf.
No	Infratech Heater	120V	LED 0-10V	0	1	0		

Provide a zone name, zone description, and any other pertinent information. Repeat this process for each Infratech heater that is to be controlled by a LQSE-4T5-120-D zone.

Continued on next page...

## 3.0 LQSE-4T5-120-D Controlling Infratech Heaters in a HomeWorks System (continued)

### 3.2 Database Design (continued)

#### 3.2.2 Adding Equipment

Next, add the equipment that the Infratech heaters will be assigned to. In this case, the equipment being added would be the DIN rail panel. To add the panel to the database, go to the **design** tab menu and select **equipment**.

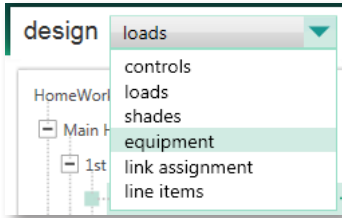

Select the area in which the dimming panel is to be physically located using the area tree on the left side of the screen.



Use the **Equipment** toolbox to add a DIN rail device compatible dimming panel to the area. In this case, a PD9-59F-120 has been selected. If the dimming panel is not currently available in the toolbox, click **Edit Toolbox** and add the dimming panel to the toolbox.

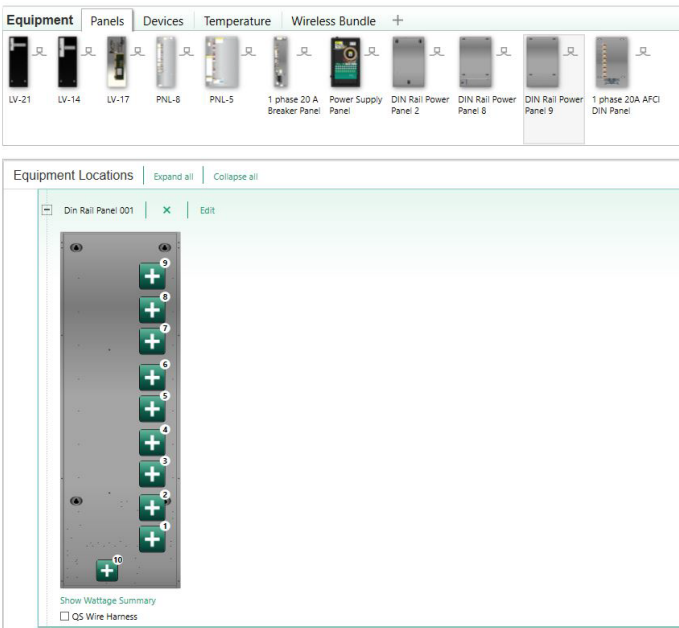

Continued on next page...

### 3.0 LQSE-4T5-120-D Controlling Infratech Heaters in a HomeWorks System (continued)

#### 3.2 Database Design (continued)

##### 3.2.2 Adding Equipment (continued)

Configure the DIN rail panel in the software to match the needs of the application. In the example below, for the QS communication link, a QS-WLB has been added to position 10. For the Infratech heater, one LQSE-4T5-120-D has been added to position 1.

The screenshot shows the software interface for configuring a DIN rail panel. At the top, there is a menu bar with 'Equipment', 'Panels', 'Devices', 'Temperature', and 'Wireless Bundle'. Below this is a toolbar with various equipment icons: Connect Bridge, Hybrid Repeater, Visor Control Receiver, Digital IO, DMX, GSM, DIN Rail Power Module Eco, DIN Rail Power Module Adaptive 10A-4 Output, DIN Rail Power Module Switching 8A-4 Output, DIN Rail Power Module 0-10 V, and DIN Rail Power Module Motor.

The main area is titled 'Equipment Locations' and shows a 'Din Rail Panel 001' configuration. On the left is a visual representation of the DIN rail panel with 10 positions. On the right is a table with the following columns: Output, Type, Area, Zone Name, Load #, Feed, Load Type, Wattage, Fixture Quantity, Total, Interface, and Interf. The table contains four rows of data:

Output	Type	Area	Zone Name	Load #	Feed	Load Type	Wattage	Fixture Quantity	Total	Interface	Interf.
1-1	0-10 V Module		Assign...								
1-2	0-10 V Module		Assign...								
1-3	0-10 V Module		Assign...								
1-4	0-10 V Module		Assign...								

At the bottom left, there are options for 'Show Wattage Summary' and 'QS Wire Harness'.

Continued on next page...

### 3.0 LQSE-4T5-120-D Controlling Infratech Heaters in a HomeWorks System (continued)

#### 3.2 Database Design (continued)

##### 3.2.3 Assigning the Infratech Heaters to the Panel

Proceed to the **design > equipment** section of the programming software. To the right of the panel 9 image and parameters, there will be assign links which will show the **Assign** window when clicked. Click on the **Assign** link for one of the zones that will control an Infratech heater via a LQSE-4T5-120-D.

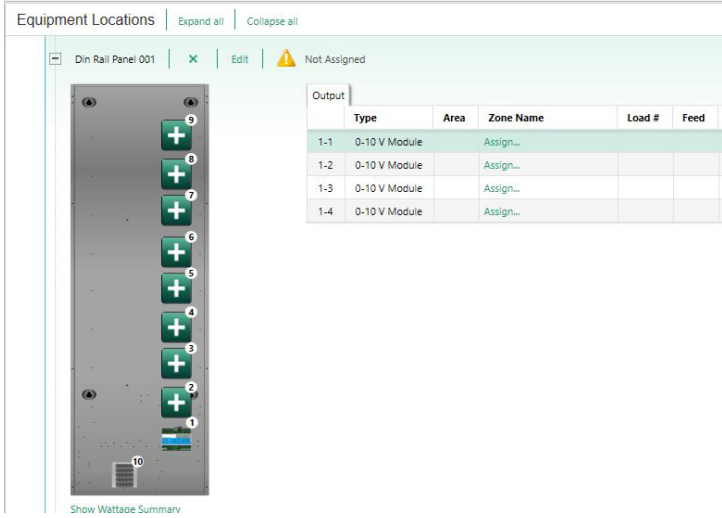

Find the zone to assign within the **Assign** window and click **Assign** for that zone.

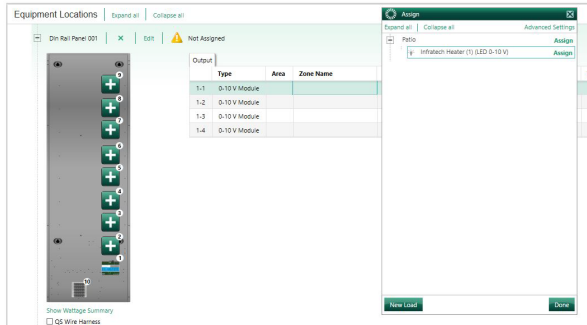

The zone will be assigned to the selected output on the panel. A LQSE-4T5-120-D should appear in the **Interface** field along with the address of the LQSE-4T5-120-D.

Output	Type	Area	Zone Name	Load Type	Fixture Quantity	Interface
1-1	0-10 V Module	Patio	Patio ▶ Infratech Heater	LED 0-10 V	1	None
1-2	0-10 V Module		Assign...			
1-3	0-10 V Module		Assign...			
1-4	0-10 V Module		Assign...			

Find compatible LED lamp types

## 4.0 GRX-TVM2 Controlling Infratech Heaters in a HomeWorks System

### 4.1 Installation

Items needed for this installation:

Item	Company	Function
GRX-TVM2	Lutron	Controls the 0–10 V <sub>DC</sub> load. Fits in the 8 <sup>th</sup> RPM location near the top of the panel.
EPC-1-D	LVS Controls	Interrupts the 0–10 V <sub>DC</sub> signal
Infratech relay module	Infratech	Interrupts line voltage to heaters
HW-RPM-4U-120	Lutron	Controls the 120 V <sub>AC</sub> switching of the Infratech heater
HW-TVMKIT-120	Lutron	Provides power to the GRX-TVM2 through a GRX-TVM-ISO2. Also includes DIN rail mounting hardware and wire harness.

The diagram below demonstrates how an GRX-TVM2 needs to be wired to the Infratech system. An output of a RPM module is needed for switching since the GRX-TVM2 controls only 0-10 V<sub>DC</sub>.

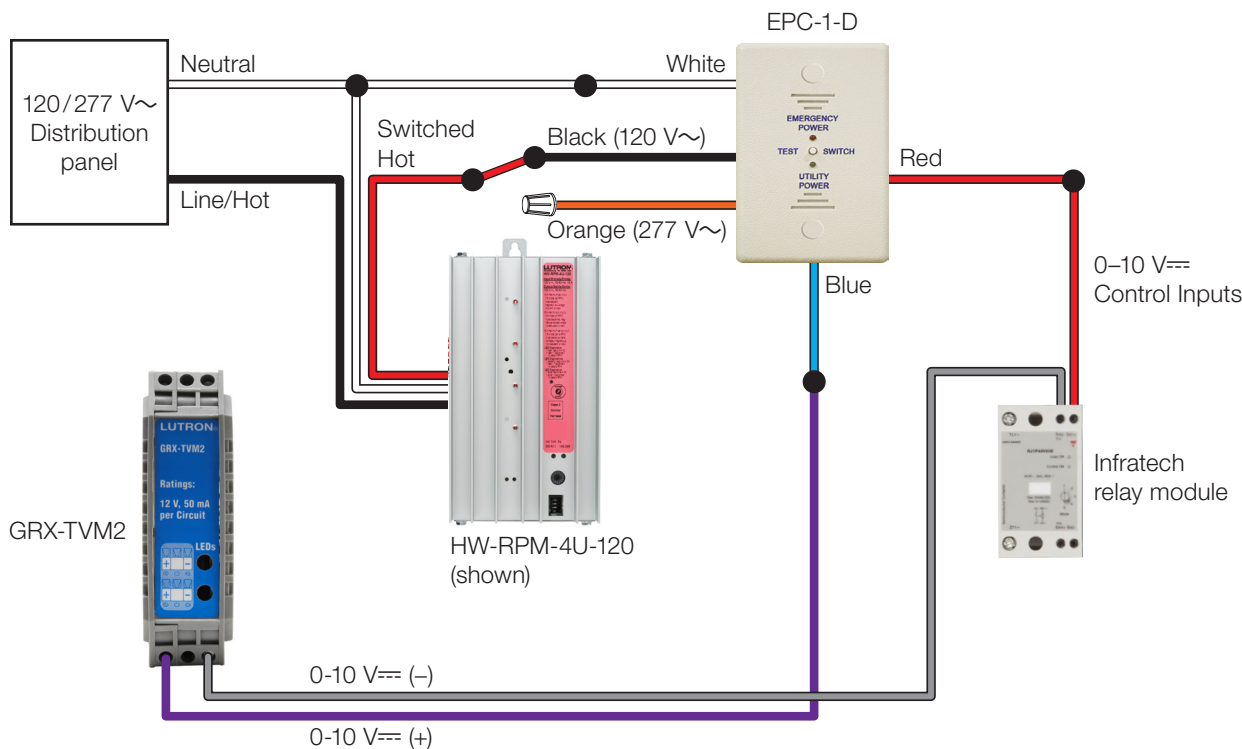

- The neutral wires of the HW-RPM-4U and the EPC-1-D must originate in the same distribution panel. This neutral may only return loads supplied by the same circuit breaker as the HW-RPM-4U or HW-RPM-4A and EPC-1-D (Split/Single Phase and Three Phase systems: This neutral may not be shared with other circuit breakers).
- Connect the black wire of the EPC-1-D to the output of the HW-RPM-4U or HW-RPM-4A. Cap off the orange (277 V<sub>AC</sub>) wire. This controls the switching portion of the Infratech system and controls the on/off function.

Continued on next page...



## 4.0 GRX-TVM2 Controlling Infratech Heaters in a HomeWorks System (continued)

### 4.2 Database Design

#### 4.2.1 Load Schedule

To begin building the load schedule, go to the **design** tab menu and select **loads**.

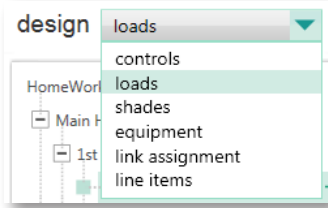

Select an area that will contain the Infratech heaters by clicking on that area name in the tree to the left. The selected area will be highlighted green.

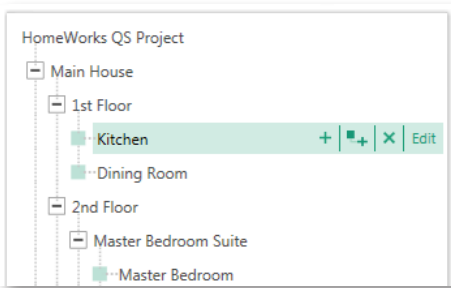

In the upper-right corner of the software window, click **Edit Fixtures**.

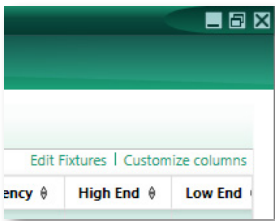

Continued on next page...

## 4.0 GRX-TVM2 Controlling Infratech Heaters in a HomeWorks System (continued)

### 4.2 Database Design (continued)

#### 4.2.1 Load Schedule (continued)

The **System Fixtures** configuration window will appear which allows you to create fixture placeholders for easy placement into the load schedule. On the **Custom** tab, create a fixture placeholder for the 0-10 V<sub>ac</sub> devices/loads that will be controlled by a GRX-TVM2. There are two options for 0-10 V<sub>ac</sub> loads: **LED** or **Fluorescent**. Selecting either **LED** or **Fluorescent** will still control the Infratech heaters even though a lighting load is selected. Choosing either **LED** or **Fluorescent** changes the trim level that can be set to 1 on the low-end and 99 on the high-end.

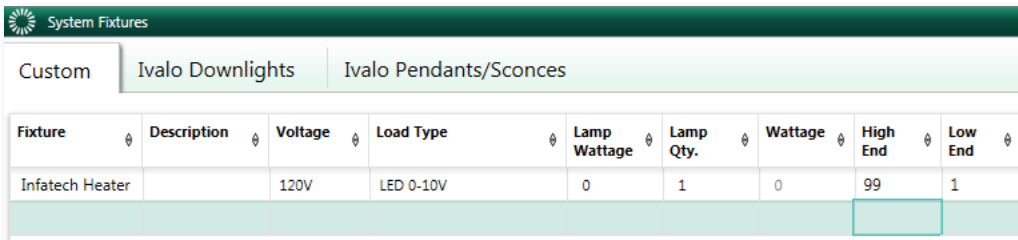

Fixture	Description	Voltage	Load Type	Lamp Wattage	Lamp Qty.	Wattage	High End	Low End
Infatech Heater		120V	LED 0-10V	0	1	0	99	1

Click **Done** to close the **System Fixtures** window and return to the load schedule for the selected area. Double-click in the **Fixture** field to reveal a drop-down menu with all currently created custom or Ivalo fixture options within the project. Select **Infratech Heater** and the software will add a load schedule line item in the selected area for the Infratech heaters in that space.

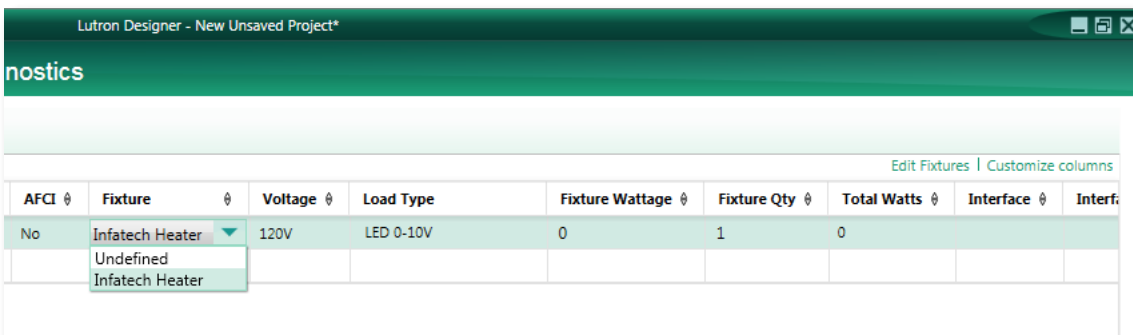

AFI	Fixture	Voltage	Load Type	Fixture Wattage	Fixture Qty	Total Watts	Interface	Interf
No	Infatech Heater	120V	LED 0-10V	0	1	0		
	Undefined							
	Infatech Heater							

Provide a zone name, zone description, and any other pertinent information. Repeat this process for each Infratech heater that is to be controlled by a GRX-TVM2.

Continued on next page...

## 4.0 GRX-TVM2 Controlling Infratech Heaters in a HomeWorks System (continued)

### 4.2 Database Design (continued)

#### 4.2.2 Adding Equipment

Next, add the equipment that the Infratech heaters will be assigned to. In this case, the equipment being added would be the HWI-PNL-8. To add the panel to the database, go to the **design** tab menu and select **equipment**.

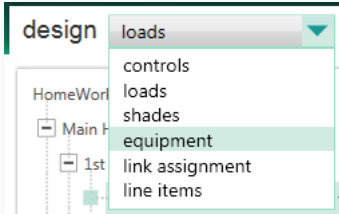

Select the area in which the dimming panel is to be physically located using the area tree on the left side of the screen.

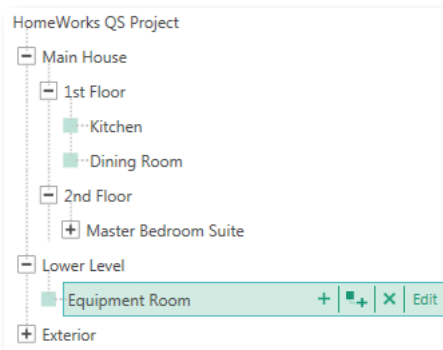

Use the **Equipment** toolbox to add an HWI-PNL-8 dimming panel to the area. If the dimming panel is not currently available in the toolbox, click **Edit Toolbox** and add the dimming panel to the toolbox.

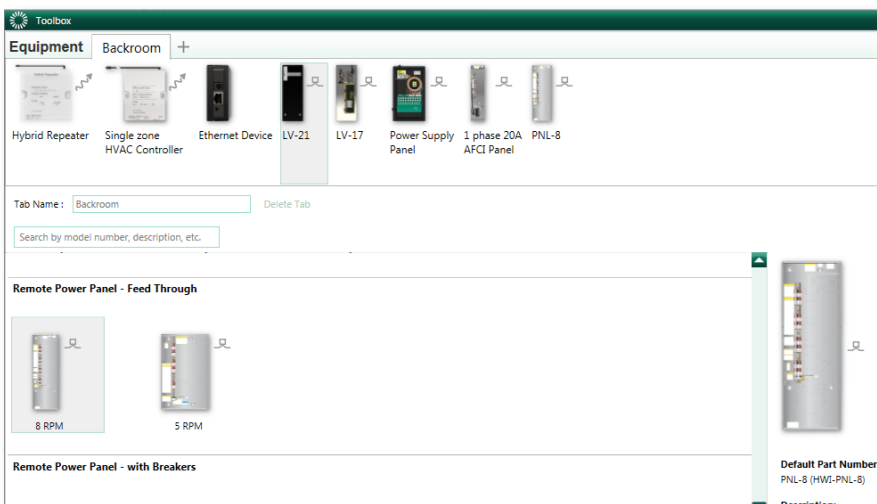

Continued on next page...

## 4.0 GRX-TVM2 Controlling Infratech Heaters in a HomeWorks System (continued)

### 4.2 Database Design (continued)

#### 4.2.2 Adding Equipment (continued)

Configure the HWI-PNL-8 dimming panel in the software to match the needs of the application. A single panel can be configured to have a maximum of 32 zones; however, the GRX-TVM2 takes the eighth spot in the panel (top location) and can control the first 24 loads in the panel.

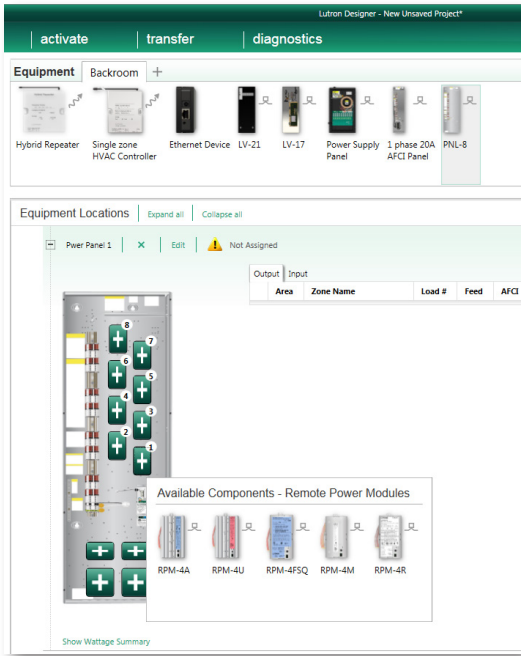

Add the GRX-TVM2 kit to the eighth spot in the panel (top location)

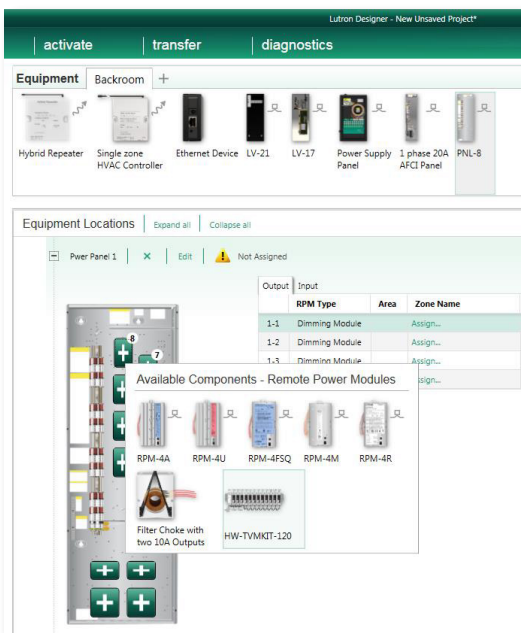

Continued on next page...

## 4.0 GRX-TVM2 Controlling Infratech Heaters in a HomeWorks System (continued)

### 4.2 Database Design (continued)

#### 4.2.3 Assigning the Infratech Heaters to the Panel

Proceed to the **design > equipment** section of the programming software. To the right of the PNL-8 panel image and parameters, there will be assign links which will show the **Assign** window when clicked. Click on the **Assign** link for one of the zones that will control an Infratech heater via a GRX-TVM2.

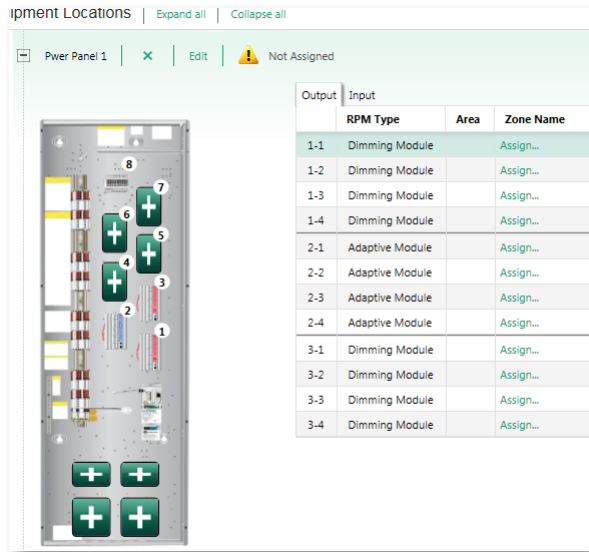

Find the zone to assign within the **Assign** window and click **Assign** for that zone.



The zone will be assigned to the selected output on the panel. A GRX-TVM2 should appear in the **Interface** field along with the address of the GRX-TVM2.

Output	Input
RPM Type	Area Zone Name Load Type Fixture Quantity Interface
1-1	Dimming Module Patio ... ▸ Patio ▸ Infratech Heater LED 0-10V 1 GRX-TVM2 1-1
1-2	Dimming Module Assign...

## 5.0 GRX-TVI-CPN3876 Controlling Infratech Heaters in HomeWorks, RadioRA 2, or Caséta Wireless Systems

### 5.1 Installation

Items needed for this installation:

Item	Company	Function
GRX-TVI-CPN3876	Lutron	0–10 V <sub>DC</sub> source signal
EPC-1-D	LVS Controls	Interrupts the 0–10 V <sub>DC</sub> signal
Infratech relay module	Infratech	Interrupts line voltage to heaters
HomeWorks, RadioRA 2, or Caséta Wireless neutral wire dimmer	Lutron	Control point

The diagram below demonstrates how a GRX-TVI-CPN3876 needs to be wired to the Infratech system and to the neutral wire dimmer.

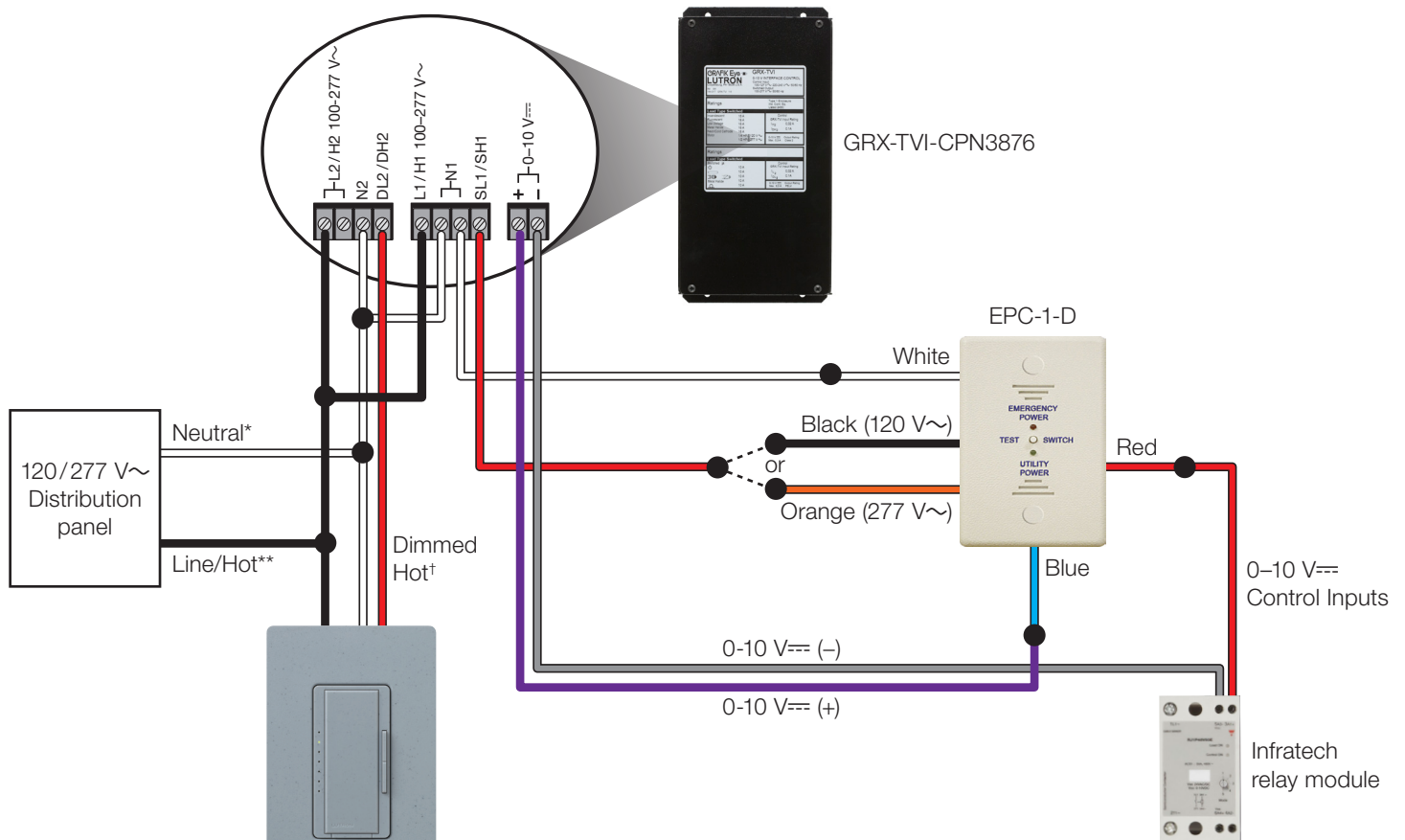

- \* Connect to the silver terminal on the dimmer.
- \*\* Connect to the black terminal on the dimmer.
- † Connect to the brass terminal on the dimmer. If using a fluorescent dimmer, connect to the orange wire on the dimmer.
- ‡ Set the trim of the dimmer accordingly. Refer to section 5.3.3 for trim levels.

- The neutral wires of the neutral wire dimmer, GRX-TVI-CPN3876, and the EPC-1-D must originate in the same distribution panel. This neutral may only return loads supplied by the same circuit breaker as the neutral wire dimmer, GRX-TVI-CPN3876, and EPC-1-D (Split/Single Phase and Three Phase systems: This neutral may not be shared with other circuit breakers).

**Important Note:** In order to utilize this solution, the GRX-TVI-CPN3876 model must be used since the Infratech heaters require the control to source the 0–10 V<sub>DC</sub> signal. The GRX-TVI model acts as a sink and follows the IEC standard of 0–10 V<sub>DC</sub> control which is not compatible with Infratech heaters.

## 5.0 GRX-TVI-CPN3876 Controlling Infratech Heaters in HomeWorks, RadioRA 2, or Caséta Wireless Systems (continued)

### 5.2 HomeWorks Database Design

#### 5.2.1 HomeWorks Load Schedule

To begin building the load schedule, go to the **design** tab menu and select **loads**.

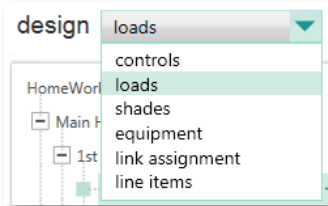

Select an area that will contain the Infratech heaters by clicking on that area name in the tree to the left. The selected area will be highlighted green.

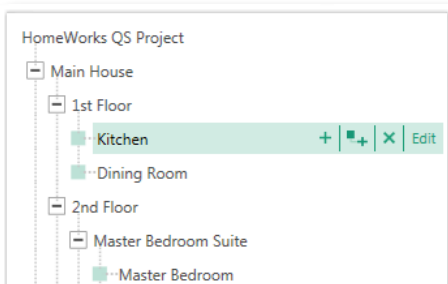

In the upper-right corner of the software window, click **Edit Fixtures**.

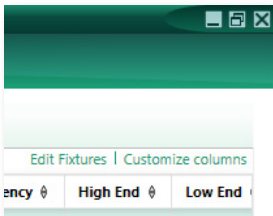

Continued on next page...

## 5.0 GRX-TVI-CPN3876 Controlling Infratech Heaters in HomeWorks, RadioRA 2, or Caséta Wireless Systems (continued)

### 5.2 HomeWorks Database Design (continued)

#### 5.2.1 HomeWorks Load Schedule (continued)

The **System Fixtures** configuration window will appear which allows you to create fixture placeholders for easy placement into the load schedule. On the **Custom** tab, create a fixture placeholder for the Infratech heaters that will be controlled by an GRX-TVI-CPN3876 and driven by the output of the neutral wire dimmer. There are two options for 0-10 V== loads: **LED** or **Fluorescent**. Select either **LED** or **Fluorescent**. The system will still control the Infratech heaters even though a lighting load is selected. Choosing either **LED** or **Fluorescent** changes the trim level that can be set to 1 on the low-end and 99 on the high-end. You may need to show **High End** and **Low End** by customizing the columns. As a best practice, give the fixture a name that will provide a good reminder that the load is tied to the GRX-TVI-CPN3876 controlled by neutral wire dimmer.

**Important Note:** The **Lamp Wattage** must be entered as “10” or greater when using GRX-TVI-CPN3876.

Fixture	Voltage	Load Type	Lamp Wattage	Lamp Qty.	Wattage	High End	Low End
Infratech	120V	LED 0-10V	10	1	10	99	1

Click **Done** to close the **System Fixtures** window and return to the load schedule for the selected area. Double-click in the **Fixture** field to reveal a drop-down menu with all currently created custom or Ivalo fixture options within the project. Select **Infratech Heater** and the software will add a load schedule line item in the selected area for the Infratech heaters in that space.

Zone Name	Zone Description	Load #	Feed Circuit	AFCI	Fixture	Voltage	Load Type
Infratech Heater		1		No	Infratech	120V	LED 0-10V

Provide a zone name, zone description, and any other pertinent information. Repeat this process for each Infratech heater that is to be controlled by a neutral wire dimmer driving a GRX-TVI-CPN3876.

Continued on next page...



## 5.0 GRX-TVI-CPN3876 Controlling Infratech Heaters in HomeWorks, RadioRA 2, or Caséta Wireless Systems (continued)

### 5.2 HomeWorks Database Design (continued)

#### 5.2.2 Adding Controls

Add the equipment that the Infratech heaters will be assigned to. In this case, the equipment being added is the neutral wire dimmer. To add the panel to the database, go to the **design** tab drop down menu and select **controls**.

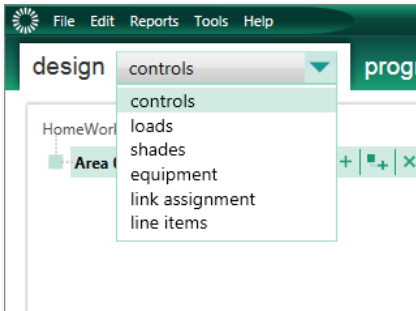

Select the area in which the dimming panel is to be physically located using the area tree on the left side of the screen.

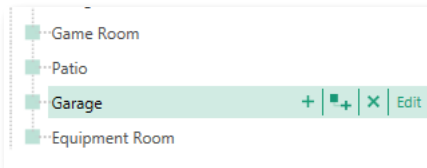

Use the **Controls** toolbox to add a neutral wire dimmer to the area. If the dimming panel is not currently available in the toolbox, click **Edit Toolbox** and add the dimming panel to the toolbox. Also, uncheck **Auto-Create Loads**.

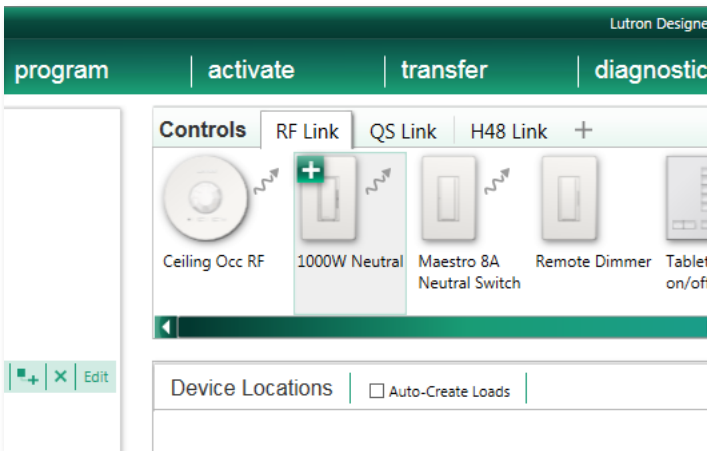

Continued on next page...

## 5.0 GRX-TVI-CPN3876 Controlling Infratech Heaters in HomeWorks, RadioRA 2, or Caséta Wireless Systems (continued)

### 5.2 HomeWorks Database Design (continued)

#### 5.2.3 Assigning Infratech Heaters to the Neutral Wire Dimmer

Remain in the **design > controls** section of the programming software. To the right of the dimmer image and parameters, there will be assign links which will show the **Assign** window when clicked. Click on the **Assign** link for one of the zones that will control an Infratech heater via a GRX-TVI-CPN3876.

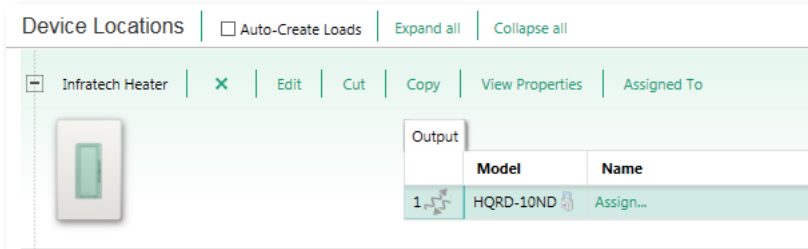

Find the zone to assign within the **Assign** window and click on **Assign** for that zone



The zone will be assigned to the output of the dimmer. A GRX-TVI-CPN3876 should appear in the **Interface** field.

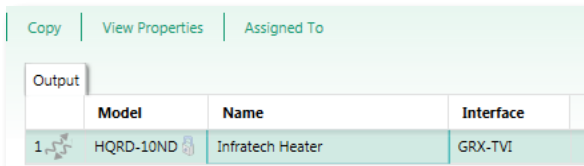

Continued on next page...

## 5.0 GRX-TVI-CPN3876 Controlling Infratech Heaters in HomeWorks, RadioRA 2, or Caséta Wireless Systems (continued)

### 5.3 Adding a Neutral Wire Dimmer to a RadioRA 2 System for Control of an Infratech Heater via GRX-TVI-CPN3876

Select the room where the Infratech heaters are located. To the right of the selected room, click the “+” above **Click here to add device location**.

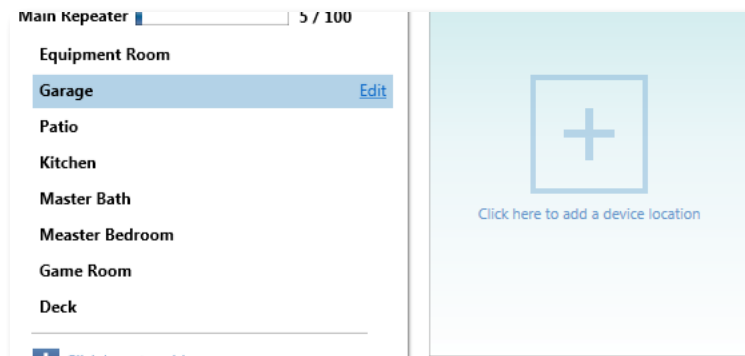

Under the **Available Devices** section, select the dimmer style and then select **0-10V Dimming With Interface** in the **Device Type** drop down menu. By default, this will add an RRD-10ND with a GRX-TVI.

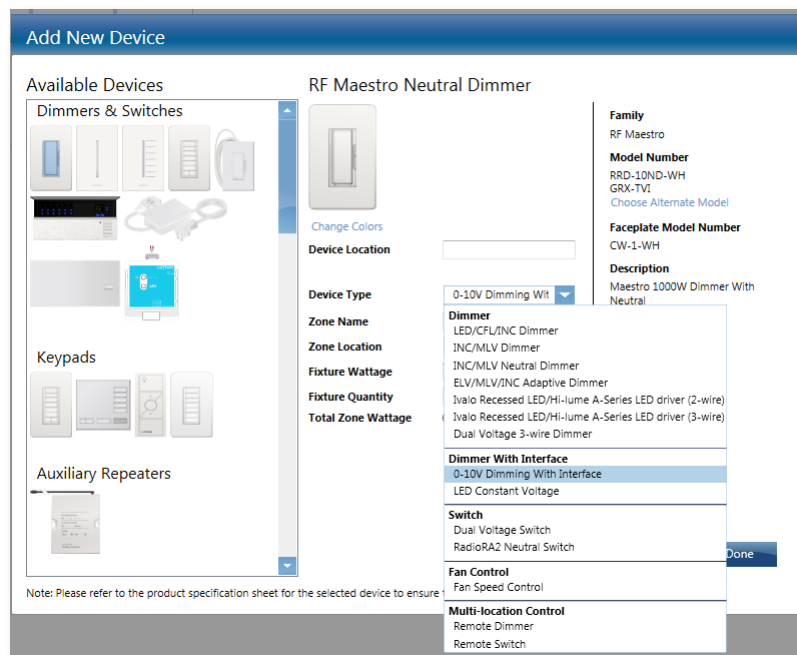

Continued on next page...

## 5.0 GRX-TVI-CPN3876 Controlling Infratech Heaters in HomeWorks, RadioRA 2, or Caséta Wireless Systems (continued)

### 5.3 Adding a Neutral Wire Dimmer to a RadioRA 2 System for Control of an Infratech Heater via GRX-TVI-CPN3876 (continued)

If an RRD-10ND is not the model to be used, click **Choose Alternate Model** under the **Model Number** section on the right side of the **Add New Device** screen.

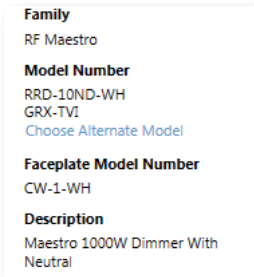

From the drop down list of neutral wire dimmers, select the appropriate dimmer for the application.

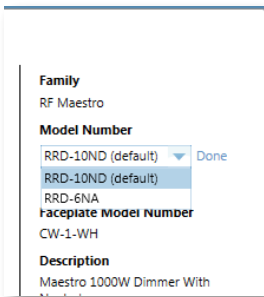

If using a GRAFIK T dimmer, select the GRAFIK T dimmer image under **Available Devices** and select either **C.L Dimmer** or **Phase Selectable Dimmer** in the **Device Type** field.

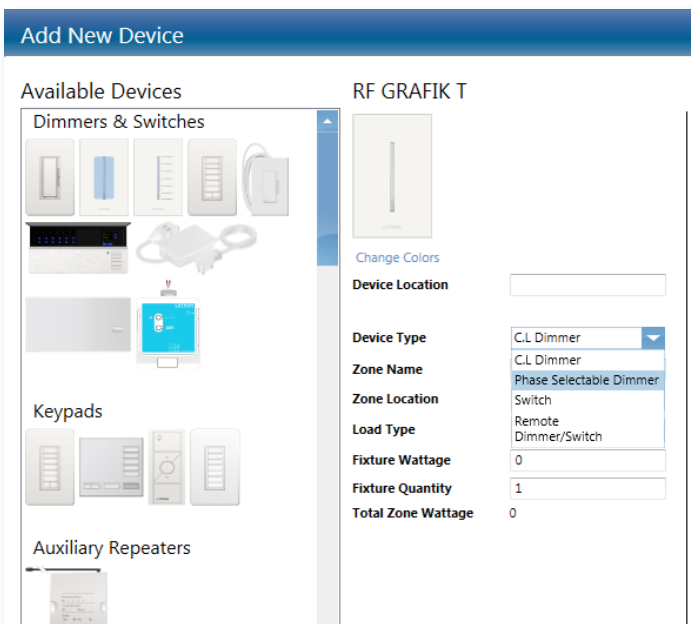

Continued on next page...

## 5.0 GRX-TVI-CPN3876 Controlling Infratech Heaters in HomeWorks, RadioRA 2, or Caséta Wireless Systems (continued)

### 5.3 Adding a Neutral Wire Dimmer to a RadioRA 2 System for Control of an Infratech Heater via GRX-TVI-CPN3876 (continued)

In the **Load Type** drop down menu, select any 0–10 V<sub>AC</sub> load. This will auto populate the GRX-TVI under the **Model Number** section.

If using a GRAFIK T keypad, select the GRAFIK T keypad image under **Available Devices** and select either **C.L Dimmer** or **Phase Selectable Dimmer** in the **Device Type** field.

RF GRAFIK T

Change Colors

Device Location

Device Type **C.L Dimmer**

Zone Name

Zone Location **Garage**

Load Type **LED 0-10V**

Fixture Wattage

Fixture Quantity

Total Zone Wattage 0

Family  
RF GRAFIK T

Model Number  
RRT-G25LW  
GRX-TVI

Faceplate Model Number  
LWT-G-WH

Description  
RF GRAFIK T 250W LED / 600W  
INC Dimmer With Optional  
Neutral

Cancel Done

he selected device to ensure that it meets local regulatory requirements.

Once added, there will be a “\*” next to the load name

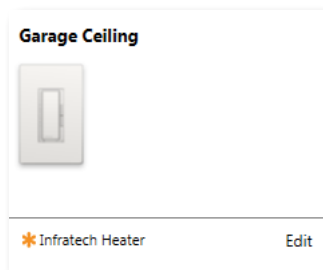

## 6.0 Setting Trim Levels on Neutral Wire Dimmers

### 6.1 Setting Trim Levels via HomeWorks Software

To begin setting the trim levels, go to the **design** tab menu and select **loads**.

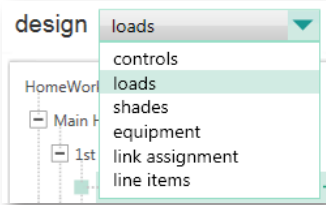

Select an area that will contain the Infratech heaters by clicking on that area name in the tree to the left. The selected area will be highlighted green.

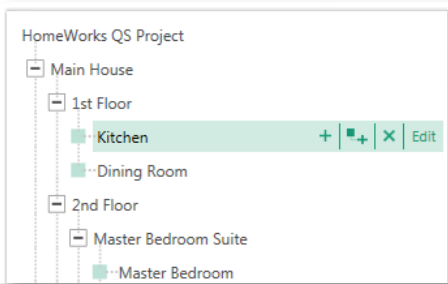

In the upper-right corner of the software window, click **Edit Fixtures**.

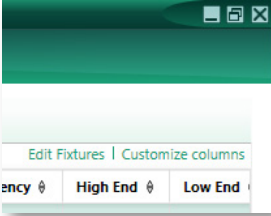

The **System Fixtures** configuration window will appear which allows you to create fixture placeholders for easy placement into the load schedule. On the **Custom** tab, create a fixture placeholder for the Infratech heaters by selecting either **LED** or **Fluorescent**. Choosing either **LED** or **Fluorescent** changes the trim level that can be set based on the dimmer being used. You may need to show **High End** and **Low End** by customizing the columns. When using a neutral wire dimmer with GRX-TVI-CPN3876, refer to **Section 6.4** for trim level settings.

System Fixtures							
Custom		Ivalo Downlights		Ivalo Pendants/Sconces			
Fixture	Voltage	Load Type	Lamp Wattage	Lamp Qty.	Wattage	High End	Low End
Infratech	120V	LED 0-10V	10	1	10	89	28

Continued on next page...

## 6.0 Setting Trim Levels on Neutral Wire Dimmers (continued)

### 6.2 Setting Trim Levels via RadioRA 2 Software

Select the room where the Infratech heater is located.



Right click on the control for the Infratech heater and select **Advanced Settings**.

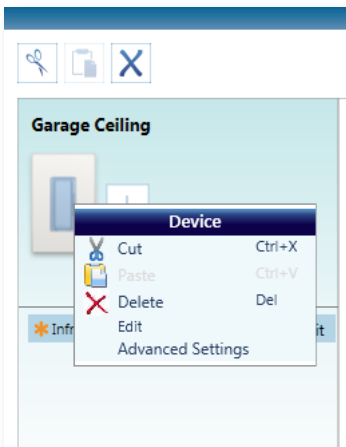

In the **Advanced Settings** screen, fill in the **Low End Trim** and **High End Trim** fields and click **Done**. When using a neutral wire dimmer with GRX-TVI-CPN3876, refer to **Section 6.4** for trim level settings.

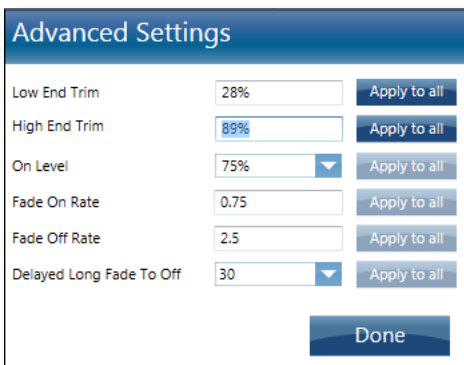

Continued on next page...

## 6.0 Setting Trim Levels on Neutral Wire Dimmers (continued)

### 6.3 Setting Trim Levels on a Caséta Wireless Dimmer (PD-10NXD)

The PD-10NXD trim levels need to be set on the dimmer itself and not through the Caséta Wireless app.

#### 6.3.1 Setting Low-End Trim

Press and hold the “☼” and “▼” buttons until a status LED starts to flash (about 6 seconds).

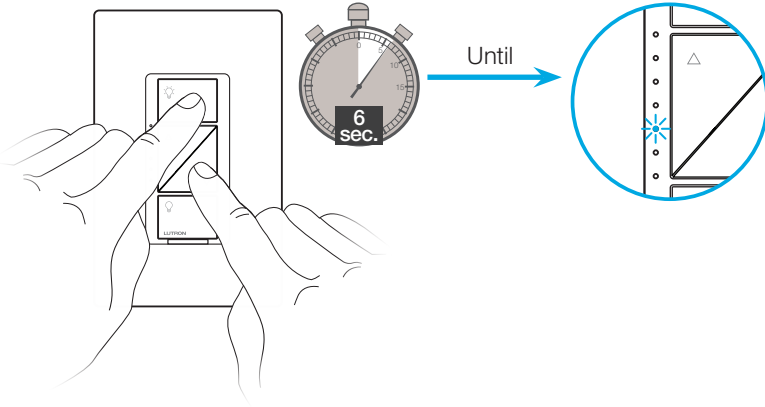

Press and hold the “▼” button until the Infratech heater is on the lowest setting.

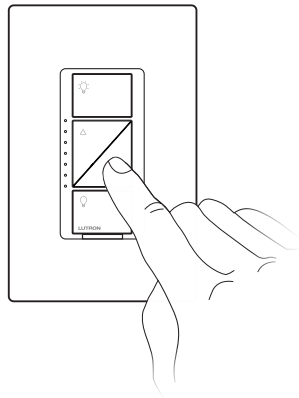

Press and hold the “☼” button until the status LED stops flashing.

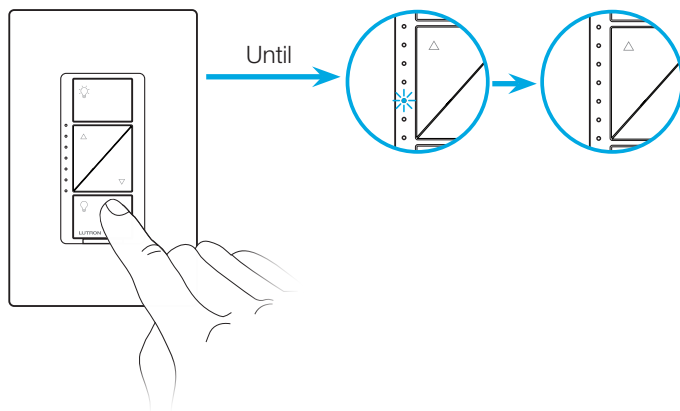



Continued on next page...



## 6.0 Setting Trim Levels on Neutral Wire Dimmers (continued)

### 6.3 Setting Trim Levels on a Caséta Wireless Dimmer (PD-10NXD) (continued)

#### 6.3.2 Setting High-End Trim

Press and hold the “” and “” buttons until a status LED starts to flash (about 6 seconds).

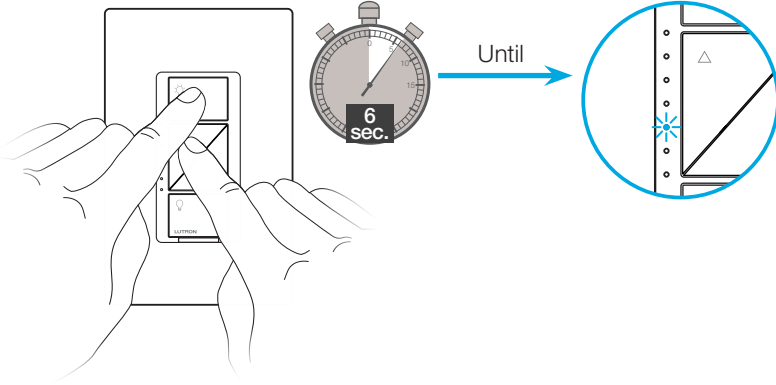

Press and hold the “” button until the Infratech heater is on the highest setting.

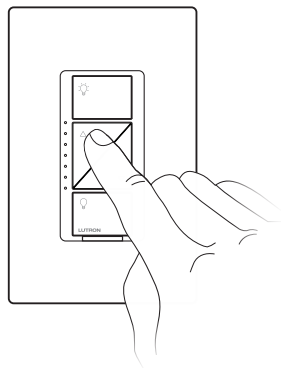

Press and hold the “” button until the status LED stops flashing.

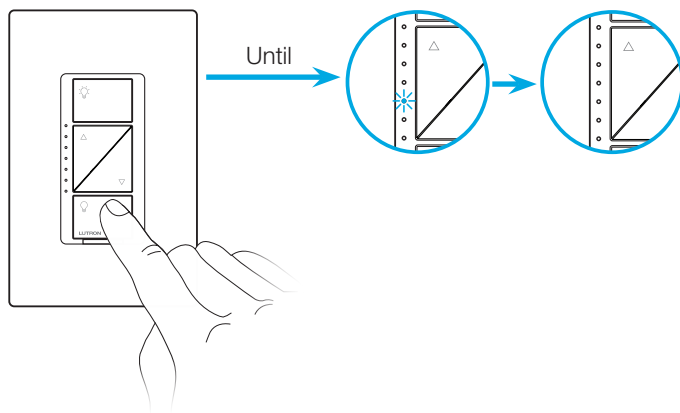

Continued on next page...

## 6.4 Setting Trim Levels When Using GRX-TVI-CPN3876

Below is a list of devices used in HomeWorks, RadioRA 2, and Caséta Wireless systems that can control Infratech heaters through a GRX-TVI-CPN3876 and the trim levels that need to be set on each device. The trims need to be set to 28% for low-end and 81% for high-end. This is due to the fact that the GRX-TVI-CPN3876 is looking for a signal from a fluorescent dimmer.

**Important Note:** If using a fluorescent dimmer, no trim level adjustments are required.

System	Model Number	Low-End	High-End	Special Instructions
HomeWorks	HW-RPM-4A	28%	81%	–
HomeWorks	HW-RPM-4U	28%	81%	–
HomeWorks	HQRD-6NA or HQRA-6NA	28%	81%	Forward Phase
HomeWorks	HQRD-10ND or HQRA-10ND	28%	81%	–
HomeWorks	HQRD-F6AN or HQRA-F6AN	28%	81%	–
HomeWorks	HQRD-H or HQRA-H	28%	81%	–
HomeWorks	HQRD-HN or HQRA-HN	28%	81%	–
HomeWorks	HQRT-5NEW	28%	81%	Forward Phase
HomeWorks	HQRT-G25LW	28%	81%	–
HomeWorks	HQRT-GH2B, HQRT-GH4B, HQRT-GH5B, or HQRT-GH6B	28%	81%	–
HomeWorks	HWD-6ND or HWA-6ND	28%	81%	–
HomeWorks	HWD-10ND or HWA-10ND	28%	81%	–
HomeWorks / RadioRA 2	LQRJ-WPM-6P	28%	81%	–
HomeWorks / RadioRA 2	QSGRJ-3P, QSGRJ-4P, or QSGRJ-6P	28%	81%	–
RadioRA 2	RRD-6NA	28%	81%	Forward Phase
RadioRA 2	RRD-10ND	28%	81%	–
RadioRA 2	RRD-F6AN	28%	81%	–
RadioRA 2	RRD-H	28%	81%	–
RadioRA 2	RRD-HN	28%	81%	–
RadioRA 2	RRD-5NEW	28%	81%	Forward Phase
RadioRA 2	RRT-G25LW	28%	81%	–
RadioRA 2	RRT-GH2B, RRT-GH4B, RRT-GH5B, or RRT-GH6B	28%	81%	–
Caséta Wireless	PD-5NE	28%	81%	Forward Phase
Caséta Wireless	PD-10NXD	28%	81%	–

Lutron, HomeWorks, RadiaRA, Clear Connect, Ivalo, RadioRA 2, GRAFIK T and Caséta are trademarks or registered trademarks of Lutron Electronics Co., Inc. in the US and/or other countries.

Infratech is a trademark of InfratechHeatersUSA.

LVS is a trademark of LVS Inc.

---

## Lutron Contact Numbers

### WORLD HEADQUARTERS

**USA**  
**Lutron Electronics Co., Inc.**  
**7200 Suter Road**  
**Coopersburg, PA 18036-1299**  
TEL: +1.610.282.3800  
FAX: +1.610.282.1243  
support@lutron.com  
www.lutron.com/support

**North & South America**  
**Customer Assistance**  
**USA, Canada, Caribbean:**  
1.844.LUTRON1 (1.844.588.7661)  
**Mexico:**  
+1.888.235.2910  
**Central/South America:**  
+1.610.282.6701

### EUROPEAN HEADQUARTERS

**United Kingdom**  
**Lutron EA Limited**  
**125 Finsbury Pavement**  
**4th floor, London EC2A 1NQ**  
**United Kingdom**  
TEL: +44.(0)20.7702.0657  
FAX: +44.(0)20.7480.6899  
FREEPHONE (UK): 0800.282.107  
Technical Support: +44.(0)20.7680.4481  
lutronlondon@lutron.com

### ASIAN HEADQUARTERS

**Singapore**  
**Lutron GL Ltd.**  
**390 Havelock Road**  
**#07-04 King's Centre**  
**Singapore 169662**  
TEL: +65.6220.4666  
FAX: +65.6220.4333  
Technical Support: 800.120.4491  
lutronsea@lutron.com

### Asia Technical Hotlines

Northern China: 10.800.712.1536  
Southern China: 10.800.120.1536  
Hong Kong: 800.901.849  
Indonesia: 001.803.011.3994  
Japan: +81.3.5575.8411  
Macau: 0800.401  
Taiwan: 00.801.137.737  
Thailand: 001.800.120.665853  
Other Countries: +65.6220.4666