

Application Note

EMC/EMI Filter Design with RB Common-Mode Chokes



SCHAFFNER
energy efficiency and reliability

Content

Scope of this Application Note	3
Introduction	3
Electromagnetic Compatibility (EMC) and Electromagnetic Interference (EMI)	3
EMC/EMI filter design	4
Design notes for RB chokes	5
Low and high inductance versions	5
Vertical and horizontal versions	6
2-wire and 3-wire versions	6
Saturation	7
Inductivity	8
Impedance Z	9
Filter design example	10
1. Determine AC current	10
2. Estimate the EMI noise level	11
3. Determine required filter attenuation	13
4. Specify the filter corner frequency f_c	14
5. Select the RB choke	14
6. Calculate the values of the capacitors	15
7. Design note for X- and Y- capacitors	15
8. Check the leakage current limit	16
9. Consider to use RB choke evaluation boards for a test set-up	16
10. Designing the filter	16
11. Verification of the filter attenuation	17
PCB design details	19
Summary	21

Scope of this Application Note

This application note addresses experienced engineers, who are familiar with the basics of EMC, and intends to provide

- ▮ Additional information about RB choke series
- ▮ Design support for PCB integrated EMC/EMI filters

Introduction

With RB chokes any DC, single- or three-phase EMC/EMI filter can be designed. Target applications are PV or drive inverters, welding units, quick chargers, power supplies or any other power electronic device.

RB choke series are common-mode (CM) chokes designed for a current range from 16 to 50A with convection cooling. They can operate with currents up to 80A in forced cooling areas with 3m/s air velocity. Integrating EMC/EMI filters directly into the power unit results in higher power density.



Like most Schaffner EMC/EMI filters, RB chokes match for worldwide applications. Bobbins and base plates consist of halogen free plastics. All materials are in accordance with the new ROHS II and REACH requirements for products for the European Community and fulfill the specifications for UL approval.

More technical details can be found in the [RB series datasheet](#).

RB chokes can be disassembled after end of life and help to fulfill the recycling quote required in directives like "Waste Electrical and Electronic Equipment" or similar documents giving advices for "green" design of electronic equipment.

Electromagnetic Compatibility (EMC) and Electromagnetic Interference (EMI)

The main task of the EMC/EMI filter design is to bring EMI noise down below the allowed limits of emission standards for the conducted RF range. For more details please refer to the Application Note [Basics in EMC and PQ](#).

EMC/EMI filter design

To fulfill the generic standards for conducted emissions, EMI noise has to be reduced starting from 150 kHz. In some products standards like for [lighting products](#) the limits already start at 9 kHz.

RB chokes are so called common-mode (CM) or current-compensated chokes. They are wound with at least two identical windings. The current draw flows through both windings, causing magnetic flux in the opposite direction and results in almost zero inductivity. Due to the resulting flux of the currents being zero, the choke will not go into magnetic saturation under normal operating conditions.

High inrush currents, high crest factors (peak to average current ratio) of the line current draw, DC currents in only one winding as a result of unbalances (like small differences in switching times) or high frequency CM currents can cause saturation and degrade the proper operation of the EMC/EMI filter.

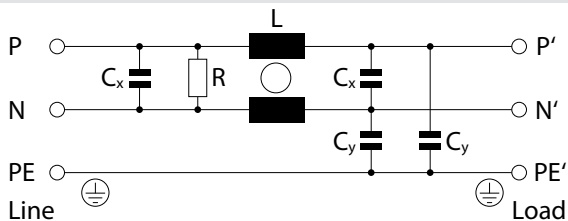

Fig 1: Schematic of a typical single-phase EMC/EMI filter

A typical EMC/EMI filter schematic is shown in figure 1. Designing filters with RB chokes is an economic way to combine low losses, low voltage drop, minimal signal impact with efficient EMC/EMI filtering.

Although RB chokes are common-mode chokes, EMC/EMI filters for both types of interferences – for common-mode (CM) noise as well as for differential-mode (DM) noise can be designed with, because L consists out of two parts: The nominal inductivity L_N and the stray inductivity L_S .

CM noise is damped by the nominal inductivity L_N of the choke and by the load-side C_Y capacitors to ground. DM noise is attenuated by the load-side capacitor C_X (if present) and the low pass filter consisting of the stray inductivity L_S of the CM choke (about 1% of L_N) and the line-side C_X .

The path via the Y-caps to PE (protective earth) closes the loop of CM current noise. The return path to the noise source has to be short for good CM attenuation performance.

The line-side PE connection is a safety measure. Here the so called leakage current flows with line frequency via the Y-caps. Line-side leakage current has to comply with the limits of applied safety standards (Refer to Application Note: [“Leakage current of power line filters”](#)).

The resistor on the line side – the so called bleed resistor – is also a safety measure. It discharges the filter capacitors to ensure that the voltage on the terminals tends to zero after line voltage is switched off.

Design notes for RB chokes

RB chokes are designed to integrate EMC/EMI filters directly to the PCB. All RB chokes can be used for DC or AC applications ranging from 0 to 400 Hz line frequency. The chokes are designed with ferrite cores and can handle switching frequencies up to several hundred kHz.

Cores are enclosed by bobbins with clearance (cl) and creepage (cp) distances (all 2 wire versions cl >3.6 mm, cp >5.2 mm; all 3-wire chokes cl >5.5 mm, cp >6.4 mm) to fulfill product-related

safety requirements and to ensure long term reliability even under severe operating conditions like vibration or thermal fluctuation.

RB chokes offer screw domes to mount them to the PCB for additional mechanical strength.

Because of the clear winding separation, RB chokes can also be used for HF transformer applications.

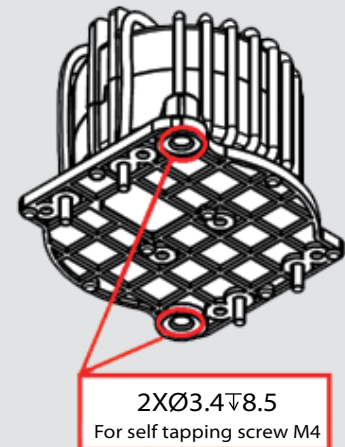

Fig. 2: RB choke mounting

Low and high inductance versions

RB chokes are available in two inductance versions. The low inductance versions (all RB6xxx types) are suited for applications with high inrush current or high crest factor like power electronics with passive rectification not having sinusoidal line current draw. They can also be used for equipment with sinusoidal current draw.

The high inductance versions (all RB8xxx types) have a more pronounced attenuation, but a lower peak current ability and are thus recommended for applications with sinusoidal line current draw. For applications with higher EMI noise level or where EMI limits start earlier (e.g. lighting products), RB8xxx types can be used.

Vertical and horizontal versions

The low inductance series are available as vertical (all RB65xx types) and horizontal (all RB61xx types) versions. The high inductance series are available as vertical (all RB85xxx types) versions.

2-wire and 3-wire versions

For DC and single phase applications the 2-wire CM chokes (all RBxx22 types), for 3-phase applications the 3-wire versions (all RBxx32 types) fit. 4-wire versions are available on request.



Fig. 3: RB choke versions

Saturation

CM currents flowing through one or more windings without cancelling the flux to zero (limit ICM_{max}) or high peak currents running in differential-mode through both windings (limit IDM_{max}) like an inrush current can cause saturation. Table 1 shows the limits specified at 25 °C and 100 °C ambient temperature:

Designation	convection cooling nominal current @60 °C [A]	forced cooling 3 m/s nominal current @60 °C [A]	Nominal Inductance L_N @25 °C [mH/path]	Typical stray Inductance L_S @25 °C [μ H/path]	Resistance R @25 °C [m Ω /path]	max. DM peak current 25 °C IDM_{max} @25 °C [A]	max. DM peak current 100 °C IDM_{max} @100 °C [A]	max. CM peak current 25 °C ICM_{max} @25 °C [A]	max. CM peak current 100 °C IDM_{max} @100 °C [A]
RB6122-16-1M0	16	25	1.00	6.3	4.8	135	95	0.24	0.16
RB6122-25-0M6	25	39	0.64	4.0	2.7	160	112	0.31	0.21
RB6122-36-0M5	36	53	0.45	3.6	1.5	185	130	0.41	0.28
RB6122-50-0M3	50	80	0.25	1.8	0.9	270	189	0.58	0.40
RB6522-16-1M0	16	25	1.00	6.2	4.6	135	95	0.24	0.16
RB6522-25-0M6	25	39	0.64	3.9	2.6	160	112	0.31	0.21
RB6522-36-0M5	36	53	0.45	3.6	1.5	185	130	0.41	0.28
RB6522-50-0M3	50	80	0.25	2.0	0.9	270	189	0.58	0.40
RB8522-16-3M0	16	25	3.00	22.2	8.4	73	51	0.17	0.11
RB8522-25-2M0	25	39	2.00	13.6	4.2	126	88	0.27	0.18
RB8522-36-1M5	36	58	1.50	12.8	3.0	165	116	0.40	0.27
RB8522-50-0M8	50	83	0.75	6.5	1.7	225	158	0.55	0.36
RB6132-16-0M8	16	26.5	0.80	5.8	4.6	155	109	0.32	0.22
RB6132-25-0M5	25	41	0.47	3.3	2.4	225	158	0.41	0.28
RB6132-36-0M4	36	60	0.42	2.9	1.4	330	231	0.59	0.39
RB6132-50-0M2	50	81	0.18	1.9	0.9	335	235	0.88	0.59
RB6532-16-0M8	16	26.5	0.80	6.9	4.7	155	109	0.32	0.22
RB6532-25-0M5	25	41	0.47	3.6	2.4	225	158	0.41	0.28
RB6532-36-0M4	36	60	0.42	4.2	1.5	330	231	0.59	0.39
RB6532-50-0M5	50	81	0.18	1.5	0.8	335	235	0.88	0.59
RB8532-16-1M3	16	27	1.30	9.1	5.7	128	90	0.26	0.17
RB8532-25-0M9	25	41	0.94	6.7	3.0	195	137	0.39	0.26
RB8532-36-0M8	36	58	0.83	7.3	2.3	260	182	0.55	0.36
RB8532-50-0M3	50	82	0.33	3.1	1.2	395	277	0.88	0.59

Table 1: RB chokes saturation parameters

ICM_{max} is the maximum allowed current flowing through one winding without causing saturation. IDM_{max} is the maximum allowed current flowing back and forward through both windings without causing saturation. DC currents or the peak value of AC currents should be below this level under all operation modes. For applications with ambient temperatures >125 °C different core types can be optionally used.

Inductivity

The nominal inductivity of the RB chokes given in the datasheet is tested with a frequency of 1 kHz. CM chokes inquiries are often reduced to the inductivity value and ampere rating. Differences of core material and the inductivity test frequency have to be considered to achieve similar EMI attenuation results. The inductivity of a toroid choke can be calculated according equation 1:

$$L = \frac{\mu_0 \mu_r N^2 A}{2\pi r}$$

L	inductivity	N	number of turns
μ_0	magnetic constant	A	cross sectional area
μ_r	relative permeability	r	toroid radius to centerline

Equ. 1: Inductivity of chokes with toroid cores

Equation 1 shows, that the inductivity depends on the number of turns, geometrical properties and on the relative permeability. The relative permeability is not constant over the frequency and has a different trend depending on the material. To compare inductivity values of chokes the relevant frequency range has to be determined first.

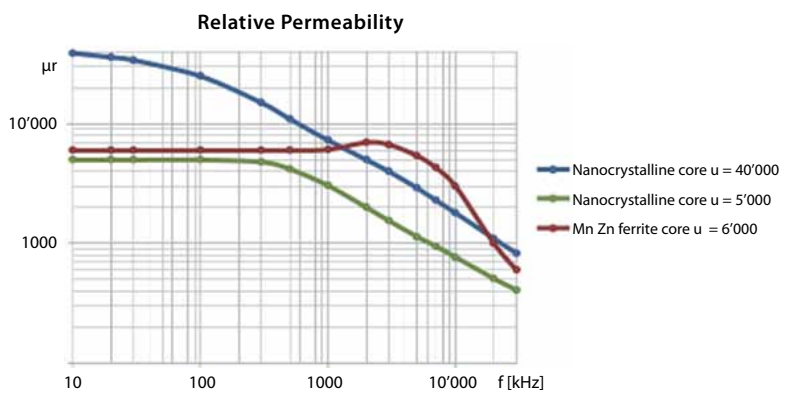

Fig. 4: Relative permeability μ_r for Mn Zn ferrite compared with nanocrystalline material

Figure 4 shows the relative permeability μ_r over the frequency of Mn Zn ferrite (displayed red) used in RB chokes in comparison to nanocrystalline cores with a relative permeability of 40 000 (blue) and 5000 (green) at 10 kHz. The μ_r of nanocrystalline cores declines earlier towards higher frequency, the type with the high permeability maintains not even 20% of its nominal value at 1 MHz. The inductivity is proportionally dependent to the relative permeability and declines the same way.

CM chokes with high μ_r nanocrystalline cores have a better performance in the lower frequency range but also a lower saturation limit. Nanocrystalline cores with about the same geometry and similar μ_r value (displayed green) have a higher saturation limit than Mn Zn ferrite cores, but μ_r declines earlier. Due to the good overall characteristic, Mn Zn ferrite fits best for most EMC/EMI filter applications.

Impedance Z

As shown before L over f depends on several constant factors and the relative permeability. In theory the impedance Z of an ideal CM choke would increase with the rising frequency according the equation 2:

$$Z = \omega L$$

ω angular frequency ($\omega = 2 \pi f$)

Equ. 2: Impedance Z

A real choke has also a parasitic winding capacitance (C_{WI}) like displayed in the simplified model in figure 5:

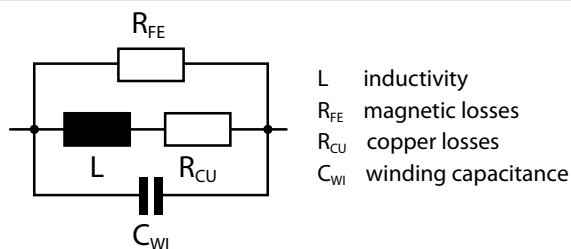

Fig. 5: Simplified equivalent circuit diagram of a real choke

The impedance Z of a real choke rises until the resonance point is reached. The resonance frequency f_{res} depends on the parasitic winding capacitance (C_{WI}) and the inductivity L. It can be calculated according equation 3:

$$f_{res} = \frac{1}{2\pi \sqrt{LC_{WI}}} \text{ for } R_{CU} < 10\text{Ohm and } R_{FE} > 1\text{M}\Omega$$

Equ. 3: Resonance frequency f_{res}

When the resonance point is reached, the trend of impedance Z and as well of the attenuation will reverse and decrease. This can be seen in the following attenuation curves.

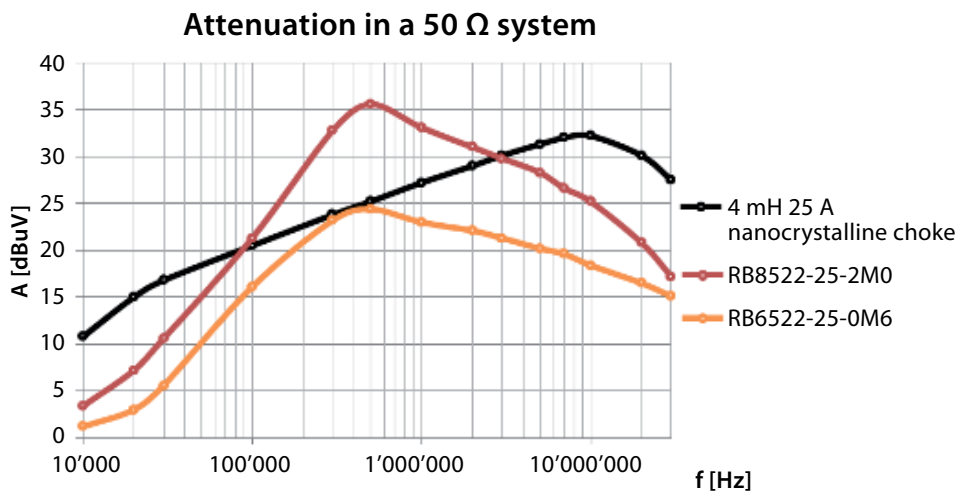

Fig. 6: Attenuation of RB6522-25-0M6, RB8522-25-2M0 and a 4 mH 25 A nanocrystalline choke

The attenuation curves in figure 6 show the performance of the 25 A high and low inductance version of RB series in comparison with a 4 mH 25 A nanocrystalline choke. As already seen in the trend of the relative permeability the nanocrystalline choke has a higher attenuation in the lower frequency area. It also has more attenuation in the higher frequency area due to the smaller winding capacitance using less turns.

Figure 6 also shows, that RB chokes achieve a similar or better noise attenuation in the generic frequency range of conducted emissions with a 2 to 6 times lower nominal inductivity value compared to nanocrystalline chokes combined with a higher saturation limit. Due to the lower losses of ferrite cores, RB chokes can also be used for applications with higher switching frequency.

Filter design example

A simple example was chosen to explain the design approach for an EMC/EMI filter with RB chokes. Assuming our application is a 1.6 kW half bridge push-pull converter running on 115 V AC single phase like shown in Figure 7. The switching frequency is 20 kHz, the duty cycle is 50% and IEC/EN61000-6-3, – the generic emission standard for residential, commercial and light-industrial environments – should be fulfilled. The switching components are displayed as switches T1 and T2.

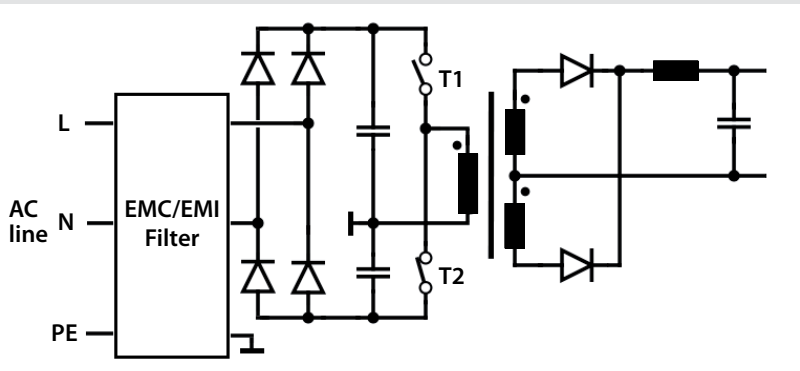

Fig. 7: Half bridge push-pull power supply

1. Determine AC current

To design an EMC/EMI line filter with RB chokes, the highest AC current is expected at minimum input voltage ($115\text{ V} - 10\%$) $I_{ac} = 1600\text{ W} / 103.5\text{ V} = 15.5\text{ A}$. RB chokes can operate up to an ambient temperature of 60°C without derating. In this case a 16 A RB choke is selected.

2. Estimate the EMI noise level

RB chokes are available as low and high inductance versions. For this application with non-sinusoidal current the low inductance version (all RB6x22) is the preferred type. To identify the needed attenuation performance we estimate in a next step the EMI noise level.

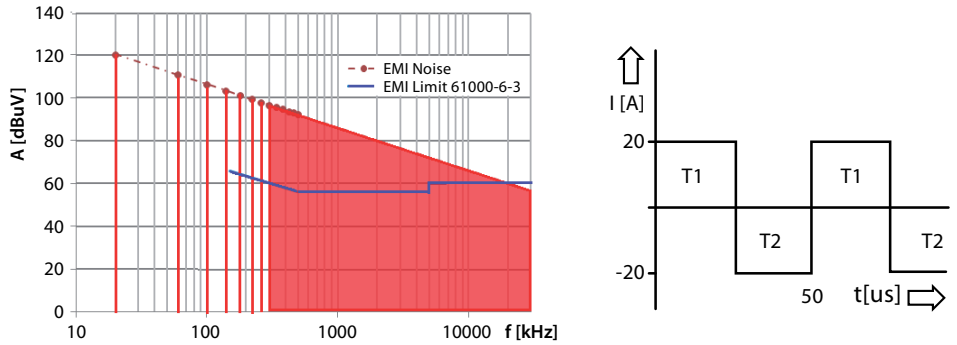

Fig. 8: Estimated trend of DM noise

The DM noise going to the line is mainly caused by the voltage drop across the impedance Z of the DC link capacitors resulting from the current blocks of the switching transistors. A very simplified EMI noise estimation (neglecting the ramp up time of the current, the needed dead time between the current blocks of the push-pull converter, the non-conducting phase of the diodes, the frequency dependence of Z , etc.) delivers a voltage drop U of about 0.76 V with current blocks of 20 A and an impedance Z of 38 m Ω .

$$a_n = \frac{4U}{\pi n} \text{ [V]} \quad A_n = 20 \log \frac{a_n}{1\mu\text{V}} \text{ [dB}\mu\text{V]} \quad \text{for } n = 1, 3, 5, \dots$$

Equ. 4: Fourier analysis

The Fourier analysis according equation 4 delivers the harmonics for this symmetrical signal. For the fundamental we receive 0.97 V (120 dB μ V) as displayed in figure 8. DM noise can be described as an envelope curve starting at 20 kHz with 120 dB μ V and decreases with 20 dB per decade. As a symmetrical signal is only causing odd harmonics, the 9th (180 kHz) with 0.11 V (101 dB μ V) would be the first harmonic to be damped to comply with the quasi peak limits of IEC/EN61000-6-3.

For PWM modulated signals with a steady variation of the on time like with drives or PFC converters the envelope curve is more complex. For an estimation of DM noise with variable duty cycle like for PFC stages, the envelope curve can also be reduced to a simple model. The amplitude of the fundamental remains on the same level up to frequency f_1 , which can be calculated with equation 5:

$$f_1 = \frac{f_s}{\sin(\pi d_{\min})}$$

d_{\min} smallest duty cycle [RAD]
 f_s switching frequency

Equ. 5: Frequency f_1 for EMI noise envelope curve

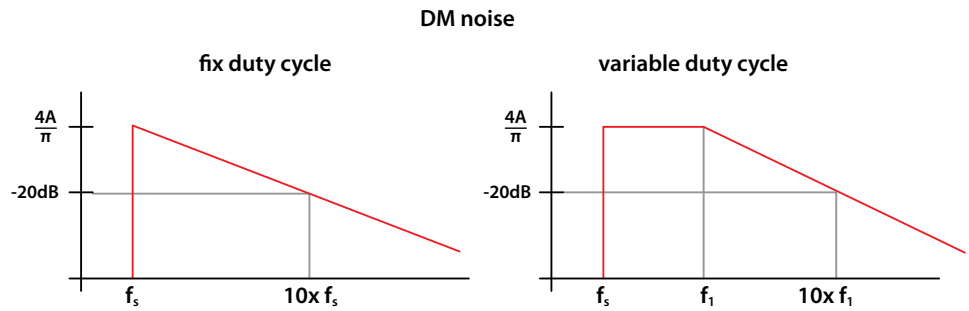

Fig. 9: Simplified envelope curves of DM noise

Figure 9 shows the simplified models of DM noise in both cases. Starting at the fundamental with a fix duty cycle of 50%, the envelope curve of DM noise immediately decreases with 20 dB μ V per decade. For applications with variable duty cycle the envelope curve remains on the starting level up to f_i and then decreases with 20 dB μ V per decade like shown at the right side diagram of figure 9.

CM noise is mainly transferred to ground via the small parasitic capacitor of the insulation between the chip and the ground of the switching power component (excluded motor drive applications with shielded motor power cords).

In our example with a fixed duty cycle of 50% CM noise is a symmetrical signal with the switching frequency period. The decay time of the pulses depends on the size of the coupling capacity and the impedance of the circuit which closes the loop to balance the leap. Assuming a coupling with several 10 pF and a line impedance of 25 Ω of the LISN for CM noise and no further ringing effects, the simplified response signal would look like shown in figure 10:

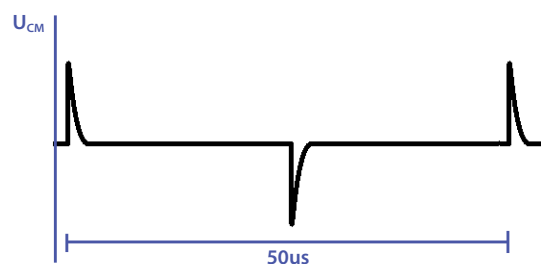

Fig. 10: Simplified CM noise signal

If one of the transistors switches, the voltage leap of 80 V would lead to current flowing through the parasitic capacitor to ground. The contact to ground can be considered as a capacitive voltage divider of parasitic capacitor of the power components (transistors, diodes) mounted to the heat sink. Assuming the switching transistor transfers 20 V to ground, we receive 25 V (148 dB μ V) for the fundamental A_1 according equation 4.

For the subsequent harmonics CM noise decreases much stronger compared to DM noise. CM noise rises again for frequencies above 1MHz. To get specifications for the required CM attenuation, a low pass behavior of $-40 \text{ dB}\mu\text{V} / \text{decade}$ (low pass consisting out of coupling capacity and wire inductivity) is assumed. Hence amplitude A_9 is expected to be about 1% of the fundamental ($0.5 \text{ V} = 108 \text{ dB}\mu\text{V}$).

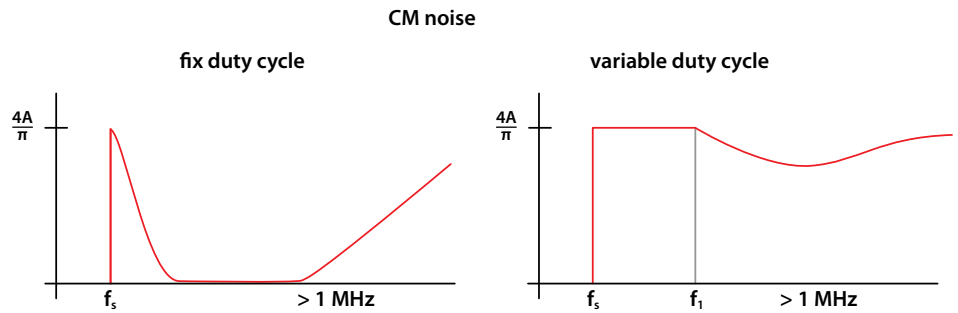

Fig.11: Simplified envelope curves of CM noise

Predicting the CM noise is more difficult, because parasitic couplings and resonances have more impact. Figure 11 shows the possible trend of harmonics. For applications with variable duty cycle, the noise level does not decrease up to f_1 , similar as with the DM noise. In both cases CM noise levels increase in the higher frequency range.

CM noise also depends more on design details of the power unit. A poor system design can raise the conducted noise level and also cause emissions in the radiated range. CM currents can flow through housing and power cords and use them as antenna to radiate EMI noise. Thus it is important to keep the loop of asymmetric current between the noise source and the EMI filter short.

3. Determine required filter attenuation

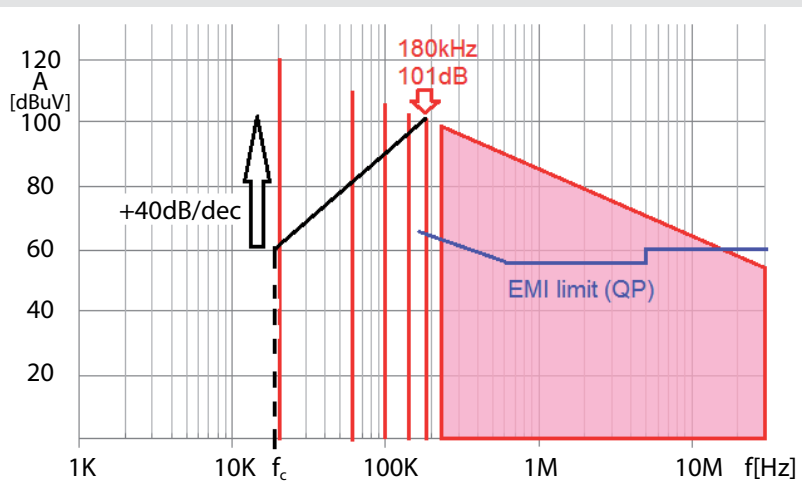

Fig. 12: Principle of EMC/EMI filter design determination

Figure 12 shows the principle to determine the required DM attenuation A. It can be looked at as a subtraction between the DM noise level (red) and the limits (blue). Considering an additional safety margin m to keep the EMI noise below the limits with respect to tolerances in series production, the required attenuation A can be derived from equation 6:

$$A[\text{dB}\mu\text{V}] = A_n - L_{\text{QP}} + m$$

A_n EMI amplitude of the nth harmonic (first harmonic above 150kHz)
L_{QP} EMI Quasi Peak limit at the nth harmonic (first harmonic above 150kHz)
m safety margin (e.g. 3dB)

Equ. 6: Required filter attenuation A

To comply with the QP limit (65 dB μ V) of IEC/EN61000-6-3 and to reduce the DM noise of 101 dB μ V at 180 kHz, the filter needs a DM attenuation of 39 dB μ V with a safety margin of 3 dB.

With the assumed CM noise of 108 dB μ V at 180 kHz and a safety margin of 3 dB μ V, a CM attenuation of 46 dB μ V is required.

4. Specify the filter corner frequency f_c

With the knowledge that the attenuation of a LC-filter starts at the corner frequency and the attenuation is rising with 40 dB per decade, the needed corner frequency can be specified according equation 7:

$$A[\text{dB}\mu\text{V}] = 40 \log \left(\frac{f}{f_c} \right) \Leftrightarrow f_c = 10^{\frac{-A}{40}} f$$

Equ. 7: Calculation of corner frequency f_c

The relative filter performance trend curve is also displayed in figure 12 (black). Where the start of the trend curve with 40 dB rise is below the EMI limit, is the required corner frequency f_c of the filter. With the required DM attenuation of 39 dB μ V, equation 7 delivers a DM corner frequency f_c of 19 kHz.

With a required CM attenuation of 46 dB μ V at 180 kHz the CM corner frequency f_c results to 12.7 kHz.

5. Select the RB choke

As our example has a non-sinusoidal current consumption like shown in Figure 13, the low inductance version RB6x22-126-1M0 should be preferred. If there is no sufficient attenuation achievable or a low leakage current design is needed, the high inductance version RB8522-16-3M0 can be used, if inrush and line current of the application do not exceed the saturation limits given in table 1.

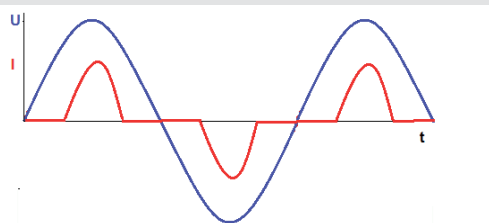

Fig.13: Non-sinusoidal line current

RB6x22-16-1M0 is selected as a preferred solution and RB8522-16-3M0 as an option.

6. Calculate the values of the capacitors

Derived from the common equations to calculate the corner frequency f_c the required values of C_x and C_y can be calculated according equation 8:

$$f_{\text{CDM}} = \frac{1}{2\pi\sqrt{2L_S C_X}} \quad f_{\text{CCM}} = \frac{1}{2\pi\sqrt{2L_N C_Y}}$$
$$C_X = \frac{1}{8\pi^2 L_S f_{\text{CDM}}^2} \quad C_Y = \frac{1}{8\pi^2 L_N f_{\text{CCM}}^2}$$

Equ. 8: Calculation values for C_x and C_y

Assuming we use the vertical versions of RB chokes, we can get the stray inductivity values L_S out of table 1 and receive $L_S = 6.3 \mu\text{H}$ for RB6522-16-1M0 and $L_S = 22.2 \mu\text{H}$ for RB8522-16-3M0.

With equation 8 we receive:

For RB6x22-16-1M0

$C_x = 5.6 \mu\text{F}$ with $f_{\text{CDM}} = 19 \text{ kHz}$ and $C_y = 79 \text{ nF}$ with $f_{\text{CCM}} = 12.7 \text{ kHz}$

We select RB6x22-16-1M0 with $C_x = 4.7 \mu\text{F}$ and $C_y = 100 \text{ nF}$ as preferred filter solution

For RB8x22-16-3M0

$C_x = 1.6 \mu\text{F}$ with $f_{\text{CDM}} = 19 \text{ kHz}$ and $C_y = 26 \text{ nF}$ with $f_{\text{CCM}} = 12.7 \text{ kHz}$

We select RB8522-16-1M0 with $C_x = 1.5 \mu\text{F}$ and $C_y = 33 \text{ nF}$ as optional filter solution.

(Selections are closest values according E6 series)

7. Design note for X- and Y-capacitors

As mentioned, the filter capacitors have to handle the ripple and leakage current.

Y-capacitors have limitations to consider:

- Thermal limit for high frequency switching currents, in particular with power electronics with no galvanic insulation or shielded motor cables
- Leakage current requirements of the application.
- Sufficient dielectric strength to withstand burst, surge, Hi-pot test voltage from active line to ground

For Class I applications Y2 types should be used.

X-capacitors have also limitations to consider:

- Thermal limit with current caused by switching voltage ripple
- Dielectric strength for burst and surge
- Hi-pot test between active lines (if applied)

Thermal tests with the application running under worst case conditions prove that the EMC design works under all conditions.

For Class I applications X2 types should be used.

8. Check the leakage current limit

As mentioned the value of C_y can be limited by safety standard requirements. The leakage current caused by the line voltage for this single phase application can be calculated according equation 9:

$$I_{lk} = 2\pi f_R U_R C_y$$

f_R rated frequency
 U_R rated voltage

Equ. 9: Calculating leakage current I_{lk}

With a voltage rating of 250 V, we receive $I_{lk} = 2.6$ mA for $C_y = 33$ nF and 7.9 mA for $C_y = 100$ nF. More details about the calculation can be found in the application note [“Leakage current of power line filters”](#).

9. Consider to use RB choke evaluation boards for a test set-up

For the fast design-in of RB choke based EMC/EMI filters Schaffner offers various evaluation boards to test and try the filter design before doing the PCB layout:

order description	fits for
EVA-BOARD FOR RB6122 SERIES	all RB6122
EVA-BOARD FOR RB6132-16/25	RB6132-16-0M8 RB6132-25-0M5
EVA-BOARD FOR RB6132-36/50	RB6132-36-0M4 RB6132-50-0M2
EVA-BOARD FOR RB6522 SERIES	all RB6522
EVA-BOARD FOR RB6532 SERIES	all RB6532
EVA-BOARD FOR RB8522 SERIES	all RB8522
EVA-BOARD FOR RB8532 SERIES	all RB8532

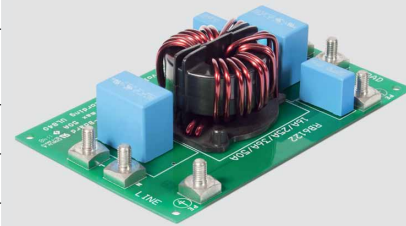

Fig. 14: Evaluation board for RB chokes

10. Designing the filter

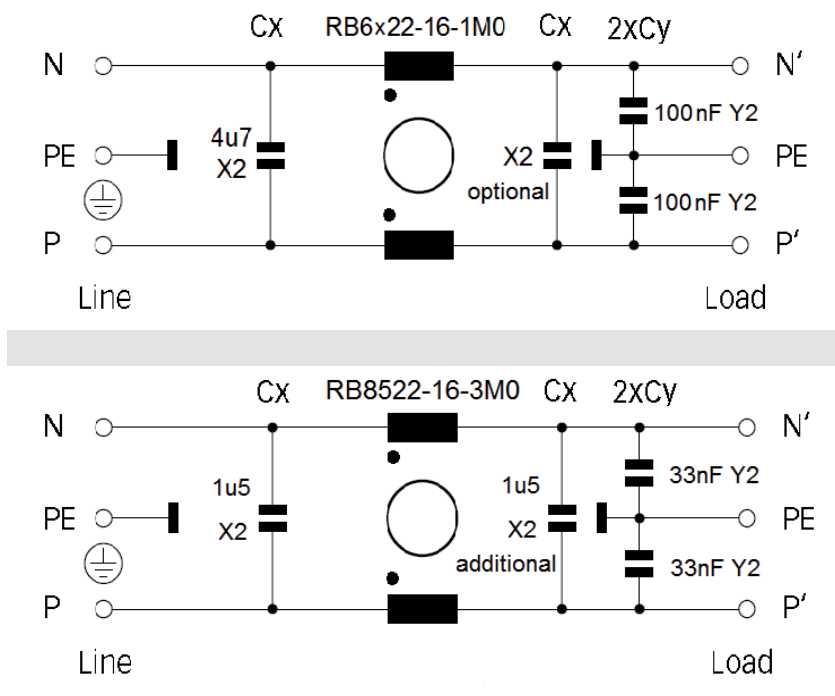

Fig. 15: Schematics of filter design with high and low inductance RB chokes

Figure 15 shows the schematics of the designed filter solutions. If a leakage current of 7.9 mA is not acceptable due to the limit of the applied safety standard (e.g. DIN VDE 0701-0702) the size of the C_y has to be reduced or the high inductance filter solution has to be selected. Additional C_x on the load-side improves the DM attenuation as shown with the CISPR17 measurements in the next chapter.

11. Verification of the filter attenuation

The first filter design with RB6522-16-1M0 has been assembled according Figure 14 with an RB choke evaluation board and the attenuation has been tested according [CISPR 17](#) in the Schaffner test lab:

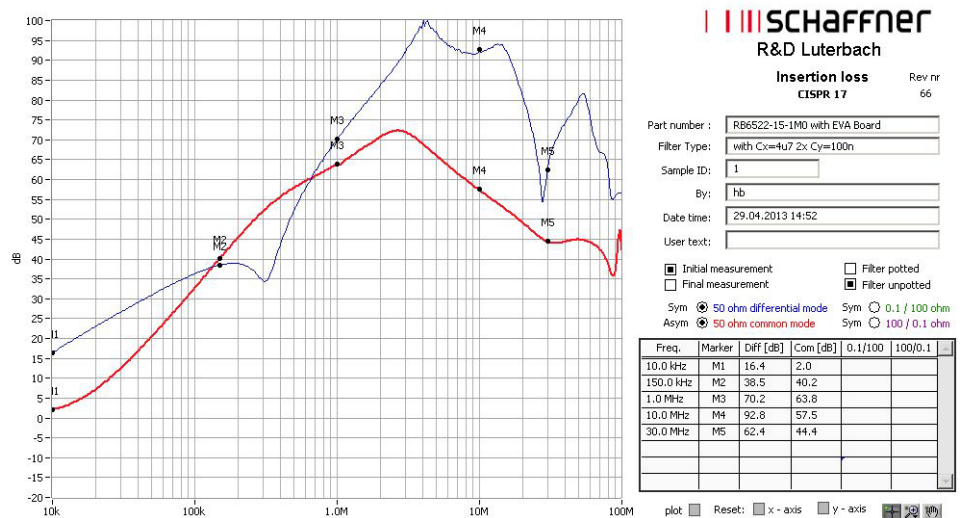

Fig.16: Insertion loss test with RB6522-16-1M0, $C_x = 4.7 \mu F$, $C_y = 100 nF$

Figure 16 shows that the filter design theory is in compliance with the practical evaluation for the 9th harmonics. We receive DM attenuation (blue line) of 39 dB μ V. But the impact of other effects (e.g. parasitic elements of the components, inductive coupling between CM choke and line side C_x etc.) can already be seen in the area above 300 kHz leading to slow-down of expected DM attenuation rise. The measured CM attenuation at 180 kHz is as expected about 45 dB μ V. From a theoretical scope there are no further filtering components needed to fulfill the attenuation performance of the application example.

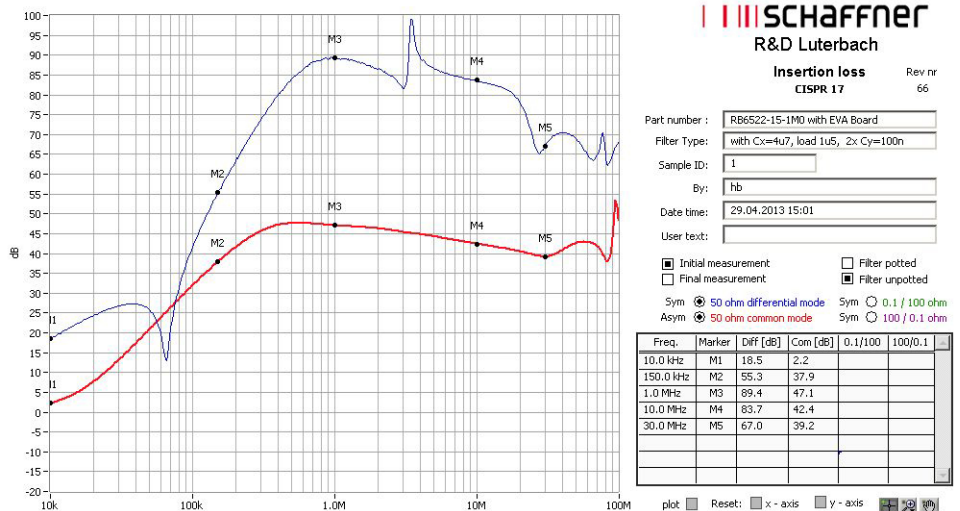

Fig.17: Insertion loss test with RB6522-16-1M0, $C_x = 4.7 \mu\text{F}$ line side, $C_x = 1.5 \mu\text{F}$ load side, $C_y = 100 \text{ nF}$

If the DM performance is not sufficient for the following harmonics or for applications with variable duty cycle, there is a “quick and dirty” method to boost it up: An additional C_x on the load side can improve DM attenuation like shown in figure 17. In real life the performance is not always so apparent depending on the noise impedance.

To fulfill the leakage current requirement of 3.5mA, a second filter design with RB8522-16-3M0 had been assembled with an evaluation board and also tested according [CISPR 17](#) in the Schaffner test lab:

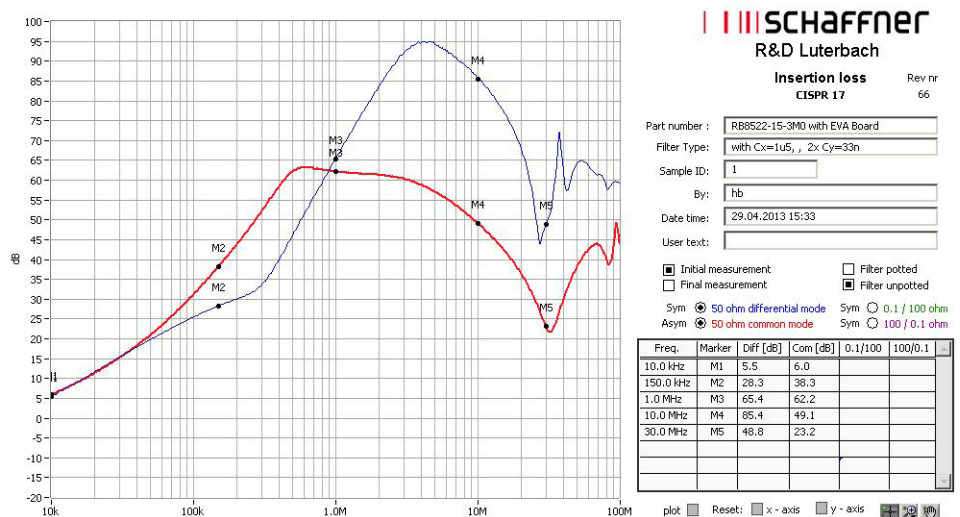

Fig.18: Insertion loss test with RB8522-16-3M0, $C_x = 1.5 \mu\text{F}$, $C_y = 33 \text{ nF}$

Figure 18 shows the result of the CISPR17 test. The projected DM attenuation of 39 dB μ V was not achieved (30 dB μ V at 180 kHz). As discussed already with the results shown in figure 15, the parasitic impacts of other effects can be seen more pronounced this time. Now an additional C_x on the load side is mandatory to achieve the projected filter performance. The CM attenuation is almost as expected about 44 dB μ V.

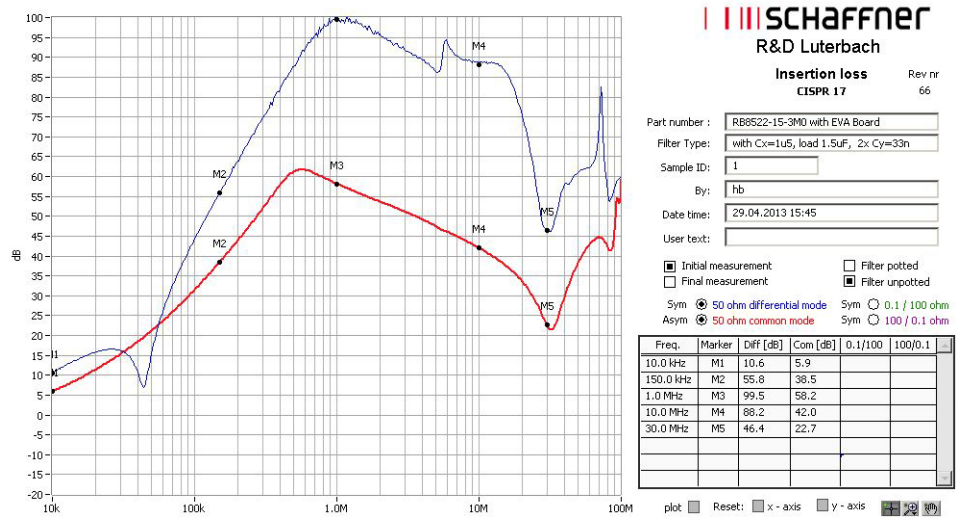

Fig.19: Insertion loss test with RB6522-16-1M0, $C_x = 1.5\mu F$, additional $C_x = 1.5\mu F$ on line side, $C_y = 33\text{ nF}$

Figure 19 shows the improvement of DM attenuation with a load-side $C_x = 1.5\mu F$. DM attenuation is now about 63 dB μ V at 180 kHz. The CM attenuation remained at 44 dB μ V at 180 kHz.

Finally the filter has to be inserted to the test setup and the conducted emissions have to be tested:

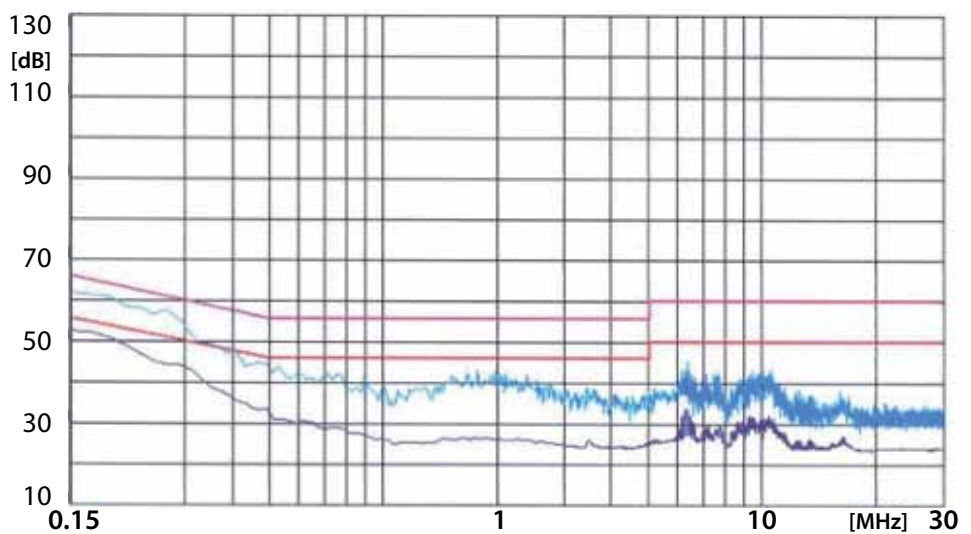

Fig. 20: EMI noise curve complies with the limits of IEC/EN61000-6-3 after filter insertion

The example shows that EMC/EMI filter design can not only be done on theoretical basis, but understanding of the theory is needed to adapt the filter to the individual needs of the application.

PCB design details

Besides the arrangement recommendation of the components shown with the schematics above, mind the rules of PCB EMC/EMI design:

- ❑ Consider the creepage and clearance distances needed in your application.
- ❑ Design circuit paths adequate to the maximum current. High current crest factors lead to higher losses. The higher the current density, the higher the possible stray fields.
- ❑ Minimize the area in between current flowing backward and forward, otherwise it can operate as a “coil” inducing magnetic fields to other components or as a dipole antenna radiating emissions to the environment.
- ❑ For best performance the power flow of the circuit paths has to go directly to the pins of the X-caps. A restriction of the circuit path forces the HF current flowing to the pins. Consider the thermal impacts of this measure as well.
- ❑ Do not intersect filtered and unfiltered paths. Keep the noisy and filtered areas separated in your design including the wiring. The pin-out of the horizontal 3-wire RB chokes are designed to enable optimum separation (see figure 22)
- ❑ Plan a load side C_x if possible, to have the chance to modify DM performance if required.

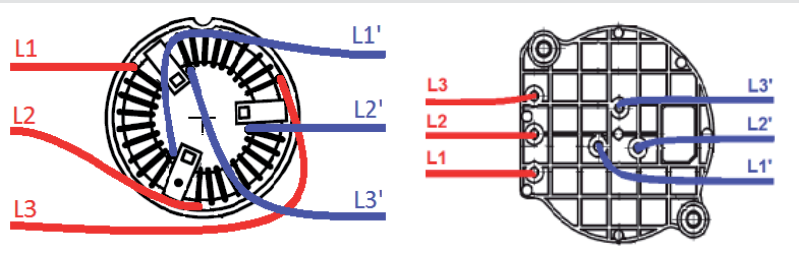

Fig. 21: left side: PCB layout with conventional horizontal 3-wire choke; right side: Layout with RB6132

Figure 21 shows on the left side a pin arrangement of conventional horizontal 3-wire chokes, where an EMC-conscious PCB layout is difficult. No broad design of the circuit path is possible and the coupling risk is high due to input output crossing. A lot of chokes also have no extra fixation possibility and the wiring is done directly on coated cores.

The horizontal 3-wire versions of RB chokes have an innovative arrangement of pins to make the PCB layout work easier. This enables sufficient space to design broad circuit paths and a clear separation of filter input and output side. All RB chokes have an outstanding insulation due to the core bobbin design and the efficient choke fixation with two screws prevents against transport and vibration damages.

To support an efficient design-in process of RB chokes for the PCB layout, 3D CAD files (format STEP) and PCB layout files (format EAGLE) are as well available from Schaffner.

Summary

EMC/EMI filter design on PCB level requires a systematic step-by-step approach for achieving the desired results. Often, common-mode choke selection is limited to the comparison of individual parameters like the inductivity, which in many cases is not sufficient. By following the recommendations in this application note, and by utilizing the RB choke evaluation boards, the overall design process and time to market can be accelerated. In addition, Schaffner field application engineers are available for individual support.

Headquarters, global innovation and development center

Schaffner Group

Nordstrasse 11
4542 Luterbach
Schweiz
T +41 32 681 66 26
F +41 32 681 66 30
info@schaffner.com
www.schaffner.com

To find your local partner within Schaffner's global network, please go to www.schaffner.com

© 2013 Schaffner Group
Specifications are subject to change within notice. The latest version of the data sheets can be obtained from the website. All trademarks recognized.

Schaffner is an ISO-registered company. Its products are designed and manufactured under the strict quality and environmental requirements of the ISO 9001 and ISO 14001 standards.

This document has been carefully checked. However, Schaffner does not assume any liability for errors or inaccuracies.

Sales and application centers

China

Schaffner EMC Ltd. Shanghai
T20-3, No 565 Chuangye Road
Pudong New Area
Shanghai 201201
T +86 21 3813 9500
F +86 21 3813 9501 / 02
cschina@schaffner.com
www.schaffner.com

Finland

Schaffner Oy
Sauvonrinne 19 H
08500 Lohja
T +358 19 35 72 71
F +358 19 32 66 10
finlandsales@schaffner.com

France

Schaffner EMC S.A.S.
112, Quai de Bezons
95103 Argenteuil
T +33 1 34 34 30 60
F +33 1 39 47 02 28
francesales@schaffner.com

Germany

Schaffner Deutschland GmbH
Schoemperlenstrasse 12B
76185 Karlsruhe
T +49 721 56910
F +49 721 569110
germanysales@schaffner.com

Italy

Schaffner EMC S.r.l.
Via Galileo Galilei, 47
20092 Cinisello Balsamo (MI)
T +39 02 66 04 30 45/47
F +39 02 61 23 943
italysales@schaffner.com

Japan

Schaffner EMC K.K.
Mitsui-Seimei Sangenjaya Bldg. 7F
1-32-12, Kamiyuma, Setagaya-ku
Tokyo 154-0011
T +81 3 5712 3650
F +81 3 5712 3651
japansales@schaffner.com
www.schaffner.jp

Singapore

Schaffner EMC Pte Ltd.
Blk 3015A Ubi Road 1
05-09 Kampong Ubi Industrial Estate
T +65 6377 3283
F +65 6377 3281
singaporesales@schaffner.com

Spain

Schaffner EMC España
Calle Caléndula 93
Miniparc III, Edificio E
El Soto de la Moraleja
Alcobendas
28109 Madrid
T +34 618 176 133
spainsales@schaffner.com

Sweden

Schaffner EMC AB
Turebergstorg 1, 6
19147 Sollentuna
T +46 8 5792 1121 / 22
F +46 8 92 96 90
swedensales@schaffner.com

Switzerland

Schaffner EMV AG
Nordstrasse 11
4542 Luterbach
T +41 32 681 66 26
F +41 32 681 66 41
sales@schaffner.ch

Taiwan

Schaffner EMV Ltd.
6th Floor, No 413
Rui Guang Road
Neihu District
Taipei City 114
T +886 2 87525050
F +886 2 87518086
taiwansales@schaffner.com

Thailand

Schaffner EMC Co. Ltd.
Northern Region Industrial Estate
67 Moo 4 Tambon Ban Klang
Amphur Muang P.O. Box 14
Lamphun 51000
T +66 53 58 11 04
F +66 53 58 10 19
thailandsales@schaffner.com

UK

Schaffner Ltd.
5 Ashville Way
Molly Millars Lane
Wokingham
Berkshire RG41 2PL
T +44 118 9770070
F +44 118 9792969
uksales@schaffner.com
www.schaffner.uk.com

USA

Schaffner EMC Inc.
52 Mayfield Avenue
Edison, New Jersey 08837
T +1 732 225 9533
F +1 732 225 4789
usasales@schaffner.com
www.schaffner.com/us