



# Application Optimization Using Cisco WAAS

Technology Design Guide

August 2014 Series



# Table of Contents

---

<b>Preface</b> .....	<b>1</b>
<b>CVD Navigator</b> .....	<b>2</b>
Use Cases .....	2
Scope .....	2
Proficiency.....	2
<b>Introduction</b> .....	<b>3</b>
Technology Use Cases .....	3
Use Case: Optimization of Traffic Traversing the WAN .....	3
Design Overview.....	3
Cisco WAAS Central Manager.....	3
WAAS Nodes .....	4
AppNav .....	5
WAN Aggregation Design Models .....	7
Remote Sites.....	10
<b>Deployment Details</b> .....	<b>14</b>
Configuring the Cisco WAAS Central Manager .....	15
Configuring the Cisco WAVE Appliance as a WAAS Node .....	22
Configuring the Cisco WAVE Appliance as an AppNav Controller .....	35
Configuring AppNav-XE on a WAN-Aggregation Router.....	51
Preparing the Cisco UCS E-Series module for vWAAS.....	61
Install VMware ESXi on the Cisco UCS E-Series module.....	73
Configuring Cisco vWAAS on the UCS E-Series module .....	104
Configuring Cisco WAAS on the Cisco Services-Ready Engine module .....	117
Configuring Cisco WAAS Express.....	127
<b>Appendix A: Product List</b> .....	<b>133</b>

<b>Appendix B: Configuration Examples</b> .....	<b>139</b>
Central Manager .....	139
WAAS Central Manager (vWAAS) .....	139
WCCP Design Model .....	141
Primary Site WAAS Node .....	141
Primary Site WAAS Node (vWAAS) .....	143
WAN-Aggregation Router .....	145
WAN-Aggregation Router (DMVPN hub) .....	147
AppNav Off Path Design Model .....	148
AppNav Controller and WAAS Node .....	148
Primary Site WAAS Node .....	152
WAN-Aggregation Router .....	154
WAN-Aggregation Router (DMVPN hub) .....	156
AppNav-XE Design Model .....	157
AppNav-XE Controller .....	157
Primary Site WAAS Node .....	160
Remote Sites .....	162
RS202 WAAS Node .....	162
RS202 WAN Router .....	165
RS240 WAAS Node (vWAAS) .....	166
RS240 WAN Router (UCS E-Series) .....	168
RS201 WAAS Node (SRE) .....	170
RS201 WAN Router (SRE) .....	172
RS204 WAASx WAN Router .....	174
<b>Appendix C: Changes</b> .....	<b>195</b>

# Preface

---

Cisco Validated Designs (CVDs) present systems that are based on common use cases or engineering priorities. CVDs incorporate a broad set of technologies, features, and applications that address customer needs. Cisco engineers have comprehensively tested and documented each design in order to ensure faster, more reliable, and fully predictable deployment.

CVDs include two guide types that provide tested design details:

- **Technology design guides** provide deployment details, information about validated products and software, and best practices for specific types of technology.
- **Solution design guides** integrate existing CVDs but also include product features and functionality across Cisco products and sometimes include information about third-party integration.

Both CVD types provide a tested starting point for Cisco partners or customers to begin designing and deploying systems.

## CVD Foundation Series

This CVD Foundation guide is a part of the *August 2014 Series*. As Cisco develops a CVD Foundation series, the guides themselves are tested together, in the same network lab. This approach assures that the guides in a series are fully compatible with one another. Each series describes a lab-validated, complete system.

The CVD Foundation series incorporates wired and wireless LAN, WAN, data center, security, and network management technologies. Using the CVD Foundation simplifies system integration, allowing you to select solutions that solve an organization's problems—without worrying about the technical complexity.

To ensure the compatibility of designs in the CVD Foundation, you should use guides that belong to the same release. For the most recent CVD Foundation guides, please visit [the CVD Foundation web site](#).

## Comments and Questions

If you would like to comment on a guide or ask questions, please use the [feedback form](#).

# CVD Navigator

The CVD Navigator helps you determine the applicability of this guide by summarizing its key elements: the use cases, the scope or breadth of the technology covered, the proficiency or experience recommended, and CVDs related to this guide. This section is a quick reference only. For more details, see the Introduction.

## Use Cases

This guide addresses the following technology use cases:

- **Optimization of Traffic Traversing the WAN**—Cisco WAN optimization is an architectural solution comprising a set of tools and techniques that work together in a strategic systems approach to provide best-in-class WAN optimization performance while minimizing its total cost of ownership.

For more information, see the “Use Cases” section in this guide.

## Scope

This guide covers the following areas of technology and products:

- Deployment of Cisco Wide Area Application Services (WAAS) Central Manager and Cisco Wide Area Virtualization Engine (WAVE) appliances
- Deployment of Virtual WAAS (vWAAS) for primary site and remote-site
- Deployment of Application Navigator (AppNav) for intelligent load distribution
- Integration of WAAS at the WAN aggregation router
- Integration of WAAS at the WAN remote-site router and switch

For more information, see the “Design Overview” section in this guide.

## Proficiency

This guide is for people with the following technical proficiencies—or equivalent experience:

- **CCNA Routing and Switching**—1 to 3 years installing, configuring, and maintaining routed and switched networks
- **VCP VMware**—At least 6 months installing, deploying, scaling, and managing VMware vSphere environments

## Related CVD Guides



MPLS WAN Technology Design Guide



VPN WAN Technology Design Guide



Application Optimization Using Cisco ISR-WAAS Technology Design Guide

To view the related CVD guides, click the titles or visit [the CVD Foundation web site](#).

# Introduction

---

Application Optimization using Cisco Wide Area Application Services (WAAS) is an essential component of the Cisco Intelligent WAN (IWAN). Cisco IWAN delivers an uncompromised user experience over any connection, allowing an organization to right-size their network with operational simplicity and lower costs.

## Technology Use Cases

The number of remote work sites is increasing, so network administrators need tools to help them ensure solid application performance in remote locations. Recent trends show that a majority of new hires are located at remote sites. These trends are tied to global expansion, employee attraction and retention, mergers and acquisitions, cost savings, and environmental concerns.

The enterprise trend toward data-center consolidation also continues. The consolidation efforts move most remote-site assets into data centers, largely to comply with regulatory mandates for centralized security and stronger control over corporate data assets.

Consolidating data centers while growing the remote-site population means that increasing numbers of remote employees access LAN-based business applications across comparatively slow WANs. With these applications growing increasingly multimedia-centric and latency-sensitive, IT and networking staffs are further challenged to keep remote-application response times on par with the experiences of users situated locally to the company's application servers in the data center. These local users enjoy multimegabit LAN speeds and are not affected by any distance-induced delay, unlike their counterparts at the other end of a WAN connection.

### Use Case: Optimization of Traffic Traversing the WAN

Application optimization can boost network performance along with enhancing security and improving application delivery. Cisco WAN Optimization is an architectural solution comprising a set of tools and techniques that work together in a strategic systems approach to provide best-in-class WAN optimization performance while minimizing its total cost of ownership.

This design guide enables the following capabilities:

- Enhanced end-user experience increasing effective bandwidth and reducing latency
- Integration into the existing Cisco WAN routers, providing a flexible deployment
- Centralized operation and management of all the organization's application optimization devices

## Design Overview

### Cisco WAAS Central Manager

Every Cisco Wide Area Application Services (Cisco WAAS) network must have one primary Cisco WAAS Central Manager device that is responsible for managing the other WAAS devices in the network. The WAAS Central Manager device hosts the WAAS Central Manager GUI, a web-based interface that allows you to configure, manage, and monitor the WAAS devices in your network. WAAS Central Manager resides on a dedicated Cisco Wide Area Virtualization Engine (WAVE) device or as a vWAAS instance (a WAAS running as a virtual machine).

The following table provides details about the Cisco WAVE sizing for Cisco WAAS Central Manager.

Table 1 - Cisco WAAS Central Manager sizing options

Device	Number of managed devices (Cisco WAAS only)	Number of managed devices (Cisco WAAS and Cisco WAAS Express)
WAVE-294-4GB	250	200
WAVE-594-8GB	1000	800
WAVE-694-16GB	2000	2000
vCM-100N	100	80
vCM-2000N	2000	2000

## WAAS Nodes

A Cisco WAAS node (WN) is a WAAS application accelerator (for instance, a Cisco WAVE appliance, Service Module-Services Ready Engine [SM-SRE] network module, or vWAAS instance, but not a WAAS Express device) that optimizes and accelerates traffic according to the optimization policies configured on the device. Table 2 provides details about the Cisco WN sizing for the WAN-aggregation site. The fan-out numbers correspond to the total number of remote-peer WNs.

A Cisco WAAS node group (WNG) is a group of WAAS nodes that services a particular set of traffic flows identified by AppNav policies.



### Reader Tip

Some Cisco product documentation may use different terminology. This guide references the most common terminology in use for consistency.

Examples:

WAAS Node (WN) = Service Node (SN)

WAAS Node group (WNG) = Service Node group (SNG)

Table 2 - WAN-aggregation Cisco WAVE appliances

Device	Max. optimized TCP connections	Max. recommended WAN link [Mbps]	Max. optimized throughput [Mbps]	Max. core fan-out [Peers]
WAVE-594-8GB	750	50	250	100
WAVE-594-12GB	1300	100	300	100
WAVE-694-16GB	2500	200	450	150
WAVE-694-24GB	6000	200	500	300
WAVE-7541	18000	500	1000	700
WAVE-7571	60000	1000	2000	1400
WAVE-8541	150000	2000	4000	2800

Table 3 - WAN-aggregation for Cisco vWAAS on Cisco UCS B-Series and Cisco UCS C-Series

Device	Max. optimized TCP connections	Max. recommended WAN link [Mbps]	Max. optimized throughput [Mbps]	Max. core fan-out [Peers]
vWAAS-750	750	50	250	100
vWAAS-1300	1300	80	300	200
vWAAS-2500	2500	200	400	300
vWAAS-6000	6000	200	400	300
vWAAS-12000	12000	310	425	1400
vWAAS-50000	50000	700	1000	2800

For comprehensive sizing and planning, please work with your Cisco account team or Cisco partner.

## AppNav

Cisco Application Navigator (AppNav) technology enables customers to virtualize WAN optimization resources by pooling them into one elastic resource in a manner that is policy based and on demand with the best available scalability and performance. It integrates transparently with Cisco WAAS physical and virtual network infrastructure and supports the capability to expand the WAN optimization service to meet future demands.

The Cisco AppNav solution is comprised of one or more Cisco AppNav Controllers, which intelligently load share network traffic for optimization to a set of resource pools built with Cisco WAAS nodes. The Cisco AppNav Controllers make intelligent flow distribution decisions based on the state of the WAAS Nodes currently providing services.

Figure 1 - WAAS AppNav Components

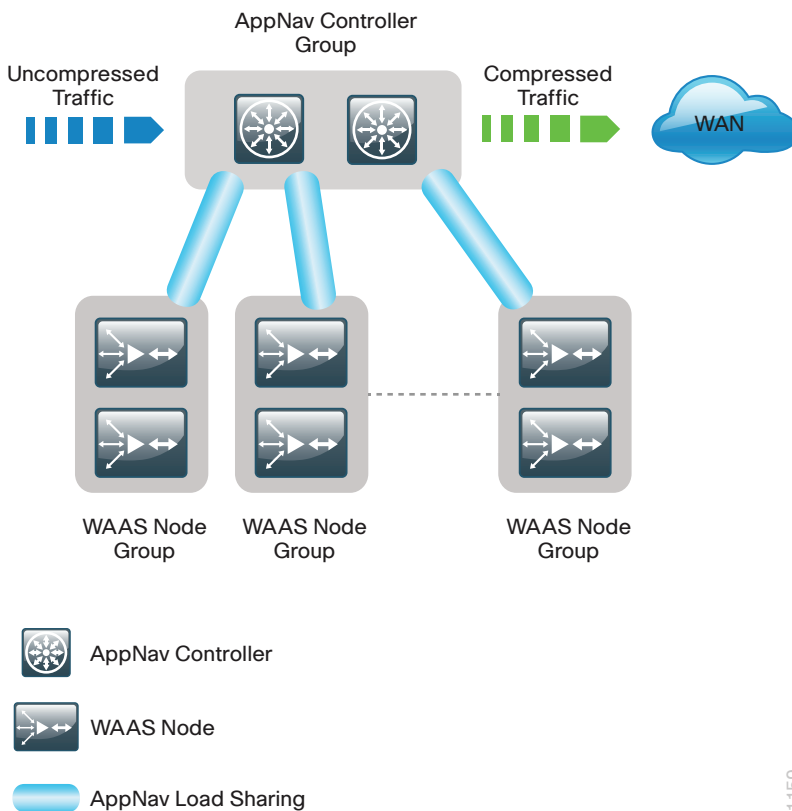



A Cisco AppNav Controller (ANC) is a WAVE appliance with a Cisco AppNav Controller I/O Module (IOM) that intercepts network traffic and, based on an AppNav policy, distributes that traffic to one or more WAAS nodes for optimization. The ANC function is also available as a component of Cisco IOS-XE software running on the Cisco ASR 1000 Series routers and the Cisco ISR 4451-X router. When the AppNav Controller is running as a router software component, it is referred to as AppNav-XE.

 **Reader Tip**

Some Cisco product documentation may use different terminology. This guide references the most common terminology in use for consistency.

Examples:

AppNav Controller (ANC) = AppNav Controller (AC)

AppNav Controller group (ANCG) = AppNav Controller group (ACG)

*Table 4 - Supported roles for Cisco WAVE appliances with a Cisco AppNav IOM*

Appliance	WAVE-APNV-GE-12T WAVE-APNV-GE-12SFP	WAVE-APNV-10GE
WAVE-594	–	AppNav Controller
WAVE-694	WAAS Node AppNav Controller	–
WAVE-7541	WAAS Node AppNav Controller	–
WAVE-7571	WAAS Node AppNav Controller	–
WAVE-8541	WAAS Node AppNav Controller	–

 **Tech Tip**

The WAVE-APNV-10GE is only available bundled with the WAVE-594 and redundant power supply unit.

A Cisco AppNav Controller group (ANCG) is a group of AppNav Controllers that share a common policy and together provide the necessary intelligence for handling asymmetric flows and providing high availability. The group of all ANC and WN devices configured together as a system is referred to as an AppNav Cluster.

 **Tech Tip**

A Cisco AppNav-XE controller group must contain only routers of the same product family and model (Example: only Cisco ASR 1002-X routers, or only Cisco ISR 4451-X routers). The ANCG may contain up to four AppNav-XE routers.

## WAN Aggregation Design Models

There are three different design models for the WAN-aggregation site. The following table provides a brief summary with more detail available in the specific sections for each design model.

Table 5 - How to choose a WAN Aggregation design model

Requirement	WAAS with WCCP design model	AppNav Off Path design model	AppNav-XE design model
AppNav IOM	Not needed	Required	Not needed
Mix of different router families	Supported	Supported	All routers in a controller group must be same product model
Maximum number of ANCs in an ANCG	Not applicable	8	4
Intelligent load sharing	Basic load sharing only	Full AppNav policies	Full AppNav policies

### WAAS node group with WCCP

The Cisco WAAS node group with WCCP design model has been the Cisco recommended design for many years prior to the introduction of AppNav. This design is widely adopted and is still currently supported by Cisco. The AppNav IOMs are not required and because the router redirection method is WCCP, this design allows for a mix of router product families. This design model is the recommended design model for remote-site deployments.

The Cisco WAAS node group with WCCP deployment model uses a single group of two or more WAAS Nodes to provide WAN optimization. The total number of devices required is a minimum of two (for N+1 resiliency).

The Cisco WAVE appliances or Cisco vWAAS instances connect to the distribution-layer switch. The connections to WAVE appliances use EtherChannel both for increased throughput and for resiliency. *EtherChannel* is a logical interface that bundles multiple physical LAN links into a single logical link. A vWAAS instance uses network interface card (NIC) teaming in order to provide resiliency. In both cases, the WAAS Nodes connect to the WAN services network that is configured on the distribution switch.

The Web Cache Communication Protocol (WCCP) is a protocol developed by Cisco. Its purpose is to transparently intercept and redirect traffic from a network device to a WCCP appliance such as a Cisco WAVE appliance running Cisco WAAS.

In this design model, WCCP is enabled on the Multiprotocol Label Switching (MPLS) CE and Dynamic Multipoint VPN (DMVPN) routers. The WCCP redirect uses service groups 61 and 62 in order to match traffic for redirection. These service groups must be used in pairs:

- Service group 61 uses the source address to redirect traffic.
- Service group 62 uses the destination address to redirect traffic.

This design uses WCCP 61 inbound on LAN-facing interfaces in order to match unoptimized data sourced from the data center that is destined for clients at the WAN remote sites. WCCP 62 is used inbound on WAN-facing interfaces, matching optimized data sourced from the WAN remote sites. WCCP 62 is used outbound on LAN interfaces for DMVPN hub routers.

The connections from the distribution switch to the WAN aggregation routers are routed point-to-point links. This design mandates the use of a negotiated-return generic routing encapsulation (GRE) tunnel from WN to router. When a design uses a GRE-negotiated return, it is not required that the WN and the WAN aggregation routers are Layer 2 adjacent.

Figure 2 - WAAS node group with WCCP design model

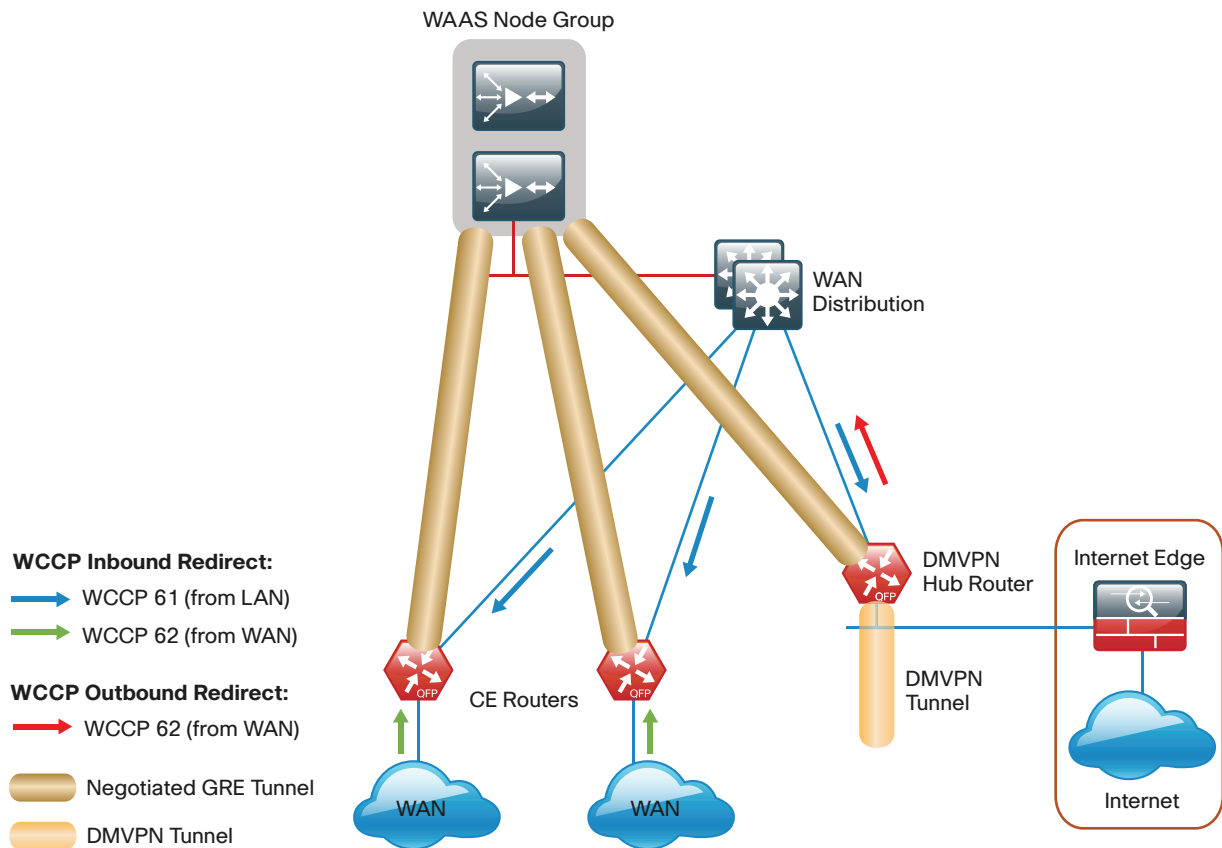

1109

## AppNav Off Path

The Cisco AppNav Off Path design model is the preferred model for new deployments.

The Cisco AppNav Off Path design model logically inserts the ANCs between the redirecting routers and the Cisco WAAS node group(s). WCCP is still used between the routers and the AppNav controllers, but the WCCP function is strictly limited to redirection and performs no load distribution. AppNav performs the intelligent load distribution.

In this design model, WCCP is enabled on the Multiprotocol Label Switching (MPLS) CE and Dynamic Multipoint VPN (DMVPN) routers. The WCCP redirect uses service groups 61 and 62 in order to match traffic for redirection, as discussed in the previous section:

- Service group 61 uses the source address to redirect traffic.
- Service group 62 uses the destination address to redirect traffic.

### Tech Tip

When using a Cisco AppNav Off Path deployment, it is possible to use just a single WCCP service group (Example: service group 61) in order to provide WCCP redirection for both source and destination traffic. However, this design model continues to use a pair of service groups for consistency and ease of migration.

The connections from the distribution switch to the WAN aggregation routers are routed point-to-point links. This design mandates the use of a generic GRE tunnel between the ANC and the routers. When a design uses a generic GRE tunnel, it is not required that the ANCs and the WAN aggregation routers are Layer 2 adjacent.

You may enable both the ANC and WN capability concurrently on a Cisco WAVE appliance when using the 1-Gbps IOMs. This allows the device to perform dual roles.

Figure 3 - AppNav off path design model

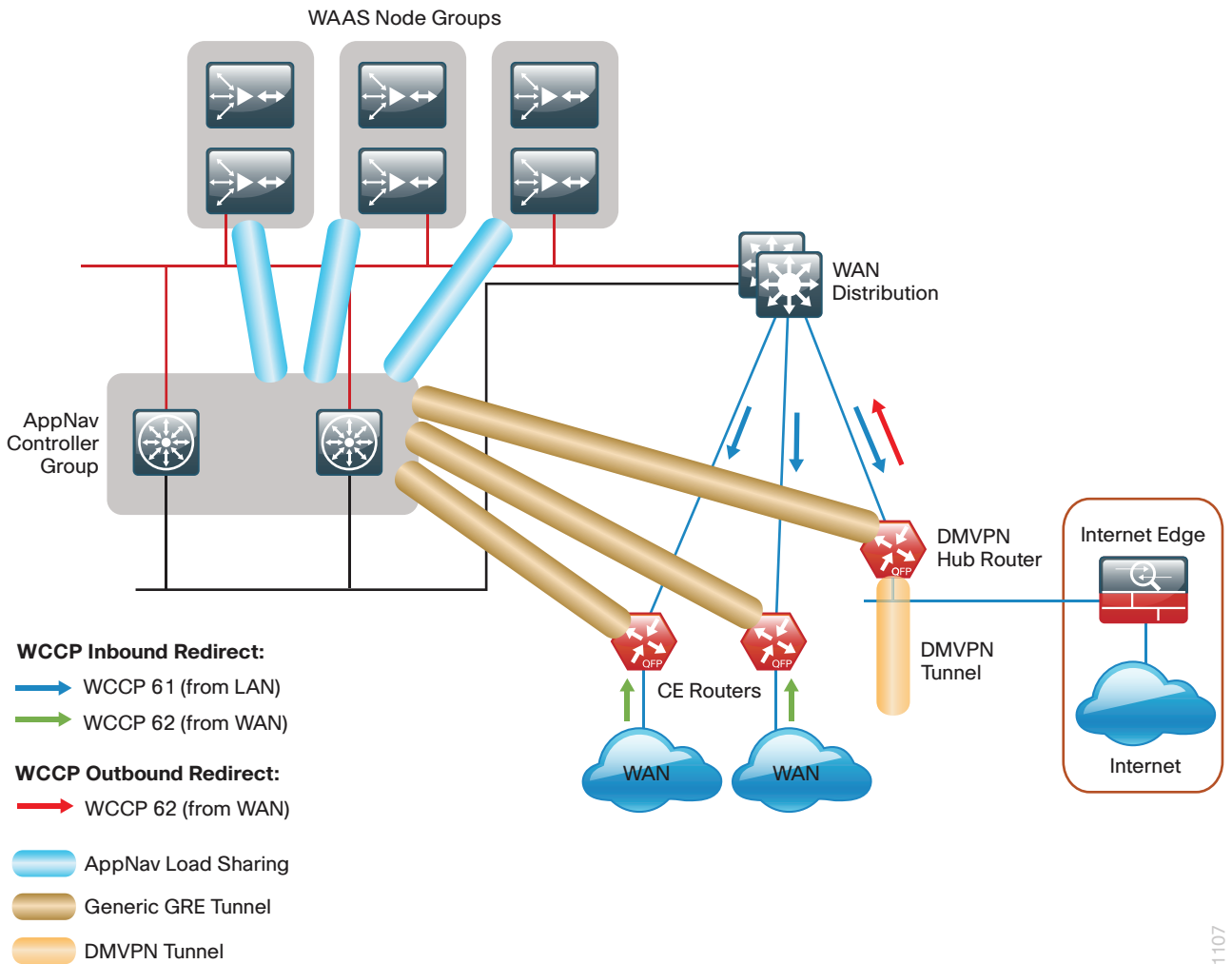

## AppNav-XE

The Cisco AppNav-XE design model allows you to deploy AppNav with an existing group of Cisco WAAS nodes without requiring the installation of IOMs. You are limited to up to four AppNav-XE Controllers, which must all be the same router model. Also, the ANCG may not include IOM-based ANCs.

The Cisco AppNav-XE deployment model uses an AppNav Controller running natively on the WAN-aggregation routers. Traffic interception is accomplished by using service insertion on the routers' WAN interfaces. WCCP is not required for this deployment model, and the ANCs and the WAN aggregation routers are not required to be Layer 2 adjacent.

Cisco AppNav performs the intelligent load sharing across the different Cisco WAAS node groups.

Figure 4 - AppNav-XE design model

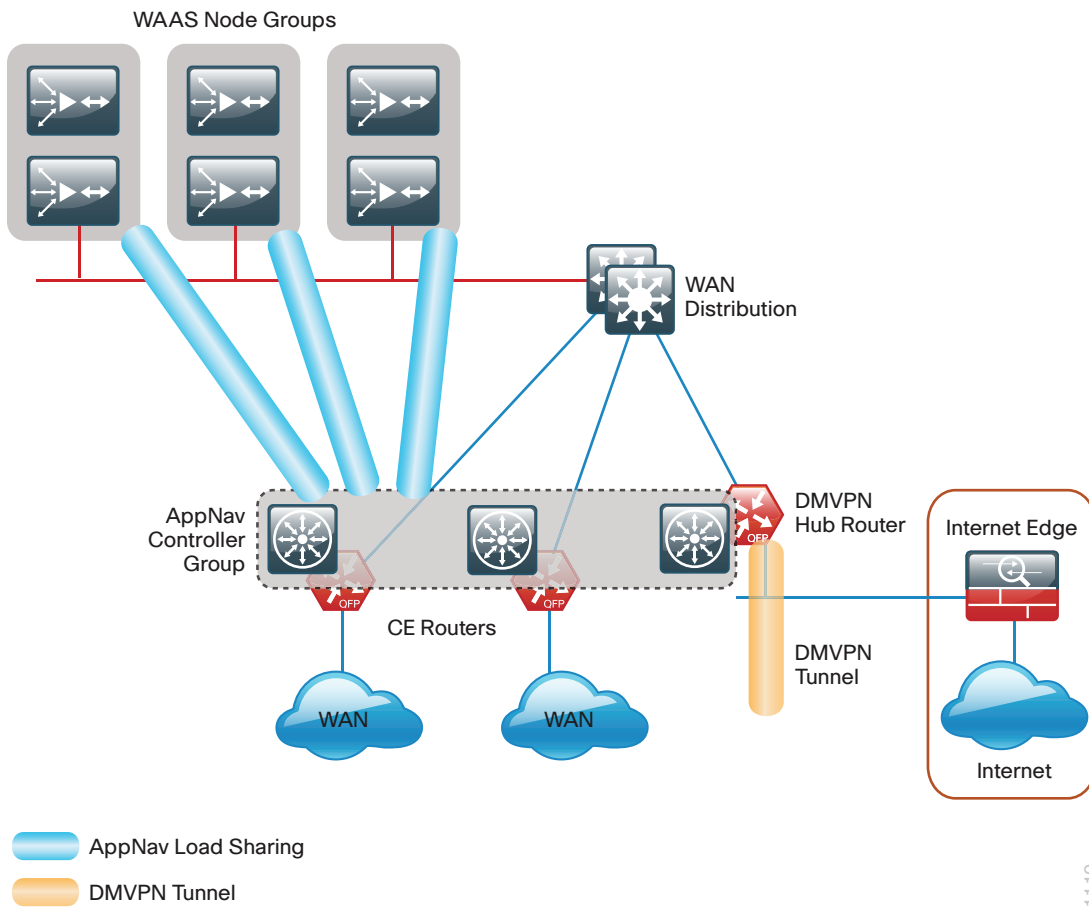

## Remote Sites

The WAN optimization design for the remote sites can vary somewhat based on site-specific characteristics. Single router sites use a single (nonredundant) Cisco WAVE appliance or Cisco vWAAS instance. Similarly, all dual-router sites use dual WAVE appliances or vWAAS instances. The specifics of the WAAS sizing and form factor primarily depend on the number of end users and bandwidth of the WAN links. Low bandwidth (< 2 Mbps) single-router, single-link sites can also use the embedded Cisco WAAS Express (WAASx) capability of the router.

There are many factors to consider in the selection of the WAN remote-site WAN optimization platform. The primary parameter of interest is the bandwidth of the WAN link. After the bandwidth requirement has been met, the next item under consideration is the maximum number of concurrent, optimized TCP connections. Additional detail on the Cisco WAVE and Cisco vWAAS sizing is provided in the following tables. The optimized throughput numbers correspond to the apparent bandwidth available after successful optimization by Cisco WAAS.

Table 6 - WAN remote-site Cisco WAVE appliances and WAAS Express

Device	Max. optimized TCP connections	Max. recommended WAN link [Mbps]	Max. optimized throughput [Mbps]
Cisco1941/WAASx <sup>1</sup>	150	4	8
SRE-710-S	200	20	200
SRE-710-M	500	20	500
SRE-910-S	200	50	200
SRE-910-M	500	50	500
SRE-910-L	1000	50	1000
WAVE-294-4GB	200	10	100
WAVE-294-8GB	400	20	150
WAVE-594-8GB	750	50	250
WAVE-594-12GB	1300	100	300
WAVE-694-16GB	2500	200	450
WAVE-694-24GB	6000	200	500

Note:

1. Single-link design only

Table 7 - WAN remote-site Cisco vWAAS on Cisco UCS E-Series

Device	Max. optimized TCP connections	Max. recommended WAN link [Mbps]	Max. optimized throughput [Mbps]
vWAAS-200	200	10	100
vWAAS-750	750	50	250
vWAAS-1300	1300	80	300
vWAAS-2500	2500	200	400

For comprehensive sizing and planning, please work with your Cisco account team or Cisco partner.

The embedded Cisco WAASx provides a subset of the full set of WAAS capabilities available on the Cisco WAVE platforms. The current WAASx software release is compatible with single-link WAN designs, cost-effective, and easy to deploy. No design or architecture changes are required to enable this functionality on the router.

Figure 5 - WAN remote-site–Cisco WAASx topology

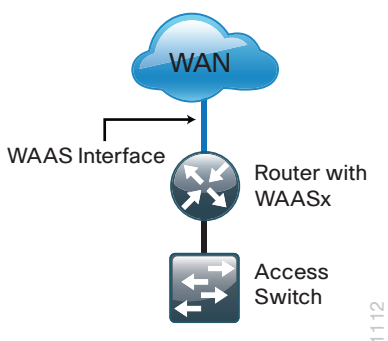

1112

The Cisco WAAS form factors for a WAN remote site include a Cisco UCS E-Series router module, Cisco Services-Ready Engine (SRE) router module and an external appliance. These variants all run the same WAAS software and are functionally equivalent. The primary difference is the method of LAN attachment for these devices:

- **Appliance**—Two interfaces (both external)
- **SRE module**—One internal interface (router-connected only), one external interface
- **UCS E-Series module**—One or two interfaces (both external)

The approach for connecting the Cisco WAVE or Cisco vWAAS devices to the LAN is to be consistent regardless of the chosen hardware form-factor. All connections are made using the external interfaces. The benefit of this method is that it is not necessary to create a dedicated network specifically to attach the WAAS devices, and the Cisco UCS E-Series module, Cisco SRE module, and appliance devices can use an identical design. The internal interface of the SRE module is not used for this design, except for the initial bootstrapping of the device configurations. The internal interface of the UCS E-Series module is not used for this design, except for the initial bootstrapping and management of the device configurations.

You must connect an external Ethernet cable from each Cisco SRE module for this solution. You must also connect one or two external Ethernet cables from each Cisco UCS E-Series module for this solution.

You should connect the Cisco WAAS devices to the data VLAN of the access switch in all flat Layer 2 designs.

When the deployment uses a distribution-layer design, the Cisco WAAS devices should connect to the primary data VLAN on the distribution switch.

Figure 6 - Cisco WAAS topology--remote-site access-layer design

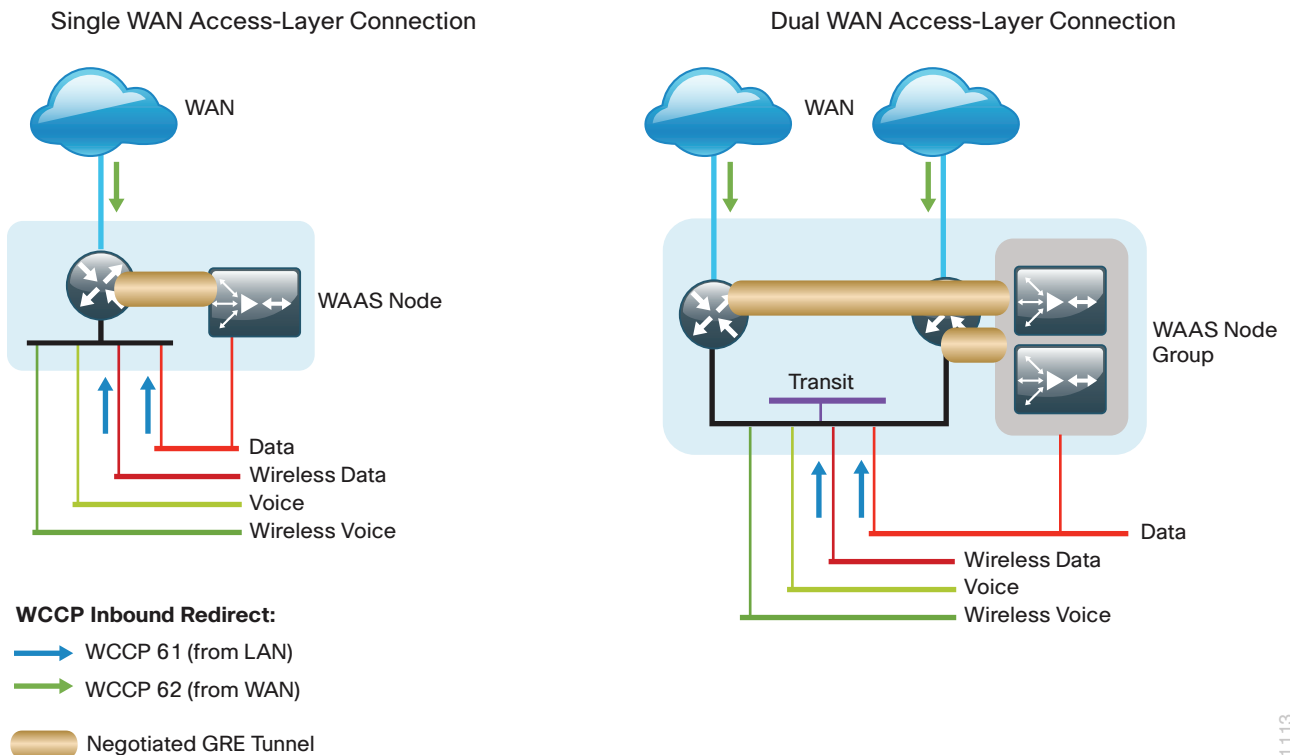

1113

Figure 7 - Cisco WAAS topology--remote-site distribution-layer design

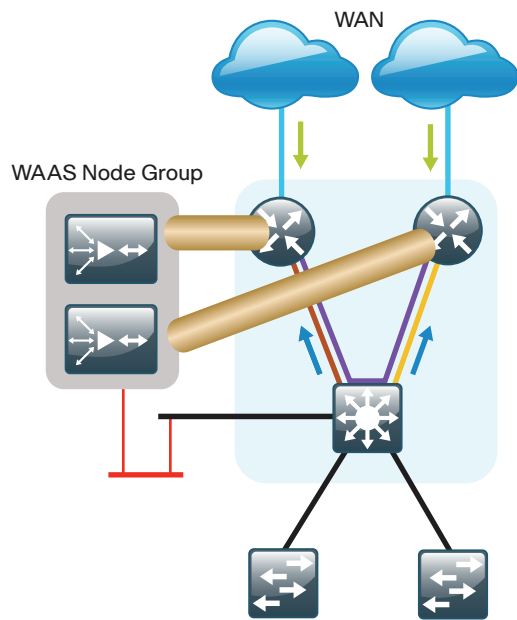

**WCCP Inbound Redirect:**

→ WCCP 61 (from LAN)

→ WCCP 62 (from WAN)

Negotiated GRE Tunnel

1114

Where possible, connect the Cisco WAVE appliances through both interfaces by using EtherChannel for performance and resiliency. A Cisco vWAAS instance uses NIC teaming to provide resiliency.

Cisco WCCP Version 2 is enabled on the WAN routers to redirect traffic to the Cisco WAAS appliances.

The WCCP redirect uses service groups 61 and 62 in order to match traffic for redirection. These services groups must be used in pairs:

- Service group 61 uses the source address to redirect traffic.
- Service group 62 uses the destination address to redirect traffic.

This design uses WCCP 61 inbound on LAN-facing VLAN subinterfaces in order to match unoptimized data sourced from the clients and destined for the data center (or other remote sites). In all cases, WCCP 62 is used inbound on WAN-facing interfaces in order to match optimized data sourced from the data center (or other remote sites).

Because the Cisco WAVE appliance is connected to the data VLAN, this design requires the use of a negotiated-return GRE tunnel from the Cisco WAVE appliances to the router. When using a GRE-negotiated return, you are not required to create a new network on the routers specifically to attach the WAVE appliances.



# Deployment Details

## How to Read Commands

This guide uses the following conventions for commands that you enter at the command-line interface (CLI).

Commands to enter at a CLI prompt:

```
configure terminal
```

Commands that specify a value for a variable:

```
ntp server 10.10.48.17
```

Commands with variables that you must define:

```
class-map [highest class name]
```

Commands at a CLI or script prompt:

```
Router# enable
```

Long commands that line wrap are underlined.

Enter them as one command:

```
police rate 10000 pps burst 10000  
packets conform-action
```

Noteworthy parts of system output (or of device configuration files) are highlighted:

```
interface Vlan64  
ip address 10.5.204.5 255.255.255.0
```

This design guide uses certain standard design parameters and references various network infrastructure services that are not located within this solution. These parameters are listed in the following table. For your convenience, you can enter your values in the table and refer to it when configuring the appliance.

Table 8 - Universal design parameters

Network service	CVD values	Site-specific values
Domain name	cisco.local	
Active Directory, DNS server, DHCP server	10.4.48.10	
Cisco Secure ACS (Optional)	10.4.48.15	
Network Time Protocol (NTP) server	10.4.48.17	
SNMP read-only community	cisco	
SNMP read-write community	cisco123	

## Configuring the Cisco WAAS Central Manager

1. Configure switch for Central Manager
2. Install the vWAAS virtual machine
3. Configure the WAAS Central Manager
4. Enable centralized AAA

The following table specifies the parameters and data, in addition to the universal design parameters, that you need in order to set up and configure the Cisco WAAS Central Manager. For your convenience, you can enter your values in the table and refer to it when configuring the appliance. The values you enter will differ from those in this example, which are provided for demonstration purposes only.

Table 9 - Cisco WAAS Central Manager network parameters

Parameter	CVD values	Site-specific values
Switch interface number	1/0/10	
VLAN number	148	
Time zone	PST8PDT - 8 0	
IP address	10.4.48.100/24	
Default gateway	10.4.48.1	
Host name	waas-wcm-1	
Management network (optional)	10.4.48.0/24	
TACACS shared key (optional)	SecretKey	

### Procedure 1 Configure switch for Central Manager

This guide assumes that the switches have already been configured. The following steps contain only the information required to complete the connection of the switch to the Cisco WAVE appliances. For full details on switch configuration, see the applicable guide: [Data Center Technology Design Guide](#) or [Server Room Technology Design Guide](#).

If you are configuring a Cisco Catalyst server room switch, complete Option 1. If you are configuring a Cisco Nexus data center switch, complete Option 2.

#### Option 1: Configure the server room switch

**Step 1:** Connect the Cisco WAVE appliance's external Ethernet port to an Ethernet port on the switch, and then return the switchport configuration to the default.

```
default interface GigabitEthernet1/0/10
```

**Step 2:** Define the switchport as an access port, and then apply quality-of-service (QoS) configuration.

```
interface GigabitEthernet1/0/10
description Link to WAAS-CM
switchport access vlan 148
switchport host
logging event link-status
macro apply EgressQoS
no shutdown
```

## Option 2: Configure the data center switch

**Step 1:** Connect the single-homed appliance to a dual-homed Cisco Fabric Extender (FEX), Define the switchport as an access port, and then apply quality-of-service (QoS) configuration.

```
interface Ethernet102/1/1
switchport access vlan 148
spanning-tree port type edge
service-policy type qos input DC-FCOE+1P4Q\_INTERFACE-DSCP-QOS
```



### Tech Tip

You must assign the Ethernet interface configuration on both data center core Cisco Nexus 5500UP switches as the appliance is dual-homed because it is on a dual-homed Cisco FEX.

## Procedure 2 Install the vWAAS virtual machine

This procedure is only required if you are using a Cisco Virtual WAAS (Cisco vWAAS) virtual machine.

Cisco vWAAS is provided as an open virtual appliance (OVA). The OVA is prepackaged with disk, memory, CPU, network interface cards (NICs), and other virtual-machine-related configuration parameters. This is an industry standard, and many virtual appliances are available in this format. Cisco provides a different OVA file for each vWAAS model.



### Tech Tip

The OVA files are available only in DVD media format and are not available for download on [www.cisco.com](http://www.cisco.com) at this time.

**Step 1:** Deploy the OVF template with the VMware vSphere client.

**Step 2:** Before you configure Cisco vWAAS, using VMware vSphere, install the vWAAS OVA on the VMware ESX/ESXi server.

**Step 3:** In the VMware console, configure the Cisco vWAAS.

The procedures and steps for configuring the Cisco vWAAS Central Manager and vWAAS Application Accelerator devices are identical to those for the Cisco WAVE appliance and Cisco SRE form factors. Apply the following procedure to complete the vWAAS configuration.

### Procedure 3 Configure the WAAS Central Manager

Use the appropriate Cisco WAVE device or Cisco vWAAS from Table 1 for the Cisco WAAS Central Manager function at the primary location in order to provide graphical management, configuration, and reporting for the Cisco WAAS network. This device resides in the server farm because it is not directly in the forwarding path of the WAN optimization, but it provides management and monitoring services. In order to initially configure the WAAS Central Manager, you must have terminal access to the console port for basic configuration options and IP address assignment. For all Cisco WAVE devices, the factory default username is **admin** and the factory default password is **default**.

#### Reader Tip

This example shows the configuration of a Cisco WAVE device. When using a vWAAS as the WAAS Central Manager, the setup options may be slightly different.

**Step 1:** From the command line, enter **setup**. The initial setup utility starts.

Parameter	Default Value
1. Device Mode	Application Accelerator
2. Interception Method	WCCP
3. Time Zone	UTC 0 0
4. Management Interface	GigabitEthernet 1/0
5. Autosense	Enabled
6. DHCP	Enabled

ESC Quit ? Help \_\_\_\_\_ WAAS Default Configuration \_\_\_\_\_  
Press 'y' to select above defaults, 'n' to configure all, <1-6> to change specific default [y]: **n**

**Step 2:** Enter option **2** to configure as **Central Manager**.

```
1. Application Accelerator
2. Central Manager
Select device mode [1]: 2
```

**Step 3:** Configure the time zone.

```
Enter Time Zone <Time Zone Hours(-23 to 23) Minutes(0-59)> [UTC 0 0]: PST8PDT -8
0
```

**Step 4:** Configure the management interface, IP address, and default gateway.

```
No.      Interface Name      IP Address      Network Mask
  1. GigabitEthernet 1/0          dhcp
  2. GigabitEthernet 2/0          dhcp
Select Management Interface [1]: 1
Enable Autosense for Management Interface? (y/n) [y]: y
Enable DHCP for Management Interface? (y/n) [y]: n
Enter Management Interface IP Address
<a.b.c.d or a.b.c.d/X(optional mask bits)> [Not configured]: 10.4.48.100/24
Enter Default Gateway IP Address [Not configured]: 10.4.48.1
```

**Step 5:** Configure the Domain Name System (DNS), host, and NTP settings.

```
Enter Domain Name Server IP Address [Not configured]: 10.4.48.10
Enter Domain Name(s) (Not configured): cisco.local
Enter Host Name (None): WAAS-WCM-1
Enter NTP Server IP Address [None]: 10.4.48.17
```

**Step 6:** Select the appropriate license.

```
The product supports the following licenses:
1. Enterprise
Enter the license(s) you purchased [1]: 1
```

**Step 7:** Verify the configuration settings, and then initiate reload.

```
Parameter                Configured Value
1. Device Mode            Central Manager
2. Time Zone              PST8PDT -8 0
3. Management Interface   GigabitEthernet 1/0
4. Autosense              Enabled
5. DHCP                  Disabled
6. IP Address             10.4.48.100
7. IP Network Mask        255.255.255.0
8. IP Default Gateway     10.4.48.1
9. DNS IP Address         10.4.48.10
10. Domain Name(s)        cisco.local
11. Host Name             WAAS-WCM-1
12. NTP Server Address    10.4.48.17
13. License               Enterprise
ESC Quit ? Help ! CLI _____ WAAS Final Configuration _____
Press 'y' to select configuration, 'd' to toggle defaults display, <1-13> to
change specific parameter [y]: y
Apply WAAS Configuration: Device Mode changed in SETUP; New configuration takes
effect after a reload. If applicable, registration with CM, CM IP address, WAAS
WCCP configuration etc, are applied after the reboot. Initiate system reload?
<y/n> [n] y
Are you sure? <y/n> [n]: y
```

Next, you will configure the device management protocols.

**Step 8:** Reboot, and then log in to the Cisco WAAS Central Manager.

**Step 9:** Generate the RSA key, and then enable the sshd service. This enables Secure Shell Protocol (SSH).

```
ssh-key-generate key-length 2048
sshd enable
no telnet enable
```

**Step 10:** Enable Simple Network Management Protocol (SNMP), which allows the network infrastructure devices to be managed by a network management system (NMS), and then configure SNMPv2c for a read-only and a read-write community string.

```
snmp-server community cisco
snmp-server community cisco123 RW
```

**Step 11:** If you want to limit access to the appliance, configure management access control lists (ACLs).

In networks where network operational support is centralized, you can increase network security by using an access list to limit the networks that can access your device. In this example, only devices on the 10.4.48.0/24 network are able to access the device via SSH or SNMP.

```
ip access-list extended 155
  permit tcp 10.4.48.0 0.0.0.255 any eq ssh
  deny tcp any any eq ssh
  permit ip any any
  exit
interface GigabitEthernet 1/0
  ip access-group 155 in
  exit
!
ip access-list standard 55
  permit 10.4.48.0 0.0.0.255
  exit
snmp-server access-list 55
```

**Step 12:** After you make configuration changes, save the configuration.

```
copy running-config startup-config
```

**Step 13:** Reboot. The Cisco WAAS Central Manager device should be up and running after the reload completes, and it should be accessible to a web browser at the IP address assigned during setup or at the associated host name if it has been configured in DNS.

## Procedure 4 Enable centralized AAA

### (Optional)

This guide assumes that Cisco Secure Access Control System (Cisco Secure ACS) has already been configured. Only the procedures required to support the integration of Cisco WAAS into the deployment are included. For details on how to configure Cisco Secure ACS, see the [Device Management Using ACS Technology Design Guide](#).

**Step 1:** Log in to the Cisco WAAS Central Manager through the web interface (for example, <https://waas-wcm-1.cisco.local:8443>) by using the default user name of **admin** and password of **default**.

Next, you will configure the Network-Admins user group. The web interface for the Cisco WAAS Central Manager requires a user group with the proper role assigned in order to authorize users from an external authentication, authorization, and accounting (AAA) database. This step must be completed before enabling AAA and can only be performed by using the web interface.

**Step 2:** In **Admin > AAA > User Groups**, click **Create**.

**Step 3:** In the **Name** box, enter a name. This name must match exactly (case sensitive) the group name used on the AAA server. For example, “Network Admins” in this implementation. Click **Submit**.

The screenshot displays the Cisco Wide Area Application Services (WAAS) web interface. The top navigation bar includes links for Home, Device Groups, Devices, AppNav Clusters, and Locations. The user is logged in as 'admin'. The breadcrumb trail shows 'Home > Admin > AAA > User Groups'. The main heading is 'Creating New User Group' with a 'Print' icon. The form is titled 'User Group Information' and contains a 'Name' field with the value 'Network Admins' and a 'Comments' text area. A note at the bottom left states 'Note: \* - Required Field'. At the bottom right, there are 'Submit' and 'Cancel' buttons.

**Step 4:** After you create the group, click the **Role Management** tab, click the **X** to assign the role, and then click **Submit**.

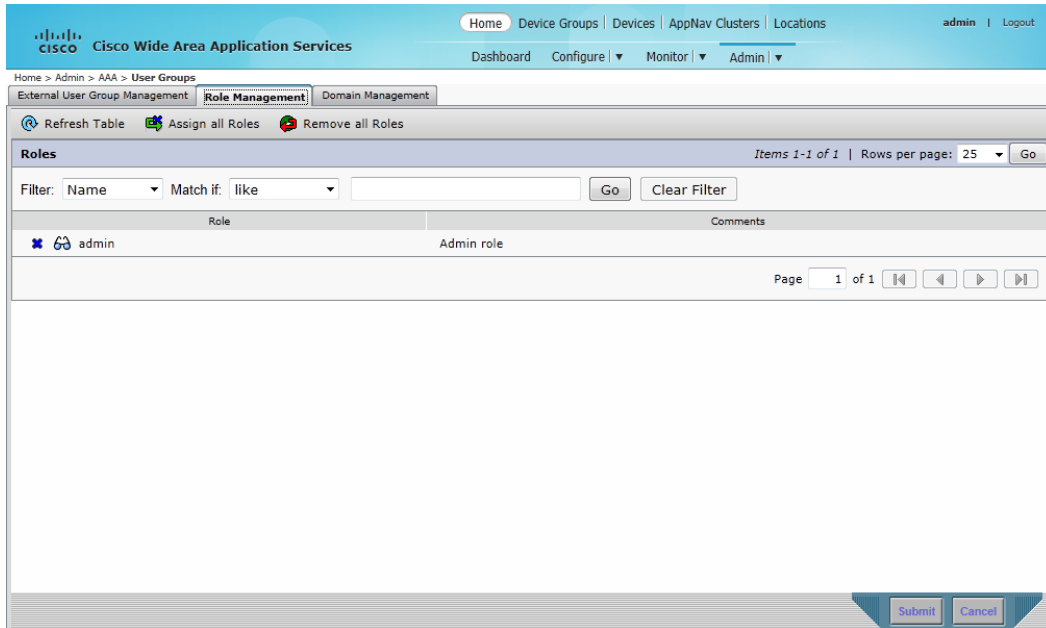

After you properly assign the role, a large, green check mark appears next to the icon.

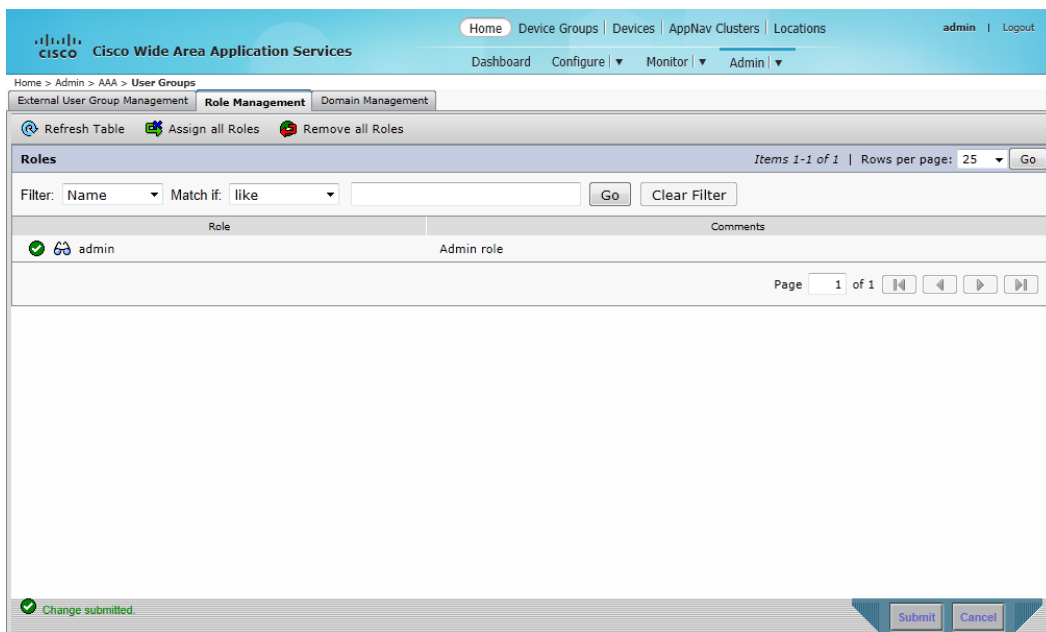

Next, you will configure secure user authentication. AAA controls all management access to the Cisco WAAS and Cisco WAVE devices (SSH and HTTPS).

A local admin user was created on the Cisco WAAS and Cisco WAVE appliances during setup. This user account provides the ability to manage the device in case the centralized TACACS+ server is unavailable or in case you do not have a TACACS+ server in your organization.





### Tech Tip

The AAA configuration details shown are for the Cisco WAAS devices only. Additional configuration is required on the AAA server for successful user authorization. Do not proceed with configuring secure user authentication until you have completed the relevant steps in the [Device Management Using ACS Technology Design Guide](#).

**Step 5:** From the command-line interface, using SSH, log in to the Cisco WAAS Central Manager by using the default user name of **admin** and password of **default**.

**Step 6:** Enable AAA authentication for access control. The following configures TACACS+ as the primary method for user authentication (login) and user authorization (configuration).

```
tacacs key SecretKey
tacacs password ascii
tacacs host 10.4.48.15 primary
!
authentication login local enable secondary
authentication login tacacs enable primary
authentication configuration local enable secondary
authentication configuration tacacs enable primary
authentication fail-over server-unreachable
```

**Step 7:** After you make configuration changes, save the configuration.

```
copy running-config startup-config
```

## PROCESS

### Configuring the Cisco WAVE Appliance as a WAAS Node

1. Configure switch for WAVE appliances
2. Configure the Cisco WAVE appliance
3. Configure WCCPv2 on routers

The following table specifies the parameters and data, in addition to the universal design parameters, that you need in order to set up and configure the Cisco WAAS network. For your convenience, you can enter your values in the table and refer to it when configuring the WAAS network. The values you enter will differ from those in this example, which are provided for demonstration purposes only.



### Tech Tip

This process should also be used for a Cisco vWAAS instance when that instance is already deployed on a VMware ESX server at the WAN-aggregation site. Specific differences are noted throughout the configuration details.

Table 10 - Cisco WAAS using Cisco WAVE Appliance network parameters

Parameter	CVD values primary WAVE	CVD values secondary WAVE	Site-specific values
Switch interface numbers	1/0/2 2/0/2	1/0/2 2/0/2	
VLAN number	350	350	
VLAN name (optional)	WAN_Service_Net	WAN_Service_Net	
Time zone	PST8PDT -8 0	PST8PDT -8 0	
IP address	10.4.32.161/26	10.4.32.162/26	
Default gateway	10.4.32.129/26	10.4.32.129/26	
WAAS Central Manager	10.4.48.100	10.4.48.100	
Hostname	WAVE-1	WAVE-2	
IP addresses of routers intercepting traffic with WCCP	10.4.32.241 10.4.32.242 10.4.32.243	10.4.32.241 10.4.32.242 10.4.32.243	
WCCP password	c1sco123	c1sco123	
Management network (optional)	10.4.48.0/24	10.4.48.0/24	
TACACS shared key (optional)	SecretKey	SecretKey	

## Procedure 1 Configure switch for WAVE appliances

There are three options for where to connect Cisco WAVE appliances. The distribution switch is the appropriate location to physically connect WAVE appliances at the WAN-aggregation site and two-tier remote sites. The access switch is the appropriate location to physically connect WAVE appliances at single-tier remote sites.

- **Distribution-layer switch**—This device type requires a resilient connection but does not require a routing protocol. This type of connection can use a Layer 2 EtherChannel link.
- **Distribution-layer switch for Cisco vWAAS**—This device type requires a resilient connection but does not require a routing protocol. This type of connection uses an active/standby port pair.
- **Remote-site access-layer switch stack or modular switch**—This type of connection can use a Layer 2 EtherChannel link.
- **Remote-site access-layer switch**—This type of connection can use a Layer 2 access interface.

This guide assumes that the switches have already been configured, so it includes only the procedures required to complete the connection of the switch to the Cisco WAVE appliances. For details on how to configure a distribution-layer switch, see [Campus Wired LAN Technology Design Guide](#).

To configure a switch for WAVE appliances, follow the steps in the applicable option:

- If you are connecting a Cisco Catalyst distribution-layer switch, complete Option 1 Connect a distribution-layer switch.
- If you are connecting a vWAAS instance to a Cisco Catalyst distribution-layer switch, complete Option 2 Connect a distribution-layer switch for vWAAS.
- If you are connecting to a remote-site Cisco Catalyst access-layer switch stack or modular switch, complete Option 3 Connect a remote-site access-layer switch stack or modular switch.
- If you are connecting to a Cisco Catalyst remote-site access-layer switch, complete Option 4 Connect a remote-site access-layer switch.

## Option 1: Connect a distribution-layer switch

**Step 1:** If a VLAN does not already exist on the distribution-layer switch, configure it now.

```
vlan 350
  name WAN_Service_Net
```

**Step 2:** Configure Layer 3. Be sure to configure a VLAN interface (SVI) for every new VLAN added so devices in the VLAN can communicate with the rest of the network.

```
interface Vlan350
  ip address 10.4.32.129 255.255.255.192
  no shutdown
```

Next, you will configure EtherChannel member interfaces.

**Step 3:** Connect the Cisco WAVE appliance EtherChannel uplinks in order to separate switches in the distribution-layer switches or stack (for the Cisco Catalyst 4507R+E distribution layer, this separates redundant modules for additional resiliency), and then configure two or more physical interfaces to be members of the EtherChannel. It is recommended that the physical interfaces are added in multiples of two. Also, apply the egress QoS macro. This ensures traffic is prioritized appropriately.

### Tech Tip

Configure the physical interfaces that are members of a Layer 2 EtherChannel prior to configuring the logical port-channel interface. Doing the configuration in this order allows for minimal configuration and reduces errors because most of the commands entered to a port-channel interface are copied to its members interfaces and do not require manual replication.

```
interface GigabitEthernet 1/0/2
  description Link to WAVE port 1
interface GigabitEthernet 2/0/2
  description Link to WAVE port 2
!
interface range GigabitEthernet 1/0/2, GigabitEthernet 2/0/2
  switchport
  macro apply EgressQoS
  channel-group 7 mode on
  logging event link-status
  logging event bundle-status
```

Next, you will configure the EtherChannel. An access-mode interface is used for the connection to the Cisco WAVE appliance.

**Step 4:** Assign the VLAN created at the beginning of the procedure to the interface. When using EtherChannel, the port channel number must match the channel group configured in Step 3.

```
interface Port-channel 7
  description EtherChannel link to WAVE
  switchport access vlan 350
  logging event link-status
  no shutdown
```

## Option 2: Connect a distribution-layer switch for vWAAS

**Step 1:** If a VLAN does not already exist on the distribution-layer switch, configure it now.

```
vlan 350
  name WAN_Service_Net
```

**Step 2:** Configure Layer 3. Be sure to configure a VLAN interface (SVI) for every new VLAN added so devices in the VLAN can communicate with the rest of the network.

```
interface Vlan350
  ip address 10.4.32.129 255.255.255.192
  no shutdown
```

Next, you will configure EtherChannel member interfaces.

**Step 3:** Connect the ESXi server ports to separate switches in the distribution-layer switches or stack (for the Cisco Catalyst 4507R+E distribution layer, this separates redundant modules for additional resiliency), and then configure two or more physical interfaces to be members of same VLAN. It is recommended that you use N+1 physical interfaces where N is the number of Cisco vWAAS instances. Also, apply the egress QoS macro. This ensures traffic is prioritized appropriately.

```
interface GigabitEthernet 1/0/12
  description Link to ESXi vmnic1
interface GigabitEthernet 2/0/12
  description Link to ESXi vmnic2
!
interface range GigabitEthernet 1/0/12, GigabitEthernet 2/0/12
  switchport
  switchport host
  switchport mode access
  switchport access vlan 350
  macro apply EgressQoS
  logging event link-status
  no shutdown
```

### Option 3: Connect a remote-site access-layer switch stack or modular switch

Next, you will configure EtherChannel member interfaces. The physical interfaces that are members of a Layer 2 EtherChannel are configured prior to configuring the logical port-channel interface. Doing the configuration in this order allows for minimal configuration and reduces errors because most of the commands entered to a port-channel interface are copied to its members' interfaces and do not require manual replication.

#### Tech Tip

*EtherChannel* is a logical interface which bundles multiple physical LAN links into a single logical link.

**Step 1:** Connect the Cisco WAVE appliance EtherChannel uplinks to separate switches in the stack, and in the case of the Cisco Catalyst 4507R+E access layer, to separate redundant modules for additional resiliency, and then configure two or more physical interfaces to be members of the EtherChannel and return their switchport configuration to the default. It is recommended that they are added in multiples of two. Also, apply the egress QoS macro. This ensures traffic is prioritized.

```
default interface GigabitEthernet 1/0/2
default interface GigabitEthernet 2/0/2
!
interface GigabitEthernet 1/0/2
  description Link to WAVE port 1
interface GigabitEthernet 2/0/2
  description Link to WAVE port 2
!
interface range GigabitEthernet 1/0/2, GigabitEthernet 2/0/2
  switchport
  macro apply EgressQoS
  channel-group 7 mode on
  logging event link-status
  logging event bundle-status
```

Next, you will configure the EtherChannel. You use an access-mode interface for the connection to the Cisco WAVE appliance.

**Step 2:** Assign the data VLAN to the interface. When using EtherChannel, the port channel number must match the channel group configured in the previous step.

```
interface Port-channel 7
  description EtherChannel link to WAVE
  switchport access vlan 64
  ip arp inspection trust
  logging event link-status
  no shutdown
```

## Option 4: Connect a remote-site access-layer switch

**Step 1:** Connect the Cisco WAVE appliance's external Ethernet port to an Ethernet port on the remote site's access switch, and then return the switchport configuration to the default.

```
default interface GigabitEthernet1/0/3
```

**Step 2:** Define the switchport in the remote-site access switch as an access port for the data VLAN, and then apply port-security and QoS configuration.

```
interface GigabitEthernet1/0/3
  description Link to WAVE
  switchport access vlan 64
  switchport host
  ip arp inspection trust
  logging event link-status
  macro apply EgressQoS
  no shutdown
```

### Procedure 2 Configure the Cisco WAVE appliance

#### Tech Tip

This procedure assumes that you are using the WAAS with WCCP design model. If you are using the AppNav off path design model or the AppNav-XE design model, WCCP is not used on the WNs. For Step 7 enter a single unused IP address (any value) and skip Step 12 and Step 13.

You can deploy a group of Cisco WAVE appliances at the WAN-aggregation site in order to provide the headend termination for Cisco WAAS traffic to and from the remote sites across the WAN. You then connect these devices directly to the distribution-layer switch, using GRE-negotiated return in order to communicate with the WCCP routers. If you don't want resiliency for application acceleration at the WAN-aggregation site, you can deploy an appliance individually, instead of in a group.

You can also deploy Cisco WAVE appliances at WAN remote sites, either individually or as part of a WNG. You should use this procedure to configure WAN remote-site Cisco WAVE appliances. You use the same setup utility that you used in the initial configuration of the Cisco WAAS Central Manager to set up WAVE appliances. These devices require only basic setup through their console port in order to assign initial settings. After you complete this setup, you can perform all management of the WAAS network through the WAAS Central Manager console. Initial configuration of the WAVE application accelerators requires terminal access to the console port for basic configuration options and IP address assignment.

The setup utility configuration steps for the application accelerator Cisco WAVE appliances are similar to the setup of the Cisco WAAS Central Manager, but the steps begin to differ after you choose application-accelerator as the device mode. After you choose this mode, the setup script changes in order to allow you to register the WAVE appliance with the existing WAAS Central Manager and to define the traffic interception method as WCCP.

For all Cisco WAVE devices, the factory default username is **admin** and the factory default password is **default**.

**Step 1:** From the command line, enter **setup**. The initial setup utility starts.

```
Parameter                Default Value
1. Device Mode            Application Accelerator
2. Interception Method    WCCP
3. Time Zone              UTC 0 0
4. Management Interface    GigabitEthernet 1/0
5. Autosense              Enabled
6.      DHCP                Enabled
ESC Quit ? Help _____ WAAS Default Configuration _____
Press 'y' to select above defaults, 'n' to configure all, <1-6> to change
specific default [y]: n
```

**Step 2:** Configure the appliance as an application accelerator.

```
1. Application Accelerator
2. AppNav Controller
3. Central Manager
Select device mode [1]: 1
```

**Step 3:** Configure the interception method.

```
1. WCCP
2. Other
Select Interception Method [1]: 1
```

**Step 4:** Configure the time zone.

```
Enter Time Zone <Time Zone Hours(-23 to 23) Minutes(0-59)> [UTC 0 0]: PST8PDT -8
0
```

**Step 5:** Configure the management interface, IP address, and default gateway.

```
No.      Interface Name      IP Address      Network Mask
1. GigabitEthernet 1/0      dhcp
2. GigabitEthernet 2/0      dhcp
Select Management Interface [1]: 1
Enable Autosense for Management Interface? (y/n)[y]: y
Enable DHCP for Management Interface? (y/n)[y]: n
Enter Management Interface IP Address
<a.b.c.d or a.b.c.d/X(optional mask bits)> [Not configured]: 10.4.32.161/26
Enter Default Gateway IP Address [Not configured]: 10.4.32.129
Enter Central Manager IP Address (WARNING: An invalid entry will cause SETUP to
take a long time when applying WAAS configuration) [None]: 10.4.48.100
```

**Step 6:** Configure the DNS, host, and NTP settings.

```
Enter Domain Name Server IP Address [Not configured]: 10.4.48.10
Enter Domain Name(s) (Not configured): cisco.local
Enter Host Name (None): WAVE-1
Enter NTP Server IP Address [None]: 10.4.48.17
```

**Step 7:** Configure the WCCP router list.

```
Enter WCCP Router (max 4) IP Address list (ip1 ip2 ...) []: 10.4.32.241  
10.4.32.242 10.4.32.243
```

**Step 8:** Select the appropriate license.

The product supports the following licenses:

1. Transport
2. Enterprise
3. Enterprise & Video
4. Enterprise & Virtual-Blade
5. Enterprise, Video & Virtual-Blade

```
Enter the license(s) you purchased [2]: 2
```

**Step 9:** Verify the configuration settings.

Parameter	Configured Value
1. Device Mode	Application Accelerator
2. Interception Method	WCCP
3. Time Zone	PST8PDT -8 0
4. Management Interface	GigabitEthernet 1/0
5. Autosense	Enabled
6. DHCP	Disabled
7. IP Address	10.4.32.161
8. IP Network Mask	255.255.255.192
9. IP Default Gateway	10.4.32.129
10. CM IP Address	10.4.48.100
11. DNS IP Address	10.4.48.10
12. Domain Name(s)	cisco.local
13. Host Name	WAVE-1
14. NTP Server Address	10.4.48.17
15. WCCP Router List	10.4.32.241 10.4.32.242 10.4.32.243
16. License	Enterprise

```
ESC Quit ? Help ! CLI _____ WAAS Final Configuration _____  
Press 'y' to select configuration, <F2> to see all configuration, 'd' to toggle  
defaults display, <1-16> to change specific parameter [y]: y  
Applying WAAS configuration on WAE ...  
May take a few seconds to complete ...
```

**Step 10:** In the EXEC mode, enable the propagation of local configuration changes to the Cisco WAAS Central Manager.

```
cms lcm enable
```



**Step 11:** If you are connecting the Cisco WAAS appliance to a distribution switch or switch stack, configure the port-channel connection and register it to the Cisco WAAS Central Manager.

```
interface GigabitEthernet 1/0
  no ip address 10.4.32.161 255.255.255.192
  exit
!
primary-interface PortChannel 1
!
interface PortChannel 1
  ip address 10.4.32.161 255.255.255.192
  exit
!
interface GigabitEthernet 1/0
  channel-group 1
  exit
interface GigabitEthernet 2/0
  channel-group 1
  no shutdown
  exit
```

There are several additional, non-default settings that you must enable on the Cisco WAVE devices in order to complete the configuration. These settings are configured in the next steps.

**Step 12:** Configure the GRE-negotiated return. All Cisco WAVE devices use GRE-negotiated return with their respective WCCP routers. Skip this step when using the AppNav Off Path design model or the AppNav-XE design model.

```
wccp tcp-promiscuous service-pair 61 62 redirect-method gre
wccp tcp-promiscuous service-pair 61 62 egress-method wccp-gre
```

**Step 13:** Configure the WCCP router list. This design uses authentication between the routers and Cisco WAVE appliances. Skip this step when using the AppNav Off Path design model or the AppNav-XE design model.

If any of the WCCP routers are Cisco ASR1000 Series routers, then change the default setting of **hash-source-ip** to **mask-assign**. This change must be made for WCCP to operate properly and is made on the Cisco WAVE appliances, not on the routers.

```
wccp tcp-promiscuous service-pair 61 62 router-list-num 7
wccp tcp-promiscuous service-pair 61 62 assignment-method mask
wccp tcp-promiscuous service-pair 61 62 password c1sco123
wccp tcp-promiscuous service-pair 61 62 enable
```

All other router platforms can use the default setting:

```
wccp tcp-promiscuous service-pair 61 62 router-list-num 7
wccp tcp-promiscuous service-pair 61 62 password c1sco123
wccp tcp-promiscuous service-pair 61 62 enable
```

Next, you will configure device management protocols.

**Step 14:** Log in to the Cisco WAVE appliance.

**Step 15:** Generate the RSA key and enable the sshd service. This enables SSH.

```
ssh-key-generate key-length 2048
sshd enable
no telnet enable
```

**Step 16:** Enable Simple Network Management Protocol (SNMP). This allows the network infrastructure devices to be managed by a Network Management System (NMS). Configure SNMPv2c for both a read-only and a read-write community string.

```
snmp-server community cisco
snmp-server community cisco123 RW
```

**Step 17:** If you want to limit access to the appliance, configure management ACLs.

In networks where network operational support is centralized, you can increase network security by using an access list to limit the networks that can access your device. In this example, only devices on the 10.4.48.0/24 network are able to access the device via SSH or SNMP.

```
ip access-list extended 155
 permit tcp 10.4.48.0 0.0.0.255 any eq ssh
 deny tcp any any eq ssh
 permit ip any any
 exit
interface [interface]
 ip access-group 155 in
 exit
!
ip access-list standard 55
 permit 10.4.48.0 0.0.0.255
 exit
snmp-server access-list 55
```

**Step 18:** If you have a centralized TACACS+ server, enable AAA authentication for access control. This configures secure user authentication as the primary method for user authentication (login) and user authorization (configuration). AAA controls all management access to the Cisco WAAS and Cisco WAVE devices (SSH and HTTPS).

### Tech Tip

A factory default local admin user was created on the Cisco WAAS and Cisco WAVE appliances during setup. This user account provides the ability to manage the device in case the centralized TACACS+ server is unavailable or if you do not have a TACACS+ server in your organization.

```
tacacs key SecretKey
tacacs password ascii
tacacs host 10.4.48.15 primary
!
authentication login local enable secondary
authentication login tacacs enable primary
authentication configuration local enable secondary
```

```
authentication configuration tacacs enable primary
authentication fail-over server-unreachable
```

**Step 19:** After you make configuration changes, in the EXEC mode, save the configuration.

```
copy running-config startup-config
```

**Step 20:** If you are deploying a group of Cisco WAVE appliances, repeat Step 1 through Step 19 for the resilient appliance.

### Procedure 3 Configure WCCPv2 on routers

This procedure assumes that you are using the WAAS with WCCP design model. If you are using a AppNav off path design model or the AppNav-XE design model, skip this procedure.

This guide assumes that the router has already been configured. Only the procedures required to support the integration of Cisco WAAS into the deployment are included. For details on how to configure a WAN router, see the [MPLS WAN Technology Design Guide](#) or [VPN WAN Technology Design Guide](#).

In this design, WCCP diverts network traffic destined for the WAN to the Cisco WAAS system for optimization. This method provides for a clean deployment with minimal additional cabling, and it requires both the WAN-aggregation and remote-site routers to be configured for WCCP.

**Step 1:** Configure global WCCP parameters, enable services 61 and 62, and then configure a group list and password. Permit only the on-site Cisco WAVE appliances in the group list in order to prevent unauthorized Cisco WAVE devices from joining the Cisco WAAS node group.

You must enable services 61 and 62 for WCCP redirect for Cisco WAAS. These services should be using WCCP Version 2. As a best practice, exempt certain critical traffic types and other protocols which cannot be optimized from WCCP redirect by using a redirect list.

*Table 11 - Critical traffic types to exempt from WCCP*

Service	TCP port number
Secure shell (SSH)	22
Telnet	23
TACACS+	49
Border Gateway Protocol (BGP)	179
Network Time Protocol (NTP)	123

Table 12 - Additional traffic types to exempt from WCCP

Service	TCP port number(s)
SNMP, SNMP trap	161, 162
SCCP, secure SCCP	2000, 2443
SIP, secure SIP	5060, 5061
H.323 gatekeeper discovery	1718
H.323 (H.225 signalling)	1720
MGCP backhaul	2428
HTTPS	443, 8443
HTTP firmware	6970
NMAP	689

Add a pair of deny statements for each TCP port listed in Table 11 and Table 12.

```

ip wccp source-interface Loopback0
ip wccp 61 redirect-list WAAS-REDIRECT-LIST group-list WAVE password cisco123
ip wccp 62 redirect-list WAAS-REDIRECT-LIST group-list WAVE password cisco123
!
ip access-list standard WAVE
 permit 10.4.32.161
 permit 10.4.32.162
ip access-list extended WAAS-REDIRECT-LIST
 remark WAAS WCCP Redirect List
 deny tcp any any eq 22
 deny tcp any eq 22 any
 deny tcp any eq telnet any
 deny tcp any any eq telnet
 deny tcp any eq tacacs any
 deny tcp any any eq tacacs
 deny tcp any eq bgp any
 deny tcp any any eq bgp
 deny tcp any any eq 123
 deny tcp any eq 123 any
 deny tcp any any eq 161
 deny tcp any eq 161 any
 deny tcp any any eq 162
 deny tcp any eq 162 any
 deny tcp any any eq 2000
 deny tcp any eq 2000 any
 deny tcp any any eq 2443
 deny tcp any eq 2443 any
 deny tcp any any eq 5060
 deny tcp any eq 5060 any
 deny tcp any any eq 5061
 deny tcp any eq 5061 any
 deny tcp any any eq 1718

```

```

deny tcp any eq 1718 any
deny tcp any any eq 1720
deny tcp any eq 1720 any
deny tcp any any eq 2428
deny tcp any eq 2428 any
deny tcp any any eq 443
deny tcp any eq 443 any
deny tcp any any eq 8443
deny tcp any eq 8443 any
deny tcp any any eq 6970
deny tcp any eq 6970 any
deny tcp any any eq 689
deny tcp any eq 689 any
permit tcp any any

```

**Step 2:** Configure WCCP redirection for traffic from the LAN. Be sure to identify specific interfaces where traffic to and from the WAN are intercepted.

Traffic from the LAN is intercepted with service 61 inbound on LAN interfaces. It is not necessary to configure WCCP interception on voice interfaces and voice VLANs.

If the LAN interface is a Layer 3 interface, define WCCP redirection on the interface directly.

```

interface Port-Channel 1
 ip wccp 61 redirect in

```

If the LAN interface is a VLAN trunk, define WCCP redirection on the data VLAN subinterface.

```

interface GigabitEthernet0/2.64
 ip wccp 61 redirect in

```

Next, you will configure WCCP redirection for traffic from the WAN.

**Step 3:** If you are configuring any Cisco WAN router, except a DMVPN hub router, intercept traffic from the WAN by using service 62 inbound on all WAN interfaces, including DMVPN tunnel interfaces (but not their underlying physical interfaces).

#### **Example: MPLS WAN Interface**

```

interface GigabitEthernet 0/3
 ip wccp 62 redirect in

```

#### **Example: DMVPN WAN Interface**

```

interface Tunnel 10
 ip wccp 62 redirect in

```

**Step 4:** If you want to configure DMVPN hub routers, configure WCCP 62 outbound on the LAN interface. This supports dynamic creation of spoke-to-spoke tunnels. Traffic from the WAN is intercepted with service 62 outbound on the LAN interfaces.

```

interface PortChannel 1
 ip wccp 62 redirect out

```

**Step 5:** After you make configuration changes, save the configuration.

```
copy running-config startup-config
```

**Step 6:** If you have multiple WAN routers at the site or multiple WAN interfaces on a single router, repeat the steps in this procedure for each WAN-facing interface.

PROCESS

## Configuring the Cisco WAVE Appliance as an AppNav Controller

1. Configure switch for WAVE appliances
2. Configure the Cisco AppNav Controller
3. Configure the AppNav cluster
4. Configure WCCPv2 on routers

The following table specifies the parameters and data, in addition to the universal design parameters, that you need in order to set up and configure the Cisco WAAS network. For your convenience, you can enter your values in the table and refer to it when configuring the WAAS network. The values you enter will differ from those in this example, which are provided for demonstration purposes only.

*Table 13 - Cisco AppNav controller WAN service network parameters*

Parameter	CVD values first ANC	CVD values second ANC	Site-specific values
Switch interface numbers	1/0/19 2/0/19	1/0/20 2/0/20	
Switch port-channel number	9	10	
VLAN number	350	350	
VLAN name (optional)	WAN_Service_Net	WAN_Service_Net	
AppNav controller interface numbers	1/0 1/1	1/0 1/1	
AppNav controller port-channel number (for intra-cluster traffic and management)	1	1	
Time zone	PST8PDT -8 0	PST8PDT -8 0	
IP address	10.4.32.163/26	10.4.32.164/26	
Default gateway	10.4.32.129/26	10.4.32.129/26	
WAAS Central Manager	10.4.48.100	10.4.48.100	
Hostname	WAVE-APPNAV-1	WAVE-APPNAV-2	
Management network (optional)	10.4.48.0/24	10.4.48.0/24	
TACACS shared key (optional)	SecretKey	SecretKey	

Table 14 - Cisco AppNav controller intercept network parameters

Parameter	CVD values primary ANC	CVD values secondary ANC	Site-specific values
AppNav interception network switch interface numbers	1/0/21 2/0/21	1/0/22 2/0/22	
Switch port-channel number	11	12	
VLAN number	349	349	
VLAN name (optional)	AppNav_Intercept_Network	AppNav_Intercept_Network	
AppNav controller interface numbers	1/2 1/3	1/2 1/3	
AppNav controller port-channel number	2	2	
IP address	10.4.32.71/26	10.4.32.72/26	
Intercept network router	10.4.32.65	10.4.32.65	
WCCP routers	10.4.32.2 10.4.32.6 10.4.32.18	10.4.32.2 10.4.32.6 10.4.32.18	
WCCP password	c1sco123	c1sco123	

## Procedure 1 Configure switch for WAVE appliances

The distribution switch is the appropriate location to physically connect the Cisco AppNav controller WAVE appliances at the WAN-aggregation site. This guide does not include details for deploying AppNav controllers at remote sites.

- **Distribution-layer switch**—This device type requires a resilient connection but does not require a routing protocol. This type of connection can use a Layer 2 EtherChannel link.

This guide assumes that the switches have already been configured, so it includes only the procedures required to complete the connection of the switch to the Cisco WAVE appliances. For details on how to configure a distribution-layer switch, see [Campus Wired LAN Technology Design Guide](#).

**Step 1:** If the VLANs do not already exist on the distribution-layer switch, configure them now.

```

vlan 350
 name WAN_Service_Net
vlan 349
 name AppNav_Intercept_Net
    
```

**Step 2:** Configure Layer 3. Be sure to configure a VLAN interface (SVI) for every new VLAN added so devices in the VLAN can communicate with the rest of the network.

```
interface Vlan350
  ip address 10.4.32.129 255.255.255.192
  no shutdown
interface Vlan349
  ip address 10.4.32.65 255.255.255.192
  no shutdown
```

Next, you will configure EtherChannel member interfaces.

### Tech Tip

*EtherChannel* is a logical interface that bundles multiple physical LAN links into a single logical link.

**Step 3:** Connect the Cisco WAVE appliance EtherChannel uplinks in order to separate switches in the distribution-layer switches or stack (for the Cisco Catalyst 4507R+E distribution layer, this separates redundant modules for additional resiliency), and then configure two or more physical interfaces to be members of the EtherChannel. It is recommended that the physical interfaces are added in multiples of two. Also, apply the egress QoS macro. This ensures traffic is prioritized appropriately.

### Tech Tip

Configure the physical interfaces that are members of a Layer 2 EtherChannel prior to configuring the logical port-channel interface. Doing the configuration in this order allows for minimal configuration and reduces errors because most of the commands entered to a port-channel interface are copied to its members interfaces and do not require manual replication.

```
interface GigabitEthernet 1/0/19
  description Link to AppNav-WAVE port 1/0
interface GigabitEthernet 2/0/19
  description Link to AppNav-WAVE port 1/1
!
interface GigabitEthernet 1/0/21
  description Link to AppNav-WAVE port 1/2 (Intercept Network)
interface GigabitEthernet 2/0/21
  description Link to AppNav-WAVE port 1/3 (Intercept Network)
!
interface range GigabitEthernet 1/0/19, GigabitEthernet 2/0/19
  switchport
  macro apply EgressQoS
  channel-group 9 mode on
  logging event link-status
  logging event bundle-status
!
interface range GigabitEthernet 1/0/21, GigabitEthernet 2/0/21
```



```
switchport
macro apply EgressQoS
channel-group 11 mode on
logging event link-status
logging event bundle-status
```

Next, you configure the EtherChannel. An access-mode interface is used for the connection to the Cisco WAVE appliance.

**Step 4:** Assign the VLANs created at the beginning of this procedure to the interface. When using EtherChannel, the port channel numbers must match the channel groups configured in Step 3.

```
interface Port-channel 9
description EtherChannel link to AppNav-WAVE
switchport access vlan 350
logging event link-status
no shutdown
!
interface Port-channel 11
description EtherChannel link to AppNav-WAVE (Intercept Network)
switchport access vlan 349
logging event link-status
no shutdown
```

## Procedure 2 > Configure the Cisco AppNav Controller

You can deploy a cluster of Cisco ANCs at the WAN-aggregation site in order to provide the headend termination for Cisco WAAS traffic to and from the remote sites across the WAN. You then connect these devices directly to the distribution-layer switch and use generic GRE tunnels in order to communicate with the WCCP routers. If you don't want resiliency for AppNav at the WAN-aggregation site, you can deploy a single ANC, instead of a cluster.

A detailed example topology is shown in the following figure.

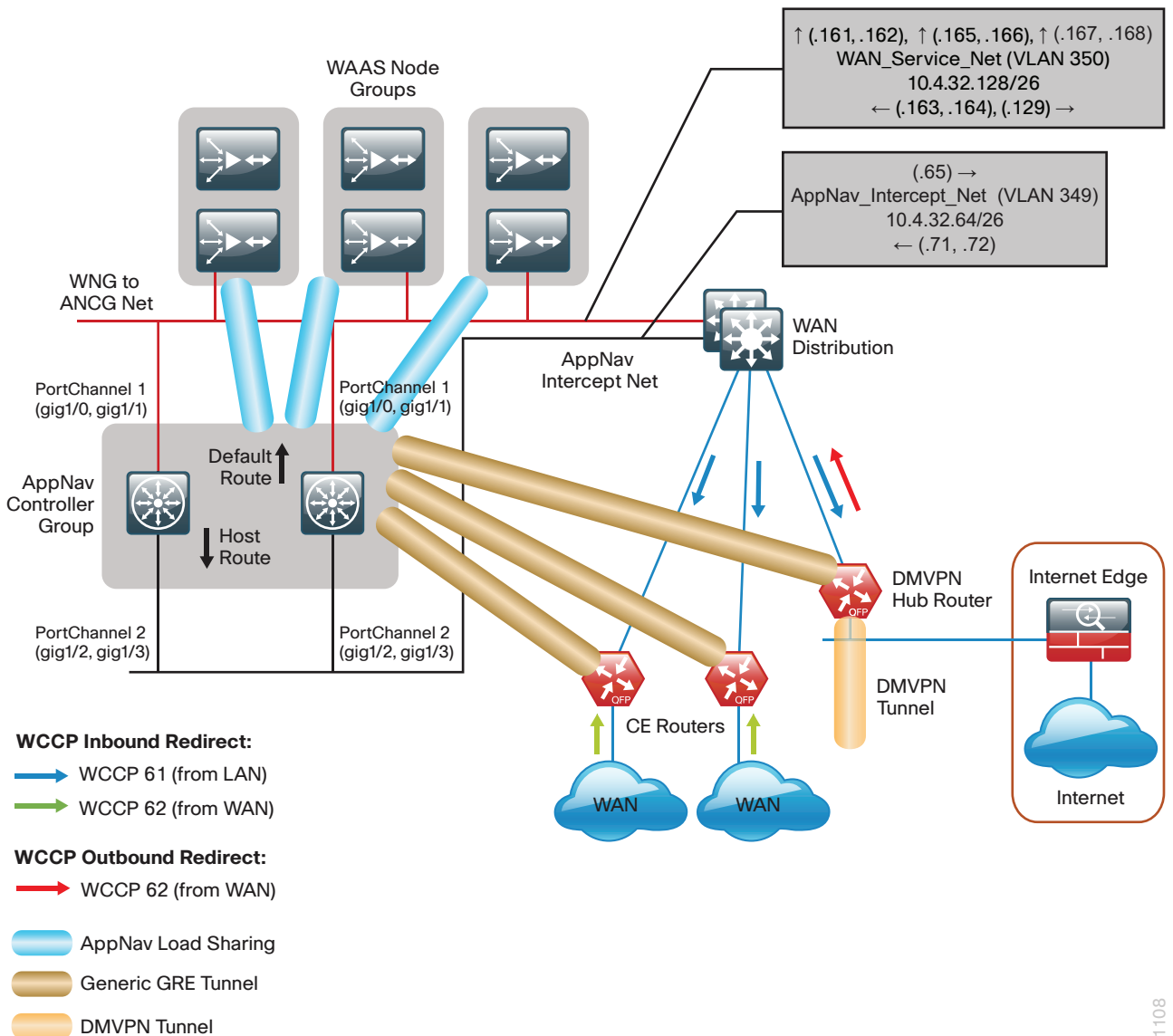

1108

You use the same setup utility that you used in the initial configuration of the Cisco WAAS Central Manager to set up ANCs. These devices require only basic setup through their console port in order to assign initial settings. After you complete this setup, you can perform all management of the WAAS network through the WAAS Central Manager console. Initial configuration of the ANC requires terminal access to the console port for basic configuration options and IP address assignment.

The setup utility configuration steps for the ANCs are similar to the setup of the Cisco WAAS Central Manager, but the steps begin to differ after you choose Cisco AppNav Controller as the device mode. After you choose this mode, the setup script changes in order to allow you to complete the configuration as an ANC.

For all Cisco WAVE devices, the factory default username is admin and the factory default password is default.

**Step 1:** From the command line, enter **setup**. The initial setup utility starts.

```
Parameter                                Default Value
1. Device Mode                            Application Accelerator
2. Interception Method                    WCCP
3. Time Zone                               UTC 0 0
4. Management Interface                   GigabitEthernet 0/0
5.     Autosense                           Enabled
6.     DHCP                                 Enabled
ESC Quit ? Help _____ WAAS Default Configuration _____
Press 'y' to select above defaults, 'n' to configure all, <1-6> to change
specific default [y]: n
```

**Step 2:** Configure the appliance as a Cisco AppNav controller.

```
1. Application Accelerator
2. AppNav Controller
3. Central Manager
Select device mode [1]: 2
Device Mode AppNav Controller selected in SETUP; New configuration takes effect
after a reload. If applicable, AppNav Controller I/O Module is recognized after
the reboot. Re-run Setup CLI to perform AppNav Controller related configuration
post reboot. Initiate system reload? <y/n> [n] y
Are you sure? <y/n> [n]:y
```

**Step 3:** After the system reloads, log in to the device again and then, from the command line, enter **setup**. The Cisco AppNav Controller setup utility starts.

```
Parameter                                Default Value
1. Device Mode                            AppNav Controller
2. Interception Method                    Inline
3. Time Zone                               UTC 0 0
4. Management Interface                   GigabitEthernet 0/0
5.     Autosense                           Enabled
6.     DHCP                                 Enabled
ESC Quit ? Help _____ WAAS Default Configuration _____
Press 'y' to select above defaults, 'n' to configure all, <1-6> to change
specific default [y]: n
```

**Step 4:** Configure the appliance as a Cisco AppNav Controller.

```
1. Application Accelerator
2. AppNav Controller
3. Central Manager
Select device mode [3]: 2
```

**Step 5:** Configure the interception method.

```
1. Inline
2. WCCP
2. Other
Select Interception Method [1]: 2
```

**Step 6:** Configure the time zone.

```
Enter Time Zone <Time Zone Hours(-23 to 23) Minutes(0-59)> [UTC 0 0]: PST8PDT -8  
0
```

**Step 7:** Configure the management interface, IP address, and default gateway.

No.	Interface Name	IP Address	Network Mask
1.	GigabitEthernet 0/0	dhcp	
2.	GigabitEthernet 0/1	unassigned	
3.	GigabitEthernet 1/0	unassigned	
4.	GigabitEthernet 1/1	unassigned	
5.	GigabitEthernet 1/2	unassigned	
6.	GigabitEthernet 1/3	unassigned	
7.	GigabitEthernet 1/4	unassigned	
8.	GigabitEthernet 1/5	unassigned	
9.	GigabitEthernet 1/6	unassigned	
10.	GigabitEthernet 1/7	unassigned	
11.	GigabitEthernet 1/8	unassigned	
12.	GigabitEthernet 1/9	unassigned	
13.	GigabitEthernet 1/10	unassigned	
14.	GigabitEthernet 1/11	unassigned	

Press <any key> to close

```
Select Management Interface [14]: 3  
Enable Autosense for Management Interface? (y/n)[y]: y  
Enter Management Interface IP Address  
<a.b.c.d or a.b.c.d/X(optional mask bits)> [Not configured]: 10.4.32.163/26  
Enter Default Gateway IP Address [Not configured]: 10.4.32.129  
Enter Central Manager IP Address (WARNING: An invalid entry will cause SETUP to  
take a long time when applying WAAS configuration) [None]: 10.4.48.100
```

**Step 8:** Configure the DNS, host, and NTP settings.

```
Enter Domain Name Server IP Address [Not configured]: 10.4.48.10  
Enter Domain Name(s) (Not configured): cisco.local  
Enter Host Name (None): AppNav-WAVE-1  
Enter NTP Server IP Address [None]: 10.4.48.17
```

**Step 9:** Select the appropriate license.

```
The product supports the following licenses:  
1. Transport  
2. Enterprise  
3. Enterprise & Video  
Enter the license(s) you purchased [2]: 2
```

**Step 10:** Verify the configuration settings.

Parameter	Configured Value
1. Device Mode	AppNav Controller
2. Interception Method	WCCP
3. Time Zone	PST8PDT -8 0
4. Management Interface	GigabitEthernet 1/0
5. Autosense	Enabled
6. DHCP	Disabled
7. IP Address	10.4.32.163
8. IP Network Mask	255.255.255.192
9. IP Default Gateway	10.4.32.129
10. CM IP Address	10.4.48.100
11. DNS IP Address	10.4.48.10
12. Domain Name(s)	cisco.local
13. Host Name	AppNav-WAVE-1
14. NTP Server Address	10.4.48.17
15. License	Enterprise

```
ESC Quit ? Help ! CLI ----- WAAS Final Configuration -----
Press 'y' to select configuration, <F2> to see all configuration, 'd' to toggle
defaults display, <1-16> to change specific parameter [y]: y
Service Context configuration, including interception settings, must be performed
using central manager .....
Please press ENTER to continue ...
Applying WAAS configuration on WAE ...
May take a few seconds to complete ...
WAAS configuration applied successfully!!
Saved configuration to memory.
Press ENTER to continue ...
```

**Step 11:** If you are connecting the Cisco WAAS appliance to a distribution switch or switch stack, configure the port-channel connection and register it to the Cisco WAAS Central Manager.

```
interface GigabitEthernet 1/0
  no ip address 10.4.32.163 255.255.255.192
  exit
!
primary-interface PortChannel 1
!
interface PortChannel 1
  ip address 10.4.32.163 255.255.255.192
  exit
!
interface GigabitEthernet 1/0
  channel-group 1
  exit
interface GigabitEthernet 1/1
  channel-group 1
  no shutdown
  exit
```

**Step 12:** Configure the port-channel connection for the AppNav intercept network.

```
interface PortChannel 2
  ip address 10.4.32.71 255.255.255.192
  exit
!
interface GigabitEthernet 1/2
  channel-group 2
  no shutdown
  exit
interface GigabitEthernet 1/3
  channel-group 2
  no shutdown
  exit
```

**Step 13:** Configure static routes for the WAN-aggregation routers.

```
ip route 10.4.32.2 255.255.255.255 10.4.32.65
ip route 10.4.32.6 255.255.255.255 10.4.32.65
ip route 10.4.32.18 255.255.255.255 10.4.32.65
```

Next, you configure device management protocols.

**Step 14:** Generate the RSA key and enable the sshd service. This enables SSH.

```
ssh-key-generate key-length 2048
sshd enable
no telnet enable
```

**Step 15:** Enable Simple Network Management Protocol (SNMP). This allows the network infrastructure devices to be managed by a Network Management System (NMS). Configure SNMPv2c for both a read-only and a read-write community string.

```
snmp-server community cisco
snmp-server community cisco123 RW
```

**Step 16:** If you want to limit access to the appliance, configure management ACLs.

In networks where network operational support is centralized, you can increase network security by using an access list to limit the networks that can access your device. In this example, only devices on the 10.4.48.0/24 network are able to access the device via SSH or SNMP.

```
ip access-list extended 155
  permit tcp 10.4.48.0 0.0.0.255 any eq ssh
  deny tcp any any eq ssh
  permit ip any any
  exit
interface PortChannel 1
  ip access-group 155 in
  exit
!
interface PortChannel 2
  ip access-group 155 in
  exit
```

```
!  
ip access-list standard 55  
  permit 10.4.48.0 0.0.0.255  
  exit  
snmp-server access-list 55
```

**Step 17:** If you have a centralized TACACS+ server, enable AAA authentication for access control. This configures secure user authentication as the primary method for user authentication (login) and user authorization (configuration). AAA controls all management access to the Cisco WAAS and Cisco WAVE devices (SSH and HTTPS).

### Tech Tip

A factory default local admin user was created on the Cisco WAAS and Cisco WAVE appliances during setup. This user account provides the ability to manage the device in case the centralized TACACS+ server is unavailable or if you do not have a TACACS+ server in your organization.

```
tacacs key SecretKey  
tacacs password ascii  
tacacs host 10.4.48.15 primary  
!  
authentication login local enable secondary  
authentication login tacacs enable primary  
authentication configuration local enable secondary  
authentication configuration tacacs enable primary  
authentication fail-over server-unreachable
```

**Step 18:** After you make configuration changes, in the EXEC mode, save the configuration.

```
copy running-config startup-config
```

**Step 19:** If your Cisco AppNav cluster includes more than one Cisco AppNav controller WAVE, repeat Step 1 through Step 19 for the resilient appliance.

## Procedure 3 Configure the AppNav cluster

This procedure is used to create the cluster and assign Cisco WAAS nodes.

### Tech Tip

This procedure assumes that one or more Cisco WAAS nodes have already been configured and are registered to the WAAS Central Manager. Any existing WCCP configuration on the WAAS nodes is overwritten by this procedure.

**Step 1:** Log in to the Cisco WAAS Central Manager through the web interface (for example, <https://waas-wcm-1.cisco.local:8443>).

**Step 2:** Navigate to **AppNav Clusters > All AppNav Clusters**.

**Step 3:** Start the configuration by starting the AppNav Cluster Wizard.

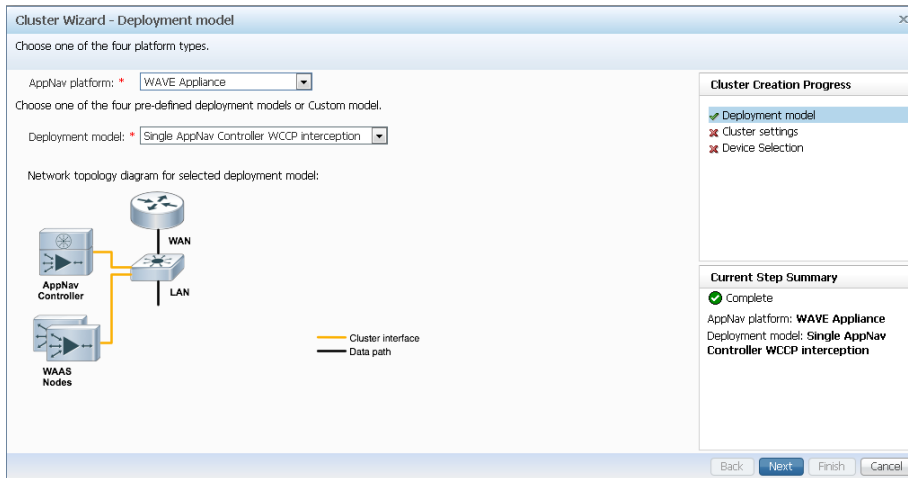

**Step 4:** Set the AppNav platform to **WAVE Appliance**, the Deployment model to **Custom**, and the Interception method to **WCCP**, and then click **Next**.

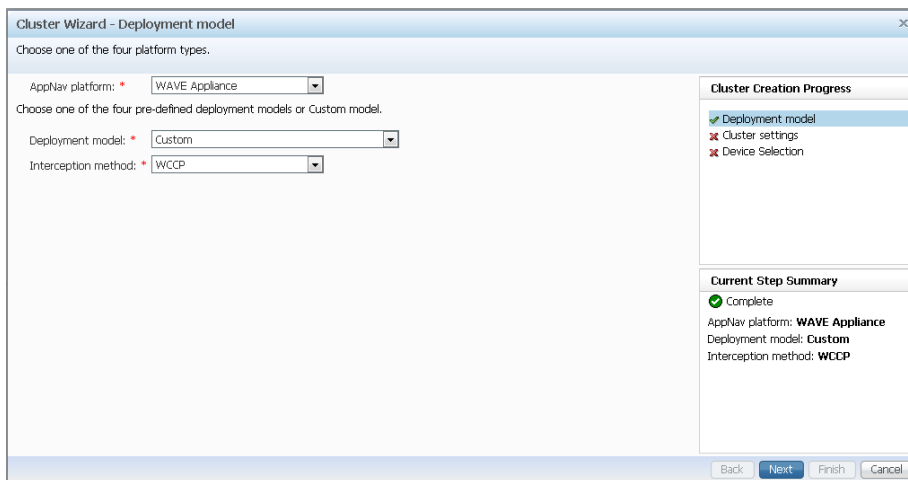



**Step 5:** Assign the Cluster Name to **AppNav-IOM**, add a description, and then click **Next**.

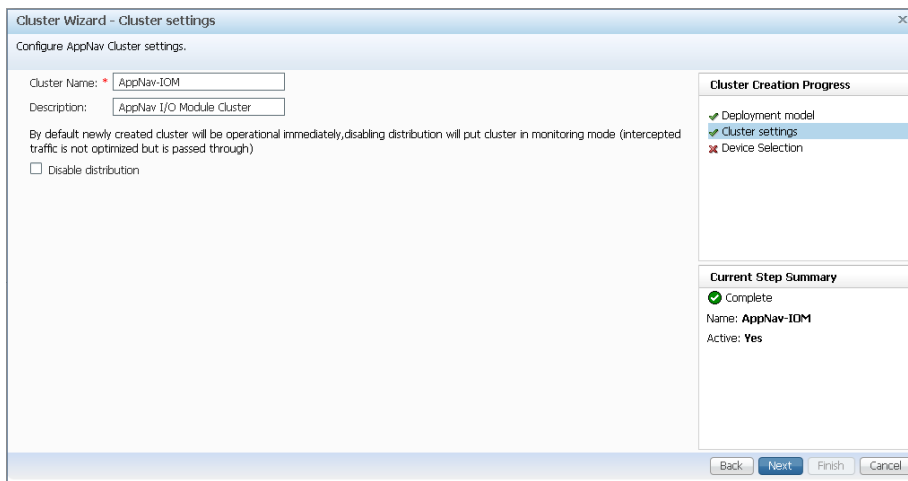

**Step 6:** Select the Cisco AppNav controllers to assign to the AppNav cluster under configuration. If you would like to use the AppNav controllers in a dual role of AppNav Controller and Application Accelerator, then also select **Enable WAN optimization on selected AppNav Controller(s)**.

If necessary, add additional dedicated Application accelerator Cisco WAAS nodes by selecting the WAAS nodes (Example: WAE-7341-1), and then clicking **Next**.

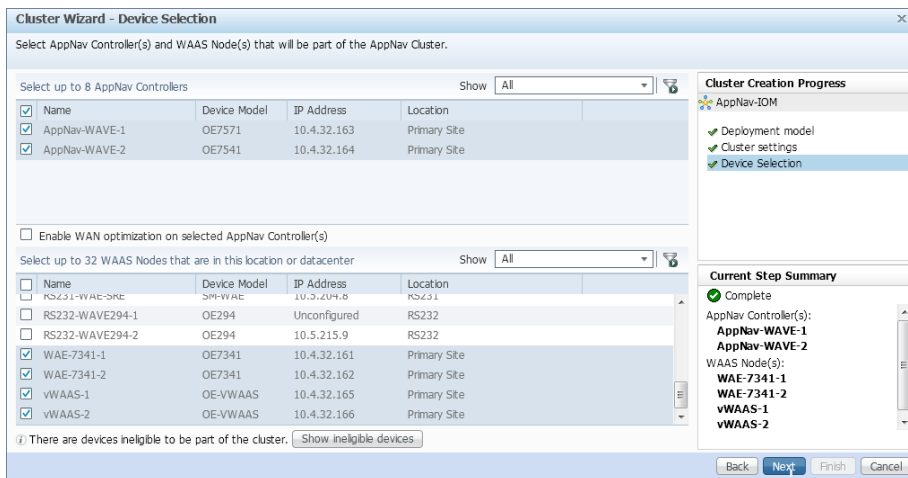

**Step 7:** Select **Enable WCCP Service**, clear **Enable Single Service Mode**, verify that Service ID1: is set to 61, set the Redirect Method to **WCCP GRE**, and then enter the IP addresses for the WCCP Routers (Example from Table 14: 10.4.32.2 10.4.32.6 10.4.32.18).

**Step 8:** Expand **Advanced WCCP settings** by clicking it, set the Password and the Confirm Password (Example from Table 14: c1sco123), and then click **Next**.

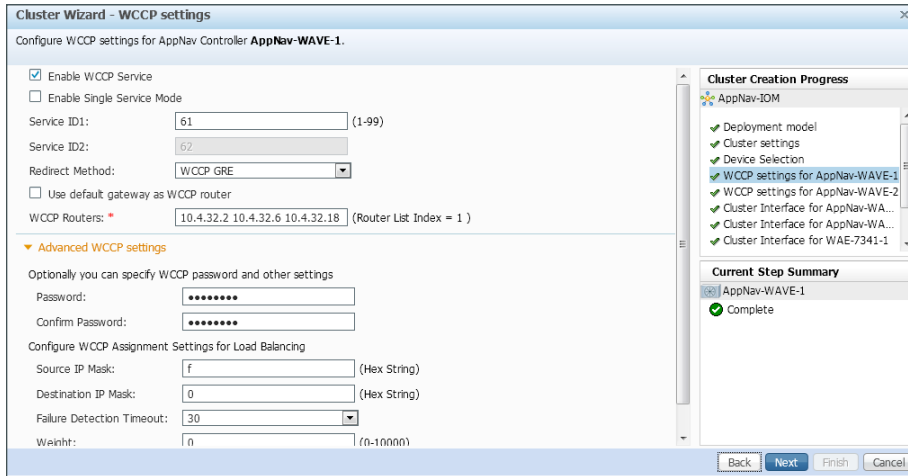

**Step 9:** If necessary, repeat Step 7 and Step 8 for additional AppNav controllers.

**Step 10:** Set the **Cluster Interface** (Example: PortChannel 1), and then click **Next**.

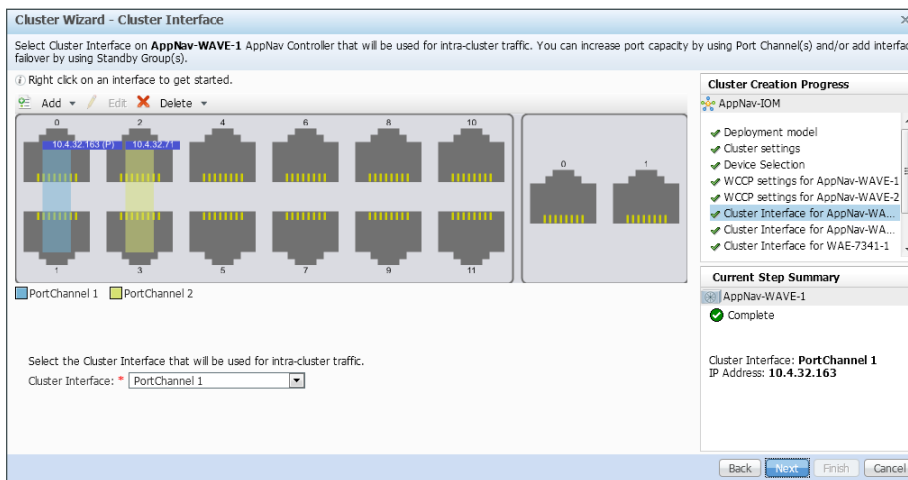

**Step 11:** Repeat Step 9 for all remaining cluster members (Cisco AppNav controllers and Cisco WAAS nodes), and then click **Finish**.

Next, configure authentication within the cluster.

**Step 12:** Navigate to **AppNav Clusters > AppNav-IOM**, enter a value for the **Authentication key:** and **Confirm authentication key:** (Example c1sco123), and then click **Submit**.

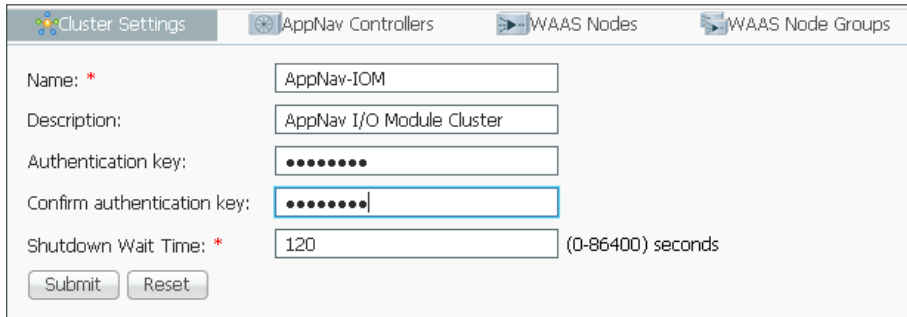

The screenshot shows a configuration interface for AppNav IOM. The fields are as follows:

- Name: AppNav-IOM
- Description: AppNav I/O Module Cluster
- Authentication key: [masked]
- Confirm authentication key: [masked]
- Shutdown Wait Time: 120 (0-86400) seconds

Buttons: Submit, Reset

#### Procedure 4 Configure WCCPv2 on routers

This guide assumes that the router has already been configured. Only the procedures required to support the integration of Cisco WAAS into the deployment are included. For details on how to configure a WAN router, see the [MPLS WAN Technology Design Guide](#) or [VPN WAN Technology Design Guide](#).

In this design, WCCP diverts network traffic destined for the WAN to the Cisco AppNav controller group for optimization. This method provides for a clean deployment with minimal additional cabling, and it requires both the WAN-aggregation routers to be configured for WCCP.

**Step 1:** Configure global WCCP parameters, enable services 61 and 62, and then configure a group list and password. Permit only the Cisco AppNav Controllers in the group list in order to prevent the use of unauthorized controllers.

You must enable services 61 and 62 for WCCP redirect for Cisco WAAS. These services should be using WCCP Version 2. As a best practice, exempt certain critical traffic types and other protocols which can not be optimized from WCCP redirect by using a redirect list. A detailed listing is included in Table 11 and Table 12.

```
ip wccp source-interface Loopback0
ip wccp 61 redirect-list WAAS-REDIRECT-LIST group-list APPNAV password c1sco123
ip wccp 62 redirect-list WAAS-REDIRECT-LIST group-list APPNAV password c1sco123
!
ip access-list standard APPNAV
 permit 10.4.32.71
 permit 10.4.32.72
!
ip access-list extended WAAS-REDIRECT-LIST
 remark WAAS WCCP Redirect List
 deny tcp any any eq 22
 deny tcp any eq 22 any
 deny tcp any any eq telnet
 deny tcp any eq telnet any
 deny tcp any any eq tacacs
 deny tcp any eq tacacs any
 deny tcp any any eq bgp
 deny tcp any eq bgp any
```

```

deny tcp any any eq 123
deny tcp any eq 123 any
deny tcp any any eq 161
deny tcp any eq 161 any
deny tcp any any eq 162
deny tcp any eq 162 any
deny tcp any any eq 2000
deny tcp any eq 2000 any
deny tcp any any eq 2443
deny tcp any eq 2443 any
deny tcp any any eq 5060
deny tcp any eq 5060 any
deny tcp any any eq 5061
deny tcp any eq 5061 any
deny tcp any any eq 1718
deny tcp any eq 1718 any
deny tcp any any eq 1720
deny tcp any eq 1720 any
deny tcp any any eq 2428
deny tcp any eq 2428 any
deny tcp any any eq 443
deny tcp any eq 443 any
deny tcp any any eq 8443
deny tcp any eq 8443 any
deny tcp any any eq 6970
deny tcp any eq 6970 any
deny tcp any any eq 689
deny tcp any eq 689 any
permit tcp any any

```

**Step 2:** Configure the generic GRE tunnel for return traffic from the Cisco AppNav controller group. You must use the physical interface as the tunnel source.

### Tech Tip

The IP address assigned to the tunnel interface is arbitrary. Cisco recommends that you use addresses assigned from the 192.0.2.0/24 network. Choose a tunnel number that is not already in use on your router.

```

interface Tunnel5
  description GRE tunnel for AppNav OffPath devices
  ip address 192.0.2.1 255.255.255.0
  no ip redirects
  ip wccp redirect exclude in
  tunnel source Port-Channel1
  tunnel mode gre multipoint
end

```

**Step 3:** Configure WCCP redirection for traffic from the LAN. Be sure to identify specific interfaces where traffic to and from the WAN are intercepted.

Traffic from the LAN is intercepted with service 61 inbound on LAN interfaces.

If the LAN interface is a Layer 3 interface, define WCCP redirection on the interface directly.

```
interface Port-Channel 1
  ip wccp 61 redirect in
```

Next, you will configure WCCP redirection for traffic from the WAN.

**Step 4:** If you are configuring any Cisco WAN router, except a DMVPN hub router, intercept traffic from the WAN by using service 62 inbound on all WAN interfaces, including DMVPN tunnel interfaces (but not their underlying physical interfaces).

**Example: MPLS WAN Interface**

```
interface GigabitEthernet 0/3
  ip wccp 62 redirect in
```

**Example: DMVPN WAN Interface**

```
interface Tunnel 10
  ip wccp 62 redirect in
```

**Step 5:** If you want to configure DMVPN hub routers, configure WCCP 62 outbound on the LAN interface. This supports dynamic creation of spoke-to-spoke tunnels. Traffic from the WAN is intercepted with service 62 outbound on the LAN interfaces.

```
interface PortChannel 1
  ip wccp 62 redirect out
```

**Step 6:** After you make configuration changes, save the configuration.

```
copy running-config startup-config
```

**Step 7:** If you have multiple WAN routers at the site or multiple WAN interfaces on a single router, repeat the steps in this procedure for each WAN-facing interface.

**Step 8:** Log in to the Cisco WAAS Central Manager through the web interface (for example, <https://waas-wcm-1.cisco.local:8443>).

Step 9: Navigate to **AppNav Clusters > AppNav-IOM** and verify that the AppNav cluster is operational.

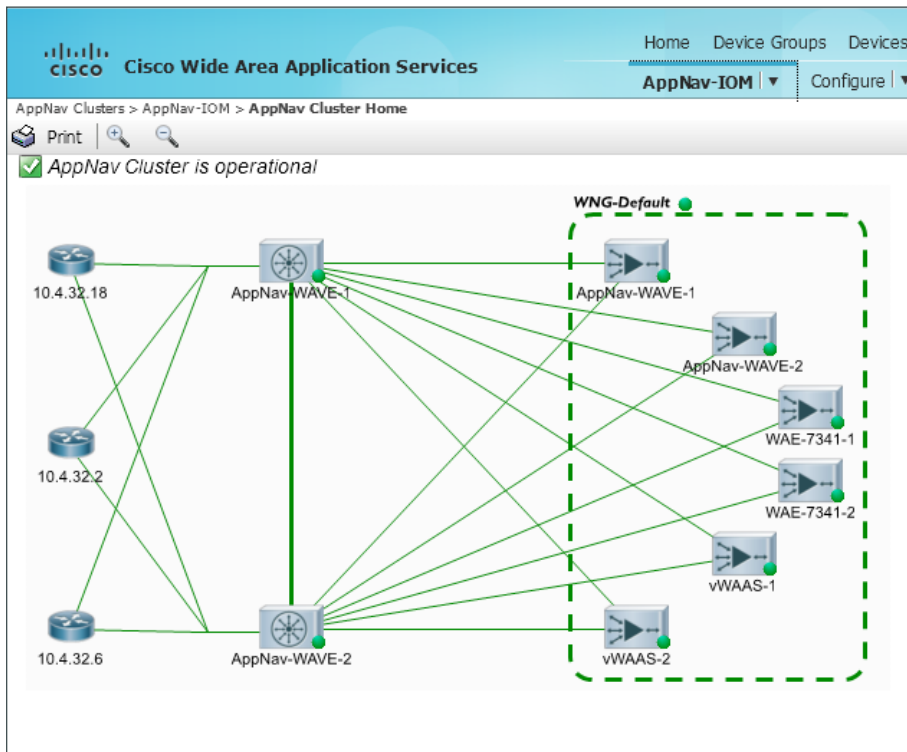

## PROCESS

### Configuring AppNav-XE on a WAN-Aggregation Router

1. Create a WAAS Central Manager user
2. Register the router to the WAAS Central Manager
3. Configure the AppNav-XE Cluster

#### Procedure 1

#### Create a WAAS Central Manager user

There are two options when you are creating the Cisco WAAS Central Manager account. If you want to create the account locally on each Cisco AppNav controller router, complete Option 1. If you want to create it once on the central AAA server, complete Option 2.

As networks scale in the number of devices to maintain, there is an operational burden to maintain local user accounts on every device. A centralized authentication, authorization and accounting (AAA) service reduces operational tasks per device and provides an audit log of user access for security compliance and root cause analysis.

Be aware that if AAA is used for router administration, centralized AAA must also be used for the Cisco WAAS Central Manager user.

## Option 1: Create a local user account

**Step 1:** Create a local user on the remote-site router.

```
username waascm privilege 15 password c1sco123
```

## Option 2: Create a centralized AAA account

The Cisco Secure ACS internal identity store can contain all the network administrator accounts or just accounts that require a policy exception if an external identity store (such as Microsoft Active Directory) is available. A common example of an account that would require an exception is one associated with a network management system that allows the account to perform automated configuration and monitoring.

**Step 1:** Navigate and log in to the Cisco Secure ACS Administration page. (Example: <https://acs.cisco.local>)

**Step 2:** Navigate to **Users and Identity Stores > Internal Identity Stores > Users**.

**Step 3:** Click **Create**.

**Step 4:** Enter a name, description, and password for the user account. (Example: user name waascm and password c1sco123)

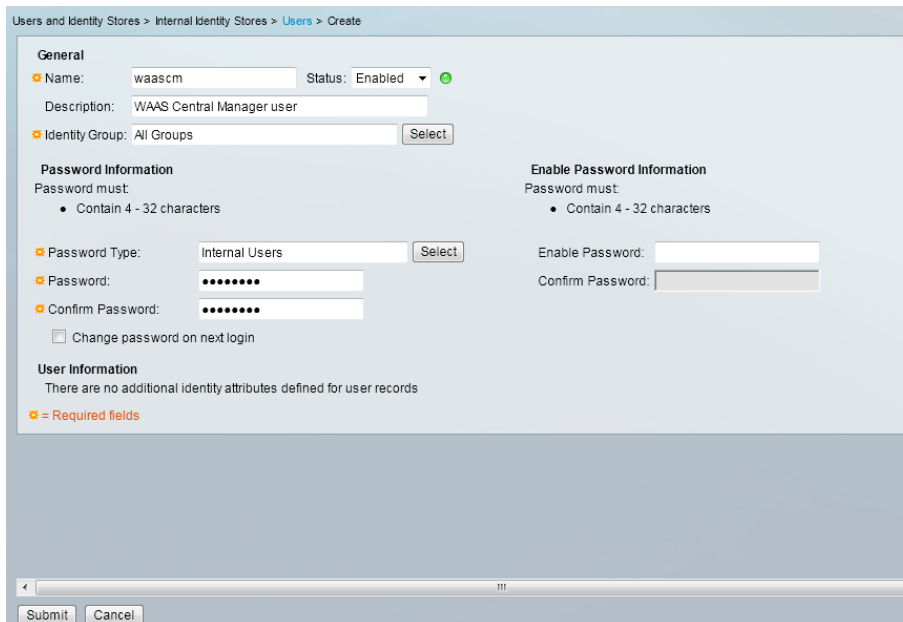

The screenshot displays the 'Create' user form in the Cisco Secure ACS Administration interface. The breadcrumb navigation at the top reads 'Users and Identity Stores > Internal Identity Stores > Users > Create'. The form is divided into several sections:

- General:** Includes a 'Name' field with the value 'waascm', a 'Status' dropdown set to 'Enabled', a 'Description' field with the value 'WAAS Central Manager user', and an 'Identity Group' dropdown set to 'All Groups' with a 'Select' button.
- Password Information:** Contains a 'Password must' section with a bullet point 'Contain 4 - 32 characters'. It includes a 'Password Type' dropdown set to 'Internal Users' with a 'Select' button, and fields for 'Password', 'Confirm Password', and 'Enable Password' (all masked with dots). There is also a 'Change password on next login' checkbox.
- Enable Password Information:** Contains a 'Password must' section with a bullet point 'Contain 4 - 32 characters' and a 'Confirm Password' field.
- User Information:** A section stating 'There are no additional identity attributes defined for user records'.

At the bottom of the form, there is a legend indicating that an orange asterisk (\*) denotes 'Required fields'. The form concludes with 'Submit' and 'Cancel' buttons.

**Step 5:** To the right of Identity Group, click **Select**.

**Step 6:** Select **Network Admins**, and then click **OK**.

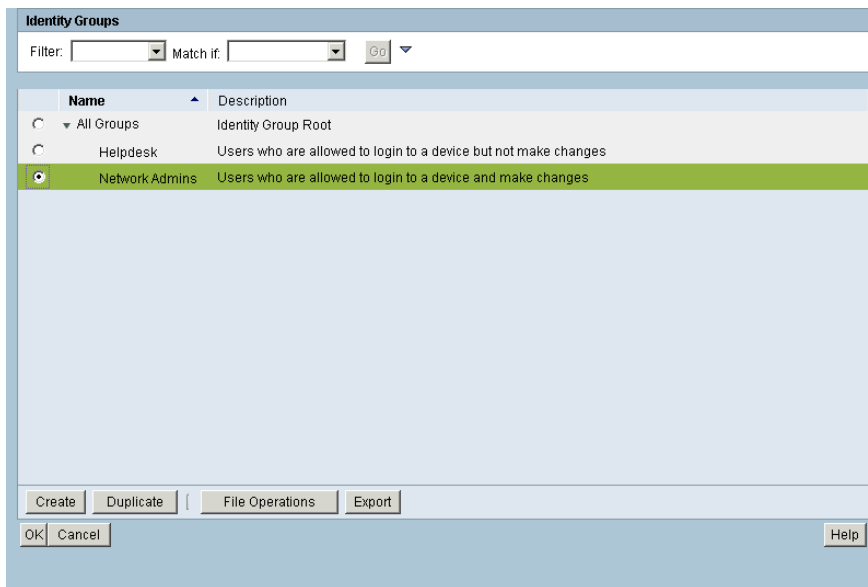

**Step 7:** Click **Submit**.

## Procedure 2 Register the router to the WAAS Central Manager

**Step 1:** Verify SSH and HTTPS servers are enabled on the router. If not already configured, configure these services now.



### Reader Tip

Secure HTTP (HTTPS) and Secure Shell (SSH) are secure replacements for the HTTP and Telnet protocols. They use Secure Sockets Layer (SSL) and Transport Layer Security (TLS) to provide device authentication and data encryption.

Secure management of the network device is enabled through the use of the SSH and HTTPS protocols. Both protocols are encrypted for privacy and the nonsecure protocols, Telnet and HTTP, are turned off.

Specify the transport preferred none on vty lines to prevent errant connection attempts from the CLI prompt. Without this command, if the ip name-server is unreachable, long timeout delays may occur for mistyped commands.

```
ip domain-name cisco.local
no ip http server
ip http secure-server
ip scp server enable
line vty 0 15
  transport input ssh
  transport preferred none
```



**Step 2:** If you are using AAA authentication, configure the HTTP server to use AAA.

```
ip http authentication aaa
```

**Step 3:** Log in to the Cisco WAAS Central Manager through the web interface (for example, <https://waas-wcm-1.cisco.local:8443>).

**Step 4:** Navigate to **Admin>Registration>Cisco IOS Routers**.

The screenshot shows the Cisco Wide Area Application Services (WAAS) Central Manager web interface. The page title is "Cisco IOS Router Registration". The navigation bar includes "Home", "Device Groups", "Devices", "AppNav Clusters", and "Locations". The breadcrumb trail is "Home > Admin > Registration > Cisco IOS Routers". The registration form includes the following fields and options:

- Router IP address entry method:  Manual  Import CSV file
- IP Address(es):  (Note: Comma separated list up to 50 entries)
- Username:
- Password:
- Enable Password:
- HTTP Authentication Type:
- Central Manager IP Address:  (Note: Update the Central Manager IP Address if NATed environment is used.)

Below the form, there are three buttons: "Register", "Retry", and "Reset". A table titled "Registration Status" is shown below the buttons, with columns for "IP Address", "Hostname", "Router type", "Status", and "Total 0". The table currently displays "No data available".

**Step 5:** Enter the management information of the WAN-aggregation routers running Cisco AppNav-XE, and then click **Register**. You may enter the IP addresses of multiple routers (separated by a comma) if they share the same authentication credentials.

- Router IP address entry method—**Manual**
- IP Address(es)—**10.4.32.245**
- Username—**waascm**
- Password—**c1sco123**
- Enable Password—**c1sco123**
- HTTP Authentication Type—**AAA**
- Central Manager IP Address—**10.4.48.100**

**Step 6:** Verify successful registration.

Registration Status			
IP Address	Hostname	Router type	Status
10.4.32.245	METRO-ASR1001-1	AppNav-XE Controller	✔ Successfully processed the registration request

**Step 7:** If necessary, repeat Step 5 and Step 6 for additional routers.

### Procedure 3 Configure the AppNav-XE Cluster

This procedure is used to create the cluster and assign Cisco WAAS nodes.

#### Tech Tip

This procedure assumes that one or more Cisco WAAS nodes have already been configured and are registered to the WAAS Central Manager. Any existing WCCP configuration on the WAAS nodes is overwritten by this procedure.

**Step 1:** Log in to the Cisco WAAS Central Manager through the web interface (for example, <https://waas-wcm-1.cisco.local:8443>).

**Step 2:** Navigate to **AppNav Clusters > All AppNav Clusters**.

**Step 3:** Start the configuration by clicking on the AppNav Cluster Wizard.

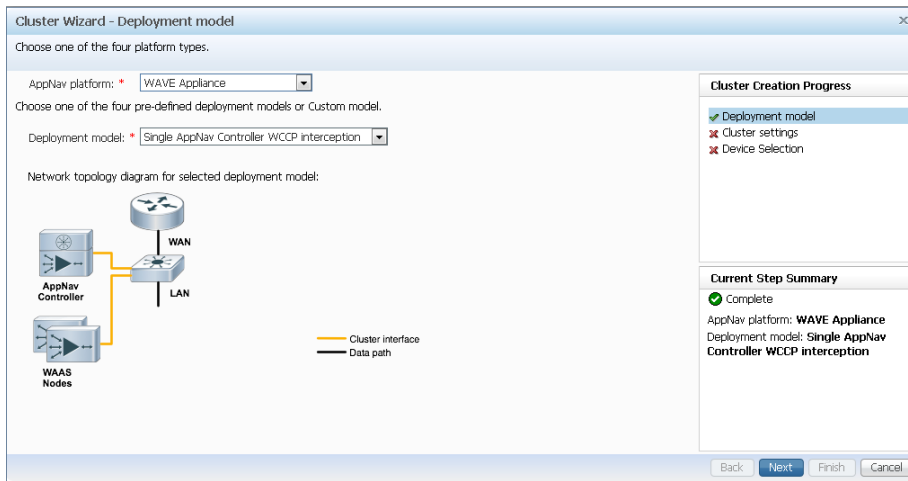

**Step 4:** Set the Cisco AppNav platform to **ASR 1000 Series**, and then click **Next**.

**i Tech Tip**

A Cisco AppNav-XE cluster must contain only routers of the same product family and model (Example: only Cisco ASR 1002-X routers, or only Cisco ISR 4451-X routers).

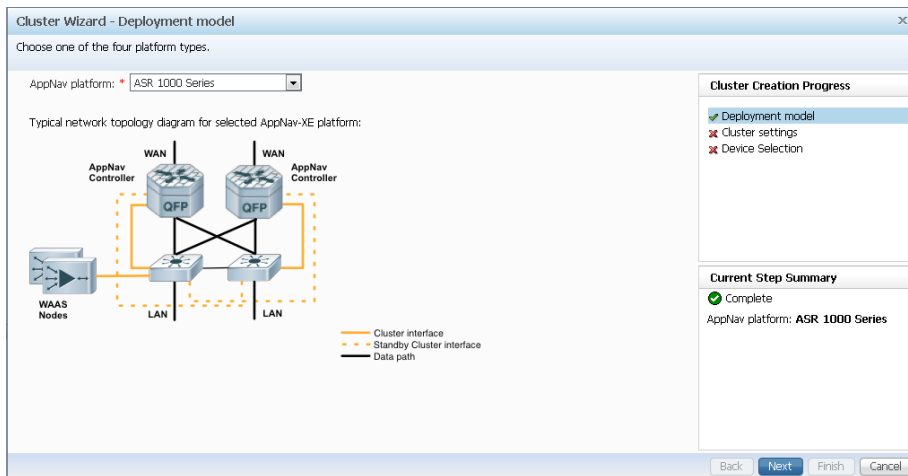

**Step 5:** Assign the Cluster Name to **AppNav-XE**, and then add a description.

**Step 6:** Select the default setting of **waas/1** for the WAAS Cluster ID, and then click **Next**.

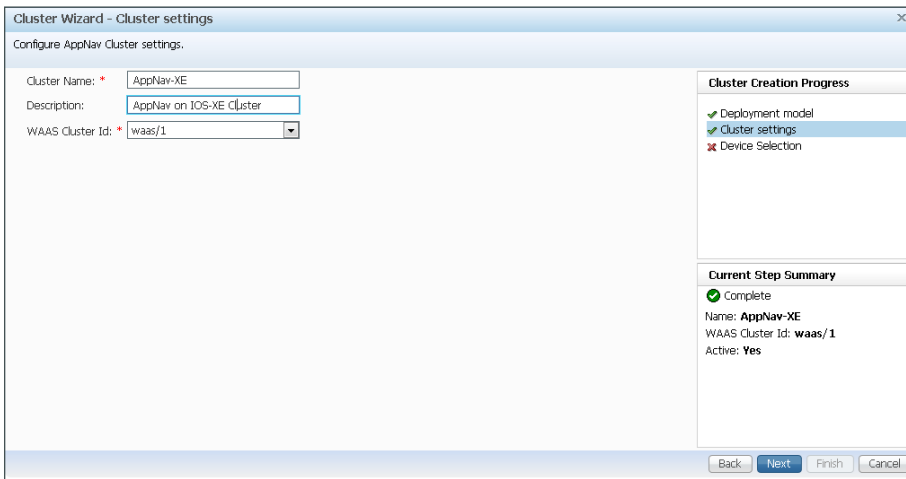

**Step 7:** Select Cisco AppNav-XE controllers (maximum of 4) to assign to the AppNav cluster under configuration.

**Step 8:** Add application accelerator Cisco WAAS nodes by selecting the WAAS nodes (Example: WAE-7341-2). After selecting all devices, click **Next**.

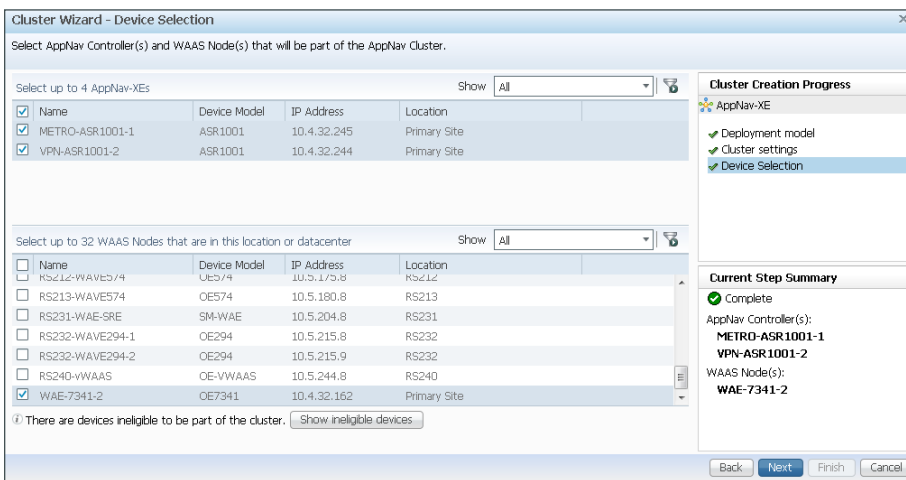

**Step 9:** Clear VRF default, select VRF global, and then click Next.

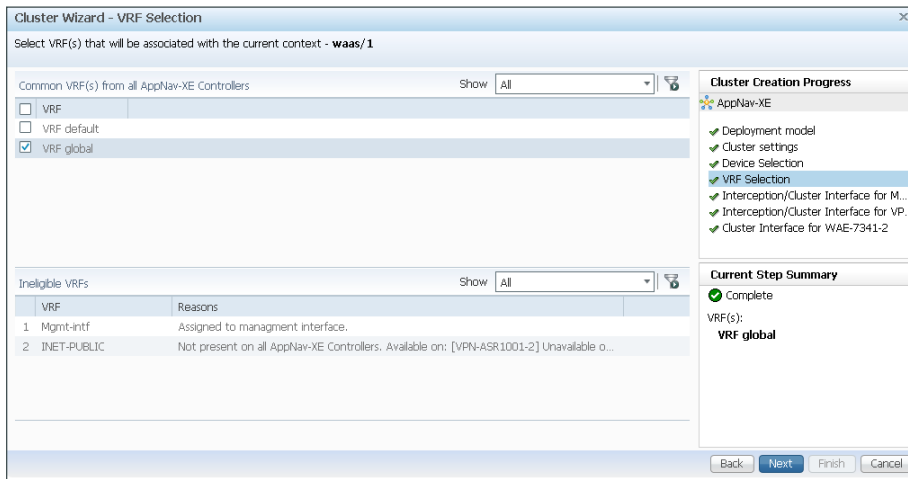

**Step 10:** Select all WAN-facing interfaces for interception, select the LAN-facing interface as the Cluster Interface for intra-cluster traffic, and then click **Next**. Example settings are shown in the following table.

i
**Tech Tip**

An AppNav-XE cluster may contain a maximum of four AppNav controllers.

*Table 15 - Example Settings for Interception and Cluster Interfaces*

Router	WAN transport	Interception interface(s)	Cluster Interface
CE-ASR1002X-1	MPLS-A	Gig0/0/3	Port-Channel1
CE-ASR1001-2	MPLS-B	Gig0/0/3	Port-Channel2
VPN-ASR1002X-1	DMVPN-1	Tunnel10	Port-Channel3
VPN-ASR1001-2	DMVPN-2	Tunnel10	Port-Channel4
METRO-ASR1001-1	Layer 2 WAN	Gig0/0/3.38 Gig0/0/3.39	Port-Channel5

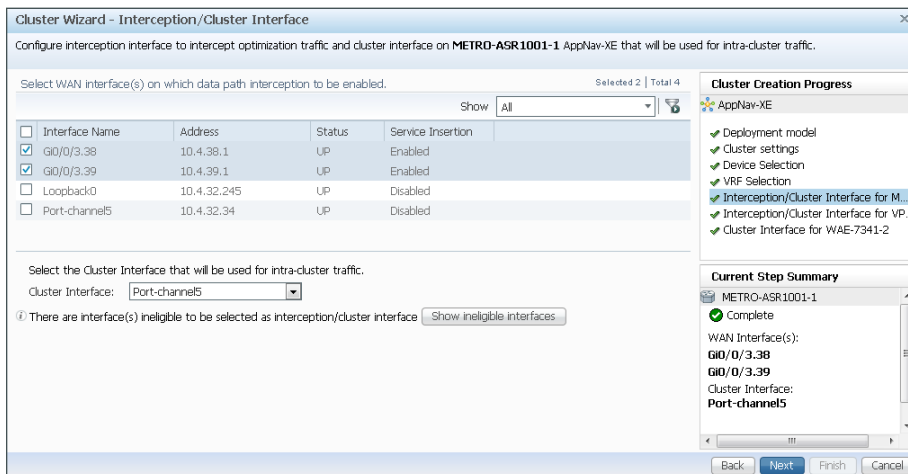

**Step 11:** If necessary, repeat Step 10 for any additional Cisco AppNav-XE controller routers.

**Step 12:** Select the Cluster Interface for the Cisco WAAS node to use for intra-cluster traffic (Example: PortChannel 1). If this is the last WAAS node, click **Finish**, otherwise click **Next**.

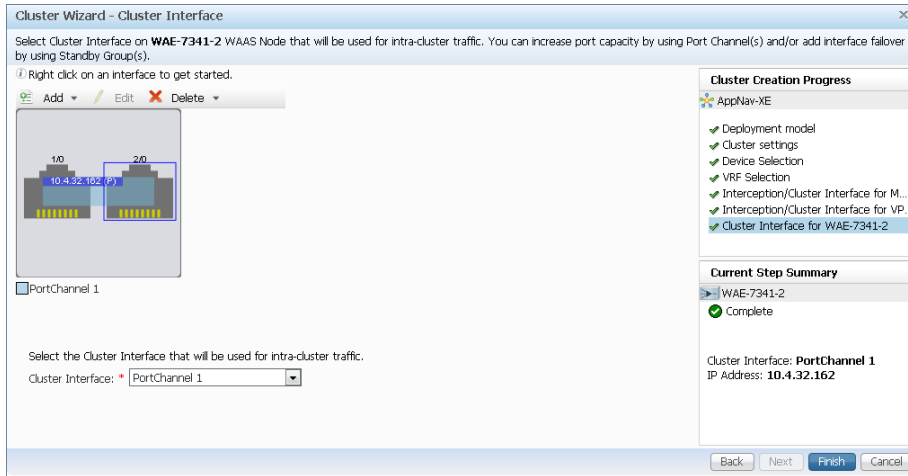

**Step 13:** Repeat Step 12 for any additional WAAS nodes if necessary.

**Step 14:** Navigate to **AppNav Clusters > AppNav-XE**, enter a value for the **Authentication key** and **Confirm authentication key** (Example c1sco123), and then click **Submit**. Authentication with the cluster is configured.

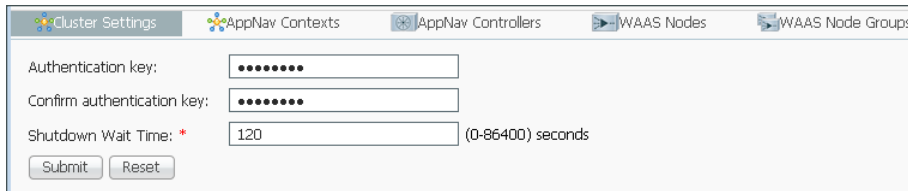

**Step 15:** Navigate to **AppNav Clusters > AppNav-XE** and verify that the Cisco AppNav cluster is operational.

The default Cisco AppNav policy includes video acceleration and the Cisco WAAS Central Manager indicates that the AppNav cluster is degraded if any of the WAAS nodes do not have a video license.

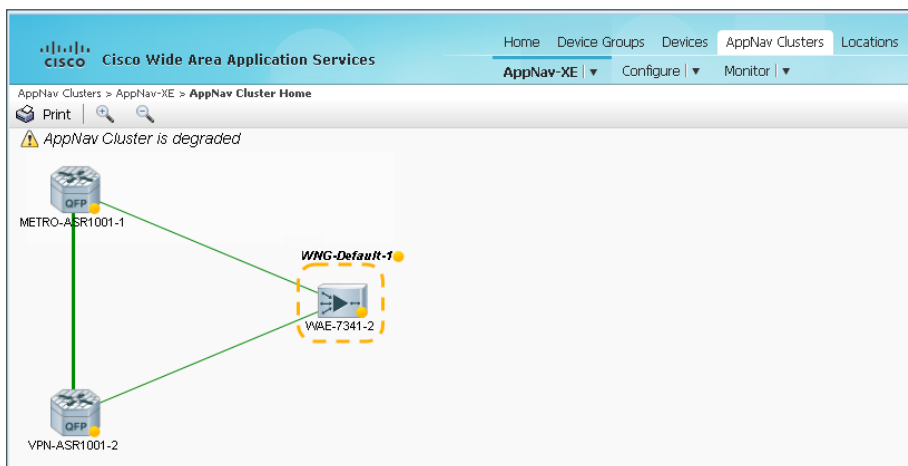

Next, if the Cisco WAAS nodes do not have a video license, disable video acceleration for the Cisco AppNav-XE cluster by following Step 16 through Step 19.

**Step 16:** If the cluster is not already selected, navigate to **AppNav Cluster > AppNav-XE**, select the cluster, and then navigate to **Configure>AppNav Policies**.

AppNav Policy across all AppNav-XE devices in a context will be same

AppNav Policies Selected 1 | Total 1

Show

	Name	Description	AppNav Contexts	AppNav Controllers
1	APPNAV-1-PMAP		waas/1	VPN-ASR1001-2, METRO-ASR1001-1

AppNav Policy Rules for Policy \*APPNAV-1-PMAP\* Selected 1 | Total 10

Show

<input type="checkbox"/>	Position	Class-Map	Source IP	Destination IP	Destination P...	Protocol	Remote Devices	Distribute To	Monitor
<input type="checkbox"/>	1	MAPI			443	mapi		WNG-Default-1	MAPI Accelerator
<input type="checkbox"/>	2	HTTPS	any	any	www			WNG-Default-1	SSL Accelerator
<input type="checkbox"/>	3	HTTP	any	any	3128			WNG-Default-1	HTTP Accelerator
<input type="checkbox"/>	4	CIFS	any	any	8000			WNG-Default-1	CIFS Accelerator
<input type="checkbox"/>	5	Citrix-ICA	any	any	8080			WNG-Default-1	ICA Accelerator
<input type="checkbox"/>	6	Citrix-CGP	any	any	8088			WNG-Default-1	ICA Accelerator
<input type="checkbox"/>	7	epmap	any	any	139			WNG-Default-1	MS PortMapper
<input type="checkbox"/>	8	NFS	any	any	445			WNG-Default-1	NFS Accelerator
<input checked="" type="checkbox"/>	9	RTSP	any	any	1494			WNG-Default-1	Video Accelerator
<input type="checkbox"/>	10	APPNAV-class-default	any	any	2598			WNG-Default-1	None

**Step 17:** In the lower pane, select the policy rule with the Monitor assigned to Video Accelerator (Example: Position 9 - RTSP), then click **Edit**.

**Step 18:** Change the setting for Monitor to **None**, click **OK**, and then accept the warning message by clicking **OK** again.

**AppNav Policy Rule**

AppNav Class-Map: \* RTSP

**AppNav Action**

Distribute To: WNG-Default-1

Monitor: \* None

**Step 19:** Navigate to **AppNav Clusters > AppNav-XE** and verify that the Cisco AppNav cluster is now operational. Expect a short delay for the new status to be reflected.

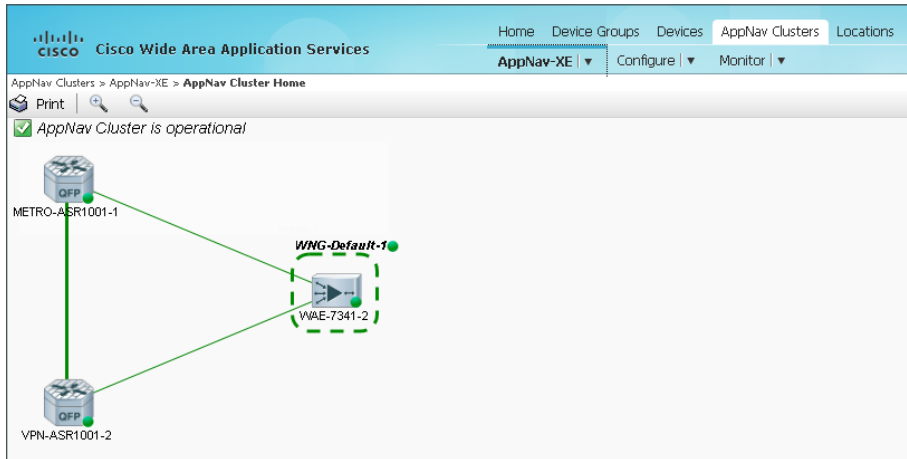

## PROCESS

### Preparing the Cisco UCS E-Series module for vWAAS

1. Configure remote switch for Cisco UCS E-Series
2. Configure the Cisco Integrated Management Controller
3. Configure UCS E-Series using CIMC
4. Configure RAID by using CIMC

#### Reader Tip

This process must be combined with the **Install VMware ESXi on the Cisco UCS E-Series module** process and the **Configuring Cisco vWAAS on the UCS E-Series module** process to complete the full installation and configuration of Cisco vWAAS on the UCS E-Series.

The following table specifies the parameters and data, in addition to the universal design parameters, that you need in order to set up and configure the Cisco vWAAS running on the Cisco UCS E-Series module. For your convenience, you can enter your values in the table and refer to it when configuring the UCS E-Series module. The values you enter will differ from those in this example, which are provided for demonstration purposes only.



Table 16 - Cisco vWAAS on the Cisco UCS E-Series module network parameters

Parameter	CVD values for an access-layer connection	CVD values for a distribution-layer connection	Site-specific values
In-band management network	10.5.244.0/24 (existing data subnet)	10.5.96.32/29 (new subnet for UCS E management)	
UCS E-Series interface address	unnumbered gig0/2.64	10.5.96.33/29	
Cisco IMC interface address	10.5.244.10/24	10.5.96.34/29	
VMware ESXi interface address	10.5.244.11/24	10.5.96.35/29	
Switch interface number	1/0/22	1/1/7	
VLAN number	64	106	
Time zone	PST8PDT -8 0	PST8PDT -8 0	
IP address	10.5.244.8/24	10.5.103.8/24	
Default gateway	10.5.244.1/24	10.5.103.1/24	
WAAS Central Manager	10.4.48.100	10.4.48.100	
Hostname	RS240-vWAAS	RS217-vWAAS-1	
IP addresses of routers intercepting traffic with WCCP	10.255.251.240	10.255.253.217	
WCCP password	c1sco123	c1sco123	
Management network (optional)	10.4.48.0/24	10.4.48.0/24	
TACACS shared key (optional)	SecretKey	SecretKey	

### Procedure 1 Configure remote switch for Cisco UCS E-Series

The access switch is the appropriate location to physically connect Cisco UCS E-Series modules at single-tier remote sites. Regardless of the switch type—single switch, switch stack, or modular—this type of connection must use a Layer 2 access interface. At distribution layer sites, the Cisco UCS E-Series module is physically connected to the distribution layer switch.

This guide assumes that the Cisco UCS E-Series module has been installed into the remote-site router and that the LAN switch has already been configured. Only the procedures required to complete the connection of the switch to the UCS E-Series module are included. For details on how to configure switches, see the [Campus Wired LAN Technology Design Guide](#).

**Step 1:** Connect the Cisco UCS E-Series module's external Ethernet port to an Ethernet port on the remote site's access or distribution layer switch, and then return the switchport configuration to the default.

```
default interface GigabitEthernet1/0/22
```

**Step 2:** Define the switchport in the remote-site switch as an access port for the data VLAN, and then apply port-security and QoS configuration.

```
interface GigabitEthernet1/0/22
description UCS E-Series external port
switchport access vlan 64
switchport host
ip arp inspection trust
logging event link-status
macro apply EgressQoS
no shutdown
```

## Procedure 2 Configure the Cisco Integrated Management Controller

### Tech Tip

The UCS E-Series procedures in this guide differ somewhat for an ISR G2 2900 series router or ISR G2 3900 series router compared to the ISR 4451-X router. Both methods are shown as options for the portions of the procedure that differ.

The Cisco UCS E-Series module has two internal interfaces on the router. These interfaces are numbered depending on which slot the UCS E-Series module is installed. Interface `ucse_/0` represents a routed PCIe interface and interface `ucse_/1` represents the multi-gigabit fabric (MGF) interface. This procedure configures the PCIe interface, which is also referred to as the Console interface.

### Option 1: Layer 2 access switch

This is the recommended configuration for remote sites with an access layer only.

Perform these steps to set up the Cisco Integrated Management Controller (CIMC) interface.

**Step 1:** Determine the UCS-E interfaces.

ISR G2 2900/3900 series router:

```
RS240-3945#show ip interface brief | include ucse
ucse1/0      unassigned   YES   unset   administratively down down
ucse1/1      unassigned   YES   unset   up       up
```

### Tech Tip

This example shows the Cisco UCS E-Series module installed in slot 1 of the router.

ISR 4451-X router:

```
RS205-4451X#show ip interface brief | include ucse
```

ucse1/0/0	unassigned	YES	unset	administratively	down	down
ucse1/1/0	unassigned	YES	unset	up	up	

### Tech Tip

This example shows the Cisco UCS E-Series module installed in slot 1 of the router.

**Step 2:** Assign an IP address to the router's UCS E-series interface. In this configuration you use **IP unnumbered** to share the IP address assigned to the internal data VLAN. This will be the gateway IP address for the Cisco UCS E-Series CIMC and hypervisor.

```
interface ucse1/0
 ip unnumbered interface GigabitEthernet0/2.64
 no shutdown
```

**Step 3:** Assign an IP address and gateway to the CIMC.

### Tech Tip

If HSRP is configured, do not use the HSRP virtual IP address. Use the real IP address assigned to the interface or subinterface.

ISR G2 2900/3900 series router:

```
interface ucse1/0
 imc ip address 10.5.180.10 255.255.255.0 default-gateway 10.5.180.1
```

ISR 4451-X router:

```
ucse subslot 1/0
 imc ip address 10.5.36.10 255.255.255.0 default-gateway 10.5.36.1
```

**Step 4:** Configure the CIMC LAN on Motherboard (LOM) for shared access.

### Tech Tip

Shared console access allows this interface to be used for CIMC access and network traffic. Dedicated mode allows only CIMC access.

ISR G2 2900/3900 series router:

```
interface ucse1/0
 imc access-port shared-lom console
```

ISR 4451-X router:

```
ucse subslot 1/0
imc access-port shared-lom console
```

**Step 5:** Configure a static host route for the CIMC host via the internal UCS-E interface.

```
ip route 10.5.244.10 255.255.255.255 ucse1/0
```

**Step 6:** Configure an additional static host route for the VMware ESXi host that will reside on the same subnet and share the UCS-E console for access.

```
ip route 10.5.244.11 255.255.255.255 ucse1/0
```

**Step 7:** If this is a dual router remote site, you may need to redistribute the static routes created in Step 5 and Step 6 into the LAN EIGRP process (AS 100).

### Tech Tip

Each of the two routers includes static routes to the UCS E-Series module. It is not necessary to redistribute these static routes into the LAN EIGRP process.

```
ip route 10.5.244.10 255.255.255.255 ucse1/0
ip route 10.5.244.11 255.255.255.255 ucse1/0
```

This type of static route is known as a *pseudo-static* or *pseudo-connected* route because it meets two conditions:

- 1) The static route points directly to an interface.
- 2) The destination IP address is contained within an IP range that is referenced by an EIGRP network statement.

```
router eigrp LAN
address-family ipv4 unicast autonomous-system 100
network 10.5.0.0 0.0.255.255
exit-address-family
```

A pseudo-connected route is treated like a connected route and is automatically advertised within the EIGRP autonomous system as an EIGRP internal route so no redistribution is required.

Although the pseudo-connected routes will be automatically brought into the EIGRP topology and treated similarly to a connected route, EIGRP does not reclassify the route as a connected. Redistribution of static routes, and then applying configuration commands (such as route maps) to the redistributed routes will affect these routes.

As a best practice, a route-map with an access-list is used to explicitly list which static routes are redistributed. If static route redistribution is already configured, then redistribution of the pseudo-connected routes is also required. In this case, add a new access-list and the additional clause for the route-map.

If static route redistribution is not already configured, then you may skip this step.

```
ip access-list standard STATIC-ROUTE-LIST
  remark UCS-E CIMC & ESXi host routes
  permit 10.5.244.10
  permit 10.5.244.11
!
route-map STATIC-IN permit 20
  match ip address STATIC-ROUTE-LIST
!
router eigrp LAN
  address-family ipv4 unicast autonomous-system 100
  topology base
    redistribute static route-map STATIC-IN
  exit-af-topology
  exit-address-family
```

Next, verify the CIMC configuration.

**Step 8:** Open a browser window to the CIMC address (example: <https://10.5.244.10> ), enter the factory default username **admin** and factory default password **password**, and then click **Log In**.

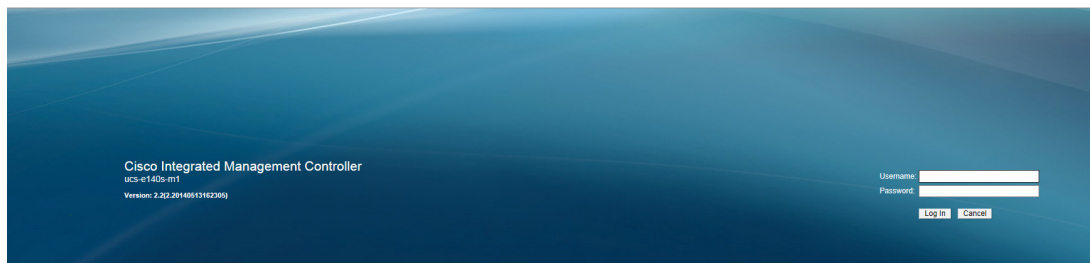

**Step 9:** If this is the first login to this device, you will be prompted to change the password. Enter a new password (Example: c1sco123), and then click **Save Changes**.

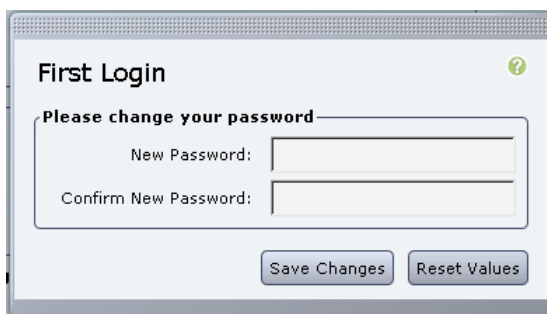

## Option 2: Layer 3 distribution switch–dedicated UCS-E subnet

This is the recommended configuration for remote sites with a distribution layer.

When connecting to the distribution layer you must assign a dedicated subnet range for Cisco UCS E-Series management. The CIMC and ESXi interfaces are both assigned addresses in this range. The external UCS E-series interface(s) are connected to the LAN for communication between the Cisco vWAAS and the redirecting router.

Perform these steps to set up the CIMC interface.

**Step 1:** Determine the UCS-E interfaces.

```
RS217-4451X-1#show ip interface brief | include ucse
ucse1/0/0      unassigned   YES   unset   administratively down down
ucse1/0/1      unassigned   YES   unset   up       up
```

**i** Tech Tip

This example shows the Cisco UCS E-Series module installed in slot 1 of the router.

**Step 2:** Assign an IP address to the router's UCS E-series interface. In this configuration you explicitly assign an IP address on the newly assigned subnet range. This will be the gateway IP address for the Cisco UCS E-Series CIMC and hypervisor.

ISR G2 2900/3900 series router:

```
interface ucse1/0
 ip address 10.5.240.33 255.255.255.248
```

ISR 4451-X router:

```
interface ucse1/0/0
 ip address 10.5.96.33 255.255.255.248
 no shutdown
```

**Step 3:** Assign an IP address and gateway to the CIMC.

ISR G2 2900/3900 series router:

```
interface ucse1/0
 imc ip address 10.5.240.34 255.255.255.248 default-gateway 10.5.240.33
```

ISR 4451-X router:

```
ucse subslot 1/0
 imc ip address 10.5.96.34 255.255.255.248 default-gateway 10.5.96.33
```

**Step 4:** Configure the CIMC LOM for shared access.

**i** Tech Tip

Shared console access allows this interface to be used for CIMC access and network traffic. Dedicated mode allows only CIMC access.

ISR G2 2900/3900 series router:

```
interface ucse1/0
 imc access-port shared-lom console
```

ISR 4451-X router:

```
ucse subslot 1/0
 imc access-port shared-lom console
```

Next, verify the CIMC configuration.

**Step 5:** Open a browser window to the CIMC address (example: <https://10.5.96.34> ), enter the factory default username **admin** and factory default password **password**, and then click **Log In**.



**Step 6:** If this is the first login to this device, you will be prompted to change the password. Enter a new password (Example: c1sco123), and then click **Save Changes**.

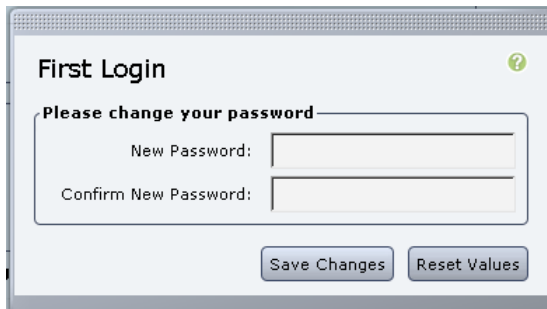

### Procedure 3 > Configure UCS E-Series using CIMC

**Step 1:** Verify the server status. From the Server Summary screen you can verify the installed CPU, if the memory and disk are correctly reported, that the correct versions of CIMC and BIOS are installed.

**Step 2:** Enter a description for this device (Example: RS213 UCS E-Series), and click then **Save Changes**.

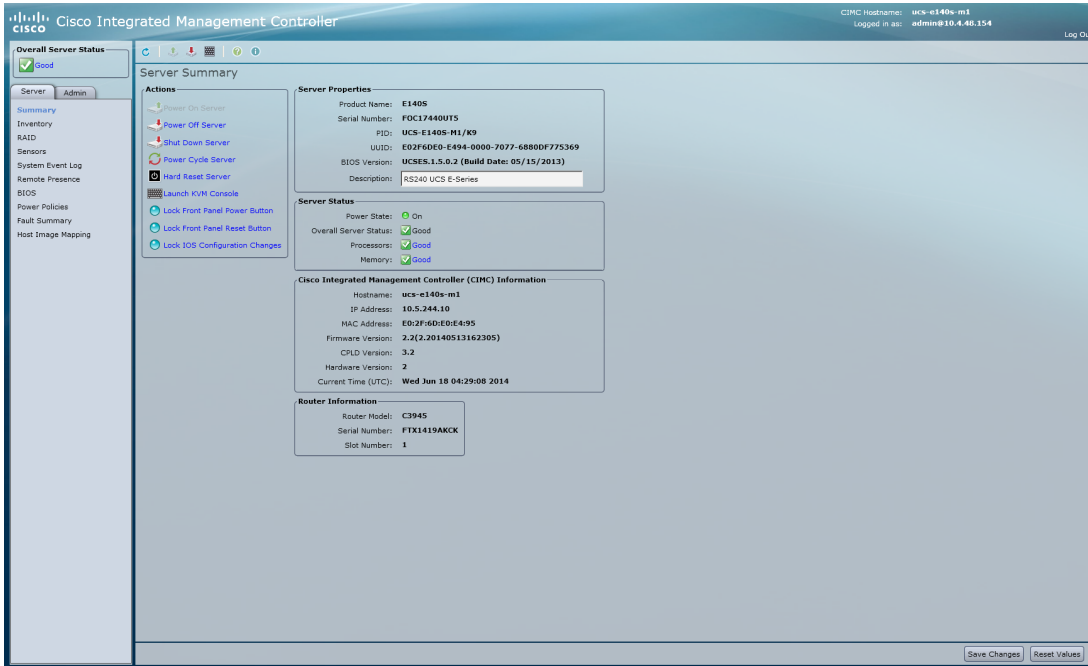

Next, configure Network Settings.

**Step 3:** Click the **Admin** tab, select **Network**, and then click the **Network Settings** tab. Configure a hostname (Example: RS213-UCSE140S) and the primary DNS server if necessary (Example: 10.4.48.10), and then click **Save Changes**. On the warning window, click **OK**.

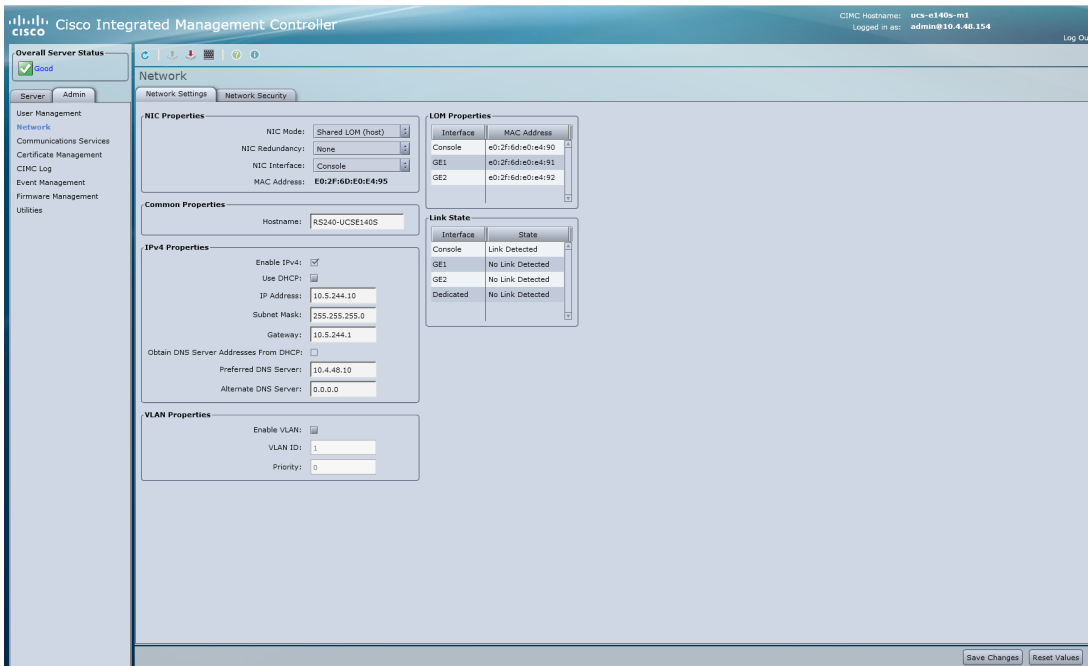



## Procedure 4 Configure RAID by using CIMC

Verify whether or not your UCS E-Series already has a virtual drive with RAID configured. If a virtual drive exists, you may skip Step 2 through Step 10.

**Step 1:** Click on the **Server** tab, select **RAID**.

Figure 8 - UCS E-Series with an existing virtual drive

The screenshot shows the CIMC interface for a UCS E-Series server. The 'RAID' tab is selected, and the 'Virtual Drive Info' sub-tab is active. A table lists the virtual drives:

Virtual Drive	Name	State	Size	RAID Level	Bootable	Actions
0		Optimal	952720 MB	RAID 1	✓	[-] Actions

Below the table, the 'Physical Drives' section shows a table with columns: Physical Drive, Span, Starting Block, Number Of Blocks, and State. It lists two physical drives, both in an 'online' state.

Figure 9 - UCS E-Series requiring the configuration of a virtual drive

The screenshot shows the CIMC interface for a UCS E-Series server. The 'RAID' tab is selected, and the 'Virtual Drive Info' sub-tab is active. The 'Virtual Drives' table is currently empty, indicating that no virtual drives are configured.

**Step 2:** Click the **Physical Drive Info** tab.

The screenshot shows the CIMC interface for a UCS E-Series server. The 'Physical Drive Info' sub-tab is active. A table lists the physical drives:

Slot Number	State	Mode	Type	Coerced Size	Bootable	Actions
1	system	3600	HDD, SATA	952720 MB		[-] Actions
2	system	3600	HDD, SATA	952720 MB		[-] Actions

Below the table, the 'General' section provides details for the selected drive (Slot 1):

- Enclosure Device ID: 64
- Slot Number: 1
- Power State: active
- Device ID: 0
- Sequence Number: 4
- Media Error Count: 0
- Other Error Count: 0
- Predictive Failure Count: 0
- Block Size: 512
- Block Count: 1953525168
- Raw Size: 953660 MB
- Non Coerced Size: 953357 MB
- Coerced Size: 952720 MB
- SAS Address: 0: 4433221100000000
- Link Speed: 6.0 Gb/s
- Media Type: HDD
- Interface Type: SATA

The 'Inquiry Data' section shows:

- Vendor: ATA
- Product ID: ST91000640NS
- Drive Firmware: CC03
- Drive Serial Number: 9XG4KA4Q

The 'Status' section shows:

- State: system
- Fault: false
- Online: true

The 'Security' section shows:

- FDE Capable: false
- Security Enabled: false
- Secured by Controller: false
- FDE Locked: false
- Secured by Foreign Key: false
- Secured by EKMS: false

**Step 3:** For the drive in Slot Number 1, choose **UnconfiguredGood** from the **Actions** list.

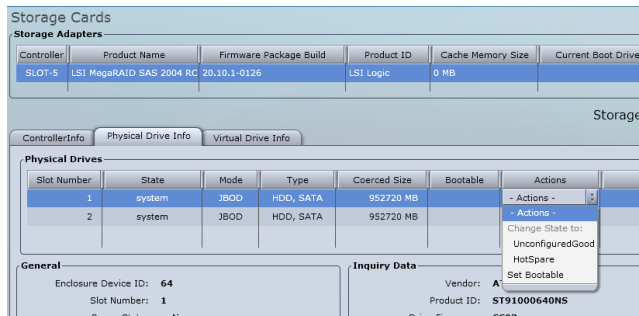

**Step 4:** Click **OK** to accept the warning.

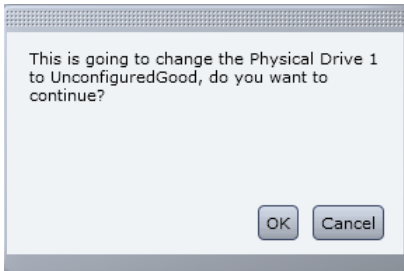

**Step 5:** For any remaining drives, repeat Step 3 and Step 4.

**Step 6:** Verify that the state of all of the drives is **unconfigured good**.

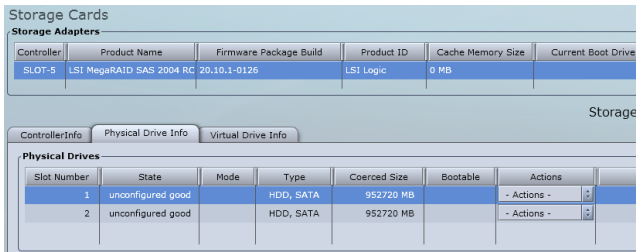

**Step 7:** Click the **Virtual Drive Info** tab and then in the **Actions** pane, click **Create**.

**i Tech Tip**

If you are configuring a Cisco UCS E-Series module with a single hard drive you can select **RAID 0** and add the single drive to the list. Using two drives is recommended when possible.

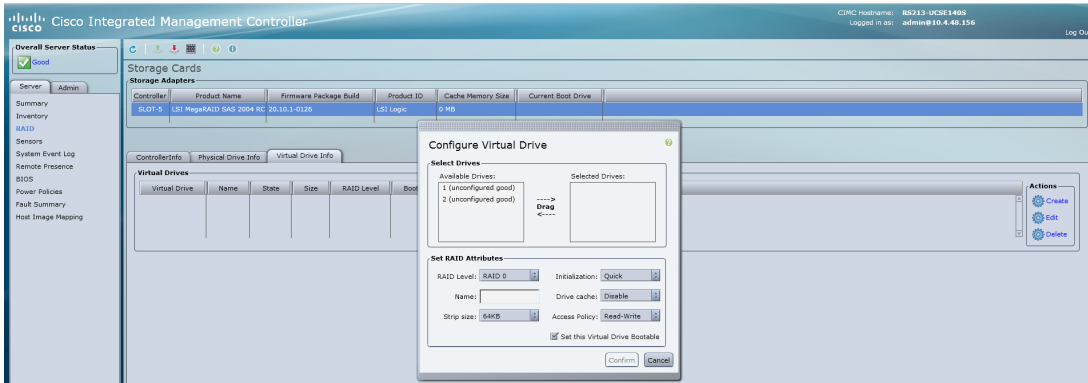

**Step 8:** In the **Configure Virtual Drive** window, select the drives to be included in the RAID configuration, and then drag them from the Available Drives column to the Selected Drives column.

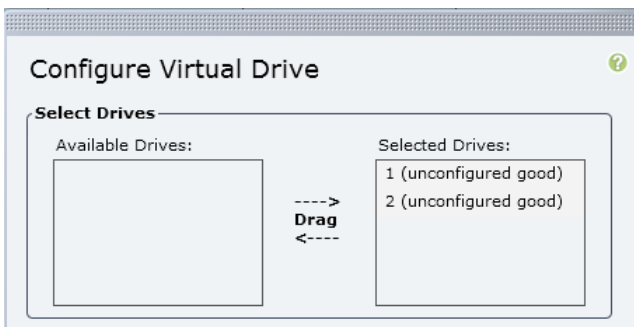

**Step 9:** Select RAID Level **RAID 1** from the drop down menu. If your system has only a single drive, select RAID Level **RAID 0** (this will be the only available option). Select **Set this Virtual Drive Bootable**, and then click **Confirm**.

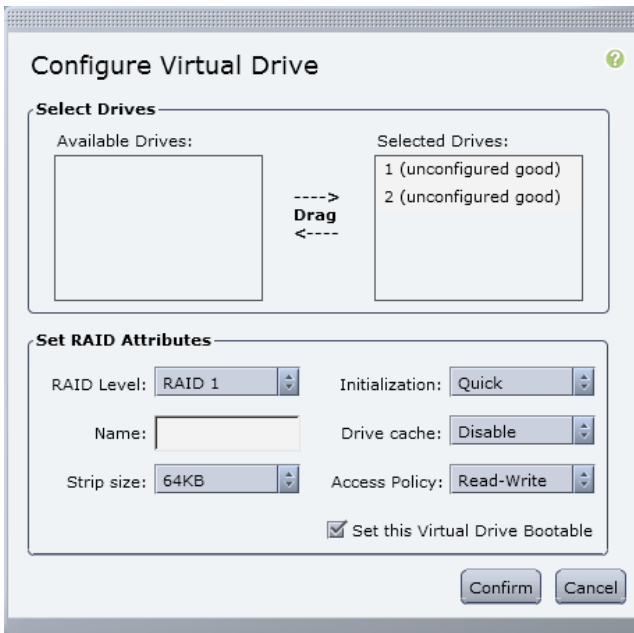

**Step 10:** Navigate to the **Server** tab, select **RAID**, click the **Virtual Drive Info** tab, and then verify that the virtual and physical drives are properly assigned.

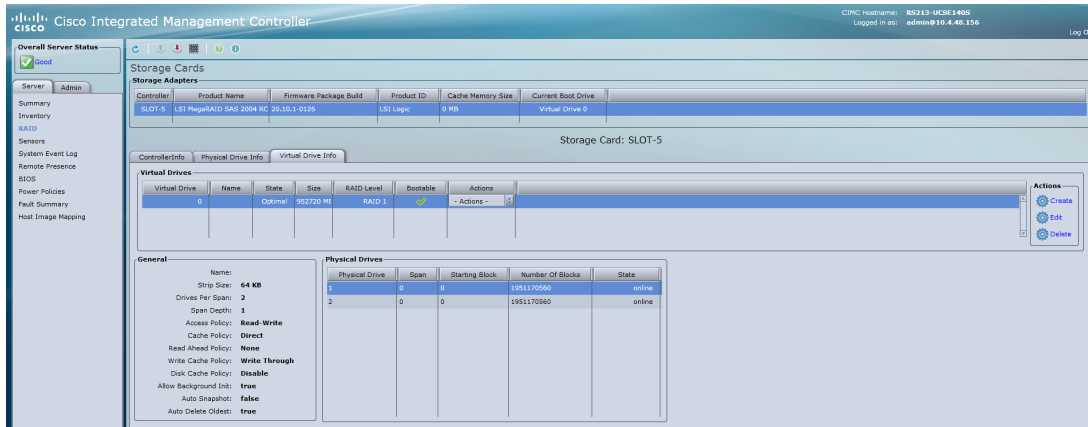

PROCESS

## Install VMware ESXi on the Cisco UCS E-Series module

1. Download UCS E-Series VMware ESXi image
2. Install VMware ESXi on UCS-E Server
3. Configure VMware ESXi Host Settings
4. Add VMware ESXi host to vCenter
5. Add a datastore to ESXi hosts
6. Configure networking for ESXi host
7. Configure ESXi NIC teaming for resiliency

If possible install ESXi on the Cisco UCS-E server modules before shipping them to remote locations. This will avoid WAN utilization and possible congestion problems on your network.

i

Tech Tip

If you are using VMware FL-SRE-V-HOST license (equivalent to VMware vSphere Hypervisor™ 5.X), make sure that the installed Cisco UCS-E RAM is 32 GB or less. If the installed UCS-E RAM is more than 32 GB, you will get an error message, and you will not be able to apply the license.

If you want to use 48-GB RAM on the UCS-E server, upgrade your license to FL-SRE-V-HOSTVC. You can verify the memory configuration prior to installing VMware ESXi by navigating to the **Server** tab, selecting **Inventory**, and then clicking the **Memory** tab.

## Procedure 1 Download UCS E-Series VMware ESXi image

A custom version of VMware ESXi has been developed specifically for use on Cisco UCS Servers. Use the following steps to download the custom ISO image.

**Step 1:** Open a browser and navigate to the VMware login page, <https://my.vmware.com/web/vmware/login>.

**Step 2:** Enter your VMware credentials, and then click **Log In**. If you do not have an account with VMware, create an account by clicking **Register**.

**Step 3:** Click on **All Downloads**.

**Step 4:** Select the **All Products** tab and then click on **View Download Components** for **VMware vSphere**.

**All Downloads**

Search All Downloads

My Products All Products Products A-Z

All Products

**Datacenter & Cloud Infrastructure**

VMware vCloud Suite [View Download Components | Drivers & Tools | Buy](#)

VMware vSphere with Operations Management [View Download Components | Drivers & Tools | Try](#)

VMware vSphere Data Protection Advanced [View Download Components | Drivers & Tools | Try](#)

VMware vSphere [View Download Components | Drivers & Tools | Try](#)

**Step 5:** Select version 5.1 in the **Select Version** dropdown box.

**Download VMware vSphere**

Select Version: Customers who have purchased VMware vSphere 5.1 can download their relevant installation package from the product download tab below. Looking to upgrade from vSphere 4 or Infrastructure 3? Visit the [VMware vSphere Upgrade Center](#).

5.1 5.5 5.1 5.0 4.1 4.0

[Read More](#)

**Step 6:** Select the **Custom ISOs** tab, and expand the **OEM Customized Installer CDs** by clicking the right arrow.

Product Downloads Drivers & Tools Open Source Custom ISOs

Custom ISOs Release Date

> OEM Customized Installer CDs

**Step 7:** Click on **Go to Downloads** for the **Cisco Custom Image for ESXi 5.1.0 U2 GA Install CD**.

Custom ISOs	Release Date
OEM Customized Installer CDs	
HP Custom Image for ESXi 5.1.0 Update 2 Install CD	2014-06-17 <a href="#">Go to Downloads</a>
Cisco Custom Image for ESXi 5.1.0 U2 GA Install CD	2014-03-15 <a href="#">Go to Downloads</a>

**Step 8:** In the Product Downloads Tab, click the **Download Now** for the **File type: iso** version.

File	Information
<b>Cisco Custom Image for VMware ESXi 5.1.0 U2 GA Install CD</b>	<a href="#">Download Now</a>
File size: 308 MB File type: iso	<a href="#">Download Manager</a>
<a href="#">Read More</a>	

**Step 9:** The customized VMware vSphere Hypervisor image is downloaded.

## Procedure 2 Install VMware ESXi on UCS-E Server

This procedure details several important tasks, including mounting the VMware ESXi ISO, setting the UCS-E Boot settings, and installing VMware ESXi onto the SD card of the UCS-E server. It is important to keep both the CIMC and KVM console windows open throughout these steps.

### Tech Tip

Installing the hypervisor onto the internal SD card of the ESXi server allows us to maintain separation and dedicate the internal RAID drives to the virtual machines loaded onto the server.

**Step 1:** Using your web browser, navigate to the CIMC address of the UCS E-Series module and login. [ex: <https://10.5.144.10>] [admin/c1sco123]. Accept any browser warnings due to untrusted certificates.

**Step 2:** On the **Server** tab, select **Remote Presence**, click the **Virtual Media** tab, and then ensure the **Enabled** check box is selected.

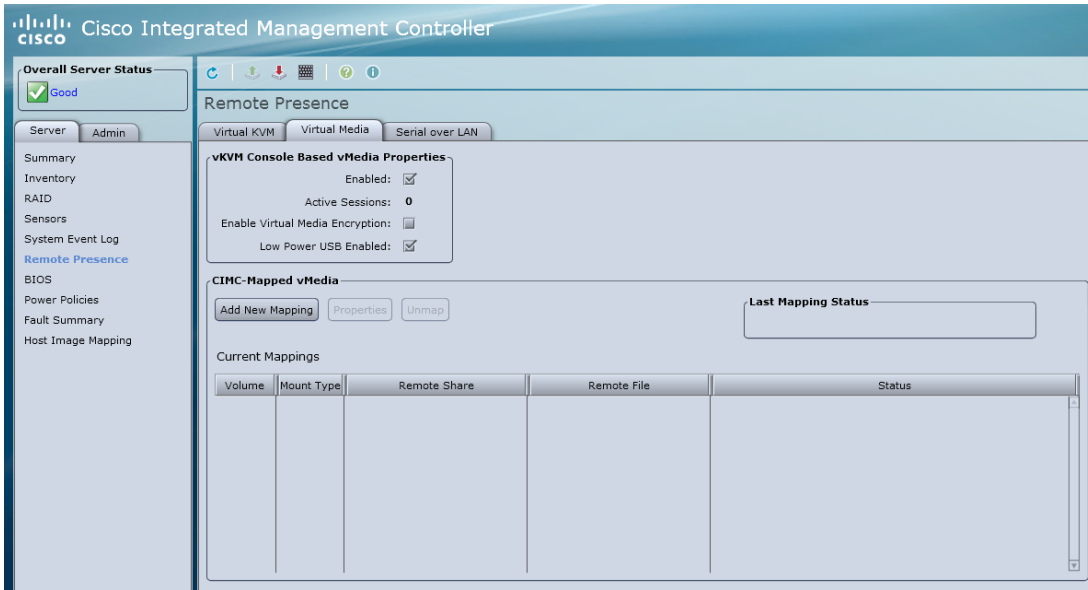

**Step 3:** Click the **Virtual KVM** tab, and then ensure the enabled check box is selected.

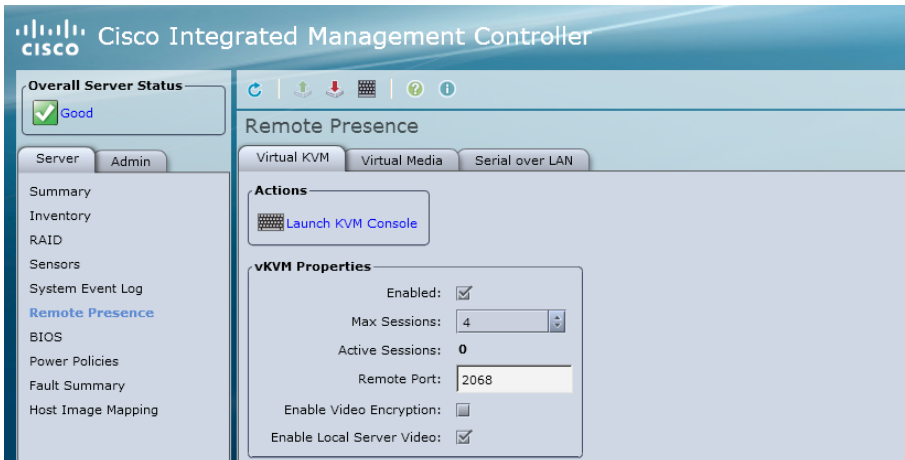

**Step 4:** In the **Actions** pane, on the **Virtual KVM** tab, click **Launch KVM Console**. Accept any security warnings. The virtual KVM window opens.

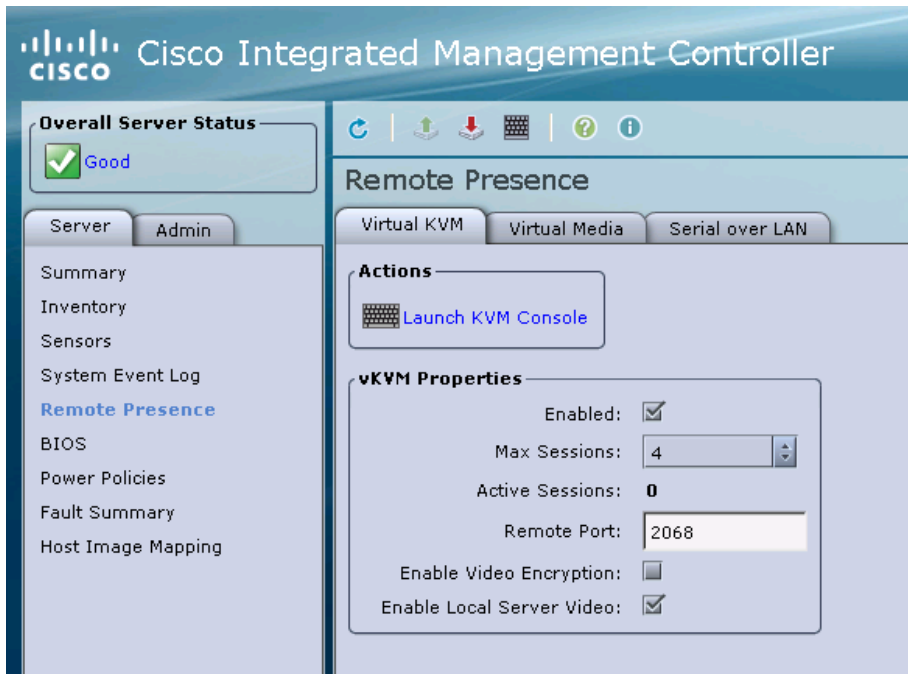

**Step 5:** In the KVM Console window, click the **Virtual Media** tab.

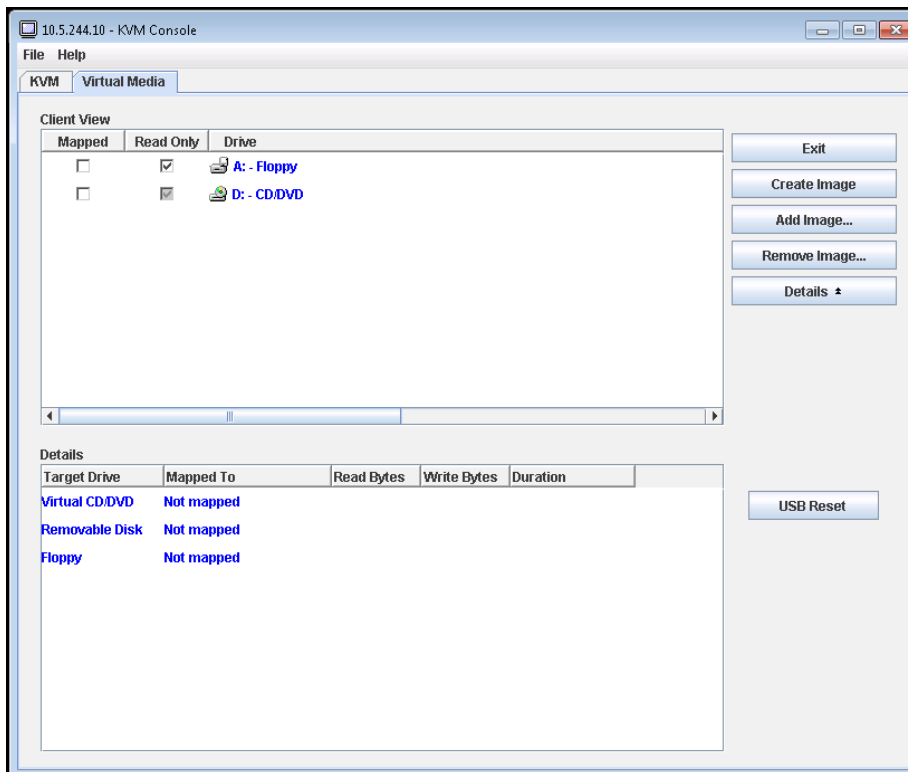



Step 6: In the KVM Console window, click Add Image.

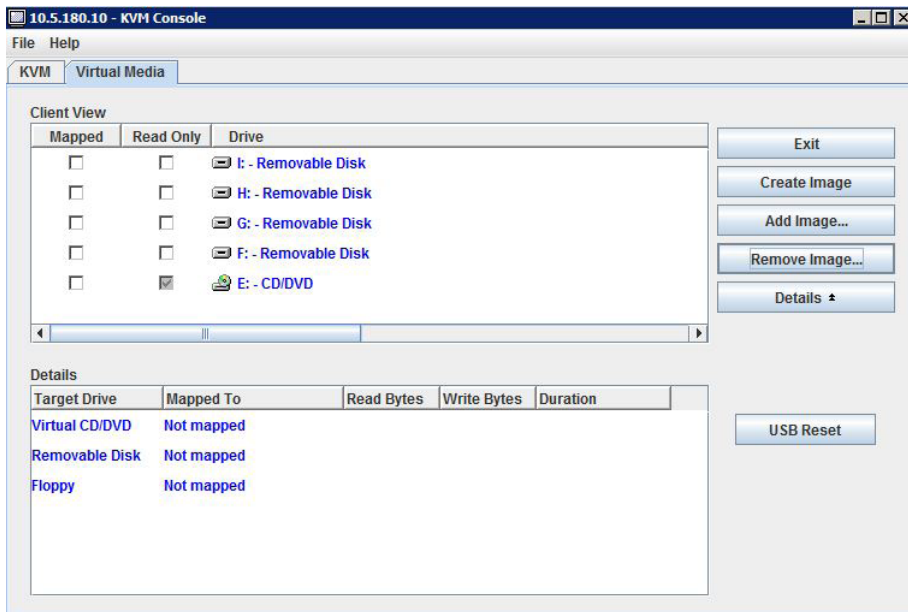

Step 7: Browse for the VMware ESXi ISO image, and then click Open.

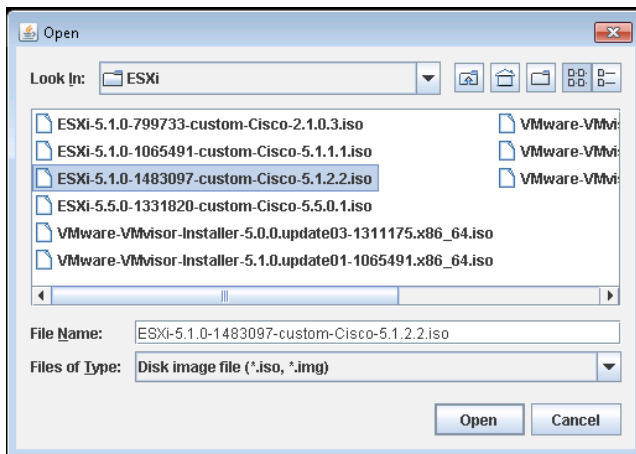

**Step 8:** For the newly added image, select **Mapped**. This maps the ISO file and completes the mount.

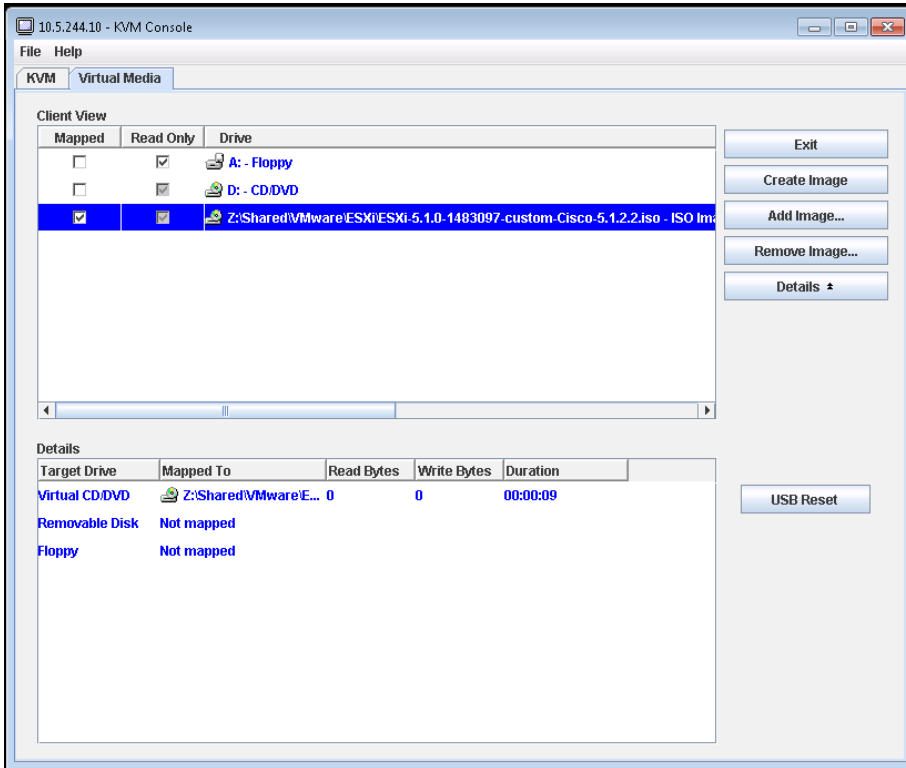

**Step 9:** Return to the **KVM Console** window by clicking the **KVM** tab. You can monitor the status of the server by using this console window. Keep this window open and visible.

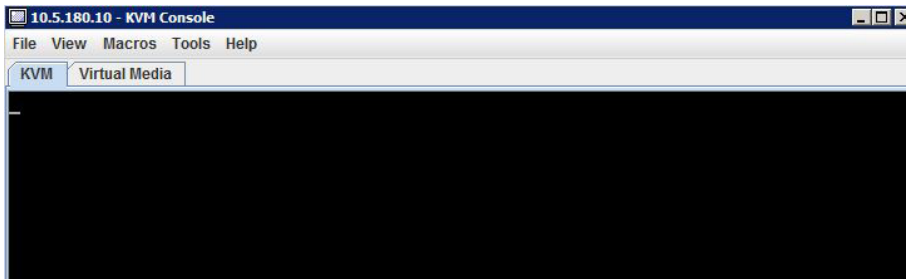

**Step 10:** From the CIMC, navigate to the server summary screen, and then reboot the server by clicking **Power Cycle Server**. In the warning window, click **OK**. The console screen turns blank and green for a moment during this process.

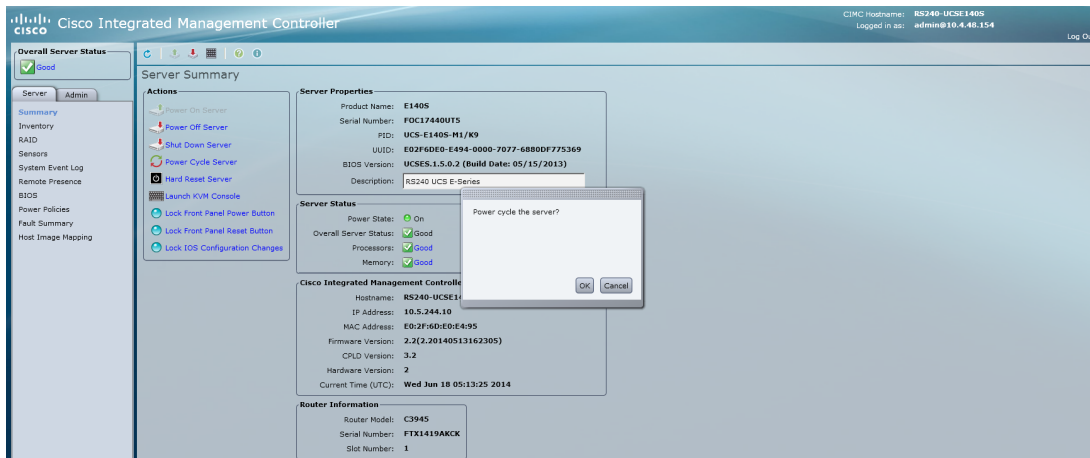

**Step 11:** Monitor the KVM Console window as the server boots, and, when prompted, enter the BIOS setup by pressing **F2**.

**Step 12:** When prompted, enter the password (Example: c1sco123). If this is the first time entering the BIOS, you are prompted to set a BIOS password (Example: c1sco123).

### Tech Tip

Pay close attention to the KVM console as the **F2** command is accepted for only a short period of time. If you fail to enter the BIOS setup, you must power cycle the server using CIMC and retry.

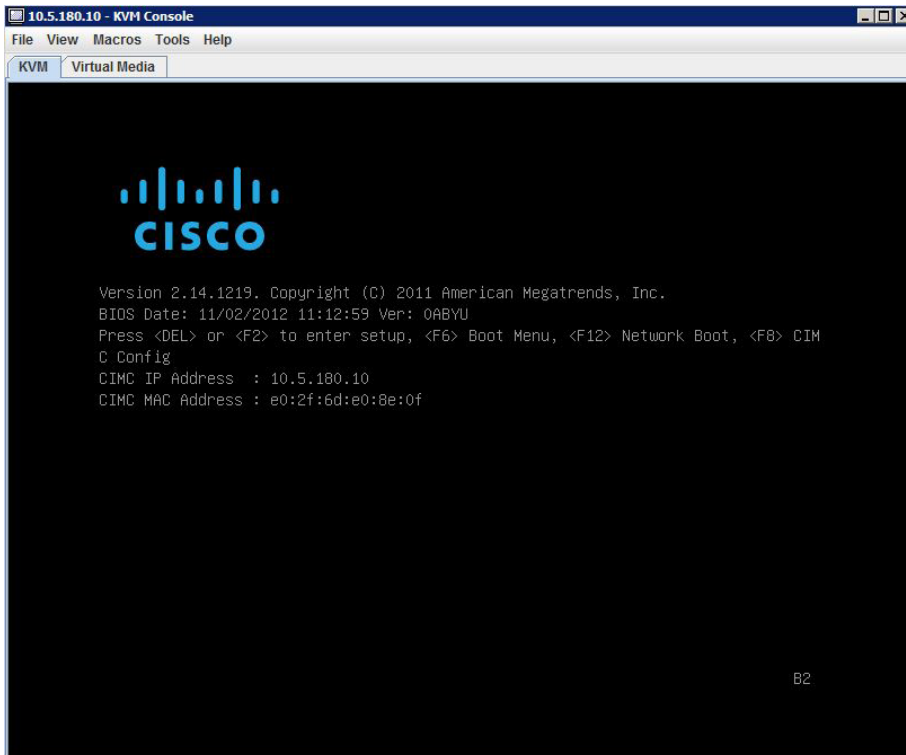

Step 13: Using the arrows on your keyboard, navigate to the **Boot** tab, highlight **Boot Option #1**, and then press **Enter**.

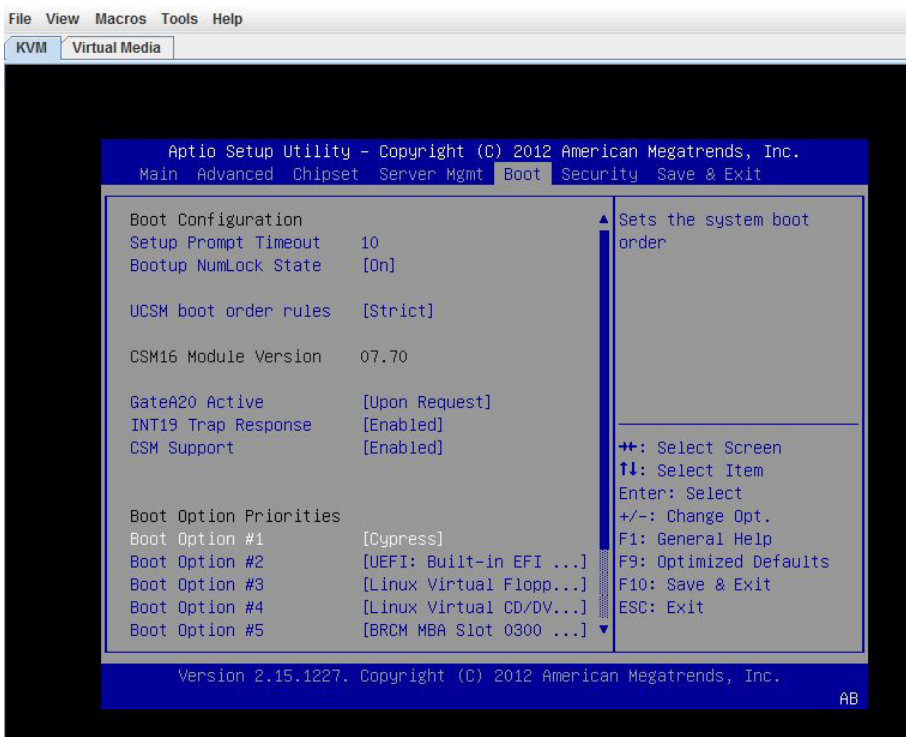

**Step 14:** In the window, select **Cypress**, and then press **Enter**.

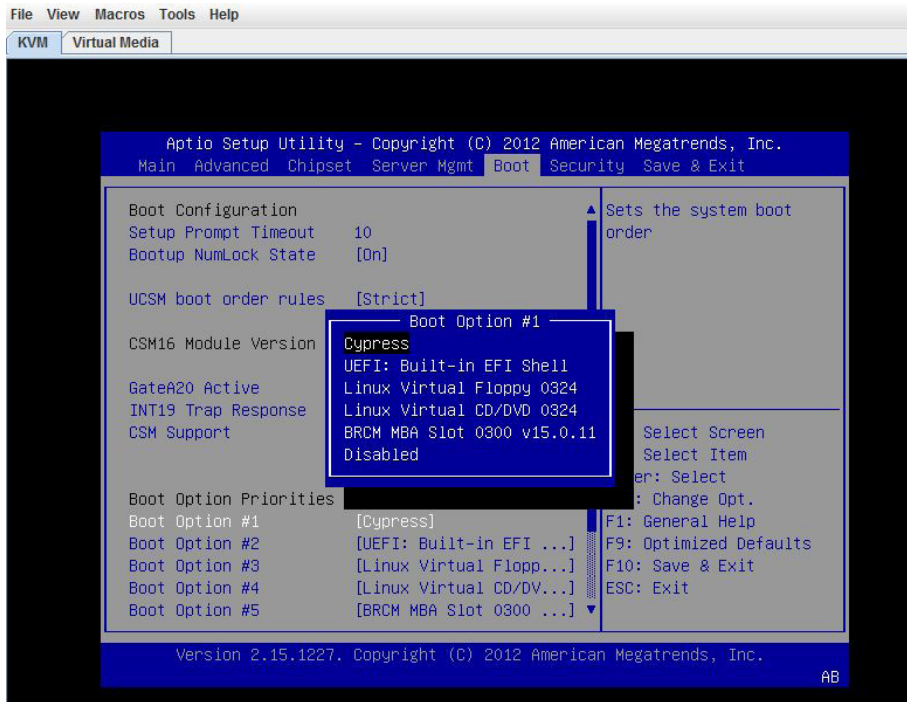

**Step 15:** Press **F10**. In the save and exit dialog box, select **Yes**, and then press **Enter**. This saves the BIOS settings and exits BIOS. The system will now reboot.

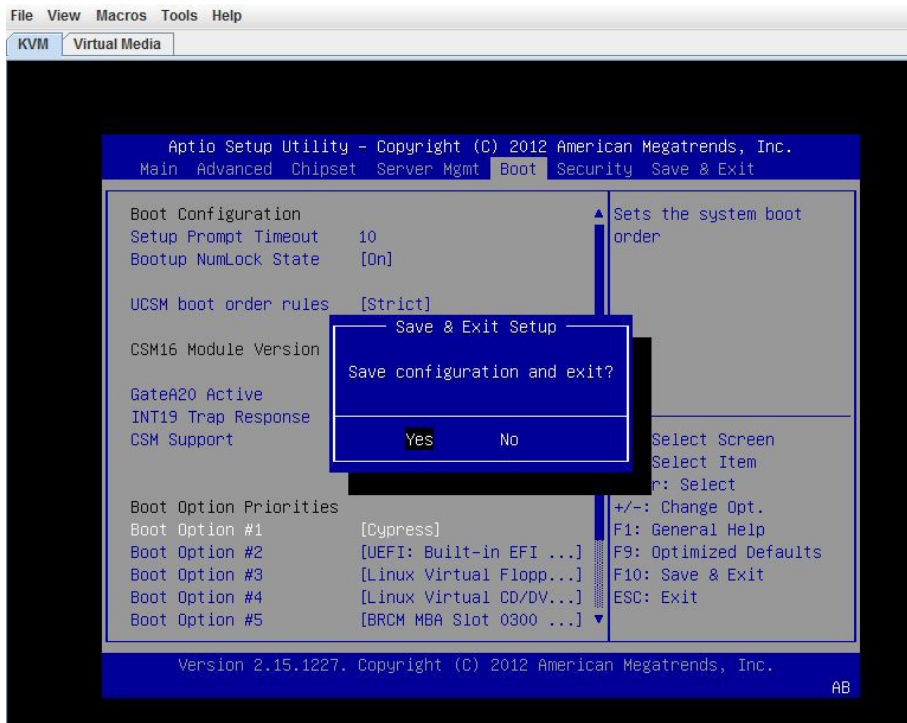

**Step 16:** In the virtual KVM window, click the **KVM** tab, and then monitor the **KVM Console** window as the server boots. The server loads the ESXi Installer from the mapped ISO image.

**Step 17:** When the VMware Vmisor Boot Menu appears, select the ESXi custom installer.

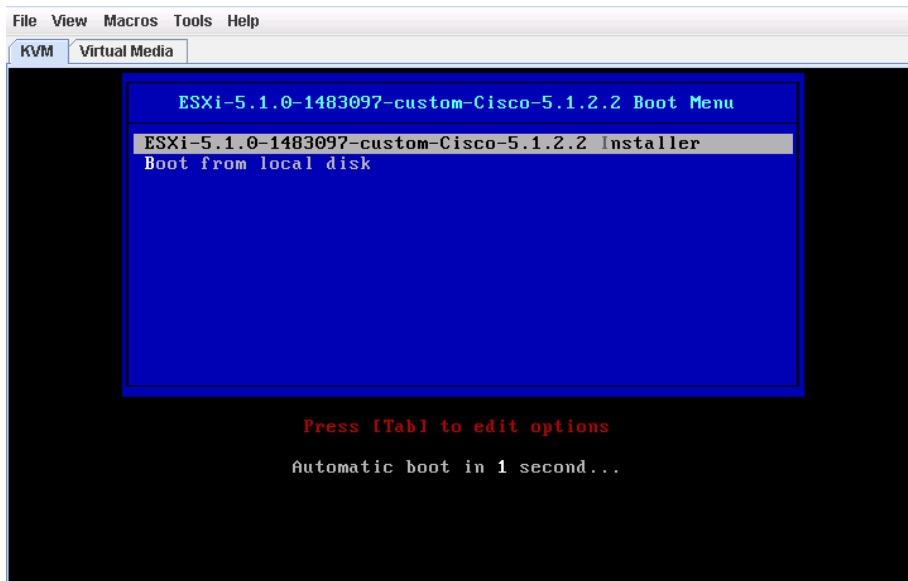

**Step 18:** After several minutes, on the welcome screen, press **Enter**. The installation of ESXi begins.

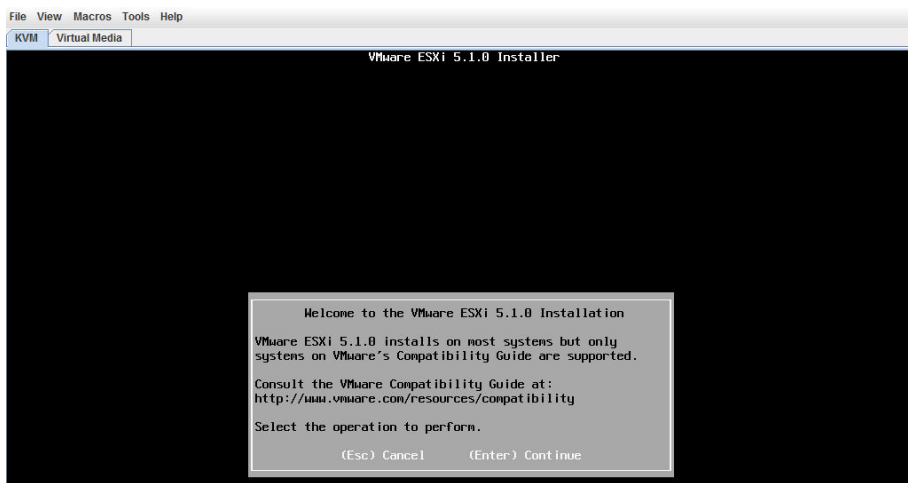

Step 19: Accept the license by pressing F11.

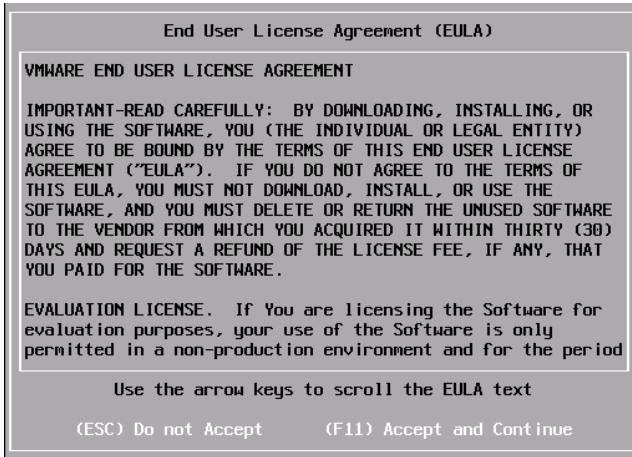

Step 20: Using the down arrow, select the SD card as the local storage device, and then press Enter. (example: Cypress Astoria SD Card). When prompted to confirm disk selection, press Enter.

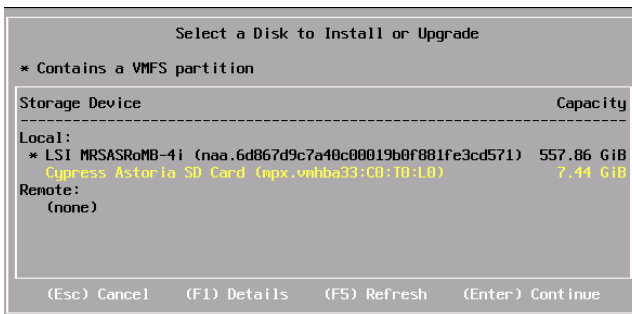

Step 21: For the keyboard layout, select the US Default, and then press Enter.

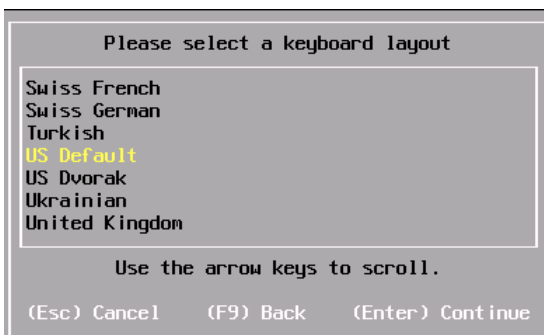

**Step 22:** Set the root password, confirm the password, and then press **Enter** (example: c1sco123).



Please enter a root password (recommended)

Root password: \_  
Confirm password:

(Esc) Cancel (F9) Back (Enter) Continue

**Step 23:** The system scans for resources, which may take a few moments. Press **F11**. A status bar shows the progress of the ESXi installation.

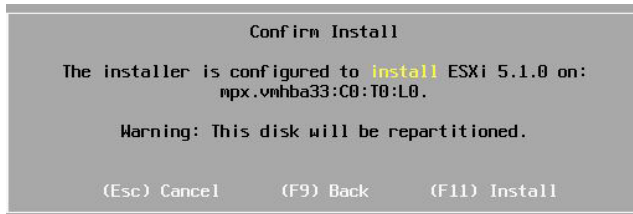

Confirm Install

The installer is configured to **install** ESXi 5.1.0 on:  
mpx.vmhba33:C0:T0:L0.

Warning: This disk will be repartitioned.

(Esc) Cancel (F9) Back (F11) Install

The Installation Complete message appears after the installation process finishes. Do not reboot the server until after you complete Step 24.



Installation Complete

ESXi 5.1.0 has been **successfully** installed.

ESXi 5.1.0 will operate in evaluation mode for 60 days. To use ESXi 5.1.0 after the evaluation period, you must register for a VMware product license. To administer your server, use the vSphere Client or the Direct Control User Interface.

**Remove** the installation disc before rebooting.

Reboot the server to start using ESXi 5.1.0.

(Enter) Reboot



**Step 24:** After a successful installation of ESXi, select the **Virtual Media** tab on the **KVM Console** window, click **Remove Image**, and agree to the warning. This unmounts the image.

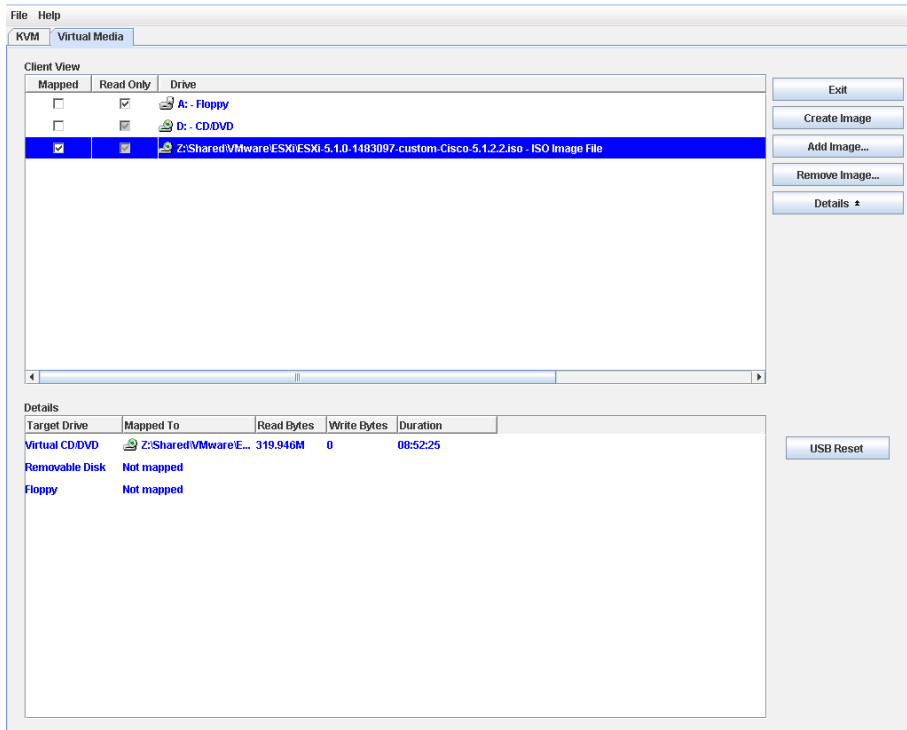

**Step 25:** On the KVM tab, press **Enter**. The system restarts, loading the ESXi image installed on the SD drive.

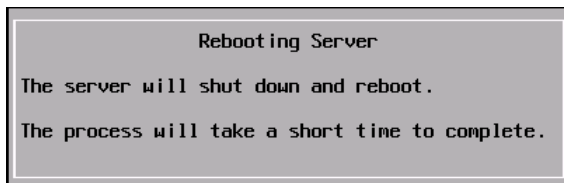

### Procedure 3

## Configure VMware ESXi Host Settings

**Step 1:** In the KVM Console window, press **F2**. This enables you to customize the system after ESXi is finished booting.

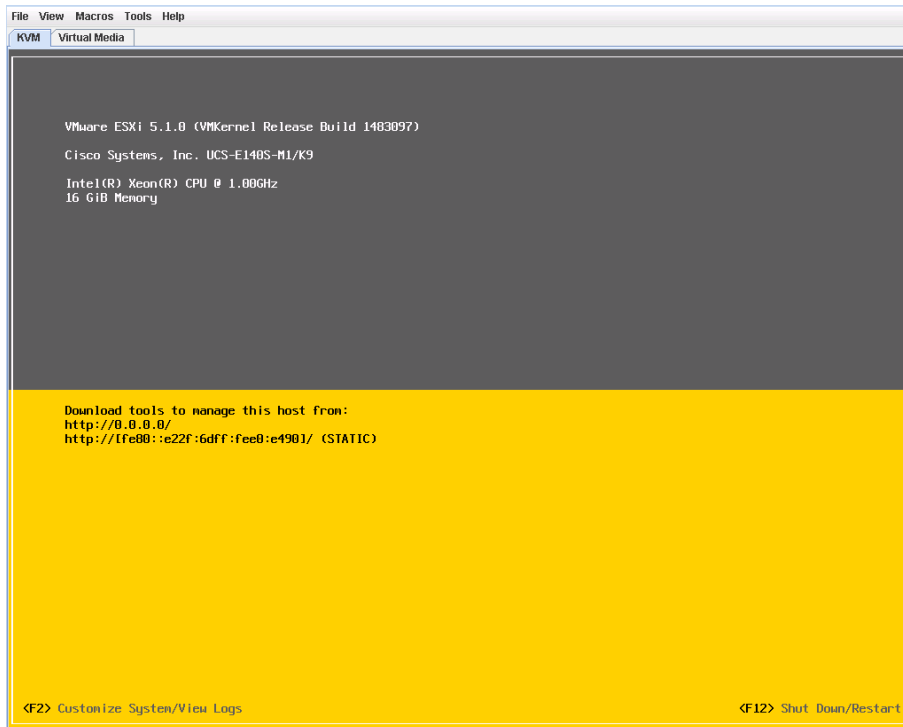

**Step 2:** Log in using the credentials you set during installation. [example: root/c1sco123]

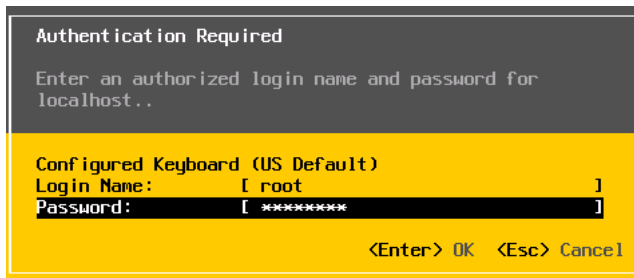

**Step 3:** Using the down arrow key, highlight to the **Configure Management Network** option, and then press **Enter**.

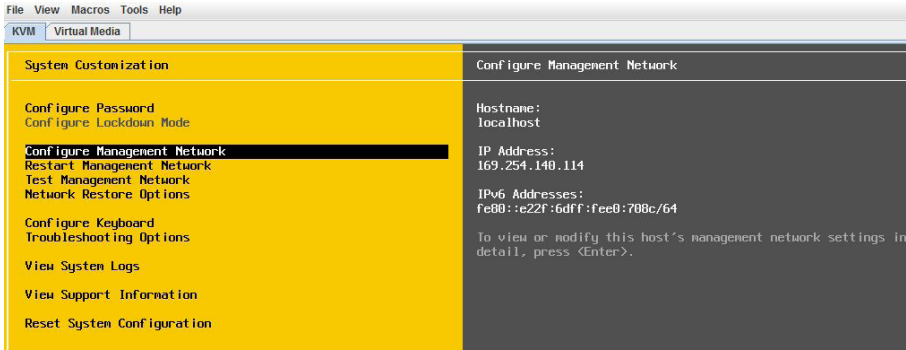

**Step 4:** Select **IP Configuration**, and then press **Enter**.

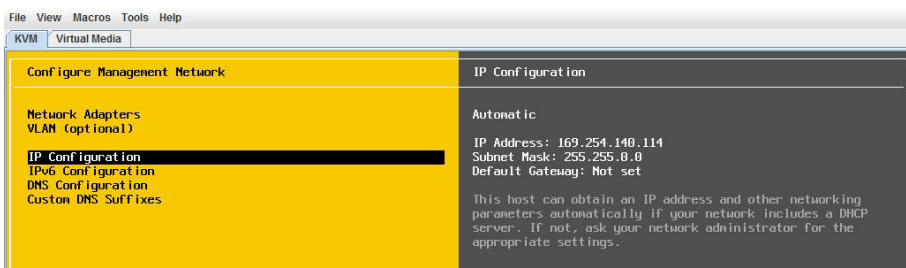

**Step 5:** Using the down arrow key, highlight **Set static IP address and network configuration**, and select it by pressing the space bar.

**Step 6:** Using the down arrow key, enter the assigned values from Table 16 (example:10.5.244.11, 255.255.255.0, 10.5.244.1) for IP address, subnet mask and default gateway, and then press **Enter**.

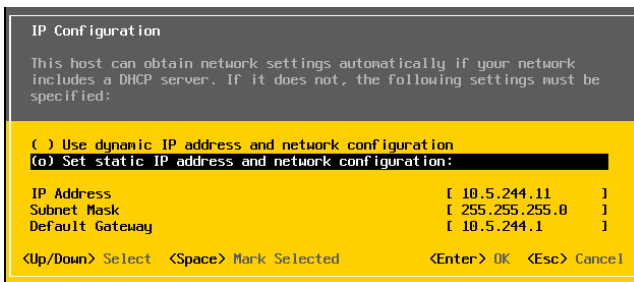

**Step 7:** Using the down arrow, select **DNS Configuration**, and then press **Enter**.

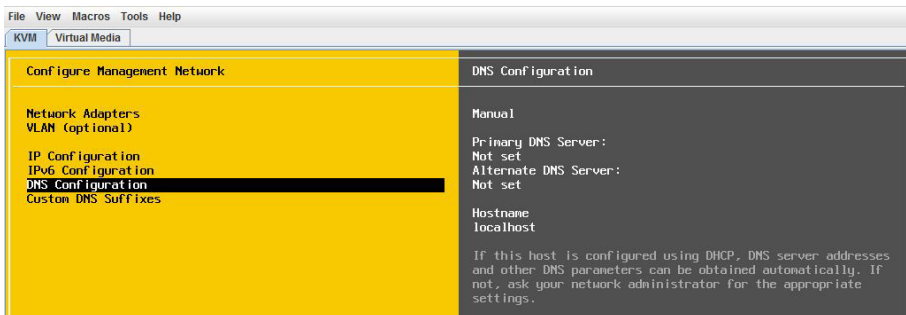

**Step 8:** Configure the primary DNS server and hostname (Example: 10.4.48.10 and RS240-ESXi.cisco.local), and then press **Enter**.

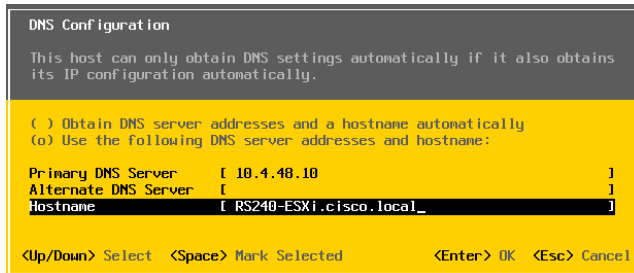

**Step 9:** On the Configure Management Network screen, exit by pressing **ESC**.

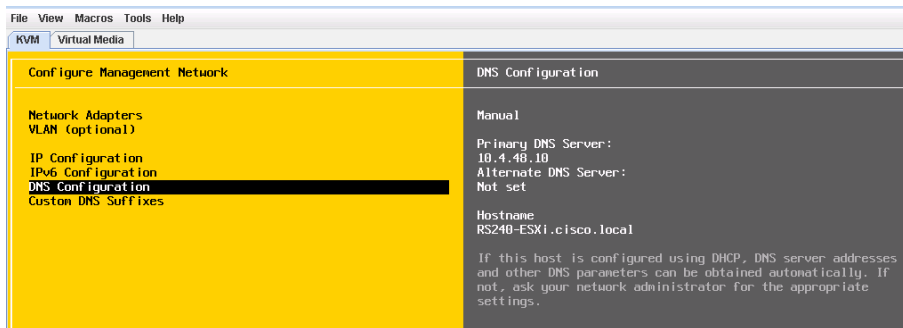

**Step 10:** On the confirmation dialog box, confirm that you want to apply changes and restart by pressing **Y**.

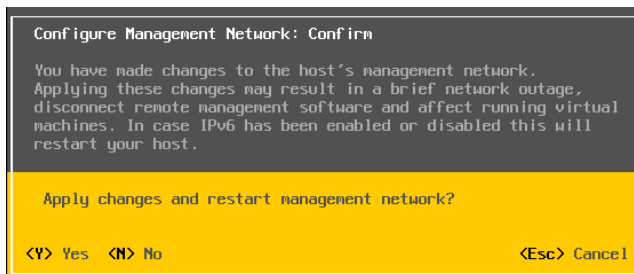

## Procedure 4 Add VMware ESXi host to vCenter

**Step 1:** From the VMware vSphere client, select the folder location where you want to add the ESXi host (Example: WAN and Remote Sites).

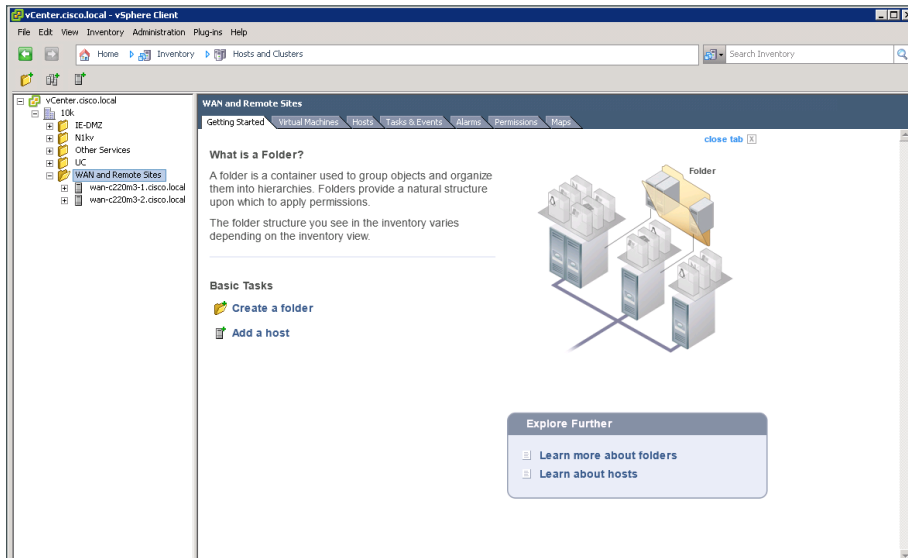

**Step 2:** On the Getting Started tab, under basic tasks, click **Add a host**. The Add Host Wizard appears.

### Tech Tip

You must have the ESXi hostname and IP address configured in your DNS database if you want to be able to reference it by name in the vCenter. Add a new DNS entry if required.

**Step 3:** In the Connection Settings window, enter the hostname of the ESXi host and the username and password [root / c1sco123], and then click **Next**. If necessary, accept the Security Alert by clicking **Yes**.

The screenshot shows the 'Add Host Wizard' window with the 'Specify Connection Settings' step selected. The window title is 'Add Host Wizard'. Below the title bar, the text reads 'Specify Connection Settings' and 'Type in the information used to connect to this host.' On the left side, there is a navigation pane with 'Connection Settings' selected, and other options like 'Host Summary', 'Assign License', 'Lockdown Mode', 'Virtual Machine Location', and 'Ready to Complete'. The main area is divided into two sections: 'Connection' and 'Authorization'. In the 'Connection' section, there is a text box labeled 'Host:' containing the value 'rs240-esxi.cisco.local'. In the 'Authorization' section, there are two text boxes: 'Username:' containing 'root' and 'Password:' containing '\*\*\*\*\*'. At the bottom of the window, there are three buttons: 'Help', '< Back', and 'Next >', with 'Next >' being the active button. A 'Cancel' button is also present.

**Step 4:** In the Host Summary window, verify the details of the ESXi host you wish to add, and then click **Next**.

The screenshot shows the 'Add Host Wizard' window with the 'Host Information' step selected. The window title is 'Add Host Wizard'. Below the title bar, the text reads 'Host Information' and 'Review the product information for the specified host.' On the left side, there is a navigation pane with 'Host Summary' selected, and other options like 'Connection Settings', 'Assign License', 'Lockdown Mode', 'Virtual Machine Location', and 'Ready to Complete'. The main area contains a summary of the host information. It starts with 'You have chosen to add the following host to vCenter:'. Below this, there is a list of details: 'Name: rs240-esxi.cisco.local', 'Vendor: Cisco Systems, Inc.', 'Model: UCS-E1405-M1/K9', and 'Version: VMware ESXi 5.1.0 build-1483097'. There is also a section for 'Virtual Machines:' which is currently empty. At the bottom of the window, there are three buttons: 'Help', '< Back', and 'Next >', with 'Next >' being the active button. A 'Cancel' button is also present.

**Step 5:** In the **Assign License** window, click in the circle to assign the appropriate VMware license key or add a new license key and then click **Next**.

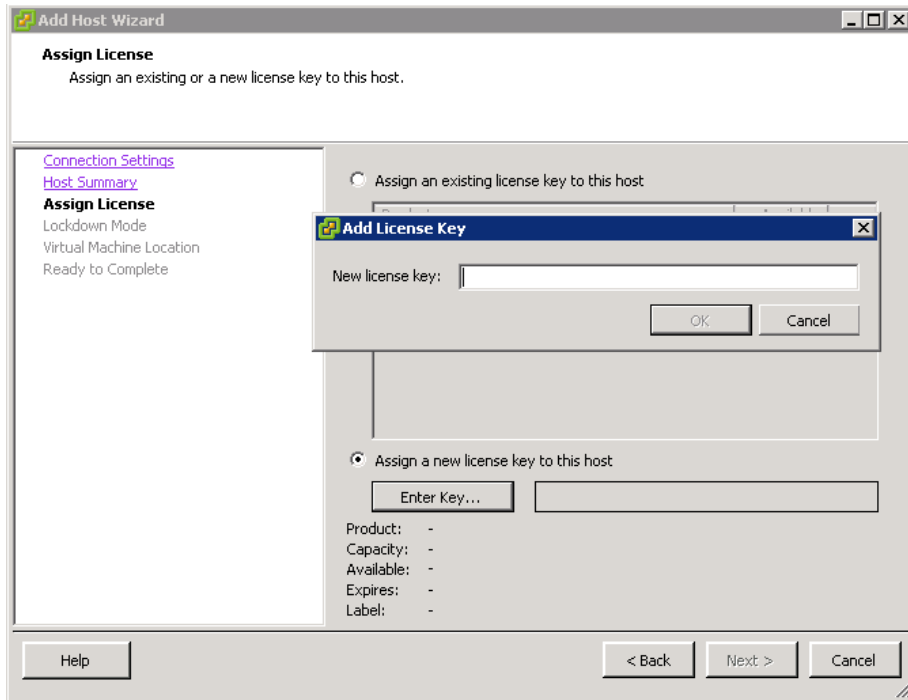

**Step 6:** In the **Lockdown Mode** window, verify that **Enable Lockdown Mode** is cleared, and then click **Next**.

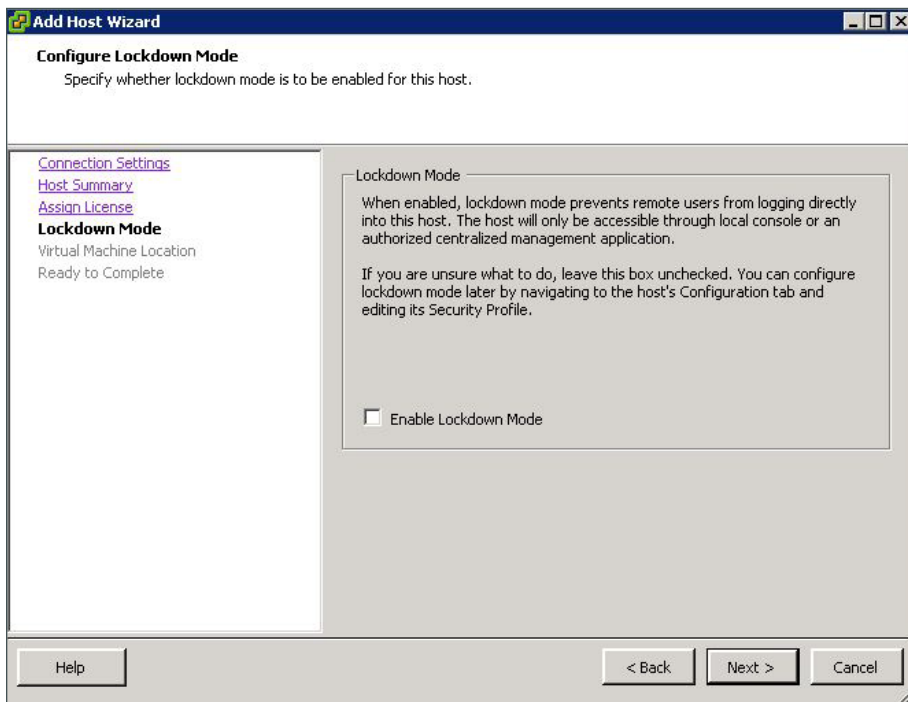

**Step 7:** In the **Virtual Machine Location** window, select the proper location for the new ESXi host, and then click **Next**.

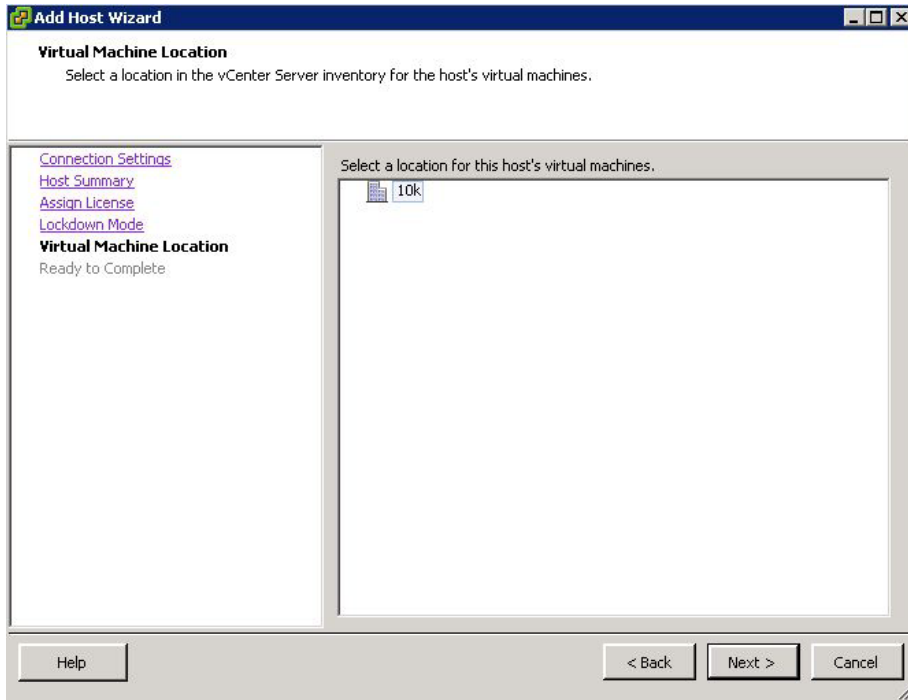

In the **Ready to Complete** summary window, verify the information, and then click **Finish**.

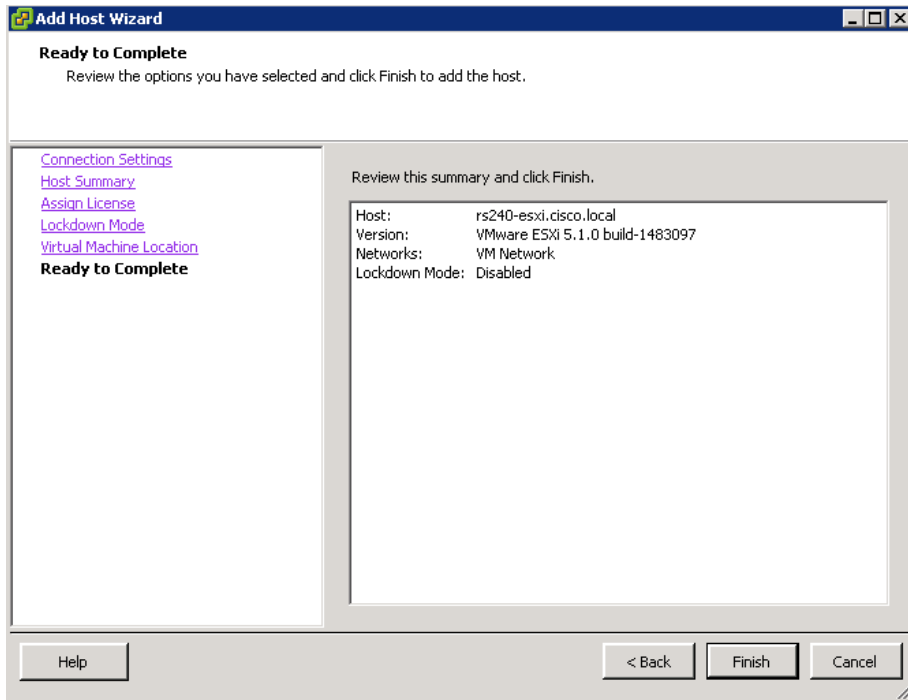



**Step 8:** Select the new ESXi host, click the **Summary** tab, and then verify the information is correct.

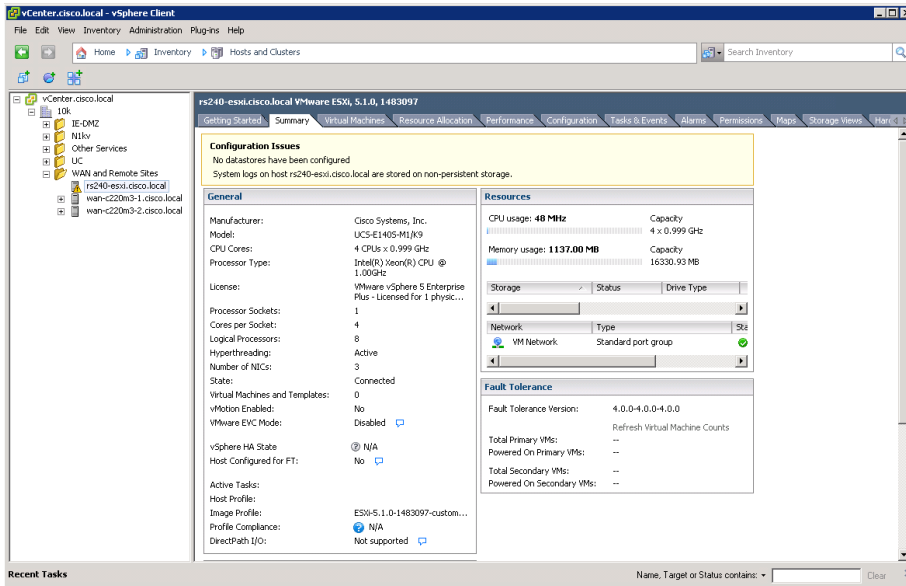

## Procedure 5 Add a datastore to ESXi hosts

In this procedure, you will add storage for the virtual machines and other system files to use. The storage will be a disk drive physically located on the server.

### Tech Tip

If you are installing the vSphere client on a server with USB storage for ESXi, you may receive a warning “System logging not Configured on host <hostname>” indicating that you do not have a location to store log files for ESXi on this host. In this case, you can store log files on a syslog server. More information can be found at: [http://kb.vmware.com/selfservice/microsites/search.do?language=en\\_US&cmd=displayKC&externalId=2003322](http://kb.vmware.com/selfservice/microsites/search.do?language=en_US&cmd=displayKC&externalId=2003322)

**Step 1:** Using vSphere Client, log in to the ESXi host.

**Step 2:** On the Configuration tab, in the Hardware pane, click **Storage**.

**Step 3:** If your ESXi host does not have a provisioned virtual machine file system (VMFS), in main window, in the “The VMware ESX Server does not have persistent storage” message, click **Click here to create a datastore**.

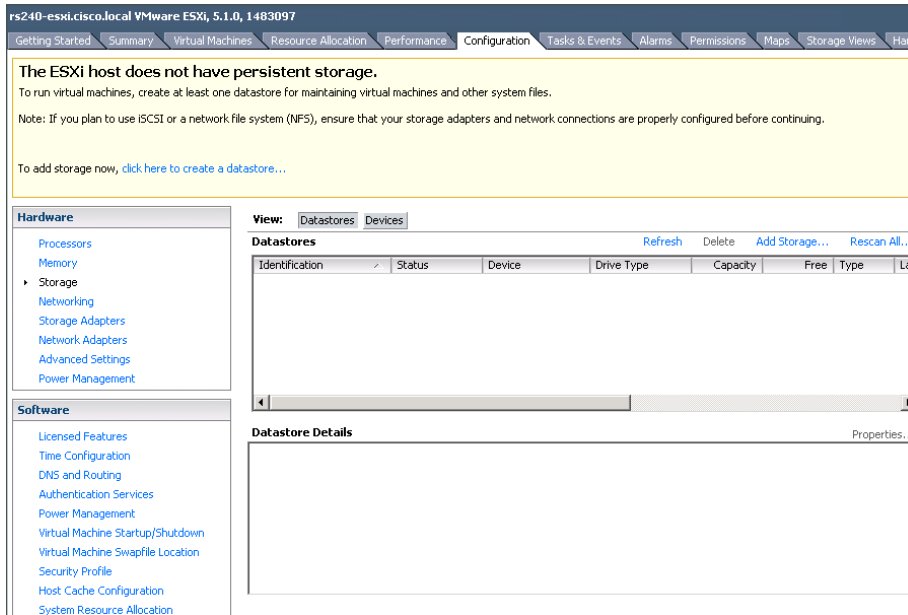

**Step 4:** In the Add Storage wizard, select **Disk/LUN**, and then click **Next**.

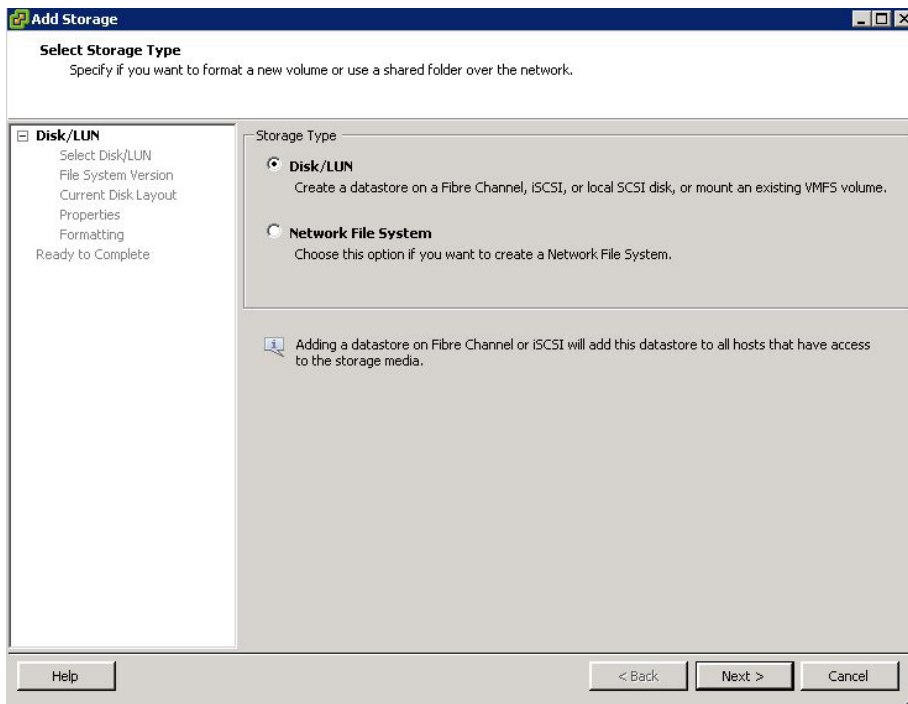

**Step 5:** On the Select Disk/LUN page, select the local disk and then click **Next**.

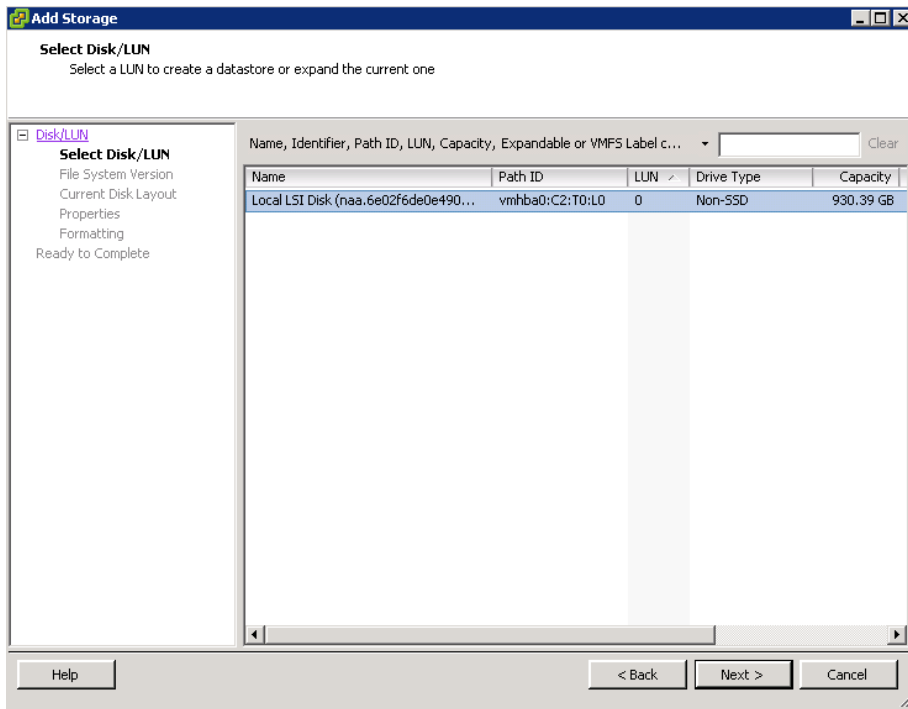

**Step 6:** On the File System Version page, select **VMFS-5**. VMFS-5 uses standard 1 MB file system block size with support of 2 TB+ virtual disks.

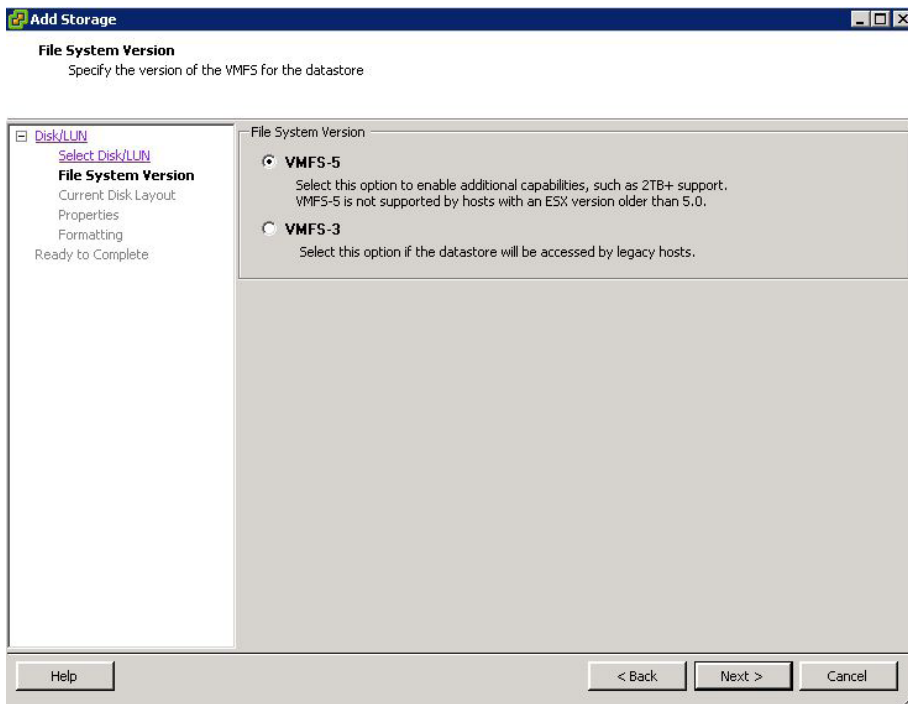

Step 7: Review the disk capacity and partition information, and then click **Next**.

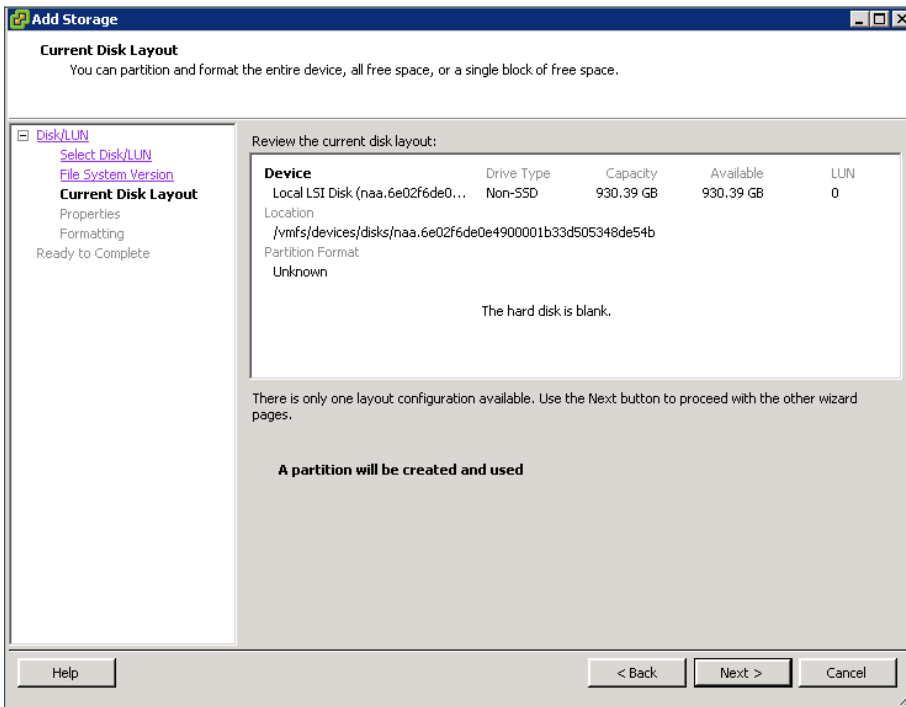

Step 8: Enter a datastore name (Example: RS240-ESXi-LocalDisk), and then click **Next**.

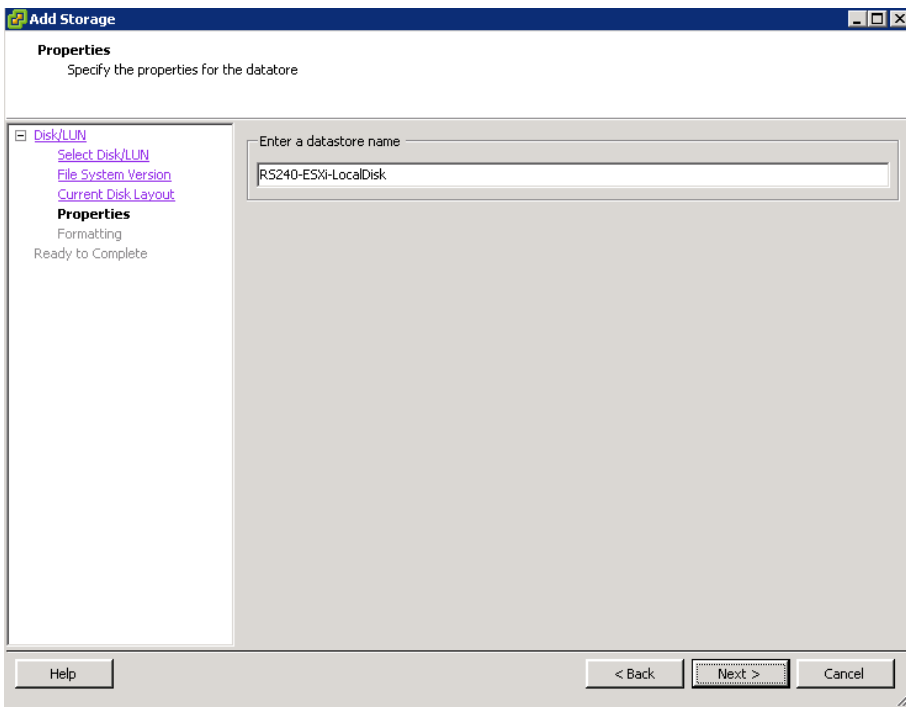

**Step 9:** On the Disk/LUN Formatting page, accept the defaults by clicking **Next**. This formats the maximum available space in the disk.

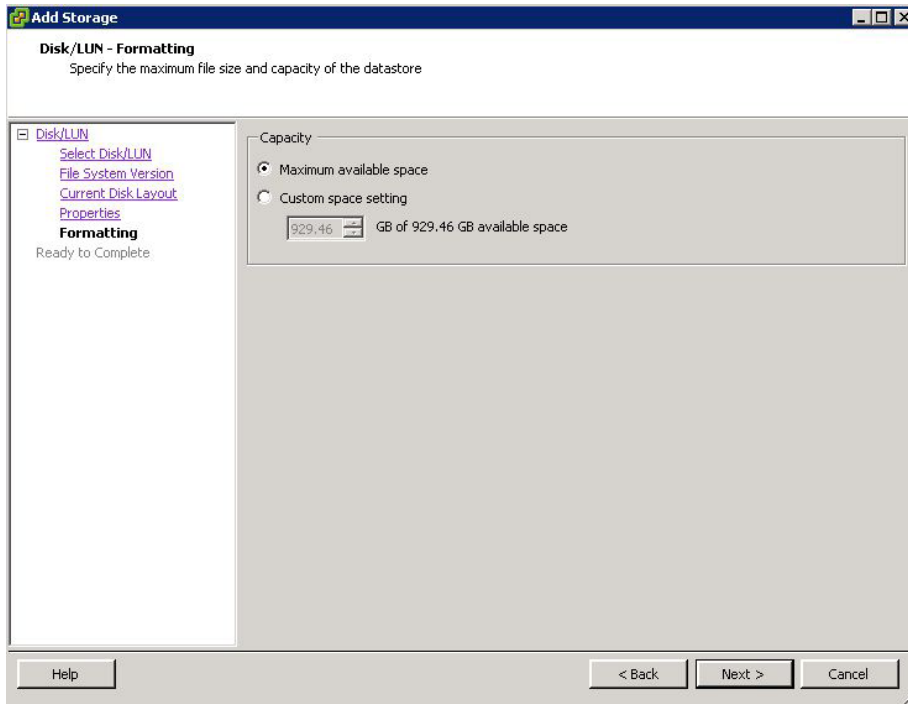

**Step 10:** Click **Finish**. The Add Storage wizard is completed.

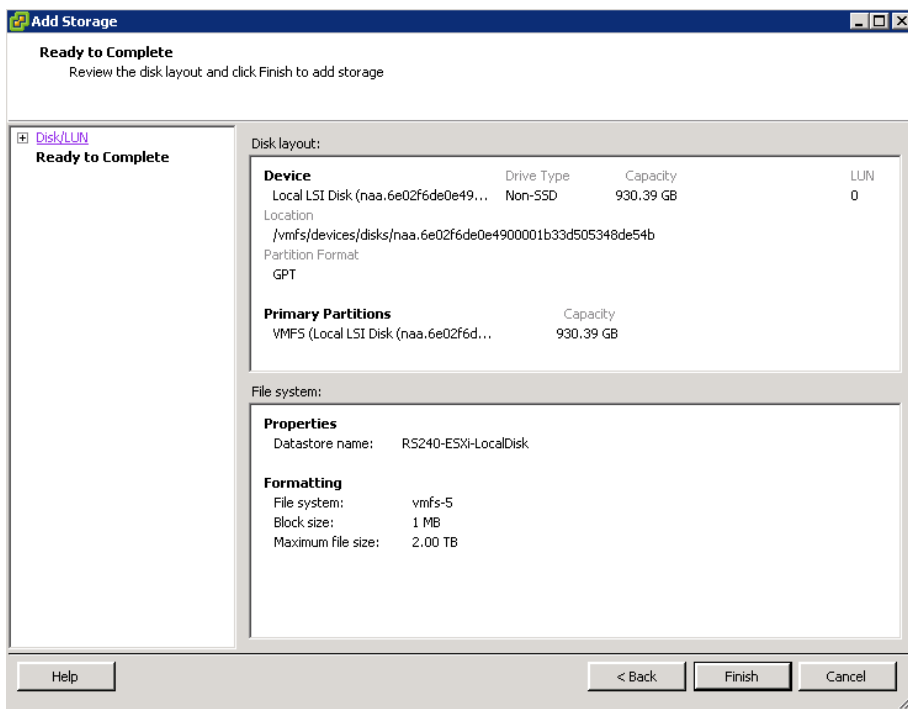

## Procedure 6 Configure networking for ESXi host

The following table is used during this procedure to map the correct network interfaces to the vSwitch.

Table 17 - Cisco UCS E-Series Interface Assignments

Interface usage	UCS-E140S (single wide)	UCS-E140D (double wide)
console/internal	vmnic0	vmnic0
internal MGF	vmnic1	vmnic1
external (1)	vmnic2	vmnic2
external (2)		vmnic3
vSwitch Port Group Network Label	ESXi-external	ESXi-external-dual

**Step 1:** Click the **Configuration** tab, and then click **Networking**.

The screenshot displays the VMware vSphere Client interface for an ESXi host. The 'Configuration' tab is active, and the 'Networking' section is expanded. The 'Standard Switch: vSwitch0' is selected, showing a 'VM Network' port group connected to a 'VMkernel Port' and a 'Management Network'. The 'Physical Adapters' section shows 'vmnic0' with a speed of 1000 and status 'Full'.

**Step 2:** Click **Add Networking**, on the Connection Type dialog box, select **Virtual Machine**, and then click **Next**.

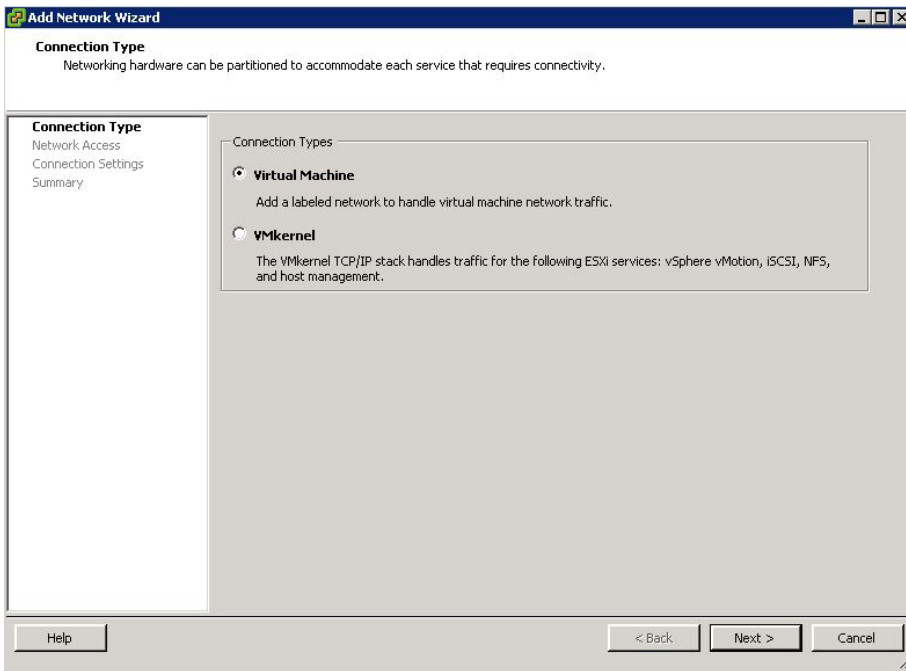

Next, configure a standard vSwitch for ESXi.

**Step 3:** Clear **vmnic1** and select the external NIC card, **vmnic2**, to be used for this vSwitch, and then click **Next**. This example uses a single interface. For dual NIC configurations, select both **vmnic2** and **vmnic3**.

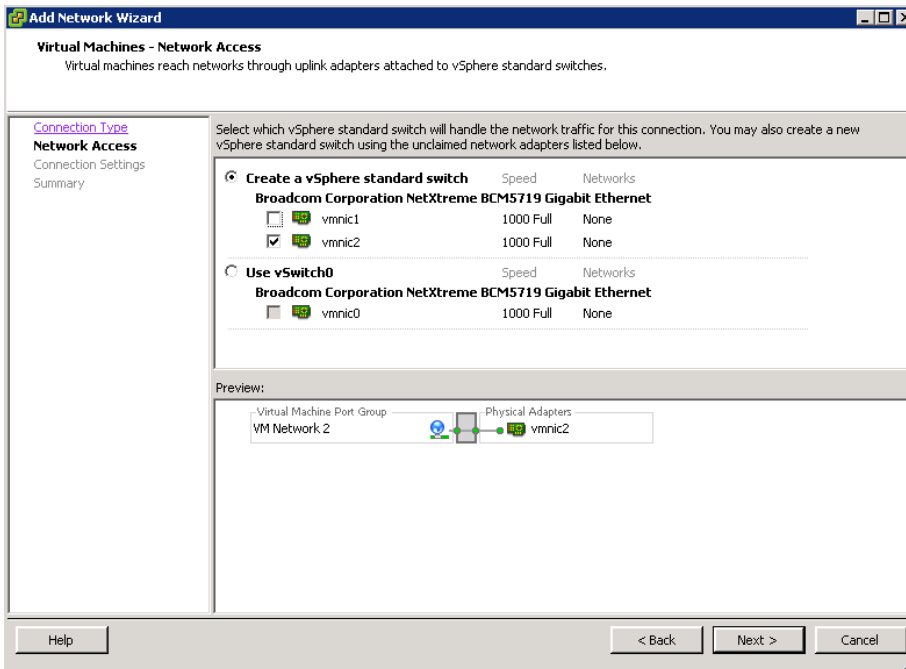

**Step 4:** In the Port Group Properties pane, edit the Network Label (Example from : ESXi-external), set the VLAN ID to **None (0)**, and then click **Next**.

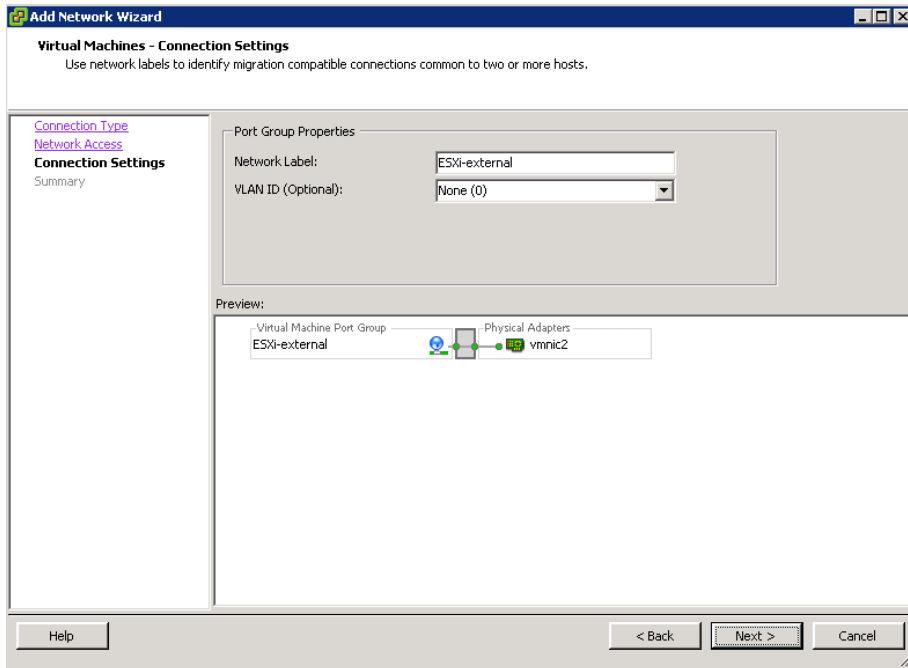

**Step 5:** Review the final host networking configuration, and then click **Finish**.

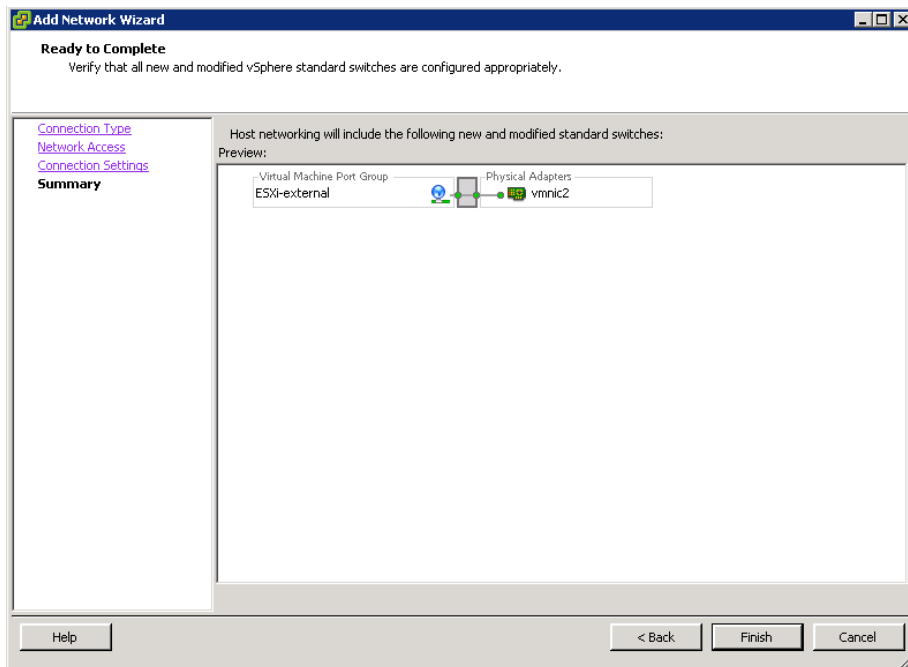



## Procedure 7 Configure ESXi NIC teaming for resiliency

### Optional

This procedure is only required if you have two external NICs connecting to external switches for resiliency. This example uses the default ESXi NIC teaming configurations for redundancy.

This procedure uses the values in to map the correct network interfaces to the vSwitch.

**Step 1:** View properties by clicking **properties** for the newly created vSwitch (Example: vSwitch1).

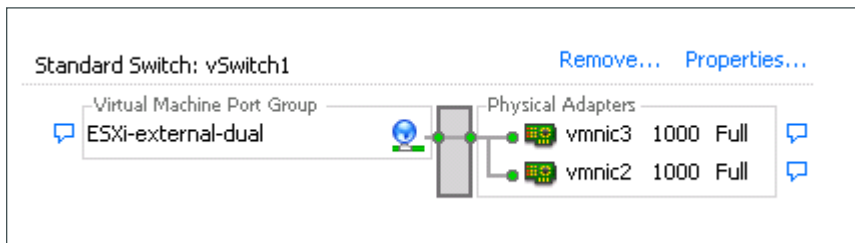

**Step 2:** In the vSwitch Properties window, select the Port Group (Example: ESXi-external-dual), and click **Edit**.

### Tech Tip

This NIC redundancy configuration using the default VMware settings provides failover for link or switch failure for applications installed on a Cisco UCS E-Series double-wide module such as the UCSE140D.

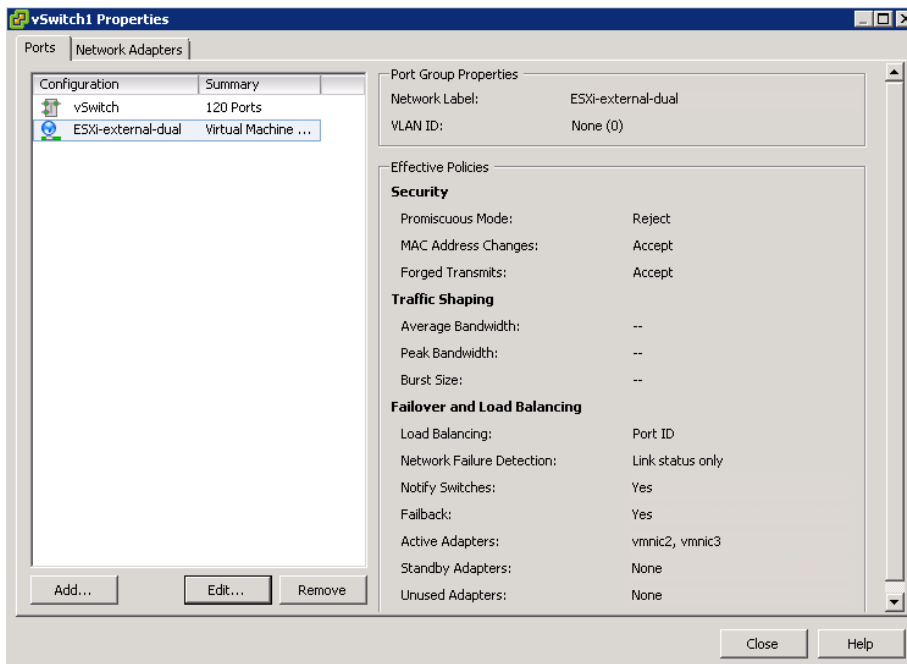

**Step 3:** In the Port Group Properties window, view the Failover and Load Balancing details by selecting the **NIC Teaming** tab. The configuration options display.

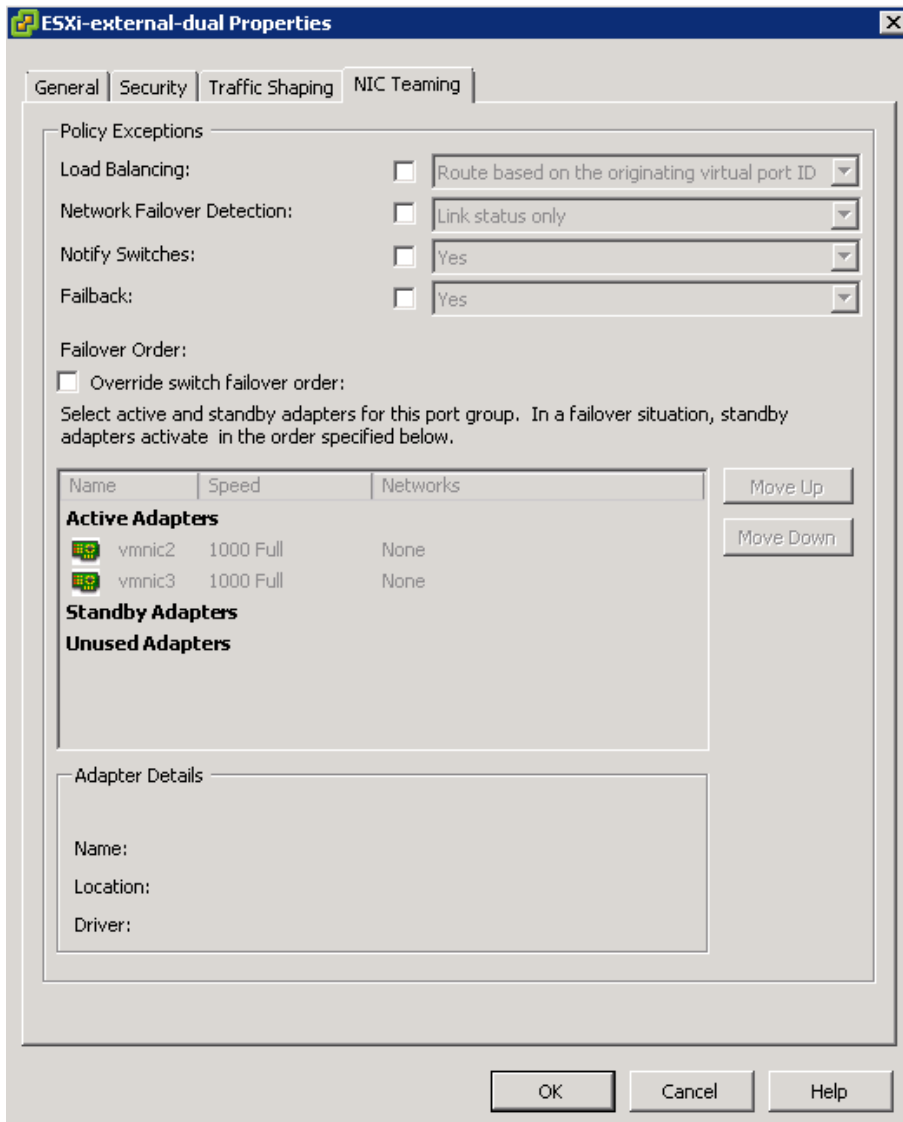

## Configuring Cisco vWAAS on the UCS E-Series module

1. Deploy the OVA
2. Configure the WAAS Node
3. Configure WCCPv2 on routers

To avoid WAN congestion and possible installation issues, download or copy the installation Open Virtual Appliance (OVA) files to a local host at the remote location and perform the installation from a remote host at that location.

Cisco vWAAS is available as OVA and is designed to be installed into a virtual environment. The OVA is an industry standard format with prepackaged disk, memory, CPU, NICs, and other virtual-machine-related configuration parameters.

### Procedure 1 Deploy the OVA

**Step 1:** From vCenter, click the ESXi host that you will use to run your virtual machine (Example: rs240-esxi.cisco.local).

**Step 2:** From the **File** menu, choose **Deploy OVF template**.

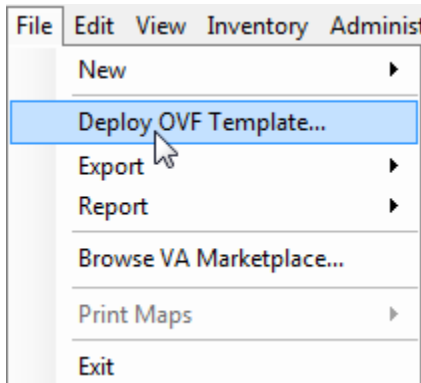

Step 3: Browse for the local OVA file to install, and then click **Next**.

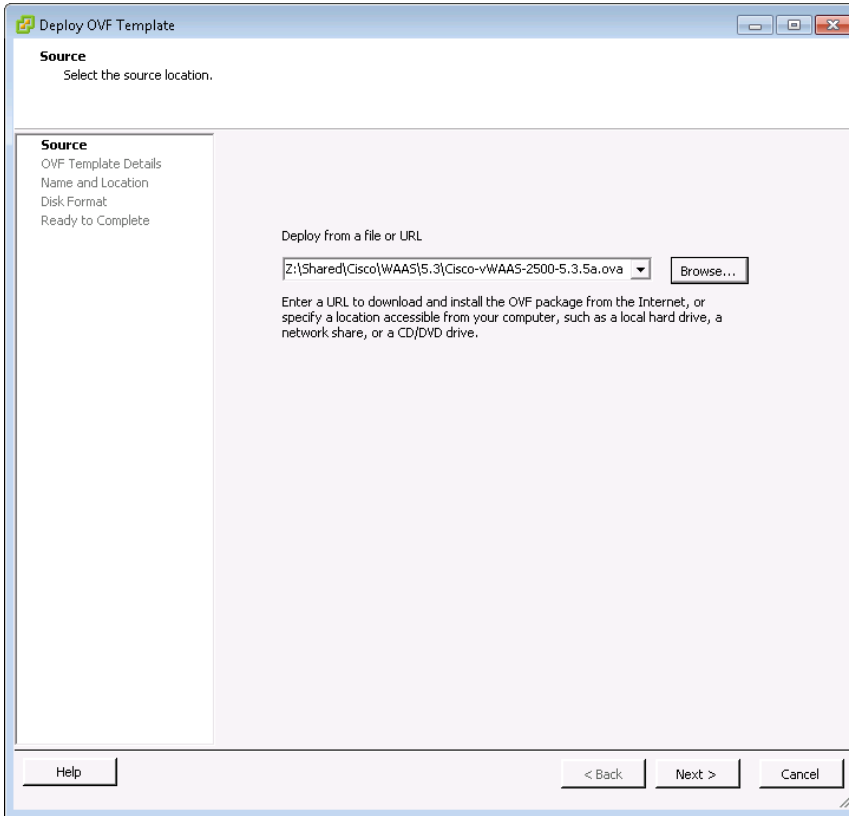

Step 4: Review the template details, and then click **Next**.

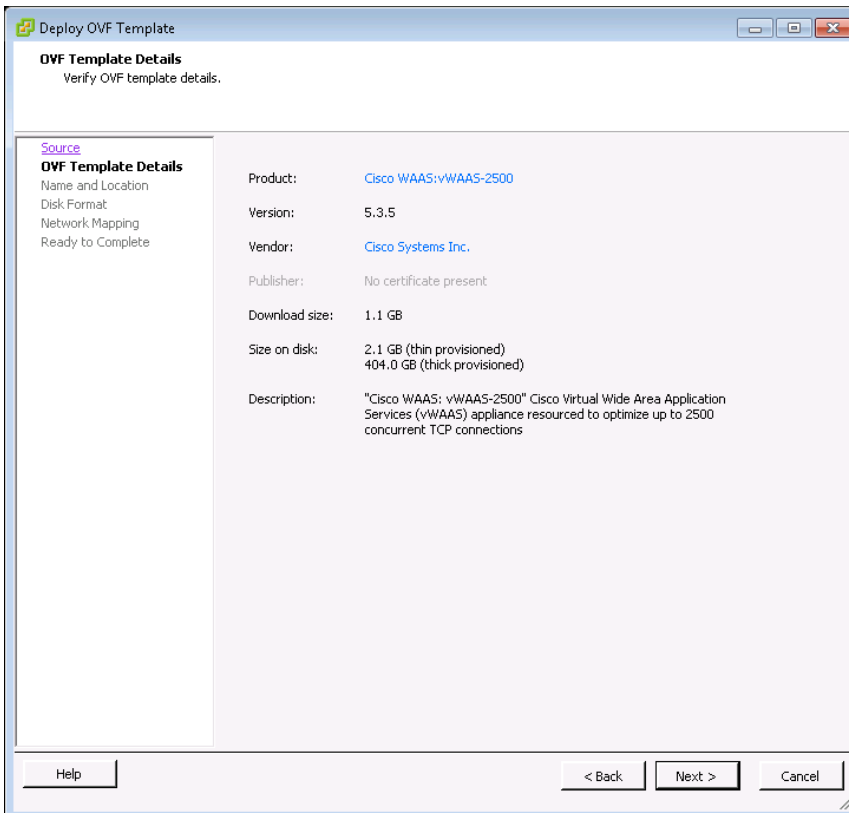

**Step 5:** Enter a name for the OVA (Example: RS240-vWAAS-2500), select the proper location, and then click **Next**.

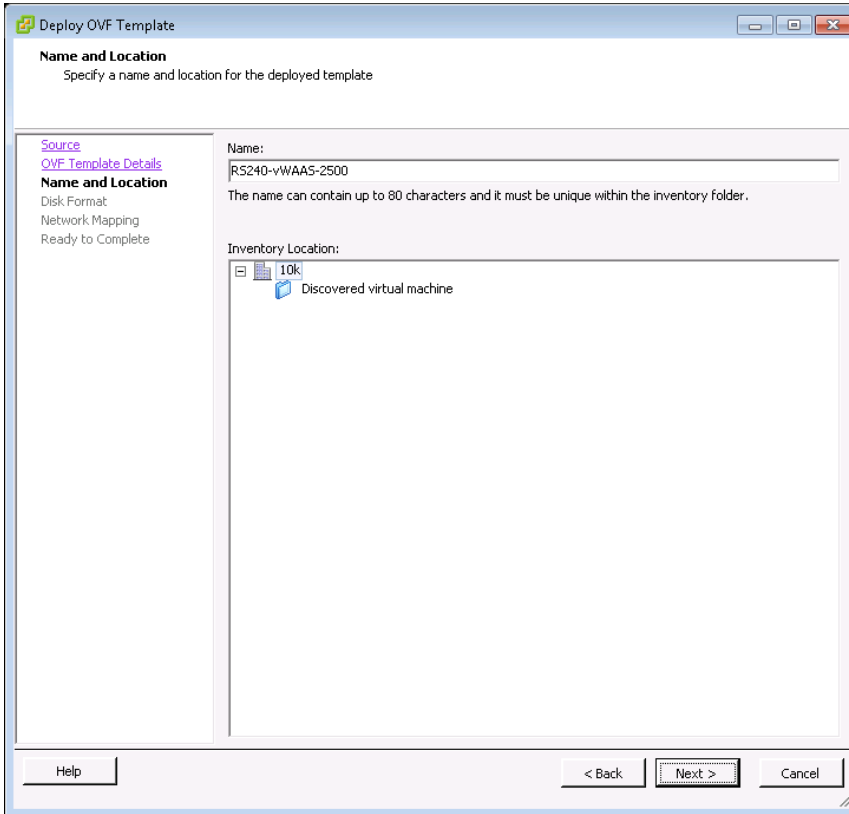

**Step 6:** Accept the recommended Disk Format settings by clicking **Next**.

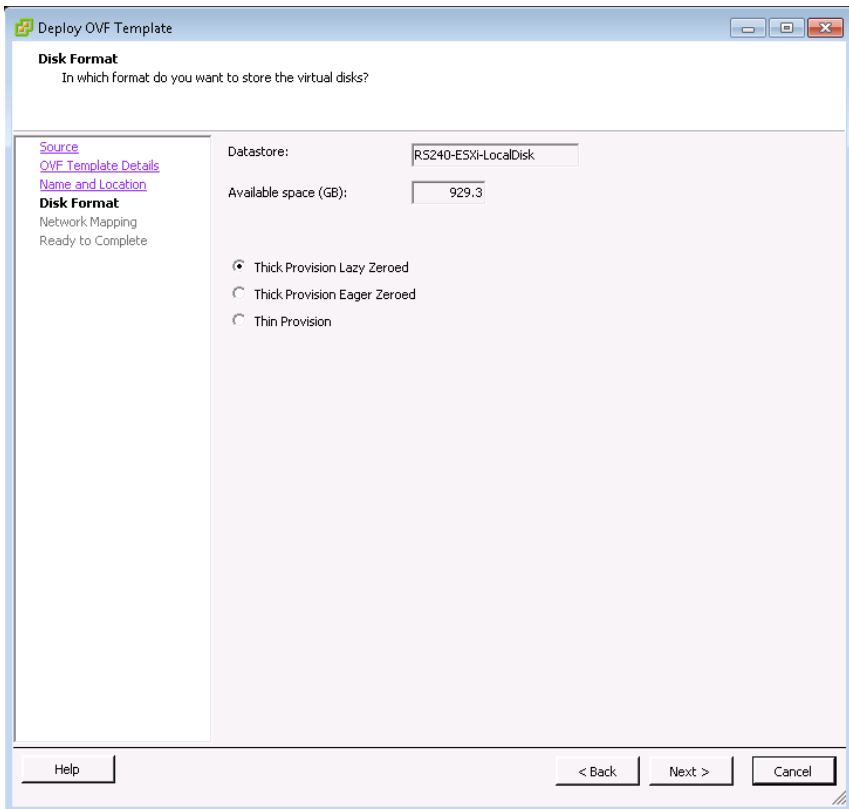

**Step 7:** Click the current setting for Destination Networks. All destination network choices are displayed.

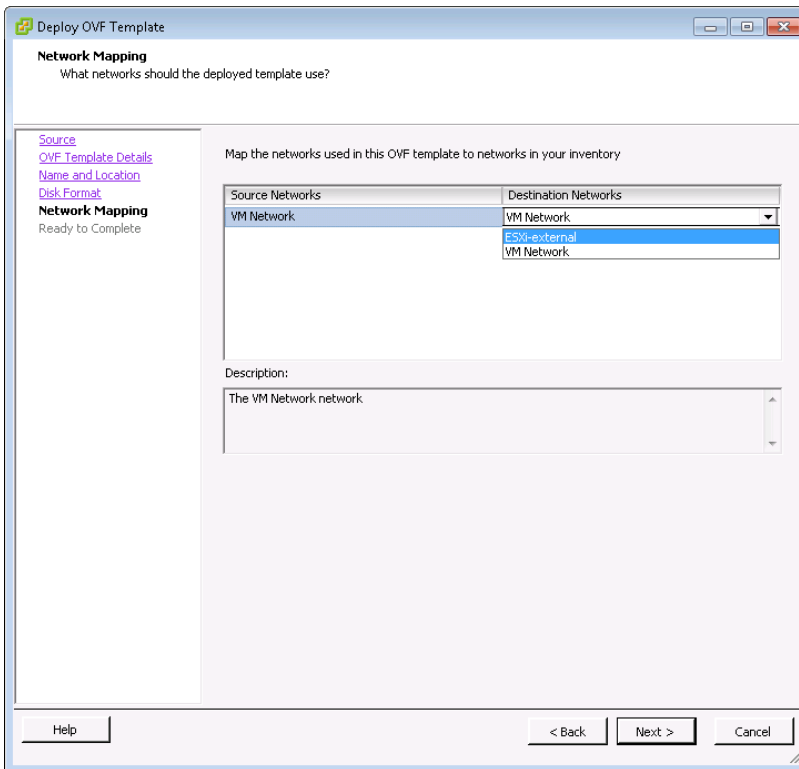

**Step 8:** Select the destination network by choosing the ESXi networking profile created in , Step 4 (Example: ESXi-external), and then click **Next**.

**Step 9:** Review the OVA summary information, select **Power on after deployment**, and then click **Finish**.

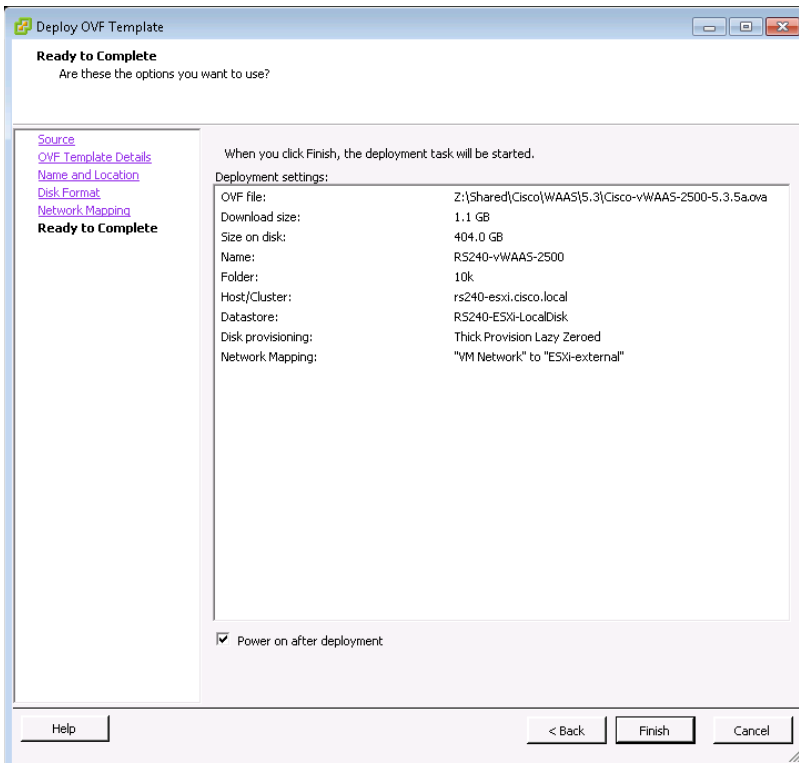

Step 10: Monitor the deployment.

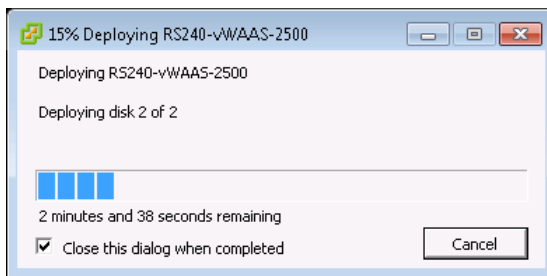

Step 11: After the OVA is installed, highlight the installed OVA, and then, on the **Summary** tab, verify its status.

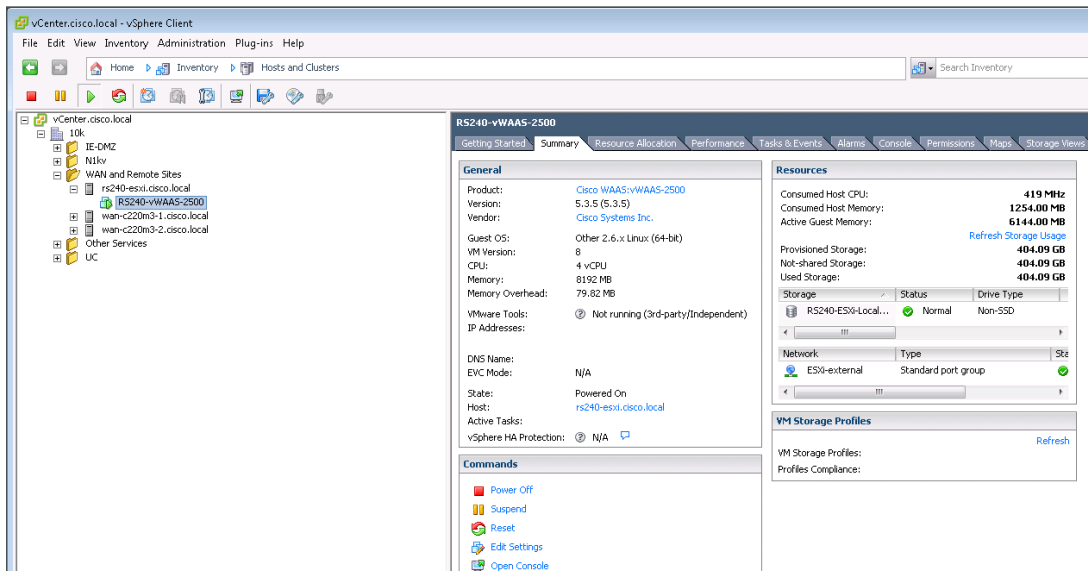

## Procedure 2 Configure the WAAS Node

This procedure uses the recommended network parameters from Table 16, repeated below.

Table 18 - Cisco vWAAS on the Cisco UCS E-Series module network parameters

Parameter	CVD values for an access-layer connection	CVD values for a distribution-layer connection	Site-specific values
In-band management network	10.5.244.0/24 (existing data subnet)	10.5.96.32/29 (new subnet for UCS E management)	
UCS E-Series interface address	unnumbered gig0/2.64	10.5.96.33/29	
Cisco IMC interface address	10.5.244.10/24	10.5.96.34/29	
VMware ESXi interface address	10.5.244.11/24	10.5.96.35/29	
Switch interface number	1/0/22	1/1/7	
VLAN number	64	106	
Time zone	PST8PDT -8 0	PST8PDT -8 0	
IP address	10.5.244.8/24	10.5.103.8/24	
Default gateway	10.5.244.1/24	10.5.103.1/24	
WAAS Central Manager	10.4.48.100	10.4.48.100	
Hostname	RS240-vWAAS-2500	RS217-vWAAS-2500-1	
IP addresses of routers intercepting traffic with WCCP	10.255.251.240	10.255.253.217	
WCCP password	c1sco123	c1sco123	
Management network (optional)	10.4.48.0/24	10.4.48.0/24	
TACACS shared key (optional)	SecretKey	SecretKey	



**Step 1:** From vCenter, click the Cisco vWAAS that you will want to configure (Example: RS213-vWAAS-1300), and then click the **Summary** tab.

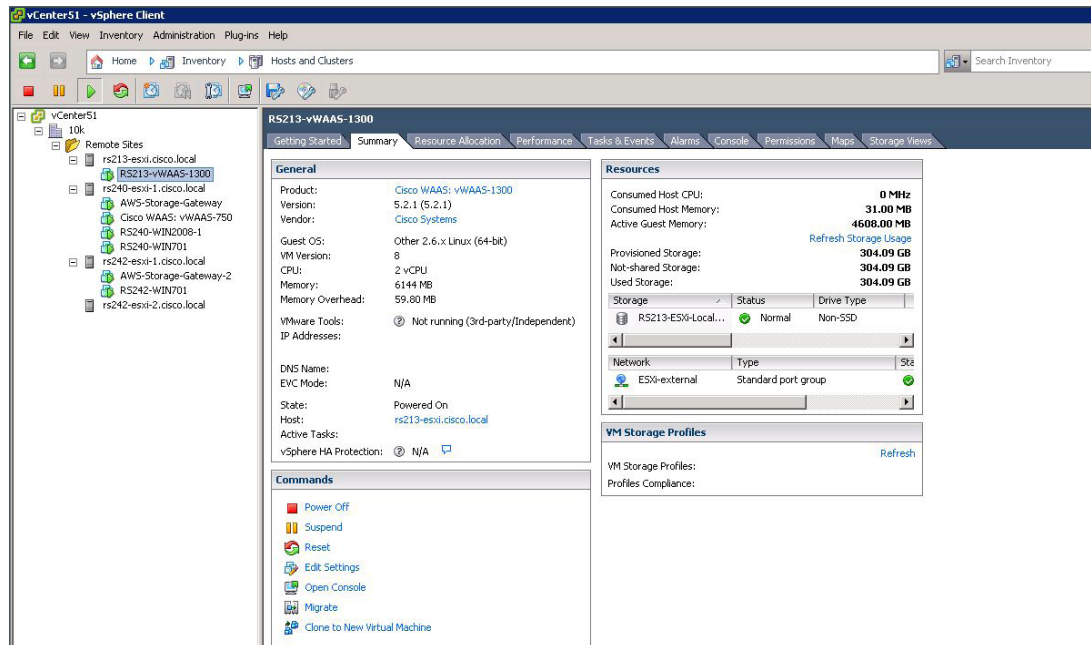

**Step 2:** In the Commands pane, click **Open Console**, and then log in. The factory default username is **admin** and the factory default password is **default**.

**Step 3:** In the console window, enter **setup**. The initial setup utility starts.

```

Parameter                                Default Value
Device Mode                               Application Accelerator
1. Interception Method                    WCCP
2. Time Zone                              UTC 0 0
3. Management Interface                    Virtual 1/0
   Autosense                              Disabled
4. DHCP                                   Enabled
ESC Quit ? Help _____ WAAS Default Configuration _____
Press 'y' to select above defaults, 'n' to configure all, <1-4> to change
specific default [y]: 4

```

**Step 4:** Disable DHCP.

```

Enable DHCP for Management Interface? (y/n) [y]: n
Parameter                                Configured Value
Device Mode                               Application Accelerator
1. Interception Method                    WCCP
2. Time Zone                              UTC 0 0
3. Management Interface                    Virtual 1/0
   Autosense                              Disabled
4. DHCP                                   Disabled
ESC Quit ? Help _____ WAAS Default Configuration _____
Press 'y' to select above defaults, 'n' to configure all, <1-4> to change
specific default [y]: n

```

**Step 5:** Configure the interception method.

```
1. WCCP
2. AppNav Controller
3. VPATH
4. Other
Select Interception Method [1]: 1
```

**Step 6:** Configure the time zone.

```
Enter Time Zone <Time Zone Hours(-23 to 23) Minutes(0-59)> [UTC 0 0]: PST8PDT -8
0
```

**Step 7:** Configure the management interface, IP address, and default gateway.

This design uses the external interface as the management interface.

```
No.      Interface Name      IP Address      Network Mask
  1. Virtual          1/0             dhcp
  2. Virtual          2/0             dhcp
Select Management Interface [1]: 1
Enable DHCP for Management Interface? (y/n) [y]: n
Enter Management Interface IP Address <a.b.c.d or a.b.c.d/X(optional mask bits)>
[ Not configured]: 10.5.244.8/24
Enter Default Gateway: 10.5.244.1
```

**Step 8:** Configure the Cisco WAAS Central Manager address.

```
Enter Central Manager IP Address (WARNING: An invalid entry will cause SETUP to
take a long time when applying WAAS configuration) [None]: 10.4.48.100
```

**Step 9:** Configure DNS, host, and NTP settings.

```
Enter Domain Name Server IP Address [Not configured]: 10.4.48.10
Enter Domain Name(s) (Not configured): cisco.local
Enter Host Name (None): RS240-vWAAS-2500
Enter NTP Server IP Address [None]: 10.4.48.17
```

**Step 10:** Configure the WCCP router list.

```
Enter WCCP Router (max 4) IP Address list (ip1 ip2 ...) []: 10.255.251.240
```

**Step 11:** Select the appropriate license.

```
The product supports the following licenses:
1. Transport
2. Enterprise
3. Enterprise & Video
Enter the license(s) you purchased [2]: 2
```

**Step 12:** Verify the configuration settings.

```
Parameter                               Configured Value
2. Time Zone                             PST8PDT -8 0
3. Management Interface                   Virtual 1/0
    Autosense                             Disabled
4.    DHCP                                Disabled
    Speed                                  1000 (full-duplex)
5.    IP Address                           10.5.244.8
6.    IP Network Mask                       255.255.255.0
7. IP Default Gateway                     10.5.244.1
8. CM IP Address                           10.4.48.100
9. DNS IP Address                          10.4.48.10
10. Domain Name(s)                         cisco.local
11. Host Name                              RS240-vWAAS-2500
12. NTP Server Address                     10.4.48.17
13. WCCP Router List                       10.255.251.240
13. License                                Enterprise
ESC Quit ? Help ! CLI _____ WAAS Final Configuration _____
Press 'y' to select configuration, <F2> to see all configuration, 'd' to toggle
defaults display, <1-12> to change specific parameter [y]: y
    Router WCCP configuration
First WCCP router IP in the WCCP router list seems to be an external address;
WCCP configuration on external routers is not allowed through SETUP. Please press
ENTER to apply WAAS configuration on WAVE ...
Applying WAAS configuration on WAE ...
May take a few seconds to complete ...
WAAS configuration applied successfully!!
Saved configuration to memory.
Press ENTER to continue ...
```

When you are prompted with a recommended router WCCP configuration template, you don't have to retain the information. This router configuration is covered in depth in a following procedure.

**Step 13:** In the EXEC mode, enable the propagation of local configuration changes to the Cisco WAAS Central Manager.

```
cms lcm enable
```

**Step 14:** Configure the GRE-negotiated return. All Cisco WAVE devices use GRE-negotiated return with their respective WCCP routers.

```
wccp tcp-promiscuous service-pair 61 62 redirect-method gre
wccp tcp-promiscuous service-pair 61 62 egress-method wccp-gre
```

**Step 15:** Configure the WCCP router list. This design uses authentication between the routers and Cisco WAVE appliances.

If any of the WCCP routers are Cisco ASR1000 Series routers, then change the default setting of **hash-source-ip** to **mask-assign**. This change must be made for WCCP to operate properly and is made on the Cisco WAVE appliances, not on the routers.

```
wccp tcp-promiscuous service-pair 61 62 router-list-num 7
wccp tcp-promiscuous service-pair 61 62 assignment-method mask
wccp tcp-promiscuous service-pair 61 62 password cisco123
wccp tcp-promiscuous service-pair 61 62 enable
```

All other router platforms can use the default setting:

```
wccp tcp-promiscuous service-pair 61 62 router-list-num 7
wccp tcp-promiscuous service-pair 61 62 password cisco123
wccp tcp-promiscuous service-pair 61 62 enable
```

Next, you will configure device management protocols.

**Step 16:** Log in to the Cisco vWAAS.

**Step 17:** Generate the RSA key and enable the sshd service. This enables SSH.

```
ssh-key-generate key-length 2048
sshd enable
no telnet enable
```

**Step 18:** Enable Simple Network Management Protocol (SNMP) in order to allow the network infrastructure devices to be managed by a Network Management System (NMS), and then configure SNMPv2c both for a read-only and a read-write community string.

```
snmp-server community cisco
snmp-server community cisco123 RW
```

**Step 19:** If you want to limit access to the appliance, configure management ACLs.

In networks where network operational support is centralized, you can increase network security by using an access list to limit the networks that can access your device. In this example, only devices on the 10.4.48.0/24 network are able to access the device via SSH or SNMP.

```
ip access-list extended 155
 permit tcp 10.4.48.0 0.0.0.255 any eq ssh
 deny tcp any any eq ssh
 permit ip any any
 exit
interface Virtual 1/0
 ip access-group 155 in
 exit
!
ip access-list standard 55
 permit 10.4.48.0 0.0.0.255
 exit
snmp-server access-list 55
```

**Step 20:** If you have a centralized TACACS+ server, enable AAA authentication for access control. This configures secure user authentication as the primary method for user authentication (login) and user authorization (configuration). AAA controls all management access to the Cisco WAAS and Cisco WAVE devices (SSH and HTTPS).

**i** Tech Tip

A factory default local admin user was created on the Cisco WAAS and Cisco WAVE appliances during setup. This user account provides the ability to manage the device in case the centralized TACACS+ server is unavailable or if you do not have a TACACS+ server in your organization.

```
tacacs key SecretKey
tacacs password ascii
tacacs host 10.4.48.15 primary
!
authentication login local enable secondary
authentication login tacacs enable primary
authentication configuration local enable secondary
authentication configuration tacacs enable primary
authentication fail-over server-unreachable
```

**Step 21:** After you make configuration changes, in the EXEC mode, save the configuration.

```
copy running-config startup-config
```

Each Cisco vWAAS instance registers with the Cisco WAAS Central Manager as it becomes active on the network.

**Step 22:** If you want to verify the Cisco vWAAS registration, on the respective vWAAS instance or via the web interface to the Cisco WAAS Central Manager, enter **show cms info**.

### Procedure 3 Configure WCCPv2 on routers

In this design, WCCP diverts network traffic destined for the WAN to the Cisco WAAS system for optimization. This method provides for a clean deployment with minimal additional cabling, and it requires both the WAN-aggregation and remote-site routers to be configured for WCCP.

This guide assumes that the router has already been configured. Only the procedures required to support the integration of Cisco WAAS into the deployment are included. Full details on WAN router configuration are included in the [MPLS WAN Technology Design Guide](#) or [VPN WAN Technology Design Guide](#).

**Step 1:** Configure global WCCP parameters, enable services 61 and 62, and then configure a group list and password. Permit only the on-site Cisco WAVE appliances in the group list in order to prevent unauthorized Cisco WAVE devices from joining the WAAS cluster.

You must enable services 61 and 62 for WCCP redirect for Cisco WAAS. These services should be using WCCP Version 2. As a best practice, exempt certain critical traffic types and other protocols which can not be optimized from WCCP redirect by using a redirect list. A detailed listing is included in Table 11 and Table 12.

```

ip wccp source-interface Loopback0
ip wccp 61 redirect-list WAAS-REDIRECT-LIST group-list WAVE password c1sco123
ip wccp 62 redirect-list WAAS-REDIRECT-LIST group-list WAVE password c1sco123
!
ip access-list standard WAVE
  permit 10.5.244.8
ip access-list extended WAAS-REDIRECT-LIST
  remark WAAS WCCP Redirect List
  deny tcp any any eq 22
  deny tcp any eq 22 any
  deny tcp any eq telnet any
  deny tcp any any eq telnet
  deny tcp any eq tacacs any
  deny tcp any any eq tacacs
  deny tcp any eq bgp any
  deny tcp any any eq bgp
  deny tcp any any eq 123
  deny tcp any eq 123 any
  deny tcp any any eq 161
  deny tcp any eq 161 any
  deny tcp any any eq 162
  deny tcp any eq 162 any
  deny tcp any any eq 2000
  deny tcp any eq 2000 any
  deny tcp any any eq 2443
  deny tcp any eq 2443 any
  deny tcp any any eq 5060
  deny tcp any eq 5060 any
  deny tcp any any eq 5061
  deny tcp any eq 5061 any
  deny tcp any any eq 1718
  deny tcp any eq 1718 any
  deny tcp any any eq 1720
  deny tcp any eq 1720 any
  deny tcp any any eq 2428
  deny tcp any eq 2428 any
  deny tcp any any eq 443
  deny tcp any eq 443 any
  deny tcp any any eq 8443
  deny tcp any eq 8443 any
  deny tcp any any eq 6970
  deny tcp any eq 6970 any
  deny tcp any any eq 689
  deny tcp any eq 689 any
  permit tcp any any

```

**Step 2:** Configure WCCP redirection for traffic from the LAN.

Specific interfaces must be identified where traffic to and from the WAN are intercepted.

Traffic from the LAN is intercepted with service 61 inbound on all LAN interfaces. It is not necessary to configure WCCP interception on voice interfaces and voice VLANs.

If the LAN interface is a Layer 3 interface, define WCCP redirection on the interface directly.

```
interface Port-Channel1
  ip wccp 61 redirect in
```

If the LAN interface is a VLAN trunk, define WCCP redirection on the data VLAN subinterface.

```
interface GigabitEthernet0/2.64
  ip wccp 61 redirect in
```

**Step 3:** Configure WCCP redirection for traffic from the WAN.

Traffic from the WAN is intercepted with service 62 inbound on all WAN interfaces, including DMVPN tunnel interfaces (but not their underlying physical interfaces).

**Example: MPLS WAN Interface**

```
interface GigabitEthernet0/3
  ip wccp 62 redirect in
```

**Example: DMVPN WAN Interface**

```
interface Tunnel10
  ip wccp 62 redirect in
```

**Step 4:** After you make configuration changes, save the configuration.

```
copy running-config startup-config
```

**Step 5:** If you have multiple WAN routers at the site, repeat Step 1 through Step 4 for each WAN router.

## Configuring Cisco WAAS on the Cisco Services-Ready Engine module

1. Configure remote switch for Cisco SRE
2. Configure the Cisco SRE module
3. Configure the WAAS Node
4. Configure WCCPv2 on routers

The following table specifies the parameters and data, in addition to the universal design parameters, that you need in order to set up and configure the Cisco SRE module. For your convenience, you can enter your values in the table and refer to it when configuring the SRE module. The values you enter will differ from those in this example, which are provided for demonstration purposes only.

Table 19 - Cisco WAAS on the Cisco SRE module network parameters

Parameter	CVD values primary WAVE	CVD values secondary WAVE	Site-specific values
Switch interface number	1/0/3	1/0/4	
VLAN number	64	64	
Time zone	PST8PDT -8 0	PST8PDT -8 0	
IP address	10.5.52.8/24	10.5.52.9/24	
Default gateway	10.5.52.1/24	10.5.52.1/24	
WAAS Central Manager	10.4.48.100	10.4.48.100	
Hostname	RS203-WAVE-SRE-1	RS203-WAVE-SRE-2	
IP addresses of routers intercepting traffic with WCCP	10.255.251.203 (r1) 10.255.253.203 (r2)	10.255.251.203 (r1) 10.255.253.203 (r2)	
WCCP password	c1sco123	c1sco123	
Management network (optional)	10.4.48.0/24	10.4.48.0/24	
TACACS shared key (optional)	SecretKey	SecretKey	

### Procedure 1 Configure remote switch for Cisco SRE

The access switch is the appropriate location to physically connect Cisco SRE modules at single-tier remote sites. Regardless of the switch type—single switch, switch stack, or modular—this type of connection must use a Layer 2 access interface.

This guide assumes that the LAN switch has already been configured. Only the procedures required to complete the connection of the switch to the Cisco WAVE appliances are included. For details on how to configure switches, see [Campus Wired LAN Technology Design Guide](#).



**Step 1:** Connect the Cisco WAVE appliance's external Ethernet port to an Ethernet port on the remote site's access switch, and then return the switchport configuration to the default.

```
default interface GigabitEthernet1/0/3
```

**Step 2:** Define the switchport in the remote-site access switch as an access port for the data VLAN, and then apply port-security and QoS configuration.

```
interface GigabitEthernet1/0/3
  description Link to WAVE
  switchport access vlan 64
  switchport host
  ip arp inspection trust
  logging event link-status
  macro apply EgressQoS
  no shutdown
```

## Procedure 2 Configure the Cisco SRE module

This guide assumes that the router has already been configured. Only the procedures required to support the integration of Cisco WAAS into the deployment are included. For details on how to configure the WAN router, see the [MPLS WAN Technology Design Guide](#) or [VPN WAN Technology Design Guide](#).

You can use a variety of Cisco WAVE appliances or Cisco SRE form-factors for the remote-site Cisco WAAS equipment in this design, depending on the performance requirements.

You can insert the Cisco SRE modules directly into a corresponding module slot in the remote-site router and configure them somewhat differently from the appliances. If you are using an appliance, you can follow the Configuring the Cisco WAVE Appliance process with remote-site addressing parameters.

Although the remote-site router can potentially communicate directly with the Cisco SRE module by using the router backplane, this design uses the external interfaces on the modules, which allows for a consistent design implementation regardless of the chosen Cisco WAVE device. You must enable the service module (SM) interface and assign an arbitrary (locally significant only) IP address in order for the SM interface to be accessed through a console session from the host router.

You must connect the external interface to the data network on the access or distribution switch for this configuration to work properly.

If AAA is enabled on the router, configuring an exemption on the router is required. If you do not configure an exemption, you will be prompted for both a router login and a Cisco WAAS login, which can be confusing. Disabling the initial router authentication requires that you create an AAA method, which you then apply to the specific line configuration on the router associated with the Cisco SRE module.

**Step 1:** On the host router, configure console access and Cisco SRE module IP addresses. This permits console access to the SRE modules.

```
interface SM1/0
  ip address 192.0.2.2 255.255.255.252
  service-module external ip address 10.5.52.8 255.255.255.0
  service-module ip default-gateway 10.5.52.1
  no shutdown
```



## Tech Tip

The IP address assigned 192.0.2.2 to SM/0 is arbitrary in this design and only locally significant to the host router.

Next, if AAA has been enabled on the router, you will configure an AAA exemption for Cisco SRE devices.

If you are not using AAA services, skip to Step 6.

**Step 2:** If you are using AAA services, create the AAA login method.

```
aaa authentication login MODULE none
```

**Step 3:** Determine which line number is assigned to Cisco SRE module. The example output below shows line 67.

```
RS203-2921-1# show run | begin line con 0  
line con 0  
  logging synchronous  
line aux 0  
line 67  
  no activation-character  
  no exec  
  transport preferred none  
  transport input all  
  transport output pad telnet rlogin lapb-ta mop udptn v120 ssh  
  stopbits 1  
  flowcontrol software  
line vty 0 4  
  transport preferred none  
  transport input ssh
```

**Step 4:** Restrict access to the Cisco SRE console by creating an access list. The access-list number is arbitrary, but the IP address must match the address assigned to the SM interface in Step 1.

```
access-list 67 permit 192.0.2.2
```

**Step 5:** Assign the method to the appropriate line.

```
line 67  
  login authentication MODULE  
  access-class 67 in  
  transport output none
```

**Step 6:** Connect to the Cisco WAVE console by using a session from the host router.

After the IP address is assigned, and the interface is enabled, it is possible to open a session on the Cisco WAVE appliance and run the setup script. For all WAVE devices, the factory default username is admin, and the factory default password is default.

If you are using secure user authentication on the router and have not created an AAA exemption, you must first authenticate with a valid router login credential before logging into the Cisco WAVE console session.

```
RS203-2921-1# service-module sm 1/0 session
```

**Step 7:** Login to the Cisco WAVE console.

The factory default username is admin and the factory default password is default.

### Procedure 3 Configure the WAAS Node

**Step 1:** In the command line interface, enter **setup**. The initial setup utility starts.

```
Parameter                Default Value
Device Mode              Application Accelerator
1. Interception Method   WCCP
2. Time Zone             UTC 0 0
3. Management Interface  GigabitEthernet 1/0      (internal)
    Autosense            Disabled
    DHCP                 Disabled
ESC Quit ? Help _____ WAAS Default Configuration _____
Press 'y' to select above defaults, 'n' to configure all, <1-3> to change specific
default [y]: n
```

**Step 2:** Configure the interception method.

```
1. WCCP
2. AppNav Controller
3. Other
Select Interception Method [1]: 1
```

**Step 3:** Configure the time zone.

```
Enter Time Zone <Time Zone Hours (-23 to 23) Minutes (0-59)> [UTC 0 0]: PST8PDT -8
0
```

**Step 4:** Configure the management interface, IP address, and default gateway.

This design uses the external interface as the management interface.

```
No.      Interface Name      IP Address      Network Mask
1. GigabitEthernet 1/0      unassigned      unassigned (internal)
2. GigabitEthernet 2/0      dhcp            (external)
Select Management Interface [1]: 2
Enable Autosense for Management Interface? (y/n) [y]: y
Enable DHCP for Management Interface? (y/n) [y]: n
```



## Tech Tip

If you receive the following warning, you may disregard it because the IP address configuration was provided previously.

```
*** You have chosen to disable DHCP! Any network
configuration learnt from DHCP server will be unlearnt!
SETUP will indicate failure as the management interface
cannot be brought up - Please make sure WAVE Management
Interface IP address and Default Gateway are configured
from the Router; Press ENTER to continue:
```

### Step 5: Configure the Cisco WAAS Central Manager address.

```
Enter Central Manager IP Address (WARNING: An invalid entry will cause SETUP to
take a long time when applying WAAS configuration) [None]: 10.4.48.100
```

### Step 6: Configure DNS, host, and NTP settings.

```
Enter Domain Name Server IP Address [Not configured]: 10.4.48.10
Enter Domain Name(s) (Not configured): cisco.local
Enter Host Name (None): RS203-WAVE-SRE-1
Enter NTP Server IP Address [None]: 10.4.48.17
```

### Step 7: Configure the WCCP router list.

```
Enter WCCP Router (max 4) IP Address list (ip1 ip2 ...) []: 10.255.251.203
10.255.253.203
```

### Step 8: Select the appropriate license.

The product supports the following licenses:

1. Transport
2. Enterprise
3. Enterprise & Video

```
Enter the license(s) you purchased [2]: 2
```

### Step 9: Verify the configuration settings.

Parameter	Configured Value
1. Interception Method	WCCP
2. Time Zone	PST8PDT -8 0
3. Management Interface	GigabitEthernet 2/0 (external)
4. Autosense	Enabled
5. DHCP	Disabled
IP Address	10.5.52.8
IP Network Mask	255.255.255.0
IP Default Gateway	10.5.52.1
6. CM IP Address	10.4.48.100
7. DNS IP Address	10.4.48.10
8. Domain Name(s)	cisco.local

```

 9. Host Name                RS203-WAVE-SRE-1
10. NTP Server Address       10.4.48.17
11. WCCP Router List        10.255.251.203 10.255.253.203
12. License                  Enterprise
ESC Quit ? Help ! CLI _____ WAAS Final Configuration _____
Press 'y' to select configuration, <F2> to see all configuration, 'd' to toggle
defaults display, <1-12> to change specific parameter [y]: y
      Router WCCP configuration
First WCCP router IP in the WCCP router list seems to be an external address;
WCCP configuration on external routers is not allowed through SETUP. Please press
ENTER to apply WAAS configuration on WAVE ...
Applying WAAS configuration on WAE ...
May take a few seconds to complete ...
WAAS configuration applied successfully!!
Saved configuration to memory.
Press ENTER to continue ...

```

When you are prompted with a recommended router WCCP configuration template, you don't have to retain the information. This router configuration is covered in depth in a following procedure.

**Step 10:** In the EXEC mode, enable the propagation of local configuration changes to the Cisco WAAS Central Manager.

```
cms lcm enable
```

**Step 11:** Configure the GRE-negotiated return. All Cisco WAVE devices use GRE-negotiated return with their respective WCCP routers.

```
wccp tcp-promiscuous service-pair 61 62 redirect-method gre
wccp tcp-promiscuous service-pair 61 62 egress-method wccp-gre
```

**Step 12:** Configure the WCCP router list. This design uses authentication between the routers and Cisco WAVE appliances.

If any of the WCCP routers are Cisco ASR1000 Series routers, then change the default setting of **hash-source-ip** to **mask-assign**. This change must be made for WCCP to operate properly and is made on the Cisco WAVE appliances, not on the routers.

```
wccp tcp-promiscuous service-pair 61 62 router-list-num 7
wccp tcp-promiscuous service-pair 61 62 assignment-method mask
wccp tcp-promiscuous service-pair 61 62 password c1sco123
wccp tcp-promiscuous service-pair 61 62 enable
```

All other router platforms can use the default setting:

```
wccp tcp-promiscuous service-pair 61 62 router-list-num 7
wccp tcp-promiscuous service-pair 61 62 password c1sco123
wccp tcp-promiscuous service-pair 61 62 enable
```

Next, you will configure device management protocols.

**Step 13:** Log in to the Cisco WAVE appliance.

**Step 14:** Generate the RSA key and enable the sshd service. This enables SSH.

```
ssh-key-generate key-length 2048
sshd enable
no telnet enable
```

**Step 15:** Enable Simple Network Management Protocol (SNMP) in order to allow the network infrastructure devices to be managed by a Network Management System (NMS), and then configure SNMPv2c both for a read-only and a read-write community string.

```
snmp-server community cisco
snmp-server community cisco123 RW
```

**Step 16:** If you want to limit access to the appliance, configure management ACLs.

In networks where network operational support is centralized, you can increase network security by using an access list to limit the networks that can access your device. In this example, only devices on the 10.4.48.0/24 network are able to access the device via SSH or SNMP.

```
ip access-list extended 155
 permit tcp 10.4.48.0 0.0.0.255 any eq ssh
 deny tcp any any eq ssh
 permit ip any any
 exit
interface GigabitEthernet 1/0
 ip access-group 155 in
 exit
!
ip access-list standard 55
 permit 10.4.48.0 0.0.0.255
 exit
snmp-server access-list 55
```

**Step 17:** If you have a centralized TACACS+ server, enable AAA authentication for access control. This configures secure user authentication as the primary method for user authentication (login) and user authorization (configuration). AAA controls all management access to the Cisco WAAS and Cisco WAVE devices (SSH and HTTPS).

#### Tech Tip

A factory default local admin user was created on the Cisco WAAS and Cisco WAVE appliances during setup. This user account provides the ability to manage the device in case the centralized TACACS+ server is unavailable or if you do not have a TACACS+ server in your organization.

```
tacacs key SecretKey
tacacs password ascii
tacacs host 10.4.48.15 primary
!
authentication login local enable secondary
authentication login tacacs enable primary
authentication configuration local enable secondary
authentication configuration tacacs enable primary
authentication fail-over server-unreachable
```

**Step 18:** After you make configuration changes, in the EXEC mode, save the configuration.

```
copy running-config startup-config
```

Each Cisco WAVE appliance registers with the Cisco WAAS Central Manager as it becomes active on the network.

**Step 19:** If you want to verify the Cisco WAVE registration, on the respective WAVE appliance or via the web interface to the Cisco WAAS Central Manager, enter **show cms info**.

**Step 20:** When this configuration is complete, press the *escape sequence* **Ctrl+Shift+6** and then enter **x**. The command line of the host router returns.



#### Tech Tip

If you are using a terminal server the escape sequence is slightly different. Press and hold the escape sequence **Ctrl+Shift**, enter **6**, enter **6** again, release the key combination, and then enter **x**. Entering **6** once returns you to the terminal server; entering **6** twice returns you to the host router.

**Step 21:** If you are deploying a cluster of Cisco WAAS nodes, repeat Procedure 1 through Procedure 3 for the remaining nodes.

## Procedure 4

### Configure WCCPv2 on routers

In this design, WCCP diverts network traffic destined for the WAN to the Cisco WAAS system for optimization. This method provides for a clean deployment with minimal additional cabling, and it requires both the WAN-aggregation and remote-site routers to be configured for WCCP.

This guide assumes that the router has already been configured. Only the procedures required to support the integration of Cisco WAAS into the deployment are included. Full details on WAN router configuration are included in the [MPLS WAN Technology Design Guide](#) or [VPN WAN Technology Design Guide](#).

**Step 1:** Configure global WCCP parameters, enable services 61 and 62, and then configure a group list and password. Permit only the on-site Cisco WAVE appliances in the group list in order to prevent unauthorized Cisco WAVE devices from joining the WAAS cluster.

You must enable services 61 and 62 for WCCP redirect for Cisco WAAS. These services should be using WCCP Version 2. As a best practice, exempt certain critical traffic types and other protocols which can not be optimized from WCCP redirect by using a redirect list. A detailed listing is included in Table 11 and Table 12.

```

ip wccp source-interface Loopback0
ip wccp 61 redirect-list WAAS-REDIRECT-LIST group-list WAVE password cisco123
ip wccp 62 redirect-list WAAS-REDIRECT-LIST group-list WAVE password cisco123
!
ip access-list standard WAVE
  permit 10.5.52.8
  permit 10.5.52.9
ip access-list extended WAAS-REDIRECT-LIST
  remark WAAS WCCP Redirect List
  deny tcp any any eq 22
  deny tcp any eq 22 any
  deny tcp any eq telnet any
  deny tcp any any eq telnet
  deny tcp any eq tacacs any
  deny tcp any any eq tacacs
  deny tcp any eq bgp any
  deny tcp any any eq bgp
  deny tcp any any eq 123
  deny tcp any eq 123 any
  deny tcp any any eq 161
  deny tcp any eq 161 any
  deny tcp any any eq 162
  deny tcp any eq 162 any
  deny tcp any any eq 2000
  deny tcp any eq 2000 any
  deny tcp any any eq 2443
  deny tcp any eq 2443 any
  deny tcp any any eq 5060
  deny tcp any eq 5060 any
  deny tcp any any eq 5061
  deny tcp any eq 5061 any
  deny tcp any any eq 1718
  deny tcp any eq 1718 any
  deny tcp any any eq 1720
  deny tcp any eq 1720 any
  deny tcp any any eq 2428
  deny tcp any eq 2428 any
  deny tcp any any eq 443
  deny tcp any eq 443 any
  deny tcp any any eq 8443
  deny tcp any eq 8443 any
  deny tcp any any eq 6970
  deny tcp any eq 6970 any
  deny tcp any any eq 689
  deny tcp any eq 689 any
  permit tcp any any

```



**Step 2:** Configure WCCP redirection for traffic from the LAN.

Specific interfaces must be identified where traffic to and from the WAN are intercepted.

Traffic from the LAN is intercepted with service 61 inbound on all LAN interfaces. It is not necessary to configure WCCP interception on voice interfaces and voice VLANs.

If the LAN interface is a Layer 3 interface, define WCCP redirection on the interface directly.

```
interface Port-Channel 1
  ip wccp 61 redirect in
```

If the LAN interface is a VLAN trunk, define WCCP redirection on the data VLAN subinterface.

```
interface GigabitEthernet0/2.64
  ip wccp 61 redirect in
```

**Step 3:** Configure WCCP redirection for traffic from the WAN.

Traffic from the WAN is intercepted with service 62 inbound on all WAN interfaces, including DMVPN tunnel interfaces (but not their underlying physical interfaces).

**Example: MPLS WAN Interface**

```
interface GigabitEthernet 0/3
  ip wccp 62 redirect in
```

**Example: DMVPN WAN Interface**

```
interface Tunnel 10
  ip wccp 62 redirect in
```

**Step 4:** After you make configuration changes, save the configuration.

```
copy running-config startup-config
```

**Step 5:** If you have multiple WAN routers at the site, repeat Step 1 through Step 4 for each WAN router.

## Configuring Cisco WAAS Express

1. Configure the Central Manager for WAASx
2. Create WAAS Central Manager user
3. Enable WAAS Express on the remote-site router
4. Register the router to the WAAS Central Manager

The following table specifies the parameters and data, in addition to the universal design parameters, that you need in order to set up and configure Cisco WAAS Express. For your convenience, you can enter your values in the table and refer to it when configuring the router. The values you enter will differ from those in this example, which are provided for demonstration purposes only.

Table 20 - Cisco WAAS Express network system parameters checklist

Parameter	CVD values primary WAVE	Site-specific values
WAAS Central Manager	10.4.48.100	
WAASx username	waascm	
WAASx password	c1sco123	

### Procedure 1 Configure the Central Manager for WAASx

You can use the Cisco WAAS Central Manager to centrally manage WAASx routers, similar to a Cisco WAVE appliance. You must define a user name and password for the WAAS Central Manager to use to access the WAASx routers for monitoring and management. You secure these communications by using HTTPS, which requires the use of digital certificates.

To enable secure communications between the Cisco WAAS Central Manager and the router requires that you install the digital certificate from the WAAS Central Manager on each of the WAASx routers. The certificate can be exported in privacy enhanced mail (PEM) base64 format. This command is available through the device command line interface.

In this procedure, you will configure login and password credentials for the Cisco WAASx router by using the Cisco WAAS Central Manager web interface (<https://waas-wcm-1.cisco.local:8443>) and you will export the Cisco WAAS Central Manager certificate necessary to ensure secure communication between the Cisco WAAS Central Manager and the WAASx routers in your deployment.

In Cisco WAAS Central Manager, navigate to **Admin > Security > Cisco IOS Router Global Credentials**. Enter the appropriate user name and password that you also plan to configure on the Cisco WAASx router or on the central AAA server. (Example: user name waascm and password c1sco123)

The screenshot shows the Cisco Wide Area Application Services (WAAS) Central Manager interface. The page title is "Cisco IOS Router Global Credentials". The breadcrumb navigation is "Home > Admin > Security > Cisco IOS Router Global Credentials". The page contains a form with two input fields: "User Name" (containing "waascm") and "Password" (containing masked characters). A tooltip for the User Name field states: "User Name is required if 'ip http authentication local/aaa' is configured on Cisco IOS router(s)". Below the form, a warning message reads: "Configuring global credentials will not be applied on the Cisco IOS router(s). Performing changes to credentials may impact communication between Central Manager and Cisco IOS router." There are "Submit" and "Reset" buttons at the bottom of the form.

## Procedure 2 Create WAAS Central Manager user

There are two options when you are creating the Cisco WAAS Central Manager account. If you want to create the account locally on each WAAS Express router, complete Option 1. If you want to create it once on the central AAA server, complete Option 2.

As networks scale in the number of devices to maintain, there is an operational burden to maintain local user accounts on every device. A centralized authentication, authorization and accounting (AAA) service reduces operational tasks per device and provides an audit log of user access for security compliance and root cause analysis.

Be aware that if AAA is used for router administration, centralized AAA must also be used for the WAAS Central Manager user.

### Option 1: Create a local user account

**Step 1:** Create a local user on the remote-site router.

```
username waascm privilege 15 password c1sco123
```

### Option 2: Create a centralized AAA account

The Cisco Secure ACS internal identity store can contain all the network administrator accounts or just accounts that require a policy exception if an external identity store (such as Microsoft Active Directory) is available. A common example of an account that would require an exception is one associated with a network management system that allows the account to perform automated configuration and monitoring.

**Step 1:** Navigate and log in to the Cisco Secure ACS Administration page. (Example: <https://acs.cisco.local>)

**Step 2:** Navigate to **Users and Identity Stores > Internal Identity Stores > Users**.

**Step 3:** Click **Create**.

**Step 4:** Enter a name, description, and password for the user account. (Example: user name waascm and password c1sco123)

The screenshot shows the 'Create' user form in the 'Users and Identity Stores' interface. The form is divided into several sections:

- General:** Name: waascm, Status: Enabled (with a green checkmark), Description: WAAS Central Manager user, Identity Group: All Groups (with a 'Select' button).
- Password Information:** Password must: Contain 4 - 32 characters. Password Type: Internal Users (with a 'Select' button). Password: [masked], Confirm Password: [masked]. There is a checkbox for 'Change password on next login' which is unchecked.
- Enable Password Information:** Password must: Contain 4 - 32 characters. Enable Password: [input field], Confirm Password: [input field].
- User Information:** There are no additional identity attributes defined for user records.

At the bottom of the form, there are 'Submit' and 'Cancel' buttons.

**Step 5:** To the right of Identity Group, click **Select**.

**Step 6:** Select **Network Admins**, and then click **OK**.

The screenshot shows the 'Identity Groups' selection dialog. It features a search bar with 'Filter:' and 'Match if:' dropdowns, and a 'Go' button. Below the search bar is a table with the following data:

Name	Description
All Groups	Identity Group Root
Helpdesk	Users who are allowed to login to a device but not make changes
Network Admins	Users who are allowed to login to a device and make changes

The 'Network Admins' row is highlighted in green. At the bottom of the dialog, there are buttons for 'Create', 'Duplicate', 'File Operations', 'Export', 'OK', 'Cancel', and 'Help'.

**Step 7:** Click **Submit**.

### Procedure 3 Enable WAAS Express on the remote-site router

This guide assumes that the router has already been configured. Only the procedures required to support the integration of Cisco WAAS into the deployment are included. Full details on WAN router configuration are included in the [MPLS WAN Technology Design Guide](#) or [VPN WAN Technology Design Guide](#).

If you want to turn on the embedded WAN optimization, you must enable Cisco WAAS optimization on the router's WAN interface. The same Cisco WAAS Central Manager used with Cisco WAVE devices can also centrally manage WAASx. The router must also be properly configured to communicate securely with the WAAS Central Manager.

Note the following:

- Cisco WAASx is a specially licensed feature. This license must be installed on a router with sufficient DRAM to support the WAASx functionality.
- Cisco WAASx routers must be configured with maximum DRAM.
- WCCP redirection is not used for a Cisco WAASx implementation. There is no need to redirect traffic to an external device, because all traffic optimization is performed on the router.

**Step 1:** On a remote-site router, enable Cisco WAAS with WAN interface GigabitEthernet0/0.

```
interface GigabitEthernet0/0
  waas enable
```

### Procedure 4 Register the router to the WAAS Central Manager

**Step 1:** Verify SSH and HTTPS servers are enabled on the router. If not already configured, configure these services now.

#### Tech Tip

Secure HTTP (HTTPS) and Secure Shell (SSH) are secure replacements for the HTTP and Telnet protocols. They use Secure Sockets Layer (SSL) and Transport Layer Security (TLS) to provide device authentication and data encryption.

Secure management of the network device is enabled through the use of the SSH and HTTPS protocols. Both protocols are encrypted for privacy and the nonsecure protocols, Telnet and HTTP, are turned off.

Specify the transport preferred none on vty lines to prevent errant connection attempts from the CLI prompt. Without this command, if the ip name-server is unreachable, long timeout delays may occur for mistyped commands.

```
ip domain-name cisco.local
no ip http server
ip http secure-server
ip scp server enable
line vty 0 15
  transport input ssh
  transport preferred none
```

**Step 2:** If you are using AAA authentication, configure the HTTP server to use AAA.

```
ip http authentication aaa
```

**Step 3:** Log in to the Cisco WAAS Central Manager through the web interface (for example, <https://waas-wcm-1.cisco.local:8443>).

**Step 4:** Navigate to **Admin>Registration>Cisco IOS Routers**.

The screenshot displays the Cisco Wide Area Application Services (WAAS) Central Manager web interface. The page title is "Cisco IOS Router Registration". The navigation menu includes "Home", "Device Groups", "Devices", "AppNav Clusters", and "Locations". The user is logged in as "admin". The page contains the following configuration fields:

- Router IP address entry method:  Manual  Import CSV file
- IP Address(es):  (with a tooltip: "Comma separated list up to 50 entries")
- Username:
- Password:
- Enable Password:
- HTTP Authentication Type:
- Central Manager IP Address:  (with a tooltip: "Update the Central Manager IP Address if NATed environment is used.")

Below the form, there are three buttons: "Register", "Retry", and "Reset". A "Registration Status" table is shown at the bottom, with columns for "IP Address", "Hostname", "Router type", "Status", and "Total 0". The table currently displays "No data available".

**Step 5:** Enter the management information of the Cisco WAAS Express remote-site routers, then click **Register**. You may enter the IP addresses of multiple routers (separated by a comma) if they share the same authentication credentials.

- Router IP address entry method—**Manual**
- IP Address(es)—**10.255.251.204**
- Username—**waascm**
- Password—**c1sco123**
- Enable Password—**c1sco123**
- HTTP Authentication Type—**AAA**
- Central Manager IP Address—**10.4.48.100**

 Cisco Wide Area Application Services
 
[Home](#) | [Device Groups](#) | [Devices](#) | [AppNav](#) | [Clusters](#) | [Locations](#)  
[Dashboard](#) | [Configure](#) | [Monitor](#) | [Admin](#)

Home > Admin > Registration > Cisco IOS Routers

Cisco IOS Router Registration

Router IP address entry method:  Manual  Import CSV file

IP Address(es):  ⓘ Comma separated list up to 50 entries

Username:

Password:

Enable Password:

HTTP Authentication Type:

Central Manager IP Address: \*  ⓘ Update the Central Manager IP Address if NATed environment is used.

ⓘ SSH v1 or SSH v2 must be enabled on routers.  
 ⓘ These credentials are used once to register all the listed routers, which should have the same credentials.  
 ⓘ These credentials are not used for communication between the Central Manager and the routers after registration finishes.

Registration Status				Total 0
IP Address	Hostname	Router type	Status	
No data available				

**Step 6:** Verify successful registration.

Registration Status				Total 1
IP Address	Hostname	Router type	Status	
10.255.251.204	RS204-1941	WAAS Express	✔ Successfully processed the registration request	

# Appendix A: Product List

## WAAS Central Manager

Functional Area	Product Description	Part Numbers	Software
Central Manager Appliance	Cisco Wide Area Virtualization Engine 694	WAVE-694-K9	5.3.5a
	Cisco Wide Area Virtualization Engine 594	WAVE-594-K9	
	Cisco Wide Area Virtualization Engine 294	WAVE-294-K9	
Central Manager Virtual Appliance	Virtual WAAS Central Manager	WAAS-CM-VIRT-K9	5.3.5a
	License to manage up to 2000 WAAS Nodes	LIC-VCM-2000N	
	License to manage up to 100 WAAS Nodes	LIC-VCM-100N	

## Access Control

Functional Area	Product Description	Part Numbers	Software
Authentication Services	ACS 5.5 VMware Software And Base License	CSACS-5.5-VM-K9	5.5 with Cumulative Patch 5.5.0.46.2



# WAAS Aggregation

Functional Area	Product Description	Part Numbers	Software
AppNav Controller Appliance	WAVE-594 bundled with 4port 10 GigE AppNav IOM	WAVE-APNV-10GE	5.3.5a
	Cisco Wide Area Virtualization Engine 8541	WAVE-8541-K9	
	Cisco Wide Area Virtualization Engine 7571	WAVE-7571-K9	
	Cisco Wide Area Virtualization Engine 7541	WAVE-7541-K9	
	Cisco Wide Area Virtualization Engine 694	WAVE-694-K9	
	AppNav IOM for WAVE - 12 port GigE copper	WAVE-APNV-GE-12T	
	AppNav IOM for WAVE - 12 port GigE SFP	WAVE-APNV-GE12SFP	
AppNav-XE Controller	Aggregation Services 1002X Router	ASR1002X-5G-VPNK9	IOS-XE 15.4(2)S Advanced Enterprise feature set
	Aggregation Services 1002 Router	ASR1002-5G-VPN/K9	
	Aggregation Services 1001 Router	ASR1001-2.5G-VPNK9	
	Cisco ISR 4451-X Security Bundle w/SEC license PAK	ISR4451-X-SEC/K9	IOS-XE 15.4(2)S securityk9 feature set
Application Accelerator Appliance	Cisco Wide Area Virtualization Engine 8541	WAVE-8541-K9	5.3.5a
	Cisco Wide Area Virtualization Engine 7571	WAVE-7571-K9	
	Cisco Wide Area Virtualization Engine 7541	WAVE-7541-K9	
	Cisco Wide Area Virtualization Engine 694	WAVE-694-K9	
	Cisco Wide Area Virtualization Engine 594	WAVE-594-K9	
Application Accelerator Virtual Appliance	Virtual WAAS	WAAS-ENT-VIRT-K9	5.3.5a
	License for 50000 optimized connections	LIC-50K-VWAAS	
	License for 12000 optimized connections	LIC-12K-VWAAS	
	License for 6000 optimized connections	LIC-6K-VWAAS	
	License for 2500 optimized connections	LIC-2500-VWAAS	
	License for 1300 optimized connections	LIC-1300-VWAAS	
	License for 750 optimized connections	LIC-750-VWAAS	

## WAAS Remote Site

Functional Area	Product Description	Part Numbers	Software
Application Accelerator Appliance	Cisco Wide Area Virtualization Engine 694	WAVE-694-K9	5.3.5a
	Cisco Wide Area Virtualization Engine 594	WAVE-594-K9	
	Cisco Wide Area Virtualization Engine 294	WAVE-294-K9	
Application Accelerator Virtual Appliance	Virtual WAAS 5.3 SW image. (C2911-AX/K9, C2921-AX/K9 and C2951-AX/K9 include 1300 connection RTU license for vWAAS. C3925-AX/K9 and C3945-AX/K9 include 2500 connection RTU license for vWAAS.)	SF-VWAAS-5.3-K9	5.3.5a
	Cisco UCS E-Series Double-Wide Server Blades, Intel Xeon E5-2400 Six Core processor, 8GB RAM, 2 SD cards, PCIe card	UCS-E160DP-M1/K9	
	Cisco UCS E-Series Double-Wide Server Blades, Intel Xeon E5-2400 Six Core processor, 8GB RAM, 2 SD cards	UCS-E160D-M1/K9	
	Cisco UCS E-Series Double-Wide Server Blades, Intel Xeon E5-2400 Quad Core processor, 8GB RAM, 2 SD cards, PCIe card	UCS-E140DP-M1/K9	
	Cisco UCS E-Series Double-Wide Server Blades, Intel Xeon E5-2400 Quad Core processor, 8GB RAM, 2 SD cards	UCS-E140D-M1/K9	
	Cisco UCS E-Series Single-Wide Server Blades, Intel Xeon E3 Quad Core processor, 8GB RAM, 2 SD cards	UCS-E140S-M1/K9	
Remote-Site WAVE SRE	Cisco WAAS 5.3 SRE SW image. (C2911-AX/K9, C2921-AX/K9 and C2951-AX/K9 include 1300 connection RTU license for WAAS. C3925-AX/K9 and C3945-AX/K9 include 2500 connection RTU license for WAAS.)	SF-WAAS-5.3-SM-K9	5.3.5a
	Cisco SRE 910 with 4-8 GB RAM, 2x 500 GB 7,200 rpm HDD, RAID 0/1, dual-core CPU configured with ISR G2	SM-SRE-910-K9	
	Cisco SRE 710 with 4 GB RAM, 500 GB 7,200 rpm HDD, single-core CPU configured with Cisco ISR G2	SM-SRE-710-K9	
Remote-Site WAAS Express	Cisco ISR 1941 Router w/ 2 GE, 2 EHWIC slots, 256MB CF, 2.5GB DRAM, IP Base, DATA, SEC, AX license with; AVC and WAAS-Express	C1941-AX/K9	15.3(3)M3 securityk9 feature set datak9 feature set

## WAN Aggregation

Functional Area	Product Description	Part Numbers	Software
WAN-aggregation Router	Aggregation Services 1002X Router	ASR1002X-5G-VPNK9	IOS-XE 15.4(2)S Advanced Enterprise feature set
	Aggregation Services 1002 Router	ASR1002-5G-VPN/K9	
	Aggregation Services 1001 Router	ASR1001-2.5G-VPNK9	
WAN-aggregation Router	Cisco ISR 4451-X Security Bundle w/SEC license PAK	ISR4451-X-SEC/K9	IOS-XE 15.4(2)S securityk9 feature set

## WAN Remote Site

Functional Area	Product Description	Part Numbers	Software
Modular WAN Remote-site Router	Cisco ISR 3945 w/ SPE150, 3GE, 4EHWIC, 4DSP, 4SM, 256MBCF, 1GBDRAM, IP Base, SEC, AX licenses with; DATA, AVC, and WAAS/vWAAS with 2500 connection RTU	C3945-AX/K9	15.3(3)M3 securityk9 feature set datak9 feature set
	Cisco ISR 3925 w/ SPE100 (3GE, 4EHWIC, 4DSP, 2SM, 256MBCF, 1GBDRAM, IP Base, SEC, AXlicenses with; DATA, AVC, WAAS/ vWAAS with 2500 connection RTU	C3925-AX/K9	
	Cisco ISR 2951 w/ 3 GE, 4 EHWIC, 3 DSP, 2 SM, 256MB CF, 1GB DRAM, IP Base, SEC, AX license with; DATA, AVC, and WAAS/ vWAAS with 1300 connection RTU	C2951-AX/K9	
	Cisco ISR 2921 w/ 3 GE, 4 EHWIC, 3 DSP, 1 SM, 256MB CF, 1GB DRAM, IP Base, SEC, AX license with; DATA, AVC, and WAAS/ vWAAS with 1300 connection RTU	C2921-AX/K9	
	Cisco ISR 2911 w/ 3 GE,4 EHWIC, 2 DSP, 1 SM, 256MB CF, 1GB DRAM, IP Base, SEC, AX license with; DATA, AVC and WAAS/ vWAAS with 1300 connection RTU	C2911-AX/K9	
	Cisco ISR 1941 Router w/ 2 GE, 2 EHWIC slots, 256MB CF, 2.5GB DRAM, IP Base, DATA, SEC, AX license with; AVC and WAAS-Express	C1941-AX/K9	

# LAN Access Layer

Functional Area	Product Description	Part Numbers	Software
Modular Access Layer Switch	Cisco Catalyst 4500E Series 4507R+E 7-slot Chassis with 48Gbps per slot	WS-C4507R+E	3.3.1XO(15.1.1XO1) IP Base feature set
	Cisco Catalyst 4500E Supervisor Engine 8-E, Unified Access, 928Gbps	WS-X45-SUP8-E	
	Cisco Catalyst 4500E 12-port 10GbE SFP+ Fiber Module	WS-X4712-SFP+E	
	Cisco Catalyst 4500E 48-Port 802.3at PoE+ 10/100/1000 (RJ-45)	WS-X4748-RJ45V+E	
	Cisco Catalyst 4500E Series 4507R+E 7-slot Chassis with 48Gbps per slot	WS-C4507R+E	3.5.3E(15.2.1E3) IP Base feature set
	Cisco Catalyst 4500E Supervisor Engine 7L-E, 520Gbps	WS-X45-SUP7L-E	
	Cisco Catalyst 4500E 48 Ethernet 10/100/1000 (RJ45) PoE+,UPoE ports	WS-X4748-UPOE+E	
	Cisco Catalyst 4500E 48 Ethernet 10/100/1000 (RJ45) PoE+ ports	WS-X4648-RJ45V+E	
Stackable Access Layer Switch	Cisco Catalyst 3850 Series Stackable 48 Ethernet 10/100/1000 PoE+ ports	WS-C3850-48F	3.3.3SE(15.0.1EZ3) IP Base feature set
	Cisco Catalyst 3850 Series Stackable 24 Ethernet 10/100/1000 PoE+ Ports	WS-C3850-24P	
	Cisco Catalyst 3850 Series 2 x 10GE Network Module	C3850-NM-2-10G	
	Cisco Catalyst 3850 Series 4 x 1GE Network Module	C3850-NM-4-1G	
	Cisco Catalyst 3650 Series 24 Ethernet 10/100/1000 PoE+ and 2x10GE or 4x1GE Uplink	WS-C3650-24PD	3.3.3SE(15.0.1EZ3) IP Base feature set
	Cisco Catalyst 3650 Series 24 Ethernet 10/100/1000 PoE+ and 4x1GE Uplink	WS-C3650-24PS	
	Cisco Catalyst 3650 Series Stack Module	C3650-STACK	
	Cisco Catalyst 3750-X Series Stackable 48 Ethernet 10/100/1000 PoE+ ports	WS-C3750X-48PF-S	15.2(1)E3 IP Base feature set
	Cisco Catalyst 3750-X Series Stackable 24 Ethernet 10/100/1000 PoE+ ports	WS-C3750X-24P-S	
	Cisco Catalyst 3750-X Series Two 10GbE SFP+ and Two GbE SFP ports network module	C3KX-NM-10G	
	Cisco Catalyst 3750-X Series Four GbE SFP ports network module	C3KX-NM-1G	
	Cisco Catalyst 2960-X Series 24 10/100/1000 Ethernet and 2 SFP+ Uplink	WS-C2960X-24PD	15.0(2)EX5 LAN Base feature set
	Cisco Catalyst 2960-X FlexStack-Plus Hot-Swappable Stacking Module	C2960X-STACK	
Standalone Access Layer Switch	Cisco Catalyst 3650 Series 24 Ethernet 10/100/1000 PoE+ and 4x1GE Uplink	WS-C3650-24PS	3.3.3SE(15.01EZ3) IP Base feature set

# LAN Distribution Layer

Functional Area	Product Description	Part Numbers	Software
Modular Distribution Layer Virtual Switch Pair	Cisco Catalyst 6800 Series 6807-XL 7-Slot Modular Chassis	C6807-XL	15.1(2)SY3 IP Services feature set
	Cisco Catalyst 6500 VSS Supervisor 2T with 2 ports 10GbE and PFC4	VS-S2T-10G	
	Cisco Catalyst 6500 4-port 40GbE/16-port 10GbE Fiber Module w/DFC4	WS-X6904-40G-2T	
	Cisco Catalyst 6500 4-port 10GbE SFP+ adapter for WX-X6904-40G module	CVR-CFP-4SFP10G	
	Cisco Catalyst 6500 CEF720 48 port 10/100/1000mb Ethernet	WS-X6748-GE-TX	
	Cisco Catalyst 6500 Distributed Forwarding Card 4	WS-F6K-DFC4-A	
	Cisco Catalyst 6500 Series 6506-E 6-Slot Chassis	WS-C6506-E	
	Cisco Catalyst 6500 VSS Supervisor 2T with 2 ports 10GbE and PFC4	VS-S2T-10G	
	Cisco Catalyst 6500 4-port 40GbE/16-port 10GbE Fiber Module w/DFC4	WS-X6904-40G-2T	
	Cisco Catalyst 6500 4-port 10GbE SFP+ adapter for WX-X6904-40G module	CVR-CFP-4SFP10G	
	Cisco Catalyst 6500 48-port GigE Mod (SFP)	WS-X6748-SFP	
	Cisco Catalyst 6500 Distributed Forwarding Card 4	WS-F6K-DFC4-A	
	Cisco Catalyst 6500 24-port GigE Mod (SFP)	WS-X6724-SFP	
	Cisco Catalyst 6500 Distributed Forwarding Card 4	WS-F6K-DFC4-A	
Extensible Fixed Distribution Layer Virtual Switch Pair	Cisco Catalyst 6800 Series 6880-X Extensible Fixed Aggregation Switch (Standard Tables)	C6880-X-LE	15.1(2)SY3 IP Services feature set
	Cisco Catalyst 6800 Series 6880-X Multi Rate Port Card (Standard Tables)	C6880-X-LE-16P10G	
Modular Distribution Layer Virtual Switch Pair	Cisco Catalyst 4500E Series 4507R+E 7-slot Chassis with 48Gbps per slot	WS-C4507R+E	3.5.3E(15.2.1E3) Enterprise Services feature set
	Cisco Catalyst 4500E Supervisor Engine 7-E, 848Gbps	WS-X45-SUP7-E	
	Cisco Catalyst 4500E 12-port 10GbE SFP+ Fiber Module	WS-X4712-SFP+E	
	Cisco Catalyst 4500E 48-Port 802.3at PoE+ 10/100/1000 (RJ-45)	WS-X4748-RJ45V+E	
Fixed Distribution Layer Virtual Switch Pair	Cisco Catalyst 4500-X Series 32 Port 10GbE IP Base Front-to-Back Cooling	WS-C4500X-32SFP+	3.5.3E(15.2.1E3) Enterprise Services feature set
Stackable Distribution Layer Switch	Cisco Catalyst 3850 Series Stackable Switch with 12 SFP Ethernet	WS-C3850-12S	3.3.3SE(15.0.1EZ3) IP Services feature set
	Cisco Catalyst 3850 Series 4 x 1GE Network Module	C3850-NM-4-1G	
	Cisco Catalyst 3850 Series 2 x 10GE Network Module	C3850-NM-2-10G	
	Cisco Catalyst 3750-X Series Stackable 12 GbE SFP ports	WS-C3750X-12S-E	15.2(1)E3 IP Services feature set
	Cisco Catalyst 3750-X Series Two 10GbE SFP+ and Two GbE SFP ports network module	C3KX-NM-10G	
	Cisco Catalyst 3750-X Series Four GbE SFP ports network module	C3KX-NM-1G	

# Appendix B: Configuration Examples

---

## Central Manager

### WAAS Central Manager (vWAAS)

```
! waas-universal-k9 version 5.3.5a (build b5 Apr 10 2014)
!
device mode central-manager
!
!
!
hostname WAAS-WCM-1
!
clock timezone PST8PDT -8 0
!
!
ip domain-name cisco.local
!
!
primary-interface Virtual 1/0
!
interface Virtual 1/0
 ip address 10.4.48.100 255.255.255.0
 ip access-group 155 in
 exit
interface Virtual 2/0
 shutdown
 exit
!
ip default-gateway 10.4.48.1
!
!
! ip path-mtu-discovery is disabled in WAAS by default
!
ip name-server 10.4.48.10
!
!
ip access-list standard 55
 permit 10.4.48.0 0.0.0.255
 exit
!
```

```
ip access-list extended 155
  permit tcp 10.4.48.0 0.0.0.255 any eq ssh
  deny tcp any any eq ssh
  permit ip any any
exit
!
!
ntp server 10.4.48.17
!
!
!
!
username admin password 1 ****
username admin privilege 15
!
snmp-server community cisco
snmp-server community cisco123 rw
snmp-server access-list 55
!
!
!
tacacs key ****
tacacs password ascii
tacacs host 10.4.48.15 primary
!
authentication login local enable secondary
authentication login tacacs enable primary
authentication configuration local enable secondary
authentication configuration tacacs enable primary
authentication fail-over server-unreachable
!
!
no telnet enable
!
sshd enable
!
!
cms enable
!
!
! End of WAAS configuration
```

# WCCP Design Model

## Primary Site WAAS Node

```
! waas-universal-k9 version 5.3.5a (build b5 Apr 10 2014)
!
device mode application-accelerator
!
interception-method wccp
!
!
hostname WAVE-7571-1
!
clock timezone PST8PDT -8 0
!
!
ip domain-name cisco.local
!
!
primary-interface PortChannel 1
!
interface PortChannel 1
 ip address 10.4.32.161 255.255.255.192
 ip access-group 155 in
 exit
!
interface GigabitEthernet 1/0
 channel-group 1
 exit
interface GigabitEthernet 2/0
 channel-group 1
 exit
!
ip default-gateway 10.4.32.129
!
!
no auto-register enable
!
! ip path-mtu-discovery is disabled in WAAS by default
!
ip name-server 10.4.48.10
!
!
ip access-list standard 55
 permit 10.4.48.0 0.0.0.255
 exit
!
```



```

ip access-list extended 155
  permit tcp 10.4.48.0 0.0.0.255 any eq ssh
  deny tcp any any eq ssh
  permit ip any any
  exit
!
!
ntp server 10.4.48.17
!
!
wccp router-list 7 10.4.32.241 10.4.32.242 10.4.32.243
wccp tcp-promiscuous service-pair 61 62
  router-list-num 7
  password ****
  redirect-method gre
  egress-method wccp-gre
  enable
  exit
!
!
!
!
username admin password 1 ****
username admin privilege 15
!
snmp-server community cisco
snmp-server community cisco123 rw
snmp-server access-list 55
!
!
!
tacacs key ****
tacacs password ascii
tacacs host 10.4.48.15 primary
!
authentication login local enable secondary
authentication login tacacs enable primary
authentication configuration local enable secondary
authentication configuration tacacs enable primary
authentication fail-over server-unreachable
!
!
no telnet enable
!
sshd enable
!
!

```

```

tfo tcp optimized-send-buffer 2048
tfo tcp optimized-receive-buffer 2048
!
!
accelerator mapi wansecure-mode auto
!
!
central-manager address 10.4.48.100
cms enable
!
!
stats-collector logging enable
stats-collector logging rate 30
!
!
! End of WAAS configuration

```

### Primary Site WAAS Node (vWAAS)

```

! waas-universal-k9 version 5.3.5a (build b5 Apr 10 2014)
!
device mode application-accelerator
!
interception-method wccp
!
!
hostname vWAAS-12k-1
!
clock timezone PST8PDT -8 0
!
!
ip domain-name cisco.local
!
!
primary-interface Virtual 1/0
!
interface Virtual 1/0
 ip address 10.4.32.162 255.255.255.192
 ip access-group 155 in
 exit
interface Virtual 2/0
 shutdown
 exit
!
ip default-gateway 10.4.32.129
!
!
no auto-register enable

```

```

!
! ip path-mtu-discovery is disabled in WAAS by default
!
ip name-server 10.4.48.10
!
!
ip access-list standard 55
  permit 10.4.48.0 0.0.0.255
  exit
!
ip access-list extended 155
  permit tcp 10.4.48.0 0.0.0.255 any eq ssh
  deny tcp any any eq ssh
  permit ip any any
  exit
!
!
ntp server 10.4.48.17
!
!
wccp router-list 7 10.4.32.241 10.4.32.242 10.4.32.243
wccp tcp-promiscuous service-pair 61 62
  router-list-num 7
  password ****
  redirect-method gre
  egress-method wccp-gre
  enable
  exit
!
!
!
!
username admin password 1 ****
username admin privilege 15
!
snmp-server community cisco
snmp-server community cisco123 rw
snmp-server access-list 55
!
!
!
tacacs key ****
tacacs password ascii
tacacs host 10.4.48.15 primary
!
authentication login local enable secondary
authentication login tacacs enable primary

```

```

authentication configuration local enable secondary
authentication configuration tacacs enable primary
authentication fail-over server-unreachable
!
!
no telnet enable
!
sshd enable
!
!
tfo tcp optimized-send-buffer 2048
tfo tcp optimized-receive-buffer 2048
!
!
accelerator mapi wansecure-mode auto
!
!
central-manager address 10.4.48.100
cms enable
!
!
stats-collector logging enable
stats-collector logging rate 30
!
!
! End of WAAS configuration

```

## WAN-Aggregation Router

```

version 15.3
!
hostname CE-ASR1001-2
!
ip wccp source-interface Loopback0
ip wccp 61 redirect-list WAAS-REDIRECT-LIST group-list WAVE password cisco123
ip wccp 62 redirect-list WAAS-REDIRECT-LIST group-list WAVE password cisco123
!
interface Loopback0
 ip address 10.4.32.242 255.255.255.255
!
interface Port-channel2
 ip address 10.4.32.6 255.255.255.252
 ip wccp 61 redirect in
!
interface GigabitEthernet0/0/3
 ip address 192.168.4.1 255.255.255.252
 ip wccp 62 redirect in
!

```

```
ip access-list standard WAVE
  permit 10.4.32.161
  permit 10.4.32.162
!
ip access-list extended WAAS-REDIRECT-LIST
  remark WAAS WCCP Redirect List
  deny tcp any any eq 22
  deny tcp any eq 22 any
  deny tcp any eq telnet any
  deny tcp any any eq telnet
  deny tcp any eq tacacs any
  deny tcp any any eq tacacs
  deny tcp any eq bgp any
  deny tcp any any eq bgp
  deny tcp any any eq 123
  deny tcp any eq 123 any
  deny tcp any any eq 161
  deny tcp any eq 161 any
  deny tcp any any eq 162
  deny tcp any eq 162 any
  deny tcp any any eq 2000
  deny tcp any eq 2000 any
  deny tcp any any eq 2443
  deny tcp any eq 2443 any
  deny tcp any any eq 5060
  deny tcp any eq 5060 any
  deny tcp any any eq 5061
  deny tcp any eq 5061 any
  deny tcp any any eq 1718
  deny tcp any eq 1718 any
  deny tcp any any eq 1720
  deny tcp any eq 1720 any
  deny tcp any any eq 2428
  deny tcp any eq 2428 any
  deny tcp any any eq 443
  deny tcp any eq 443 any
  deny tcp any any eq 8443
  deny tcp any eq 8443 any
  deny tcp any any eq 6970
  deny tcp any eq 6970 any
  deny tcp any any eq 689
  deny tcp any eq 689 any
  permit tcp any any
```

## WAN-Aggregation Router (DMVPN hub)

```
version 15.3
!
hostname VPN-ASR1002X-1
!
ip wccp source-interface Loopback0
ip wccp 61 redirect-list WAAS-REDIRECT-LIST group-list WAVE password cisco123
ip wccp 62 redirect-list WAAS-REDIRECT-LIST group-list WAVE password cisco123
!
interface Loopback0
 ip address 10.4.32.243 255.255.255.255
!
interface Port-channel3
 ip address 10.4.32.18 255.255.255.252
 ip wccp 61 redirect in
 ip wccp 62 redirect out
!
interface Tunnel10
 bandwidth 100000
 ip address 10.4.34.1 255.255.254.0
!
ip access-list standard WAVE
 permit 10.4.32.161
 permit 10.4.32.162
!
ip access-list extended WAAS-REDIRECT-LIST
 remark WAAS WCCP Redirect List
 deny tcp any any eq 22
 deny tcp any eq 22 any
 deny tcp any eq telnet any
 deny tcp any any eq telnet
 deny tcp any eq tacacs any
 deny tcp any any eq tacacs
 deny tcp any eq bgp any
 deny tcp any any eq bgp
 deny tcp any any eq 123
 deny tcp any eq 123 any
 deny tcp any any eq 161
 deny tcp any eq 161 any
 deny tcp any any eq 162
 deny tcp any eq 162 any
 deny tcp any any eq 2000
 deny tcp any eq 2000 any
 deny tcp any any eq 2443
 deny tcp any eq 2443 any
 deny tcp any any eq 5060
```

```

deny tcp any eq 5060 any
deny tcp any any eq 5061
deny tcp any eq 5061 any
deny tcp any any eq 1718
deny tcp any eq 1718 any
deny tcp any any eq 1720
deny tcp any eq 1720 any
deny tcp any any eq 2428
deny tcp any eq 2428 any
deny tcp any any eq 443
deny tcp any eq 443 any
deny tcp any any eq 8443
deny tcp any eq 8443 any
deny tcp any any eq 6970
deny tcp any eq 6970 any
deny tcp any any eq 689
deny tcp any eq 689 any
permit tcp any any

```

## AppNav Off Path Design Model

### AppNav Controller and WAAS Node

```

! waas-universal-k9 version 5.3.5a (build b5 Apr 10 2014)
!
device mode appnav-controller
!
interception-method wccp
!
!
hostname AppNav-WAVE-2
!
clock timezone PST8PDT -8 0
!
!
ip domain-name cisco.local
!
!
primary-interface PortChannel 1
!
interface PortChannel 1
 ip address 10.4.32.164 255.255.255.192
 ip access-group 155 in
 exit
interface PortChannel 2
 ip address 10.4.32.72 255.255.255.192
 ip access-group 155 in

```

```
exit
!
interface GigabitEthernet 0/0
shutdown
exit
interface GigabitEthernet 0/1
shutdown
exit
interface GigabitEthernet 1/0
channel-group 1
exit
interface GigabitEthernet 1/1
channel-group 1
exit
interface GigabitEthernet 1/2
channel-group 2
exit
interface GigabitEthernet 1/3
channel-group 2
exit
interface GigabitEthernet 1/4
shutdown
exit
interface GigabitEthernet 1/5
shutdown
exit
interface GigabitEthernet 1/6
shutdown
exit
interface GigabitEthernet 1/7
shutdown
exit
interface GigabitEthernet 1/8
shutdown
exit
interface GigabitEthernet 1/9
shutdown
exit
interface GigabitEthernet 1/10
shutdown
exit
interface GigabitEthernet 1/11
shutdown
exit
!
ip default-gateway 10.4.32.129
!
```



```

!
no auto-register enable
!
! ip path-mtu-discovery is disabled in WAAS by default
!
ip name-server 10.4.48.10
!
ip route 10.4.32.2 255.255.255.255 10.4.32.65
ip route 10.4.32.6 255.255.255.255 10.4.32.65
ip route 10.4.32.18 255.255.255.255 10.4.32.65
!
ip access-list standard 55
    permit 10.4.48.0 0.0.0.255
    exit
!
ip access-list extended 155
    permit tcp 10.4.48.0 0.0.0.255 any eq ssh
    deny tcp any any eq ssh
    permit ip any any
    exit
!
!
ntp server 10.4.48.17
!
!
wccp router-list 1 10.4.32.2 10.4.32.6 10.4.32.18
wccp tcp-promiscuous service-pair 61 62
    router-list-num 1
    password ****
    redirect-method gre
    enable
    exit
!
!
!
!
username admin password 1 ****
username admin privilege 15
!
snmp-server community cisco123 rw
snmp-server community cisco
snmp-server access-list 55
!
!
!
tacacs key ****
tacacs password ascii

```

```

tacacs host 10.4.48.15 primary
!
authentication login local enable secondary
authentication login tacacs enable primary
authentication configuration local enable secondary
authentication configuration tacacs enable primary
authentication fail-over server-unreachable
!
!
!
!
no telnet enable
!
sshd enable
!
!
tfo tcp optimized-send-buffer 2048
tfo tcp optimized-receive-buffer 2048
!
!
service-insertion service-node-group WNG-Default
    service-node 10.4.32.161
    service-node 10.4.32.162
    service-node 10.4.32.163
    service-node 10.4.32.164
    service-node 10.4.32.165
    service-node 10.4.32.166
    exit
!
!
accelerator mapi wansecure-mode auto
!
!
!
central-manager address 10.4.48.100
cms enable
!
!
stats-collector logging enable
stats-collector logging rate 30
!
service-insertion appnav-controller-group scg
    appnav-controller 10.4.32.163
    appnav-controller 10.4.32.164
    exit
!
!

```

```

service-insertion service-context AppNav-IOM
  description AppNav IOM CLuster
  authentication sha1 key ****
  appnav-controller-group scg
  service-node-group WNG-Default
  service-policy appnav_default
  enable
  exit
!
service-insertion service-node
  description WN of AppNav-IOM
  authentication sha1 key ****
  enable
  exit
!
!
! End of WAAS configuration

```

### Primary Site WAAS Node

```

! waas-universal-k9 version 5.3.5a (build b5 Apr 10 2014)
!
device mode application-accelerator
!
interception-method appnav-controller
!
!
hostname WAVE7341-1
!
clock timezone PST8PDT -8 0
!
!
ip domain-name cisco.local
!
!
primary-interface PortChannel 1
!
interface PortChannel 1
  ip address 10.4.32.161 255.255.255.192
  ip access-group 155 in
  exit
!
interface GigabitEthernet 1/0
  channel-group 1
  exit
interface GigabitEthernet 2/0
  channel-group 1
  exit

```

```

!
ip default-gateway 10.4.32.129
!
!
no auto-register enable
!
! ip path-mtu-discovery is disabled in WAAS by default
!
ip name-server 10.4.48.10
!
!
ip access-list standard 55
    permit 10.4.48.0 0.0.0.255
exit
!
ip access-list extended 155
    permit tcp 10.4.48.0 0.0.0.255 any eq ssh
    deny tcp any any eq ssh
    permit ip any any
exit
!
!
ntp server 10.4.48.17
!
!
!
!
!
!
username admin password 1 ****
username admin privilege 15
!
snmp-server community cisco
snmp-server community cisco123 rw
snmp-server access-list 55
!
!
!
tacacs key ****
tacacs password ascii
tacacs host 10.4.48.15 primary
!
authentication login local enable secondary
authentication login tacacs enable primary
authentication configuration local enable secondary
authentication configuration tacacs enable primary
authentication fail-over server-unreachable

```

```

!
!
!
no telnet enable
!
sshd enable
!
!
tfo tcp optimized-send-buffer 2048
tfo tcp optimized-receive-buffer 2048
!
!
!
accelerator mapi wansecure-mode auto
!
!
!
central-manager address 10.4.48.100
cms enable
!
!
stats-collector logging enable
stats-collector logging rate 30
!
service-insertion service-node
  description WN of AppNav-IOM
  authentication sha1 key ****
  enable
  exit
!
!
! End of WAAS configuration

```

## WAN-Aggregation Router

```

version 15.3
!
hostname CE-ASR1001-2
!
ip wccp source-interface Loopback0
ip wccp 61 redirect-list WAAS-REDIRECT-LIST group-list APPNAV password cisco123
ip wccp 62 redirect-list WAAS-REDIRECT-LIST group-list APPNAV password cisco123
!
interface Loopback0
  ip address 10.4.32.242 255.255.255.255
!
interface Port-channel2
  ip address 10.4.32.6 255.255.255.252

```

```

ip wccp 61 redirect in
!
interface Tunnel5
description GRE tunnel for AppNav OffPath devices
ip address 192.0.2.2 255.255.255.0
no ip redirects
ip wccp redirect exclude in
tunnel source Port-channel2
tunnel mode gre multipoint
!
interface GigabitEthernet0/0/3
ip address 192.168.4.1 255.255.255.252
ip wccp 62 redirect in
!
ip access-list standard APPNAV
permit 10.4.32.71
permit 10.4.32.72
!
ip access-list extended WAAS-REDIRECT-LIST
remark WAAS WCCP Redirect List
deny tcp any any eq 22
deny tcp any eq 22 any
deny tcp any eq telnet any
deny tcp any any eq telnet
deny tcp any eq tacacs any
deny tcp any any eq tacacs
deny tcp any eq bgp any
deny tcp any any eq bgp
deny tcp any any eq 123
deny tcp any eq 123 any
deny tcp any any eq 161
deny tcp any eq 161 any
deny tcp any any eq 162
deny tcp any eq 162 any
deny tcp any any eq 2000
deny tcp any eq 2000 any
deny tcp any any eq 2443
deny tcp any eq 2443 any
deny tcp any any eq 5060
deny tcp any eq 5060 any
deny tcp any any eq 5061
deny tcp any eq 5061 any
deny tcp any any eq 1718
deny tcp any eq 1718 any
deny tcp any any eq 1720
deny tcp any eq 1720 any
deny tcp any any eq 2428

```

```

deny tcp any eq 2428 any
deny tcp any any eq 443
deny tcp any eq 443 any
deny tcp any any eq 8443
deny tcp any eq 8443 any
deny tcp any any eq 6970
deny tcp any eq 6970 any
deny tcp any any eq 689
deny tcp any eq 689 any
permit tcp any any

```

## WAN-Aggregation Router (DMVPN hub)

```

version 15.3
!
hostname VPN-ASR1002X-1
!
ip wccp source-interface Loopback0
ip wccp 61 redirect-list WAAS-REDIRECT-LIST group-list APPNAV password cisco123
ip wccp 62 redirect-list WAAS-REDIRECT-LIST group-list APPNAV password cisco123
!
interface Loopback0
 ip address 10.4.32.243 255.255.255.255
!
interface Port-channel3
 ip address 10.4.32.18 255.255.255.252
 ip wccp 61 redirect in
 ip wccp 62 redirect out
!
interface Tunnel10
 bandwidth 100000
 ip address 10.4.34.1 255.255.254.0
!
ip access-list standard APPNAV
 permit 10.4.32.71
 permit 10.4.32.72
!
ip access-list extended WAAS-REDIRECT-LIST
 remark WAAS WCCP Redirect List
 deny tcp any any eq 22
 deny tcp any eq 22 any
 deny tcp any eq telnet any
 deny tcp any any eq telnet
 deny tcp any eq tacacs any
 deny tcp any any eq tacacs
 deny tcp any eq bgp any
 deny tcp any any eq bgp
 deny tcp any any eq 123

```

```

deny tcp any eq 123 any
deny tcp any any eq 161
deny tcp any eq 161 any
deny tcp any any eq 162
deny tcp any eq 162 any
deny tcp any any eq 2000
deny tcp any eq 2000 any
deny tcp any any eq 2443
deny tcp any eq 2443 any
deny tcp any any eq 5060
deny tcp any eq 5060 any
deny tcp any any eq 5061
deny tcp any eq 5061 any
deny tcp any any eq 1718
deny tcp any eq 1718 any
deny tcp any any eq 1720
deny tcp any eq 1720 any
deny tcp any any eq 2428
deny tcp any eq 2428 any
deny tcp any any eq 443
deny tcp any eq 443 any
deny tcp any any eq 8443
deny tcp any eq 8443 any
deny tcp any any eq 6970
deny tcp any eq 6970 any
deny tcp any any eq 689
deny tcp any eq 689 any
permit tcp any any

```

## AppNav-XE Design Model

### AppNav-XE Controller

```

version 15.3
!
hostname METRO-ASR1001-1
!
class-map type appnav match-any RTSP
  match access-group name APPNAV-ACL-RTSP
class-map type appnav match-any MAPI
  match protocol mapi
class-map type appnav match-any HTTP
  match access-group name APPNAV-ACL-HTTP
class-map type appnav match-any APPNAV-class-default
  match access-group name APPNAV-ACL-class-default
class-map type appnav match-any CIFS
  match access-group name APPNAV-ACL-CIFS

```



```

class-map type appnav match-any Citrix-CGP
  match access-group name APPNAV-ACL-Citrix-CGP
class-map type appnav match-any HTTPS
  match access-group name APPNAV-ACL-HTTPS
class-map type appnav match-any Citrix-ICA
  match access-group name APPNAV-ACL-Citrix-ICA
class-map type appnav match-any NFS
  match access-group name APPNAV-ACL-NFS
class-map type appnav match-any epmap
  match access-group name APPNAV-ACL-epmap
!
policy-map type appnav APPNAV-1-PMAP
  class MAPI
    distribute service-node-group WNG-Default-1
    monitor-load mapi
  class HTTPS
    distribute service-node-group WNG-Default-1
    monitor-load ssl
  class HTTP
    distribute service-node-group WNG-Default-1
    monitor-load http
  class CIFS
    distribute service-node-group WNG-Default-1
    monitor-load cifs
  class Citrix-ICA
    distribute service-node-group WNG-Default-1
    monitor-load ica
  class Citrix-CGP
    distribute service-node-group WNG-Default-1
    monitor-load ica
  class epmap
    distribute service-node-group WNG-Default-1
    monitor-load MS-port-mapper
  class NFS
    distribute service-node-group WNG-Default-1
    monitor-load nfs
  class RTSP
    distribute service-node-group WNG-Default-1
  class APPNAV-class-default
    distribute service-node-group WNG-Default-1
!
service-insertion service-node-group WNG-Default-1
  service-node 10.4.32.162
!
service-insertion appnav-controller-group scg
  appnav-controller 10.4.32.22
  appnav-controller 10.4.32.34

```

```

!
service-insertion service-context waas/1
  authentication sha1 key 7 130646010803557878
  appnav-controller-group scg
  service-node-group WNG-Default-1
  service-policy APPNAV-1-PMAP
  vrf global
  enable
!
interface Port-channel5
  ip address 10.4.32.34 255.255.255.252
!
interface GigabitEthernet0/0/3
  no ip address
!
interface GigabitEthernet0/0/3.38
  encapsulation dot1Q 38
  ip address 10.4.38.1 255.255.255.0
  service-insertion waas
!
interface GigabitEthernet0/0/3.39
  encapsulation dot1Q 39
  ip address 10.4.39.1 255.255.255.0
  service-insertion waas
!
interface AppNav-Compress1
  ip unnumbered Port-channel1
  no keepalive
!
interface AppNav-UnCompress1
  ip unnumbered Port-channel1
  no keepalive
!
ip access-list extended APPNAV-ACL-CIFS
  permit tcp any any eq 139
  permit tcp any any eq 445
ip access-list extended APPNAV-ACL-Citrix-CGP
  permit tcp any any eq 2598
ip access-list extended APPNAV-ACL-Citrix-ICA
  permit tcp any any eq 1494
ip access-list extended APPNAV-ACL-HTTP
  permit tcp any any eq www
  permit tcp any any eq 3128
  permit tcp any any eq 8000
  permit tcp any any eq 8080
  permit tcp any any eq 8088
ip access-list extended APPNAV-ACL-HTTPS

```

```

    permit tcp any any eq 443
ip access-list extended APPNAV-ACL-NFS
    permit tcp any any eq 2049
ip access-list extended APPNAV-ACL-RTSP
    permit tcp any any eq 554
    permit tcp any any eq 8554
ip access-list extended APPNAV-ACL-class-default
    permit tcp any any
ip access-list extended APPNAV-ACL-epmap
    permit tcp any any eq msrpc

```

## Primary Site WAAS Node

```

! waas-universal-k9 version version 5.3.5a (build b5 Apr 10 2014)
!
device mode application-accelerator
!
interception-method appnav-controller
!
!
hostname WAE7341-2
!
clock timezone PST8PDT -8 0
!
!
ip domain-name cisco.local
!
!
primary-interface PortChannel 1
!
interface PortChannel 1
    ip address 10.4.32.162 255.255.255.192
    ip access-group 155 in
    exit
!
interface GigabitEthernet 1/0
    channel-group 1
    exit
interface GigabitEthernet 2/0
    channel-group 1
    shutdown
    exit
!
ip default-gateway 10.4.32.129
!
!
no auto-register enable
!

```

```

! ip path-mtu-discovery is disabled in WAAS by default
!
ip name-server 10.4.48.10
!
!
ip access-list standard 55
  permit 10.4.48.0 0.0.0.255
  exit
!
ip access-list extended 155
  permit tcp 10.4.48.0 0.0.0.255 any eq ssh
  deny tcp any any eq ssh
  permit ip any any
  exit
!
!
ntp server 10.4.48.17
!
!
username admin password 1 ****
username admin privilege 15
!
snmp-server community cisco
snmp-server community cisco123 rw
snmp-server access-list 55
!
!
!
tacacs key ****
tacacs password ascii
tacacs host 10.4.48.15 primary
!
authentication login local enable secondary
authentication login tacacs enable primary
authentication configuration local enable secondary
authentication configuration tacacs enable primary
authentication fail-over server-unreachable
!
!
!
no telnet enable
!
sshd enable
!
!
tfo tcp optimized-send-buffer 2048
tfo tcp optimized-receive-buffer 2048

```

```

!
!
!
accelerator mapi wansecure-mode auto
!
!
!
central-manager address 10.4.48.100
cms enable
!
!
!
!
!
stats-collector logging enable
stats-collector logging rate 30
!
service-insertion service-node
  description WN of AppNav-XE
  authentication sha1 key ****
  enable
  exit
!
!
! End of WAAS configuration

```

## Remote Sites

### RS202 WAAS Node

```

! waas-universal-k9 version version 5.3.5a (build b5 Apr 10 2014)
!
device mode application-accelerator
!
interception-method wccp
!
!
hostname RS202-WAVE594
!
clock timezone PST8PDT -8 0
!
!
ip domain-name cisco.local
!
!
primary-interface GigabitEthernet 0/0
!

```

```

interface GigabitEthernet 0/0
 ip address 10.5.68.8 255.255.255.0
 ip access-group 155 in
 exit
interface GigabitEthernet 0/1
 shutdown
 exit
!
ip default-gateway 10.5.68.1
!
!
no auto-register enable
!
! ip path-mtu-discovery is disabled in WAAS by default
!
ip name-server 10.4.48.10
!
bmc lan ip address set-to-factory-default
no bmc lan enable
no bmc serial-over-lan enable
!
!
ip access-list standard 55
 permit 10.4.48.0 0.0.0.255
 exit
!
ip access-list extended 155
 permit tcp 10.4.48.0 0.0.0.255 any eq ssh
 deny tcp any any eq ssh
 permit ip any any
 exit
!
!
ntp server 10.4.48.17
!
!
wccp router-list 7 10.255.252.202
wccp tcp-promiscuous service-pair 61 62
 router-list-num 7
 password ****
 redirect-method gre
 egress-method wccp-gre
 enable
 exit
!
!
username admin password 1 ****

```

```

username admin privilege 15
!
snmp-server community cisco
snmp-server community cisco123 rw
snmp-server access-list 55
!
!
tacacs key ****
tacacs password ascii
tacacs host 10.4.48.15 primary
!
authentication login local enable secondary
authentication login tacacs enable primary
authentication configuration local enable secondary
authentication configuration tacacs enable primary
authentication fail-over server-unreachable
!
!
!
no telnet enable
!
sshd enable
!
!
tfo tcp optimized-send-buffer 2048
tfo tcp optimized-receive-buffer 2048
!
!
accelerator mapi wansecure-mode auto
!
!
virtual-blade enable
!
central-manager address 10.4.48.100
cms enable
!
!
!
!
!
stats-collector logging enable
stats-collector logging rate 30
!
!
! End of WAAS configuration

```

## RS202 WAN Router

```
version 15.3
!
hostname RS202-2911
!
ip wccp source-interface Loopback0
ip wccp 61 redirect-list WAAS-REDIRECT-LIST group-list WAVE password cisco123
ip wccp 62 redirect-list WAAS-REDIRECT-LIST group-list WAVE password cisco123
!
interface Loopback0
 ip address 10.255.252.202 255.255.255.255
!
interface Tunnel10
 ip address 10.4.34.202 255.255.254.0
 ip wccp 62 redirect in
!
interface GigabitEthernet0/0
 ip address 192.168.4.5 255.255.255.252
 ip wccp 62 redirect in
!
interface GigabitEthernet0/2
 no ip address
!
interface GigabitEthernet0/2.64
 encapsulation dot1Q 64
 ip address 10.5.68.1 255.255.255.0
 ip wccp 61 redirect in
!
ip access-list standard WAVE
 permit 10.5.68.8
!
ip access-list extended WAAS-REDIRECT-LIST
 remark WAAS WCCP Redirect List
 deny tcp any any eq 22
 deny tcp any eq 22 any
 deny tcp any eq telnet any
 deny tcp any any eq telnet
 deny tcp any eq tacacs any
 deny tcp any any eq tacacs
 deny tcp any eq bgp any
 deny tcp any any eq bgp
 deny tcp any any eq 123
 deny tcp any eq 123 any
 deny tcp any any eq 161
 deny tcp any eq 161 any
 deny tcp any any eq 162
```



```

deny tcp any eq 162 any
deny tcp any any eq 2000
deny tcp any eq 2000 any
deny tcp any any eq 2443
deny tcp any eq 2443 any
deny tcp any any eq 5060
deny tcp any eq 5060 any
deny tcp any any eq 5061
deny tcp any eq 5061 any
deny tcp any any eq 1718
deny tcp any eq 1718 any
deny tcp any any eq 1720
deny tcp any eq 1720 any
deny tcp any any eq 2428
deny tcp any eq 2428 any
deny tcp any any eq 443
deny tcp any eq 443 any
deny tcp any any eq 8443
deny tcp any eq 8443 any
deny tcp any any eq 6970
deny tcp any eq 6970 any
deny tcp any any eq 689
deny tcp any eq 689 any
permit tcp any any

```

## RS240 WAAS Node (vWAAS)

```

! waas-universal-k9 version 5.3.5a (build b5 Apr 10 2014)
!
device mode application-accelerator
!
interception-method wccp
!
!
hostname RS240-vWAAS-2500
!
clock timezone PST8PDT -8 0
!
!
ip domain-name cisco.local
!
!
primary-interface Virtual 1/0
!
interface Virtual 1/0
 ip address 10.5.244.8 255.255.255.0
 ip access-group 155 in
 exit

```

```

interface Virtual 2/0
 shutdown
 exit
!
ip default-gateway 10.5.244.1
!
!
no auto-register enable
!
! ip path-mtu-discovery is disabled in WAAS by default
!
ip name-server 10.4.48.10
!
!
ip access-list standard 55
 permit 10.4.48.0 0.0.0.255
 exit
!
ip access-list extended 155
 permit tcp 10.4.48.0 0.0.0.255 any eq ssh
 deny tcp any any eq ssh
 permit ip any any
 exit
!
!
ntp server 10.4.48.17
!
!
wccp router-list 7 10.255.251.240
wccp tcp-promiscuous service-pair 61 62
 router-list-num 7
 password ****
 redirect-method gre
 egress-method wccp-gre
 enable
 exit
!
!
!
!
username admin password 1 ****
username admin privilege 15
!
snmp-server community cisco
snmp-server community cisco123 rw
!
!

```

```

!
tacacs key ****
tacacs password ascii
tacacs host 10.4.48.15 primary
!
authentication login local enable secondary
authentication login tacacs enable primary
authentication configuration local enable secondary
authentication configuration tacacs enable primary
authentication fail-over server-unreachable
!
!
no telnet enable
!
sshd enable
!
!
tfo tcp optimized-send-buffer 2048
tfo tcp optimized-receive-buffer 2048
!
!
accelerator mapi wansecure-mode auto
!
!
central-manager address 10.4.48.100
cms enable
!
!
!
stats-collector logging enable
stats-collector logging rate 30
!
!
! End of WAAS configuration

```

### **RS240 WAN Router (UCS E-Series)**

```

version 15.3
!
hostname RS240-3925
!
ip wccp source-interface Loopback0
ip wccp 61 redirect-list WAAS-REDIRECT-LIST group-list WAVE password cisco123
ip wccp 62 redirect-list WAAS-REDIRECT-LIST group-list WAVE password cisco123
!
interface Loopback0
 ip address 10.255.251.240 255.255.255.255
!

```

```

interface Tunnel10
 ip address 10.4.34.240 255.255.254.0
 ip wccp 62 redirect in
!
interface GigabitEthernet0/0
 ip address 192.168.3.49 255.255.255.252
 ip wccp 62 redirect in
!
interface GigabitEthernet0/2
 no ip address
!
interface GigabitEthernet0/2.64
 encapsulation dot1Q 64
 ip address 10.5.244.1 255.255.255.0
 ip wccp 61 redirect in
!
interface ucse1/0
 ip unnumbered GigabitEthernet0/2.64
 imc ip address 10.5.244.10 255.255.255.0 default-gateway 10.5.244.1
 imc access-port shared-lom console
!
ip route 10.5.244.10 255.255.255.255 ucse1/0
ip route 10.5.244.11 255.255.255.255 ucse1/0
!
ip access-list standard WAVE
 permit 10.5.244.8
!
ip access-list extended WAAS-REDIRECT-LIST
 remark WAAS WCCP Redirect List
 deny tcp any any eq telnet
 deny tcp any eq telnet any
 deny tcp any any eq 22
 deny tcp any eq 22 any
 deny tcp any any eq 161
 deny tcp any eq 161 any
 deny tcp any any eq 162
 deny tcp any eq 162 any
 deny tcp any any eq 123
 deny tcp any eq 123 any
 deny tcp any any eq bgp
 deny tcp any eq bgp any
 deny tcp any any eq tacacs
 deny tcp any eq tacacs any
 deny tcp any any eq 2000
 deny tcp any eq 2000 any
 deny tcp any any eq 2443
 deny tcp any eq 2443 any

```

```

deny tcp any any eq 5060
deny tcp any eq 5060 any
deny tcp any any eq 5061
deny tcp any eq 5016 any
deny tcp any any eq 1718
deny tcp any eq 1718 any
deny tcp any any eq 1720
deny tcp any eq 1720 any
deny tcp any any eq 2428
deny tcp any eq 2428 any
deny tcp any any eq 443
deny tcp any eq 443 any
deny tcp any any eq 8443
deny tcp any eq 8443 any
deny tcp any any eq 6970
deny tcp any eq 6970 any
deny tcp any any eq 689
deny tcp any eq 689 any
permit tcp any any

```

## RS201 WAAS Node (SRE)

```

! waas-universal-k9 version 5.3.5a (build b5 Apr 10 2014)
!
device mode application-accelerator
!
interception-method wccp
!
!
hostname RS201-2911-SRE
!
clock timezone PST8PDT -8 0
!
!
ip domain-name cisco.local
!
!
primary-interface GigabitEthernet 2/0
!
interface GigabitEthernet 1/0
 shutdown
 exit
interface GigabitEthernet 2/0
 ip address 10.5.44.8 255.255.255.0
 ip access-group 155 in
 exit
!
ip default-gateway 10.5.44.1

```

```

!
!
no auto-register enable
!
! ip path-mtu-discovery is disabled in WAAS by default
!
ip name-server 10.4.48.10
!
!
ip access-list standard 55
  permit 10.4.48.0 0.0.0.255
  exit
!
ip access-list extended 155
  permit tcp 10.4.48.0 0.0.0.255 any eq ssh
  deny tcp any any eq ssh
  permit ip any any
  exit
!
!
ntp server 10.4.48.17
!
!
wccp router-list 7 10.255.251.201
wccp tcp-promiscuous service-pair 61 62
  router-list-num 7
  password ****
  redirect-method gre
  egress-method wccp-gre
  enable
  exit
!
!
username admin password 1 ****
username admin privilege 15
!
snmp-server community cisco123 rw
snmp-server community cisco
snmp-server access-list 55
!
!
tacacs key ****
tacacs password ascii
tacacs host 10.4.48.15 primary
!
authentication login local enable secondary
authentication login tacacs enable primary

```

```

authentication configuration local enable secondary
authentication configuration tacacs enable primary
authentication fail-over server-unreachable
!
!
no telnet enable
!
sshd enable
!
!
tfo tcp optimized-send-buffer 2048
tfo tcp optimized-receive-buffer 2048
!
!
accelerator mapi wansecure-mode auto
!
!
central-manager address 10.4.48.100
cms enable
!
!
stats-collector logging enable
stats-collector logging rate 30
!
!
! End of WAAS configuration

```

## RS201 WAN Router (SRE)

```

version 15.3
!
hostname RS201-2911
!
aaa authentication login MODULE none
!
ip wccp source-interface Loopback0
ip wccp 61 redirect-list WAAS-REDIRECT-LIST group-list WAVE password cisco123
ip wccp 62 redirect-list WAAS-REDIRECT-LIST group-list WAVE password cisco123
!
interface Loopback0
 ip address 10.255.251.201 255.255.255.255
!
interface Tunnel10
 ip address 10.4.34.201 255.255.254.0
 ip wccp 62 redirect in
!
interface Port-channel1
 no ip address

```

```

!
interface Port-channel1.64
  encapsulation dot1Q 64
  ip address 10.5.44.1 255.255.255.0
  ip wccp 61 redirect in
!
interface GigabitEthernet0/0
  ip address 192.168.3.21 255.255.255.252
  ip wccp 62 redirect in
!
interface SM1/0
  ip address 192.0.2.2 255.255.255.252
  service-module external ip address 10.5.44.8 255.255.255.0
  service-module ip default-gateway 10.5.44.1
!
ip access-list standard WAVE
  permit 10.5.44.8
!
ip access-list extended WAAS-REDIRECT-LIST
  remark WAAS WCCP Redirect List
  deny tcp any any eq telnet
  deny tcp any eq telnet any
  deny tcp any any eq 22
  deny tcp any eq 22 any
  deny tcp any any eq 161
  deny tcp any eq 161 any
  deny tcp any any eq 162
  deny tcp any eq 162 any
  deny tcp any any eq 123
  deny tcp any eq 123 any
  deny tcp any any eq bgp
  deny tcp any eq bgp any
  deny tcp any any eq tacacs
  deny tcp any eq tacacs any
  deny tcp any any eq 2000
  deny tcp any eq 2000 any
  deny tcp any any eq 2443
  deny tcp any eq 2443 any
  deny tcp any any eq 5060
  deny tcp any eq 5060 any
  deny tcp any any eq 5061
  deny tcp any eq 5016 any
  deny tcp any any eq 1718
  deny tcp any eq 1718 any
  deny tcp any any eq 1720
  deny tcp any eq 1720 any
  deny tcp any any eq 2428

```



```

deny tcp any eq 2428 any
deny tcp any any eq 443
deny tcp any eq 443 any
deny tcp any any eq 8443
deny tcp any eq 8443 any
deny tcp any any eq 6970
deny tcp any eq 6970 any
deny tcp any any eq 689
deny tcp any eq 689 any
permit tcp any any
!
access-list 67 permit 192.0.2.2
!
line 67
  access-class 67 in
  login authentication MODULE

```

## RS204 WAASx WAN Router

```

version 15.3
!
hostname RS204-1941
!
parameter-map type waas waas_global
  tfo optimize full
  tfo auto-discovery blacklist enable
  lz entropy-check
  dre upload
  accelerator http-express
    no enable
  accelerator cifs-express
    no enable
  accelerator ssl-express
    enable
!
class-map type waas match-any BFTP
  match tcp destination port 152
class-map type waas match-any proshare
  match tcp destination port 5713 5717
class-map type waas match-any msnp
  match tcp destination port 1863
  match tcp destination port 6891 6900
class-map type waas match-any Laplink-surfup-HTTPS
  match tcp destination port 1184
class-map type waas match-any msmq
  match tcp destination port 1801
  match tcp destination port 2101
  match tcp destination port 2103

```

```

    match tcp destination port 2105
class-map type waas match-any rrac
    match tcp destination port 5678
class-map type waas match-any nameserver
    match tcp destination port 42
class-map type waas match-any ms-sql-s
    match tcp destination port 1433
class-map type waas match-any WINS
    match tcp destination port 1512
class-map type waas match-any NNTP
    match tcp destination port 119
class-map type waas match-any PPTP
    match tcp destination port 1723
class-map type waas match-any hp-pdl-datastr
    match tcp destination port 9100
class-map type waas match-any RTSP
    match tcp destination port 554
    match tcp destination port 8554
class-map type waas match-any VocalTec
    match tcp destination port 1490
    match tcp destination port 6670
    match tcp destination port 25793
    match tcp destination port 22555
class-map type waas match-any PostgreSQL
    match tcp destination port 5432
class-map type waas match-any Danware-NetOp
    match tcp destination port 6502
class-map type waas match-any TACACS
    match tcp destination port 49
class-map type waas match-any isns
    match tcp destination port 3205
class-map type waas match-any klogin
    match tcp destination port 543
class-map type waas match-any auth
    match tcp destination port 113
class-map type waas match-any Cisco-CallManager
    match tcp destination port 2748
    match tcp destination port 2443
class-map type waas match-any sunrpc
    match tcp destination port 111
class-map type waas match-any ccm ail
    match tcp destination port 3264
class-map type waas match-any netrjs-3
    match tcp destination port 73
class-map type waas match-any orasrv
    match tcp destination port 1525
    match tcp destination port 1521

```

```

class-map type waas match-any ircs
  match tcp destination port 994
class-map type waas match-any PDMWorks
  match tcp destination port 30000
  match tcp destination port 40000
class-map type waas match-any eTrust-policy-Compliance
  match tcp destination port 1267
class-map type waas match-any ircu
  match tcp destination port 531
  match tcp destination port 6660 6665
  match tcp destination port 6667 6669
class-map type waas match-any timbuktu
  match tcp destination port 407
class-map type waas match-any sshell
  match tcp destination port 614
class-map type waas match-any corba-iiop-ssl
  match tcp destination port 684
class-map type waas match-any sametime
  match tcp destination port 1533
class-map type waas match-any Laplink-ShareDirect
  match tcp destination port 2705
class-map type waas match-any EMC-SRDFA-IP
  match tcp destination port 1748
class-map type waas match-any FTPS
  match tcp source port 989
class-map type waas match-any ftps
  match tcp destination port 990
class-map type waas match-any novadigm
  match tcp destination port 3460
  match tcp destination port 3461
  match tcp destination port 3464
class-map type waas match-any tell
  match tcp destination port 754
class-map type waas match-any sftp
  match tcp destination port 115
class-map type waas match-any talk
  match tcp destination port 517
class-map type waas match-any Veritas-NetBackup
  match tcp destination port 13720
  match tcp destination port 13721
  match tcp destination port 13782
  match tcp destination port 13785
class-map type waas match-any Basic-TCP-services
  match tcp destination port 1 19
class-map type waas match-any cvspserver
  match tcp destination port 2401
class-map type waas match-any imap

```

```

    match tcp destination port 143
class-map type waas match-any kshell
    match tcp destination port 544
class-map type waas match-any ms-olap4
    match tcp destination port 2383
class-map type waas match-any TFTP
    match tcp destination port 69
class-map type waas match-any svrloc
    match tcp destination port 427
class-map type waas match-any HTTP
    match tcp destination port 80
    match tcp destination port 8080
    match tcp destination port 8000
    match tcp destination port 8088
    match tcp destination port 3128
class-map type waas match-any panywheredata
    match tcp destination port 5631 5632
    match tcp destination port 65301
class-map type waas match-any QMTP
    match tcp destination port 209
class-map type waas match-any LDAP
    match tcp destination port 389
    match tcp destination port 8404
class-map type waas match-any sqlsrv
    match tcp destination port 156
class-map type waas match-any smtp
    match tcp destination port 25
class-map type waas match-any BitTorrent
    match tcp destination port 6881 6889
    match tcp destination port 6969
class-map type waas match-any exec
    match tcp destination port 512
class-map type waas match-any FCIP
    match tcp destination port 3225
class-map type waas match-any UniSQL
    match tcp destination port 1978
    match tcp destination port 1979
class-map type waas match-any openmail
    match tcp destination port 5755
    match tcp destination port 5757
    match tcp destination port 5766
    match tcp destination port 5767
    match tcp destination port 5768
    match tcp destination port 5729
class-map type waas match-any ssl
    match tcp destination port 3352
class-map type waas match-any SoulSeek

```

```

    match tcp destination port 2234
    match tcp destination port 5534
class-map type waas match-any WBEM
    match tcp destination port 5987 5990
class-map type waas match-any ms-sql-m
    match tcp destination port 1434
class-map type waas match-any afpovertcp
    match tcp destination port 548
class-map type waas match-any CIFS
    match tcp destination port 139
    match tcp destination port 445
class-map type waas match-any IBM-TSM
    match tcp destination port 1500 1502
class-map type waas match-any xmpp-client
    match tcp destination port 5222
class-map type waas match-any pcsync-http
    match tcp destination port 8444
class-map type waas match-any xprint-server
    match tcp destination port 8100
class-map type waas match-any Telnet
    match tcp destination port 23
    match tcp destination port 107
class-map type waas match-any Remote-Anything
    match tcp destination port 3999 4000
class-map type waas match-any Double-Take
    match tcp destination port 1105
    match tcp destination port 1100
class-map type waas match-any cisco-q931-backhaul
    match tcp destination port 2428
class-map type waas match-any msft-gc
    match tcp destination port 3268
class-map type waas match-any net-assistant
    match tcp destination port 3283
class-map type waas match-any imap3
    match tcp destination port 220
class-map type waas match-any ms-content-repl-srv
    match tcp destination port 560
    match tcp destination port 507
class-map type waas match-any netapp-snapmirror
    match tcp destination port 10565 10569
class-map type waas match-any Amanda
    match tcp destination port 10080
class-map type waas match-any gds_db
    match tcp destination port 3050
class-map type waas match-any radmin-port
    match tcp destination port 4899
class-map type waas match-any PSOM-MTLS

```

```

    match tcp destination port 8057
class-map type waas match-any sybase-sqlany
    match tcp destination port 1498
    match tcp destination port 2638
    match tcp destination port 2439
    match tcp destination port 3968
class-map type waas match-any print-srv
    match tcp destination port 170
class-map type waas match-any EMC-Celerra-Replicator
    match tcp destination port 8888
class-map type waas match-any ftps-data
    match tcp source port 20
class-map type waas match-any Gnutella
    match tcp destination port 6346 6349
    match tcp destination port 6355
    match tcp destination port 5634
class-map type waas match-any HP-OpenView
    match tcp destination port 7426 7431
    match tcp destination port 7501
    match tcp destination port 7510
class-map type waas match-any sip-tls
    match tcp destination port 5061
class-map type waas match-any Yahoo-Messenger
    match tcp destination port 5000 5001
    match tcp destination port 5050
    match tcp destination port 5100
class-map type waas match-any pop3s
    match tcp destination port 995
class-map type waas match-any Apple-iChat
    match tcp destination port 5297
    match tcp destination port 5298
class-map type waas match-any Siebel
    match tcp destination port 8448
    match tcp destination port 2320
    match tcp destination port 2321
class-map type waas match-any Kerberos
    match tcp destination port 88
    match tcp destination port 888
    match tcp destination port 2053
class-map type waas match-any MS-GROOVE
    match tcp destination port 2492
class-map type waas match-any MS-NetMeeting
    match tcp destination port 522
    match tcp destination port 1503
    match tcp destination port 1731
class-map type waas match-any Oracle
    match tcp destination port 66

```

```

class-map type waas match-any ssc-agent
  match tcp destination port 2847
  match tcp destination port 2848
  match tcp destination port 2967
  match tcp destination port 2968
  match tcp destination port 38037
  match tcp destination port 38292
class-map type waas match-any soap-http
  match tcp destination port 7627
class-map type waas match-any Pervasive-SQL
  match tcp destination port 1583
class-map type waas match-any iFCP
  match tcp destination port 3420
class-map type waas match-any sql-net
  match tcp destination port 150
class-map type waas match-any xmpp-server
  match tcp destination port 5269
class-map type waas match-any pcmail-srv
  match tcp destination port 158
class-map type waas match-any AOL
  match tcp destination port 5190 5193
class-map type waas match-any SAP
  match tcp destination port 3200 3204
  match tcp destination port 3206 3219
  match tcp destination port 3390 3399
  match tcp destination port 3284 3305
  match tcp destination port 3226 3259
  match tcp destination port 3261 3263
  match tcp destination port 3265 3267
  match tcp destination port 3662 3699
  match tcp destination port 3221 3224
  match tcp destination port 3270 3282
  match tcp destination port 3307 3351
  match tcp destination port 3353 3388
  match tcp destination port 3600 3658
class-map type waas match-any waas-default
  match tcp any
class-map type waas match-any TFTP
  match tcp destination port 3713
class-map type waas match-any WinMX
  match tcp destination port 6699
class-map type waas match-any ezMeeting
  match tcp destination port 10101 10103
  match tcp destination port 26260 26261
class-map type waas match-any afs3
  match tcp destination port 7000 7009
class-map type waas match-any NetIQ

```

```
match tcp destination port 2220
match tcp destination port 2735
match tcp destination port 10113 10116
class-map type waas match-any Grouper
  match tcp destination port 8038
class-map type waas match-any apple-sasl
  match tcp destination port 3659
class-map type waas match-any SSH
  match tcp destination port 22
class-map type waas match-any h323hostcallsc
  match tcp destination port 1300
class-map type waas match-any IPP
  match tcp destination port 631
class-map type waas match-any NTP
  match tcp destination port 123
class-map type waas match-any VoIP-Control
  match tcp destination port 1718 1719
  match tcp destination port 11000 11999
class-map type waas match-any HTTPS
  match tcp destination port 443
class-map type waas match-any mgcp-gateway
  match tcp destination port 2427
class-map type waas match-any Clearcase
  match tcp destination port 371
class-map type waas match-any novell-zen
  match tcp destination port 1761 1763
  match tcp destination port 2544
  match tcp destination port 8039
  match tcp destination port 2037
class-map type waas match-any iso-tsap
  match tcp destination port 102
class-map type waas match-any ms-streaming
  match tcp destination port 1755
class-map type waas match-any Napster
  match tcp destination port 8875
  match tcp destination port 7777
  match tcp destination port 6700
  match tcp destination port 6666
  match tcp destination port 6677
  match tcp destination port 6688
class-map type waas match-any mgcp-callagent
  match tcp destination port 2727
class-map type waas match-any Kazaa
  match tcp destination port 1214
class-map type waas match-any kerberos-adm
  match tcp destination port 749
class-map type waas match-any Telnets
```



```

    match tcp destination port 992
class-map type waas match-any pcsync-https
    match tcp destination port 8443
class-map type waas match-any WASTE
    match tcp destination port 1337
class-map type waas match-any BGP
    match tcp destination port 179
class-map type waas match-any BMC-Patrol
    match tcp destination port 6161
    match tcp destination port 6162
    match tcp destination port 8160
    match tcp destination port 8161
    match tcp destination port 6767
    match tcp destination port 6768
    match tcp destination port 10128
class-map type waas match-any Rsync
    match tcp destination port 873
class-map type waas match-any Qnext
    match tcp destination port 44
    match tcp destination port 5555
class-map type waas match-any Liquid-Audio
    match tcp destination port 18888
class-map type waas match-any timbuktu-srv
    match tcp destination port 1417 1420
class-map type waas match-any eDonkey
    match tcp destination port 4661 4662
class-map type waas match-any h323hostcall
    match tcp destination port 1720
class-map type waas match-any DNS
    match tcp destination port 53
class-map type waas match-any Filenet
    match tcp destination port 32768 32774
class-map type waas match-any backup-express
    match tcp destination port 6123
class-map type waas match-any ControlIT
    match tcp destination port 799
class-map type waas match-any NFS
    match tcp destination port 2049
class-map type waas match-any Netopia-netOctopus
    match tcp destination port 1917
    match tcp destination port 1921
class-map type waas match-any VNC
    match tcp destination port 5800 5809
    match tcp destination port 5900 5909
class-map type waas match-any Vmware-VMConsole
    match tcp destination port 902
class-map type waas match-any cisco-sccp

```

```
match tcp destination port 2000 2002
class-map type waas match-any intersys-cache
  match tcp destination port 1972
class-map type waas match-any pop3
  match tcp destination port 110
class-map type waas match-any Other-Secure
  match tcp destination port 261
  match tcp destination port 448
  match tcp destination port 695
  match tcp destination port 2252
  match tcp destination port 2478
  match tcp destination port 2479
  match tcp destination port 2482
  match tcp destination port 2484
  match tcp destination port 2679
  match tcp destination port 2762
  match tcp destination port 2998
  match tcp destination port 3077
  match tcp destination port 3078
  match tcp destination port 3183
  match tcp destination port 3191
  match tcp destination port 3220
  match tcp destination port 3410
  match tcp destination port 3424
  match tcp destination port 3471
  match tcp destination port 3496
  match tcp destination port 3509
  match tcp destination port 3529
  match tcp destination port 3539
  match tcp destination port 3660
  match tcp destination port 3661
  match tcp destination port 3747
  match tcp destination port 3864
  match tcp destination port 3885
  match tcp destination port 3896
  match tcp destination port 3897
  match tcp destination port 3995
  match tcp destination port 4031
  match tcp destination port 5007
  match tcp destination port 7674
  match tcp destination port 9802
  match tcp destination port 12109
class-map type waas match-any IBM-DB2
  match tcp destination port 523
class-map type waas match-any citriximaclient
  match tcp destination port 2598
class-map type waas match-any Legato-RepliStor
```

```
match tcp destination port 7144
match tcp destination port 7145
class-map type waas match-any lotusnote
  match tcp destination port 1352
class-map type waas match-any MDAemon
  match tcp destination port 3000
  match tcp destination port 3001
class-map type waas match-any dmdocbroker
  match tcp destination port 1489
class-map type waas match-any ftp
  match tcp destination port 21
class-map type waas match-any Altiris-CarbonCopy
  match tcp destination port 1680
class-map type waas match-any login
  match tcp destination port 513
class-map type waas match-any iscsi
  match tcp destination port 3260
class-map type waas match-any msft-gc-ssl
  match tcp destination port 3269
class-map type waas match-any objcall
  match tcp destination port 94
  match tcp destination port 627
  match tcp destination port 1965
  match tcp destination port 1580
  match tcp destination port 1581
class-map type waas match-any imaps
  match tcp destination port 993
class-map type waas match-any printer
  match tcp destination port 515
class-map type waas match-any netbios
  match tcp destination port 137
class-map type waas match-any smtps
  match tcp destination port 465
class-map type waas match-any kpasswd
  match tcp destination port 464
class-map type waas match-any epmapi
  match tcp destination port 135
class-map type waas match-any ldaps
  match tcp destination port 636
class-map type waas match-any cmd
  match tcp destination port 514
class-map type waas match-any sip
  match tcp destination port 5060
class-map type waas match-any ica
  match tcp destination port 1494
class-map type waas match-any cuseeme
  match tcp destination port 7640
```

```

match tcp destination port 7642
match tcp destination port 7648
match tcp destination port 7649
class-map type waas match-any Legato-NetWorker
match tcp destination port 7937
match tcp destination port 7938
match tcp destination port 7939
class-map type waas match-any citrixadmin
match tcp destination port 2513
class-map type waas match-any sqlexec
match tcp destination port 9088 9089
class-map type waas match-any CommVault
match tcp destination port 8400 8403
class-map type waas match-any Veritas-BackupExec
match tcp destination port 6101
match tcp destination port 6102
match tcp destination port 6106
match tcp destination port 3527
match tcp destination port 1125
class-map type waas match-any nntps
match tcp destination port 563
class-map type waas match-any groupwise
match tcp destination port 1677
match tcp destination port 9850
match tcp destination port 7205
match tcp destination port 3800
match tcp destination port 7100
match tcp destination port 7180
match tcp destination port 7101
match tcp destination port 7181
match tcp destination port 2800
class-map type waas match-any x11
match tcp destination port 6000 6063
class-map type waas match-any citrixima
match tcp destination port 2512
class-map type waas match-any L2TP
match tcp destination port 1701
class-map type waas match-any LANDesk
match tcp destination port 9535
match tcp destination port 9593 9595
class-map type waas match-any ms-wbt-server
match tcp destination port 3389
class-map type waas match-any MySQL
match tcp destination port 3306
class-map type waas match-any netviewdm
match tcp destination port 729 731
class-map type waas match-any OpenVPN

```

```

    match tcp destination port 1194
class-map type waas match-any sqlserv
    match tcp destination port 118
class-map type waas match-any HotLine
    match tcp destination port 5500 5503
class-map type waas match-any laplink
    match tcp destination port 1547
class-map type waas match-any ncp
    match tcp destination port 524
class-map type waas match-any flowmonitor
    match tcp destination port 7878
class-map type waas match-any connected
    match tcp destination port 16384
!
!
policy-map type waas waas_global
    class afs3
        optimize tfo dre lz application File-System
    class AOL
        passthrough application Instant-Messaging
    class Altiris-CarbonCopy
        passthrough application Remote-Desktop
    class Amanda
        optimize tfo application Backup
    class hp-pdl-datastr
        optimize tfo dre lz application Printing
    class afpovertcp
        optimize tfo dre lz application File-System
    class net-assistant
        passthrough application Remote-Desktop
    class Apple-iChat
        passthrough application Instant-Messaging
    class BFTP
        optimize tfo dre lz application File-Transfer
    class BGP
        passthrough application Other
    class BMC-Patrol
        passthrough application Systems-Management
    class backup-express
        optimize tfo application Backup
    class Basic-TCP-services
        passthrough application Other
    class BitTorrent
        passthrough application P2P
    class gds_db
        optimize tfo dre lz application SQL
    class CIFS

```

```

    optimize tfo dre lz application CIFS accelerate cifs-express
class cuseeme
    passthrough application Conferencing
class cvspserver
    optimize tfo dre lz application Version-Management
class Cisco-CallManager
    passthrough application Call-Management
class ica
    optimize tfo dre lz application Remote-Desktop
class citriximaclient
    optimize tfo dre lz application Remote-Desktop
class Clearcase
    optimize tfo dre lz application Version-Management
class CommVault
    optimize tfo application Backup
class connected
    optimize tfo application Backup
class ControlIT
    optimize tfo application Remote-Desktop
class DNS
    passthrough application Name-Services
class Danware-NetOp
    optimize tfo application Remote-Desktop
class dmdocbroker
    optimize tfo dre lz application Content-Management
class Double-Take
    optimize tfo dre lz application Replication
class EMC-Celerra-Replicator
    optimize tfo dre lz application Replication
class EMC-SRDFA-IP
    optimize tfo dre lz application Storage
class FCIP
    optimize tfo lz application Storage
class ftp
    passthrough application File-Transfer
class ftps-data
    optimize tfo dre lz application File-Transfer
class FTPS
    passthrough application File-Transfer
class ftps
    optimize tfo application File-Transfer
class Filenet
    optimize tfo dre lz application Content-Management
class Gnutella
    passthrough application P2P
class Grouper
    passthrough application P2P

```

```

class openmail
  optimize tfo dre lz application Email-and-Messaging
class HP-OpenView
  passthrough application Systems-Management
class novadigm
  optimize tfo dre lz application Systems-Management
class HTTP
  optimize tfo dre lz application Web accelerate http-express
class HTTPS
  optimize tfo application SSL
class HotLine
  passthrough application P2P
class IBM-DB2
  optimize tfo dre lz application SQL
class netviewdm
  passthrough application Systems-Management
class IBM-TSM
  optimize tfo dre lz application Backup
class objcall
  optimize tfo dre lz application Systems-Management
class IPP
  optimize tfo dre lz application Printing
class proshare
  passthrough application Conferencing
class intersys-cache
  optimize tfo dre lz application SQL
class imap
  optimize tfo dre lz application Email-and-Messaging
class imap3
  optimize tfo dre lz application Email-and-Messaging
class pop3
  optimize tfo dre lz application Email-and-Messaging
class smtp
  optimize tfo dre lz application Email-and-Messaging
class imaps
  optimize tfo application Email-and-Messaging
class pop3s
  optimize tfo application Email-and-Messaging
class smtps
  optimize tfo application Email-and-Messaging
class xmpp-client
  passthrough application Instant-Messaging
class xmpp-server
  passthrough application Instant-Messaging
class Kazaa
  passthrough application P2P
class Kerberos

```

```

    passthrough application Authentication
class kerberos-adm
    passthrough application Authentication
class klogin
    passthrough application Authentication
class kshell
    passthrough application Authentication
class tell
    passthrough application Authentication
class kpasswd
    passthrough application Authentication
class L2TP
    optimize tfo application VPN
class LANDesk
    optimize tfo dre lz application Systems-Management
class LDAP
    optimize tfo dre lz application Directory-Services
class msft-gc
    optimize tfo dre lz application Directory-Services
class msft-gc-ssl
    passthrough application Directory-Services
class ldaps
    passthrough application Directory-Services
class laplink
    optimize tfo dre lz application Remote-Desktop
class pcsync-http
    optimize tfo dre lz application Replication
class pcsync-https
    optimize tfo application Replication
class Laplink-ShareDirect
    passthrough application P2P
class Laplink-surfup-HTTPS
    optimize tfo application Remote-Desktop
class Legato-NetWorker
    optimize tfo application Backup
class Legato-RepliStor
    optimize tfo application Backup
class Liquid-Audio
    optimize tfo dre lz application Streaming
class lotusnote
    optimize tfo dre lz application Email-and-Messaging
class sametime
    passthrough application Instant-Messaging
class MDAemon
    optimize tfo dre lz application Email-and-Messaging
class ms-content-repl-srv
    optimize tfo application Replication

```



```

class epmap
  optimize tfo application Other
class MS-GROOVE
  optimize tfo application Enterprise-Applications
class msmq
  optimize tfo dre lz application Other
class MS-NetMeeting
  passthrough application Conferencing
class ms-streaming
  optimize tfo dre lz application Streaming
class msnp
  passthrough application Instant-Messaging
class ms-olap4
  optimize tfo application SQL
class ms-sql-s
  optimize tfo dre lz application SQL
class ms-wbt-server
  optimize tfo application Remote-Desktop
class MySQL
  optimize tfo dre lz application SQL
class NFS
  optimize tfo dre lz application File-System
class NNTP
  optimize tfo dre lz application Email-and-Messaging
class nntps
  optimize tfo application Email-and-Messaging
class NTP
  passthrough application Other
class Napster
  passthrough application P2P
class netapp-snapmirror
  optimize tfo dre lz application Replication
class NetIQ
  passthrough application Systems-Management
class timbuktu
  optimize tfo application Remote-Desktop
class timbuktu-srv
  optimize tfo application Remote-Desktop
class Netopia-netOctopus
  passthrough application Systems-Management
class groupwise
  optimize tfo dre lz application Email-and-Messaging
class ncp
  optimize tfo dre lz application File-System
class novell-zen
  optimize tfo dre lz application Systems-Management
class talk

```

```

    passthrough application Instant-Messaging
class OpenVPN
    optimize tfo application VPN
class Oracle
    optimize tfo dre lz application SQL
class orasrv
    optimize tfo dre lz application SQL
class Other-Secure
    passthrough application Other
class corba-iiop-ssl
    passthrough application Other
class ircs
    passthrough application Other
class netrjs-3
    optimize tfo application Remote-Desktop
class pcanwheredata
    optimize tfo application Remote-Desktop
class pccmail-srv
    optimize tfo dre lz application Email-and-Messaging
class PDMWorks
    optimize tfo dre lz application CAD
class PPTP
    optimize tfo application VPN
class PSOM-MTLS
    passthrough application Conferencing
class Pervasive-SQL
    optimize tfo dre lz application SQL
class PostgreSQL
    optimize tfo dre lz application SQL
class QMTP
    optimize tfo dre lz application Email-and-Messaging
class Qnext
    passthrough application P2P
class radmin-port
    optimize tfo application Remote-Desktop
class RTSP
    optimize tfo dre lz application Streaming
class Remote-Anything
    optimize tfo application Remote-Desktop
class rrac
    optimize tfo application Replication
class Rsync
    optimize tfo dre lz application Replication
class apple-sasl
    passthrough application Authentication
class sip-tls
    passthrough application Call-Management

```

```

class soap-http
  optimize tfo dre lz application Web
class sqlsrv
  optimize tfo dre lz application SQL
class SSH
  optimize tfo application SSH
class sshell
  passthrough application Console
class xprint-server
  optimize tfo dre lz application Printing
class ssql
  optimize tfo dre lz application SQL
class svrloc
  passthrough application Name-Services
class Siebel
  optimize tfo dre lz application Enterprise-Applications
class sftp
  optimize tfo dre lz application File-Transfer
class SoulSeek
  passthrough application P2P
class sunrpc
  passthrough application File-System
class sybase-sqlany
  optimize tfo dre lz application SQL
class ssc-agent
  optimize tfo dre lz application Other
class TACACS
  passthrough application Authentication
class TFTP
  optimize tfo dre lz application File-Transfer
class TFTPSS
  optimize tfo application File-Transfer
class Telnet
  passthrough application Console
class login
  passthrough application Console
class Telnets
  passthrough application Console
class UniSQL
  optimize tfo dre lz application SQL
class printer
  optimize tfo dre lz application Printing
class print-srv
  optimize tfo dre lz application Printing
class cmd
  passthrough application Console
class exec

```

```

    passthrough application Console
class Veritas-BackupExec
    optimize tfo application Backup
class Veritas-NetBackup
    optimize tfo application Backup
class Vmware-VMConsole
    optimize tfo application Remote-Desktop
class VoIP-Control
    passthrough application Call-Management
class cisco-q931-backhaul
    passthrough application Call-Management
class cisco-sccp
    passthrough application Call-Management
class h323hostcall
    passthrough application Call-Management
class h323hostcallsc
    passthrough application Call-Management
class sip
    passthrough application Call-Management
class VocalTec
    passthrough application Conferencing
class flowmonitor
    optimize tfo lz application Systems-Management
class WASTE
    passthrough application P2P
class WBEM
    passthrough application Systems-Management
class WINS
    passthrough application Name-Services
class nameserver
    passthrough application Name-Services
class netbios
    passthrough application Name-Services
class WinMX
    passthrough application P2P
class iso-tsap
    optimize tfo dre lz application Email-and-Messaging
class x11
    optimize tfo application Remote-Desktop
class Yahoo-Messenger
    passthrough application Instant-Messaging
class eDonkey
    passthrough application P2P
class eTrust-policy-Compliance
    optimize tfo application Systems-Management
class ezMeeting
    passthrough application Conferencing

```

```

class iFCP
  optimize tfo dre lz application Storage
class iscsi
  optimize tfo dre lz application Storage
class isns
  passthrough application Name-Services
class ircu
  passthrough application Instant-Messaging
class SAP
  optimize tfo dre lz application Enterprise-Applications
class VNC
  optimize tfo application Remote-Desktop
class auth
  passthrough application Authentication
class citrixadmin
  optimize tfo dre lz application Remote-Desktop
class citrixima
  optimize tfo dre lz application Remote-Desktop
class mgcp-callagent
  passthrough application Call-Management
class mgcp-gateway
  passthrough application Call-Management
class ms-sql-m
  optimize tfo dre lz application SQL
class sqlexec
  optimize tfo dre lz application SQL
class sql-net
  optimize tfo dre lz application SQL
class sqlserv
  optimize tfo dre lz application SQL
class ccmail
  optimize tfo dre lz application Email-and-Messaging
class waas-default
  optimize tfo dre lz application waas-default
!
!
interface Loopback0
  ip address 10.255.251.204 255.255.255.255
!
interface GigabitEthernet0/0
  ip address 192.168.3.29 255.255.255.252
  waas enable
!
ip http authentication aaa
ip http secure-server

```

# Appendix C: Changes

---

This appendix summarizes the changes Cisco made to this guide since its last edition.

- We updated the Cisco WAAS software to version 5.3.5a.
- We documented the revised requirement for AppNav-XE controller groups to include only identical router models.
- We updated the EIGRP named mode configuration.
- We Updated the configuration procedures for the Cisco UCS E-Series module using the latest version of the Cisco Integrated Management Controller (CIMC) and included additional steps for the Cisco ISR 4451-X router.

## Feedback

Please use the [feedback form](#) to send comments and suggestions about this guide.



**Americas Headquarters**  
Cisco Systems, Inc.  
San Jose, CA

**Asia Pacific Headquarters**  
Cisco Systems (USA) Pte. Ltd.  
Singapore

**Europe Headquarters**  
Cisco Systems International BV Amsterdam,  
The Netherlands

Cisco has more than 200 offices worldwide. Addresses, phone numbers, and fax numbers are listed on the Cisco Website at [www.cisco.com/go/offices](http://www.cisco.com/go/offices).

ALL DESIGNS, SPECIFICATIONS, STATEMENTS, INFORMATION, AND RECOMMENDATIONS (COLLECTIVELY, "DESIGNS") IN THIS MANUAL ARE PRESENTED "AS IS," WITH ALL FAULTS. CISCO AND ITS SUPPLIERS DISCLAIM ALL WARRANTIES, INCLUDING, WITHOUT LIMITATION, THE WARRANTY OF MERCHANTABILITY, FITNESS FOR A PARTICULAR PURPOSE AND NONINFRINGEMENT OR ARISING FROM A COURSE OF DEALING, USAGE, OR TRADE PRACTICE. IN NO EVENT SHALL CISCO OR ITS SUPPLIERS BE LIABLE FOR ANY INDIRECT, SPECIAL, CONSEQUENTIAL, OR INCIDENTAL DAMAGES, INCLUDING, WITHOUT LIMITATION, LOST PROFITS OR LOSS OR DAMAGE TO DATA ARISING OUT OF THE USE OR INABILITY TO USE THE DESIGNS, EVEN IF CISCO OR ITS SUPPLIERS HAVE BEEN ADVISED OF THE POSSIBILITY OF SUCH DAMAGES. THE DESIGNS ARE SUBJECT TO CHANGE WITHOUT NOTICE. USERS ARE SOLELY RESPONSIBLE FOR THEIR APPLICATION OF THE DESIGNS. THE DESIGNS DO NOT CONSTITUTE THE TECHNICAL OR OTHER PROFESSIONAL ADVICE OF CISCO, ITS SUPPLIERS OR PARTNERS. USERS SHOULD CONSULT THEIR OWN TECHNICAL ADVISORS BEFORE IMPLEMENTING THE DESIGNS. RESULTS MAY VARY DEPENDING ON FACTORS NOT TESTED BY CISCO.

Any Internet Protocol (IP) addresses used in this document are not intended to be actual addresses. Any examples, command display output, and figures included in the document are shown for illustrative purposes only. Any use of actual IP addresses in illustrative content is unintentional and coincidental.

© 2014 Cisco Systems, Inc. All rights reserved.

Cisco and the Cisco logo are trademarks or registered trademarks of Cisco and/or its affiliates in the U.S. and other countries. To view a list of Cisco trademarks, go to this URL: [www.cisco.com/go/trademarks](http://www.cisco.com/go/trademarks). Third-party trademarks mentioned are the property of their respective owners. The use of the word partner does not imply a partnership relationship between Cisco and any other company. (1110R)