

# *Applications of Nanotechnology in Soft Materials*

Fiona Case  
fiona@casescientific.com

## Applications of Nanotechnology in Soft Materials

- Introduction to soft nanotechnology
  - Definitions
  - Why do some materials have nanoscale structure?
- Surfactant examples
- Polymer and protein examples
- Emulsions (and colloids)

## Soft nanotechnology

- *Hard* matter versus *Soft* Matter: scales of time
- Hard: rocks, metals,...
- Soft: soil, gels, living tissue, .....
- Soft materials are often soft because they do not have long-range molecular scale order
- They can often be induced to flow because the energy barriers to movement are accessible.

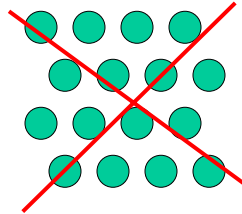

## Energy scales

- Hard materials: intermolecular interaction  $\gg kT$
- Soft materials: intermolecular interaction  $\sim kT$
- We can assemble and dis-assemble many soft nanostructured materials at room temperature without large input of energy because the structural changes require an amount of energy of a few  $kT$ .

# Soft nanotechnology

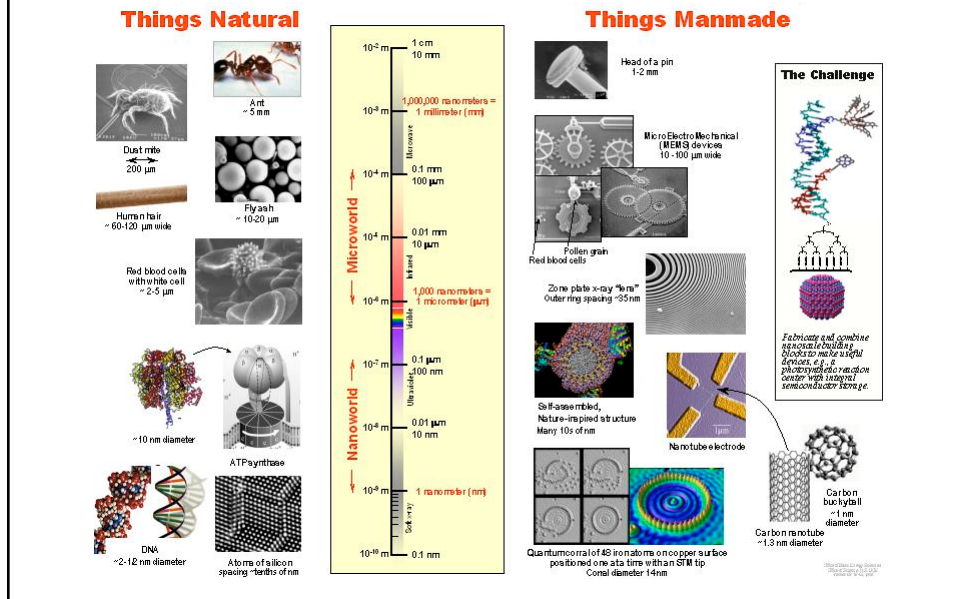

# Soft nanotechnology

- Nanotechnology is the **understanding** and **control** of matter at dimensions of roughly 1 to 100 nanometers, where unique phenomena enable **novel applications**.
- At this level, the physical, chemical, and biological properties of materials differ in fundamental and valuable ways from the properties of individual atoms and molecules or bulk matter.

Nanotechnology definition from [www.nano.gov](http://www.nano.gov)

## Nanoscale structure changes properties

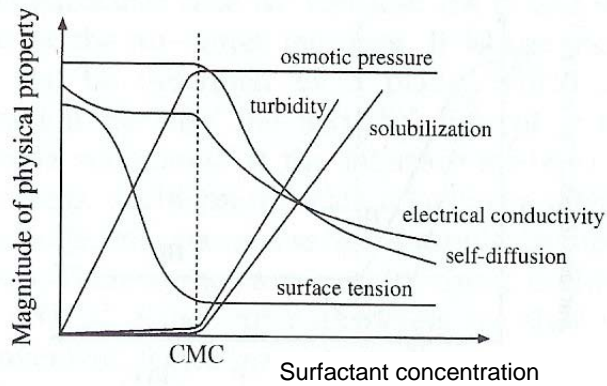

CMC - the critical micelle concentration.  
The concentration above which nanostructure forms

## Soft nanotechnology

- Complex fluids, nanostructured fluids, soft matter .....
  - Contain nanoscale structures
  - (Usually) Formed by the self-assembly of molecules
  - For example, **surfactants** or block copolymers

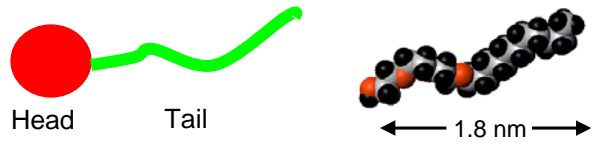
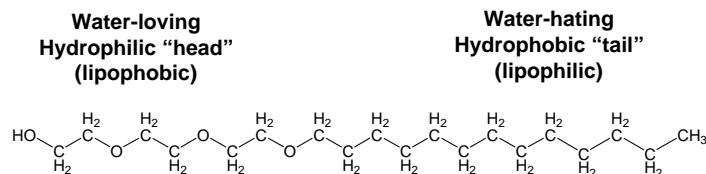

## Soft nanotechnology

- Self assembly of surfactants to form nanoscale structures

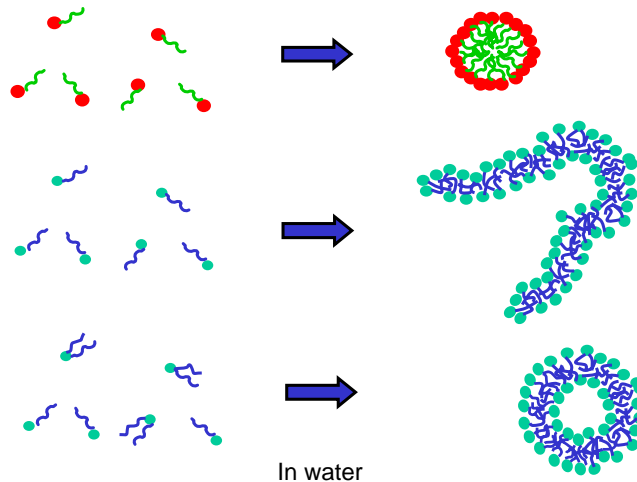

## The first surfactants?

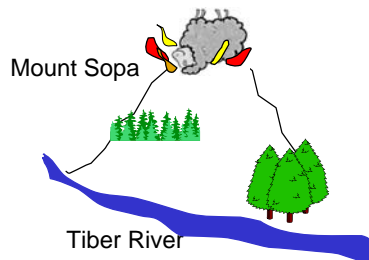

- The first known written mention of soap was on Sumerian clay tablets 2500 B.C.
- (legend) Ancient Romans discovered the mixture of fat and charcoal which ended up in the Tiber river was good for cleaning clothes

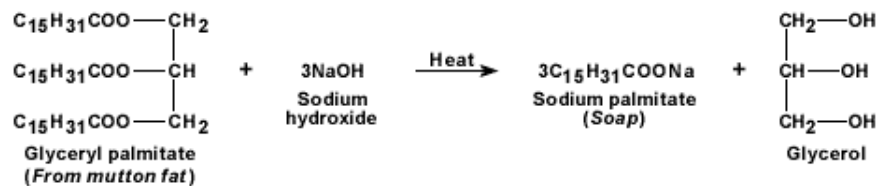

# Surfactants

- The ancient Romans were making use of surfactants!

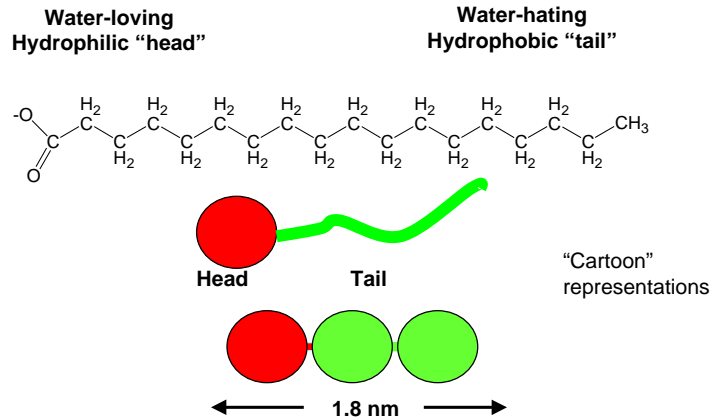

- Were they doing nanotechnology?

# Soft nanotechnology



- Soft nanostructured materials have been part of our lives for many years
- But now we are starting to learn how to control this soft nanoscale structure and to design materials with specific properties

This is soft nanotechnology

"The design and application of soft materials with nanoscale structure to create new materials and devices with novel and valuable properties"



## The driving forces for structure formation

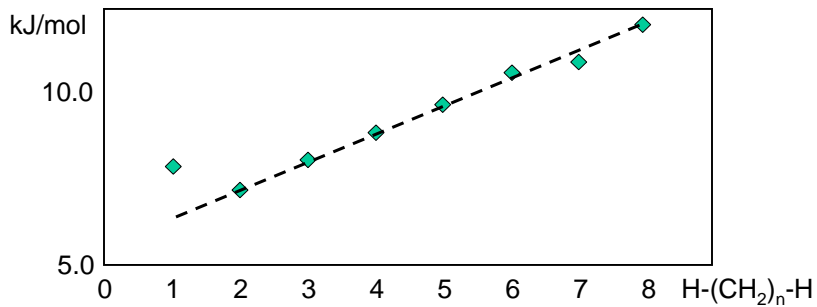

- Hydrophobic interactions
- The energy penalty for alkanes (surfactant tails) in water
- Transfer free energy (the benefit of removing the tails from water) is about 0.7 kJ/mol per methylene group
- Remember:  $kT = 2.5$  kJ at 300K

## The driving forces for structure formation

- But the surfactant head groups are hydrophilic - they want to stay in the water
- Result = nanoscale structures

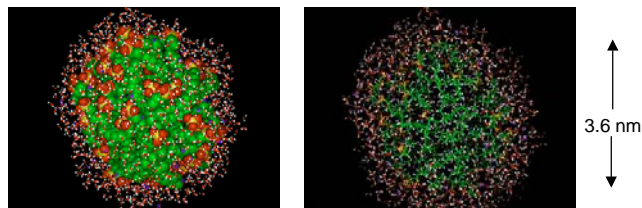

Predicted structure for a micelle of SDS

Carbon = green, sodium = purple  
Oxygen = red, sulfur = yellow

## Self-Assembly Movie

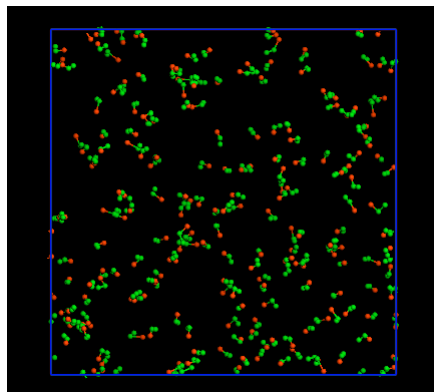

Prediction of surfactant behavior using dissipative particle dynamics

## Why do different surfactants create different nanostructure?

- Empirical Rules

$$k = \frac{v_0}{a_0 l_c}$$

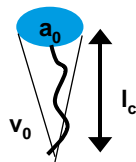

$k < 1/3$



Cone



Spheres

$1/3 < k < 1/2$



Truncated Cone

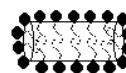

Rods

$k > 1/2$



Cylinder

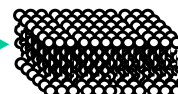

Bilayers

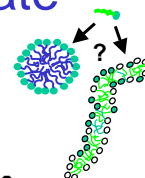



# Dish liquid



- Sodium Lauryl Sulfate (SLS)

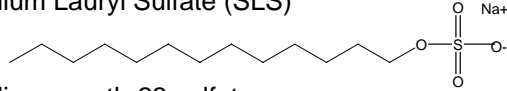

- Sodium pareth-23 sulfate

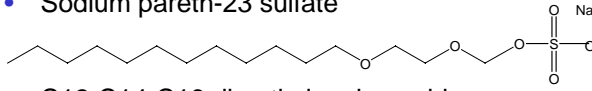

- C12-C14-C16 dimethyl amine oxide

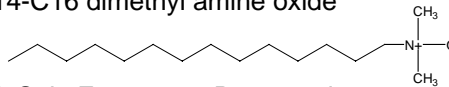

- Alcohol, Salt, Fragrance, Preservative

- High surfactant concentration
- Relatively low viscosity
- Excellent grease cutting

# Ionic surfactants in Water

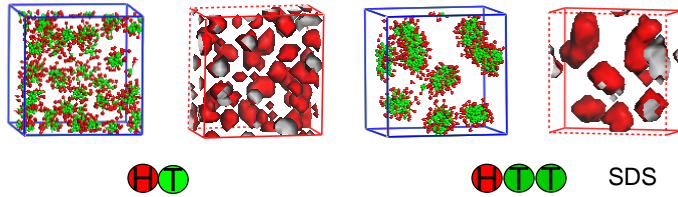

- Prediction of aggregation/self assembly for surfactants with strongly repulsive head groups
- A longer tailed surfactant forms larger micelles

Predictions using computer modeling: Broze, G. and Case, F. H., Chapter 24 in "Mesoscale Phenomena in Fluid Systems" ACS Symposium Series #861 (2003)

## Liquid Hand Soap



- Sodium Laureth Sulfate (SLS)

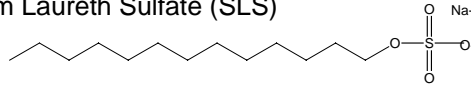

- Cocamidopropyl betaine

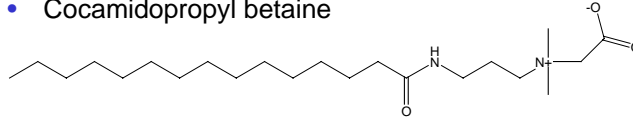

- Decyl glucoside

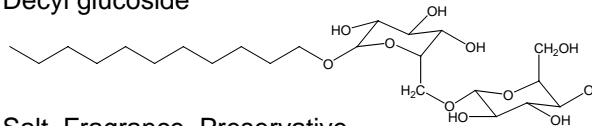

- Salt, Fragrance, Preservative

- Low surfactant concentration
- Higher viscosity
- Gentle on the skin

## Foaming

- Foam is a coarse dispersion of a gas in a liquid
- Foam is stabilized by the nanoscale structure in the liquid films between the gas bubbles
- Several (often independent) properties are important:
  - The amount of foam (for example initial foam height) for a given formula
  - The stability of the foam
  - Foam texture and feel

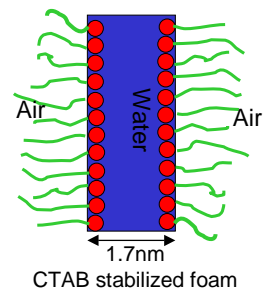
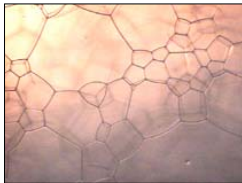

## Viscosity

- Viscosity may be built using long rod-like micelles (which entangle)
- This provides a thick product (quality feel), even with low surfactant concentration

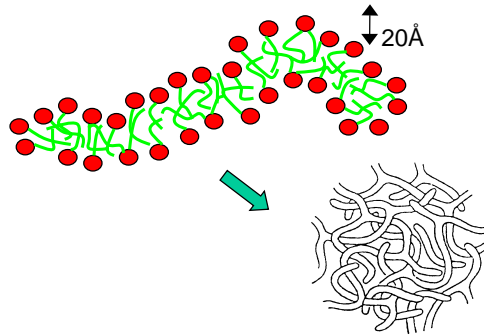

## Rheology in personal care products

- Soft materials with nanoscale structure formed by self-assembly can shear-thin
- When the material is sheared (as it is squeezed out of a bottle or rubbed on the skin) the nanoscale structure is changed and the viscosity of the material reduced

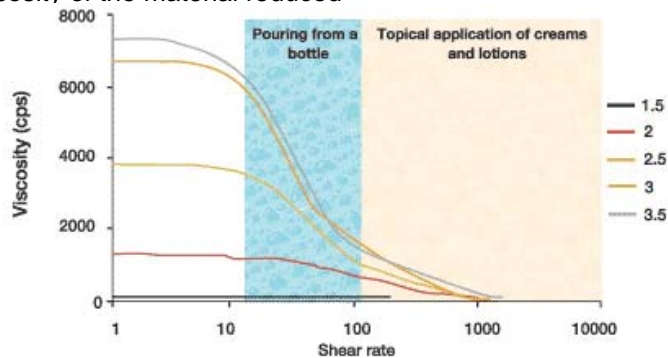

Results from Uniqema, Euro Cosmetics 26.05.2003 (eurocosmetics-magazine.com)

## Shear-thinning

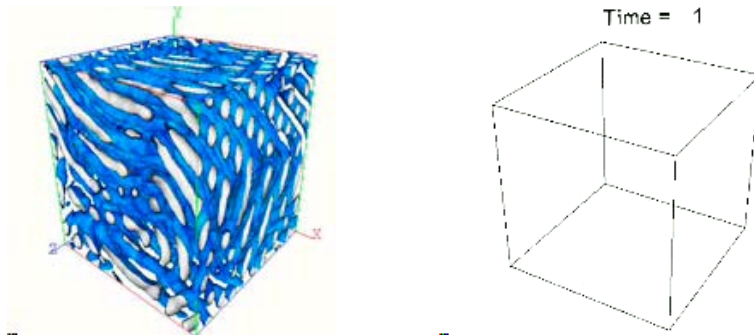

PEO-PPO block copolymer gel,  
Pluronic 64 60%

Predictions using dynamic density functional theory

## Shear thinning of rod forming nanostructures

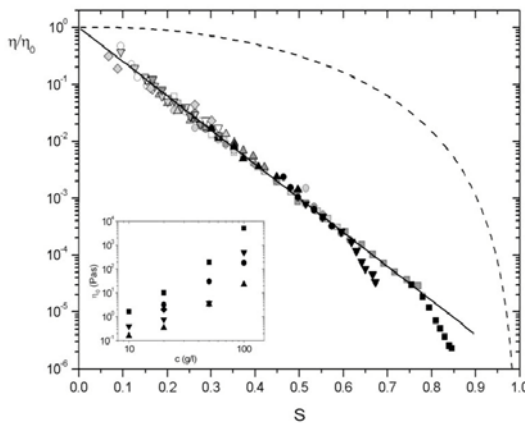

- Dimensionless viscosity  $\eta/\eta_0$  as a function of the orientational order parameter  $S$
- Results for a range of materials and concentrations can be plotted on one curve
- This suggests that it is the nanoscale structure that is determining the viscosity, rather than the molecular scale structure

"Shear Thinning and Orientational Ordering of Wormlike Micelles"  
S. Förster, M. Konrad, and P. Lindner, PRL 94, 017803 (2005)

## Surfactants with two tails

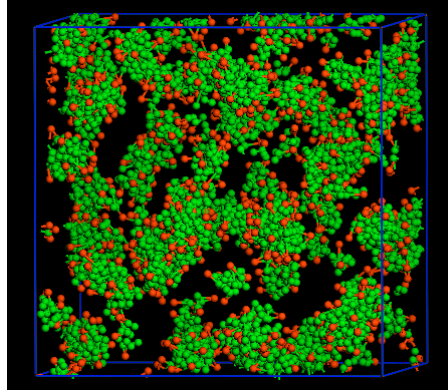

## Two tails

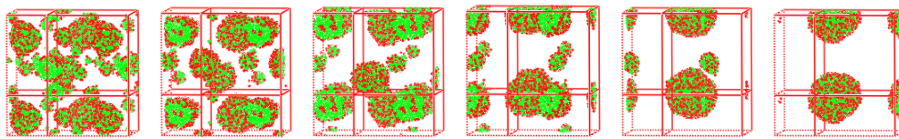

Uni-layer vesicles aggregate to form a multi-layer structure

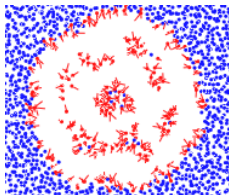

- Cross-section of the final vesicle structure
- Multi-layer vesicles are used for fragrance delivery

## Single layer vesicles, liposomes

- Hollow sphere of surfactants
- Used to transport water soluble materials
- Applications include cosmetics and drug delivery

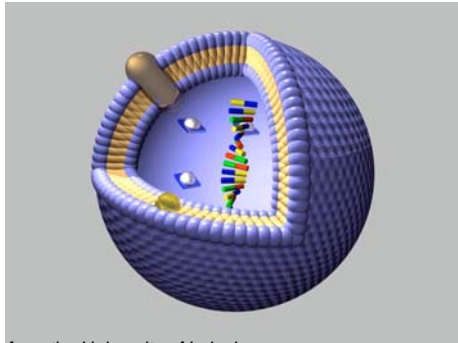

A symbolic representation of a self-organized lipid vesicle containing water-soluble substances (DNA fragments and the anti-cancer drug Carboplatin) and hydrophobic components like membrane proteins.

Image from the University of Leipzig.  
<http://www.uni-leipzig.de/~sfb294/Symposium2002/symposium2002.htm>

## Cell Wall

- Phospholipids are key structural components of biological membranes
- The animal and bacteria cell walls (and enveloped viruses)

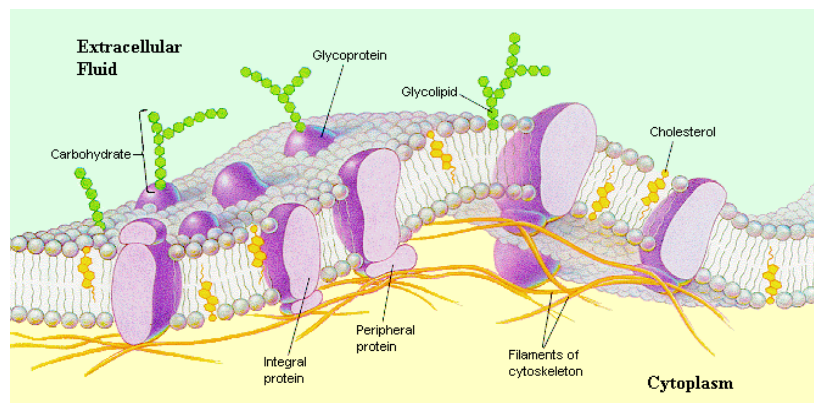

## Polymers and copolymers

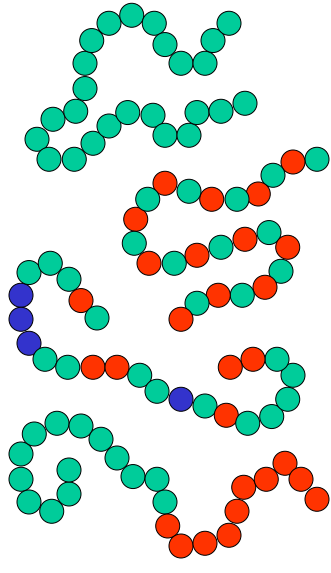

- Homopolymer
- Alternating copolymer
- Random copolymer
- Di-block copolymer
- Tri-block copolymer
- Copolymers can self-assemble to form nanoscale structures

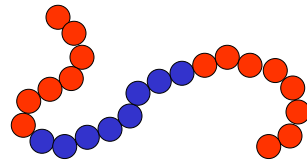

## Soft nanotechnology

- Block copolymer melts self assemble to form nanoscale structure
  - For example a block copolymer of polystyrene and poly(methyl methacrylate) - equal sized blocks

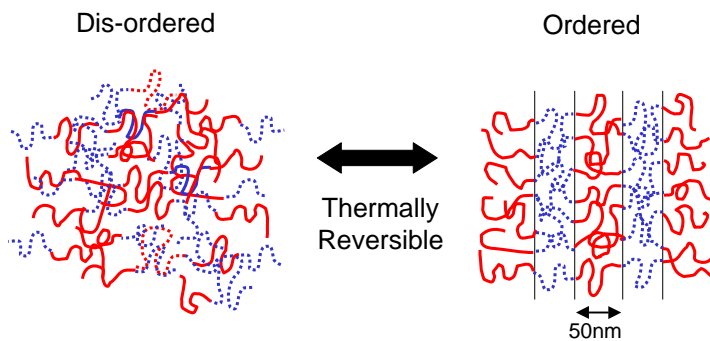

## Di-block copolymer melts

- The structure that is formed depends on the relative length of the two blocks and how compatible they are

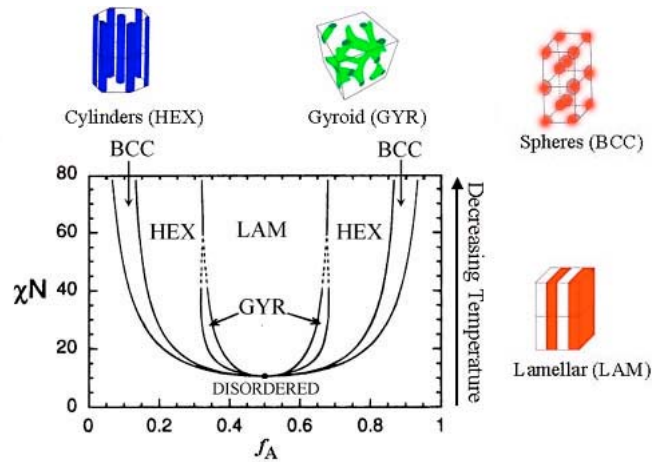

## Nanoscale structure formation

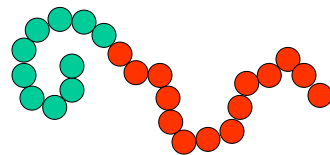
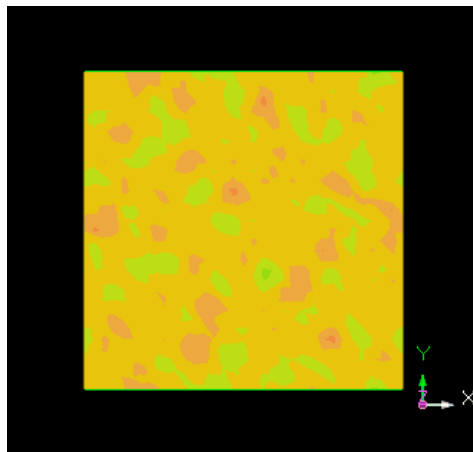

A block copolymer with uneven block lengths can form spheres or rods (cylinders)



# Nano Patterning using Block Copolymers

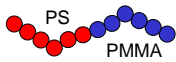
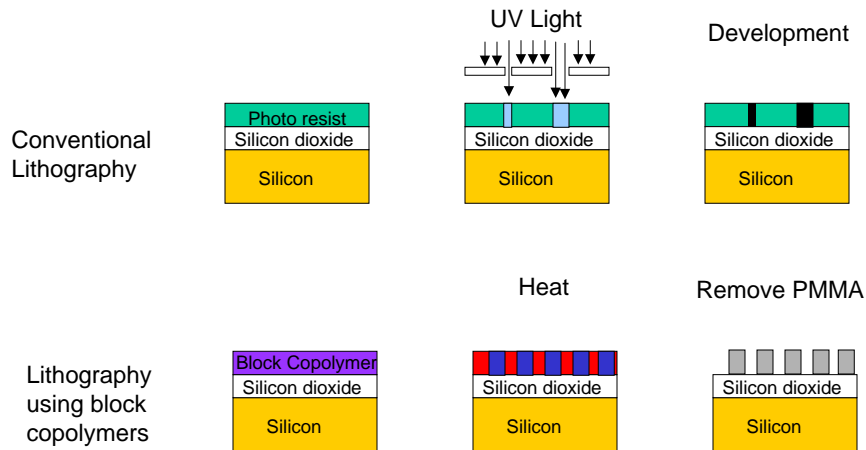

Black and Guarini, IBM Research. Tom Russell U. Mass.

# Creating nanodots

poly(styrene-b-ferrocenylsilane)  
block copolymer

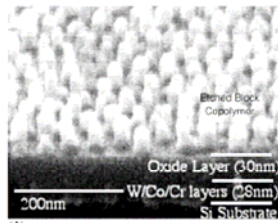

Structure applicable to hard drive manufacture

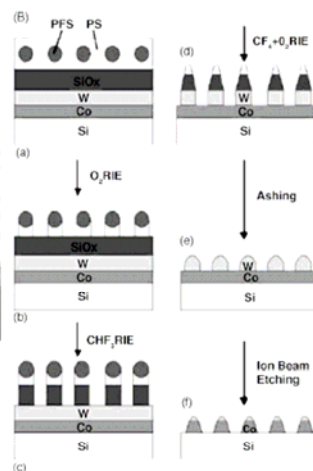

J.Y. Cheng, C.A. Ross, V.Z.H. Chan, E.L. Thomas, R.G.H. Lammertink, G.J. Vancso, *Adv. Mater.* 13, 1174–1178 (2001)

## Directing the structure formation

Thin film of cylinder-forming PS-b-PI on a 35 nm deep grating

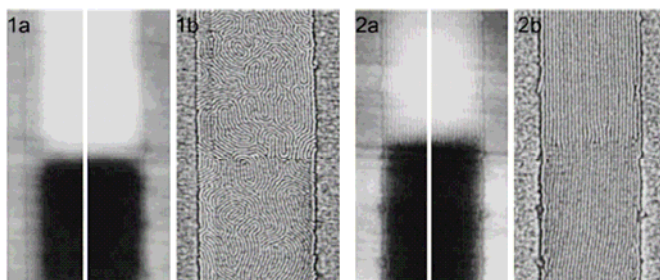

After annealing for 2 hours    After annealing for 20 hours

D. Sundrani, S.B. Darling, S.J. Sibener, Langmuir 20, 5091–5099 (2004)

## Structured surfaces from polyelectrolytes

- Weak polyelectrolytes can be coated layer by layer on a surface

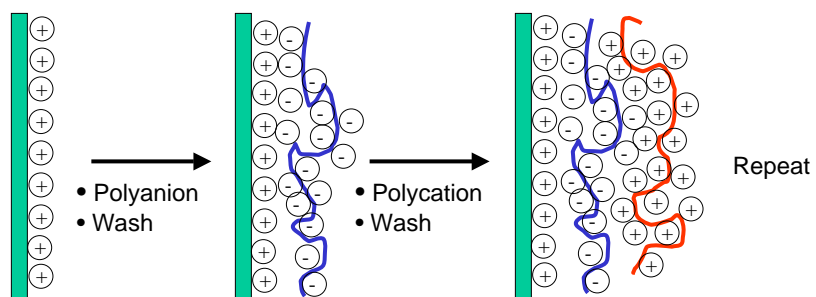

[www.chem.fsu.edu/multilayers](http://www.chem.fsu.edu/multilayers)

## Polyelectrolyte multi-layers

- The process can be repeated many times creating a multilayer
- Multilayers created from poly(acrylic acid), PAA, and poly(allylamine hydrochloride), PAH will phase separate when the pH is dropped to 2.4
- Their phase separation is kinetically frustrated and they form nanoporous heterostructures

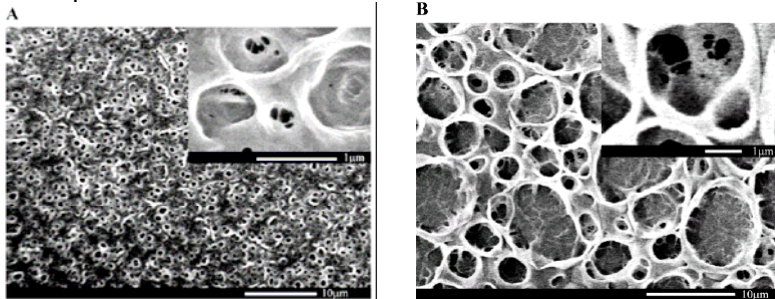

After one acid treatment

[Nano Letters, 4\(7\), 1349-1353 \(2004\)](#)

## Structured surfaces

- These nanostructured surfaces can be transformed into stable, durable, superhydrophobic surfaces
  - The microphase separated surface is crosslinked
  - SiO<sub>2</sub> nanoparticles are deposited on the surface (creating a templated SiO<sub>2</sub> layer with nano/micro phase structure)
  - Semifluorinated silane is deposited using CVD

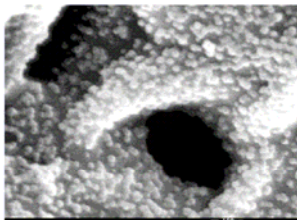

SEM image of the fully treated structure with silica nanoparticles.

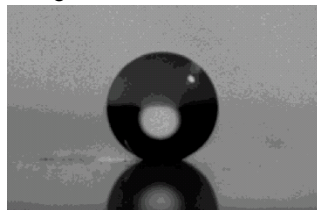

Water droplet on the superhydrophobic surface.

[Nano Letters, 4\(7\), 1349-1353 \(2004\)](#)

## Microphase separated systems

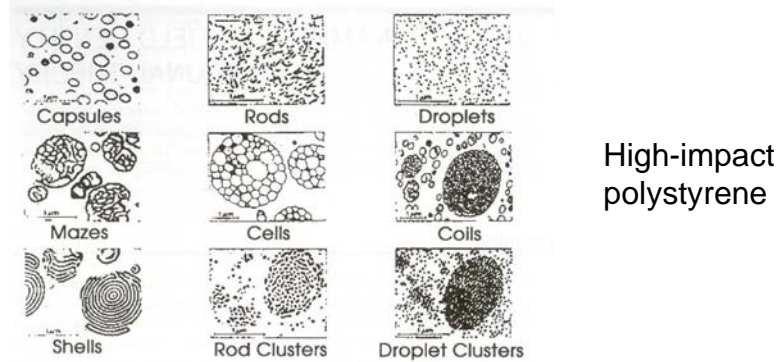

mix of polybutadiene, polystyrene and compatibilizer.  
The structure depends on the choice of compatibilizer  
and the processing conditions (these structures are also  
kinetically trapped)

World-wide production > 1 Mton/year!

## Block copolymer structures

- In solution block copolymers can form micelles, lamella and vesicles in the same way as surfactants

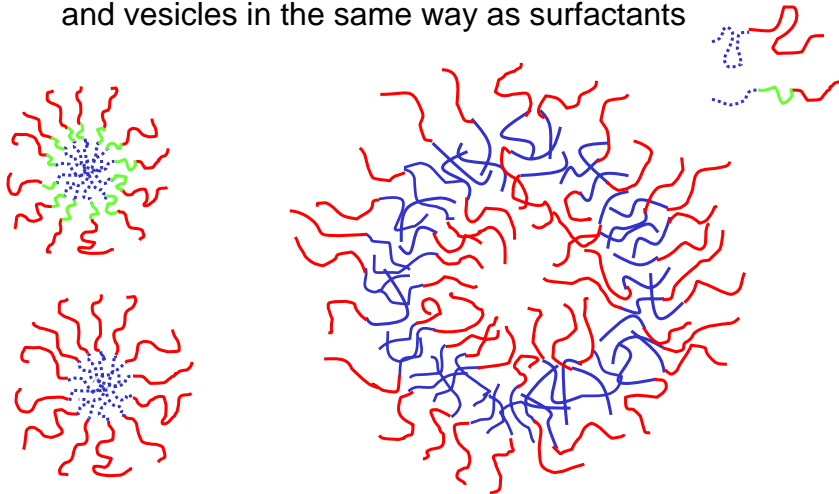

## PEO-PPO-PEO triblock

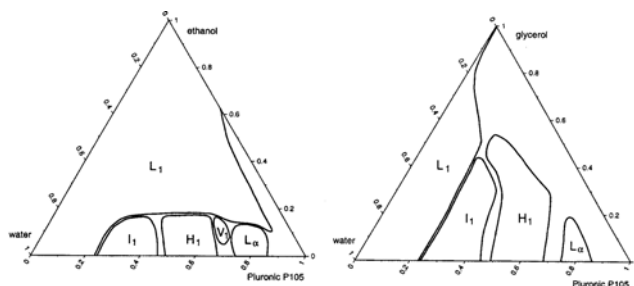

lyotropic liquid crystalline microstructures

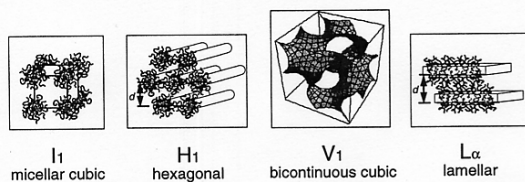

I<sub>1</sub>  
micellar cubic

H<sub>1</sub>  
hexagonal

V<sub>1</sub>  
bicontinuous cubic

L<sub>α</sub>  
lamellar

Experimental phase diagram: Alexandridis

MW PPO = 3000  
50% PEO

## Polymersomes: Tough Vesicles Made from Diblock Copolymers

Science, Vol 284, Issue 5417, 1143-1146, 14 May 1999

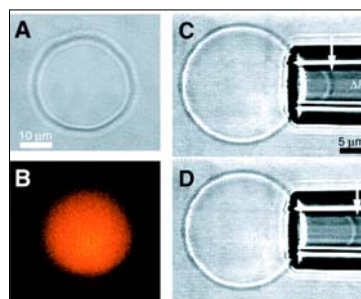
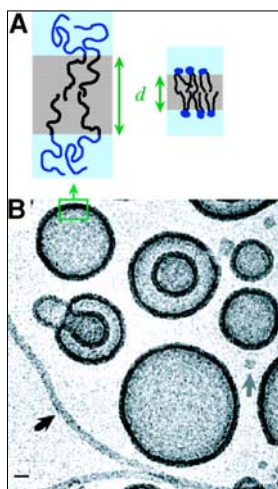

## Polymer chimeras

- In principle block copolymers in a mixed copolymer system can phase separate creating nanostructures that are far more complex than the spheres, rods and vesicles formed by low molecular weight surfactants

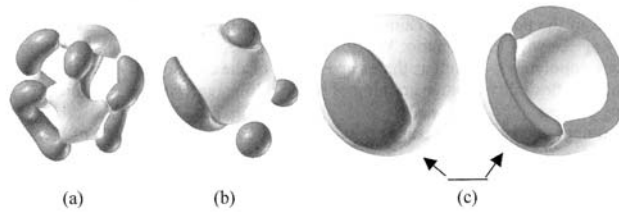

- Predicted structures for two-component polymersome chimeras
- The two copolymers (one shown black, the other white) are A13H7 and B13H17 where the A and B materials are incompatible

## Self-assembly: Proteins Design of Amphiphilic $\alpha$ -Helices

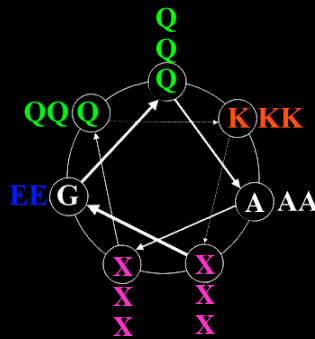

-XGQAXQKXEQAXQKXEQAXQK-amide

Martin Case, University of Vermont

## Self-assembled structure



- Protein of ~60 amino acids
- > 80% helical by CD
- Cold denaturation suggests  $\Delta S$  dominates assembly
- Cooperative unfolding ( $\Delta G_u \sim 3 \text{ kcalM}^{-1}$ )
- Reversible structural change (folds and unfolds, and folds again)
- Backbone structure determined by NMR

NMR structure: Gochin, M.; Khorosheva, V.; Case, M. A. *J ACS* **2002**

## Antimicrobial peptides

- Living organisms of all types including plants and humans have been shown to produce a large repertoire of gene-encoded antimicrobial peptides that serve as part of their innate immunity to microbial invasion.

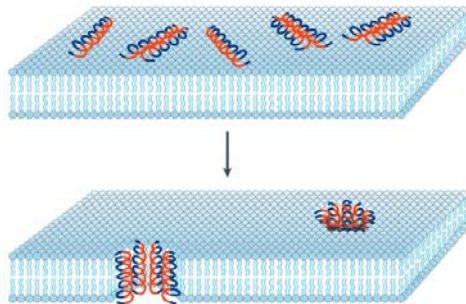

The barrel-stave model of antimicrobial-peptide-induced killing.

In this model, the attached peptides aggregate and insert into the membrane bilayer so that the hydrophobic peptide regions align with the lipid core region and the hydrophilic peptide regions form the interior region of the pore.

A wonderful example of self-assembly

Nature Reviews | Microbiology

Antimicrobial peptides: Pore formers or metabolic inhibitors in bacteria? Brogden  
KA Nature Reviews Microbiology 3 (3): 238-250 MAR 2005

## Foam stability

- Surface active materials that form stable nanostructures at the water/air interface strengthen the film and prevent rupture
- Beer is stabilized by Lipid Transfer Protein 1 (LTP1), a 10 kDa protein of barley origin
- The transformation of barley LTP1 into the more foam-promoting form takes place during wort boiling and involves an unfolding of the three-dimensional structure



## Applications of Nanotechnology in Soft Materials

- Introduction to soft nanotechnology
  - Definitions
  - Why do some materials have nanoscale structure?
- Surfactant examples
- Polymer and protein examples
- Emulsions (and colloids)



## Forming a simple emulsion

- If you vigorously mix oil and water, or any other two immiscible fluids, you will create an emulsion (for example vinaigrette)
- Relatively large oil droplets, no stabilizing surfactant or block copolymer
- Thermodynamically unstable
  - coalescence (droplets merge)
  - Ostwald ripening (large droplets grow at the expense of the small ones)

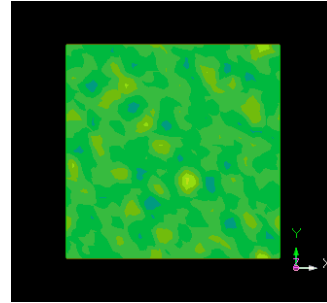

## Stabilizing an emulsion

- If the droplets are stabilized and prevented from further phase separation this creates an emulsion
- Emulsion stability can be increased by:
  - adding “surfactants” (stabilizes the oil/water interface)
  - adding polymer (increases viscosity - reduces coalescence)
  - decreasing the solubility of the droplet material in the matrix material (reduces Ostwald ripening)

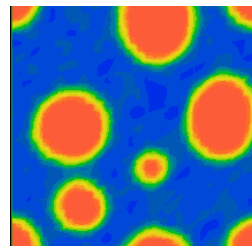

Salad dressing - a stabilized oil/water emulsion



# Water-in-oil emulsion

INGREDIENTS: LIQUID VEGETABLE OIL (SOYBEAN, OLIVE), WATER, SWEET CREAM BUTTERMILK, PARTIALLY HYDROGENATED SOYBEAN OIL, SALT, VEGETABLE MONO AND DIGLYCERIDES AND SOY LECITHIN (EMULSIFIERS), POTASSIUM SORBATE AND SODIUM BENZOATE AND CALCIUM DISODIUM EDTA (TO PRESERVE FRESHNESS), PHOSPHORIC ACID (ACIDULANT), ARTIFICIAL FLAVOR, VITAMIN A PALMITATE, COLORED WITH BETA CAROTENE (SOURCE OF VITAMIN A).  
 CONTAINS: MILK  
 DISTRIBUTED BY:  
**ConAgra Foods**  
 DOWNERS GROVE, IL 60515  
 SATISFACTION GUARANTEED 81243a  
 Questions or comments? Write to us at: ConAgra Foods, P.O. Box 3768, Dept. FLM, Omaha, NE 68103-0768 or call 1-800-988-7808 weekdays 10 am to 7 pm CST. www.fleischmanns.com  
**MUST BE REFRIGERATED**

Example: Margarine

- Milk proteins are surface active (milk is an emulsion)
- Mono and diglycerides are surfactants
- Large tails & small heads

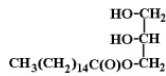

**Mono-glyceride**

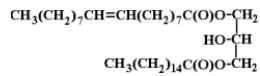

**Di-glyceride**

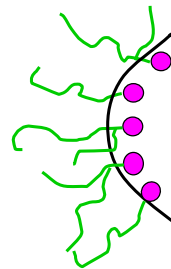

Cryo TEM - 12% wt.  $\text{C}_{12}\text{E}_5$  surfactant and equal volume ratio of water and n-octane at 28 °C.

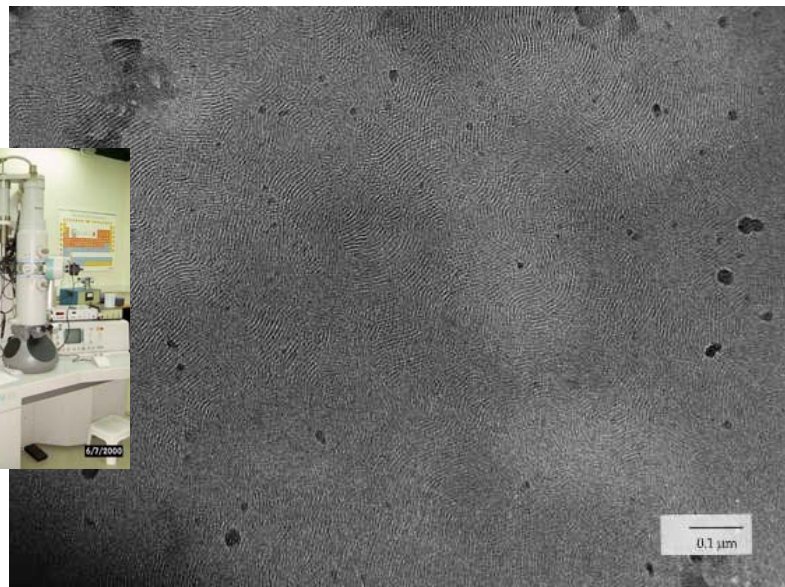

Yeshayahu Talmon - Technion-Israel Institute of Technology

## Mixing kinetics

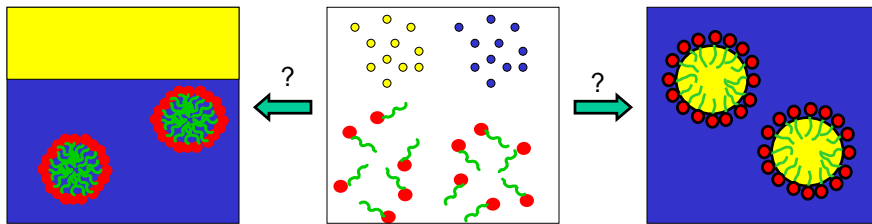

- Starting with a homogeneous mixture of oil, water, and surfactant (if this was possible) would we obtain an emulsion, or surfactant micelles and a separate layer of oil?
- This depends on the rate of oil droplet coalescence or nucleation and growth, and the rate of emulsion formation.

## How to transport and handle bitumen?

- One challenge with utilizing heavy hydrocarbons is that of transportation and handling
- These high viscosity materials cannot be pumped or flow through pipes unless they are heated (expensive!)
- A successful solution developed by INTERVEP, Venezuela, is to create a bitumen emulsion

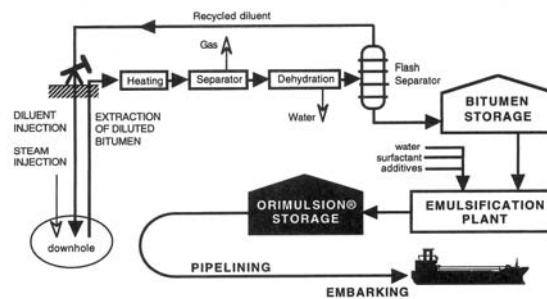

Flow chart of Orimulsion® production.

## Designing a bitumen emulsion

- The emulsification is carried out in two stages
- First the heavy crude is emulsified with an ethoxylated nonylphenol (17.5 EO groups) to create a 85% O/W emulsion. Low energy mixing is used to avoid inversion to a W/O emulsion
- Dilution to 70% oil content is carried out by adding water containing magnesium nitrate
- This two stage process allows gentler mixing conditions to be used
- The residence time in the mixer is carefully monitored - it must be long enough to attain the desired droplet size - but not too long because of the danger of phase inversion
- Phase inversion almost instantly produces an extremely viscous W/O emulsion. Rapid action is required to protect the gearbox!

Jean-Louis Salager, Maria Isabel Briceño and Carlo Bracho, Chapter 20, "Encyclopedic Handbook of Emulsion Technology" Edited by Johan Sjöblom, Marcel Dekker, 2001

## Designing self assembled soft nanostructure

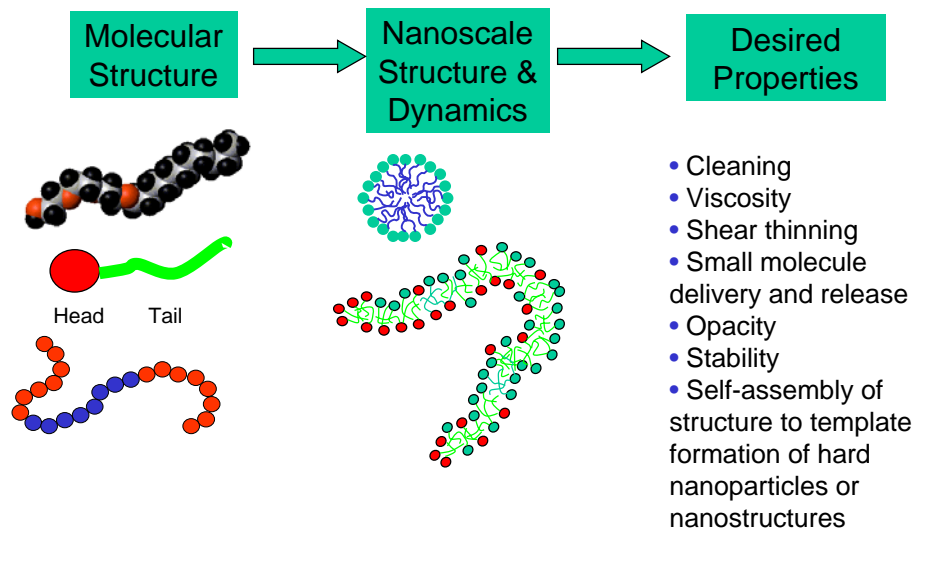

## More about soft nanotechnology:



- NSTI Nano Industrial Impact Workshop on "Soft Nanotechnology and Self-Assembly: Industrial Applications"
- Symposium on "Soft Nanotechnology, Nanostructured Fluids and Self Assembly"
- Symposium on "Polymer Nanotechnology"

Fiona Case: [www.casescientific.com](http://www.casescientific.com)