











**Novus**
HYBRIDS



TABLE OF CONTENTS

Plug	Approvals	Page
 CHINA	----- CCC	3
 EUROPE	----- VDE	5
 GULF COUNTRIES	----- GCC	7
 INDONESIA	----- SNI	11
 JAPAN	----- PSE	13
 KOREA	----- KC	14
 N.AMERICA	----- UL/c-UL	16
 RUSSIA	----- EAC	17
 SINGAPORE	----- CPS	19
 UNITED KINGDOM	----- ASTA	23

Connector		

IEC Std. C7	-----	27
IEC Std. C13	-----	28

Generic Cordsets		

Chinese Powercord Set 1.8M Black	----- CCC	30
British Powercord Set 1.8M Black	----- ASTA,CPS,GCC	33
European Powercord Set 1.8M Black	----- VDE,EAC,KC	36
North American Powercord Set 1.8M Black	----- UL/c-UL	40
North American Hospital-Grade Powercord Set 1.8M Grey	----- UL/c-UL	41
Australian Powercord Set 1.8M Black	----- SAA	42
Indian Powercord Set 1.8M Black	----- BIS	44
Japanese Powercord Set 1.8M Black	----- PSE	46
South African Powercord Set 1.8M Black	----- SABS	48
Switzerland Powercord Set 1.8M Black	----- SEV	49
Jumper Cordset 1.8M Black	----- ENEC	51
Generic Powercord Set Configurator	-----	52



CHINA

Cat. No: VNBGB10S2

Description: Straight Plug for Class II Appliance

Standards: GB2099.1 / GB1002

Max. Rating: 10A, 250V

Safety Approval: CCC



Cable Type	Size (mm ²)	Matching Connector	Rated Current
60227 IEC 52 (RVV) 300/300 (Flat)	2x0.50	VNBC7S*	2.5A
60227 IEC 52 (RVV) 300/300 (Flat)	2x0.75	VNBC7S	6A
60227 IEC 52 (RVV) 300/300 (Round)	2x0.75		6A
60227 IEC 53 (RVV) 300/500 (Flat)	2x0.75	VNBC7S	6A
60227 IEC 53 (RVV) 300/500 (Round)	2x0.75		6A
60227 IEC 53 (RVV) 300/500 (Round)	2x1.00		10A

Remarks

* Cable length limit to 2 meters.

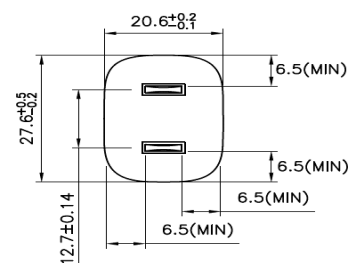
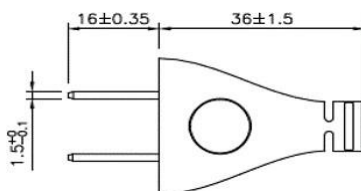
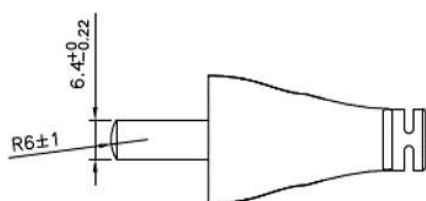



CHINA

Cat. No: VNBGB10S3

Description: Straight Plug for Class I Appliance

Standards: GB2099.1 / GB1002

Max. Rating: 10A, 250V

Safety Approval: CCC



Cable Type	Size (mm ²)	Matching Connector	Rated Current
60227 IEC 52 (RVV) 300/300 (Round)	3x0.75		6A
60227 IEC 53 (RVV) 300/500 (Round)	3x0.75	VNBC13S*	6A
60245 IEC 89 (RQB) 300/300	3x0.75		6A
60227 IEC 53 (RVV) 300/500 (Round)	3x1.00	VNBC13S	10A
60245 IEC 53 (YZ) 300/500	3x1.00		10A
60245 IEC 89 (RQB) 300/300	3x1.00		10A

Remarks

* Cable length limit to 2 meters.

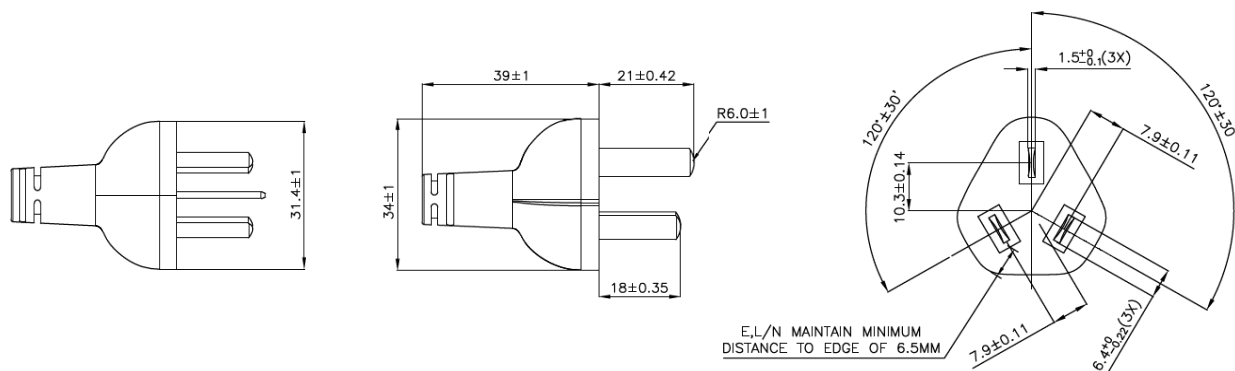



EUROPE

Cat. No: VNBEU16S3

Description: Straight Plug with Dual-earthing contacts
for Class I Equipment

Standards: IEC 60884-1
(CEE 7 Standard Sheet VII)

Max. Rating: 16A, 250V

Safety Approval: VDE



Cable Type	Size (mm ²)	Matching Connector	Combo Approvals
60227 KS IEC 52 (H03VV-F)	3 x 0.75		EAC/KC
60227 KS IEC 53 (H05VV-F)	3 x 0.75	VNBC13S*	EAC/KC
H03RT-H	3 x 0.75		EAC
H05RN-F	3 x 0.75		EAC
H05RR-F	3 x 0.75		EAC
60227 KS IEC 53 (H05VV-F)	3 x 1.00	VNBC13S	EAC/KC
60245 KS IEC 53 (H05RR-F)	3 x 1.00		EAC/KC
H05V2V2-F	3 x 1.00		EAC
H05RN-F	3 x 1.00		EAC
H03RT-H	3 x 1.00		EAC
H05RN-F	3 x 1.00		EAC
60227 KS IEC 53 (H05VV-F)	3 x 1.50	VNBC13S	EAC/KC

Remarks

* Cable length limit to 2 meters.

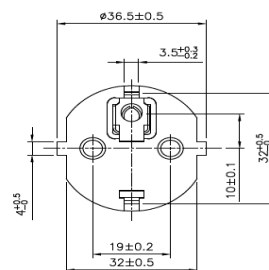
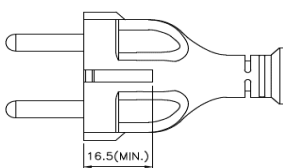
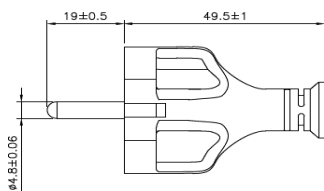



EUROPE

Cat. No: VNBEU16A3

Description: Angled Plug with Dual-earthing contacts for Class I Equipment

Standards: IEC 60884-1
(CEE 7 Standard Sheet VII)

Max. Rating: 16A, 250V

Safety Approval: VDE

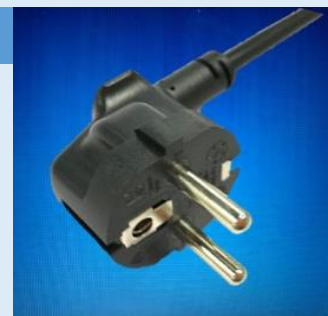

Cable Type	Size (mm ²)	Matching Connector	Combo Approvals
60227 KS IEC 52 (H03VV-F)	3 x 0.75		EAC/KC
60227 KS IEC 53 (H05VV-F)	3 x 0.75	VNBC13S*	EAC/KC
H03RT-H	3 x 0.75		EAC
H05RN-F	3 x 0.75		EAC
H05RR-F	3 x 0.75		EAC
60227 KS IEC 53 (H05VV-F)	3 x 1.00	VNBC13S	EAC/KC
60245 KS IEC 53 (H05RR-F)	3 x 1.00		EAC/KC
H05V2V2-F	3 x 1.00		EAC
H05RN-F	3 x 1.00		EAC
H03RT-H	3 x 1.00		EAC
H05RN-F	3 x 1.00		EAC
60227 KS IEC 53 (H05VV-F)	3 x 1.50	VNBC13S	EAC/KC

Remarks

* Cable length limit to 2 meters.

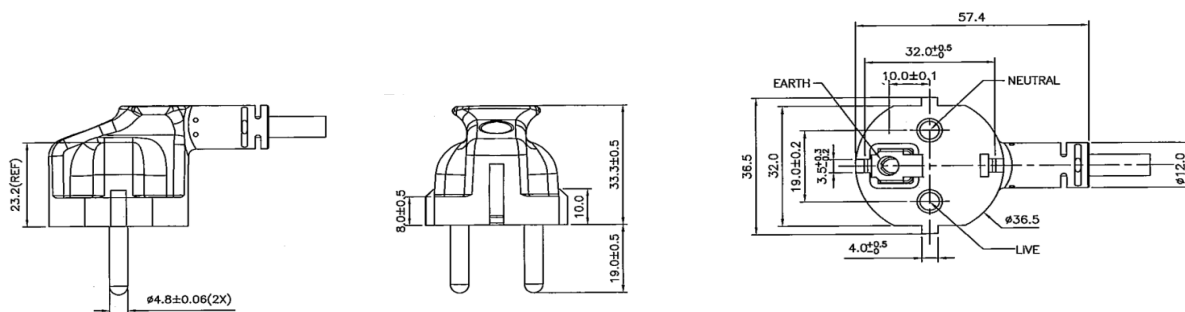



GULF COUNTRIES

Cat. No: VNBUK13A2

Description: Angled Plug for Class II Appliance

Standards: IEC 60884

Max. Rating: 10A, 250V

Safety Approval: GCC



Cable Type	Size (mm ²)	Matching Connector	Rated Current	Max. Fuse Rating	Combo Approvals
H03VVH2-F	2 x 0.50	VNBC7S*	3A	5A	ASTA/CPS
H05V2V2-F	2 x 0.75		6A	13A	
H05VV-F	2 x 0.75		6A	13A	
H03VVH2-F	2 x 0.75	VNBC7S	6A	13A	
H05VVH2-F	2 x 0.75	VNBC7S	6A	13A	
H05RR-F	2 x 0.75		6A	13A	
H05RN-F	2 x 0.75		6A	13A	
H05V2V2-F	2 x 1.00		10A	13A	
H05VV-F	2 x 1.00		10A	13A	
H05RR-F	2 x 1.00		10A	13A	
H05RN-F	2 x 1.00		10A	13A	

Remarks

* Cable length limit to 2 meters.

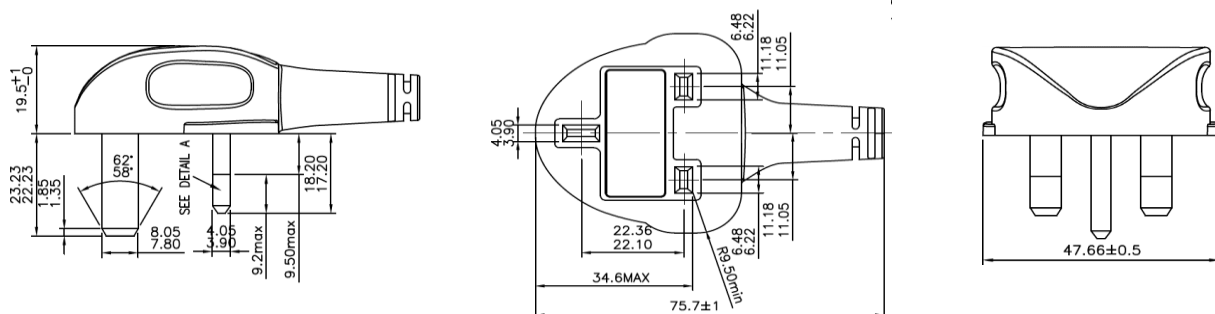



GULF COUNTRIES

Cat. No: VNBUK13A2B

Description: Angled Plug for Class II Appliance
(Big Strain Relief for rubber cables)

Standards: IEC 60884

Max. Rating: 13A, 250V

Safety Approval: GCC



Cable Type	Size (mm ²)	Rated Current	Max. Fuse Rating	Combo Approvals
H07RN-F	2 x 1.00	10A	13A	ASTA/CPS
H05RR-F	2 x 1.50	13A	13A	
H07RN-F	2 x 1.50	13A	13A	

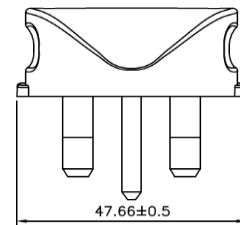
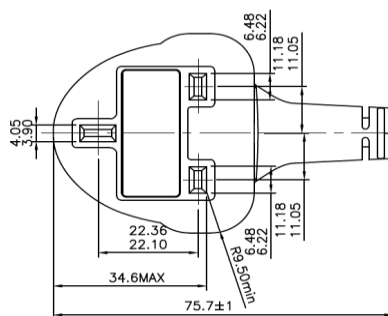
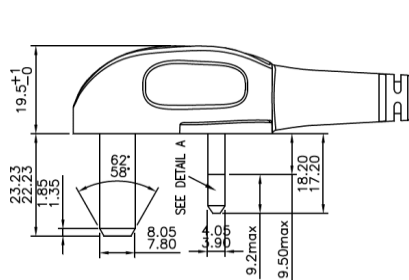



GULF COUNTRIES

Cat. No: VNBUK13A3

Description: Angled Plug for Class I Appliance

Standards: IEC 60884

Max. Rating: 13A, 250V

Safety Approval: GCC



Cable Type	Size (mm ²)	Matching Connector	Rated Current	Max. Fuse Rating	Combo Approvals
H05V2V2-F	3 x 0.75		6A	13A	ASTA/CPS
H03VV-F	3 x 0.75		6A	13A	
H05VV-F	3 x 0.75	VNBC13S*	6A	13A	
H05VV-F	3 x 1.00	VNBC13S	10A	13A	
H05V2V2-F	3 x 1.00		10A	13A	
H05VV-F	3 x 1.50	VNBC13S	13A	13A	

Remarks

* Cable length limit to 2 meters.

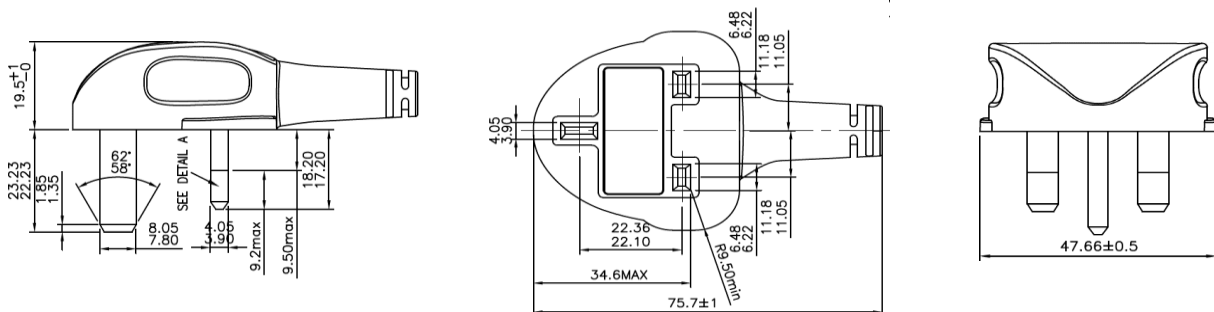



GULF COUNTRIES

Cat. No: VNBUK13A3B

Description: Angled Plug for Class I Appliance
(Big Strain Relief for rubber cables)

Standards: IEC 60884

Max. Rating: 13A, 250V

Safety Approval: GCC



Cable Type	Size (mm ²)	Rated Current	Max. Fuse Rating	Combo Approvals
H03RT-H	3 x 0.75	6A	13A	ASTA/CPS
H05RR-F	3 x 0.75	6A	13A	
H05RN-F	3 x 0.75	6A	13A	
H05RR-F	3 x 1.00	10A	13A	
H03RT-H	3 x 1.00	10A	13A	
H05RN-F	3 x 1.00	10A	13A	
H03RT-H	3 x 1.50	13A	13A	

Remarks

* Cable length limit to 2 meters.

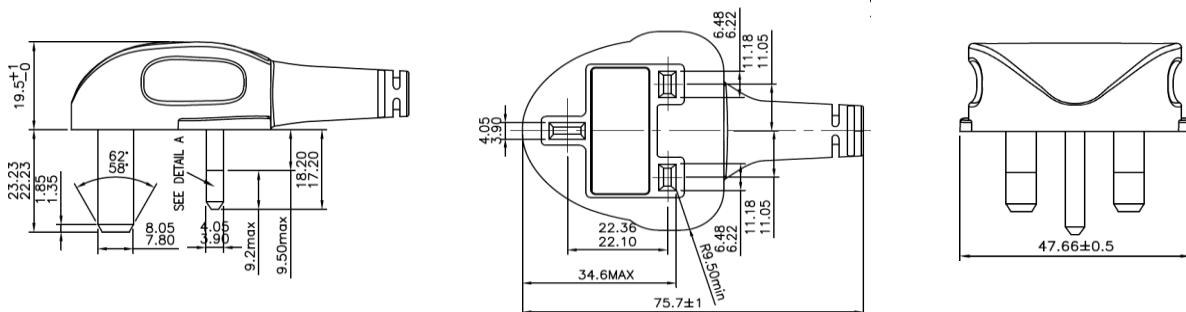



INDONESIA

Cat. No: VNBEU16S3

Description: Straight Plug with Dual-earthing contacts
for Class I Equipment

Standards: SNI 04-3892.1

Max. Rating: 16A, 250V

Safety Approval: SNI



Cable Type	Size (mm ²)	Matching Connector
60227 IEC 53 (H05VV-F)	3 x 0.75	VNBC13S*
60245 IEC 89 (H03RT-H)	3 x 0.75	
60245 IEC 57 (H05RN-F)	3 x 0.75	
60245 IEC 53 (H05RR-F)	3 x 0.75	
60227 IEC 53 (H05VV-F)	3 x 1.00	VNBC13S
60245 IEC 89 (H03RT-H)	3 x 1.00	
60245 IEC 57 (H05RN-F)	3 x 1.00	
60245 IEC 53 (H05RR-F)	3 x 1.00	
60227 IEC 53 (H05VV-F)	3 x 1.50	VNBC13S

Remarks

* Cable length limit to 2 meters

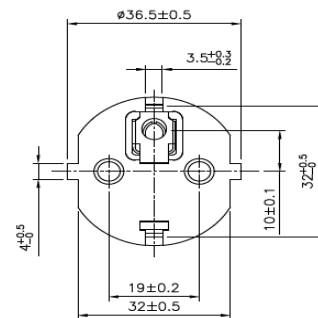
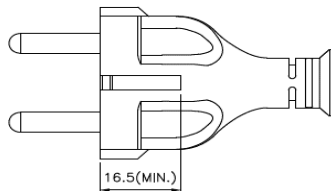
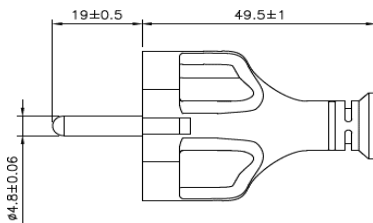



INDONESIA

Cat. No: VNBEU16A3

Description: Angled Plug with Dual-earthing contacts
for Class I Equipment

Standards: SNI 04-3892.1

Max. Rating: 16A, 250V

Safety Approval: SNI



Cable Type	Size (mm ²)	Matching Connector
60227 IEC 53 (H05VV-F)	3 x 0.75	VNBC13S*
60245 IEC 89 (H03RT-H)	3 x 0.75	
60245 IEC 57 (H05RN-F)	3 x 0.75	
60245 IEC 53 (H05RR-F)	3 x 0.75	
60227 IEC 53 (H05VV-F)	3 x 1.00	VNBC13S
60245 IEC 89 (H03RT-H)	3 x 1.00	
60245 IEC 57 (H05RN-F)	3 x 1.00	
60245 IEC 53 (H05RR-F)	3 x 1.00	
60227 IEC 53 (H05VV-F)	3 x 1.50	VNBC13S

Remarks

* Cable length limit to 2 meters

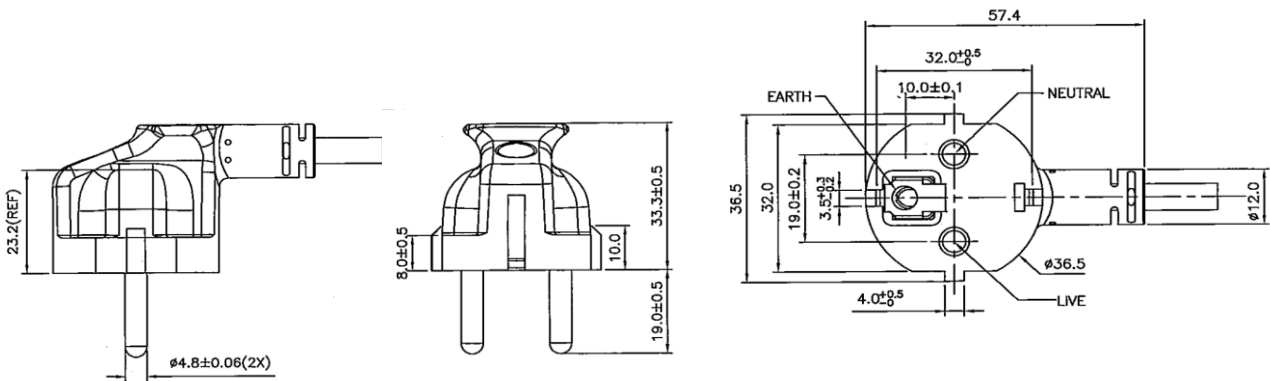

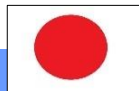

JAPAN

Cat. No: VNBUS15S3

Description: 3 Pins Straight Plug - (Without sleeve)
for Class I Appliance

Standards: JIS C8303 & JIS C8306 (Under Ordinance 1)

Max. Rating: 15A, 125V

Safety Approval: PSE



Cable Type	Size (mm ²)	Rated Current
VCTF	3 X 2.00	15A, 125V

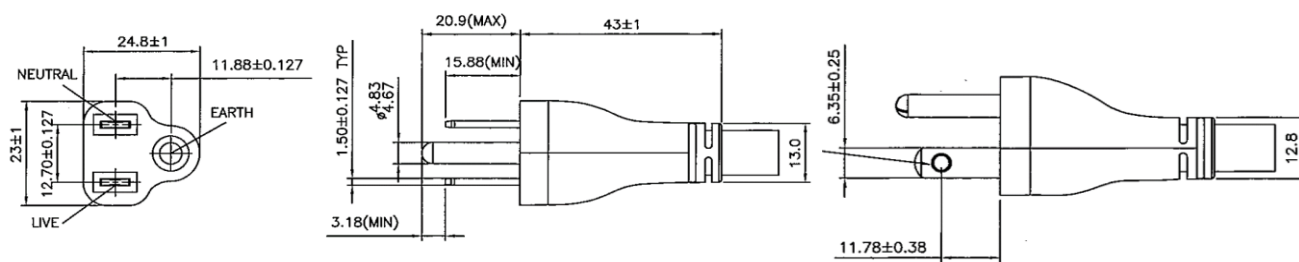



KOREA

Cat. No: VNBEU16S3

Description: Straight Plug with Dual-earthing contacts
for Class I Equipment

Standards: K60884-1

Max. Rating: 16A, 250V

Safety Approval: KC



Cable Type	Size (mm ²)	Matching Connector	Combo Approvals
60227 KS IEC 52 (H03VV-F)	3 x 0.75		VDE/EAC
60227 KS IEC 53 (H05VV-F)	3 x 0.75	VNBC13S*	
60227 KS IEC 53 (H05VV-F)	3 x 1.00	VNBC13S	
60245 KS IEC 53 (H05RR-F)	3 x 1.00		
60227 KS IEC 53 (H05VV-F)	3 x 1.50		

Remarks

* Cable length limit to 2 meters.

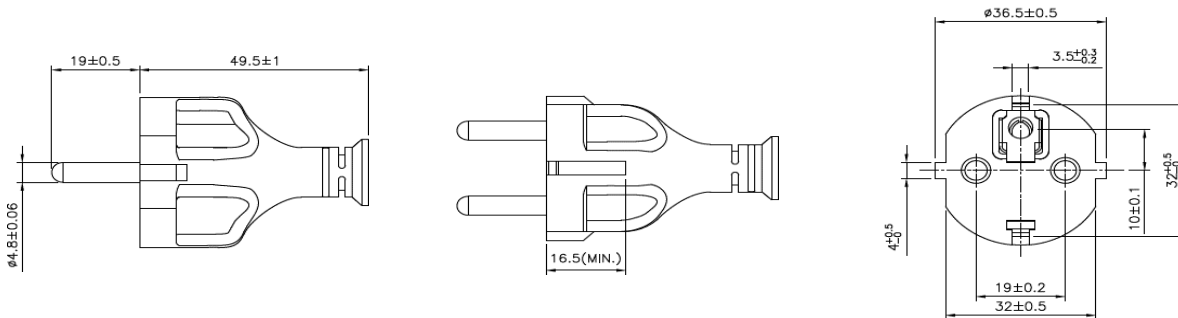



KOREA

Cat. No: VNBEU16A3

Description: Angled Plug with Dual-earthing contacts
for Class I Equipment

Standards: K60884-1

Max. Rating: 16A, 250V

Safety Approval: KC

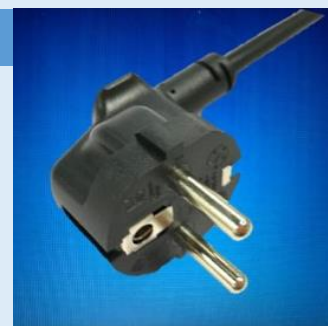

Cable Type	Size (mm ²)	Matching Connector	Combo Approvals
60227 KS IEC 52 (H03VV-F)	3 x 0.75		VDE/EAC
60227 KS IEC 53 (H05VV-F)	3 x 0.75	VNBC13S*	
60227 KS IEC 53 (H05VV-F)	3 x 1.00	VNBC13S	
60245 KS IEC 53 (H05RR-F)	3 x 1.00		
60227 KS IEC 53 (H05VV-F)	3 x 1.50		

Remarks

* Cable length limit to 2 meters.

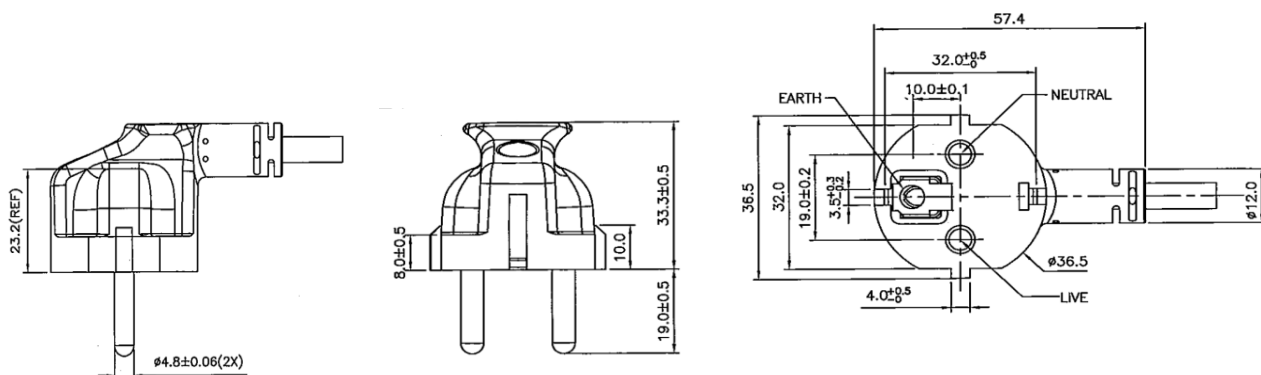



NORTH AMERICA

Cat. No: VNBUS15S3

Description: NEMA 5-15P Straight Plug for Class I Appliance

Standards: UL498 , UL817 , CSA Std C22.2

Max. Rating: 15A, 125V

Safety Approval: UL/c-UL



Cable Type	Size (mm ²)	Rated Current
SJT	AWG 14X3	15A, 125V

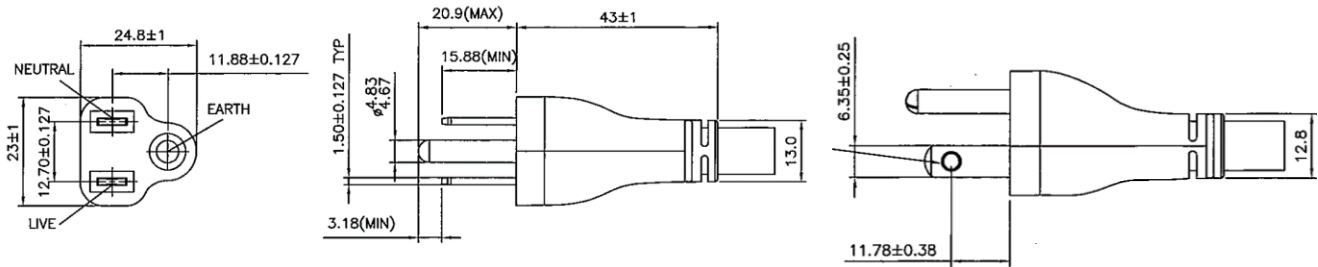



RUSSIA

Cat. No: VNBEU16S3

Description: Straight Plug with Dual-earthing contacts
for Class I Equipment

Standards: GOST R 51322.1

Max. Rating: 16A, 250V

Safety Approval: EAC



Cable Type	Size (mm ²)	Matching Connector	Combo Approvals
60227 KS IEC 52 (H03VV-F)	3 x 0.75		VDE/KC
60227 KS IEC 53 (H05VV-F)	3 x 0.75	VNBC13S*	VDE/KC
H03RT-H	3 x 0.75		VDE
H05RN-F	3 x 0.75		VDE
H05RR-F	3 x 0.75		VDE
60227 KS IEC 53 (H05VV-F)	3 x 1.00	VNBC13S	VDE/KC
60245 KS IEC 53 (H05RR-F)	3 x 1.00		VDE/KC
H05V2V2-F	3 x 1.00		VDE
H05RN-F	3 x 1.00		VDE
H03RT-H	3 x 1.00		VDE
H05RN-F	3 x 1.00		VDE
60227 KS IEC 53 (H05VV-F)	3 x 1.50	VNBC13S	VDE/KC

Remarks

* Cable length limit to 2 meters.

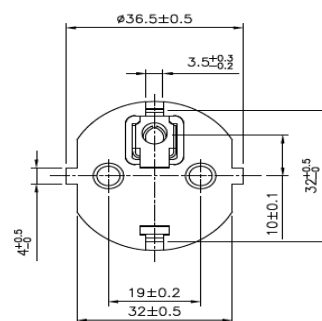
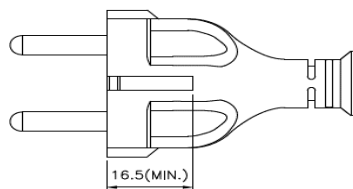
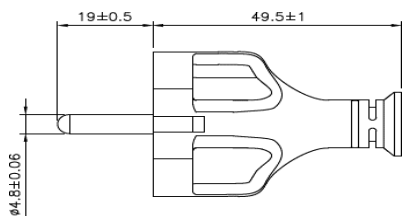



RUSSIA

Cat. No: VNBEU16A3

Description: Angled Plug with Dual-earthing contacts
for Class I Equipment

Standards: GOST R 51322.1

Max. Rating: 16A, 250V

Safety Approval: EAC

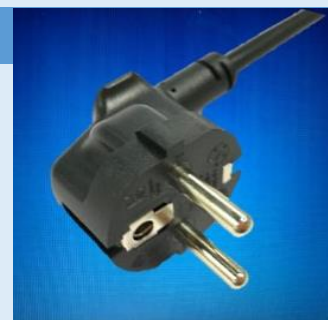

Cable Type	Size (mm ²)	Matching Connector	Combo Approvals
60227 KS IEC 52 (H03VV-F)	3 x 0.75		VDE/KC
60227 KS IEC 53 (H05VV-F)	3 x 0.75	VNBC13S*	VDE/KC
H03RT-H	3 x 0.75		VDE
H05RN-F	3 x 0.75		VDE
H05RR-F	3 x 0.75		VDE
60227 KS IEC 53 (H05VV-F)	3 x 1.00	VNBC13S	VDE/KC
60245 KS IEC 53 (H05RR-F)	3 x 1.00		VDE/KC
H05V2V2-F	3 x 1.00		VDE
H05RN-F	3 x 1.00		VDE
H03RT-H	3 x 1.00		VDE
H05RN-F	3 x 1.00		VDE
60227 KS IEC 53 (H05VV-F)	3 x 1.50	VNBC13S	VDE/KC

Remarks

* Cable length limit to 2 meters.

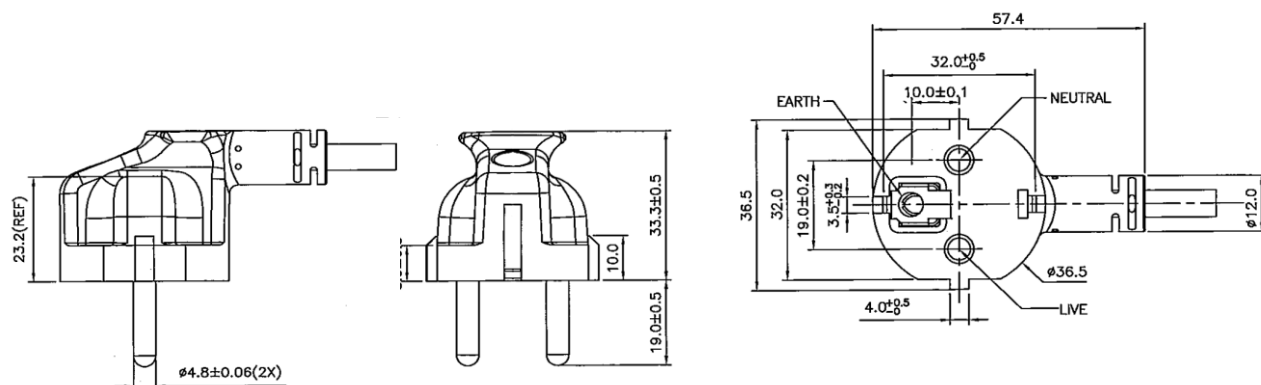



SINGAPORE

Cat. No: VNBUK13A2

Description: Angled Plug for Class II Appliance

Standards: SS145/A

Max. Rating: 10A, 250V

Safety Approval: CPS



Cable Type	Size (mm ²)	Matching Connector	Rated Current	Max. Fuse Rating	Combo Approvals
H03VVH2-F	2 x 0.50	VNBC7S*	3A	5A	ASTA/GCC
H05V2V2-F	2 x 0.75		6A	13A	
H05VV-F	2 x 0.75		6A	13A	
H03VVH2-F	2 x 0.75	VNBC7S	6A	13A	
H05VVH2-F	2 x 0.75	VNBC7S	6A	13A	
H05RR-F	2 x 0.75		6A	13A	
H05RN-F	2 x 0.75		6A	13A	
H05V2V2-F	2 x 1.00		10A	13A	
H05VV-F	2 x 1.00		10A	13A	
H05RR-F	2 x 1.00		10A	13A	
H05RN-F	2 x 1.00		10A	13A	

Remarks

* Cable length limit to 2 meters.

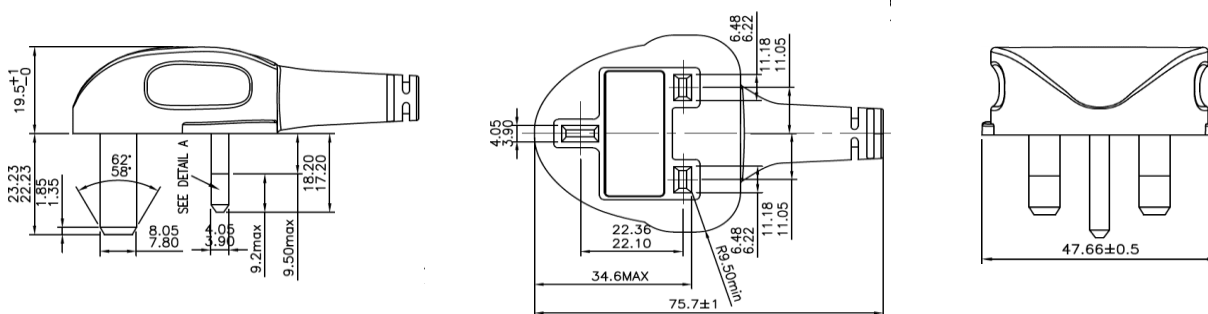



SINGAPORE

Cat. No: VNBUK13A2B

Description: Angled Plug for Class II Appliance
(Big Strain Relief for rubber cables)

Standards: SS145/A

Max. Rating: 13A, 250V

Safety Approval: CPS



Cable Type	Size (mm ²)	Rated Current	Max. Fuse Rating	Combo Approvals
H07RN-F	2 x 1.00	10A	13A	ASTA/GCC
H05RR-F	2 x 1.50	13A	13A	
H07RN-F	2 x 1.50	13A	13A	

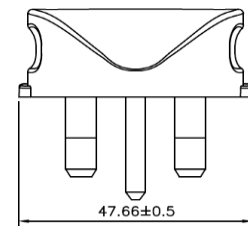
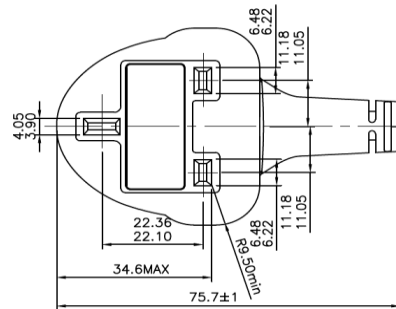
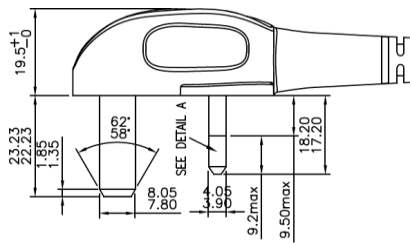



SINGAPORE

Cat. No: VNBUK13A3

Description: Angled Plug for Class I Appliance

Standards: SS145/A

Max. Rating: 13A, 250V

Safety Approval: CPS



Cable Type	Size (mm ²)	Matching Connector	Rated Current	Max. Fuse Rating	Combo Approvals
H05V2V2-F	3 x 0.75		6A	13A	ASTA/GCC
H03VV-F	3 x 0.75		6A	13A	
H05VV-F	3 x 0.75	VNBC13S*	6A	13A	
H05VV-F	3 x 1.00	VNBC13S	10A	13A	
H05V2V2-F	3 x 1.00		10A	13A	
H05VV-F	3 x 1.50	VNBC13S	13A	13A	

Remarks

* Cable length limit to 2 meters.

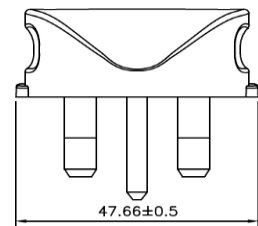
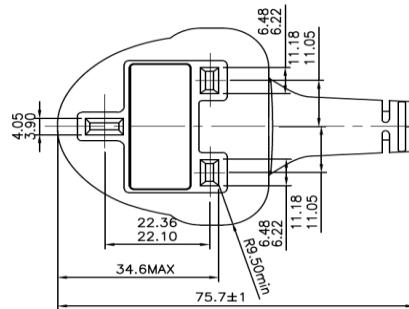
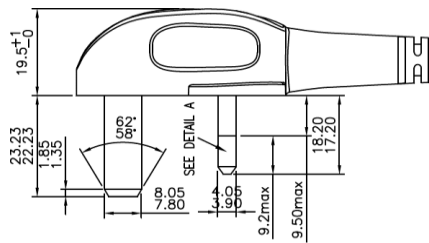



SINGAPORE

Cat. No: VNBUK13A3B

Description: Angled Plug for Class I Appliance
(Big Strain Relief for rubber cables)

Standards: SS145/A

Max. Rating: 13A, 250V

Safety Approval: CPS



Cable Type	Size (mm ²)	Rated Current	Max. Fuse Rating	Combo Approvals
H03RT-H	3 x 0.75	6A	13A	ASTA/CPS
H05RR-F	3 x 0.75	6A	13A	
H05RN-F	3 x 0.75	6A	13A	
H05RR-F	3 x 1.00	10A	13A	
H03RT-H	3 x 1.00	10A	13A	
H05RN-F	3 x 1.00	10A	13A	
H03RT-H	3 x 1.50	13A	13A	

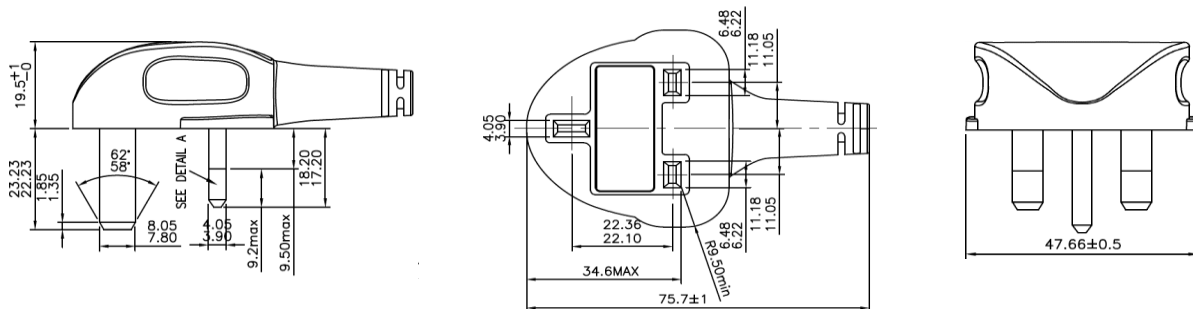



UNITED KINGDOM

Cat. No: VNBUK13A2

Description: Angled Plug for Class II Appliance

Standards: BS 1363/A

Max. Rating: 10A, 250V

Safety Approval: ASTA



Cable Type	Size (mm ²)	Matching Connector	Rated Current	Max. Fuse Rating	Combo Approvals
H03VVH2-F	2 x 0.50	VNBC7S*	3A	5A	CPS/GCC
H05V2V2-F	2 x 0.75		6A	13A	
H05VV-F	2 x 0.75		6A	13A	
H03VVH2-F	2 x 0.75	VNBC7S	6A	13A	
H05VVH2-F	2 x 0.75	VNBC7S	6A	13A	
H05RR-F	2 x 0.75		6A	13A	
H05RN-F	2 x 0.75		6A	13A	
H05V2V2-F	2 x 1.00		10A	13A	
H05VV-F	2 x 1.00		10A	13A	
H05RR-F	2 x 1.00		10A	13A	
H05RN-F	2 x 1.00		10A	13A	

Remarks

* Cable length limit to 2 meters.

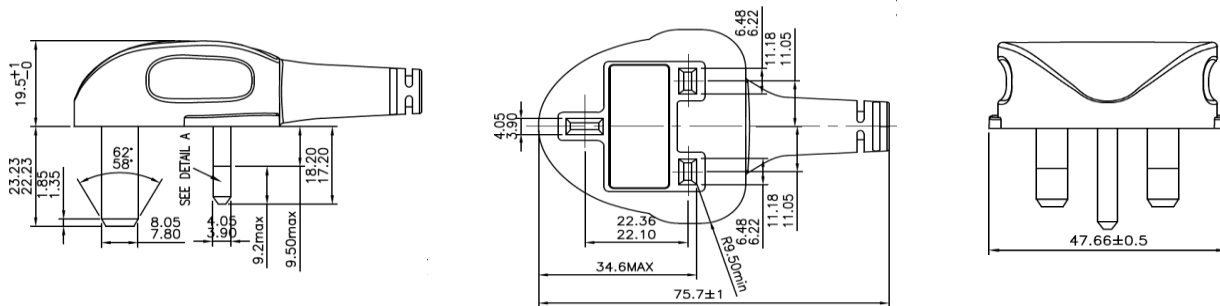



UNITED KINGDOM

Cat. No: VNBUK13A2B

Description: Angled Plug for Class II Appliance
(Big Strain Relief for rubber cables)

Standards: BS 1363/A

Max. Rating: 13A, 250V

Safety Approval: ASTA



Cable Type	Size (mm ²)	Rated Current	Max. Fuse Rating	Combo Approvals
H07RN-F	2 x 1.00	10A	13A	CPS/GCC
H05RR-F	2 x 1.50	13A	13A	
H07RN-F	2 x 1.50	13A	13A	

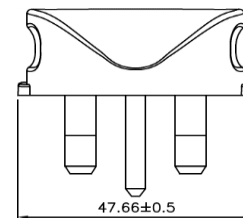
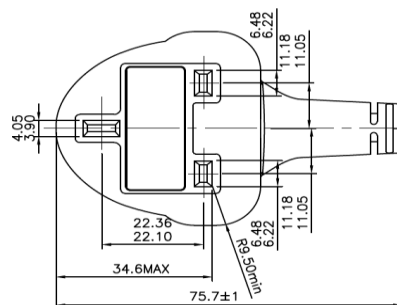
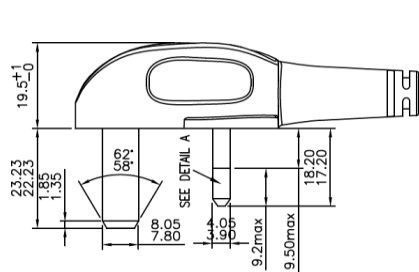



UNITED KINGDOM

Cat. No: VNBUK13A3

Description: Angled Plug for Class I Appliance

Standards: BS 1363/A

Max. Rating: 13A, 250V

Safety Approval: ASTA



Cable Type	Size (mm ²)	Matching Connector	Rated Current	Max. Fuse Rating	Combo Approvals
H05V2V2-F	3 x 0.75		6A	13A	CPS/GCC
H03VV-F	3 x 0.75		6A	13A	
H05VV-F	3 x 0.75	VNBC13S*	6A	13A	
H05VV-F	3 x 1.00	VNBC13S	10A	13A	
H05V2V2-F	3 x 1.00		10A	13A	
H05VV-F	3 x 1.50	VNBC13S	13A	13A	

Remarks

* Cable length limit to 2 meters.

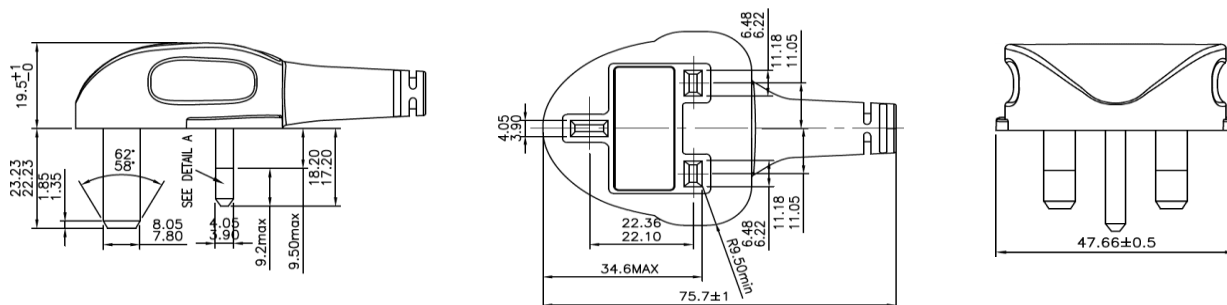



UNITED KINGDOM

Cat. No: VNBUK13A3B

Description: Angled Plug for Class I Appliance
(Big Strain Relief for rubber cables)

Standards: BS 1363/A

Max. Rating: 13A, 250V

Safety Approval: ASTA



Cable Type	Size (mm ²)	Rated Current	Max. Fuse Rating	Combo Approvals
H05RN-F	3 x 0.75	6A	13A	CPS/GCC
H05RR-F	3 x 0.75	6A	13A	
H03RT-H	3 x 0.75	6A	13A	
H03RT-H	3 x 1.00	10A	13A	
H05RN-F	3 x 1.00	10A	13A	
H05RR-F	3 x 1.00	10A	13A	
H03RT-H	3 x 1.50	13A	13A	

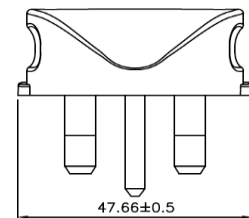
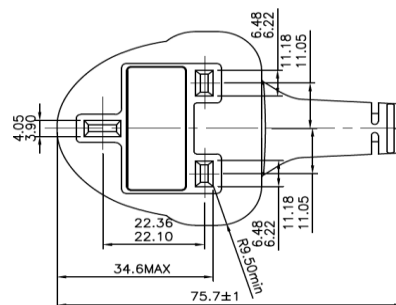
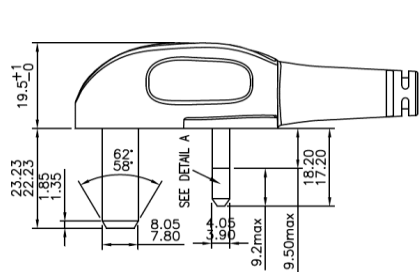



WORLD WIDE CONNECTORS IEC STD.C7

Cat. No: VNBC7S

Description: 2-pole Straight Connector

Standards: GB17465.1 / GB15934

IEC/EN 60320-1, Standard Sheet C7

K60320-1 / K60799

AS/NZS 60320.1, Standard Sheet C7

JIS C 8358 & JIS C8306, under Ordinance 1

J60320-1 (IEC-J), under Ordinance 2

UL 60320-1, CSA STD C22.2, No. 60320-1-11



Cable Type	Size (mm ²)	Rated Current	Safety Approval
60227 IEC 52 (RVV) 300/300 (Flat)	2 x 0.50*	2.5A / 250V~	CCC
60227 IEC 52 (RVV) 300/300 (Flat)	2 x 0.75	2.5A / 250V~	
60227 IEC 53 (RVV) 300/500 (Flat)	2 x 0.75	2.5A / 250V~	
H03VVH2-F	2 x 0.50*	2.5A / 250V~	ENEC
H03VVH2-F	2 x 0.75	2.5A / 250V~	
H05VVH2-F	2 x 0.75	2.5A / 250V~	
60227 KS IEC 52 (H03VVH2-F)	2 x 0.75	2.5A 250V~	KC
V-75, 250/250V, Light Duty (Flat)	2 x 0.50*	2.5A, 250V	SAA
H03VVH2-F			
V-75, 250/250 V, Light Duty (Flat) H03VVH2-F	2 x 0.75	2.5A, 250V	
V-75, 250/440 V, Ordinary Duty (Flat) H05VVH2-F	2 x 0.75	2.5A, 250V	
VFF	2 x 0.75	7A, 125V	PSE
HVFF	2 x 0.75	7A, 125V	
VCTFK	2 x 0.75	7A, 125V	
227 IEC 52 (Flat)	2 x 0.75	7A, 125V	
		2.5A, 250V	
SPT-2 + VFF	18/2 + 2x0.75mm ²	7A, 125V	UL+PSE
NISPT-2 + VCTFK	18/2 + 2x0.75mm ²	7A, 125V	
SPT-1	AWG 18 x 2	7A, 125V/ 250V	UL,c-UL
SPT-2	AWG 18 x 2	7A, 125V/ 250V	
NISPT-1	AWG 18 x 2	7A, 125V/ 250V	
NISPT-2	AWG 18 x 2	7A, 125V/ 250V	

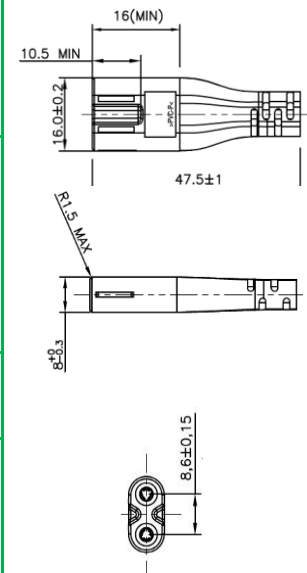

Remarks

- * Cable length limit to 2 meters.
- VNBC7S with yellow full-insertion indicators are also available.



WORLD WIDE CONNECTORS IEC STD.C13

Cat. No: VNBC13S

Description: 3-pole Straight Connector

Standards: GB17465.1 / GB15934
IEC/EN 60320-1 - Standard Sheet C13
JIS C 8358 & JIS C8306,
under Ordinance 1

AS/NZS 60320.1 Standard Sheet C13

K60320-1 / K60799

UL 60320-1 , CSA STD C22.2 No. 60320-1-11



Cable Type	Size (mm ²)	Rated Current	Safety Approval
60227 IEC 53 (RVV) 300/500 (Round)	3 x 0.75 *	10A, 250V	CCC
60227 IEC 53 (RVV) 300/500 (Round)	3 x 1.00	10A, 250V	
H05VV-F	3 x 0.75 *	10A, 250V	ENEC
H05VV-F	3 x 1.00	10A, 250V	
H05VV-F	3 x 1.50	10A, 250V	
VCTF	2 X 0.75	7A, 125V	PSE
HVCTF	2 X 0.75	7A, 125V	
VFF	2 X 0.75	7A, 125V	
VCTFK	2 X 0.75	7A, 125V	
HVCTFK	2 X 0.75	7A, 125V	
PSE IEC 52 (Flat)	2 X 0.75	7A, 125V	
HVFF	2 X 0.75	7A, 125V	
VFF	2 X 1.25	12A, 125V	
VCTFK	2 X 1.25	12A, 125V	
VCTF	2 X 1.25	12A, 125V	
HVCTF	2 X 1.25	12A, 125V	
VCTF	2 X 2.00	15A, 125V	
227 IEC 53	3 x 0.75	7A, 125V	
	3 x 0.75 *	10A, 250V	
VCTF	3 x 0.75	7A, 125V	
HVCTF	3 x 0.75	7A, 125V	
227 IEC 53	3 x 1.00	10A, 250V	
HVCTF	3 X 1.25	12A, 125V/250V	
VCTF	3 x 1.25	12A, 125V/250V	
VCTF	3 X 2.00	10A, 250V	
		15A, 125V/250V	

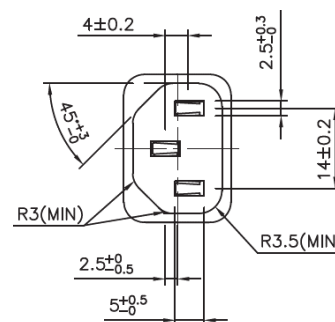
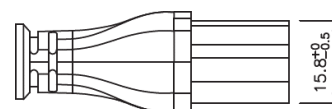
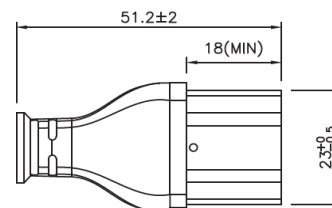



WORLD WIDE CONNECTORS IEC STD.C13 (Cont.)

Cable Type	Size (mm ²)	Rated Current	Safety Approval
HVCTF	3 x 2.00	10A, 250V	PSE
		15A, 125V/250V	
V-75, 250/440 V, Ordinary Duty (Circular) (H05VV-F)	3 x 0.75 *	10A, 250V	SAA
V-75, 250/440 V, Ordinary Duty (Circular) (H05VV-F)	3 x 1.00	10A, 250V	
V-75, 250/440 V, Ordinary Duty (Circular) (H05VV-F)	3 x 1.50	10A, 250V	
60227 KS IEC 53 (H05VV-F)	3 x 0.75 *	10A, 250V	KC
60227 KS IEC 53 (H05VV-F)	3 x 1.00	10A, 250V	
SJT	AWG 16/3	13A, 125V/250V	UL/C-UL
SJT Shielded	AWG 16/3	13A, 125V/250V	
SVT	AWG 16/3	13A, 125V/250V	
SJTW	AWG 16/3	13A, 125V/250V	
SJTOW	AWG 16/3	13A, 125V/250V	
SJTOOW	AWG 16/3	13A, 125V/250V	
SJTO	AWG 16/3	13A, 125V/250V	
SJTOO	AWG 16/3	13A, 125V/250V	
SJT	AWG 17/3	250V; 12A, 125V/	
SJT	AWG 18/3	10A, 125V/250V	
SJT Shielded	AWG 18/3	10A, 125V/250V	
SJTO	AWG 18/3	10A, 125V/250V	
SJTOO	AWG 18/3	10A, 125V/250V	
SJTW	AWG 18/3	10A, 125V/250V	
SJTOW	AWG 18/3	10A, 125V/250V	
SJTOOW	AWG 18/3	10A, 125V/250V	
SVT	AWG 18/3	10A, 125V/250V	
SVT Shielded	AWG 18/3	10A, 125V/250V	
SPT-2	AWG 18/3	10A, 125V/250V	

Remarks

* Cable length limit to 2 meters.



Generic Chinese Powercord Set (Class I) 1.8M Black

Cat. No: BGBSD3SX18B

Description: Chinese Power Supply Cordset (PB FR)

Standards: GB2099.1 / GB1002

Max. Rating: 10A, 250V

Safety Approval: CCC

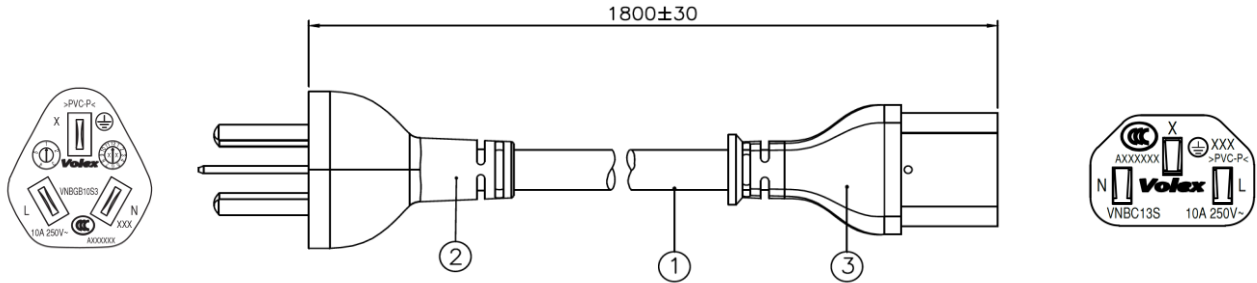

Cable Type ①	Size (mm ²)	Plug ②	Connector③
RVV 300/500	3X1.0	VNBGB10S3	VNBC13S

Binding: 210 +/- 30 mm (w / pin cap)

Standard Packaging: 80 pcs per box

Master Box Dimensions: 560x330x250 mm

SKU Spec Ref No: 192931/2



Generic Chinese Powercord Set (Class I) 1.8M Black

Cat. No: BGBSD3SW18B

Description: Chinese Power Supply Cordset (PB FR)

Standards: GB2099.1 / GB1002

Max. Rating: 10A, 250V

Safety Approval: CCC

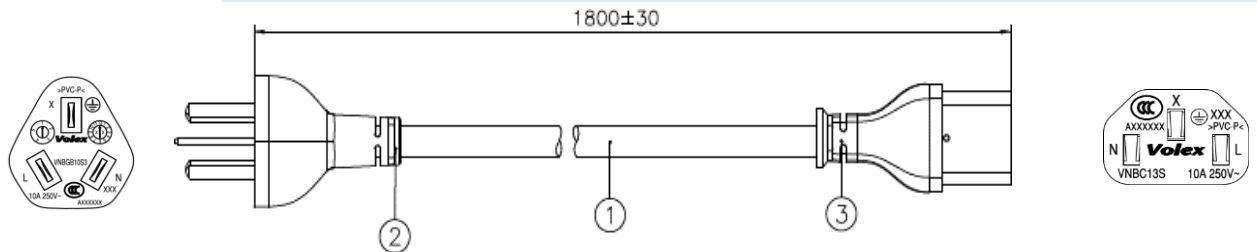

Cable Type ①	Size (mm ²)	Plug ②	Connector③
RVV 300/500	3X0.75	VNBGB10S3	VNBC13S

Binding: 210 +/- 30 mm (w / pin cap)

Standard Packaging: 80 pcs per box

Master Box Dimensions: 560x330x250 mm

SKU Spec Ref No: 196633/2



Generic Chinese Powercord Set (Class I) 1.8M Black

Cat. No: SGBSD5SW18B

Description: Chinese Power Supply Cordset (PB FR)

Standards: GB2099.1 / GB1002

Max. Rating: 2.5A, 250V

Safety Approval: CCC

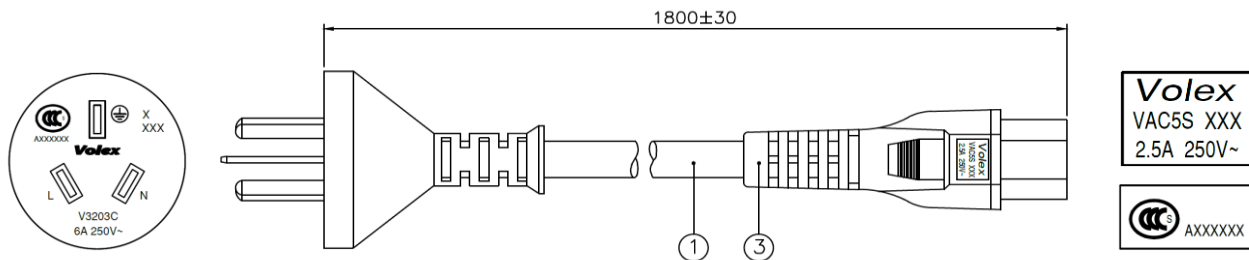

Cable Type ①	Size (mm ²)	Plug ②	Connector③
RVV 300/500	3X0.75	V3203C	VAC5S

Binding: 210 +/- 30 mm (w / pin cap)

Standard Packaging: 80 pcs per box

Master Box Dimensions: 560x330x250 mm

SKU Spec Ref No: 192932/2



Generic Chinese Powercord Set (Class II) 1.8M Black

Cat. No: BGBSA7SW18B

Description: Chinese Power Supply Cordset (PB FR)

Standards: GB2099.1 / GB1002

Max. Rating: 2.5A, 250V

Safety Approval: CCC

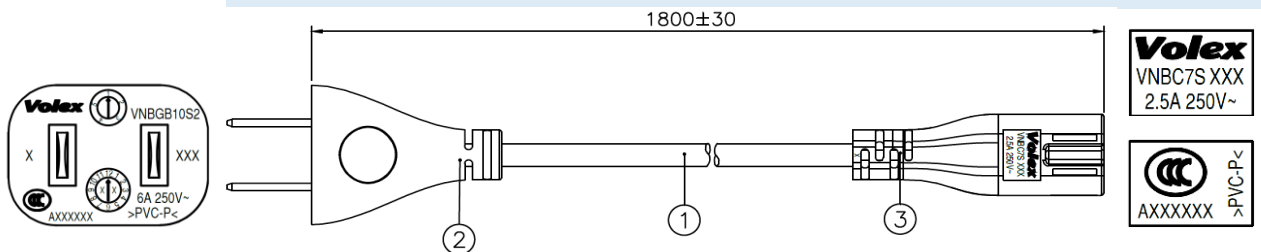

Cable Type ①	Size (mm ²)	Plug ②	Connector③
RVV 300/300	2X0.75	VNBGB10S2	VNBC7S

Binding: 220 +/- 30 mm (w / pin cap)

Standard Packaging: 170 pcs per box

Master Box Dimensions: 560x330x250 mm

SKU Spec Ref No: 192933/2



Generic Chinese Powercord Set (Class II) 1.8M Black

Cat. No: BGBSA7SV18B

Description: Chinese Power Supply Cordset (PB FR)

Standards: GB2099.1 / GB1002

Max. Rating: 2.5A, 250V

Safety Approval: CCC

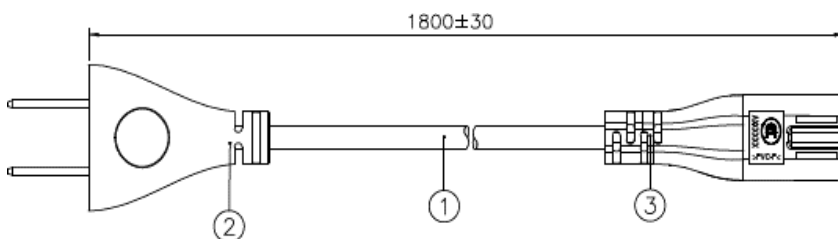
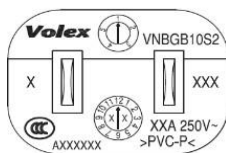

Volex
VNBC7S XXX
2.5A 250V~



Cable Type ①	Size (mm ²)	Plug ②	Connector③
RVV 300/500	2x0.50	VNBGB10S2	VNBC7S

Binding: 220 +/- 30 mm (w / pin cap)

Standard Packaging: 200 pcs per box

Master Box Dimensions: 560x330x250 mm

SKU Spec Ref No: 196634/2



Generic British Powercord Set (Class I) 1.8M Black



Cat. No: BUKAD3SX18B

Description: British+Singapore+GCC Power Supply CordSet (PB FR)

Standards: BS 1363/A

SS145/A

IEC 60884

Max. Rating: 10A, 250V

Safety Approval: ASTA,CPS,GCC

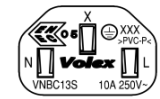
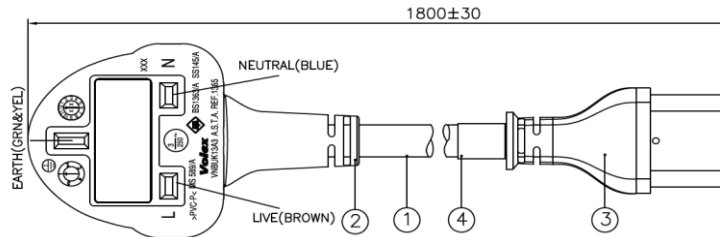

Cable Type ①	Size (mm ²)	Plug ②	Connector ③
H05VV-F	3 x 1.00	VNBUK13A3	VNBC13S

Binding: 210 +/- 30 mm (w / pin cap)

Label CE & ROHS: 50x25 mm

Standard Packaging: 70 pcs per box

Master Box Dimensions: 560x330x250 mm

SKU Spec Ref No: 206521/10



Generic British Powercord Set (Class I) 1.8M Black



Cat. No: BUKAD3SW18B

Description: British+Singapore+GCC Power Supply CordSet (PB FR)

Standards: BS 1363/A

SS145/A

IEC 60884

Max. Rating: 10A, 250V

Safety Approval: ASTA,CPS,GCC

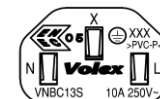
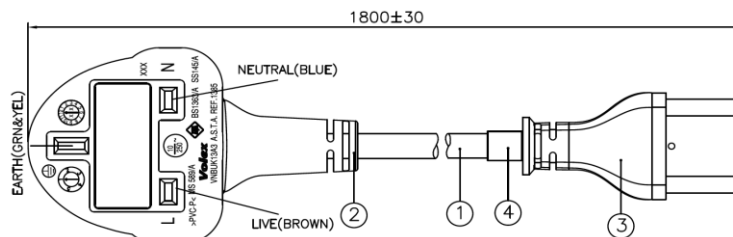

Cable Type ①	Size (mm ²)	Plug ②	Connector ③
H05VV-F	3X0.75	VNBUK13A3	VNBC13S

Binding: 210 +/- 30 mm (w / pin cap)

Label CE & ROHS: 50x25 mm

Standard Packaging: 80 pcs per box

Master Box Dimensions: 560x330x250 mm

SKU Spec Ref No: 192944/2



Generic British Powercord Set (Class I) 1.8M Black



Cat. No: BUKAD5SW18B

Description: British+Singapore+GCC Power Supply CordSet (PB FR)

Standards: BS 1363/A

SS145/A

IEC 60884

Max. Rating: 2.5A, 250V

Safety Approval: ASTA,CPS,GCC

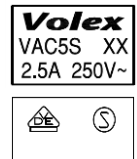
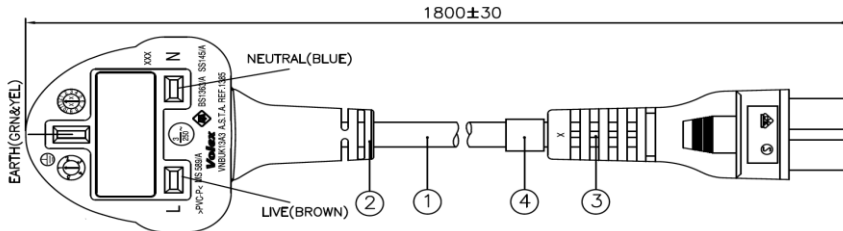

Cable Type ①	Size (mm ²)	Plug ②	Connector ③
H05VV-F	3X0.75	VNBUK13A3	VAC5S

Binding: 210 +/- 30 mm (w / pin cap)

Label CE & ROHS: 50x25 mm

Standard Packaging: 80 pcs per box

Master Box Dimensions: 560x330x250 mm

SKU Spec Ref No: 206521/11



Generic British Powercord Set (Class II) 1.8M Black



Cat. No: BUKAA7SW18B

Description: British+Singapore+GCC Power Supply CordSet (PB FR)

Standards: BS 1363/A

SS145/A

IEC 60884

Max. Rating: 2.5A, 250V

Safety Approval: ASTA,CPS,GCC

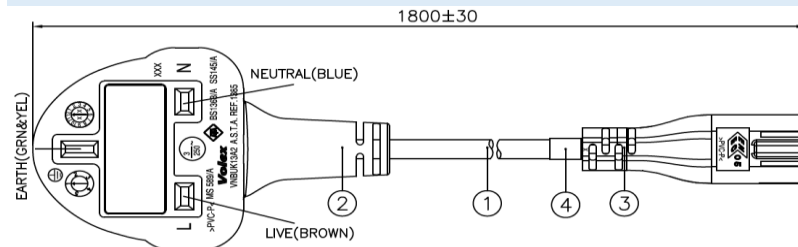

Cable Type ①	Size (mm ²)	Plug ②	Connector ③
H03VVH2-F	2X0.75	VNBUK13A2	VNBC7S

Binding: 220 +/- 30 mm (w / pin cap)

Label CE & ROHS: 50x 25 mm

Standard Packaging: 130 pcs per box

Master Box Dimensions: 560x330x250 mm

SKU Spec Ref No: 206521/12



Generic British Powercord Set (Class II) 1.8M Black



Cat. No: BUKAA7SV18B

Description: British+Singapore+GCC Power Supply CordSet (PB FR)

Standards: BS 1363/A

SS145/A

IEC 60884

Max. Rating: 2.5A, 250V

Safety Approval: ASTA,CPS,GCC

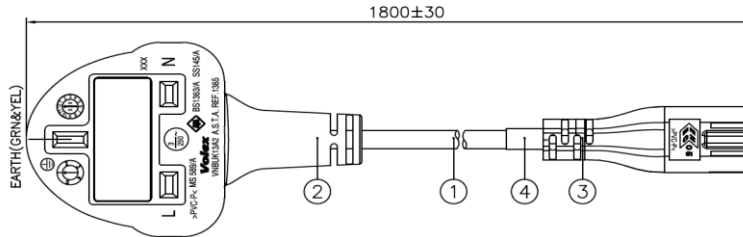

Volex
VNBC7S XXX
2.5A 250V~

EN 05
>PVC-P<

Cable Type ①	Size (mm ²)	Plug ②	Connector ③
H03VVH2-F	2 x 0.50	VNBUK13A2	VNBC7S

Binding: 220 +/- 20 mm (w / pin cap)

Label CE & ROHS: 50x25 mm

Standard Packaging: 150 pcs per box

Master Box Dimensions: 560x330x250 mm

SKU Spec Ref No: 196632/2

Generic European Powercord Set (Class I) 1.8M Black



Cat. No: BEUSD3SX18B

Description: European+Russian+Korean Power Supply Cordset (PB FR)

Standards: IEC 60884-1 (CEE 7 Standard Sheet VII)

GOST R 51322.1

K60884-1

Max. Rating: 10A, 250V

Safety Approval: VDE,EAC,KC

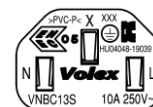
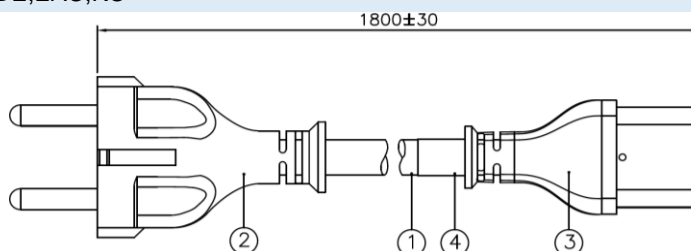
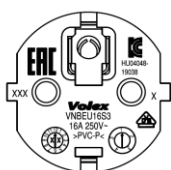

Cable Type ①	Size (mm ²)	Plug ②	Connector③
H05VV-F + K60227 IEC 53	3X1.00	VNBEU16S3	VNBC13S

Binding: 210 +/- 30 mm (No pin cap)

Label CE & ROHS: 50x25 mm

Standard Packaging: 70 pcs per box

Master Box Dimensions: 560x330x250 mm

SKU Spec Ref No: 192934/2

Generic European Powercord Set (Class I) 1.8M Black



Cat. No: BEUAD3SX18B

Description: European+Russian+Korean Power Supply Cordset (PB FR)

Standards: IEC 60884-1 (CEE 7 Standard Sheet VII)

GOST R 51322.1

K60884-1

Max. Rating: 10A, 250V

Safety Approval: VDE,EAC,KC

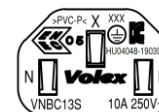
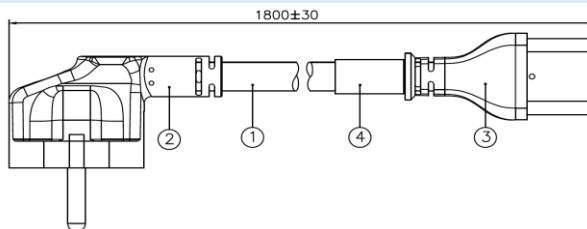
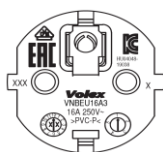

Cable Type ①	Size (mm ²)	Plug ②	Connector③
H05VV-F + K60227 IEC 53	3X1.00	VNBEU16A3	VNBC13S

Binding: 210 +/- 30 mm (No pin cap)

Label CE & ROHS: 50x25 mm

Standard Packaging: 70 pcs per box

Master Box Dimensions: 560x330x250 mm

SKU Spec Ref No: 196636/2

Generic European Powercord Set (Class I) 1.8M Black



Cat. No: BEUSD3SW18B

Description: European+Russian+Korean Power Supply Cordset (PB FR)

Standards: IEC 60884-1 (CEE 7 Standard Sheet VII)

GOST R 51322.1

K60884-1

Max. Rating: 10A, 250V

Safety Approval: VDE,EAC,KC

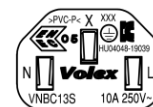
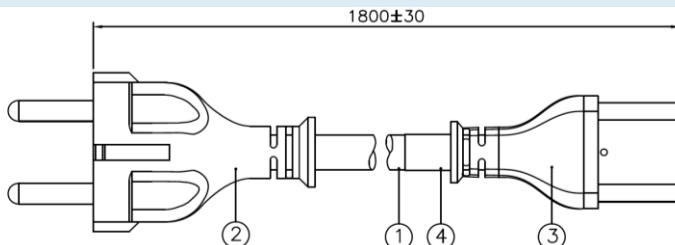
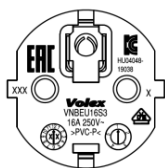

Cable Type ①	Size (mm ²)	Plug ②	Connector③
H05VV-F + K60227 IEC 53	3X0.75	VNBEU16S3	VNBC13S

Binding: 210 +/- 30 mm (No pin cap)

Label CE & ROHS: 50x25 mm

Standard Packaging: 70 pcs per box

Master Box Dimensions: 560x330x250 mm

SKU Spec Ref No: 196635/2

Generic European Powercord Set (Class I) 1.8M Black



Cat. No: BEUAD3SW18B

Description: European+Russian+Korean Power Supply Cordset (PB FR)

Standards: IEC 60884-1 (CEE 7 Standard Sheet VII)

GOST R 51322.1

K60884-1

Max. Rating: 10A, 250V

Safety Approval: VDE,EAC,KC

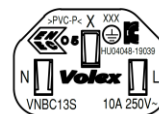
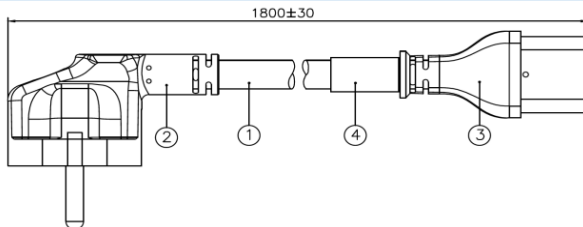
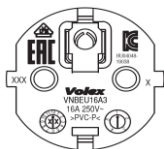

Cable Type ①	Size (mm ²)	Plug ②	Connector③
H05VV-F + K60227 IEC 53	3X0.75	VNBEU16A3	VNBC13S

Binding: 210 +/- 30 mm (No pin cap)

Label CE & ROHS: 50x25 mm

Standard Packaging: 70 pcs per box

Master Box Dimensions: 560x330x250 mm

SKU Spec Ref No: 192935/2

Generic European Powercord Set (Class I) 1.8M Black



Cat. No: SEUSD5SW18B

Description: European+Russian+Korean Power Supply Cordset (PB FR)

Standards: IEC 60884-1 (CEE 7 Standard Sheet VII)

GOST R 51322.1

K60884-1

Max. Rating: 2.5A, 250V

Safety Approval: VDE,EAC,KC

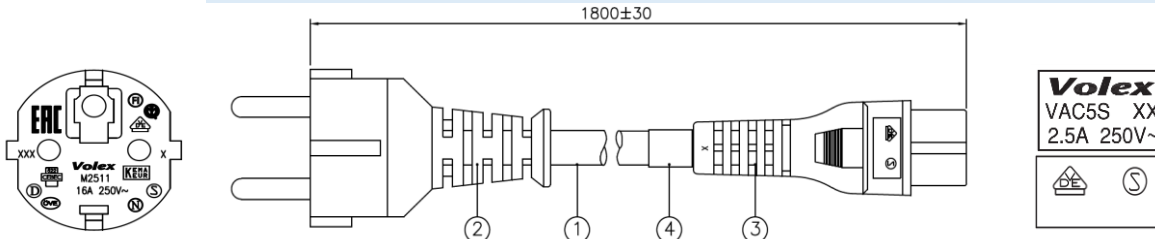

Cable Type ①	Size (mm ²)	Plug ②	Connector③
H05VV-F	3X0.75	M2511	VAC5S

Binding: 210 +/- 30 mm (No pin cap)

Label CE & ROHS: 50x25 mm

Standard Packaging: 70 pcs per box

Master Box Dimensions: 560x330x250 mm

SKU Spec Ref No: 192936/2

Generic European Powercord Set (Class I) 1.8M Black



Cat. No: SEUAD5SW18B

Description: European+Russian+Korean Power Supply Cordset (PB FR)

Standards: IEC 60884-1 (CEE 7 Standard Sheet VII)

GOST R 51322.1

K60884-1

Max. Rating: 2.5A, 250V

Safety Approval: VDE,EAC,KC

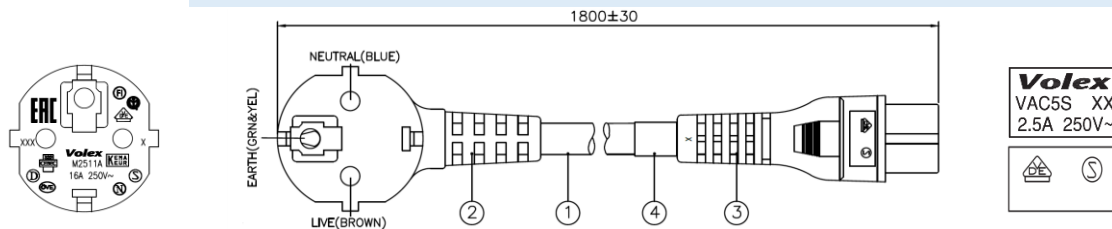

Cable Type ①	Size (mm ²)	Plug ②	Connector③
H05VV-F	3X0.75	M2511A	VAC5S

Binding: 210 +/- 30 mm (No pin cap)

Label CE & ROHS: 50x25 mm

Standard Packaging: 70 pcs per box

Master Box Dimensions: 560x330x250 mm

SKU Spec Ref No: 192937/2



Generic European Powercord Set (Class II) 1.8M Black

Cat. No: BEUSA7SW18B

Description: European Power Supply Cordset (PB FR)

Standards: IEC 60884-1 (CEE 7 Standard Sheet VII)

GOST R 51322.1

K60884-1

Max. Rating: 2.5A, 250V

Safety Approval: ENEC-VDE

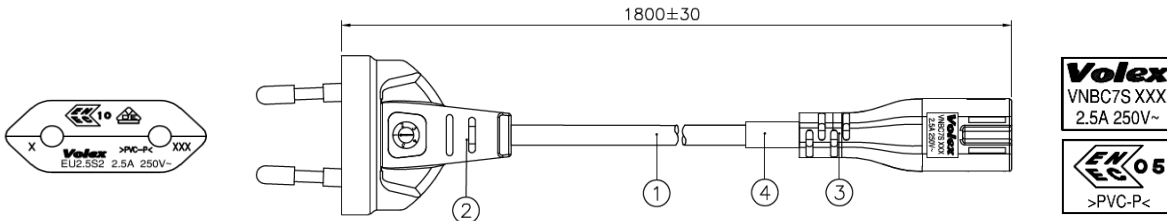

Cable Type ①	Size (mm ²)	Plug ②	Connector③
H03VVH2-F	2X0.75	EU2.5S2	VNBC7S

Binding: 220 +/- 30 mm (No pin cap)

Label CE & ROHS: 50x25mm

Standard Packaging: 180 pcs per box

Master Box Dimensions: 560x330x250 mm

SKU Spec Ref No: 192938/2



Generic European Powercord Set (Class II) 1.8M Black

Cat. No: BEUSA7SV18B

Description: European Power Supply Cordset (PB FR)

Standards: IEC 60884-1 (CEE 7 Standard Sheet VII)

GOST R 51322.1

K60884-1

Max. Rating: 2.5A, 250V

Safety Approval: ENEC-VDE

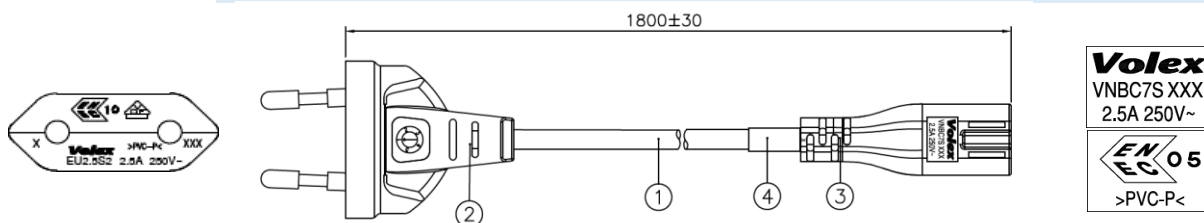

Cable Type ①	Size (mm ²)	Plug ②	Connector③
H03VVH2-F	2 x 0.50	EU2.5S2	VNBC7S

Binding: 220 +/- 30 mm (No pin cap)

Label CE & ROHS: 50x25 mm

Standard Packaging: 210 pcs per box

Master Box Dimensions: 560x330x250 mm

SKU Spec Ref No: 196638/2



Generic North-American Powercord Set (Class I) 1.8M Black

Cat. No: BUSSD3SX18B

Description: North-American Power Supply Cordset (PB FR)

Standards: UL498

UL817

CSA Std C22.2

Max. Rating: 10A, 125V

Safety Approval: UL/cUL

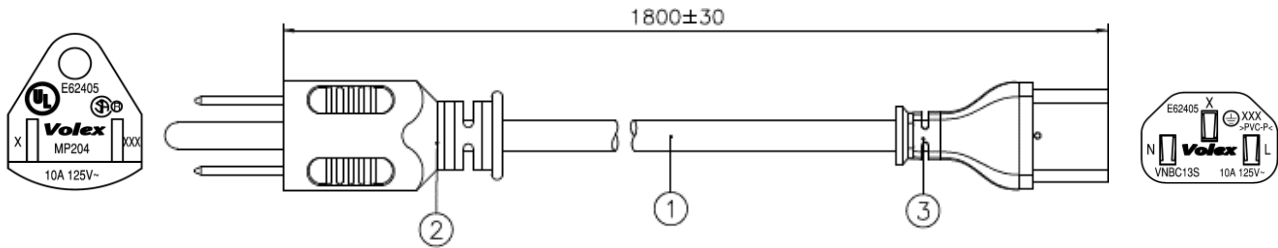

Cable Type ①	Size (mm ²)	Plug ②	Connector③
SJT	AWG 18X3	MP204	VNBC13S

Binding: 210 +/- 30 mm(w / pin cap)

Standard Packaging: 70 pcs per box

Master Box Dimensions: 560x330x250 mm

SKU Spec Ref No: 196637/2



Generic North-America Powercord Set (Class II) 1.8M BLACK

Cat. No: BUSSH7SX18B

Description: North-American Power Supply Cordset (PB FR)

Standards: UL498

UL817

CSA Std C22.2

Max. Rating: 2.5A, 125V

Safety Approval: UL/cUL

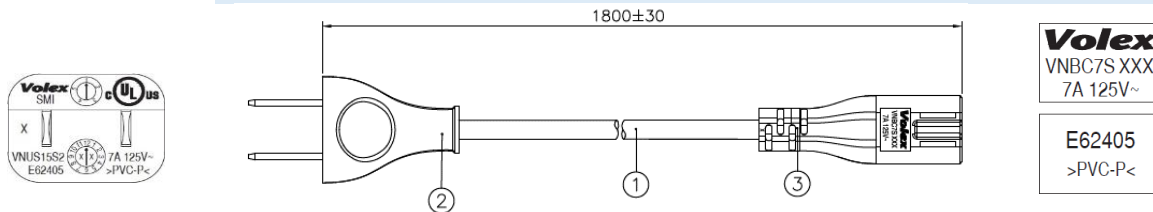

Cable Type ①	Size (mm ²)	Plug ②	Connector③
SPT-2	AWG 18X2	VNUS15S2	VNBC7S

Binding: 220 +/- 30 mm (w / pin cap)

Standard Packaging: 160 pcs per box

Master Box Dimensions: 560x330x250 mm

SKU Spec Ref No: 196840/2



Generic North-American Powercord Set (Class I) 1.8M Black

Cat. No: SUSSC5SX18B

Description: North-American Power Supply Cordset (PB FR)

Standards: UL498

UL817

CSA Std C22.2

Max. Rating: 2.5A, 125V

Safety Approval: UL/cUL

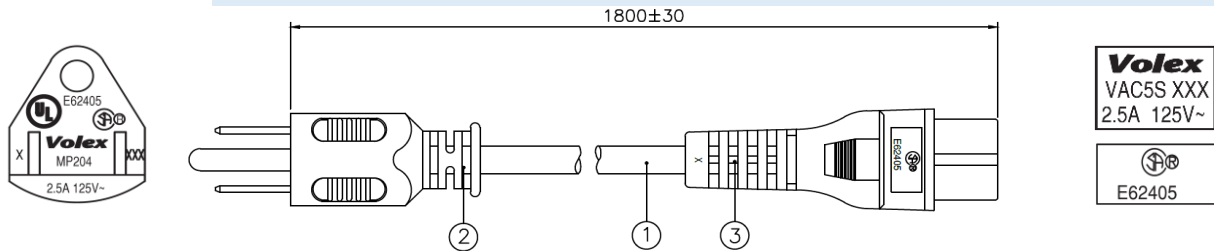

Cable Type ①	Size (mm ²)	Plug ②	Connector③
SVT	AWG 18X3	MP204	VAC5S

Binding: 210 +/- 30 mm(w / pin cap)

Standard Packaging: 90 pcs per box

Master Box Dimensions: 560x330x250 mm

SKU Spec Ref No: 196839/2



Generic N.America Hospital-Grade Powercord Set (Class I) 1.8M GREY

Cat. No: BUSSD3SY18G

Description: North-American Power Supply Cordset (PB FR)

Standards: UL498

UL817

CSA Std C22.2

Max. Rating: 13A, 125V

Safety Approval: UL/cUL

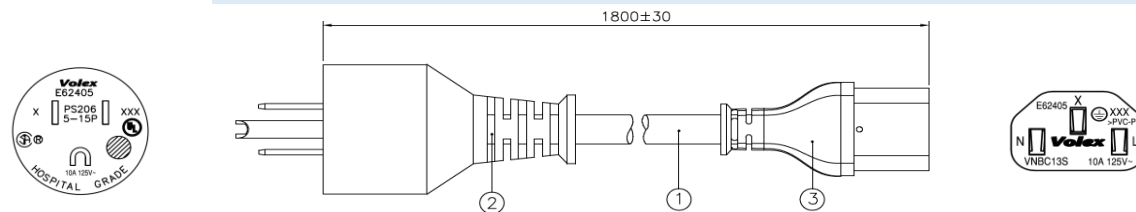

Cable Type ①	Size (mm ²)	Plug ②	Connector③
SJT	AWG 16X3	PS206	VNBC13S

Binding: 210 +/- 30 mm (w / pin cap)

Standard Packaging: 50 pcs per box

Master Box Dimensions: 560x330x250 mm

SKU Spec Ref No: 192940/2



Generic Australia Powercord Set (Class I) 1.8M Black

Cat. No: BAUSD3SX18B

Description: Australian/New Zealand Power Supply
Cordset (PB FR)

Standards: AS/NZS 3112: 2011 + A1

Max. Rating: 10A, 250V

Safety Approval: SAA

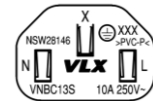
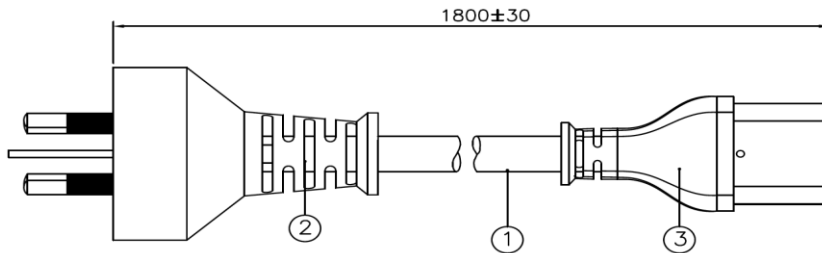
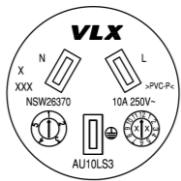

Cable Type ①	Size (mm ²)	Plug ②	Connector ③
Circular Ordinary (H05VV-F)	3X1.00	AU10LS3	VNBC13S

Binding: 210 +/- 30 mm (w/ pin cap)

Standard Packaging: 70 pcs per box

Master Box Dimensions: 560x330x250 mm

SKU Spec Ref No: 196831/2



Generic Australia Powercord Set (Class I) 1.8M BLACK

Cat. No: SAUSC5SW18B

Description: Australian/New Zealand Power Supply
Cordset (PB FR)

Standards: AS/NZS 3112: 2011 + A1

Max. Rating: 2.5A, 250V

Safety Approval: SAA

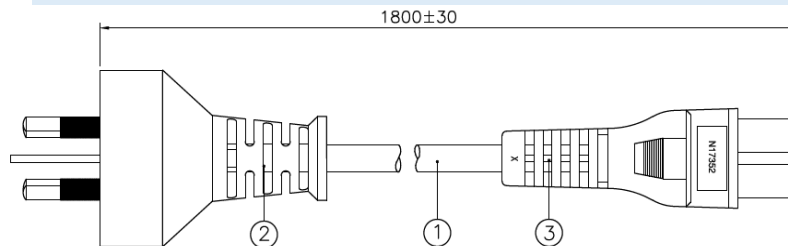
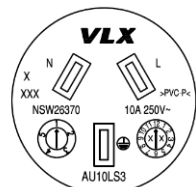

N17352

Cable Type ①	Size (mm ²)	Plug ②	Connector ③
Ordinary Duty (H03VVH2-F)	3X0.75	AU10LS3	VAC5S

Binding: 210 +/- 30 mm(w / pin cap)

Standard Packaging: 90 pcs per box

Master Box Dimensions: 560x330x250 mm

SKU Spec Ref No: 196832/2



Generic Australia Powercord Set (Class II) 1.8M Black

Cat. No: BAUSA7SW18B

Description: Australian/New Zealand Power Supply
Cordset (PB FR)

Standards: AS/NZS 3112: 2011 + A1

Max. Rating: 2.5A, 250V

Safety Approval: SAA

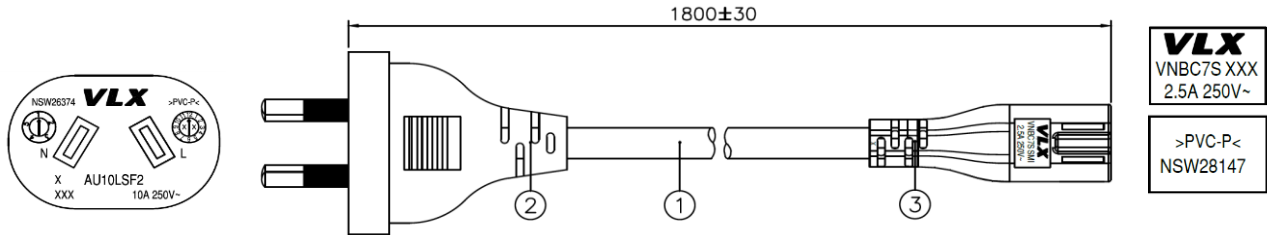

Cable Type ①	Size (mm ²)	Plug ②	Connector ③
Light Duty (H03VVH2-F)	2X0.75	AU10LSF2	VNBC7S

Binding: 220 +/- 30 mm (w / pin cap)
Standard Packaging: 150 pcs per box
Master Box Dimensions: 560x330x250 mm
SKU Spec Ref No: 196833/2



Generic Indian Powercord Set (Class I) 1.8M Black

Cat. No: BIAAD3SX18B

Description: Indian Power Supply Cordset (RoHs Compliant)

Standards: IS 1293: 2005

Max. Rating: 6A, 250V

Safety Approval: BIS

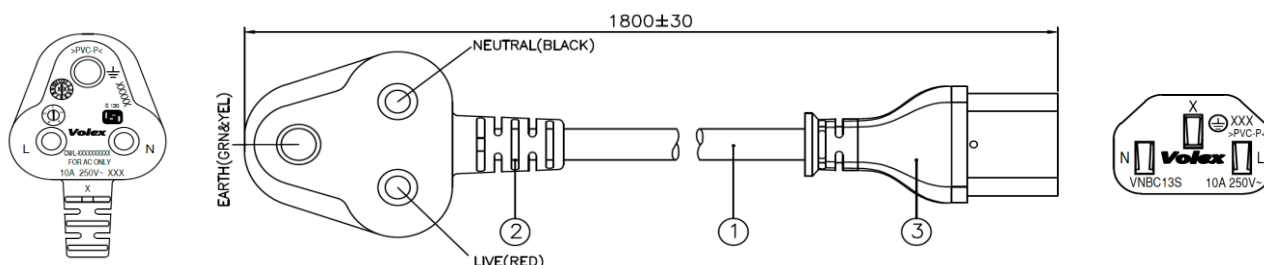

Cable Type ①	Size (mm ²)	Plug ②	Connector③
IS 694	3X1.0	IA6A3	VNBC13S

Binding: 210 +/- 30 mm (No pin cap)

Standard Packaging: 70 pcs per box

Master Box Dimensions: 560x330x250 mm

SKU Spec Ref No: 192939/2



Generic Indian Powercord Set (Class II) 1.8M BLACK

Cat. No: BIASB7SW18B

Description: Indian Power Supply Cordset (RoHs Compliant)

Standards: IS 1293: 2005

Max. Rating: 2.5A, 250V

Safety Approval: BIS

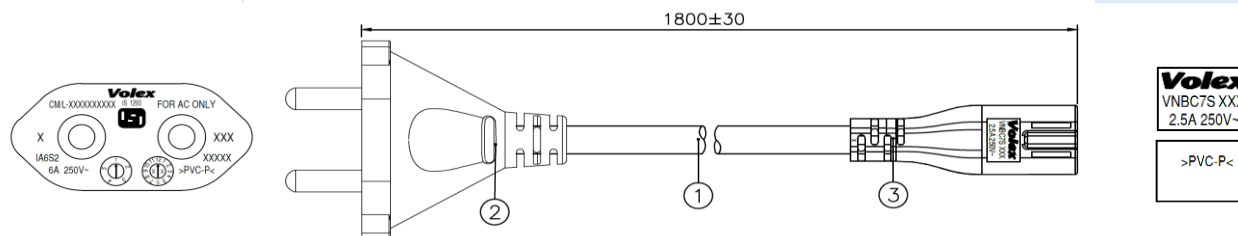

Cable Type ①	Size (mm ²)	Plug ②	Connector③
IS 694	2X0.75	IA6S2	VNBC7S

Binding: 210 +/- 30 mm (No pin cap)

Standard Packaging: 130 pcs per box

Master Box Dimensions: 560x330x250 mm

SKU Spec Ref No: 196835/2



Generic Indian Powercord Set (Class I) 1.8M Black

Cat. No: SIAAD5SW18B

Description: Indian Power Supply Cordset (RoHs Compliant)

Standards: IS 1293: 2005

Max. Rating: 2.5A, 250V

Safety Approval: BIS

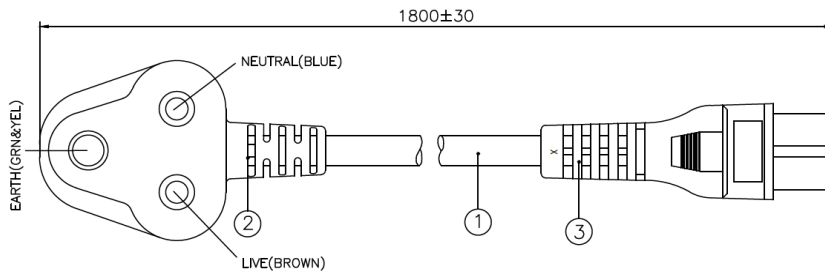
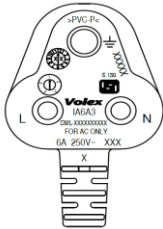

Volex
VAC5S XX
2.5A 250V~

Cable Type	Size	Plug	Connector
①	(mm ²)	②	③
IS 694	3X0.75	IA6A3	VAC5S

Binding: 210 +/- 30 mm (No pin cap)

Standard Packaging: 70 pcs per box

Master Box Dimensions: 560x330x250 mm

SKU Spec Ref No: 196834/2



Generic Japanese Powercord Set (Class I) 1.8M Black

Cat. No: BJPSC3SW18B

Description: Japanese Power Supply Cordset (PB FR)

Standards: JIS C8303 & JIS C8306 (Under Ordinance 1)

Max. Rating: 7A, 125V

Safety Approval: PSE

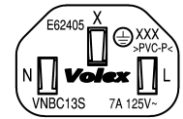
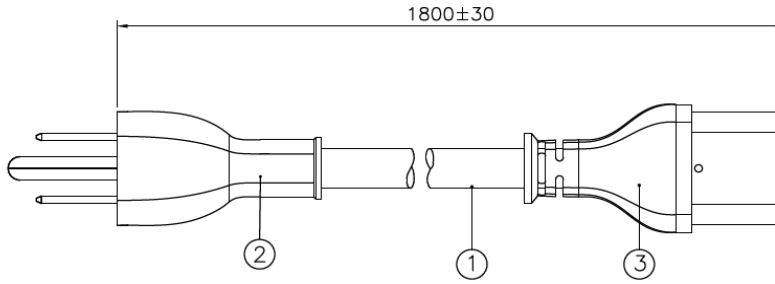
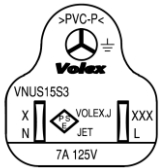

Cable Type ①	Size (mm ²)	Plug ②	Connector③
VCTF	3X0.75	VNUS15S3	VNBC13S

Binding: 210 +/- 30 mm (w / pin cap)

Standard Packaging: 90 pcs per box

Master Box Dimensions: 560x330x250 mm

SKU Spec Ref No: 196836/2

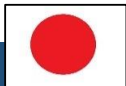

Generic Japanese Powercord Set (Class I) 1.8M BLACK

Cat. No: NJPSC5SW18B

Description: Japanese Power Supply Cordset (PB FR)

Standards: JIS C8303 & JIS C8306 (Under Ordinance 1)

Max. Rating: 7A, 125V

Safety Approval: PSE

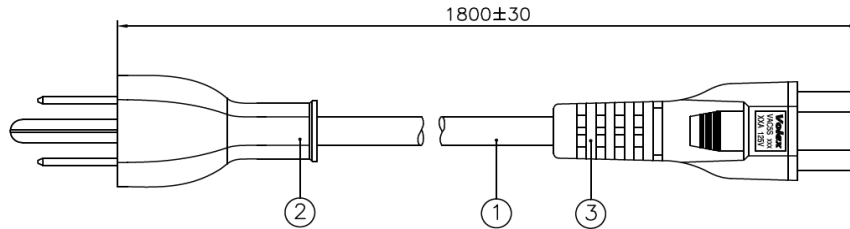

Cable Type ①	Size (mm ²)	Plug ②	Connector③
VCTF	3X0.75	VNUS15S3-V	VAC5S

Binding: 210 +/- 30 mm (w / pin cap)

Standard Packaging: 90 pcs per box

Master Box Dimensions: 560x330x250 mm

SKU Spec Ref No: 196837/2



Generic Japanese Powercord Set (Class II) 1.8M Black

Cat. No: BJPS7SW18B

Description: Japanese Power Supply Cordset (PB FR)

Standards: JIS C8303 & JIS C8306 (Under Ordinance 1)

Max. Rating: 7A, 125V

Safety Approval: PSE

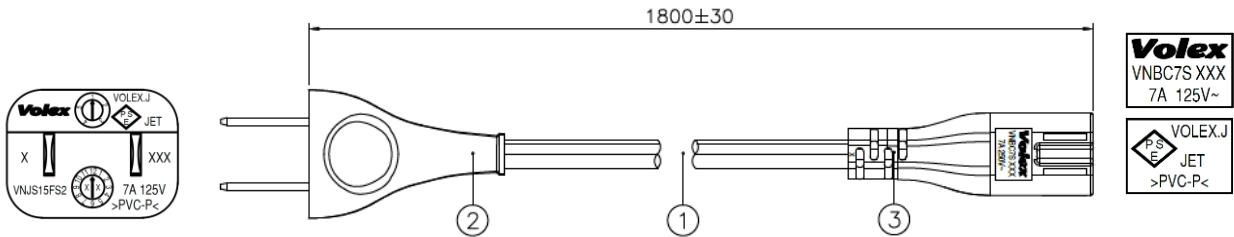

Cable Type ①	Size (mm ²)	Plug ②	Connector ③
VFF	2X0.75	VNJS15FS2	VNBC7S

Binding: 220 +/-30 mm (w / pin cap)
Standard Packaging: 210 pcs per box
Master Box Dimensions: 560x330x250 mm
SKU Spec Ref No: 196838/2



Generic South-Africa Powercord Set (Class I) 1.8M Black

Cat. No: SSAAD3SX18B

Description: South Africa Power Supply Cordset (PB FR)

Standards: SABS 164-1

(Re-designated as SANS 164-1)

Max. Rating: 10A, 250V

Safety Approval: SABS Compliant

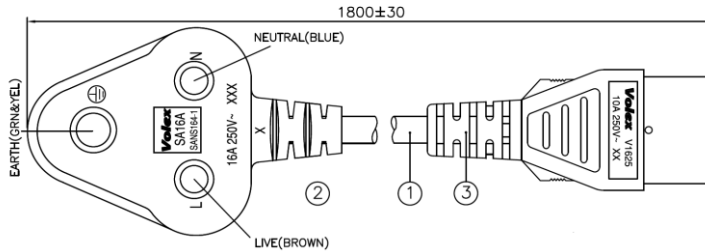
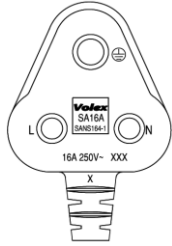

Cable Type ①	Size (mm ²)	Plug ②	Connector ③
H05VV-F	3X1.0	SA16A	V1625

Binding: 210 +/- 30 mm (No pin cap)

Standard Packaging: 50 pcs per box

Master Box Dimensions: 560x330x250 mm

SKU Spec Ref No: 192941/2



Generic Switzerland Powercord Set (Class I) 1.8M Black

Cat. No: BSWSD3SX18B

Description: Swiss Power Supply Cordset (PB FR)

Standards: IEC 60884-1 & SEV 1011
(CH type 11, Standard Sheet SEV 6533-2)

Max. Rating: 10A, 250V

Safety Approval: SEV

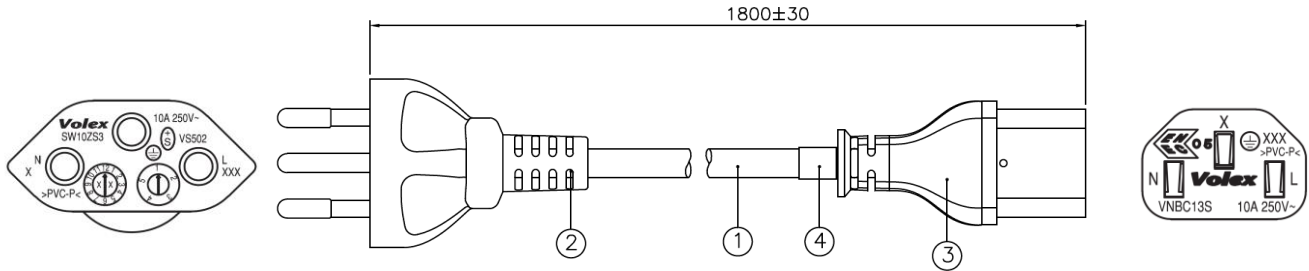

Cable Type ①	Size (mm ²)	Plug ②	Connector ③
H05VV-F	3X1.0	SW10ZS3	VNBC13S

Binding: 210 +/- 30 mm (No pin cap)

Label CE & ROHS: 25x50 mm

Standard Packaging: 80 pcs per box

Master Box Dimensions: 560x330x250 mm

SKU Spec Ref No: 192942/2



Generic Switzerland Powercord Set (Class I) 1.8M Black

Cat. No: SSWSD5SW18B

Description: Switzerland Powercord Set

Standards: IEC 60884-1 & SEV 1011
(CH type 11, Standard Sheet SEV 6533-2)

Max. Rating: 2.5AA, 250V

Safety Approval: SEV

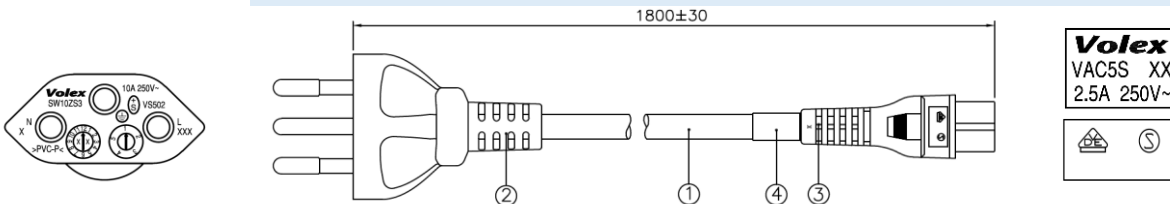

Cable Type ①	Size (mm ²)	Plug ②	Connector ③
H05VV-F	3X0.75	SW10ZS3	VAC5S

Binding: 210 +/- 30 mm (No pin cap)

Label CE & ROHS: 25x50 mm

Standard Packaging: 90 pcs per box

Master Box Dimensions: 560x330x250 mm

SKU Spec Ref No: 196841/2



Generic Switzerland Powercord Set (Class II) 1.8M Black

Cat. No: BSWSA7SW18B

Description: Switzerland Powercord Set

Standards: IEC 60884-1 & SEV 1011
(CH type 11, Standard Sheet SEV 6533-2)

Max. Rating: 2.5A, 250V

Safety Approval: SEV

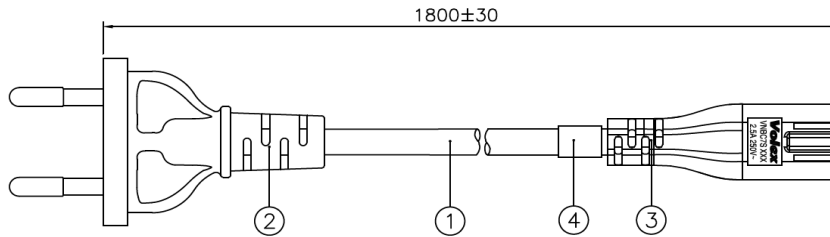
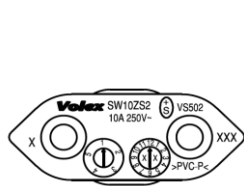

Cable Type ①	Size (mm ²)	Plug ②	Connector ③
H03VVH2-F	2X0.75	SW10ZS2	VNBC7S

Binding: 220 +/- 30 mm (No pin cap)

Label CE & ROHS: 25x50 mm

Standard Packaging: 170 pcs per box

Master Box Dimensions: 560x330x250 mm

SKU Spec Ref No: 192943/2



Generic Jumper Cordset Set (Class I) 1.8M Black

Cat. No: BJ1S3SX18B

Description: European Power Supply Cordset (PB FR)

Standards: IEC 60320-2-2

EN 60320-2-2 - Stand Sheet E

Max. Rating: 10A, 250V

Safety Approval: ENEC

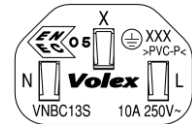
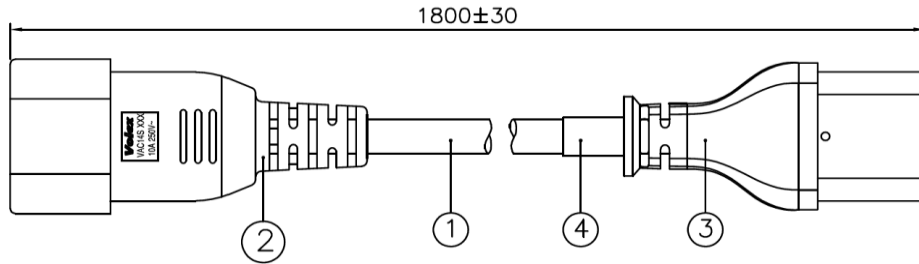
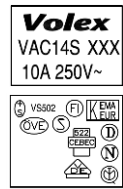

Cable Type ①	Size (mm ²)	Plug ②	Connector ^③
H05VV-F	3X0.75	VAC14S	VNBC13S

Binding: 210 +/- 30 mm (No pin cap)

Label CE & ROHS: 50x25 mm

Standard Packaging: 80 pcs per box

Master Box Dimensions: 560x330x250 mm

SKU Spec Ref No: 202120

Generic Powercord Set Configurator

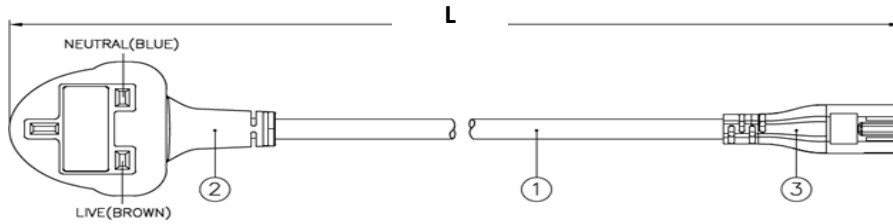

S/N	Description
3	Connector
2	Plug
1	Cable
L	Over-all Length

Material	HAR/EN (EU)	UL	PSE	CCC	KS	BIS
A	H03VVH2-F	NI SPT-1	VCTFK	60227 IEC 52 (RVV) 300/300 Flat	60227 KS IEC 52	
B	H05VVH2-F	NI SPT-2		60227 IEC 53 (RVV) 300/500 Flat	60227 KS IEC 53	IS 694 (Flat)
C	H03VV-F	SVT	VCTF	60227 IEC 52 (RVV) 300/300 Round	60227 KS IEC 52	
D	H05VV-F	SJT		60227 IEC 53 (RVV) 300/500 Round	60227 KS IEC 53	IS 694 (Round)
E	H03VH-Y	-	-	-	-	
F	H03V2V2-F	-	HVCTF	-	-	
G	H05V2V2-F	-	-	-	60227 KS IEC 57	
H	-	SPT-2	VFF	-	-	
I	H05RR-F	SJ	-	60245 IEC 53 (YZ) 300/500	60245 KS IEC 53	
J	-	-	-	60245 IEC 66 (YC) 450/750	-	
K	H05RN-F	SJO	-	60245 IEC 57 (YZW) 300/500	60245 KS IEC 57	
L	H07RN-F	-	-	60245 IEC 66 (YCW) 450/750	-	
M	Figure 8 Rubber	-	HPN	HVFF	-	
N	Round Textile	H03RT-H	-	-	60245 IEC 51 (RX) 300/300	-
O	Combo Cable	H05VV-F	SJT/SVT	IEC-J	60227 IEC 53 (RVV) 300/500	60227 KS IEC 53

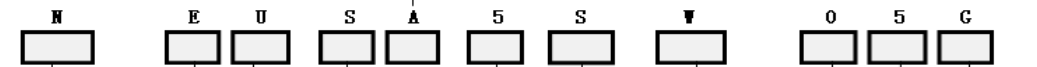

- Product**
B: V-Novus Hybrids
H: Hospital Grade
L: V-Lock
N: V-Novus
P: Halogen Free
S: Standard
- Country**
AR: Argentina
AU: Australia
BR: Brazil
GB: China
DM: Denmark
GC: Gulf Countries
EU: Europe
HK: Hong Kong
IA: India
IT: Italy
JS: Japan
KR: Korea
RU: Russia
SA: South Africa
SD: Saudi Arabia
SG: Singapore
SI: Israel
SW: Switzerland
TW: Taiwan
UK: United Kingdom
US: North America
J1: Jumper Cord
C14
J2: Jumper Cord
C20
- Plug Version**
S: Straight
A: Angled
- Connector**
1: C1
5: C5
7: C7
3: C13
6: C15
8: C17
9: C19
C: Blunt Cut
S: Sheath and Stripped
B: Sheath and Blunt Cut
T: Terminals
G: Grommet
- Connector**
Version
S: Straight
R: Right Angled
L: Left Angled
D: Down Angled
- Conductor**
Size
- Cable Length**
05: 0.5 m
10: 1.0 m
12: 1.2 m
15: 1.5 m
18: 1.8 m
20: 2.0 m
25: 2.5 m
30: 3.0 m
- Cord Set Color**
B: Black
U: Blue
N: Green
G: Grey
O: Orange
R: Red
W: White

Letter	Max. Current Rating	HAR/EN (EU) mm ²	UL AWG (mm ²)	JIS mm ²	CCC mm ²	BS mm ²
V	3A	0.5 (2.5A)	20 (0.62)	-	0.5	0.5
W	6A	0.75	-	0.75 (7A)	0.75	0.75
X	10A	1.0	18 (0.82)	1.25	1.0	1.0
Y	12A	-	16 (1.23)	1.25	-	1.25 (13A)
Z	16A	1.5	14 (1.95)	2.0	1.5	1.5 (13/15A)
A	20A	2.5 (25A)	12 (3.31)	3.5	-	-
B	30A	-	10 (5.26)	-	-	-
C	40A	-	8 (8.37)	-	-	-