



METER

AQUALAB® SERIES 4



TABLE OF CONTENTS

1. Introduction.....	1
2. Operation	2
2.1 Installation	2
2.2 Sample Preparation	3
2.2.1 Sample Composition.....	4
2.2.2 Sample Temperature.....	6
2.3 Taking a Reading	7
2.4 Viewing Data	9
2.5 Using Moisture Content (AQUALAB DUO Only).....	10
2.5.1 Obtaining Product Isotherm Models	11
2.5.2 Loading and Organizing Product Isotherm Models.....	11
2.5.3 Measuring Moisture Content	12
2.5.4 Moisture Content Model Offset.....	14
2.5.5 Restore Moisture Content Default Settings	17
2.5.6 Deleting Models.....	19
3. System.....	21
3.1 Specifications.....	21
3.2 Components	22
3.2.1 Cords and Cables	23
3.2.2 Sample Chamber.....	23
3.2.3 Buttons	24
3.2.4 Display Screen	25

3.3 Computer Interface.....	36
3.3.1 AquaLink 4 Software.....	36
3.3.2 Using a Terminal Program	37
3.4 Theory.....	37
3.4.1 Moisture Content	37
3.4.2 Water Activity	38
3.4.3 Chilled-Mirror Dew Point Limitations.....	41
3.4.4 Water Potential	41
3.4.5 Sorption Isotherms	41
4. Service.....	43
4.1 Verification and Calibration	43
4.1.1 Water Activity Verification	43
4.1.2 Linear Offset	46
4.1.3 Multipoint Calibration (TEV Only).....	48
4.1.4 Restore Factory Defaults	51
4.2 Cleaning.....	52
4.2.1 Cleaning Kit	53
4.2.2 AQUALAB 4TEV Special Considerations	53
4.2.3 Cleaning Procedure.....	53
4.3 Maintenance Packages	55
4.4 Repair	55
4.5 Troubleshooting	56
4.6 Customer Support.....	59
4.7 Terms and Conditions	60
Reference.....	61
Index	62

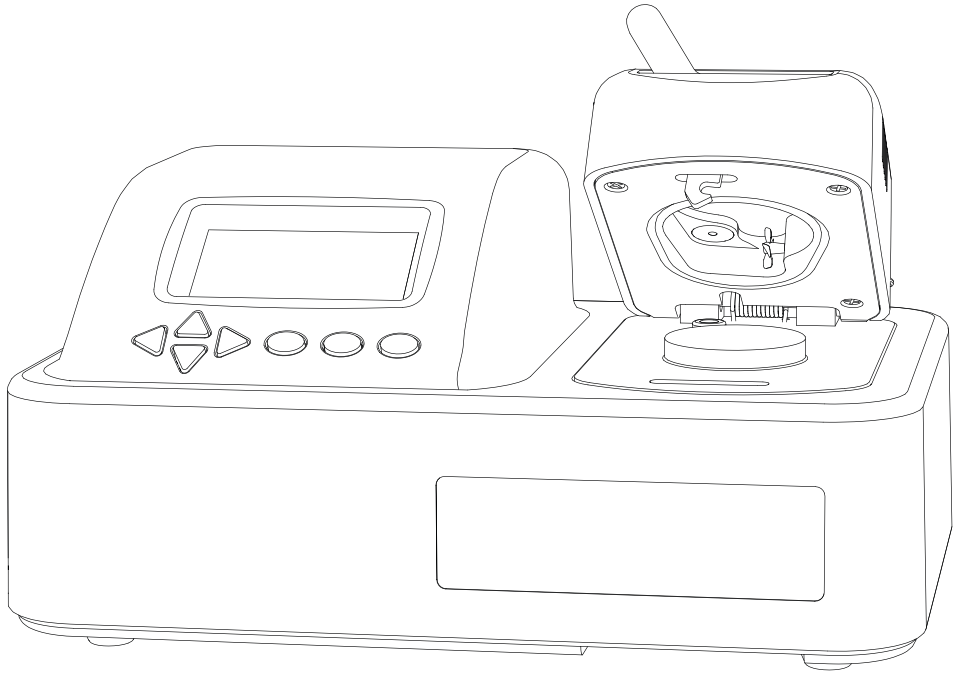

1. INTRODUCTION

Thank you for choosing the AQUALAB® 4 Series Water Activity Meter from METER Group. AQUALAB is the most accurate and most reliable instrument available for measuring water activity (a_w).

The AQUALAB 4 Series includes four models:

- AQUALAB 4TE uses a chilled-mirror dew point sensor and thermoelectric (Peltier) components to maintain a user-selectable internal temperature.
- AQUALAB 4TEV uses both a chilled-mirror dew point sensor and a capacitance sensor for measuring nonvolatile and volatile substances, respectively. Either sensor is selected using the instrument menu system.
- AQUALAB 4TE DUO uses a chilled-mirror dew point sensor and programmed models obtained from isotherm data to give the user both water activity and moisture content simultaneously in 5 min or less.
- AQUALAB 4TEV DUO uses both a chilled-mirror dew point sensor or capacitance sensor as well as programmed models obtained from isotherm data to give the user both water activity and moisture content simultaneously for samples containing both nonvolatile and volatile substances.

This manual includes instructions for setting up, verifying the calibration, preparing samples, taking readings, and maintaining AQUALAB instruments.

Verify all instrument contents shipped and appear in good condition:

- AQUALAB Water Activity Meter
- Calibration certificate
- Power cord
- USB A to USB B cable
- 50 disposable sample cups
- AQUALAB Cleaning Kit
- Two vials each of the following verification solutions:
 - 0.760 a_w 6.00 mol/kg NaCl
 - 0.500 a_w 8.57 mol/kg LiCl
 - 0.250 a_w 13.41 mol/kg LiCl

2. OPERATION

Please read all instructions before operating the AQUALAB to ensure it performs to its full potential.

Please observe the following considerations carefully.

- Only allow personnel qualified by METER to carry out service work on the electrical components.
- Never remove the cover of the instrument. There are no parts inside the housing that can be serviced or replaced by the user.

WARNING: There is a risk of damaging the instrument or of causing serious injury if live components are touched.

- Only operate this instrument with a main power voltage specified (100 to 240 V AC).
- Plug the instrument into a grounded outlet or power strip.
- Only use the fuse type and rating specified for this instrument ([Section 3.1](#)).

If the instrument is used in a manner not specified by the manufacturer, the protection provided by the equipment may be impaired.

PRECAUTIONS

METER sensors are built to the highest standards, but misuse, improper protection, or improper installation may damage the sensor and possibly void the manufacturer's warranty. Before integrating AQUALAB into a system, follow the recommended installation instructions and arrange proper protections to safeguard the instrument from damage.

2.1 INSTALLATION

Follow the steps listed in [Table 1](#) to set up the AQUALAB.

Table 1 Installation

Preparation	<p>Select Clean, Level Location</p> <p>Select a location where the temperature remains fairly stable to avoid temperature changes that can affect accuracy (away from air conditioner and heater vents, open windows, etc.).</p> <p>Observe clean practices to prevent contamination of the sample chamber.</p> <p>Maintain a level surface to reduce the chance of spilling sample material and contaminating the sample chamber.</p>
--------------------	---

Table 1 Installation (continued)

Installation	<p>Plug In Instrument Plug the power cord into the back of the AQUALAB unit and into an outlet.</p> <p>Only use the supplied power cord or one rated for AQUALAB 4 and certified for the country of use. The cord must be a minimum of 18 AWG and have a rating for 10 A or greater.</p> <p>WARNING: An incorrect main power voltage can damage the instrument.</p> <p>Turn the Unit ON. Allow the AQUALAB a 15-min warm-up period to ensure accurate readings.</p>
---------------------	--

2.2 SAMPLE PREPARATION

Proper sample preparation is important to keep the AQUALAB clean and achieve repeatable results. Carefully prepare and load samples to lengthen time between cleanings and help avoid downtime. Be consistent in sample preparation methods (e.g., crush, grind, slice the sample) to obtain reproducible results.

More specific considerations regarding sample composition and sample temperature are discussed in [Section 2.2.1](#) and [Section 2.2.2](#), respectively.

Follow the steps listed below to prepare samples:

1. Make sure the sample to be measured is homogeneous.
Multicomponent samples (e.g., muffins with raisins) or samples that have outside coatings (like deep-fried, breaded foods) can be measured, but they need to have representative portions in the cup and may take longer than other sample types to equilibrate.
2. Place the sample in a disposable sample cup.
 - a. Completely cover the bottom of the cup, if possible, to provide enough sample to get an accurate reading.
The AQUALAB is able to accurately measure a sample that does not (or cannot) cover the bottom of the cup. For example, raisins only need to be placed in the cup and do not need to be flattened to cover the bottom.
A larger sample surface area increases instrument efficiency by providing more stable infrared sample temperatures. It also speeds up the reading by shortening the time needed to reach vapor equilibrium.
 - b. Do not fill the sample cup more than half full.
Overfilled cups can contaminate the chamber and do not make the readings faster or more accurate.
3. Wipe any excess sample material from the rim and outside of the sample cup with a clean KIMWIPES® tissue.

Material left on the rim or the outside of the cup can contaminate the chamber and be transferred to subsequent samples.

4. If a sample cannot be measured immediately, put the disposable sample cup lid on the cup to restrict water transfer.

For longer term storage of no more than 4 h, seal the lid by placing tape or Parafilm® laboratory film completely around the cup to lid junction.

2.2.1 SAMPLE COMPOSITION

The nature of some samples results in longer reading times. These materials may need additional preparation to ensure accurate readings. Contact [Customer Support](#) for questions on sample composition.

Use the following steps to determine if further sample preparation is necessary:

1. Take several readings of the sample to see if the readings (a_w and time) stabilize ([Section 2.3](#)).
2. If the readings take less than 6 min to stabilize, the sample can be handled normally. If the readings take longer than 6 min, remove the sample and take a reading of a verification standard ([Section 4.1.1](#)).
3. If the verification standard takes less than 6 min to test, the sample itself is causing the long read time. Refer to the following sections for pertinent sampling considerations. If the verification standard also takes longer than 6 min to test, the chamber may be dirty and will need to be cleaned ([Section 4.2](#)). Retest the sample after cleaning the chamber.

2.2.1.1. COATED AND DRIED SAMPLES

Samples with high sugar or fat coatings often require multiple readings, because it equilibrates very slowly with the sample chamber.

Crush or slice the sample before sampling to reduce the time needed to take a water activity reading for coated or dried samples. This increases the surface area of the sample, thus decreasing reading times. However, modifying some samples may alter their water activity readings.

For example, a candy may have a soft chocolate center and a hard outer coating. The water activity reading for the center and the outer coating are different, so one would need to evaluate which part of the sample needed to be measured before crushing it. When the candy is crushed, the water activity represents the average water activity of the entire sample; whereas leaving the candy whole gives a reading for the coating, which may act as a barrier to the center.

To reduce test time when testing whole samples, see [Section 3.2.4.2](#) to set Low-Emitting mode.

2.2.1.2. LOW WATER-EMITTING SAMPLES

Some extremely dry, dehydrated, highly viscous, water-in-oil emulsions (e.g., butter), high fat, or glassy compositions may require multiple readings because of their slow water-emitting properties. This is because the slow emission of water decreases the change in water activity sufficiently that the instrument determines the test to be complete, even though changes in water activity are still occurring.

The most effective way to test these types of samples is to run them in the AQUALAB using Continuous or Custom mode and wait for the water activity readings to stabilize.

For faster reading, it is important to have the relative humidity of the chamber at or below the water activity of these types of samples. This causes the sample to release water to the vapor phase and equilibrate with the chamber. If the relative humidity of the headspace is greater than the water activity of the sample, the sample will require a long period of time to reach equilibrium.

To reduce test time when testing low water-emitting samples, see [Section 3.2.4.2](#) to set Low-Emitting mode.

2.2.1.3. VOLATILE SAMPLES

Samples with certain volatiles in high enough concentrations may give inaccurate water activity values in the AQUALAB 4TE and AQUALAB 4TE DUO models. Volatiles condense on the mirror during the reading process but do not evaporate from the mirror as water does. As a result, the reading on samples with volatiles may not be accurate. The concentration of volatiles that causes interference is variable and matrix dependent.

The AQUALAB 4TEV measures volatiles such as propylene glycol and ethanol. The AQUALAB 4TEV contains both a chilled-mirror dew point and a capacitance sensor. The capacitance sensor has a lower accuracy of $\pm 0.015 a_w$ than the dew point sensor, which has an accuracy of $\pm 0.003 a_w$.

To determine if volatiles are a problem, compare dew point readings to capacitance readings. If the dew point readings are $>0.018 a_w$ higher than the capacitance readings, volatiles are likely a problem and the AQUALAB 4TEV, AQUALAB 4TEV DUO, or AQUALAB TDL will need to be used for the sample.

After measuring volatiles with the capacitance sensor, clean the chamber ([Section 4.2](#)), place charcoal in the chamber, and seal for a minimum of 5 min before switching to the dew point sensor.

2.2.1.4. LOW WATER ACTIVITY

A sample's water activity value may be below the cooling capacity of the AQUALAB. The AQUALAB will display an error message indicating the lowest reading it attained on that particular sample. The AQUALAB may also give the error message even if the sample is not below $0.03 a_w$. [Section 4.5](#) provides possible solutions to the error message.

If a sample has a water activity of $<0.03 a_w$, a $<$ symbol in the Measurement tab indicates the sample is too dry to be accurately measured by the AQUALAB (Figure 1).



Figure 1 Low water activity reading

If the measured a_w appears lower than the known sample water activity, the instrument sensors may have been contaminated and need to be cleaned or serviced (Section 4.2).

2.2.2 SAMPLE TEMPERATURE

The ambient temperature of the AQUALAB should be between 4 and 50 °C. The AQUALAB 4TE and AQUALAB 4TEV have internal temperature control capabilities that enable them to read samples at temperatures different from the ambient temperature, but no higher than 50 °C and no lower than 4 °C.

Samples that are more than 4 °C colder or warmer than the instrument chamber temperature need to equilibrate to instrument temperature before taking a reading, ideally within 1 or 2 °C of the chamber temperature. Rapid changes in temperature over short periods of time causes the water activity readings to rise or fall until the temperature stabilizes. Proceed with normal measurements when the temperature stabilizes within an optimal 1 or 2 °C of the chamber temperature.

High water activity samples that are warmer than the chamber temperature can cause condensation inside the measuring chamber, which adversely affects subsequent readings. A warning message appears if the sample temperature is more than 4 °C above chamber temperature (Figure 2).

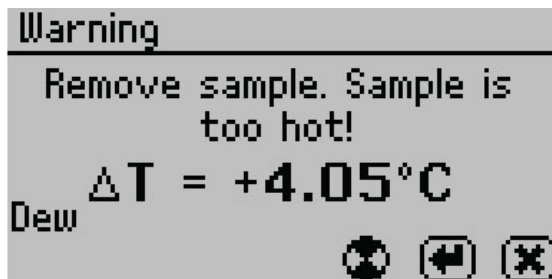

Figure 2 Sample is too hot! message

If this error message appears,

1. Remove the sample from the instrument.
2. Place a lid on the cup.
3. Allow the sample to cool to within 4 °C of the instrument before measuring.

To check the differences in temperature between the sample and the chamber prior to beginning a reading, set the sample in the chamber, close the lid without latching it, and press the **RIGHT** or **LEFT** button. [Figure 3](#) provides an example of this screen.

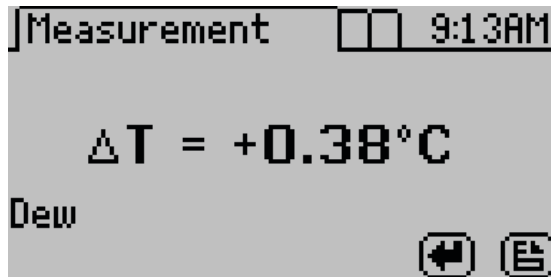

Figure 3 Temperature difference between sample and sample chamber

2.3 TAKING A READING

The AQUALAB provides readings in 5 min or less. Readings are reliable, providing $\pm 0.003 a_w$ accuracy.

CAUTIONS

- Never leave a sample in the AQUALAB after a reading has been taken. The sample may spill and contaminate the instrument chamber if the instrument is accidentally moved or jolted.
- Never move the instrument after a sample has been loaded. Movement may cause the sample material to spill and contaminate the sample chamber.
- Do not measure a sample that has a temperature greater than ± 4 °C than the AQUALAB chamber ([Section 2.2.2](#)). Remove the sample until it is at room temperature.

NOTE: After measuring volatiles with the capacitance sensor, clean the chamber ([Section 4.2](#)), place charcoal in the chamber, and seal for a minimum of 5 min before switching to the dew point sensor.

Perform the following steps to take a reading.

1. Ensure the AQUALAB is plugged in and turned on.
The splash screen will appear, followed by the main Measurement tab ([Section 3.2.4.1](#)).
2. For AQUALAB DUO instruments ([Section 2.5](#)), use the **UP** and **DOWN** buttons to scroll through all available product models that may be used ([Figure 4](#)).
The moisture content value adjusts based on the selected model.

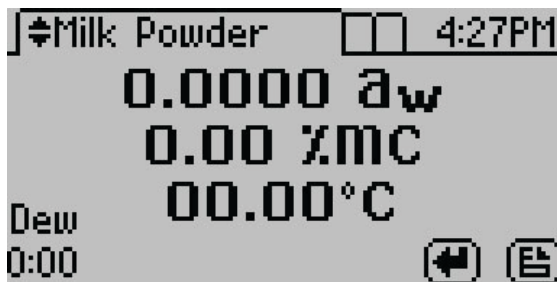

Figure 4 Measurement screen for AQUALAB DUO Milk Powder product model

3. Verify cleanliness (Section 4.2), calibration (Section 4.1), and sample preparation (Section 2.2).

NOTE: The device fan can blow powdery substances; always verify the cleanliness of the sample chamber before reading a new sample.

4. Move the chamber lever to the OPEN position and lift the chamber lid.
5. Check the top lip and outside surfaces of the sample cup to ensure they are free from sample residue and confirm the sample cup is not overfilled.

NOTE: Overfilling the sample cup may contaminate the chamber sensors.

The sample cup lid must be removed for correct functionality.

6. Place the prepared sample cup in the chamber.
7. Close the chamber lid.
8. Move the lever to the READ position to seal the sample chamber. The reading will automatically start.

In 1 to 2 min, the first measurement will display on the screen (this is an intermediate reading). The instrument crosses the dew threshold numerous times to ensure equilibrium and the accuracy of readings. Length of read times may vary depending on temperature differences between the chamber and the sample as well as on other properties of the sample (Section 2.2). The default AQUALAB reading cycle continues until the rates of change of three consecutive intermediate readings are $<0.0005 a_w$ of each other.

When the instrument has finished its read cycle, results will display. The **SAVE** icon replaces the spinning measurement icon, and, if enabled, a series of beeps sounds. The results will include the water activity, read time, temperature, and, for AQUALAB DUO instruments (Section 2.5), moisture content for the selected product model (Figure 5).

NOTE: Autosave only saves the moisture content value of the model selected at the end of the reading. Overwrite the autosave by selecting the correct model using the UP and DOWN buttons and selecting SAVE.

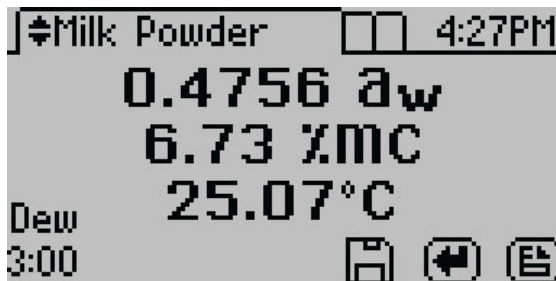

Figure 5 Completed test results with both water activity and moisture content

9. Autosave (default setting) retains the data without any annotation (Section 3.2.4.2). To add an annotation, select **SAVE**, add desired letters, and select **SAVE** again (Figure 6).



Figure 6 Keyboard screen to annotate data results

2.4 VIEWING DATA

To view prior test results, use the following steps:

1. Press **MENU** to navigate to the Data tab (Figure 7).

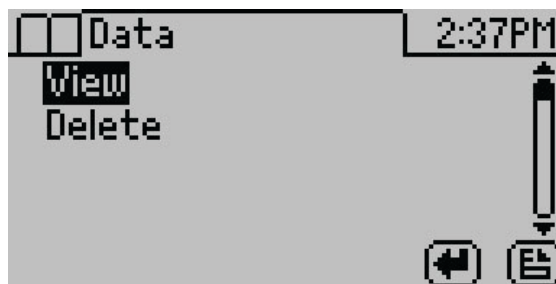

Figure 7 Data tab

2. Select **ENTER**.
3. Scroll through the list of saved tests using **UP** and **DOWN** (to move one item at a time) or **RIGHT** and **LEFT** (to move a page at a time).

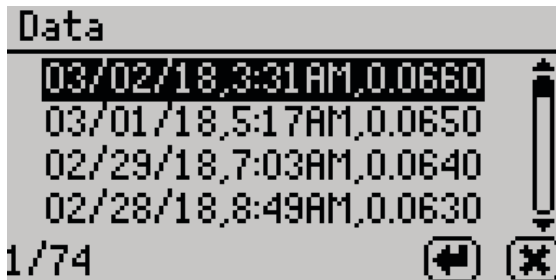

Figure 8 List of saved tests

4. Select **ENTER**.

The detailed test results screen will appear (Figure 9). Tests can also be scrolled through using the arrow buttons on this detailed screen.

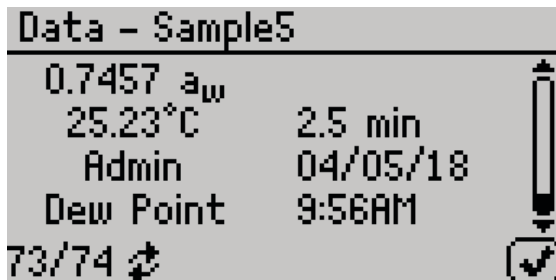

Figure 9 Detailed test results screen

5. Select **OK** to return to the list of tests.
6. Select **CANCEL** to return to the Data tab.

2.5 USING MOISTURE CONTENT (AQUALAB DUO ONLY)

The relationship between water activity and moisture content is called the moisture sorption isotherm, and it is complex and unique to each product type.

AQUALAB DUO models generate water activity values and moisture content. The DUO models use preloaded product-specific isotherm models to calculate moisture content and present it on the screen with the water activity (Figure 10). The AQUALAB 4TE and AQUALAB 4TEV can be upgraded to an AQUALAB 4TE DUO and AQUALAB 4TEV DUO, respectively.

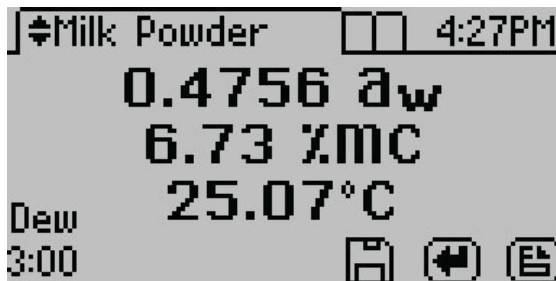

Figure 10 AQUALAB DUO display with water activity and moisture content readings

2.5.1 OBTAINING PRODUCT ISOTHERM MODELS

The isotherm relationship for each product is unique, and each product isotherm model must be determined experimentally prior to testing moisture content with the AQUALAB DUO.

There are several strategies that can be used to generate models. Please contact [Customer Support](#) for information on model development.

2.5.2 LOADING AND ORGANIZING PRODUCT ISOTHERM MODELS

A product model must be loaded onto the AQUALAB DUO before it can calculate moisture content. Models can be loaded onto the instrument by METER or by using the AquaLink 4 software ([Section 3.3.1](#)). As many as 100 models can be stored on the instrument.

The AquaLink 4 software uses a model loading tool to add and remove product models from the AQUALAB DUO, allowing the user to control and organize product models.

The following steps explain how to load new models:

1. Download AquaLink 4 software from metergroup.com/aqualab4te-support onto a computer.
2. Save the model files onto the same computer.
3. Open AquaLink software.
4. Connect the AQUALAB to the computer using the USB cord (or an RS-232 cord).
5. Turn the AQUALAB on.
6. In the AquaLink window, select the appropriate COM port from the dropdown menu.
7. Click Connect.
When the instrument is connected, the button will change to Disconnect.
8. Click Models.

OPERATION

The Model Manager window will show all current models (Figure 11). If no models have been loaded, the window will be empty.

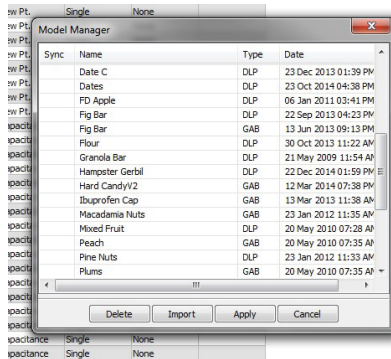

Figure 11 AquaLink 4 model loading tool

9. Click Import.
10. Navigate to the model saved on the computer and select.
Each model will need to be imported individually. The models should now show up in the Model Manager window.
11. Click in the Sync box next to each model name that will be uploaded to the AQUALAB.
12. Click Apply.
13. After a few seconds, use **UP** and **DOWN** on the AQUALAB instrument to test if the instrument can scroll through the new models (visible at the top of the Measurement tab). The display screen should also have a placeholder for moisture content measurements.
14. In the AquaLink window, click Disconnect.
15. Close the AquaLink program.
16. Unplug the AQUALAB from the computer.

2.5.3 MEASURING MOISTURE CONTENT

With product models loaded onto the instrument, the AQUALAB DUO can generate moisture content and water activity simultaneously while taking a reading.

1. Press **MENU** to navigate to the Configuration tab (Figure 12).

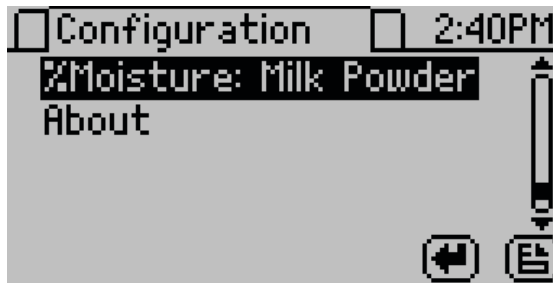

Figure 12 Changing moisture content model on the Configuration tab

2. Select %Moisture.

A list of available models appears, organized by name (Figure 13).

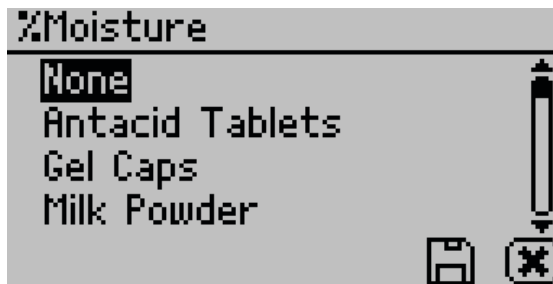

Figure 13 Product models for moisture content

3. Select the model for the product to be analyzed.
If the listed models do not apply, select None. No moisture content will appear on the Measurement tab.
4. Select **SAVE**.
5. Navigate to the Measurement tab.
6. Take a reading (Section 2.3).

The moisture content measurement (%MC) will appear below the water activity measurement (Figure 14) in the test results.

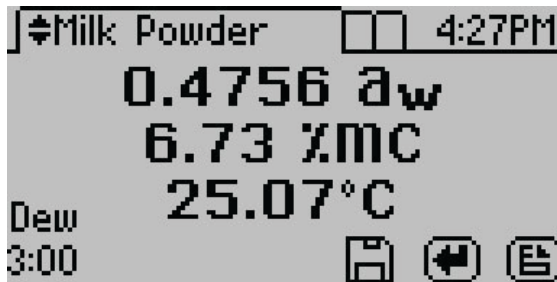

Figure 14 AQUALAB DUO display with water activity and moisture content readings

2.5.4 MOISTURE CONTENT MODEL OFFSET

The AQUALAB DUO calculates moisture content values based on water activity readings by utilizing models stored within the instrument. Because moisture content results vary between reference methods, it is important to ensure that the model in the instrument correlates well with the values obtained from the selected reference method (e.g., Karl Fischer titration or oven loss on drying). Moisture content differences among various methods are usually linear and can be easily corrected with a linear offset. Therefore, if moisture contents calculated with the AQUALAB DUO instrument are not agreeing with the reference method, the problem can likely be addressed by adjusting a linear offset.

Reference methods can differ between laboratories, so check for a linear offset upon receipt of a new isotherm model from METER. In addition, the linear offset should be adjusted if moisture contents calculated by the AQUALAB DUO instrument are consistently higher or lower for a product than reference method values over several samples.

The following steps describe how to adjust for linear offset or how to create a new model based off an old model:

1. Ensure the instrument is verified ([Section 4.1](#)).
2. Collect three subsamples of the product for analysis.
3. Place one subsample into a sample cup ([Section 2.2](#)).
4. Cover sample cup with a lid to limit exposure to ambient conditions.
5. Use the reference method to determine the average moisture content of the other two subsamples.
6. On the AQUALAB, press **MENU** to navigate to the Configuration tab.
7. Select Calibration.
8. Select %Moisture from the list of calibration types ([Figure 15](#)).

NOTE: If %Moisture is not an option, the instrument may not be an AQUALAB DUO. Contact [Customer Support](#).

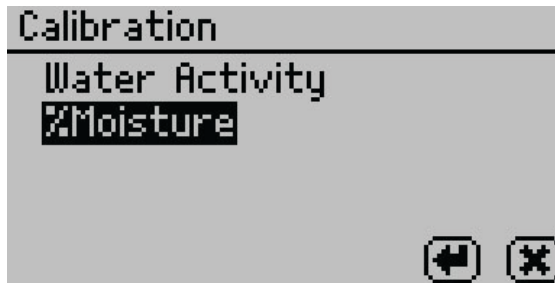

Figure 15 Select %Moisture on the Calibration tab

The %Moisture Calibration screen will appear (Figure 16).

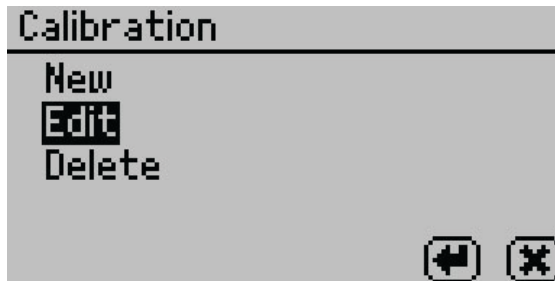

Figure 16 %Moisture Calibration screen

9. If creating an existing model, select New.
If editing an existing model, select Edit.
10. Scroll through the reference models for the desired product (Figure 17).

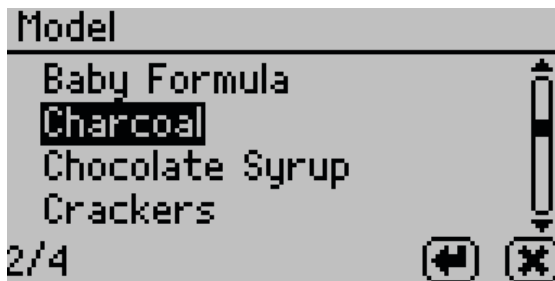

Figure 17 Moisture content model list

11. Select ENTER.
12. Select Start (Figure 18).

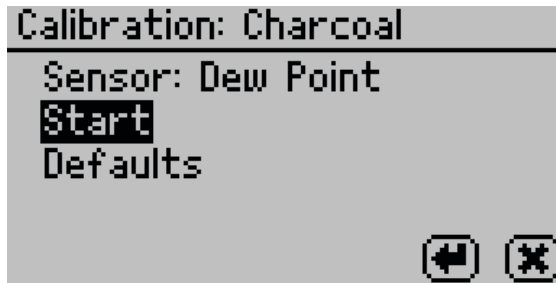

Figure 18 Start test

13. Place a sample in the sample chamber when prompted (Figure 19).

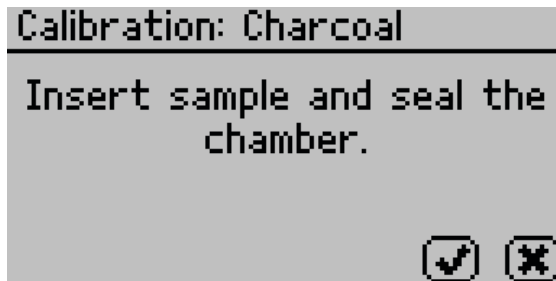

Figure 19 Prompt to place sample in chamber

14. Remove the lid from the sample cup prepared in [step 3](#) and place into the chamber.
15. Close and latch the lid.
16. Select **OK** to begin a reading.
Once the reading is complete, the measured water activity as well as the moisture content based on the target model will display on the screen.
17. Adjust the moisture content value using **UP** and **DOWN** until it matches the average moisture content value obtained from the reference method in [step 5](#) (Figure 20).

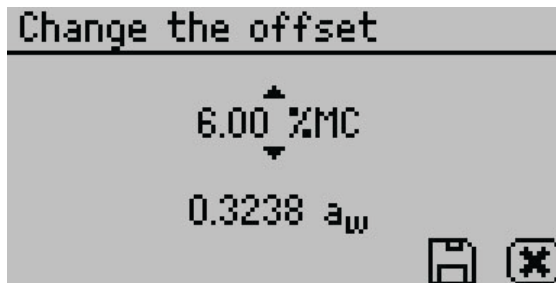

Figure 20 Adjust the moisture content value to match the reference method

18. Select **SAVE**.

19. If editing an existing model, the model will update but automatically retain the same name.

If creating a new model, enter a new name on the Annotation screen.

Select **CANCEL** to return to the Configuration tab and cancel the moisture content adjustment.

20. Air out the chamber for at least 1 h.

21. Measure the sample again in normal sampling mode. The AQUALAB DUO should now read the corrected moisture content value provided in [step 17](#).

If moisture content readings are still inconsistent with the reference method, contact [Customer Support](#).

2.5.5 RESTORE MOISTURE CONTENT DEFAULT SETTINGS

To restore the original model settings, use the following steps:

1. Press **MENU** to navigate to the Configuration tab.
2. Select Calibration.
3. Select %Moisture from the list of calibration types ([Figure 21](#)).

NOTE: If %Moisture is not an option, the instrument may not be an AQUALAB DUO. Contact [Customer Support](#).

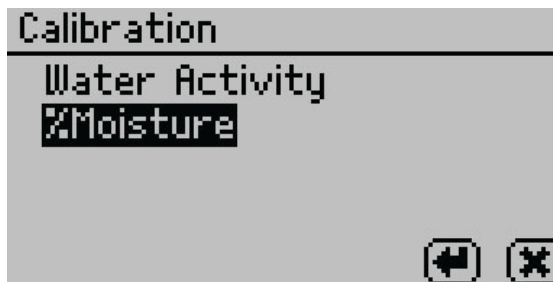

Figure 21 List of calibration types

4. Select Edit ([Figure 22](#)).

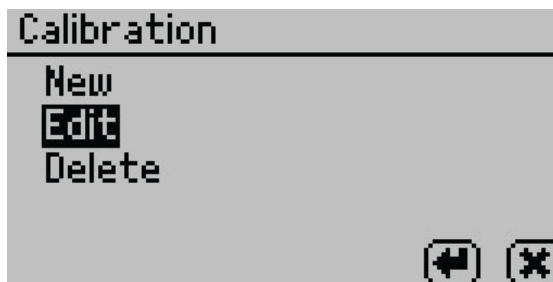

Figure 22 Select Edit

5. Select the desired model (Figure 23).

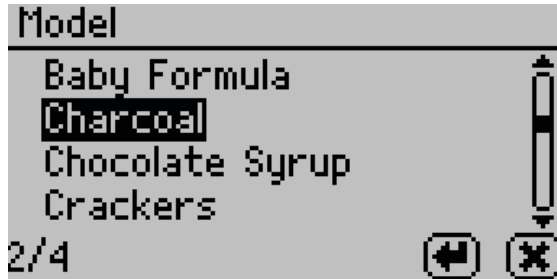

Figure 23 Moisture content model list

6. Select Defaults (Figure 24).

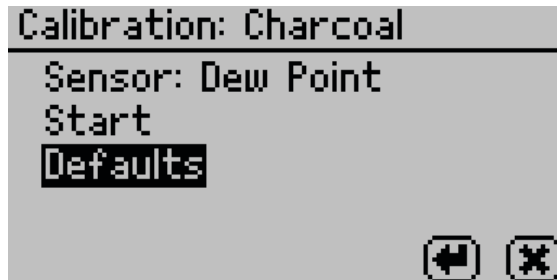

Figure 24 Default options

A confirmation dialog will appear (Figure 25).

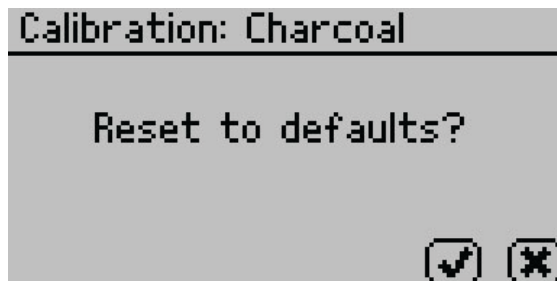

Figure 25 Confirmation dialog to reset calibration to defaults

7. To restore the original model settings, select **OK**.
 To cancel and return to the Calibration tab, select **CANCEL**.
 A screen will confirm the restoration of factory calibration (Figure 26).

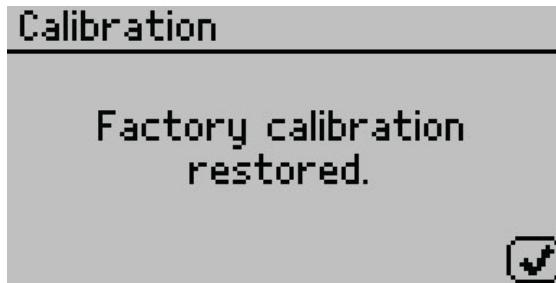

Figure 26 Confirmation dialog that AQUALAB was reset to factory calibration

8. Select **OK** to return to the Configuration tab.

2.5.6 DELETING MODELS

If a model is no longer needed, it can be deleted directly from the AQUALAB. Models are not user-specific, so if a model is deleted from the instrument, all users will lose access to it.

NOTE: Deleted models cannot be recovered from AQUALAB. Use AquaLink 4 to back up models.

1. Press **MENU** to navigate to the Configuration tab.
2. Select **Calibration**.
3. Select **%Moisture** from the list of calibration types (Figure 27).

NOTE: If **%Moisture** is not an option, the instrument may not be an AQUALAB DUO. Contact [Customer Support](#).



Figure 27 Calibration screen listing calibration types

4. Select **Delete**.
5. Select the desired model from the list (Figure 28).
Select **CANCEL** to return to the %Moisture Calibration screen.

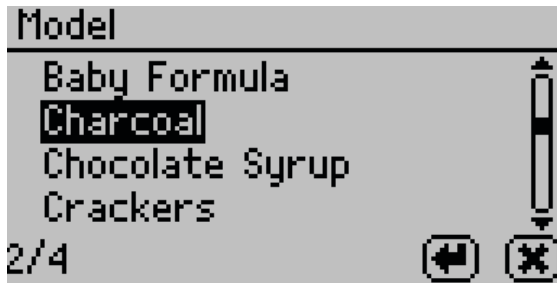

Figure 28 Moisture content model list

A confirmation screen will appear indicating the model to be deleted (Figure 29).

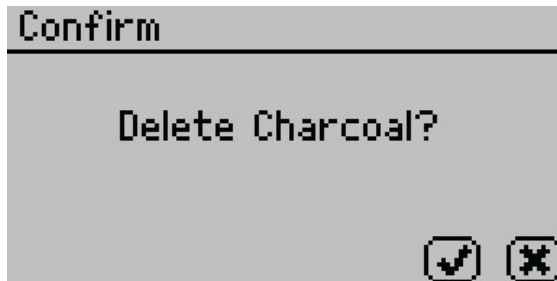

Figure 29 Confirmation dialog to delete model

6. Select **OK** to delete the model.
Select **CANCEL** to return to the previous screen.

3. SYSTEM

This section describes the specifications, components, and theory of the AQUALAB instrument.

3.1 SPECIFICATIONS

MEASUREMENT SPECIFICATIONS

Water Activity

Range	0.030–1.000 a_w
Resolution	0.0001 a_w
Accuracy	±0.003 (4TE dew point) ±0.015 (4TEV capacitance)
Repeatability	0.001 a_w

Moisture Content (DUO only)

Accuracy	0.1%–0.5% to moisture content reference
Repeatability	0.02%

Temperature

Range	15–50 °C
Resolution	0.01 °C
Accuracy	±0.1 °C

Read Time

~5 min

PHYSICAL SPECIFICATIONS

Case Dimensions

Length	26.7 cm (10.5 in)
Width	17.8 cm (7.0 in)
Height	12.7 cm (5.0 in)

Case Material

POLYLAC PA-765 (ABS) with fire retardant

Sample Cup Capacity

14 mL (0.47 fl oz)

Weight

3.1 kg (6.8 lb)

Display

64 × 128 graphical

Operating Temperature

Minimum 4 °C

Typical NA

Maximum 50 °C

Operating Environment

0%–90% noncondensing

Data CommunicationsUSB A and RS-232 serial
9,600–115,000 baud**Power**110–220 VAC
50/60 Hz**COMPLIANCE**

Manufactured under ISO 9001:2015

EM ISO/IEC 17050:2010 (CE Mark)

3.2 COMPONENTS

The AQUALAB uses the chilled-mirror dew point technique to measure the water activity of a sample. In an instrument that uses the dew point technique, the sample is equilibrated with the headspace of a sealed chamber that contains a mirror and a means of detecting condensation on the mirror. At equilibrium, the relative humidity of the air in the chamber is the same as the water activity of the sample.

The AQUALAB DUO models make it possible to determine both moisture content and water activity with one machine. For information about upgrading an AQUALAB 4TE or 4TEV to a DUO, contact [Customer Support](#).

The AQUALAB main components include the display screen and sample chamber ([Figure 30](#)).

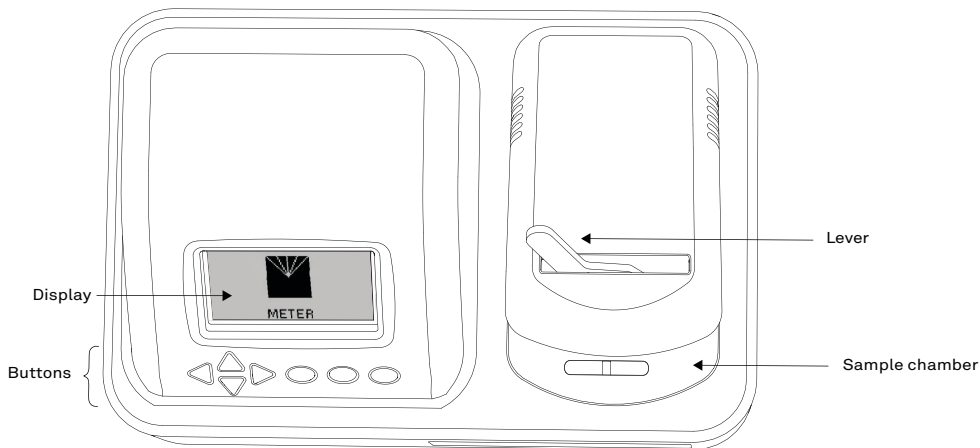

Figure 30 AQUALAB exterior

3.2.1 CORDS AND CABLES

The AQUALAB is shipped with a power cord and a USB cable.

The power cord plugs into the back of the instrument and must be plugged into a grounded outlet or power strip.

WARNING: Only use the supplied power cord or one rated for AQUALAB 4 and certified for the country of use. The cord must be a minimum of 18 AWG and have a rating for 10 A or greater.

The USB cable has one USB A connector to connect to a computer and one USB B connector to connect to the AQUALAB. The data from the AQUALAB can be saved to the computer with this connection ([Section 3.3.1](#)).

The AQUALAB may also be connected to a computer using a RS-232 serial cable (not included).

3.2.2 SAMPLE CHAMBER

Externally, the sample chamber lever has two positions: OPEN (handle moved to the right) and READ (handle moved to the left).

Internally, there are two blocks within the sample chamber: an upper lid block and a lower sample block ([Figure 31](#)). The blocks are temperature controlled and regulate the temperature of the sample and sample chamber.

The mirror temperature is precisely controlled by a thermoelectric (Peltier) cooler. Detection of the exact point condensation first appears on the mirror is observed with a photoelectric cell. A beam of light is directed onto the mirror and reflected into a photo detector cell. The photo detector senses the change in reflectance when condensation occurs on the mirror. A

SYSTEM

thermocouple attached to the mirror then records the temperature at which condensation occurs. The AQUALAB then signals with beeps and displays the final water activity and temperature.

The AQUALAB uses an internal fan to circulate the air within the sample chamber to reduce equilibrium time. Since the AQUALAB measures both dew point and sample surface temperatures simultaneously, it eliminates the need for complete thermal equilibrium, thereby reducing measurement times to <5 min for most samples.

Additionally, the AQUALAB 4TEV uses a capacitance humidity sensor to measure the water activity of a sample. The sensor is suspended in the headspace of the chamber and uses a special polymer material sandwiched between two microporous electrodes to sense humidity changes. The sensor measures a specific capacitance, which is translated by the software and displayed as water activity on the instrument screen. At equilibrium, the relative humidity of the air in the chamber is the same as the water activity of the sample.

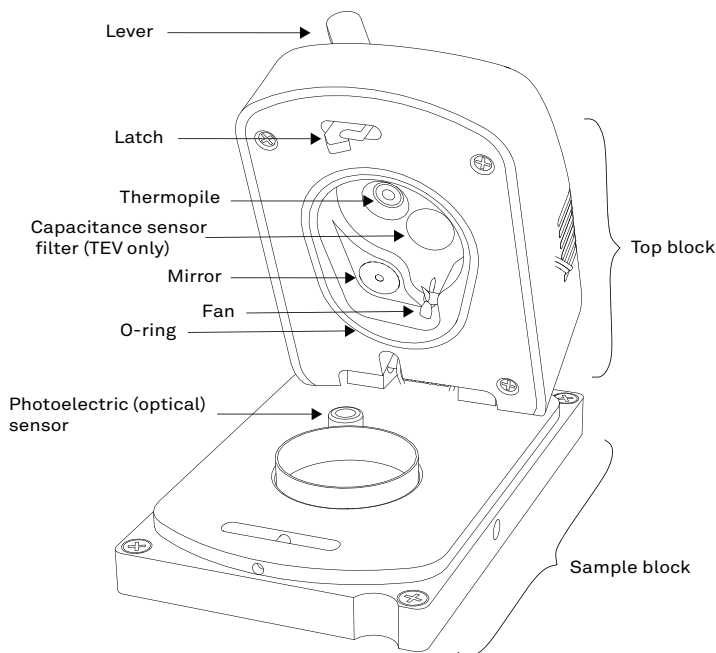

Figure 31 Sample chamber interior

3.2.3 BUTTONS

The power switch is located on the lower left corner of the AQUALAB back panel. After being turned on, the AQUALAB should warm up for 15 minutes before operation to ensure accurate readings.

There are four arrow buttons: **LEFT**, **RIGHT**, **UP**, and **DOWN** (Figure 32). These buttons allow for navigation through the various screens on the AQUALAB. The three round buttons have variable uses, depending on what icon is represented above them on the display (Section 3.2.4).

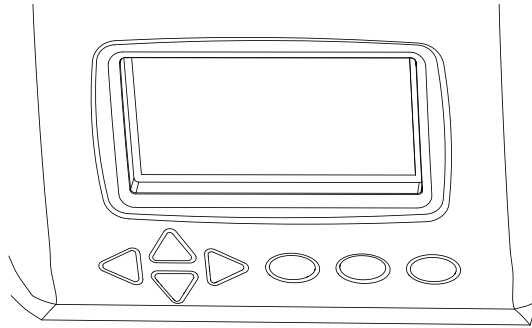

Figure 32 AQUALAB buttons under the display screen

3.2.4 DISPLAY SCREEN

The display screen (Figure 33) has three tabs: Measurement, Configuration, and Data.

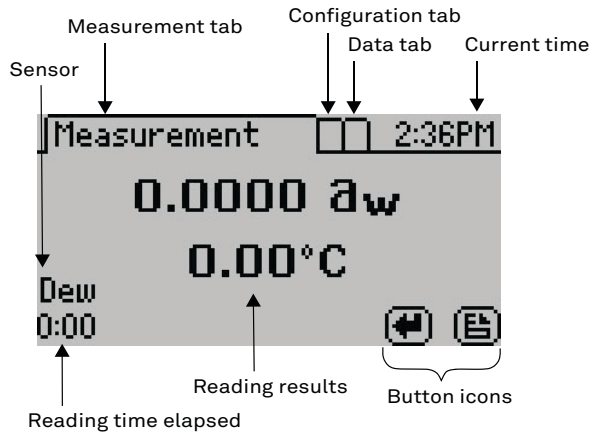









Figure 33 Display screen

The button icons on the display change to show the available actions for the screen ([Table 2](#)).

Table 2 AQUALAB button icons

Icon	Name	Action
	ENTER	Accepts the current action
	CANCEL	Ends the current action
	MENU	Switches between the Measurement, Configuration, and Data tabs
	SAVE	Saves a setting or a reading
	OK	Accepts the input from the user
	AUDIO OFF	Silences beeping
	AUDIO ON	Enables beeping

3.2.4.1. MEASUREMENT TAB

The Measurement tab ([Figure 34](#)) is the main screen and must be visible to start a reading. Measurement results are displayed on this screen.

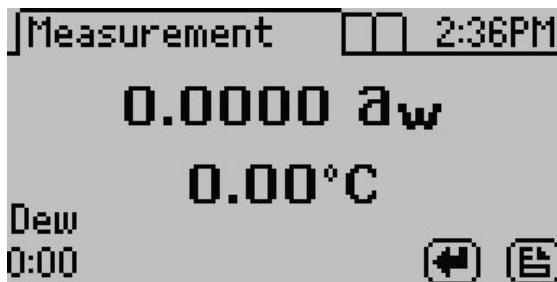

Figure 34 Measurement tab

Using the **RIGHT** or **LEFT** buttons changes the display to a temperature equilibration screen ([Figure 35](#)). This screen shows the temperature difference between the sample and the lid.

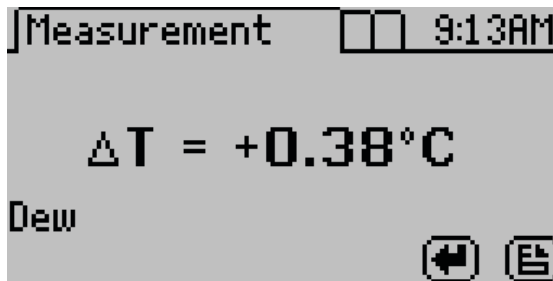

Figure 35 Temperature difference between sample and lid

On AQUALAB DUO models, using the **UP** or **DOWN** buttons changes the results according to the models loaded onto the instrument.

The main screen shows the water activity in the middle of the screen and above the sample temperature. The measurement read time is shown at the bottom left of the screen. The AQUALAB 4TEV model will display either **DEW** or **CAP** indicating whether the dew point or capacitance sensor is being used.

3.2.4.2. CONFIGURATION TAB

The Configuration tab provides a menu of configuration options (Figure 36). Use **UP** and **DOWN** to move the selection through the various configuration options or **LEFT** and **RIGHT** to page through the options. Use **ENTER** to select the highlighted option.

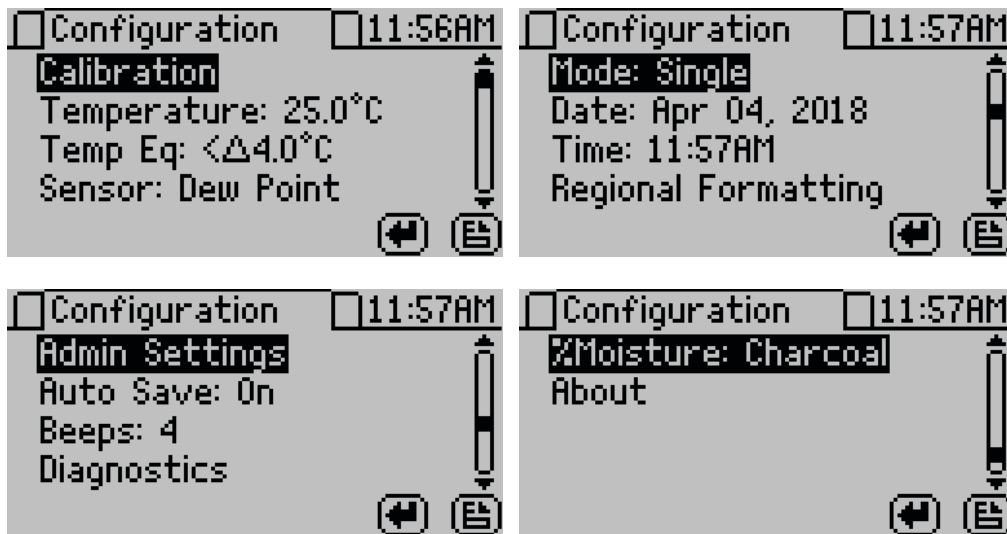

Figure 36 Configuration tab screens

- **Calibration.** Select to start the calibration process ([Section 4.1](#)) for water activity or moisture content ([Figure 37](#)). Resetting factory defaults is described in [Section 4.1.4](#).



Figure 37 Calibration option

- **Temperature.** Select to set the AQUALAB to the desired temperature using **UP** and **DOWN**. When finished, select **SAVE** ([Figure 38](#)).

The AQUALAB 4TE models may be set between 15 and 50 °C in 0.1 °C intervals. The default temperature is 25 °C.

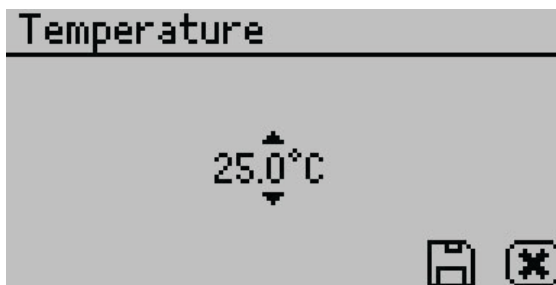

Figure 38 Temperature option

- **Temp Eq.** Select to set the acceptable temperature difference between the sample block and the sample before starting a water activity measurement ([Figure 39](#)).

The range is 0.1 to 4.0 °C. A setting of 4.0 °C begins the measurement when the sample is <4.0 °C above or below the block temperature. A setting of 0.1 °C begins the measurement when the sample is <0.1 °C above or below the block temperature.



Figure 39 Temp Eq screen

- **Sensor (AQUALAB 4TEV only).** Select to choose a capacitance sensor or chilled-mirror dew point sensor for sampling volatiles or nonvolatiles, respectively. The AQUALAB 4TE model only has a dew point option.
- **Mode.** Select to choose between Single, Continuous, ISO 18787, Custom, or Low-Emitting mode (Figure 40). The current mode settings appear at the top of the screen with the number of tests appearing first, followed by the stability value (Δa_w).

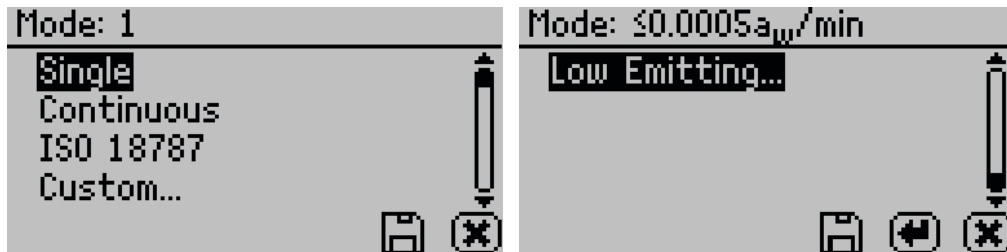

Figure 40 Custom mode options

- ♦ Single mode reads the sample once.
- ♦ Continuous mode reads the sample until the chamber lid is opened or the test is stopped by selecting **CANCEL**.

The AQUALAB reads the sample, displays results, and begins another read cycle without further action from the user. The machine signals the completion of each reading with a beep. A timer on the screen tracks the cumulative read time.

All readings taken during Continuous mode are saved on the instrument memory if the autosave feature is turned on (default). If the AQUALAB is connected to a computer using AquaLink 4 (Section 3.3.1), all readings can be downloaded to the AquaLink 4 software.

- ♦ ISO 18787 mode reads the sample until the water activity change is equal to or less than $0.0003 a_w$ /min per minute.
- ♦ Custom mode reads a sample multiple times until a set level of stability is achieved. For example, the instrument could be set to read the sample until two consecutive tests are within $\pm 0.001 a_w$ of each other.

Use **RIGHT** and **LEFT** to change between the Readings or Δa_w settings.

Use **UP** and **DOWN** to change to select the number of readings (2 to 9).

Use **UP** and **DOWN** to select the Δa_w value (any number from 0.0003 to 0.0400) (Figure 41).

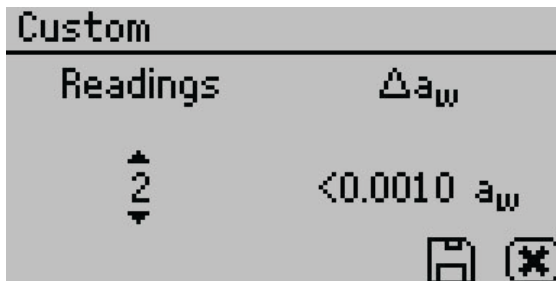

Figure 41 Custom mode screen

Select **SAVE** to update and exit. Select **CANCEL** to exit without updating. The Mode screen reappears with the updated custom settings at the top of the screen.

If autosave is turned on (default), all test readings will save to the instrument memory, but only the final reading will remain on the Measurement screen. If the AQUALAB is connected to a computer using AquaLink 4 (Section 3.3.1), AquaLink 4 downloads all readings taken during a Custom mode test.

- ♦ Low-Emitting mode gives the option of speeding up test time by adjusting the equilibrium trigger value (Figure 42).

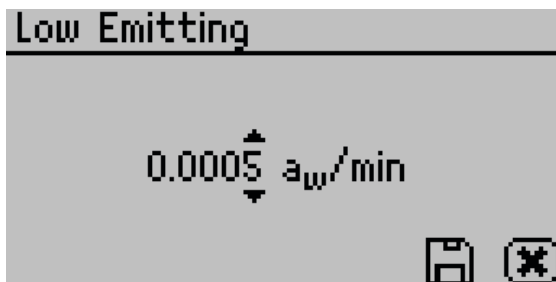

Figure 42 Low-Emitting mode screen

AQUALAB determines vapor equilibrium at the end of a test by comparing sequential water activity values, looking for a trigger value difference of $\leq 0.0005 a_w/\text{min}$. This value can be adjusted to any value between 0.0003 and 0.0060 a_w/min . Increasing the trigger value causes a subsequent reduction in instrument accuracy and precision but results in a shorter test time. This mode is for samples that are slow to equilibrate, such as vegetable oils, high-fat samples, and high-viscosity samples. In these types of cases, the loss in performance may be acceptable in order to speed up the analysis time. Use a high trigger value only after careful consideration of the impact on test results.

NOTE: The computation for Low-Emitting mode has changed between AQUALAB firmware versions. To compare low-emitting measurements across instruments with different versions, set low-emitting value in versions using a_w/min to twice the value of the low-emitting setting in a_w .

- ♦ **Date.** Select to set the date in the instrument. Use **RIGHT** and **LEFT** to change between the month, day, and year categories and **UP** and **DOWN** to change the individual values (Figure 43).

The date is recorded with each water activity reading.



Figure 43 Date option

- **Time.** Select to set the time in the instrument. Use **RIGHT** and **LEFT** to change between the hour and minute categories and **UP** and **DOWN** to change the individual values (Figure 44). The hour setting automatically changes between AM and PM.

The time is recorded with each water activity reading.



Figure 44 Time option

- **Regional Formatting.** Select to configure how the AQUALAB displays information. Choose the temperature scale (Celsius or Fahrenheit), the date display (mm/dd/yy or dd/mm/yy), the hour format (12h or 24h), and the language (Figure 45).

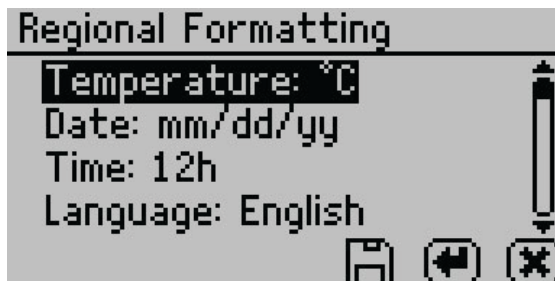

Figure 45 Regional Formatting option

- **Admin Settings.** Select to create an administrator password as well as create, edit, and delete additional users (Figure 46).



Figure 46 Admin Settings option

The Admin Settings allow the administrator to grant or block access to some or all the configuration options.

NOTE: Once the administrator is set up, the password cannot be recovered. The AQUALAB must be sent back to METER to be reset.

Administrators can add, edit, or delete users from the User Setup screen. The keyboard allows for lowercase, uppercase, and accented letters (Figure 47).



Figure 47 Keyboard screen

NOTE: User setup is not required for instrument operation. It is for users requiring 21 CFR Part 11 compliance or who want to save specific settings.

Once the administrator and users are set up, an Access option will appear on individual user screens (Figure 48).



Figure 48 Access option on a user screen

To lock out users from accessing certain settings, enter the Access function and use **UP** and **DOWN** to find the desired option. Selecting the option will toggle it ON or OFF: calibration, temperature, temperature equilibration, sensor selection, mode, date/time, region, password, autosave, number of beeps, and delete (Figure 49). These options can also be all locked or unlocked at the same time.



Figure 49 Access settings first screen

- **Autosave.** Select to turn Autosave on or off. Autosave stores water activity readings within the instrument automatically for every water activity reading in the internal memory. The AQUALAB can store up to 8,000 records before the memory is full.

Any individual reading may be saved manually right after completing the test and before beginning the next test, regardless of the Autosave setting.

NOTE: If a reading is autosaved, it is not possible to give it an annotation later.

- **Beeps.** Select to change the number of notification beeps for a finished test (four, continuous, or no beeps). The audible notification can also be turned off.
- **Diagnostics.** Select to view information regarding pertinent sensors.

For the chilled-mirror dew point sensor, the Diagnostics option provides lid, base, sample and mirror temperatures, optical voltage, and the user offset. Figure 50 shows typical values for the sensors. Lid, base, and sample temperatures may fluctuate but should not change more than 0.03 °C. Typical ranges for the lid, base, and sample temperatures is between 24.5 and 25.5 °C. The optical sensor has a typical range between 300 and 2,900 mV. If values are outside these ranges, refer to Section 4.5.

Diagnostics		Diagnostics	
Lid:	25.50°C	Offset:	+0.0002 a _w
Base:	25.19°C		
Sample:	25.23°C		
Mirror:	26.92°C		
Optical:	1.745mV		

Figure 50 Chilled-mirror dew point sensor Diagnostics screen

For the capacitance sensor (TEV models only), Diagnostics provides lid, base, and sample temperatures, relative humidity, and the capacitive sensor user offset (Figure 51). If any of the temperature values are outside the ranges specified in the previous paragraph, refer to Section 4.5.

Diagnostics	$\Delta=0.40^{\circ}\text{C}$
Lid:	25.40 $^{\circ}\text{C}$
Base:	25.09 $^{\circ}\text{C}$
Sample:	25.12 $^{\circ}\text{C}$
RH:	22.9% (20562)
Offset:	+0.000 a_w <input checked="" type="checkbox"/>

Figure 51 Capacitance sensor Diagnostics screen

- **%Moisture (DUO only).** Select to view all isotherm models on the instrument (Section 2.5).
- **About.** Select to view instrument information including the serial number and firmware code version of the instrument (Figure 52).

About
SN: AL400002634
Lid SN: ALB00002123
Version: AS4 3.00.11
©2018 METER Group

Figure 52 About screen

3.2.4.3. DATA TAB

Data can be viewed or deleted from the Data tab (Figure 53).

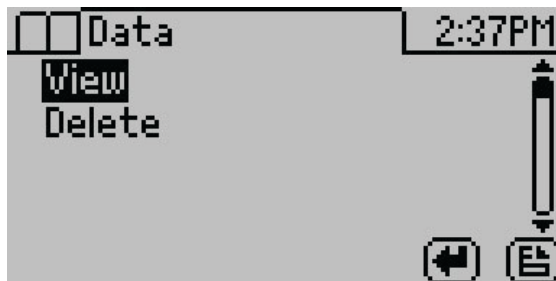

Figure 53 Data tab

- **View.** Select to view stored measurements with the most recent measurements at the top of the table (Figure 54). Use **UP** and **DOWN** to move through the stored data. Use **LEFT** and **RIGHT** to page quickly through the data. Refer to Section 3.3 for information about downloading these readings to a computer.

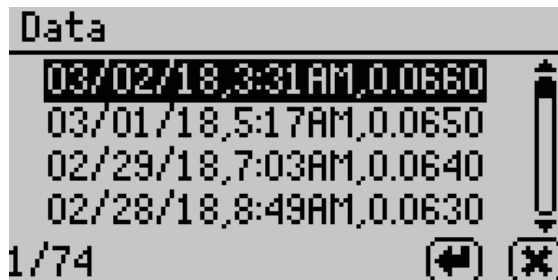

Figure 54 View data

Select a highlighted reading to view detailed information (Figure 55).

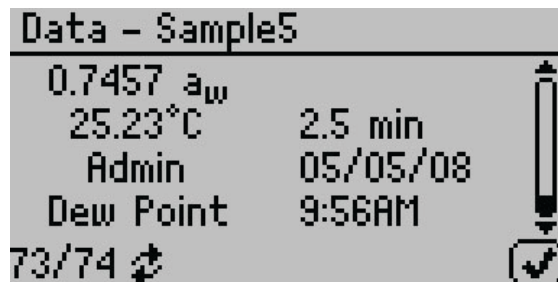

Figure 55 Data sample detail screen

The screen displays the name of the reading (if annotated), the water activity of the sample, the temperature of the sample, the test time, the user who ran the test (if set up), the reading date, the sensor used, the time the reading was taken, and the sequence number of the stored reading. Use **UP** and **DOWN** to scroll through readings.

- **Delete.** Select this option to delete **all** data currently stored in the instrument. Readings cannot be deleted individually. If the information has not been backed up with AquaLink 4, a reminder will appear (Figure 56).

NOTE: Deleted data cannot be recovered.

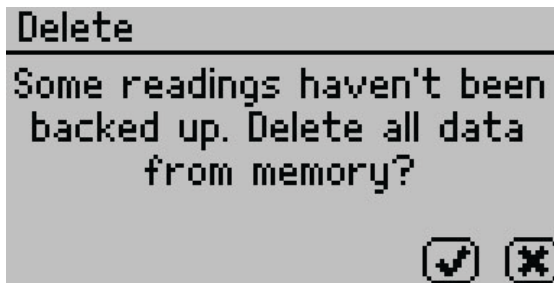

Figure 56 Delete option backup reminder dialog

3.3 COMPUTER INTERFACE

The AQUALAB can connect to a computer using USB (included) or RS-232 to send water activity data for further analysis and storage. The interface is run through the AquaLink 4 software or a terminal communication program.

NOTE: Install the USB driver before connecting the USB cable to the computer by downloading from metergroup.com/aqualab4te-support.

3.3.1 AQUALINK 4 SOFTWARE

AquaLink 4 is available for use with the AQUALAB. AquaLink 4 is a Microsoft® Windows®-based program designed for data collection and customized report generation for all AQUALAB models. AquaLink 4 logs water activity, temperature, and time and date of measurement along with other information (Figure 57). AquaLink 4 also has sample identification and comment fields to help annotate the data the AQUALAB is gathering. The AquaLink 4 software can also download data (including moisture content) from the instrument, present the data in table form, filter the data, and print reports. Refer to AquaLink 4 software help files for further instructions.

Date Time	Device	Water Activity	°C	Test Time	User	Type
2000-Jan-01 00:00:00	S40001234	0.0000	0.00	0.0	Admin	Normal
2000-Jan-01 22:14:07	S40001234	0.0010	1.43	3.0	Admin	Normal
2000-Jan-02 20:28:14	S40001234	0.0020	2.86	2.9	Admin	Normal
2000-Jan-03 18:42:21	S40001234	0.0030	4.29	5.9	Admin	Normal
2000-Jan-04 16:56:28	S40001234	0.0040	5.72	5.8	Admin	Normal
2000-Jan-05 15:10:35	S40001234	0.0050	7.15	5.7	Admin	Normal
2000-Jan-06 13:24:42	S40001234	0.0060	8.58	5.5	Admin	Normal
2000-Jan-07 11:38:49	S40001234	0.0070	10.01	5.4	Admin	Normal
2000-Jan-08 09:52:56	S40001234	0.0080	11.44	5.3	Admin	Normal
2000-Jan-09 08:07:03	S40001234	0.0090	12.87	5.2	Admin	Normal
2000-Jan-10 06:21:10	S40001234	0.0100	14.30	5.1	Admin	Normal
2000-Jan-11 04:35:17	S40001234	0.0110	15.73	5.0	Admin	Normal
2000-Jan-12 02:49:24	S40001234	0.0120	17.16	4.8	Admin	Normal
2000-Jan-13 01:03:31	S40001234	0.0130	18.59	4.7	Admin	Normal
2000-Jan-13 23:17:38	S40001234	0.0140	20.02	4.6	Admin	Normal
2000-Jan-14 21:31:45	S40001234	0.0150	21.45	4.5	Admin	Normal
2000-Jan-15 19:45:52	S40001234	0.0160	22.88	4.4	Admin	Normal
2000-Jan-16 17:59:59	S40001234	0.0170	24.31	4.3	Admin	Normal
2000-Jan-17 16:14:06	S40001234	0.0180	25.74	4.1	Admin	Normal
2000-Jan-18 14:28:13	S40001234	0.0190	27.17	4.0	Admin	Normal
2000-Jan-19 12:42:20	S40001234	0.0200	28.60	3.9	Admin	Normal
2000-Jan-20 10:56:27	S40001234	0.0210	30.03	3.8	Admin	Normal

Figure 57 AquaLink 4 main screen

3.3.2 USING A TERMINAL PROGRAM

There are several terminal program options. METER has its own terminal program (DecaTerm) that can be downloaded from metergroup.com/aqualab4te-support. Two other options are TeraTerm, a free program that can be found on the internet, and Hyperterminal, the standard program with Microsoft Windows prior to Windows 7 software.

To integrate a terminal program with AQUALAB, use the following steps:

1. Power on the AQUALAB.
2. Connect the USB interface cable to the computer.
3. Follow the instructions for the program with the following settings:
 - c. Choose correct COM Port
 - d. Set or verify COM Properties
 - e. Bits per second (Baud rate): 9600
 - Data: 8 bit
 - Parity: none
 - Stop: 1 bit
 - Flow control: none

Upon successful completion of a water activity reading, the data in the terminal program displays measurement time (in minutes), sample temperature, and water activity.

Table 3 shows an example data return.

Table 3 Terminal data

Measurement Time	Temperature (°C)	a_w
3.1	24.3	0.862

3.4 THEORY

Water is a major component of foods, pharmaceuticals, and cosmetics and influences the product texture, appearance, flavor, and shelf life. Quantifying these attributes require two basic types of water analysis: moisture content and water activity (a_w).

3.4.1 MOISTURE CONTENT

Moisture content implies a quantitative analysis to determine the total amount of water present in a sample. There are two primary methods for determining moisture content: loss on drying and Karl Fisher titration. Secondary methods, such as near infrared

(NIR) and nuclear magnetic resonance (NMR), may also be used. Moisture content determination is essential in meeting product nutritional labeling regulations, specifying recipes, and monitoring processes.

However, moisture content alone is not a reliable indicator for predicting microbial responses and chemical reactions in materials. The limitations of moisture content measurement are attributed to differences in the intensity that water associates with other components.

3.4.2 WATER ACTIVITY

Water activity (a_w) is a measurement of the energy status of the water in a system. The value indicates how tightly water is bound, structurally or chemically, within a substance. The lower a sample's water activity, the more tightly bound that water is within the sample. The concept of water activity is of particular importance in determining product quality and safety. It predicts safety and stability with respect to microbial growth, chemical and biochemical reaction rates, and physical properties.

Water activity is a measure of the energy status of the water in a system and is a far better indicator of product stability than moisture content. Figure 58 shows how the relative activity of microorganisms, lipids, and enzymes relate to water activity. While other factors, such as nutrient availability and temperature, can affect the relationships, water activity is the best single measure of how water affects these processes.

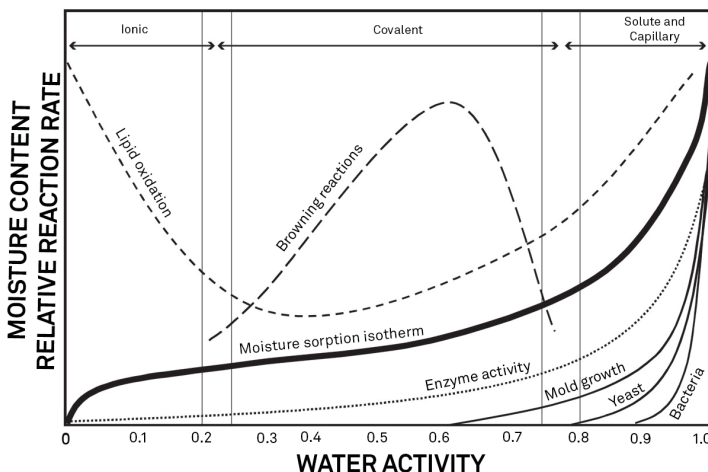

Figure 58 Water activity diagram adapted from Labuza (1976)

Researchers measure the water activity of a system by equilibrating the liquid phase water in the sample with the vapor phase water in the headspace and measuring the relative humidity of the headspace. In the AQUALAB, a sample in a sample cup is sealed inside the sample chamber, which contains a fan, a dew point sensor, and an infrared thermometer. The fan speeds equilibrium and controls the boundary layer conductance of the dew point sensor. The dew point sensor measures the dew point temperature of the air in the

chamber, and the infrared thermometer measures the sample temperature. From these measurements, the relative humidity of the headspace is computed as the ratio of the dew point temperature saturation vapor pressure to the saturation vapor pressure at the sample temperature. When the water activity of the sample and the relative humidity of the air are in equilibrium, the measurement of the headspace humidity gives the water activity of the sample. Water activity is the relative humidity of air in equilibrium with a sample in a sealed chamber.

In addition to equilibrium between the liquid phase water and the vapor phase, the internal equilibrium of the sample is important. If a system is not at internal equilibrium, one might measure a steady vapor pressure (over the period of measurement) which is not the true water activity of the system. An example of this might be a baked good or a multicomponent food. Initially out of the oven, a baked good is not at internal equilibrium; the outer surface is at a lower water activity than the center of the baked good. One must wait a period of time in order for the water to migrate and the system to come to internal equilibrium. It is important to keep in mind that by this definition, water activity is an equilibrium measurement.

The water activity of a sample is influenced by factors that affect the binding of water. These factors include temperature, osmotic, matric, and pressure effects. Typically, water activity is measured at atmospheric pressure, so only the osmotic, temperature, and matric effects are important.

3.4.2.1. TEMPERATURE EFFECTS

Temperature plays a critical role in water activity determination. Most critical is the measurement of the difference between sample and dew point temperature. For water activity measurements to be accurate to 0.001, temperature difference measurements need to be accurate to 0.017 °C. The AQUALAB infrared thermometer measures the difference in temperature between the sample surface and the sample block. The thermometer is carefully calibrated to minimize temperature errors; however, achieving 0.017 °C accuracy is difficult when temperature differences are large. Most accurate measurements are obtained when the sample is near sample chamber temperature.

Another effect of temperature on water activity occurs when samples are near saturation. A sample that is close to 1.0 a_w and is warmer than the sensor block will cause water to condense within the chamber. This causes errors in the measurement and in subsequent measurements until the condensation disappears. For example, a sample at 0.75 a_w only needs to be 4 °C above the sample chamber temperature to cause condensation to form. The AQUALAB warns the user if a sample temperature is more than 4 °C above the chamber temperature, but for high water activity samples, the operator needs to be aware that condensation can occur if a sample is warmer than the sample block.

There are several advantages in having a temperature-controlled water activity meter. A few major reasons are detailed here.

1. Research purposes.

Researchers can use temperature control to study the effects of temperature on the water activity of a sample, make a comparison of the water activity of different samples

independent of temperature, and conduct accelerated shelf-life studies or other water activity studies where temperature control is critical. There are many shelf-life, packaging, and isotherm studies in which temperature control would be very beneficial.

2. Compliance with government or internal regulations for specific products.

Though the water activity of most products varies by less than ± 0.02 per degree Celsius, some regulations require measurement at a specific temperature. The most common specification is 25 °C, though 20 °C is sometimes indicated.

3. Minimization of extreme ambient temperature fluctuations.

If the environmental and AQUALAB temperatures fluctuate by as much as ± 5 °C daily, water activity readings may vary by $\pm 0.01 a_w$. Temperature control eliminates variations caused by changes in ambient conditions.

The AQUALAB models have thermoelectric components installed to allow the instrument to maintain a set chamber temperature. Customers can set the temperature using the Configuration tab of any of the AQUALAB models.

3.4.2.2. OSMOTIC EFFECTS

Osmotic effects are well known from biology and physical chemistry. Water is diluted when a solute is added. If this diluted water is separated from pure water by a semipermeable membrane, water tends to move from the pure water side through the membrane to the side with the added solute. If sufficient pressure is applied to the solute-water mixture to just stop the flow, this pressure is a measure of the osmotic potential of the solution. Addition of 1 mol of an ideal solute to 1 kg of water produces an osmotic pressure of 22.4 atm. This lowers the water activity of the solution from 1.0 to 0.98 a_w . For a given amount of solute, increasing the moisture content of the systems dilutes the solute, decreasing the osmotic pressure, and increasing the water activity. Since microbial cells are high concentrations of solute surrounded by semipermeable membranes, the osmotic effect on the free energy of the water is important for determining microbial water relations and therefore microbe activity.

3.4.2.3. MATRIX EFFECTS

The sample matrix affects water activity by physically binding water within its structure through adhesive and cohesive forces that hold water in pores and capillaries and to particle surfaces. If cellulose or protein were added to water, the energy status of the water would be reduced. Work would need to be done to extract the water from this matrix. This reduction in energy status of the water is not osmotic, because the cellulose or protein concentrations are far too low to produce any significant dilution of water. The reduction in energy is the result of direct physical binding of water to the cellulose or protein matrix by hydrogen bonding and van der Waals forces. At higher water activity levels, capillary forces and surface tension can also play a role.

3.4.3 CHILLED-MIRROR DEW POINT LIMITATIONS

The limitation of the AQUALAB 4TE is its ability to accurately measure samples with high concentrations (typically >1%) of certain volatile compounds such as ethanol or propylene glycol, which can condense on the surface of the chilled mirror. The extent of the effect is determined by how readily the material volatilizes, which is both concentration and matrix dependent. Therefore, even if a sample contains materials that could volatilize, it may still be possible to make accurate readings using the chilled-mirror dew point sensor.

The AQUALAB TDL provides a solution for products containing volatile materials. The TDL uses a tunable diode laser which shines light of a controlled wavelength, specific to water vapor, at a detector that receives light from the laser. The vapor pressure of the headspace of the instrument in equilibrium is determined by the loss of signal strength from the laser caused by the presence of water vapor in the headspace. For more information, contact [Customer Support](#).

3.4.4 WATER POTENTIAL

Water activity is closely related to a thermodynamic property called the water potential, or chemical potential (μ) of water, which is the change in Gibbs free energy (ΔG) when water concentration changes. Equilibrium occurs in a system when μ is the same everywhere in the system. Equilibrium between the liquid and the vapor phases implies that μ is the same in both phases. This means the measured water potential of the vapor phase can be used to determine the water potential of the liquid phase. Gradients in μ are driving forces for moisture movement. In an isothermal system, water tends to move from regions of high water potential (high a_w) to regions of low water potential (low a_w). Moisture content is not a driving force for water movement and, therefore, cannot be used to predict the direction of water movement, except in homogeneous materials.

3.4.5 SORPTION ISOTHERMS

Changes in moisture content affect both the osmotic and matric binding of water in a product. Thus, a relationship exists between the water activity and moisture content. This relationship is called the sorption isotherm and is unique for each product. Besides being unique to each product, the isotherm changes depending on whether it was obtained by drying or wetting the sample. Typically, large safety margins are built into moisture content specifications to allow for these uncertainties.

While the sorption isotherm is often used to infer water activity from moisture content, one could easily go the other direction and infer moisture content from water activity. This is particularly attractive because water activity can be measured much more quickly than moisture content. This method gives particularly good precision in the center of the isotherm. In order to infer moisture content from water activity, an isotherm for the particular product is needed. METER sells an isotherm generator called the AQUALAB Vapor Sorption Analyzer (VSA) or METER can run the isotherm for a fee. Visit metergroup.com/food/services/water-activity-and-isotherm-testing for more information.

SYSTEM

For example, if using the AQUALAB to monitor the moisture content of dried potato flakes, measure the water activity and moisture content of potato flakes dried to varying degrees using the standard drying process for those flakes. That data is used to construct an isotherm and infer the moisture content using the measured water activity of samples and that isotherm. The DUO upgrade to AQUALAB 4TE and TDL enables users to determine moisture content and water activity simultaneously.

4. SERVICE

This section contains calibration and verification information, cleaning and maintenance guidelines, troubleshooting steps, and customer support information.

4.1 VERIFICATION AND CALIBRATION

It is important to verify the AQUALAB water activity calibration against known standards to guarantee optimal performance and accuracy. METER recommends verification daily, once per shift, or before each use.

METER also recommends annual factory calibration to maintain optimal performance.

4.1.1 WATER ACTIVITY VERIFICATION

The AQUALAB uses the chilled-mirror dew point technique to determine water activity. Because this is a primary measurement of relative humidity, no calibration is necessary; however, METER recommends periodic verification. The components used by the instrument to measure water activity are subject to contamination, which may affect AQUALAB performance. Therefore, frequent verification assures that the AQUALAB is performing correctly. In addition, providing a linear offset can be used to overcome any additional instrument drift.

4.1.1.1. VERIFICATION STANDARDS

Verification standards are specially prepared, unsaturated salt solutions having a specific molality and water activity value that are accurately measurable. The verification standards that were sent with the initial shipment are very accurate and readily available from METER. Using verification standards to verify accuracy can greatly reduce preparation errors. Performance Verification Standards come in seven water activity levels: 1.000, 0.984, 0.920, 0.760, 0.500, 0.250, and 0.150 a_w (Table 4). The standards are produced under a strict quality assurance regime. Please contact [Customer Support](#).

Table 4 Verification standards

Verification Standard at 25 °C	Dew Point a_w	Capcitive a_w
17.18 mol/kg LiCl	0.150 ±0.005	0.150 ±0.015
13.41 mol/kg LiCl	0.250 ±0.003	0.250 ±0.015
8.57 mol/kg LiCl	0.500 ±0.003	0.500 ±0.015
6.00 mol/kg NaCl	0.760 ±0.003	0.760 ±0.015
2.33 mol/kg NaCl	0.920 ±0.003	0.920 ±0.015
0.50 mol/kg KCl	0.984 ±0.003	0.984 ±0.015
Steam Distilled Water	1.000 ±0.003	1.000 ±0.015

NOTE: Safety Data Sheet (SDS) for these standards are available at sds.metergroup.com.

To use a verification standard, remove the twist top and pour the contents into an AQUALAB sample cup. Information about the standard value and molality can be found printed on the outside of the plastic vial. If for some reason METER verification standards are not available, contact [Customer Support](#) for instructions on how to create a verification standard salt solution.

In TEV models, the capacitance sensor can exhibit hysteresis. When a high water activity standard or sample is measured, this may influence future readings. After measuring a high water activity sample, allow 1 h for the sensor to dry. Additionally, desiccant or activated carbon can be used to accelerate the drying process.

NOTE: To avoid inaccurate water activity readings, verification standards should be used once immediately after opening. Do not store standards in sample cups for repeated use.

4.1.1.2. VERIFICATION OF CALIBRATION

Verification of the calibration should be performed regularly to ensure the AQUALAB is operating within specification. METER recommends verification be run once per shift or prior to operation. The procedure for verification involves reading a sample of known water activity. METER recommends using a standard close to that of the sample being measured. If operating in volatiles mode using the capacitance sensor or measuring a broad range of water activity values, METER recommends bracket the sample range. Capacitance sensors can show significantly more drift when compared to a chilled mirror and can exhibit some nonlinear behavior. Verifications should not be performed with only water standards.

Checking the water activity of a standard solution checks for the possibility of unit contamination or shifts in the linear offset from other causes.

The following steps explain how to verify for linear offset of the AQUALAB ([Figure 59](#)).

1. If measuring samples over a wide range of water activity values, select two standards that best bracket the region. If measuring a relatively narrow region, select a sample that most closely matches the sample range being measured.

For example, if testing for water activity readings ranging between 0.621 and 0.713, use the 8.57 mol/kg LiCl ($0.50 a_w$) standard for the first verification and the 6.00 mol/kg, NaCl ($0.76 a_w$) for the second verification.

NOTE: The AQUALAB needs to warm up for approximately 15 min to make accurate readings.

2. Empty a vial of the lower water activity verification standard into a sample cup.
3. Place it in the AQUALAB testing chamber. Make sure that the standard is as close to the instrument temperature as possible. See [Section 2.2.2](#) for detailed instructions.

NOTE: Make sure the rim and outside of the sample cup are clean.

4. Carefully close the lid and move the lever to the READ position.
5. Take two readings.

The water activity readings should be within $\pm 0.003 a_w$ of the given value for the dew point or ± 0.015 for capacitance when testing the verification standard. The standards will read at 25 °C. If other temperatures are required, refer to [Table 5](#).

Table 5 Temperature correction of verification standards

Temperature (°C)	Water	0.50 mol/kg KCL	2.33 mol/kg NaCl	6.00 mol/kg NaCl	8.57 mol/kg LiCl	13.41 mol/kg LiCl	17.18 mol/kg LiCl
15	1.000	0.984	0.923	0.761	0.492	0.238	0.140
20	1.000	0.984	0.922	0.760	0.496	0.245	0.145
25	1.000	0.984	0.920	0.760	0.500	0.250	0.150
30	1.000	0.984	0.920	0.760	0.504	0.255	0.155
35	1.000	0.984	0.920	0.760	0.508	0.261	0.160
40	1.000	0.984	0.921	0.760	0.512	0.266	0.165
50	1.000	0.984	0.894	0.740	0.517	0.275	0.172

NOTE The AQUALAB measures these verification standards to $\pm 0.003 a_w$ with the dew point sensor and $\pm 0.015 a_w$ with the capacitance sensor.

6. The readings may lead to one of three outcomes.
 - a. If the AQUALAB reads within $\pm 0.003 a_w$ of the first verification standard for dew point and ± 0.015 for capacitance, take two readings of the second verification standard. The second water activity reading for the second verification standard should be within $\pm 0.003 a_w$ for the dew point and ± 0.015 for the capacitance sensors.
 - b. If either verification standard is not correct, it is probably due to contamination of the sensor chamber. Clean and air out the chamber ([Section 4.2](#)) and repeat verification from [step 2](#).
 - c. If readings are consistently outside the water activity of the first verification standard by more than $\pm 0.003 a_w$ for dew point and ± 0.015 for capacitance, a linear offset can be applied. Adjust the reading to match the correct verification standard value ([Section 4.1.2](#)).

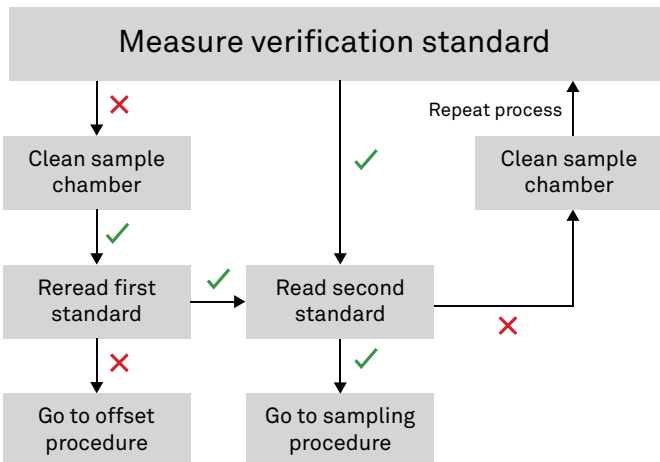

Figure 59 Verification standard flowchart. A check indicates AQUALAB verified the standard within specification; a cross indicates AQUALAB did not verify the standard within specifications.

4.1.2 LINEAR OFFSET

After verification and cleaning, the instrument an offset may be necessary.

1. Navigate to the Configuration tab.

For the AQUALAB 4TEV, the currently selected sensor for the instrument will be the one offset. Make sure to select the correct sensor before beginning the offset.

2. Select Calibration.

NOTE: The DUO model shows both water activity and moisture content on this screen. Select Water Activity.

3. Select Start (Figure 60).

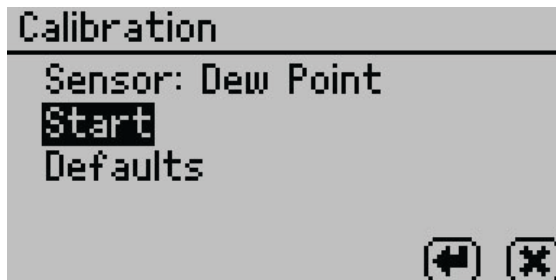

Figure 60 Start dew point calibration

To return to the prior tab, select CANCEL.

4. A prompt will appear to insert a fresh standard and seal the chamber (Figure 61).

NOTE: The same verification standard can be used to verify and adjust the linear offset. If using the same verification standard, do not open the sample chamber between verification and offset.

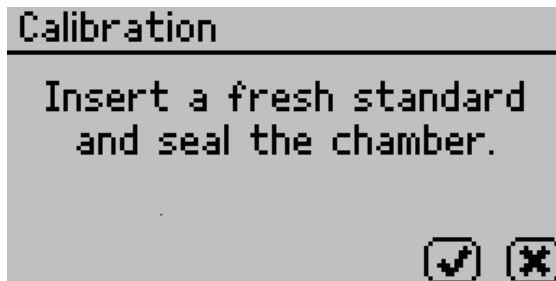

Figure 61 Calibration instruction dialog

5. Empty the whole vial of water activity standard into a sample cup.
METER recommends using the 6.00 NaCl (0.76 a_w). Do not adjust for the offset using steam distilled water.
6. Ensure the rim and outside of the cup are clean.
7. Place the sample cup in the sample chamber.
8. Carefully close the lid and move the lever to the READ position.
9. Select **OK** to begin testing.

NOTE: To interrupt the offset procedure, return the lever to the OPEN position or select **CANCEL** to return to the previous screen.

After the AQUALAB has finished measuring the verification standard, it displays a Change the offset screen (Figure 62).

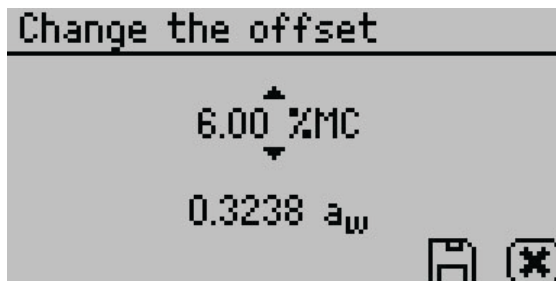

Figure 62 Change the offset screen

10. Use **UP** and **DOWN** to adjust the water activity reading to its proper value for the particular verification standard.
11. Select **SAVE** to store this new value.
To cancel and return to the main menu, select **CANCEL** to make no changes.
12. Restart the verification procedure in [Section 4.1.1](#).
If incorrect verification standard readings persist after cleaning the chamber and adjusting for linear offset, contact [Customer Support](#) for further instructions.

4.1.3 MULTIPPOINT CALIBRATION (TEV ONLY)

The capacitance sensor used for measuring the water activity of materials with volatiles (AQUALAB 4TEV models only) is a secondary method for measuring water activity and may require a slope change to the calibration in addition to a linear offset. This is the case when the offset in capacitance mode is different at high water activities than low water activities.

The 0.25, 0.50, 0.76, and 0.92 a_w unsaturated salt standards are needed to proceed with multipoint calibration.

1. Navigate to the Configuration tab.
For the AQUALAB 4TEV, make sure to select the capacitance sensor before beginning the multipoint calibration.
2. Select Calibration from the Configuration tab (Figure 63).

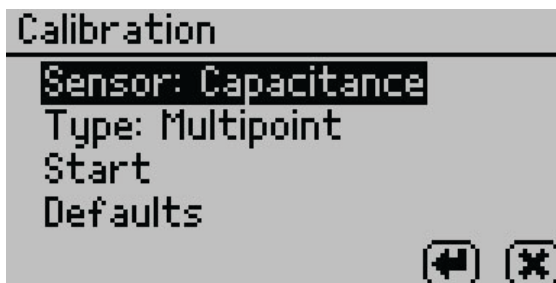

Figure 63 Capacitance sensor calibration screen

3. Highlight Type and select **ENTER** to toggle to Multipoint.
4. Select Start.
Prompts will instruct the user to insert a fresh standard and seal the chamber (Figure 64).

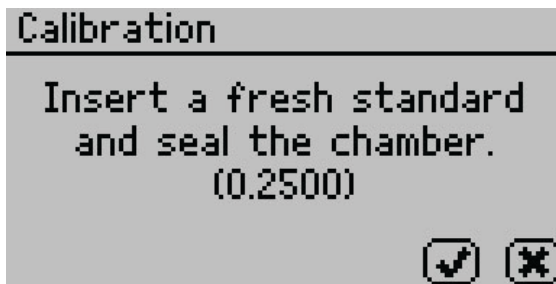

Figure 64 Prompt to insert fresh standard

5. Empty the whole vial of 0.25 a_w standard solution into a sample cup.
6. Ensure the rim and outside of the cup are clean.

7. Place the sample cup in the AQUALAB sample chamber.
8. Carefully close the lid and move the lever to the READ position.
9. Select **OK** to begin testing.

After AQUALAB has finished measuring the verification standard, a new screen appears requesting that a 0.50 a_w standard be placed in the chamber.

10. Repeat [steps 5](#) through [9](#) using 0.50, 0.76, and 0.92 a_w standards.

NOTE: To end the multipoint calibration program, select **CANCEL** to return to the previous screen.

When measurements are complete on all four standards, the Verification Complete screen appears showing the testing results for each standard ([Figure 65](#)).

Verification Complete			Verification Complete		
Standard	Read	Error	Standard	Read	Error
0.250	0.254	0.004	0.920	0.928	0.008
0.500	0.492	-0.008			
0.760	0.757	-0.003			

⏪ ✓ ✗
⏪ ✓ ✗

Figure 65 Verification Complete screen with results

11. Select **OK** to continue or **CANCEL** to cancel the entire process.

NOTE: Select the audio icon to turn beeping on and off.

12. To make adjustments to the calibration, select **OK**.

Select **CANCEL** to cancel without adjusting the calibration ([Figure 66](#)).

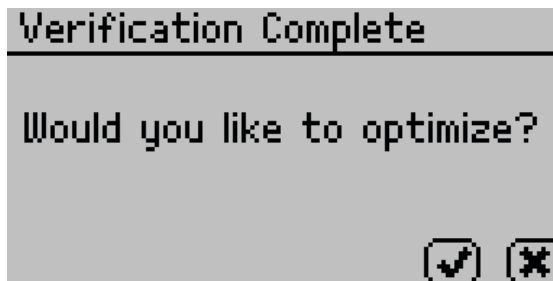

Figure 66 Prompt to adjust calibration

13. To save the new calibration changes, select **SAVE**.

To cancel the multipoint calibration without saving the new changes, select **CANCEL** ([Figure 67](#)).



Figure 67 Calibration Complete screen

Once the multipoint calibration is saved, a confirmation screen will appear (Figure 68).

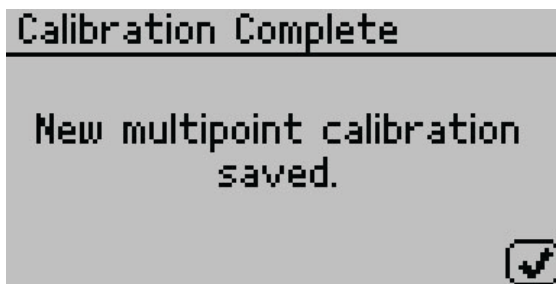

Figure 68 Calibration saved confirmation

14. Select **OK** to continue.
15. If the calibration is canceled at any point, a Calibration Canceled confirmation will appear. Select **OK** to continue (Figure 69).

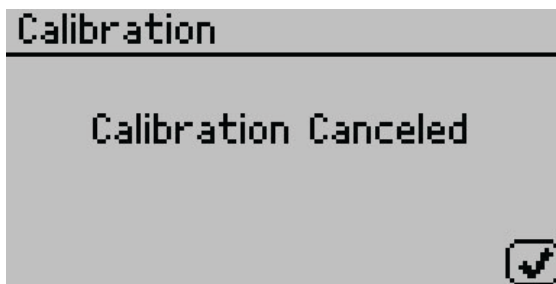

Figure 69 Calibration canceled confirmation

16. Let the sample chamber air out for at least 1 h.
17. Measure a 0.25 or 0.50 a_w verification standard in the Measurement tab (with capacitance sensor type).
18. Verify the AQUALAB reads within $\pm 0.015 a_w$ at a given temperature.

19. Measure a 0.76 a_w verification standard according to the verification procedure detailed in [Section 4.1.1](#).

If both verification readings are within $\pm 0.015 a_w$, the instrument is ready to begin testing.

If incorrect verification standard readings persist, contact [Customer Support](#).

4.1.4 RESTORE FACTORY DEFAULTS

To restore original calibration settings, do the following:

1. Navigate to the Configuration tab using **MENU**.
NOTE: For TEV models, ensure the correct sensor is selected.
2. Select Calibration.
If using a DUO model, also select Water Activity.
3. Select Defaults to access the Restore Factory Defaults routine ([Figure 70](#)).

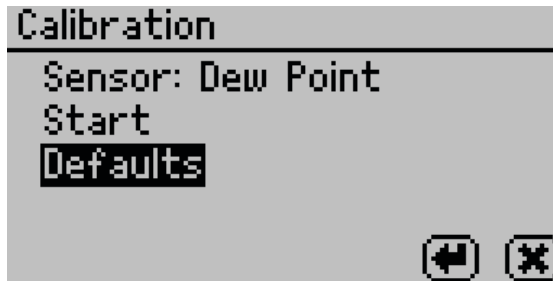

Figure 70 Calibration screen with Defaults selected

A confirmation dialog will appear ([Figure 71](#)).

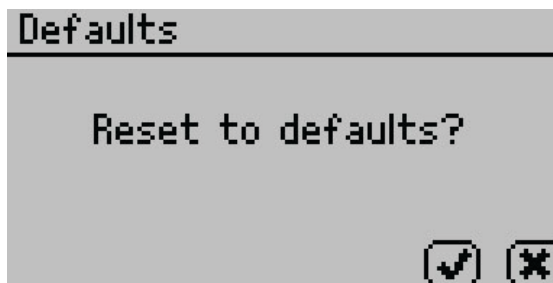

Figure 71 Confirmation dialog to reset defaults

4. Select **OK**.
Select **CANCEL** to return to the Calibration menu.
The instrument will confirm the factory calibration has been restored ([Figure 72](#)).

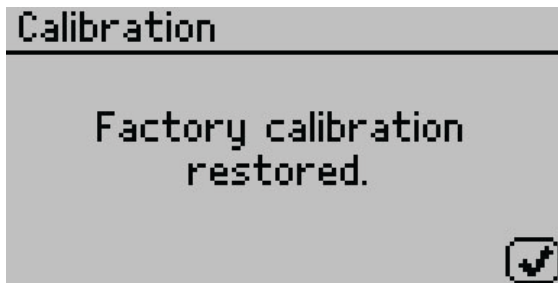

Figure 72 Confirmation that factory calibration was reset

5. Select OK.

4.2 CLEANING

Keeping the AQUALAB clean is vital to maintaining the accuracy of the instrument. Dust and sampling debris can contaminate the sampling chamber, so regular cleaning is essential.

To clean the AQUALAB, carefully follow these instructions and refer to the labeled diagram in Figure 73. A video is also available at metergroup.com/meter_knowledgebase/aqualab-4te-certification.

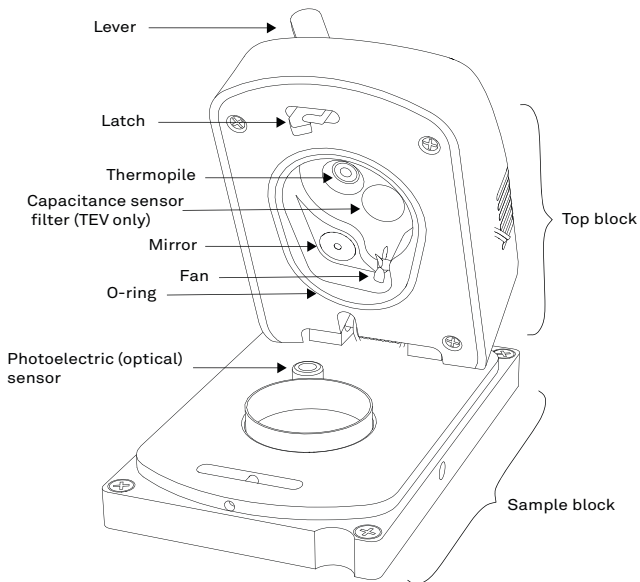

Figure 73 AQUALAB sample chamber diagram

The purpose of the cleaning procedure is to remove grease, dirt, and other soluble substances that can absorb or release water during verification, calibration, or sample testing. The mirror must be perfectly clean for a smooth and even dew formation. If there are

any contaminants (e.g., fingerprints) on the mirror, the dew forms unevenly and can affect the accuracy of the reading.

The instrument should be cleaned if visual inspection indicates the chamber is dirty or as part of the verification process (Section 4.1).

4.2.1 CLEANING KIT

The AQUALAB comes with an AQUALAB Cleaning Kit that contains enough cleaning supplies to clean the instrument for about 1 year. The following supplies are included:

- Spatula (a thin plastic rod)
- Deionized water for cleaning
- Cleaning Solution
- KIMWIPES® tissues
- Activated charcoal for removing volatile compounds from the chamber between readings

NOTE: Wash hands with soap and water, and wear clean gloves before starting the cleaning procedure. This prevents oils from contaminating the cleaning materials, the sample chamber, and the sensors.

4.2.2 AQUALAB 4TEV SPECIAL CONSIDERATIONS

When cleaning an AQUALAB 4TEV, do not get cleaning solution on the capacitance sensor filter (Figure 73). Repeated exposure of cleaning materials or contaminants to the filter may cause inaccurate readings. If the filter appears to be contaminated, it may need to be replaced.

To replace the capacitance sensor filter, use the following steps:

1. Use a tweezer or small knife blade to pry up the edge of the filter, being careful not to disturb the sensor beneath.
2. Discard the soiled filter.
3. With clean and gloved hands, gently press a new filter into place.

4.2.3 CLEANING PROCEDURE

The procedure to clean AQUALAB involves washing, rinsing, and drying each area.

NOTE: Isopropyl alcohol can be substituted for the Cleaning Solution.

1. Turn the AQUALAB power OFF.
2. Open the chamber cover to expose the sample chamber and sensors.
3. Clean the sample chamber. The sample chamber consists of all surfaces inside the red O-ring when the lid is closed.

NOTE: Be extremely careful not to damage the fan blades when cleaning the chamber.

- a. Remove any debris that may have collected within or around the sample chamber.

SERVICE

- b. Wrap a new tissue around the end of the spatula and moisten it with cleaning solution.

NOTE: Do not dip used tissue into the cleaning solution as the cleaning solution will become contaminated.

- c. Clean upper chamber, O-ring, and all surfaces of the sample block within the red O-ring. Replace the tissue if it becomes too dirty during this process.
- d. Clean lower block with a fresh KIMWIPES tissue. Clean the entire block surface.
- e. Repeat [steps b](#) through [d](#) using a new tissue moistened with deionized water.
- f. Repeat [steps b](#) through [d](#) using a new, dry KIMWIPES tissue to remove any moisture remaining from the cleaning.

NOTE: Do not reuse tissues.

4. Clean the mirror.
 - a. Wrap a new KIMWIPES tissue around the end of the spatula and moisten it with cleaning solution.
 - b. Gently swipe the moistened tissue across the mirror once. A single swipe is usually sufficient to remove contaminants.
 - c. Repeat [steps a](#) and [b](#) using a new tissue moistened with deionized water.
 - d. Repeat [steps a](#) and [b](#) using a new, dry KIMWIPES tissue to remove any moisture remaining from the cleaning.
 - e. Visually inspect the mirror for cleanliness. Clean again if necessary.
5. Clean the thermopile and optical sensor.
 - a. Wrap a new KIMWIPES tissue around the end of the spatula and moisten it with cleaning solution.
 - b. Swipe the moistened tissue across thermopile and optical sensor. A single swipe across the sensor is usually sufficient to remove contaminants.
 - c. Repeat [steps a](#) and [b](#) using a new tissue moistened with deionized water.
 - d. Repeat [steps a](#) and [b](#) using a new, dry KIMWIPES tissue to remove any moisture remaining from the cleaning.
 - e. Visually inspect the thermopile and optical sensor for cleanliness. Clean again, if necessary.
6. Visually inspect the sample chamber and sensors for contaminants, including moisture. If necessary, repeat the cleaning process using new KIMWIPES tissues.
7. Let stand for 5 min to ensure the sample chamber is dry.
8. After cleaning the AQUALAB, check the instrument performance and correct for any linear offset that may have occurred during the cleaning process.
 - a. Run a sample of the activated charcoal pellets from the AQUALAB Cleaning Kit.

This cleans the air inside the chamber, helping it come back to a stable sampling environment.

- b. Verify the linear offset against known verification standards as described in [Section 4.1.2](#).
- c. If a linear offset has occurred, adjust for linear offset.

If the instrument is still not reading samples correctly, contact [Customer Support](#).

4.3 MAINTENANCE PACKAGES

METER offers maintenance and calibration packages to ensure AQUALAB is functioning to its highest standard ([Table 6](#)).

Table 6 Maintenance package options

Package	Preventative Maintenance	Basic Calibration Service
As-found inspection	Available	Available
Replace old/damaged parts	Included	Separate charge per part
Instrument cleaning	Included	Included
Factory calibration	Included	Included
Extended 1-year warranty	Included	Not included
Loaner instrument	Available	Available

Replacement parts can also be ordered from METER. Contact [Customer Support](#).

4.4 REPAIR

METER repairs manufacturer defects and instruments within the 1-year warranty at no charge. Repairs outside of the warranty window are charged based on cost of parts, labor, and shipping. An extra fee may be charged for rush work. Contact [Customer Support](#) for an estimated repair cost.

METER has loaner instruments available for a fee while the AQUALAB is being serviced.

All AQUALAB units returning to METER for servicing must be accompanied with a Return Merchandise Authorization (RMA) number. Prior to shipping the instrument, contact [Customer Support](#) to obtain an RMA number.

The following steps will help to ensure the safe shipping and processing of the AQUALAB:

1. Ship the AQUALAB in its original cardboard box with suspension packaging. If this is not possible, use a box with at least 4 in of space between the instrument and each wall of the box.
2. Place the AQUALAB in a plastic bag to avoid disfiguring marks from the packaging.

3. Do not ship the power cord, serial cable, or any other accessories.
4. If the original packaging is not available, pack the box moderately tight with packing material (e.g., Styrofoam™ peanuts or bubble wrap), ensuring the instrument is suspended in the packing material.
5. On the RMA form, please verify the ship to and bill to information, contact name, and problem description. If anything is incorrect, please contact [Customer Support](#).
6. Tape the box in both directions for added support.
7. Include the RMA number in the attention line on the shipping label.

A Certificate of Calibration will be issued upon completion of the work.

4.5 TROUBLESHOOTING

[Table 7](#) lists common problems and their solutions. If the problem is not listed or these solutions do not solve the issue, contact [Customer Support](#).

Table 7 Troubleshooting the AQUALAB

Problem	Possible Solutions
<p>AQUALAB does not turn on</p>	<p>Ensure power cord is securely attached to the back of the instrument and plugged into the power outlet.</p> <p>A power surge may have caused a fuse to blow. To change the fuses:</p> <ul style="list-style-type: none"> • Unplug the power cord. • Locate the panel where the power cord plugs in. The fuse box is on the right side of that panel. Press the release tab and pull the fuse-holder out. • Pull the broken fuse out and replace with a 1.25-A, 250-V fuse. CAUTION: Do not use any other kind of fuse to avoid risk of damaging the instrument or voiding the warranty. • Replace the fuse holder and push it into the fuse well until the release tab snaps in place. • Connect the power cord and turn the instrument on. <p>If the fuse blows again, a failed component may be causing the problem. Contact Customer Support to make arrangements for repairs.</p>

Table 6 Troubleshooting the AQUALAB (continued)

Problem	Possible Solutions
Readings are slow or inconsistent	<p>The sample chamber may be dirty. Refer to Section 4.2 for directions on cleaning the sample chamber.</p> <p>The temperature difference between the sample and the block chamber may be too great. Allow the sample to equilibrate to instrument temperature. Refer to Section 2.2.2.</p> <p>Some products absorb or desorb moisture very slowly, causing measurements to take longer than usual, and nothing can be done to speed up the process. Refer to Section 2.2.1.</p> <p>The sample may contain volatiles. Refer to Section 2.2.1.3 for suggestions on reducing difficulties with measuring samples with volatile compounds.</p> <p>A fan blade in the block chamber may be broken or bent. If salt standards take a long time to read and the sample chamber is clean, a broken chamber fan blade is the probable cause. Contact Customer Support for details on replacement.</p>
Water activity readings on verification standards are too high or too low and a linear offset adjustment cannot be made any higher or lower	<p>The thermopile, which measures sample temperature, may have become contaminated. Refer to Section 4.2 for directions on cleaning.</p> <p>The chamber mirror may be dirty. Refer to Section 4.2 for directions on cleaning.</p>
Remove sample. Sample is too hot! error message	<p>The sample temperature is too high for the instrument to equilibrate within a reasonable amount of time. Ensure samples are at the same temperature as the instrument (Section 2.2.2).</p>
Displayed a_w is below instrument detection limits	<p>The sample is too dry for the instrument to read accurately. If a sample has a water activity that is less than the detection limits of the instrument, this message appears. There is not enough sample moisture to condense on the mirror and provide a reading.</p> <p>The mirror may be dirty. Clean the mirror and chamber (Section 4.2) and measure the sample again.</p>
Dew point sensor failure error message	<p>The cooler is damaged and needs to be serviced by METER. Refer to Section 4.4 for detailed instructions.</p>
Crystal Failure. See Manual for options. error message	<p>The crystal that runs the firmware is having trouble starting. Cycle the power. If this message continues to appear, the instrument needs to be serviced by METER (Section 4.4).</p>
Verification is not correct	<p>Clean the sample chamber and mirror. Refer to Section 4.2 for detailed cleaning instructions.</p> <p>If verification is still not correct, verify and adjust for linear offset (Section 4.1.2).</p>
Contaminated mirror. error message	<p>Clean the chamber mirror (Section 4.2) and run the sample again. If this message continues to appear, contact Customer Support for further options.</p>

Table 6 Troubleshooting the AQUALAB (continued)

Problem	Possible Solutions
Firmware is corrupted. See Manual for options. error message	The firmware on the instrument is corrupted and needs to be reloaded. To download new firmware to the AQUALAB 4 models, the instrument must be serviced by METER (Section 4.4).
Ran test with wrong model	<p>On the measurement screen, toggle to the correct model using the UP and DOWN button (Section 2.5). The moisture content value updates to correspond with the model selected. Use SAVE to save the updated moisture value.</p> <p>If the correct model is not available, the model may not be loaded on the instrument.</p> <p>To determine which models are loaded on the instrument, cycle to the Configuration tab, select Moisture and the loaded models will be listed.</p> <p>If the correct model is not available, load the appropriate model using AquaLink 4 software (Section 2.5.2). The AQUALAB DUO can hold a total of 100 models at any one time.</p>
Moisture content displayed is not correct (AQUALAB DUO)	<p>The model selected may not be correct for the product being tested.</p> <p>Toggle through the available models to find a more appropriate model.</p> <p>If the model is correct but not giving correct moisture content values, it may be necessary to offset the model. See Section 2.5.4 for detailed instructions.</p> <p>If the model is correct and an offset does not work, it may be necessary to generate a new model for the product or update an existing model. For information about updating or generating a model, contact Customer Support.</p>
Moisture content does not show up on the Measurement tab (AQUALAB DUO)	<p>Moisture content has not been activated.</p> <p>Toggle to the Configuration tab, select %Moisture, and select the appropriate model.</p> <p>If no models appear in the %Moisture screen, reload models using AquaLink 4.</p> <p>If %Moisture is not an active selection, the DUO feature may not be active. Contact Customer Support to learn how to upgrade to a DUO.</p>
Message on the Measurement tab displays no moisture content reading (AQUALAB DUO)	<p>When a moisture content reading is not shown, the water activity or temperature for that reading is beyond the scope of the moisture sorption isotherm. This can happen under the following two conditions:</p> <ul style="list-style-type: none"> • The isotherm equation calculates a moisture content that is less than 0% or greater than 100% with the given water activity. • The control temperature is significantly different than the isotherm temperature. Make sure that the sample water activity and the instrument controlling temperature are within the scope of the selected moisture sorption isotherm model.

Table 6 Troubleshooting the AQUALAB (continued)

Problem	Possible Solutions
Sensors are reading outside of the typical range	<p>If, after cleaning the instrument and following troubleshooting guidelines, there is still a measurement error, navigate to the Diagnostics screen.</p> <p>The lid, base, and sample temperatures should be between 24.5 and 25.5 °C. If the mirror temperature is at lid temperature, the cooler has failed and must be replaced. If the mirror is below lid temperature or appears to be random, the thermocouple wire is broken and must be repaired.</p> <p>A typical optical range is between 300 and 2,900 mV. If the sensor is reading outside of this range, contact Customer Support.</p>

4.6 CUSTOMER SUPPORT

NORTH AMERICA

Customer service representatives are available for questions, problems, or feedback Monday through Friday, 7:00 am to 5:00 pm Pacific time.

Email: support.food@metergroup.com
sales.food@metergroup.com

Phone: +1.509.332.5601

Fax: +1.509.332.5158

Website: metergroup.com

EUROPE

Customer service representatives are available for questions, problems, or feedback Monday through Friday, 8:00 to 17:00 Central European time.

Email: support@metergroup.de
sales@metergroup.de

Phone: +49 89 12 66 52 36

Fax: +49 89 12 66 52 20

Website: metergroup.de

If contacting METER by email, please include the following information:

Name	Email address
Address	Instrument serial number
Phone	Description of the problem

NOTE: For products purchased through a distributor, please contact the distributor directly for assistance.

4.7 TERMS AND CONDITIONS

By using METER instruments and documentation, you agree to abide by the METER Group, Inc. USA Terms and Conditions. Please refer to metergroup.com/terms-conditions for details.

REFERENCE

Labuza, Ted P., K. Acott, S. R. Tatini, R. Y. Lee, J. Flink, and W. McCall (1976). "Water activity determination: A collaborative study of different methods." *Journal of Food Science* 41, no. 4: 910–917.

INDEX

A

accuracy 6, 21
 admin settings 31–33
 annual calibration service 43, 55
 AQUALAB models 1
 AquaLink 11–12, 36
 autosave 30, 33

B

beep 26, 33

C

calibration 28, 43
 multipoint 48–51
 restore 51–52
 capacitance sensor 24, 29, 34
 cautions 2, 7
 Certificate of Calibration 56
 charcoal 5, 7, 53, 54
 cleaning 52–54
 capacitance sensor filter 53
 cleaning kit 53–54
 procedure 53–54
 components 22–36
 buttons 24–25, 26
 display screen 25–36
 Configuration tab 27–34
 Data tab 34–36
 Measurement tab 26–27
 fan 24
 optical sensor 23, 24
 power cord 23
 RS-232 cable 22, 23, 36
 sample chamber 23–24
 shipped 1
 thermopile 24, 54
 USB cable 22, 23, 36
 computer interface 36–37
 Configuration tab 27–34
 contamination 2, 43, 44, 45
 customer support 59

D

data
 delete 35–36
 download 36–37
 view 35
 Data tab 34–36
 date 30
 dew point sensor 29, 33, 38
 diagnostics 33–38
 DUO model 1, 42

E

email address 59

F

fan 24
 fax number 59
 fuse 2

G

Gibbs free energy 41

I

installation 2–3
 isotherm model 10
 deletion 19–20
 generation 11
 loading 11–12
 model offset 14–17
 theory 41–42
 viewing 7, 34

L

linear offset 14, 33, 34, 43
 liquid phase water 38–39
 loaner instrument 55

M

maintenance 55
 matrix effects 40
 Measurement tab 26–27
 microbial growth 38, 40

mirror 5, 23, 24, 41–42

mode

continuous 29

custom 29–30

ISO 29

low-emitting 30

single 29

moisture content 10, 21

measuring 12

theory 37–38

value 7

O

osmotic effects 40

P

Peltier thermoelectric cooler 23, 40

phone number 59

pressure effects 39

propylene glycol 41

R

read time 21

reference

reference method 14

regional formatting 31

relative humidity 5, 22, 34, 38–39

repair 2, 55–56

RMA number 55

S

sample composition 4–5

coated 3, 4

dried 4

emulsions 5

multicomponent 3

viscous 5

volatile 5

sample cup 3–4, 21

sample preparation 3–7

sample temperature 6–7

sensor 29

serial number 34

service 2

settings

beeps 33

date 30–31

language 31

mode 29–30

sensor 29

temp eq 28

temperature 31

time 31

specifications

compliance 22

measurement 21

physical 21–22

power voltage 2, 22

T

temp eq 28–29

temperature 21, 28

temperature effects 2, 39–40

terms and conditions 60

theory

moisture content 37–38

sorption isotherm 41–42

water activity 38–40

water potential 41

thermometer 38, 39

time 31

troubleshooting 56–58

U

user setup 32

V

vapor phase water 39

verification 43–45

verification standards 43–44, 45

volatile compound 41. See also sample composition, volatile

W

water activity 21

theory 38–40

water potential 41

METER Group, Inc. USA

2365 NE Hopkins Court Pullman, WA 99163
T: +1.509.332.2756 F: +1.509.332.5158
E: info@metergroup.com W: metergroup.com

METER Group AG

Mettlacher Straße 8, 81379 München
T: +49 89 12665236 F: +49 89 1266520
E: info@metergroup.de W: metergroup.de

