

AQUAPONICS FOOD SYSTEM

BY YWAM EMERGE

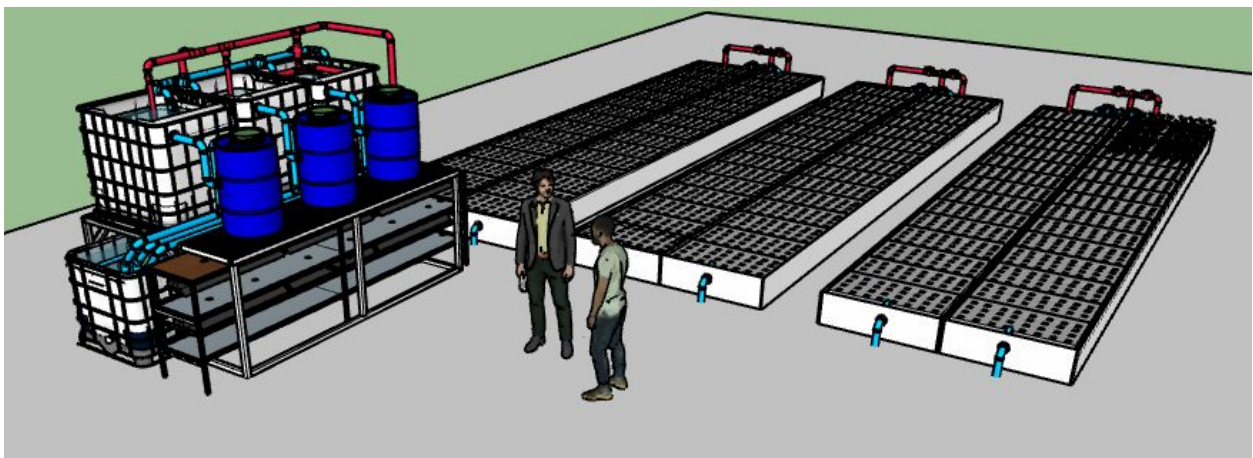

BUILD INSTRUCTION MANUAL



Copyright © 2020 YWAM Emerge | All rights reserved
www.ywamemerge.org

Version 1.0

Table of Contents

Requirements	4
System Layout	5
Parts List	6
Tool List	10
Build Checklist	11
Fish Module	12
Concrete footings	12
Sump Tank	13
Construct the Bio Filter	14
Parts List	14
Build Instructions	15
Construct Matala Filter	18
Build Instructions	19
Build Filter Frame	20
Construct Fish Rack	22
Parts List	22
Prepare Fish Tanks	24
Fish Tank Build Instructions	24
Prepare Radial Filters	27
Parts List	27
Build Instructions	28
Build Radial Rack	31
Positioning the radial filters	34
Grow Module	36
Parts List (For one grow bed)	37
Parts List Explanations	38
Constructing the Grow Beds	39
Bending Standard Ribs	40
Bending Special Ribs	42
Bending Short Ribs	42

Fabricating End Rib	43
Assemble End Unit	44
Install Plywood piece on End Unit	45
Bed Assembly	46
Insulation	47
Pond Liner	48
Aeration	49
Construction of Seeding Rack	50
Build Instructions	51
Prepare the Seeding Trays	52
Plumbing and Lighting the Seedling Trays	54
Fabricate Grow Rafts	55
Water Piping Connection	59
Air Piping Connection	63
Water: Adding and Adjusting Flow	68
Finished System	69

Requirements

Before moving forward, please take your time considering:

- Sufficient space for system (at minimum, 75 square meters)
- Properly leveled area for the system
- Capability of maintaining temperature range of 15-25c
- Capability of maintaining humidity range of 50-70%
- a reliable electricity supply and/or a backup generator
- Water supply

Some Important Questions to Answer

- Can you fit all large parts through a door into your grow area? i.e. fish tank, fish rack?
- Are you able to dig a hole in the ground for the Sump pump and water piping?

You must either be trained or capable of hiring someone who is trained in:

- Basic Construction
- Metal Welding
- Plumbing Work
- Electrician Work
- Basic Aquaponic Knowledge



If you don't have one of the above requirements STOP. Once you are able to have each of these items, you can move forward.

System Layout

We recommend three basic layouts for the aquaponics farm.

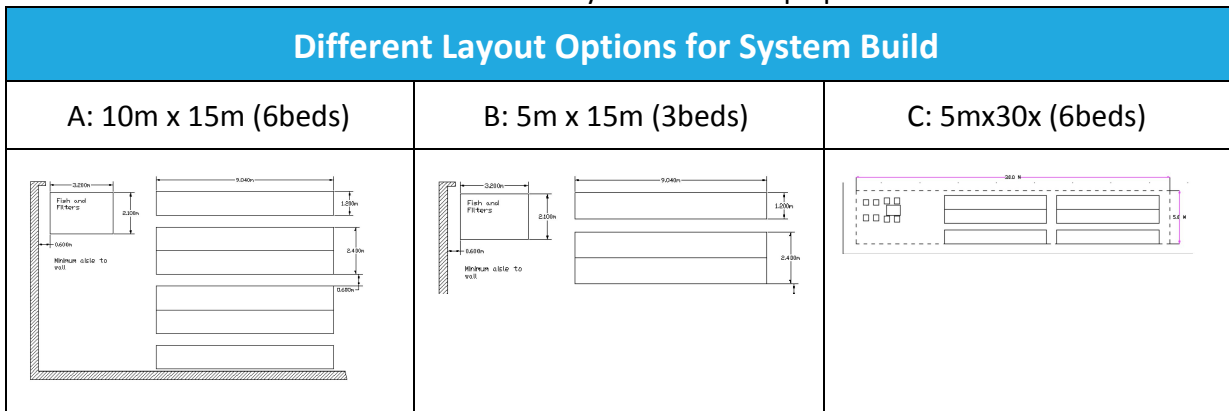

*Full size drawings can be found in the appendix

There are three modules that you need to account for when preparing to set up your system:

1. Fish Module

- This takes up 14.5 square meters of area.
- 2.1 meters by 3.2 meters plus walkways
- The height of this module is 2.4 meters. **Ensure proper space is available. If the height is not available, more floor space will need to be allotted.**

2. Grow Module

- Each bed is 11.04 square meters of area
- The dimensions of each bed is 1.2 meters by 9.2 meters

3. Work Space Module

- This space is very important, do not try to eliminate work space for more grow space.
- Area needed will depend on the size of your system but in a 150 square meter system, your work space will take up approximately 25 square meters.
- Aisle spacing should be at minimum 0.6 meters wide

4. Additional Spacing Comments





- We recommend staking out the area with stakes and string, ribbon or tape to get a visual representation of space needed. The layout of the growspace may vary depending on space available, door location, and height available.

Parts List

*Please note, substitutions may need to be made based on the regional availability of certain components

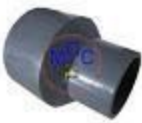
Qty	Item	Image	Qty	Item	Image
11	63mm Bulkhead Connectors		156	Conduit unthreaded Tee	
5	40mm Bulkhead Connectors		104	Black Metal Tee	
6	75 mm 90 Deg Elbows		12	PVC 3 Way Elbow Unthreaded	
38	63mm 90 Deg Elbows		4	PVC 3 Way Elbow threaded	
33	40mm Elbows		8	Black metal elbow	
3	63mm 45 Deg connector		6	75mm PVC Pipe	
4	75mm Tee		10	63mm PVC pipe	

13	63mm Tee		5	40mm PVC pipe	
22	40mm Tee		240	Snap Clamps	
11	63mm Ball Valve		2	Water Pumps	
9	40mm Ball Valve		1	Air Pump	
3	75mm Connector		1	4'x8'x3/4" Plywood	
4	63mm PVC Connector		36	pipe clamps	
9	40mm PVC Connector		30	3/4 inch foam Insulation board	
2	63-40mm PVC Reducer Coupling		4	Matala® Filter Media Pad	

1				60	Bio Media	
2	63mm 1 Way Valve Coupling			100	Floating Rafts Low density	
3	63mm PVC End Cap			20	Floating Rafts High density	
1	Pressure Gauge			1	1/4 inch Distribution Tubing	
6	1000L IBC tanks			60	Aerator Bubble Stones	
3	20L buckets			3	Aerator Disc for Bio Filter	
3	Bucket Lids			36	Permiable 1" tubing -1ft pieces	
3	55 Gallon Plastic Barrels			2	Concrete	
1	Rack for Fish Tank Elevation			6	Concrete Forms	

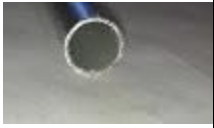
240	Meters Pond liner (2x10m pieces)			1	Load of road base	
156	10' 3/4" EMT Conduit			1	Load of coarse sand	
85	10' 3/4" EMT conduit			2	Sheets of PT Plywood	
52	Conduit threaded Tee			6	0.30 m diameter concrete forms	

Tool List

#	Item	Image	#	Item	Image
1	Conduit bender		8	Hole Bit Set	
2	Tubing Cutter		9	Drill	
3	Bending Jig		10	Jigsaw	
4	Hammer		11	Selection of Screws	
5	Rubber Mallet		12	PVC glue (& primer if needed)	
6	Knife		13	Grinder with cut-off blades	
7	Drill bit set				

Build Checklist

Location Check & Site Prep

- Level Ground
- Gather all equipment and parts required

Fish Module

- Prep Sump Tank Hole
- Lay Concrete Footers
- Fabricate & Install
 - Sump Tank
 - Bio Tank
 - Matala Filter
 - Fish Tank Rack
 - Fish tanks
 - Radial Filters
- Connect all plumbing units
- Connect all aeration units

Grow Module

- Prep Grow Bed Area
- Fabricate & Install grow beds
- Install outlet plumbing from grow beds to sump
- Install inlet plumbing from sump to grow beds
- Connect aeration in all beds

Fish Module

Concrete footings

Preliminary Checklist:

- ✓ Proper floor space available
- ✓ Proper ceiling height available
- ✓ Ground Levelled without large rocks
- ✓ Sump Area able to be excavated

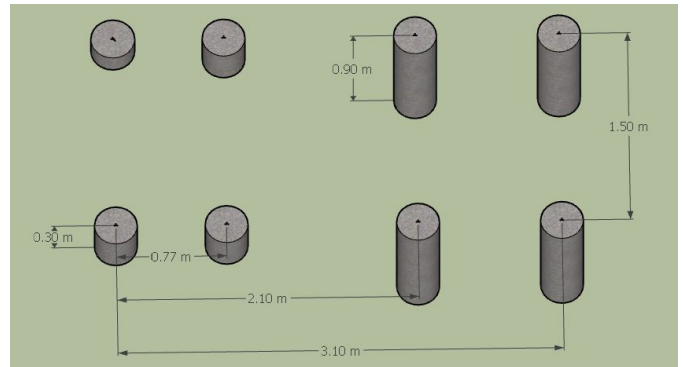

Build Checklist:

- Dig hole for sump tank
- Dig hole for fish tank rack footers
- Insert Concrete frames
- Mix and pour concrete; level with each other
- Build support box for sump tank and access area

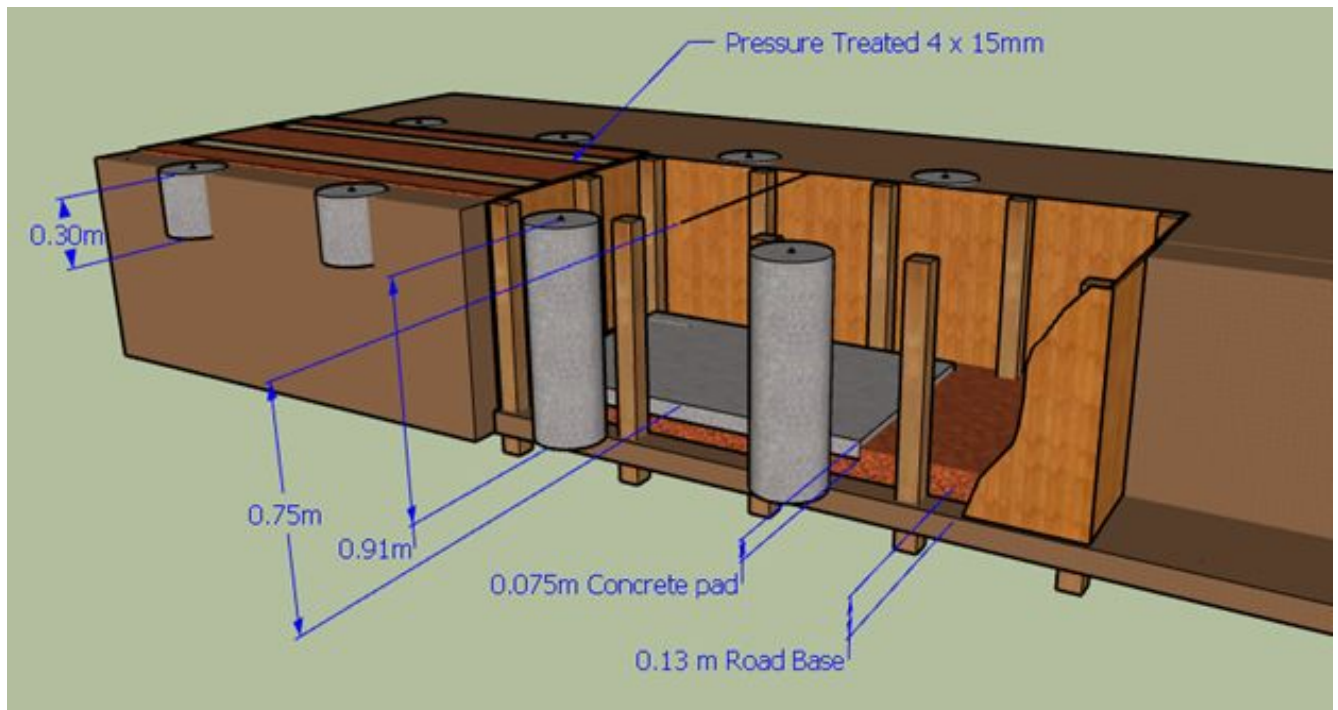
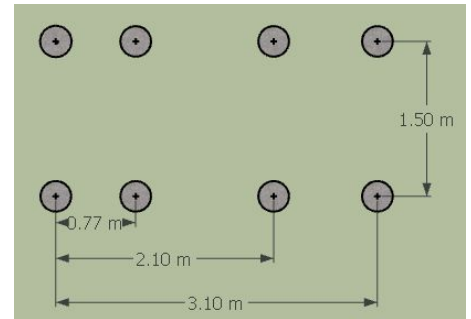

Sump Tank

Preliminary Checklist:

- ✓ Concrete footers are poured
- ✓ Wall Barrier for Sump and Access area is installed

Build Checklist:

- Modify the Sump Tank
- Drill inlet holes and install bulkheads
- Place Unit into place

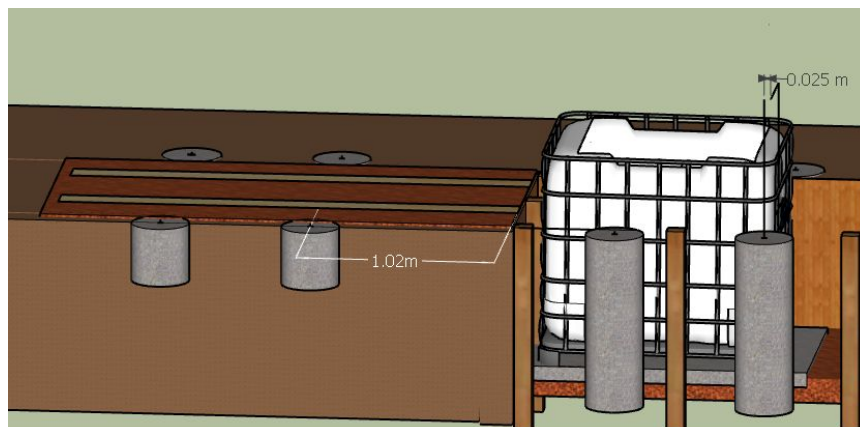
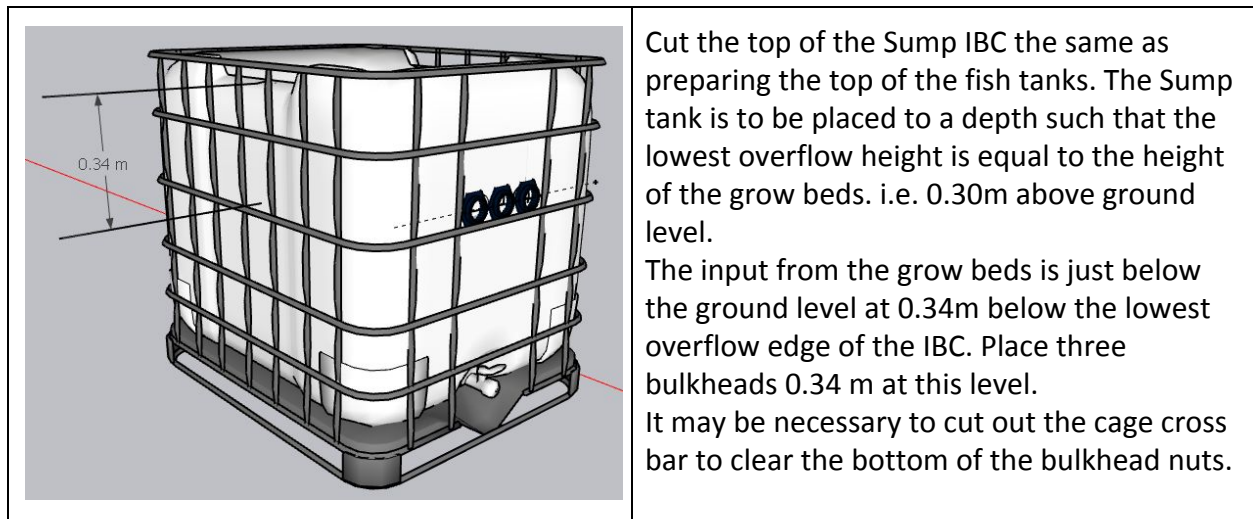

Construct the Bio Filter

Preliminary Checklist:





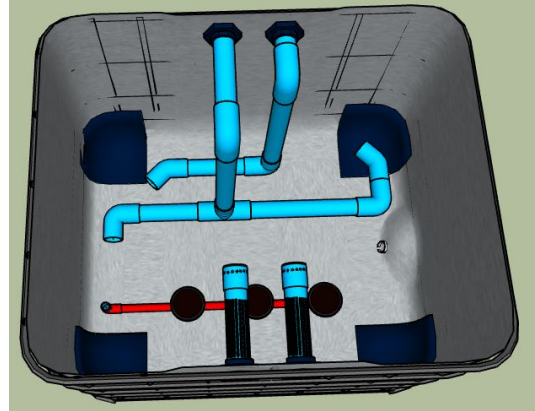

- ✓ Concrete Footers installed
- ✓ Sump tank installed

Build Checklist

- Cut Bio Tank
- Measure and drill holes for bio inputs
- Measure and drill holes for bio outputs
- Install bulkheads
- Construct and install input swirl units.
- Install Strainer attachment and Inlet Unit
- Install Air diffuser Unit
- Fill bio tank 60% full with bio surface material

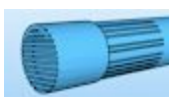

Parts List

Qty	Item	Photo	Qty	Item	Photo
1	IBC Tank		1	Bio Material 0.6 cubes	
2	Bulkhead Connector		1	Air Diffuser Unit	
2	Strainer Attachment		2	Inlet Unit	

Build Instructions

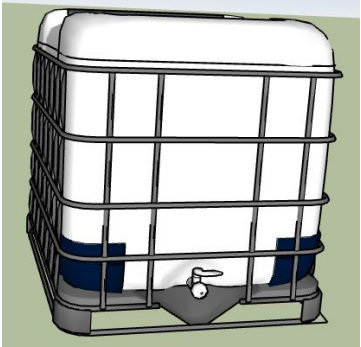
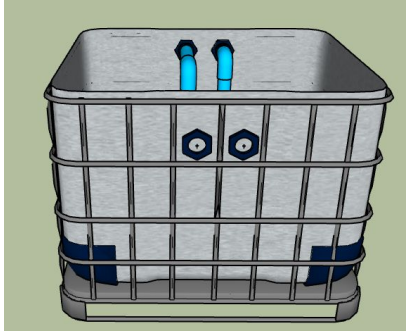
IBC Modification for Bio Tank	Cut the plastic 0.813m above tank bottom.	Completed Bio tank.
		

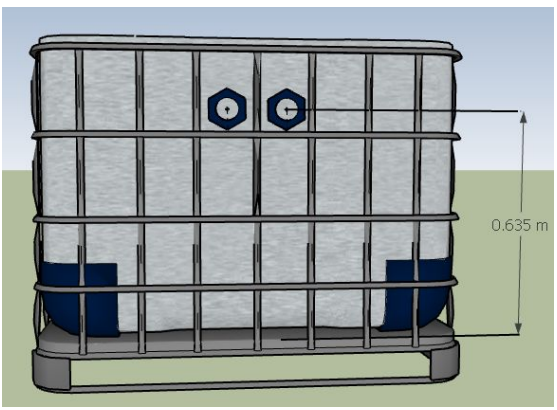
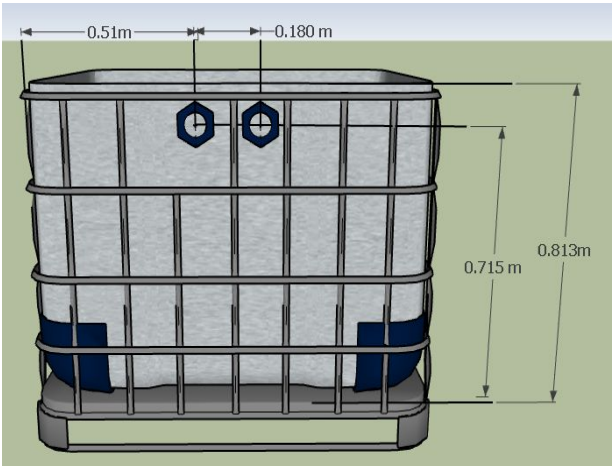
	<p>IBC drain is on the Right</p> <p>Drill output hole at 0.635m from bottom of tank and centered in the two central cage spaces with just enough room to spin the bulkhead nut.</p>
	<p>THESE BULKHEADS MUST ALIGN WITH THE MATALE OUTPUTS WHEN BOTH TANKS ARE CENTERED UNDER THE FISH.</p> <p>Drill inlet hole at 0.715m high centered and near top of the matching cage grid as the Matala output.</p> <p>Install input bulkhead.</p> <p>Measure and cut a 63mm pipe to connect Matala filter to bio tank</p>

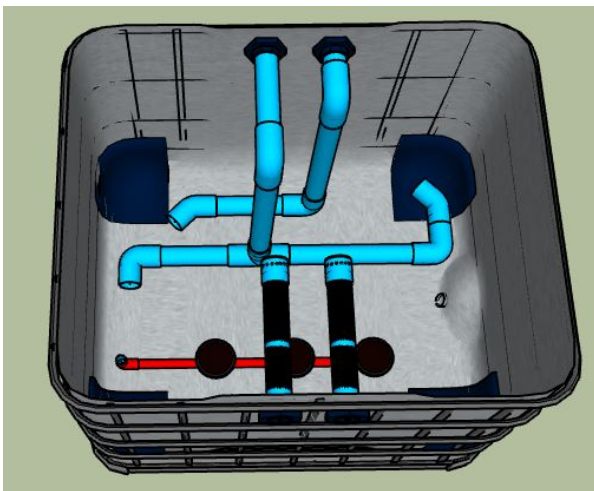
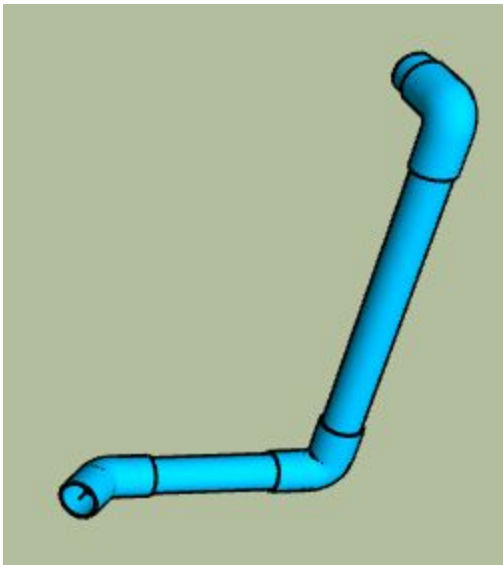
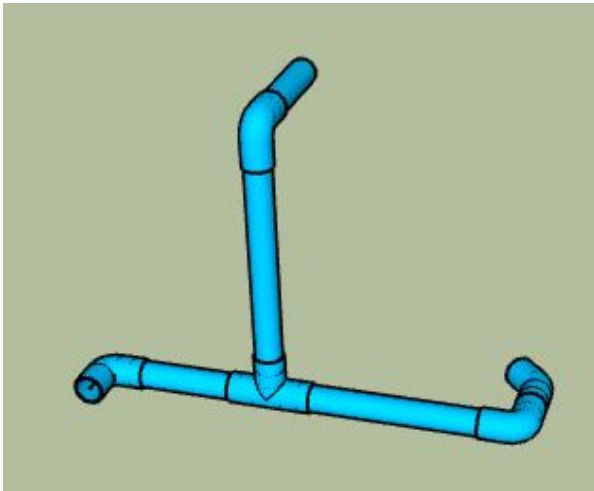

To assist in moving the Bio media in the Bio tank construct 2 Inlet Units to create a swirling current.

- 63 mm PVC
- 2 - 63mm 45 degree elbow
- 5 - 63mm 90 degree elbow
- 2 - 63mm Tee

Place in the bio tank near the center and near the bottom of the tank.

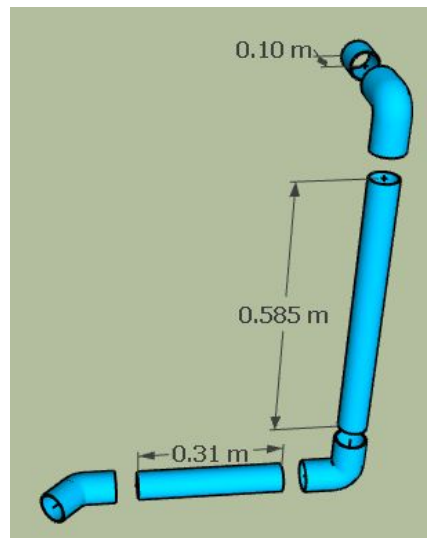
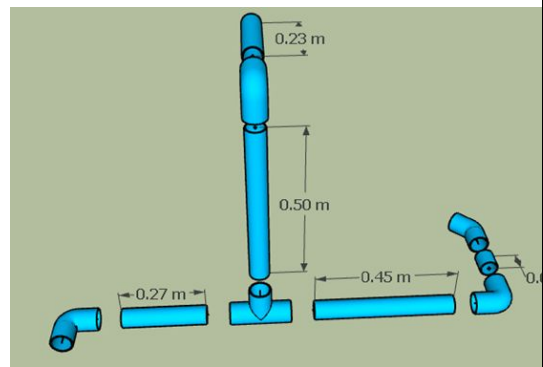

The unit closer to the inlet extends down to within 1 cm to the bottom.

The more centrally located unit extends to approximately 3 cm above the bottom.

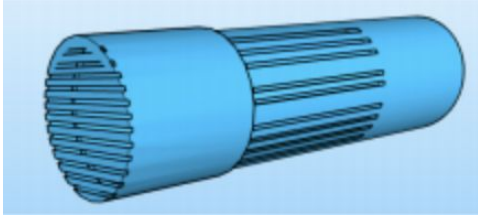

Make a strainer unit for the outlet of the bio filter.

Using 63mm piping and cap by cutting multiple slits in end and in the pipe.



Make a Diffuser unit for aeration of Biofilter

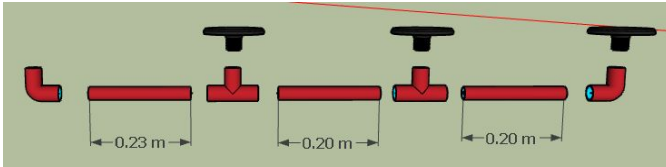

- 1 each - 1 inch PVC 90 Deg. Exbow
- 2 each - 1 inch PVC Tee with ¼ inch Threaded side
- 1 each - 1 inch slip x ¼ threaded PVC 90 Deg. Elbow
- 3 each - Diffuser discs : Mfr. Model # AB-70016

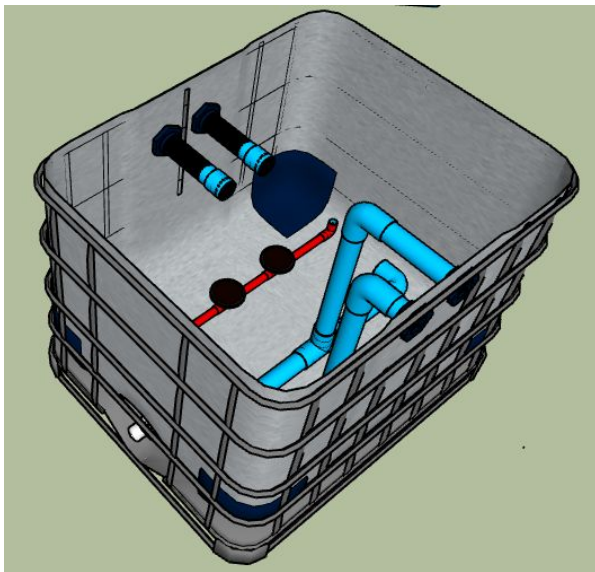

Install all parts into Bio Filter

Fill the dry tank to 60% of its total water volume with Bio Material.,



Construct Matala Filter

Preliminary Checklist:

- ✓ Sump Tank Installed
- ✓ Bio Tank Installed

Build Checklist:

- Cut Matala Tank
- Build Filter Frame
- Install Filter into Malata tank
- Drill output drain
- Install Bulkhead for output

Specifications:

Matala® Filter Frame: 2 each required. Parts List:

- 40 zip Ties
- 8 40mm PVC 90 Deg. Elbows
- 8 40mm PVC Tee's
- 7.0 m 40mm PVC Pipe
 - o 8 each 0.245m x 40mm PVC
 - o 8 each 0.545m x 40mm PVC
 - o 4 each 0.05m x 40mm PVC
- 4 each 1.0m x 0.5m Green Matala Filter pads
Matala® #110324

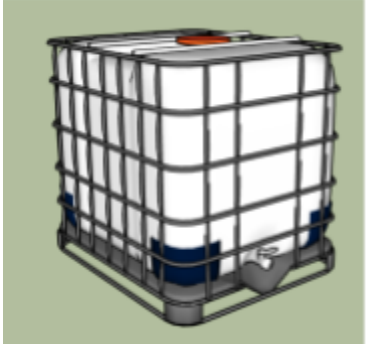
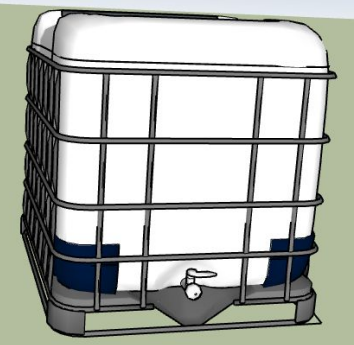
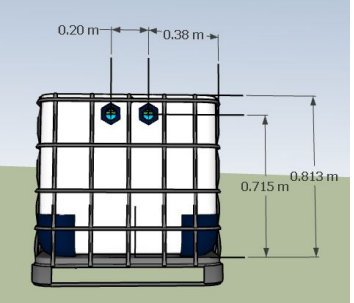

Build Instructions

IBC Modification for Matala	Cut the plastic 0.813m above tank bottom.	Completed Matala tank.
		

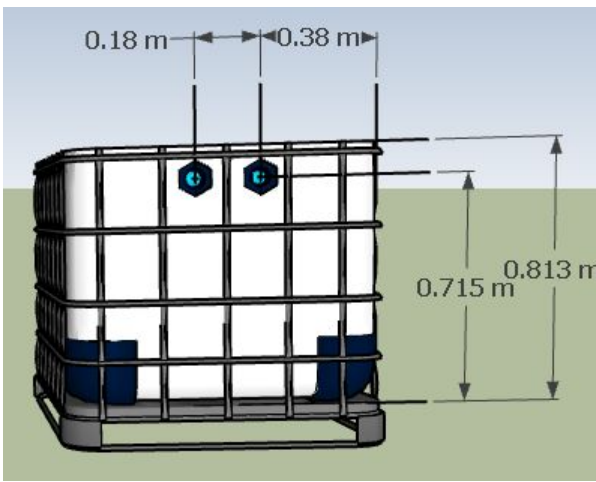
	<p>Drill and install a bulkhead fitting for outputs from the Matala.</p> <p>THIS OUTLET MUST ALIGN WITH THE INLET TO THE BIO WHEN BOTH TANKS ARE CENTERED UNDER THE FISH.</p>
------------------------------------------------------------------------------------	--------------------------------------------------------------------------------------------------------------------------------------------------------------------------------------

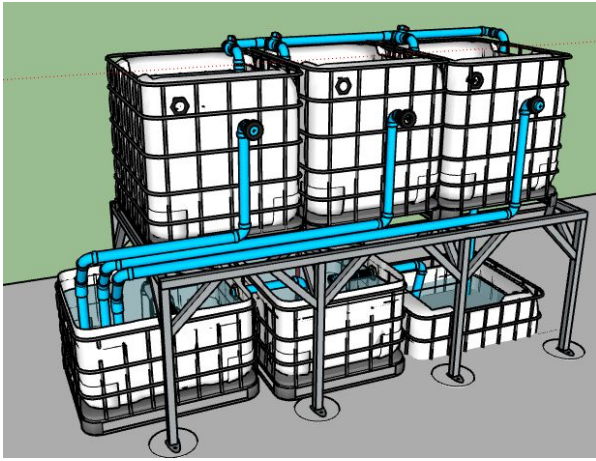
	<p>Measure and connect plumbing from the output of each individual radial filter separately to the Matala tank.</p> <p>The inputs to the Matala must enter the tank on the upflow side of the Matala filter element such that they do not interfere with the element or make the element difficult to remove.</p>
-------------------------------------------------------------------------------------	-------------------------------------------------------------------------------------------------------------------------------------------------------------------------------------------------------------------------------------------------------------------------------------------------------------------

Build Filter Frame

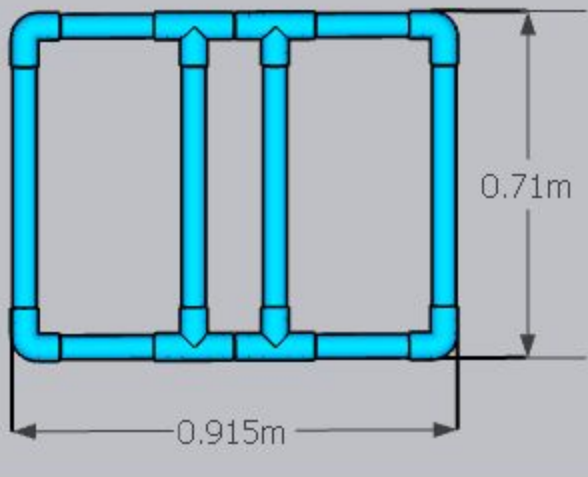
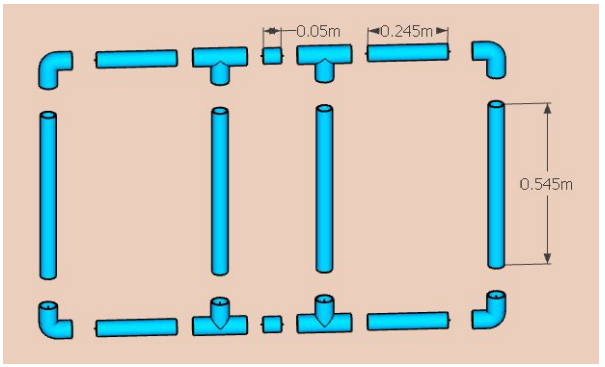
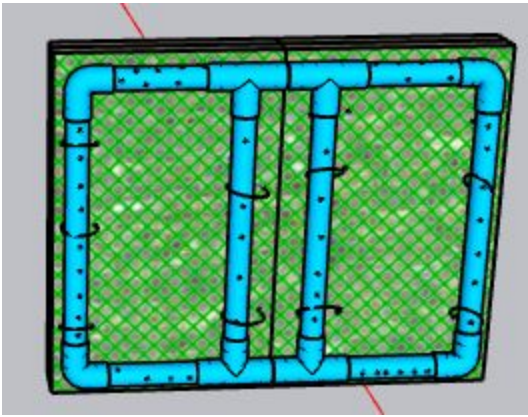
	<p>Matala Media Frame (2 each)</p> <ul style="list-style-type: none"> • 40mm PVC pipe • (8) 40mm PVC Tee's • (8) 40mm PVC 90 Deg Elbows • (8) 40mm x 0.545m PVC Pipes • (8) 40mm x 0.245m PVC Pipes • (4) 40mm x 0.05m PVC Pipes
	<p>Drill 0.006m holes in the tubes to prevent floatation.</p> <p>Place (4) Matala® media pads in the frames, press tightly together in the center, and press zip ties through the media to tightly bind both side frames to the media.</p> <p>Cut the Matala pads larger than the frame to fit tight against the sides and bottom of the Matala IBC.</p>
	

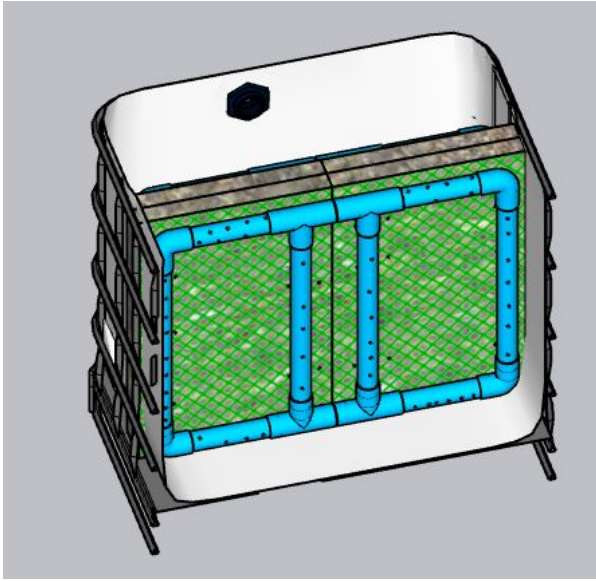

Cutaway view of the Matala IBC with the media pressed tightly against the sides and bottom of the IBC.

Trim bottom corners to fit tank curvature, and press down tightly to form the media to the side curvature and bottom of the IBC.

The media pads are pressed tightly together in the center of the frame.

The top of the media pads are above the top of the outlet port.

All water flow is through the Matala pads.



Construct and install the filter element hold down bar using two (2) tee connectors and 63mm pipe

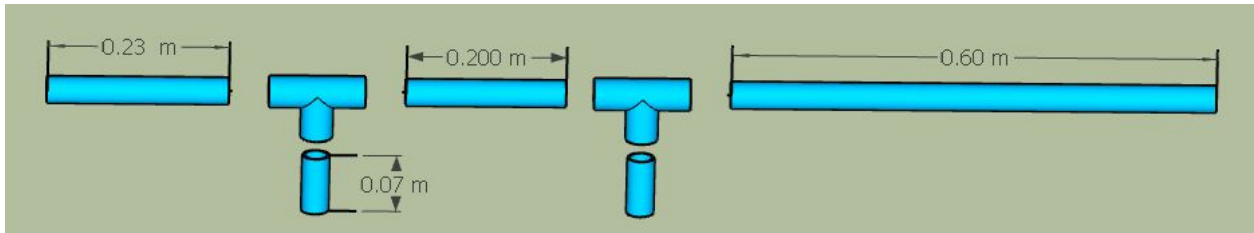

Place Bio and Matala Tanks in position (NOTE: Bio Tank is rotated 90 Degrees from other

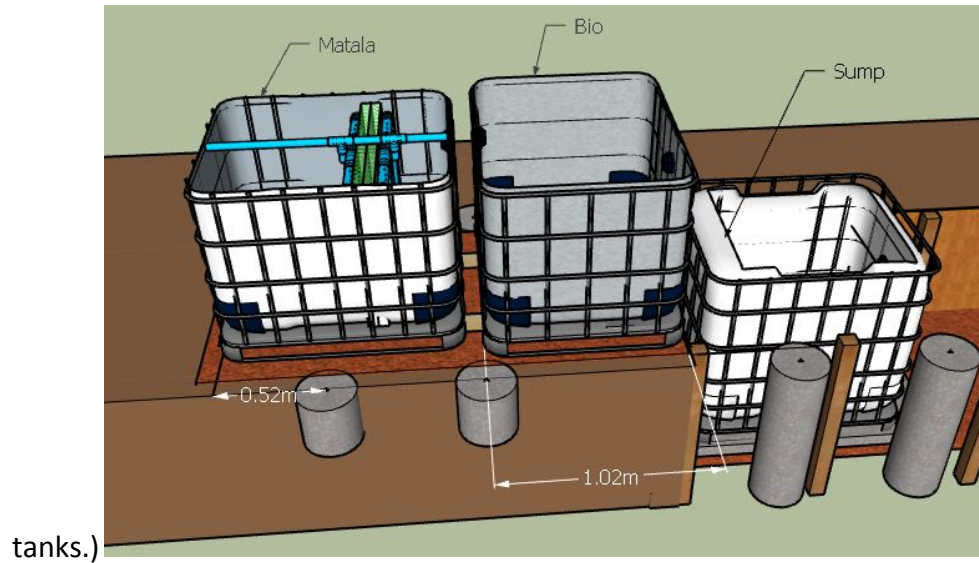

tanks.)

Construct Fish Rack

Preliminary Checklist:

- ✓ Concrete footers are poured
- ✓ Sump is installed
- ✓ Bio Tank is installed
- ✓ Matala Tank is installed
- ✓ You have ensured rack will fit through door or are it fabricating it inside

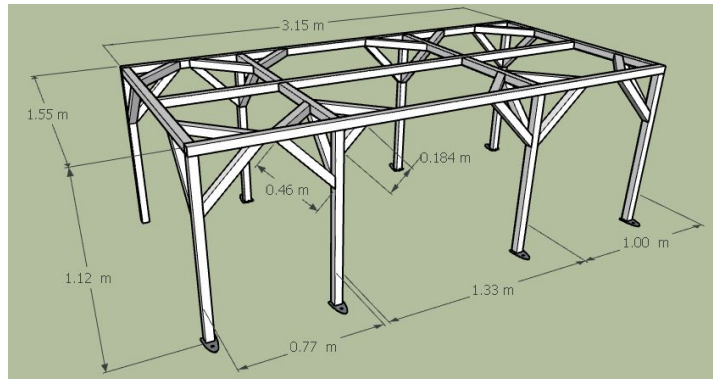

Build Checklist:

- Build Fish Rack table
- Set rack on cured concrete footers (used shims to achieve level table)
- Anchor Fish Table Rack to concrete

Fish Rack Specifications

- Made from 5 cm 11 gauge square tubing
- The leg spacing(0.77)m and inside dimension between the center side legs (1.28 m) is critical

Parts List

- 8 legs - 1.07 m
- 2 long top beams - 3.15 m

- 1 center top long beam - 3.05 m
- 2 top end beams - 1.45 m
- 4 top cross beams - 0.70m
- 30 angle braces - 0.46 on long side
- 2 angle braces - 0.184 on long side of 45 degree cut
- Concrete anchors for table - 8 count

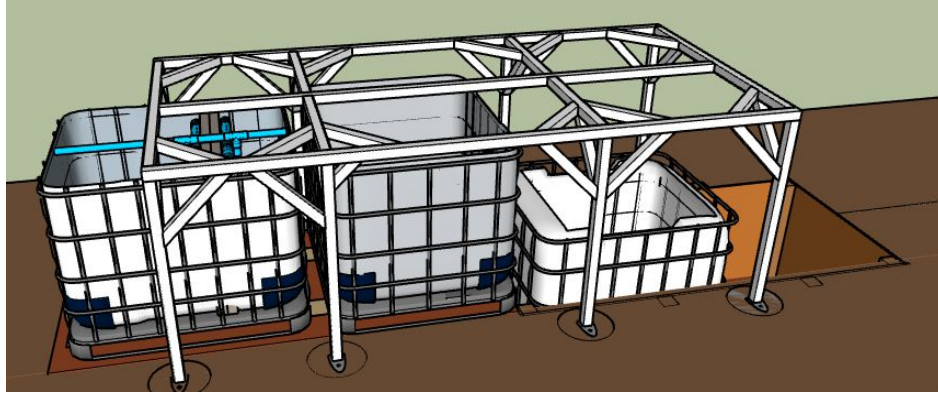

Prepare Fish Tanks

Preliminary Checklist:

- ✓ Sump, Bio, Matala tanks are installed
- ✓ IBC Tanks for fish tanks are cleaned from dirt and debris
- ✓ Fish tank rack is set and secure

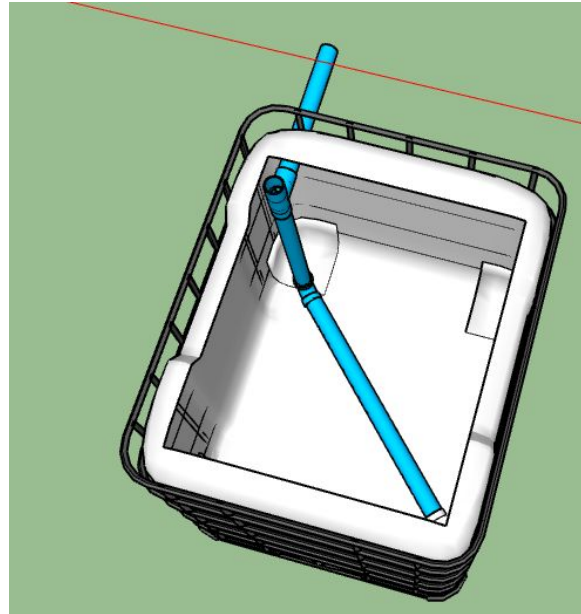

Build Checklist

- Remove top cross bars
- Cut out the top of the tank
- Remove plastic tank
- Insert Insulation liner
- Replace plastic tank
- Add water to settle tank
- Drill Output Hole
- Install SLO Plumbing (*Do not glue*)
- Place finished tanks on Fish Rack Table



Fish Tank Build Instructions

Three IBC tanks are shown side-by-side. The first has a red cap. The second has a red cap and a small hole in the top. The third has a grey cap and a larger hole in the top.	<p>Cut only the top of the IBC, do not cut along the sides of the tank</p>
A white plastic tank with a blue base and a metal wire frame are shown side-by-side. The plastic tank is on the left, and the metal frame is on the right.	<p>Remove the plastic tank from the metal frame</p>

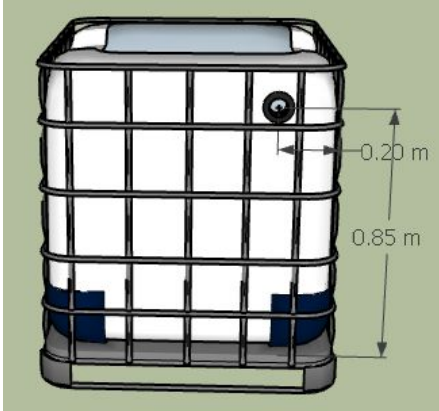
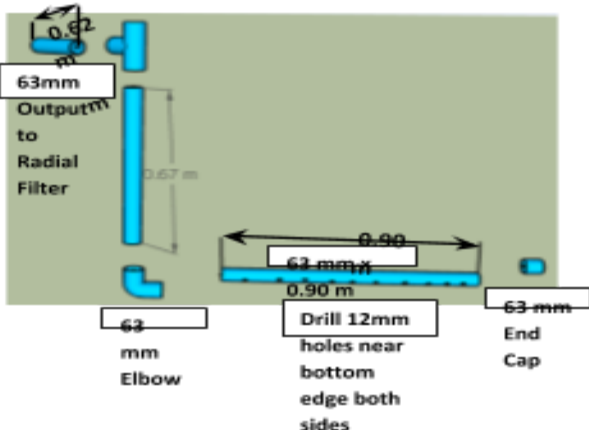
	<p>Using reflective roll insulation line the bottom and inside of the IBC cage for insulation and to limit algae growth. Insulation thickness should be approximately 5 mm uncompressed.</p>
	<p>Slide the container back inside the cage inside the reflective insulation.</p>
	<p>The output hole for the 63mm bulkhead fitting should be centered 0.85m from bottom of the tank and 0.20m from the edge of the plastic tank on the opposite side from the tank drain.</p> <p>Note: bulkhead should both clear the metal ring and seat fully on the flat of the tank (not into the top curve).</p> <p>NOTE: Various bulkhead manufacturers require different size holes for the same pipe size; observe manufacturer instructions.</p>
	<p>This apparatus is called a Solids Lift Overflow or SLO.</p> <p>It consists of :</p> <ul style="list-style-type: none"> ● 63mm PVC pipe ● one end cap ● one elbow ● one Tee

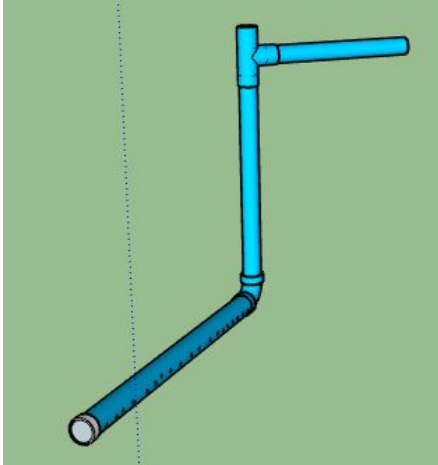

The bottom capped pipe with holes drilled in it. It lies diagonally on the bottom of the fish tank IBC.

Note the top fitting must be a Tee and not an elbow to prevent a siphon from developing and draining the fish tank.

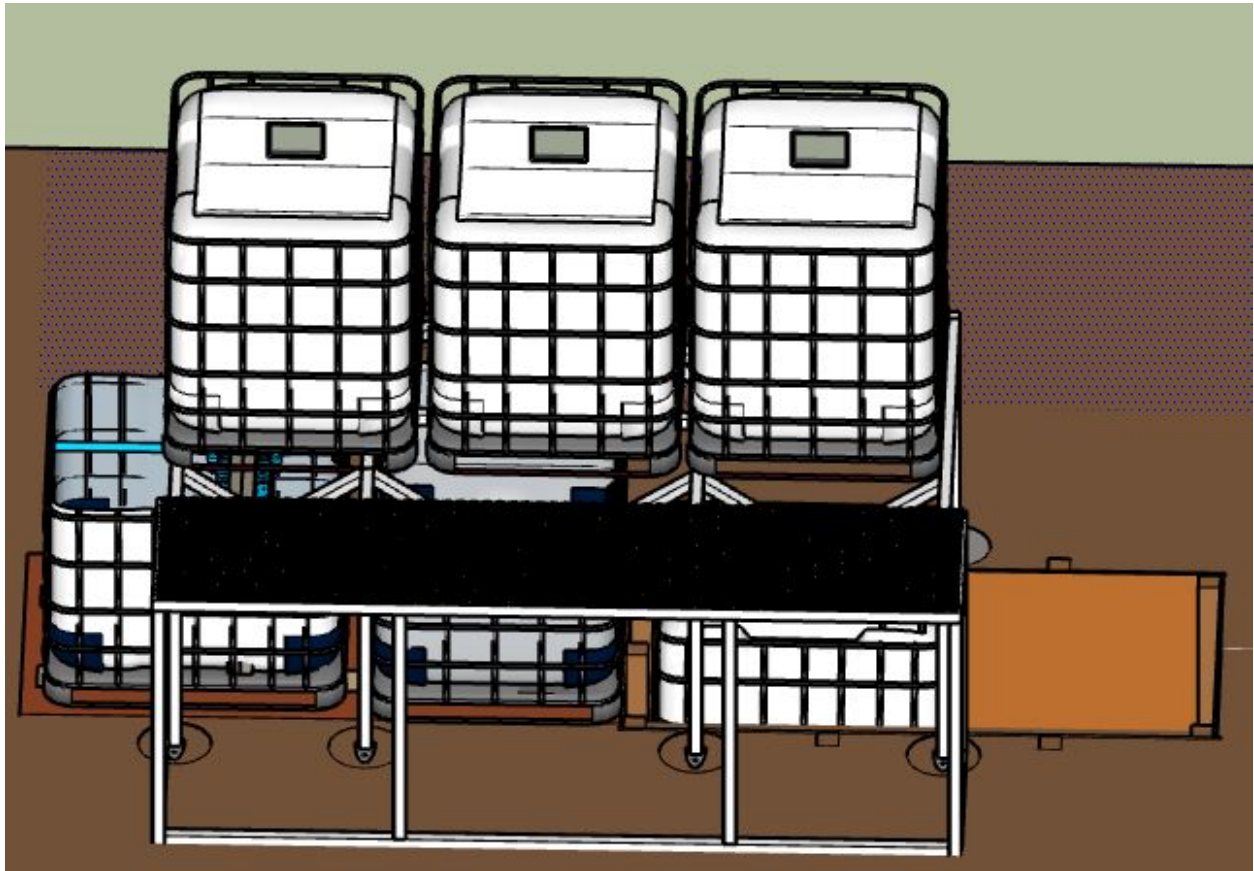

Prepare Radial Filters

Preliminary Checklist:

- ✓ Sump, Bio, Matala & Fish tanks are built and installed
- ✓ Radial Filter Stand is built and installed

Build Checklist



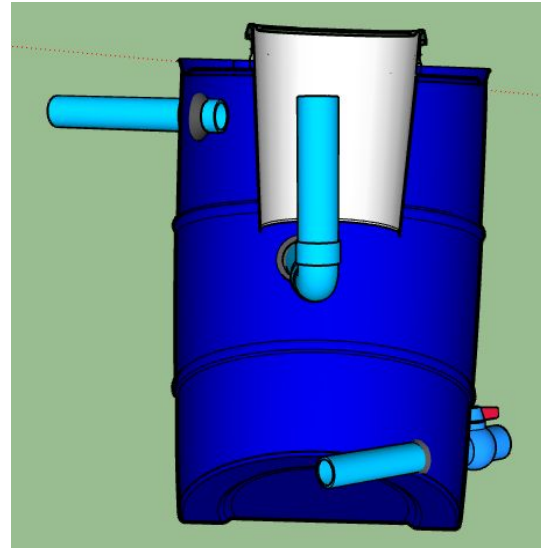

- Drill holes and cut barrels
- Install Bulkheads/Uniseals
- Install Piping and valves
- Position tanks on Radial Filter Stand
- Connect to Fish tanks





Specifications:

There needs to be three units.

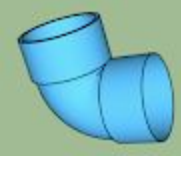
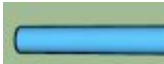
Parts List

Qty	Item	Photo	Qty	Item	Photo
3	63mm Uniseal®		1	19 L Bucket with Lid	
1	63mm Ball Valve		1	200L barrel	
2	63mm 90 degree elbow		4	0.37m section of 63mm PVC	

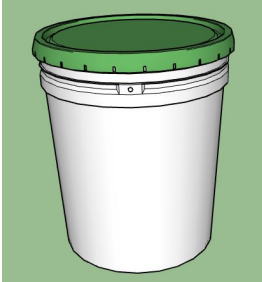
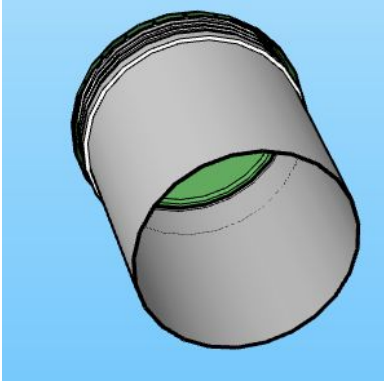
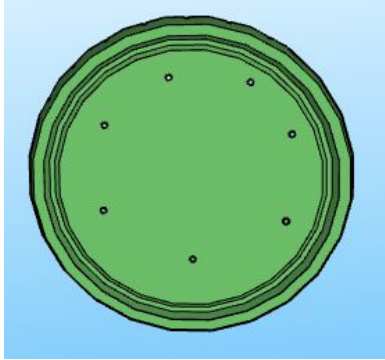
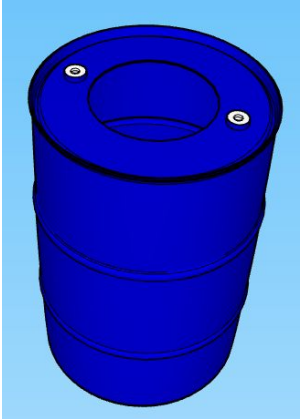
Build Instructions

	<p>Remove bail/handle from bucket</p>
	<p>Cut bottom out of buckets. Drill several 6mm holes around lid perimeter for air escape</p>
	
	<p>Cut hole in the top of the barrel for the bucket to fit loosely but will not fall through.</p>
	<p>Attach ball valve to 37cm x 63mm PVC to make drain outlet</p>

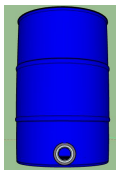

Make Hole 0.06 m from bottom and place uniseal. Then push the cleanout pipe through to the center of the barrel as shown in cut-away drawing.

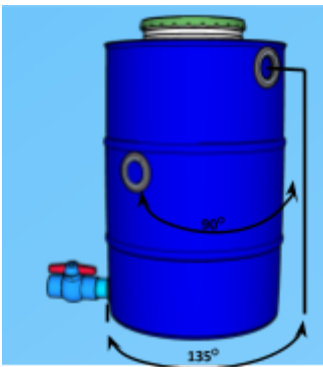

Cut the upper hole 0.06m down from the top 135 degrees ccw around the barrel from the cleanout drain and install a 63mm Uniseal® This will be the out flow from the radial filter. Install another 63mm Uniseal® 0.4 m down from the top of the barrel 90 degrees ccw around the barrel from the top uniseal. This will be the input from the fish tank. (See top view below for orientation.)

NOTE: Hole size for the Uniseal is critical follow the instruction chart that comes with the grommet

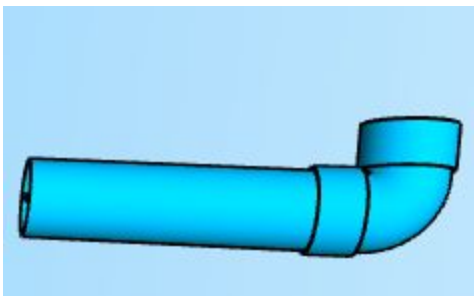

A 37cm pipe with elbow is inserted in the hole 40 cm down from the top of the barrel.

- Now place the bottomless bucket in the barrel as shown in the cut-away drawing

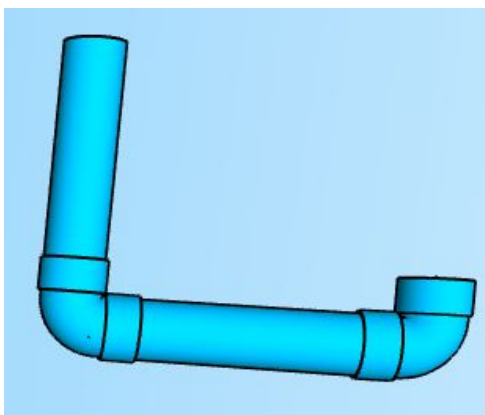

An elbow and a 37cm pipe will be attached after the above is inserted to a distance that makes the vertical pipe to be centered in the bottomless bucket as shown in the cut away drawing.

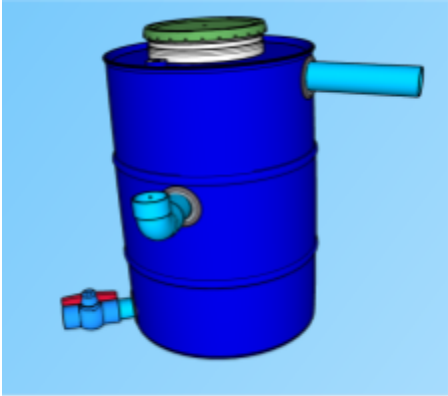

Outside view of a completed Radial filter. See cut-away drawing for inside view.
Make three radial filters per system.

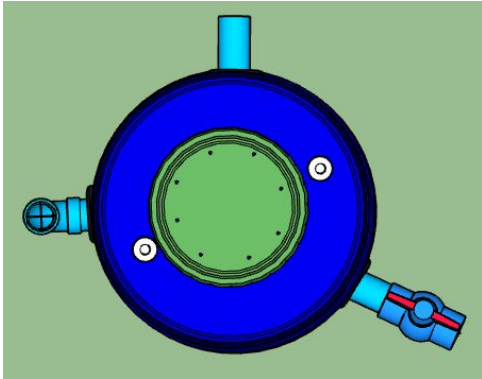

Top view of radial filter

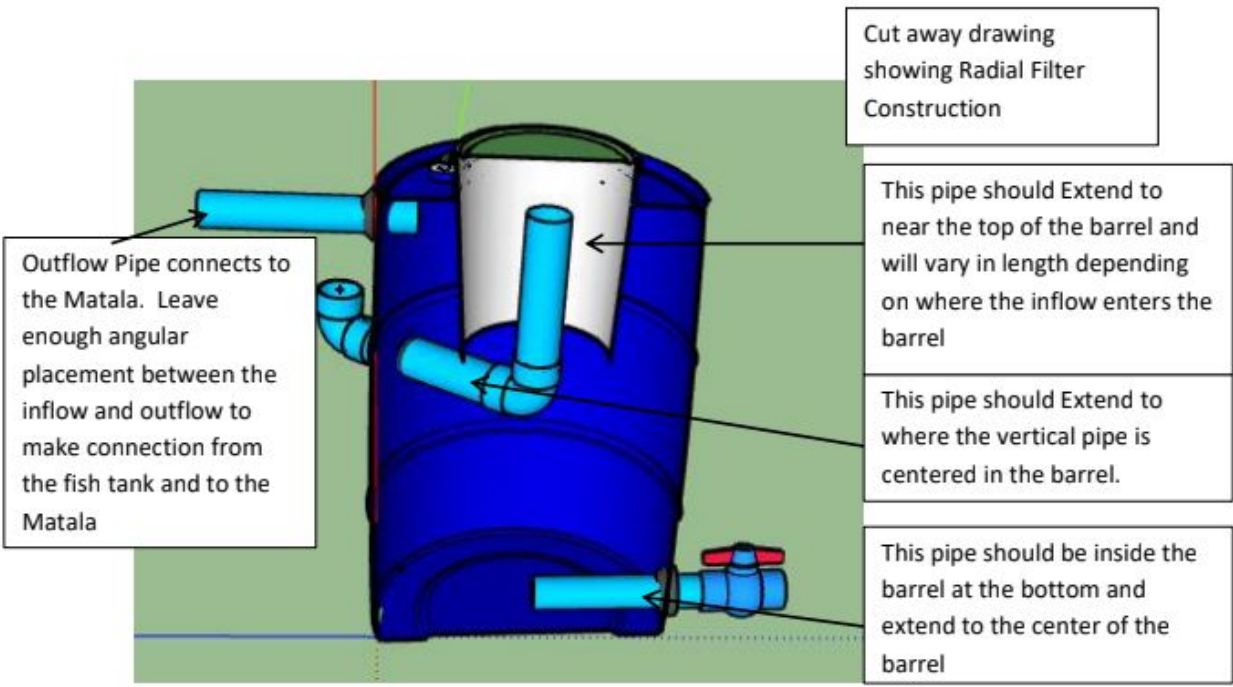

Build Radial Rack

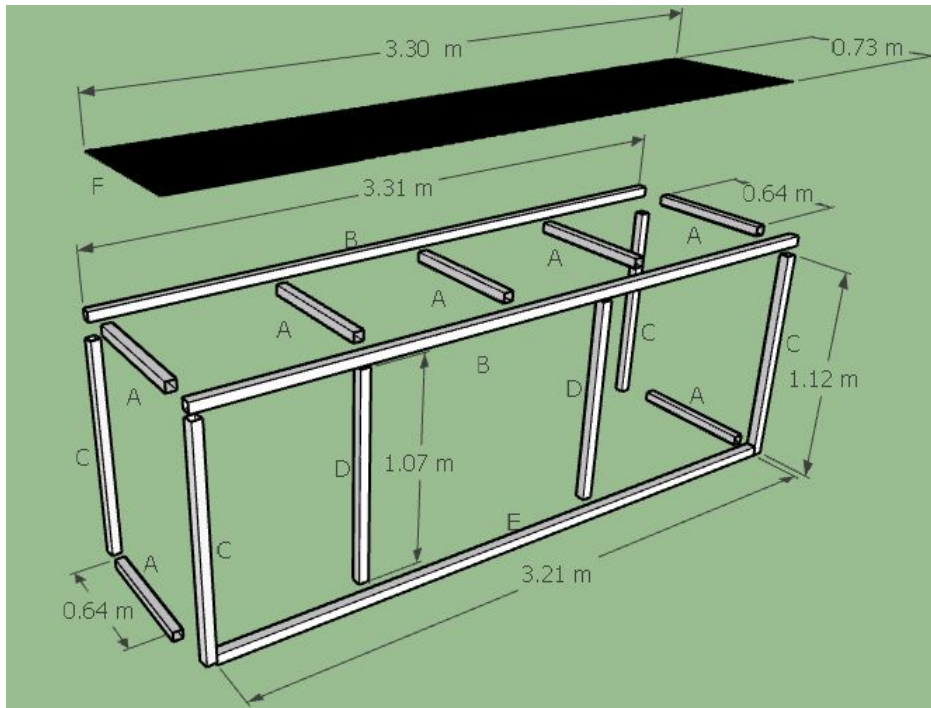

Parts List: Made from 5mm square tubing

- A – 0.64 m 7 each
- B – 3.31 m 2 each
- C – 1.12 m 4 each
- D – 1.07 m 2 each
- E – 3.21 m 1 each
- F – Expanded Metal Grid 3.30 m x 0.73 m

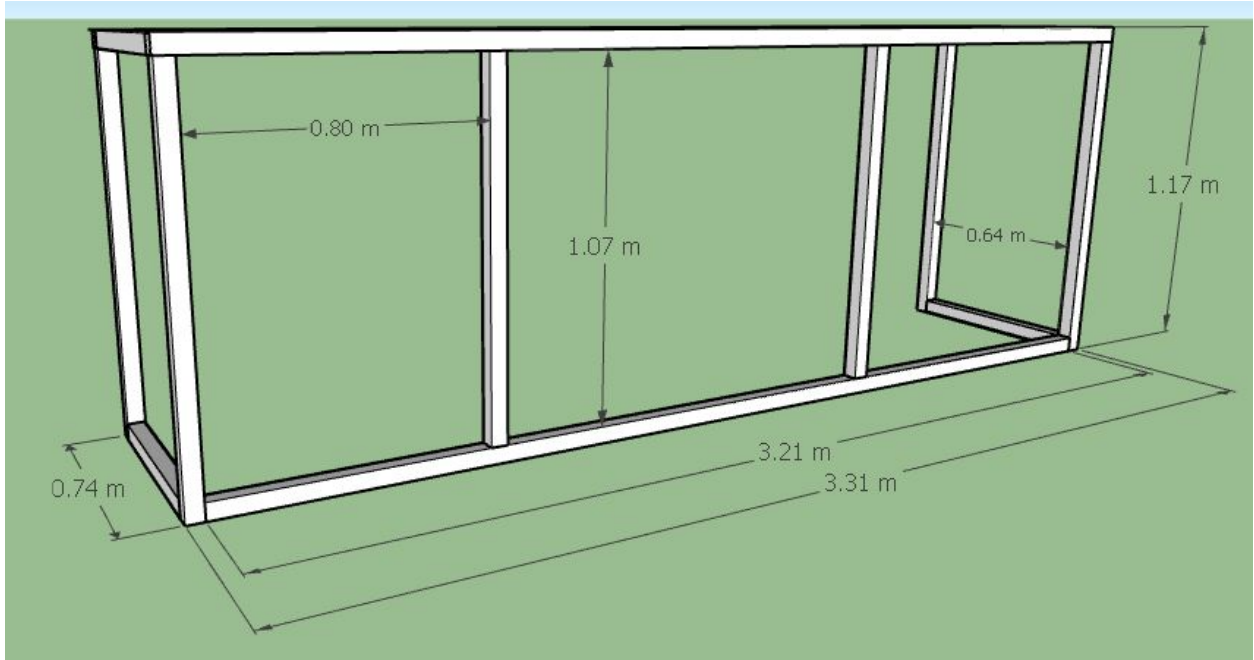

Assembled view

Radial Rack fits over the edge of the fish rack

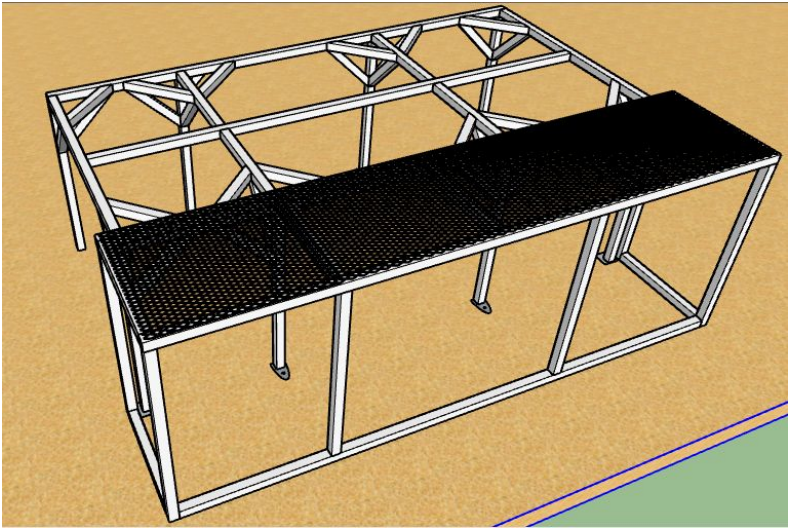
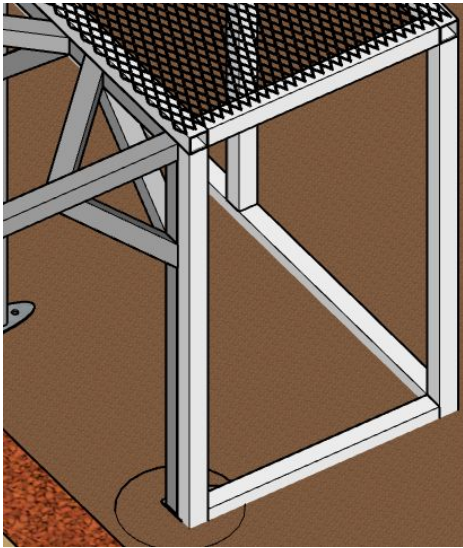

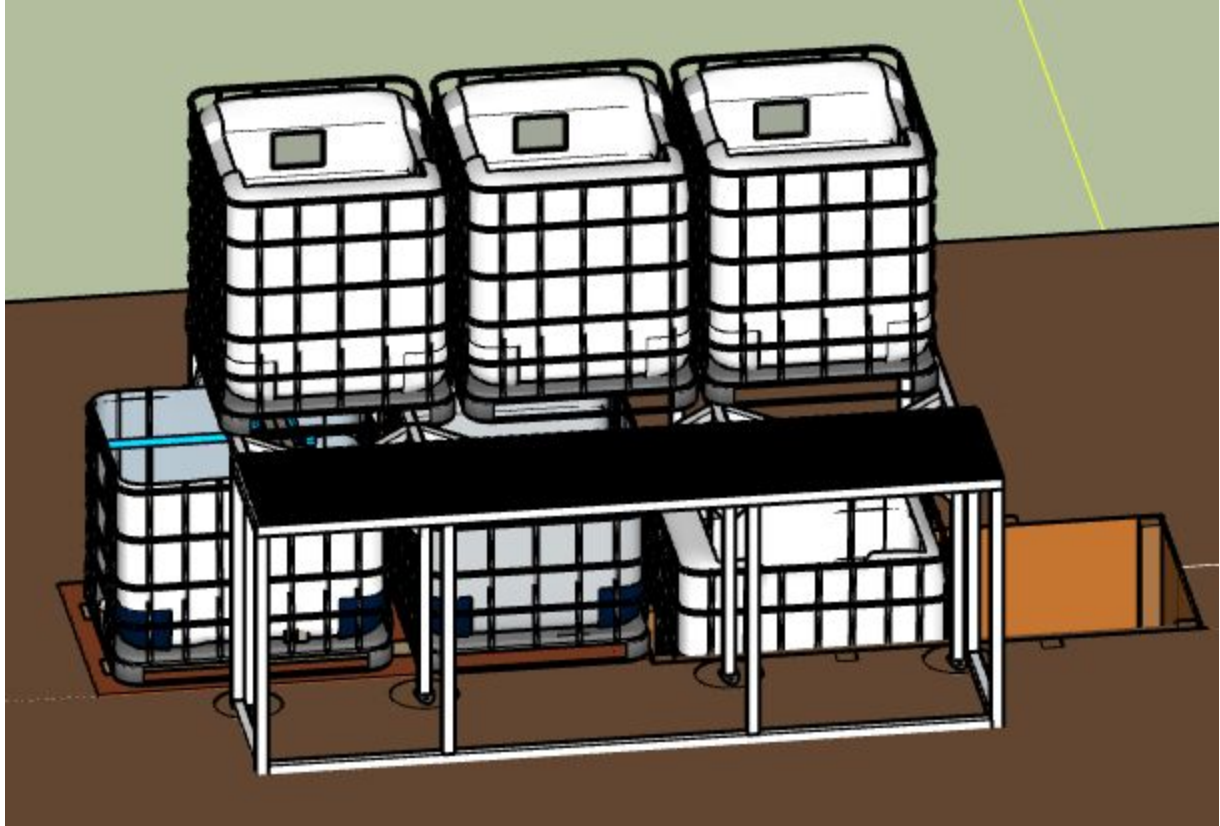

Positioning the radial filters

1. Radial Filters may be raised up to 10 cm below the output of the fish tanks.
2. Radial filter outputs must be higher than the matala filter highest point to drain into it.

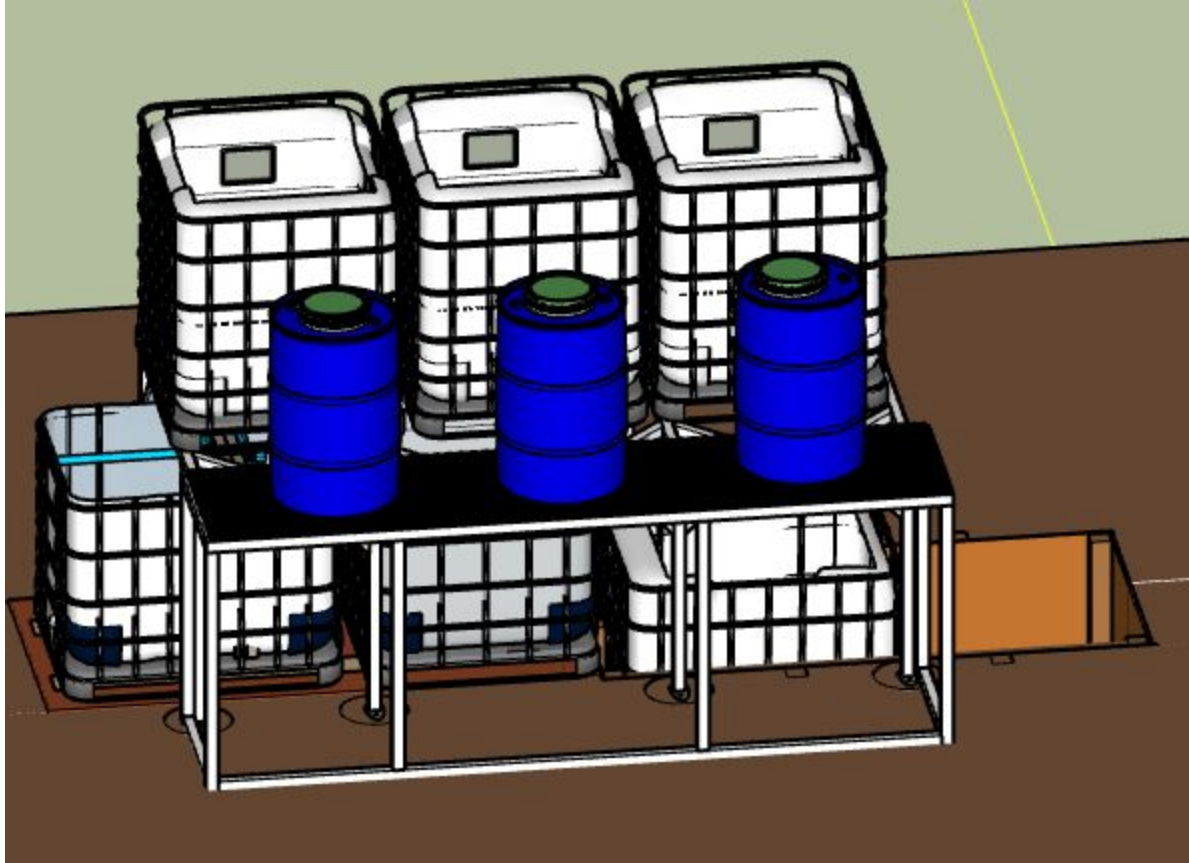

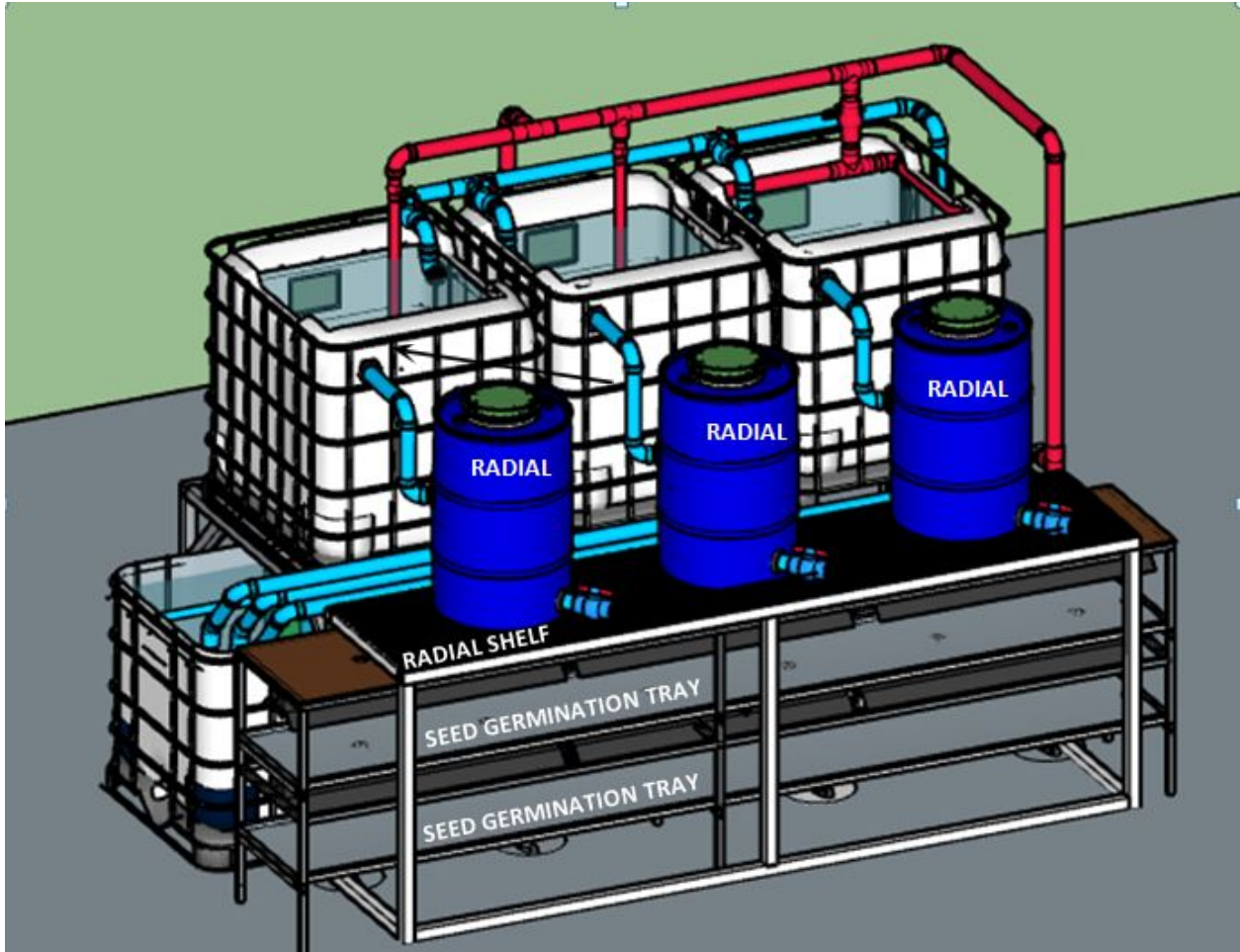

Raise the Radial Filters by placing on a base with an option to put seed germination underneath

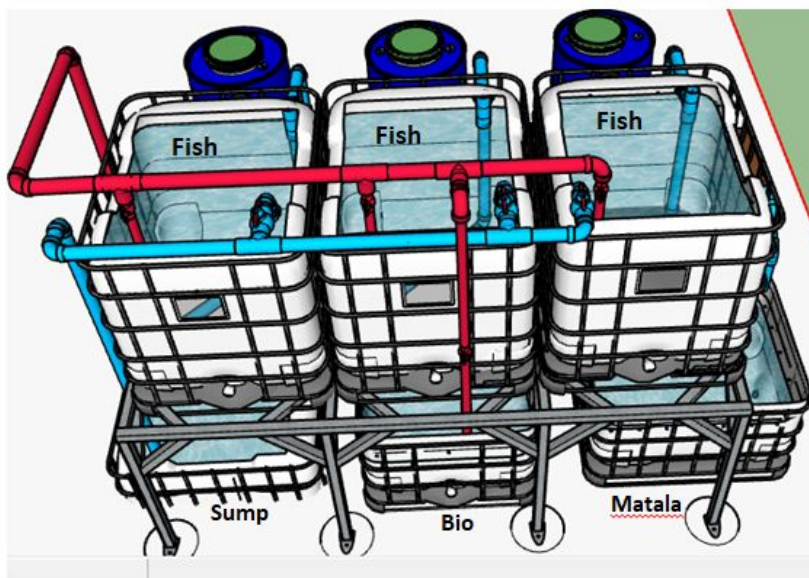

Grow Module

Preliminary Checklist:

- ✓ Fish Module is built and installed
- ✓ Ground for Grow beds is level

Build Checklist







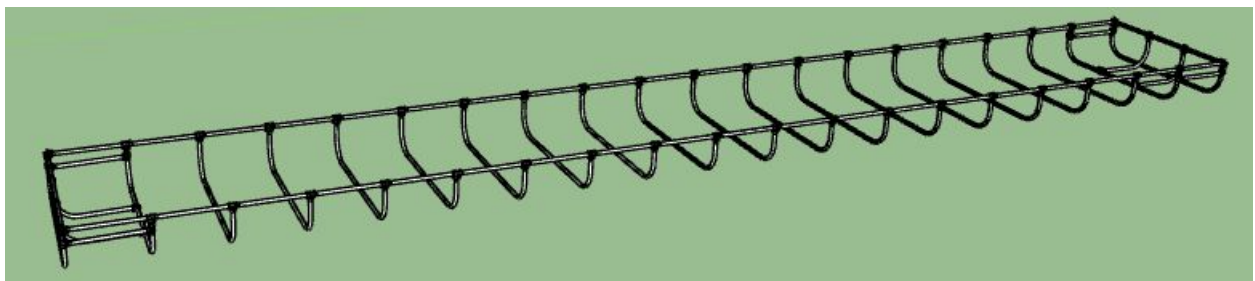



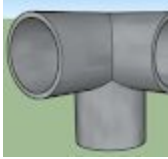

- Construct grow beds
- Position each grow bed according to the layout
- Cut to fit and place appropriate foam insulation material
- Measure and cut grow bed lining material
- Install the lining, attach clips to hold in place
- Install Bulkhead at the end of the bed
- Attach outlet pipes to Sump Tank
- Install inlet piping
- Connect aeration to all beds

Specifications & Notes

- Each grow bed is 9.2 meters in length, 1.2 meters wide and 0.3 meters high
- Total volume of water in each bed is 3300 liters of water
- Conduit and Conduit fittings can be as small as 19mm up to 25mm
- Instructions are shown for bending pipe, however there may be capabilities to hire someone to use a hydraulic press to bend the pipe into the proper dimensions.

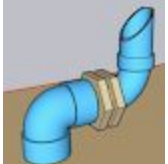

Parts List (For one grow bed)

Qty	Item	Photo	Qty	Item	Photo
20	Standard Rib Conduit		52	Tee Connector	
2	Special End Rib Conduit <i>With two tees on before bending</i>		4	Corner Connector	
4	Short Rib Conduit		12	End Board Clamp	
2	End Top Rail Conduit 1.27m		1	Bulkhead Board	
8	Brace Conduit Piece 0.462m		1	Bulkhead Connector	
2	Side Top Rail Long Section 5.64m		1	Drain Unit	
2	Side Top Rail Short Section 3.56m		17	Insulation Boards 1.2m x 0.455m	

Parts List Explanations

Bending Tool: Video of an electrician teaching use of the bending tool:
[Click this link.](#)

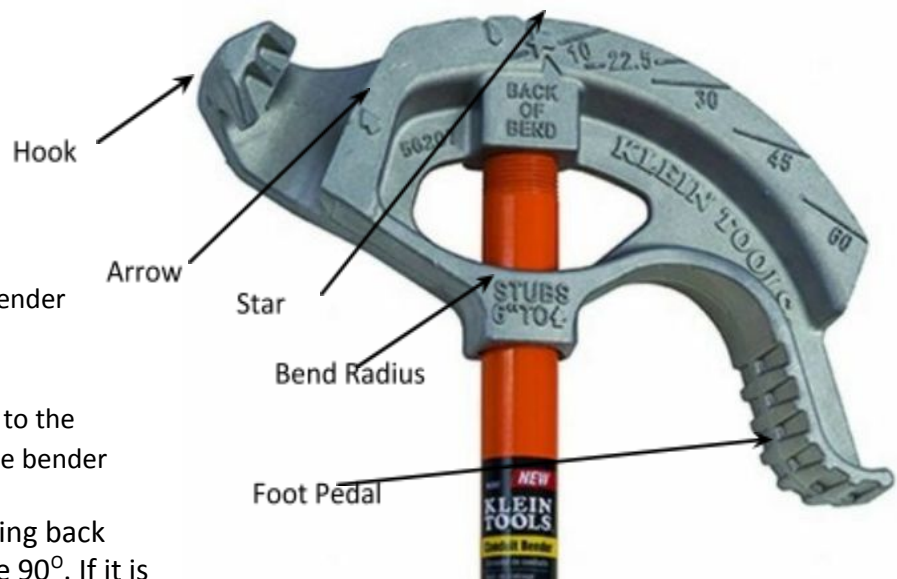

Key parts of bending tool:

- Hook – Holds conduit in bender
- Arrow – Start of bend
- Star- Center of 90° bend
- Foot Pedal- Holds conduit to the floor so it only bends in the bender

**When bending, check for spring back and adjust the bend to give true 90°. If it is not kept tight against the floor the bender may slip down mid bend, make a kink, or the pipe beyond the bend will have a bend as well.

Bending Jig

Conduit bending jig to help keep bends in the same plane.

Made of 2 x 4 boards and 6.5 cm wood screws.

Cut 4 boards to the following lengths.

- 1 each - 1.5 m
- 1 each - 0.79 m
- 2 each - 0.75 m

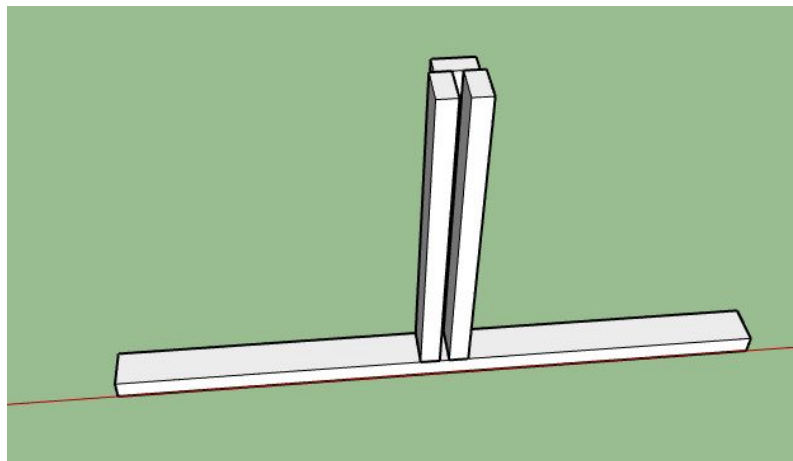

Constructing the Grow Beds

Build Order:

1. Bend Standard Ribs (18 per bed)
2. Bend Special Ribs (2 per bed)
3. Bend Short Ribs (4 per bed)
4. Fabricate End Rib Assembly (2 per bed)
5. Assemble End Unit (2 per bed)
6. Install Plywood Supports
7. Assemble Bed

Important Points

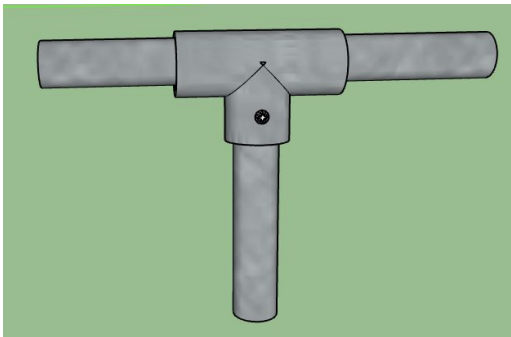



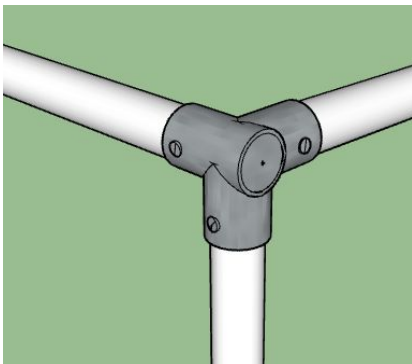

Secure each Tee with a set screw or rivet through the rib

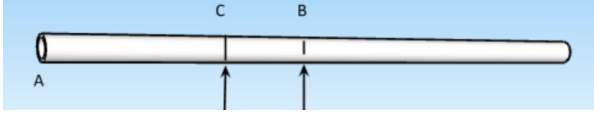

Secure each corner with set screws or rivets

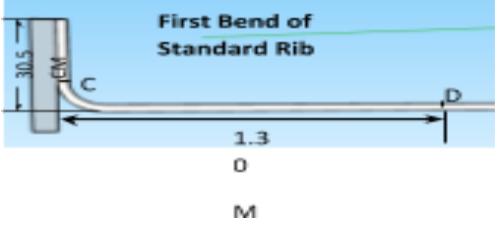
Bending Standard Ribs

	<p>From end of conduit measure 0.15m and mark C</p>
	<p>Place the conduit in the bender with the hook between A and C.</p> <p>Slide the conduit to where <u>the Arrow lines up with the C mark.</u></p> <p>While pressing down on the Foot Pedal with your foot, keep the conduit firmly against the floor, and smoothly without hesitation bend the conduit to 90°</p>
	<p>Using a straight edge against the A-C outside edge measure 1.30 M or 130 CM and mark D.</p>
	<p>Place the conduit in the bender with the Hook beyond the D.</p> <p>Slide the conduit to where the Star on the bender lines up with D.</p>

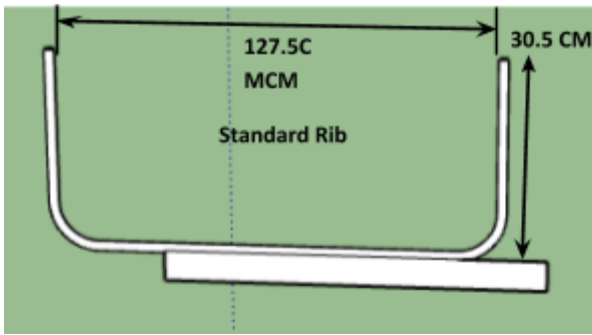

Align the bender handle making sure the new bend will be in the same plane as A-C. Bend the conduit just beyond 90°. **Use the 2x4 bending jig** to hold the A-C vertical as you bend, helping keep the A-C pipe in the same plane as the new bend.

Place a straight edge on the outside of the B-D edge and measure 30.5 CM, mark and cut conduit. Before cutting, make sure both vertical arms are of equal length. Debur the inside of the cut edge.

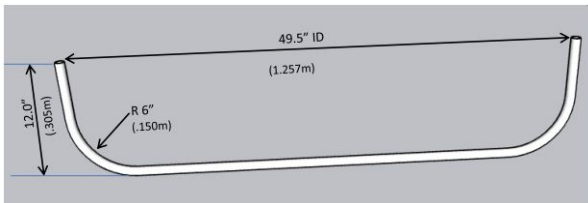

When the new rib is formed it should lie flat on the floor with both vertical arms flat on the floor. If not, use the hollow conduit bender handle and twist the rib to align so both vertical arms are in the same plane and both will lie flat on the floor. Measure the new rib to verify the inside dimension between the arms is 125.7 CM ± 2 mm. If not bend the arms equally on both sides to obtain 125.7 CM.

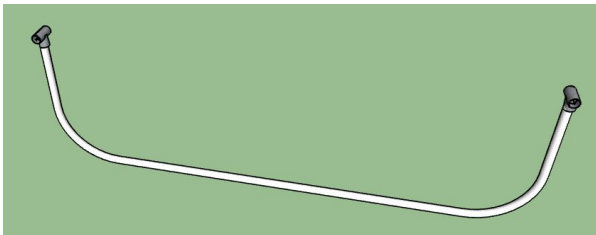

Put a tee on each end of the rib and secure tightly to the pipe

The centerline length of this pipe = 69 3/8" (1.761m) . During bending the inside radius is compressed and the outside radius is stretched. The exact length of the pipe before bending will depend on stretching/compression factors plus the diameter of the pipe plus the bending tool's selected radius. If cutting before bending is necessary, cut the pipe a known length little long then cut the final bend leg to size. If bending is repeatable, measure the amount cut off and subtract it from the initial known length, then it may be possible to precut remaining pipes to that length. Make sure measurements are made to a straight edge against the length and side to avoid errors due to the curvature.

Bending Special Rib

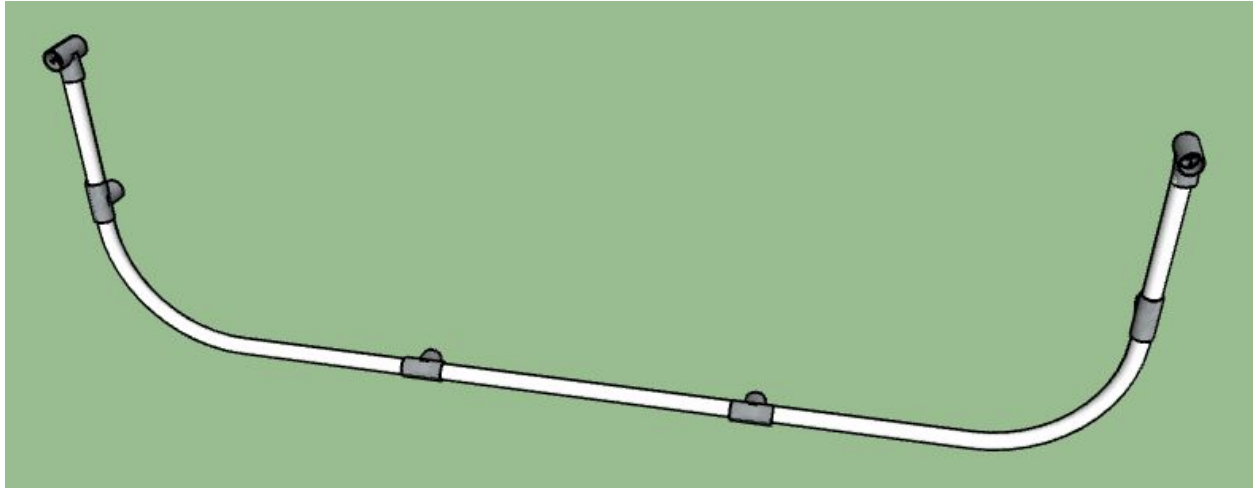

Follow the instructions for bending the standard ribs but **prior to bending**, add two tees to the unit to be used for the end unit assembly. The tees are unable to be installed AFTER the conduit has been bent.

In addition to having two tees on the bottom of the rib, add two tees on the sides for support conduit installation

Bending Short Rib

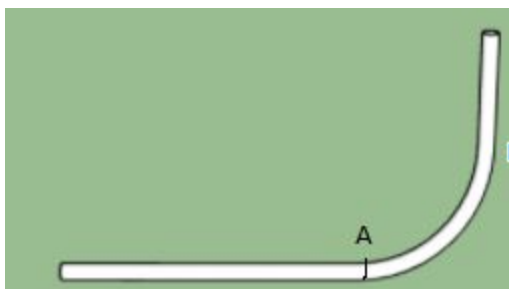



0.480 m Long x 0.30m High

Measure 0.330 m and mark A. Place the bender arrow on the mark and make the 90 Deg. bend. Place a straight edge along the bottom and measure the height, 0.30 m, and cut to height.

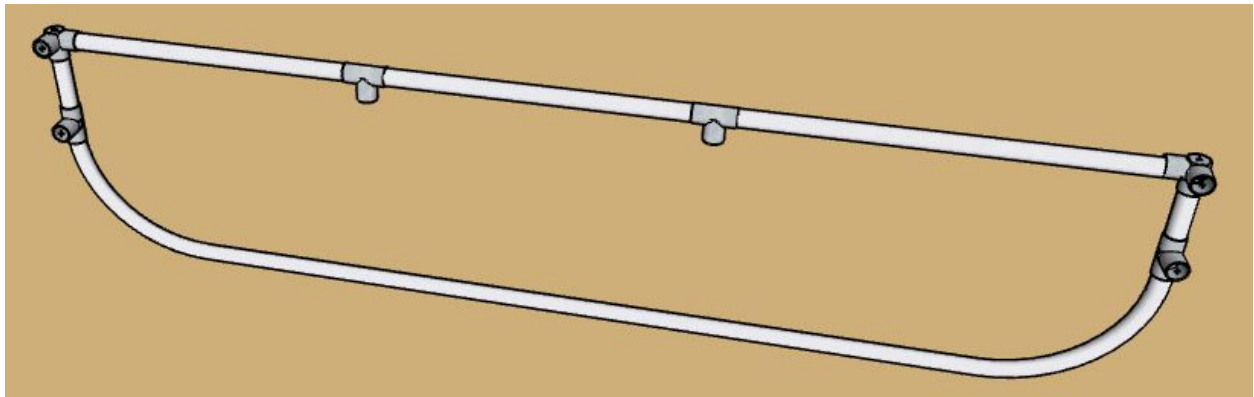
Fabricating End Rib

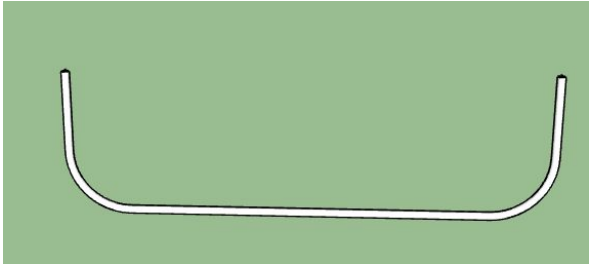
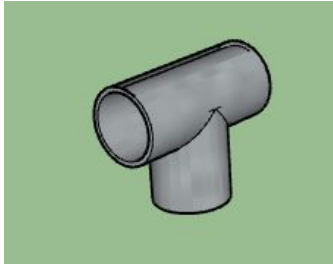
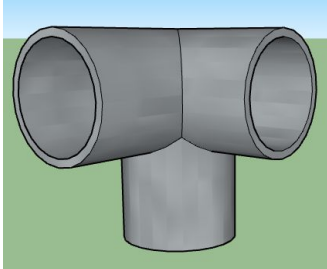

2 each per grow bed. Made from 1 standard rib, 4 metal Tee's, 2, 3 way side Tee's and one end top cross bar.

Standard Rib (2 needed)	Metal Tee fits conduit.
	
3 way or side exit Tee	End Top Bar 1.257m (1 each per end unit)
	

Assemble End Unit

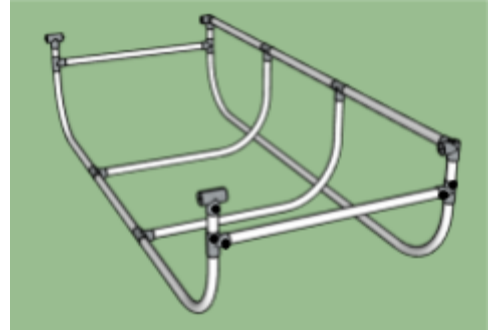
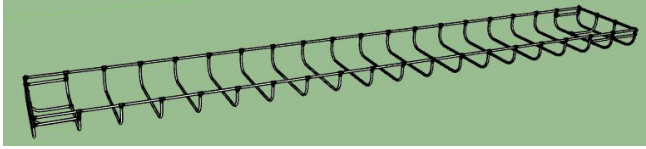

<p>Special Rib Assembly</p>	<p>End Rib Assembly</p>
<p>Short Rib</p>	<p>Brace Conduit (0.462m)</p>
<p>Secure Tee's to short ribs on the bottom of the unit from bottom to prevent set screw damaging of liner material.</p>	

Install Plywood piece on End Unit

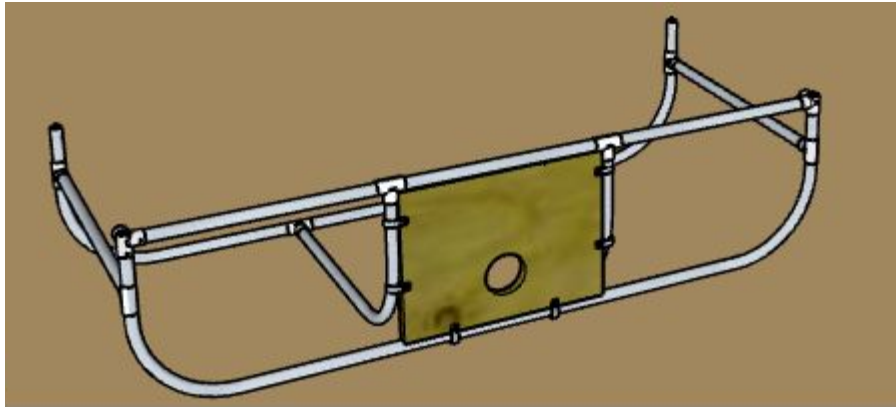

Fasten with smooth head screws from the inside (6 needed)

Pipe clamp for holding end board. (6 needed).

0.42m x 0.26m x 20mm (1 needed)

Cut 20mm plywood to fit between end short ribs. Cut hole in lower 1/3rd to fit bulkhead connector.

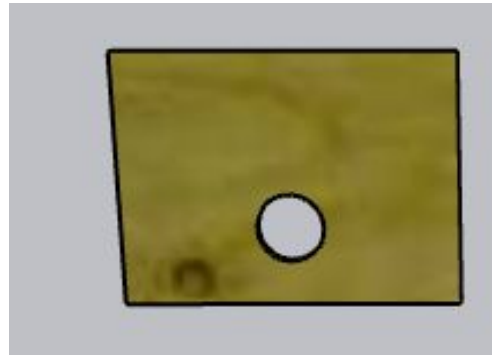
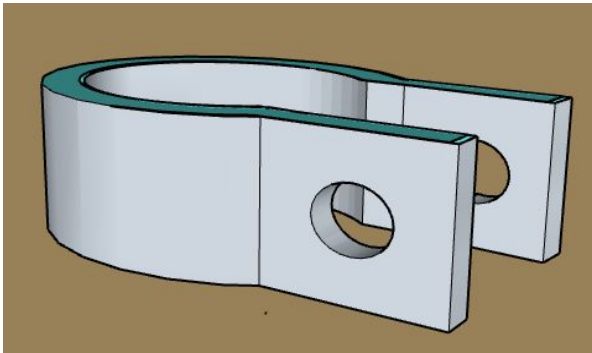

A bulkhead and PVC Drain will be installed. Make hole in the end board suitable for the size bulkhead chosen.

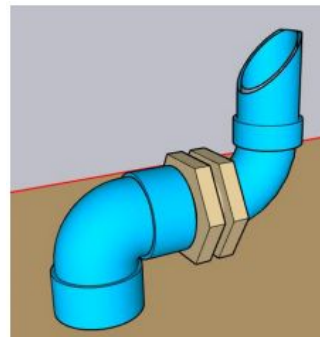

Stand Pipe determines the water depth in the grow bed. It is cut on a slant such that the high end extends above the water enough to keep the floating rafts from covering the bed drain.

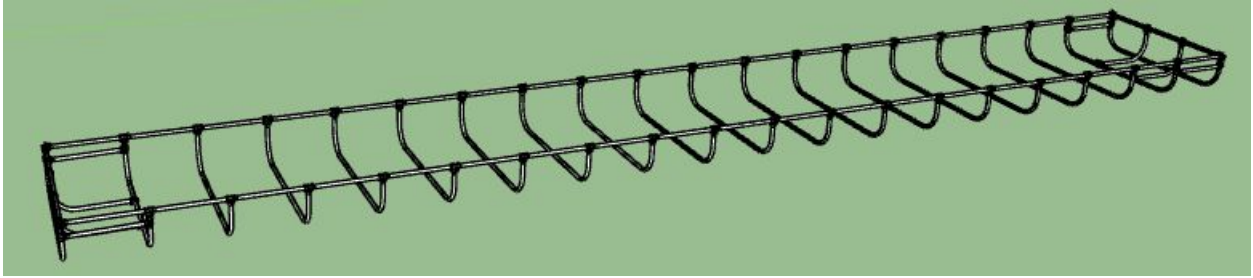

Bed Assembly

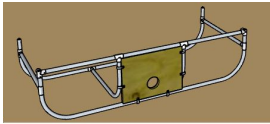
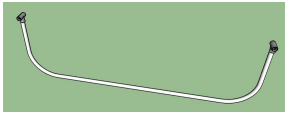

Final grow bed frame assembly: 9.2 m ID length x 1.25m wide. Rib spacing = 0.484 m

End Unit - 2 ct	Standard Rib - 16 ct	Long Top Rail - 2 ct	Short Top Rail - 2 ct
		5.64m 	3.56m 

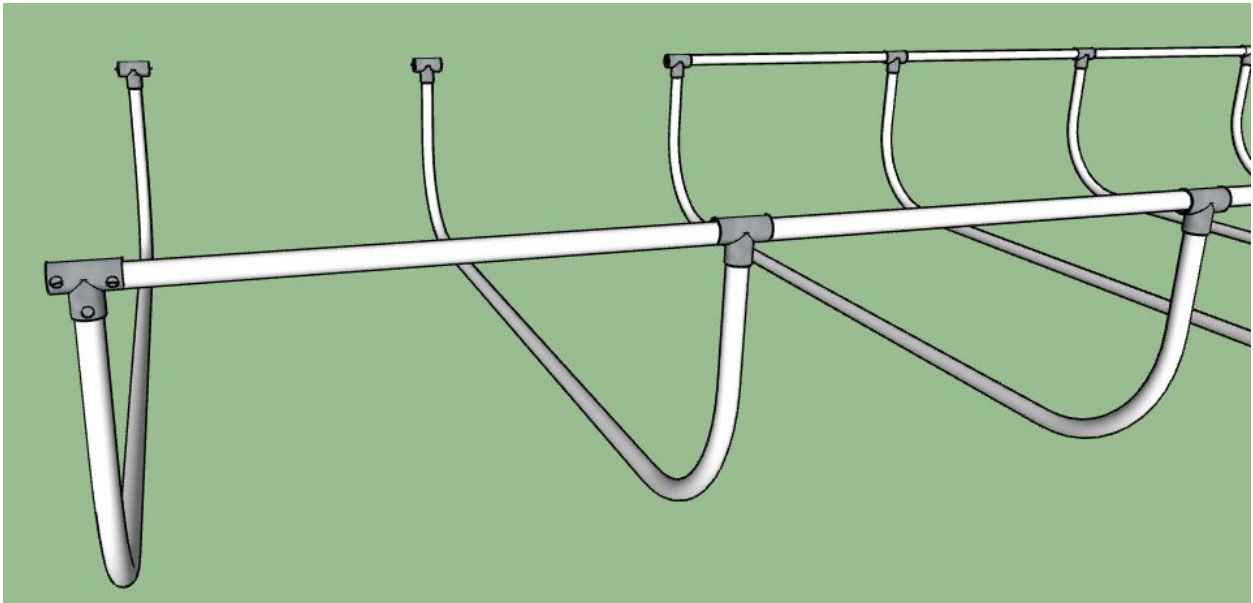

Trim the conduit side rails to meet in a tee. The opposite top side rails should staggered to meet least 2 ribs apart,

Insulation

Cut 1.20m x 0.455m sheets of 20mm foam insulation board and place between each rib.

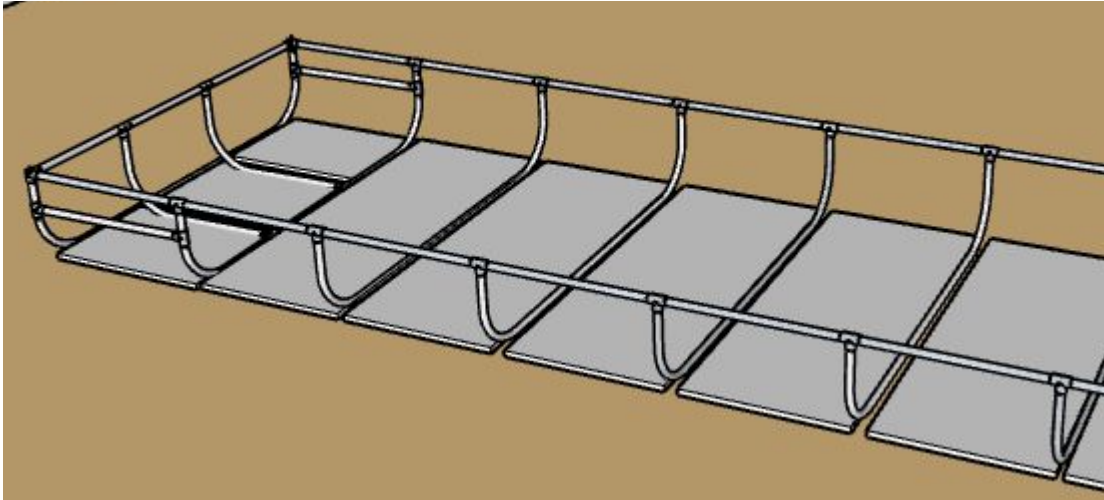

Cut foam lengths for grow bed sides 0.23m wide and notch (.015m x 0.025m for ribs) then line the entire inside of the frame.

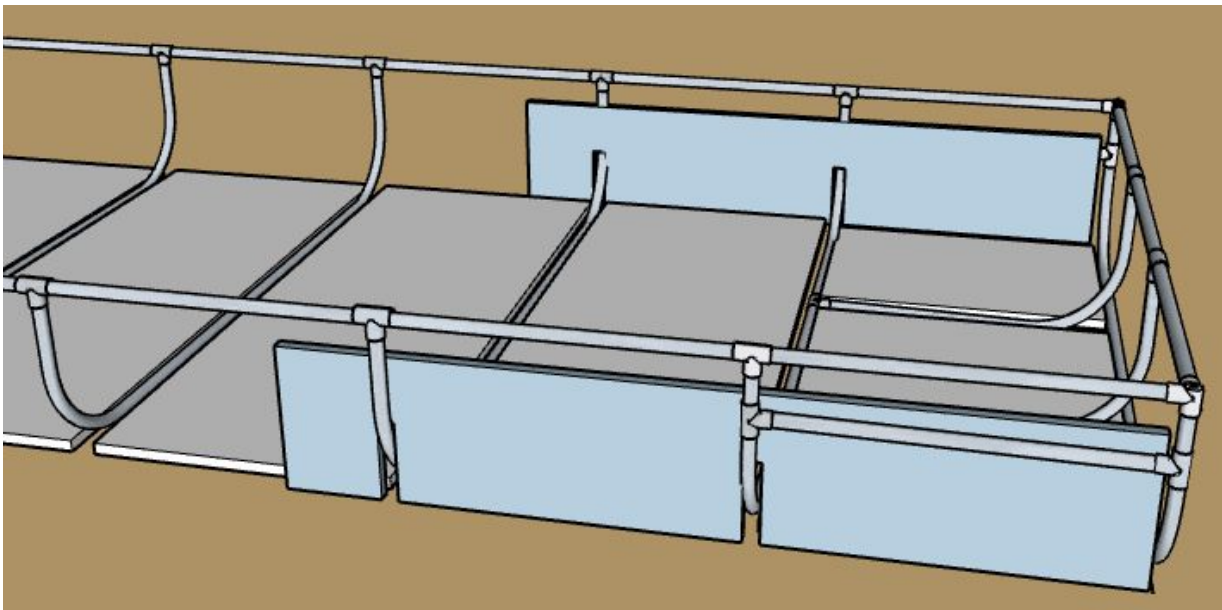

Pond Liner

For a 9.2 x 1.2 meter bed, cut a piece of pond liner at 10.2 meter

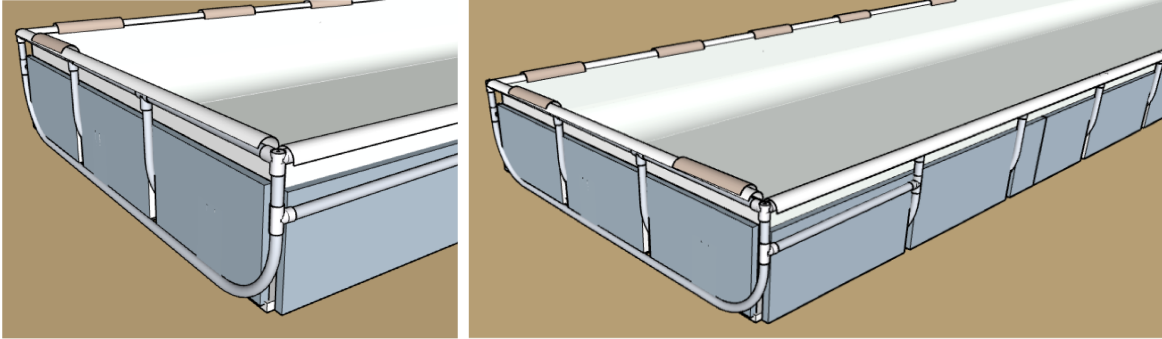

Center liner in bed, start at one end, fix the corners and work towards the other end

Put a clip every 10 cm and ensure the liner has enough curvature to put water weight on the ground and not pushing out the sides of the unit

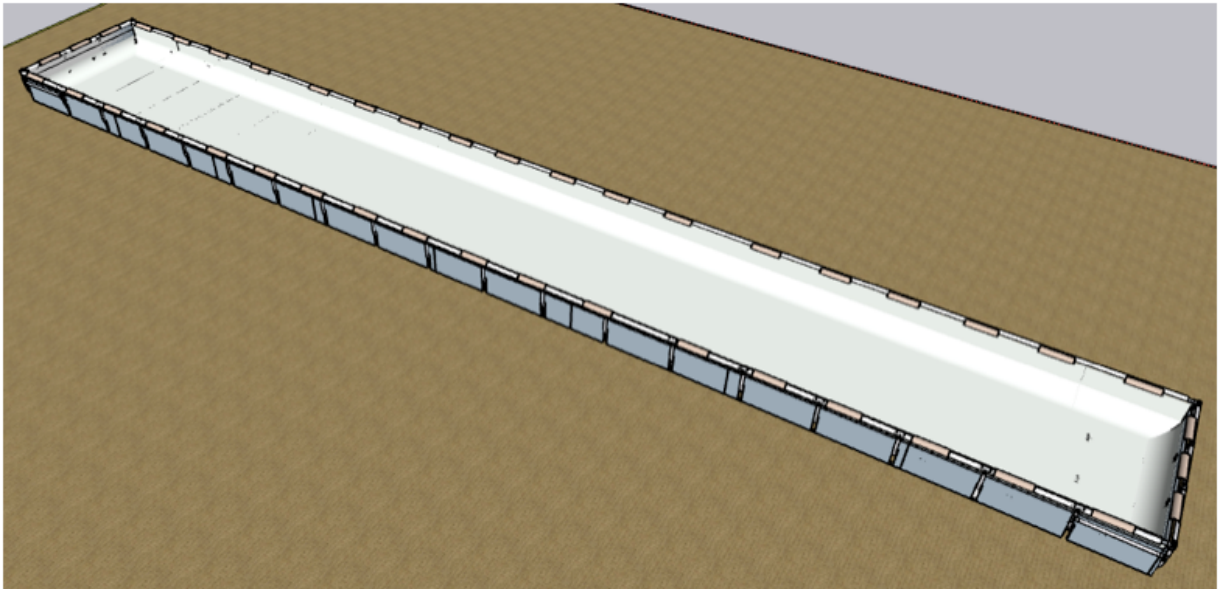

Aeration

Each grow bed (2 beds shown) has an air supply line made from 40mm PVC, a 40mm Elbow and a 40mm end cap with air stone/ hold down devices. One diffuser per meter.

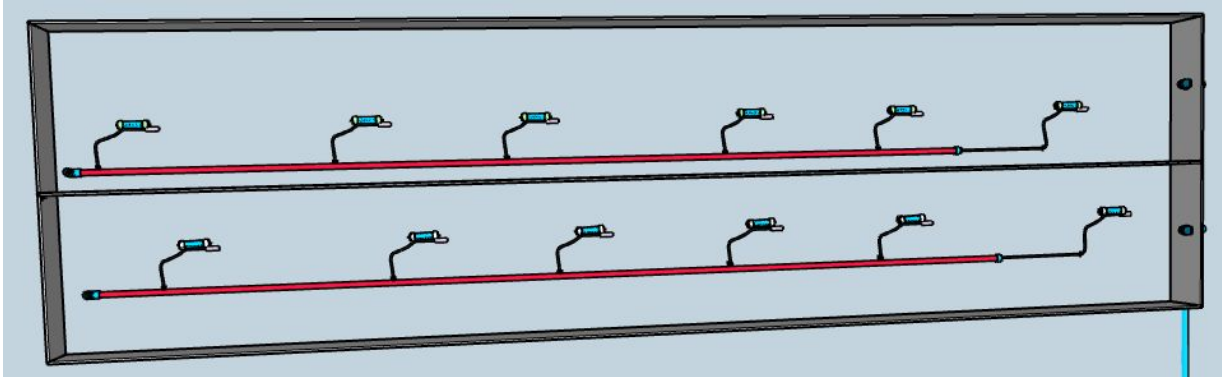

Make a minimum of 8 per grow bed of the following aeration devices.

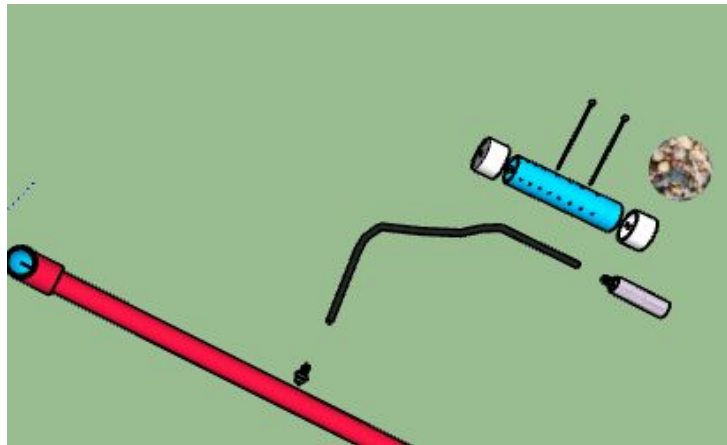

Air stone with hold down made from:

- 40 mm tube 0.15m long with holes drilled in it.
- 2 40mm end caps
- 2 Pea Gravel to fill tube
- Zip Ties to hold weight to air stone
- Nipple to connect distribution tubing to air supply line
- 0.45 m Distribution tubing
- Air stone or air distribution bubbler of your choosing.

Construction of Seeding Rack

Preliminary Checklist:

- ✓ All other modules are built and installed

Build Checklist

- Weld Frame
- Insert Tray Holder pipes
- Fabricate and Install Tray
- Connect piping

Specifications & Notes

- The seeding rack is 3.87 meters long, 0.62 meters wide, and 1.1 meters high.
- It is made from 22mm square metal tubing.
- There are two levels of germination capability equaling a total of 4.5 square meters of germination area.
- Placement of this rack can either go underneath a raised radial rack or elsewhere as space allows.
- Plumbing is shown as an option to run water back to the Sump tank if rack is placed underneath the Radial Filters.

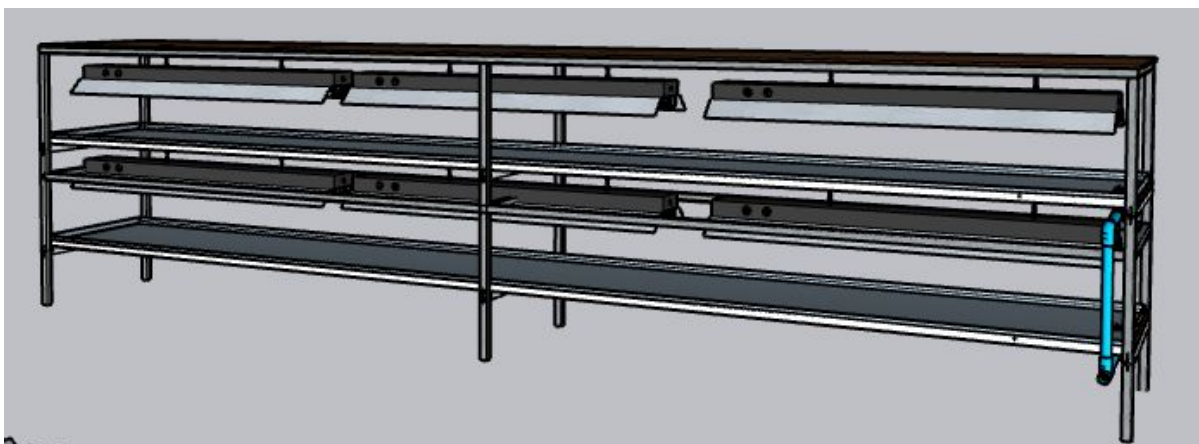
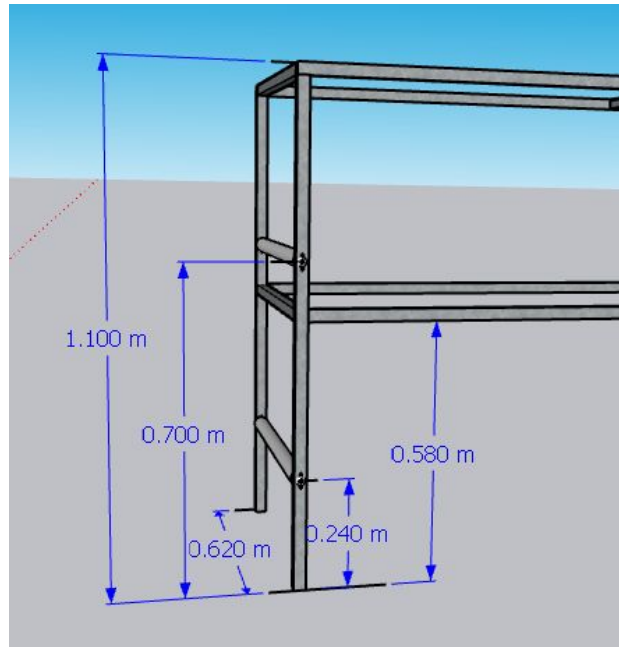

Build Instructions

Cut 5mm x 0.05m slots through all 6 legs centered at 0.24m and 0.70m high

Cut six 25mm Diameter conduit pipes 0.549m to be cross bars on which the seeding tray rests. Deburr inside edges. Insert Nuts.



Using the Pan Head screws place the pipes in the slotted holes in the frame. These pipes can be raised and lowered to control the slope of the seeding trays.

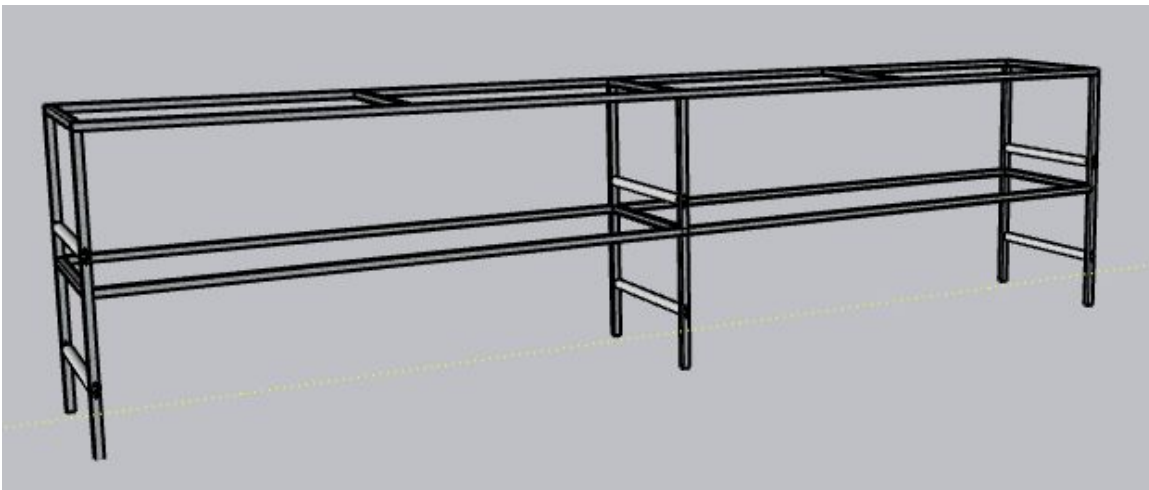
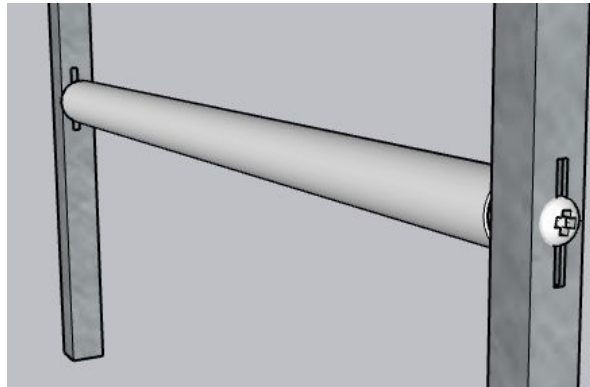

Prepare the Seeding Trays

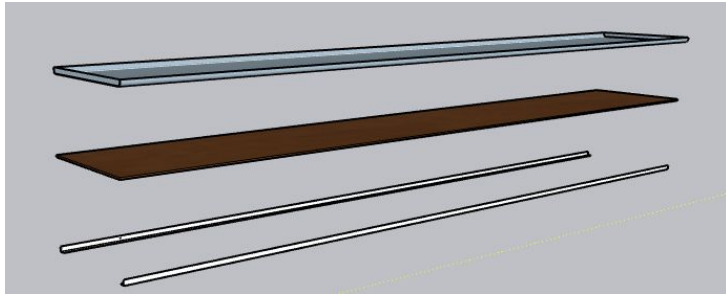

	<p>Using two 4.05m x 0.62m sheet of metal, fold the edges and end up 25mm to form 2 pans.</p>
	<p>Using four 25mm angle rods will hold the plywood base you can set the sheet metal on top of.</p>
	<p>Plywood section of 1cm x 0.56m W x 4.0m L forms the base.</p>
	<p>using a 20mm PVC threaded female to slip adapter, an O Ring and a Threaded male to slip adapter make a miniature bulkhead connector for the metal pan.</p>

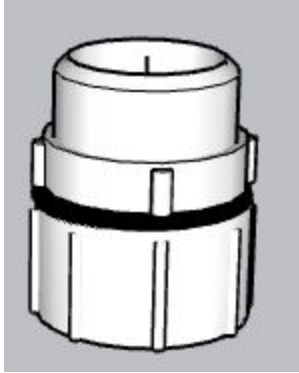

Screw the units firmly together until the O Ring is slightly compressed.

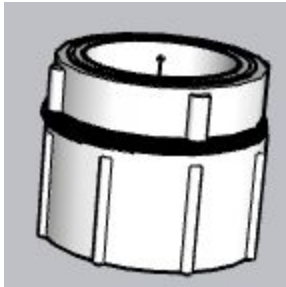

Cut off the top of the mated female adapter to lower the water level in the seeding tray as shown

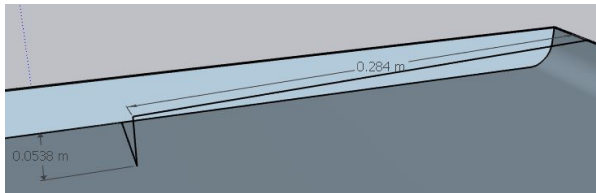

Locate this position to drill a hole in the pan and plywood. 0.284 m from end and 0.0538m from the side.

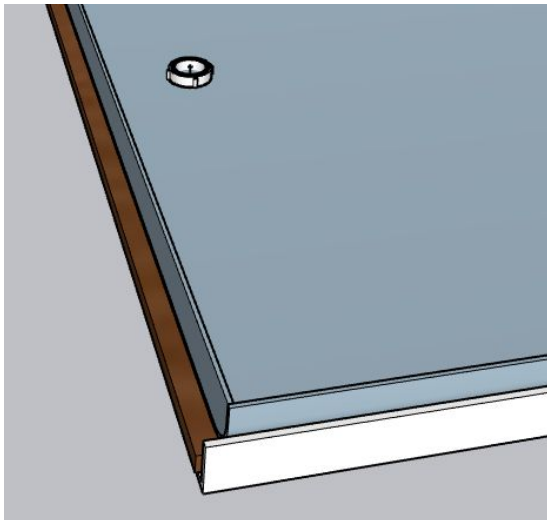

- Drill a 2mm pilot hole centered at this location through both the metal and plywood.
- Lift the pan out and prepare a hole just large enough to fit the male threads of the PVC adapter (0.028m). Be very careful not to make it too large. The O Ring must press against the metal.
- Drill a hole through the plywood large enough to freely access the knurled end of the male PVC adapter (0.05 – 0.07m).
- Assemble the mini-bulkhead to the pan and put in place.
- Do this for each pan.
- Place pan units in the rack and fit with drain plumbing.

Plumbing and Lighting the Seedling Trays

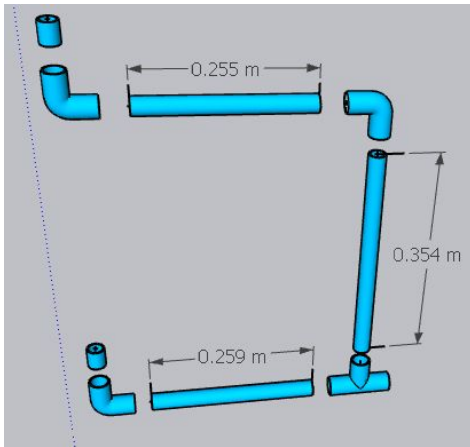

Make this drain unit from 25mm PVC. Do not glue until fit is verified. Fit drain to mini-bulkheads for draining to sump.

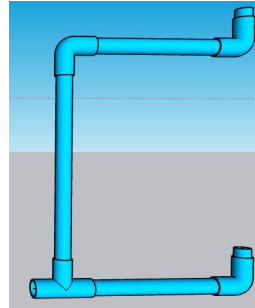

Fasten light fixtures in place. Approximately three fixtures per level depending on the length of the fixture.

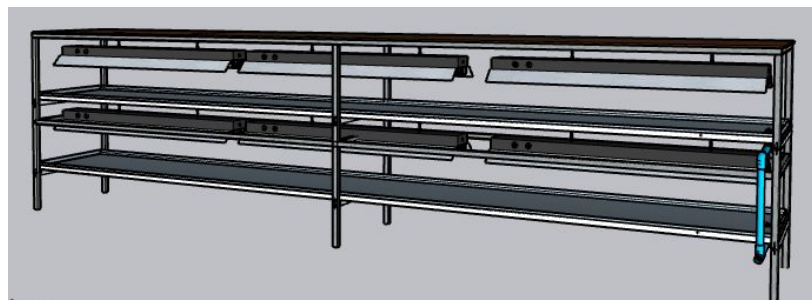

Fabricate Grow Rafts

Build Checklist

- Trim boards as needed
- Drill holes
- Wash off excess dirt or material dust
- Place into grow beds

Specifications & Notes

- Each Raft should be 1.15 meters long and 0.56 meters wide
- For a grow bed that is 9.2 meters long, there can be 15 rafts per bed.
- Each low density raft can contain 28-36 holes depending on pattern chosen
- Each high density raft can contain 105 holes at the maximum
- If there is access to buying premade rafts, that is also an option.

Low Density Raft Options

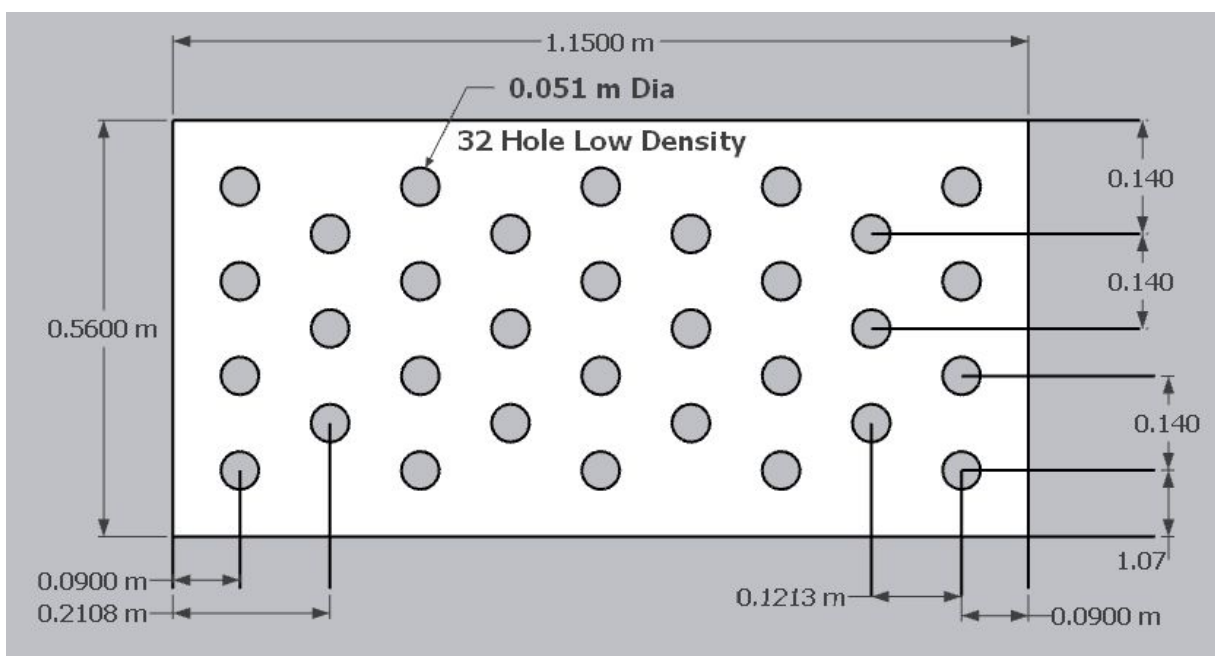
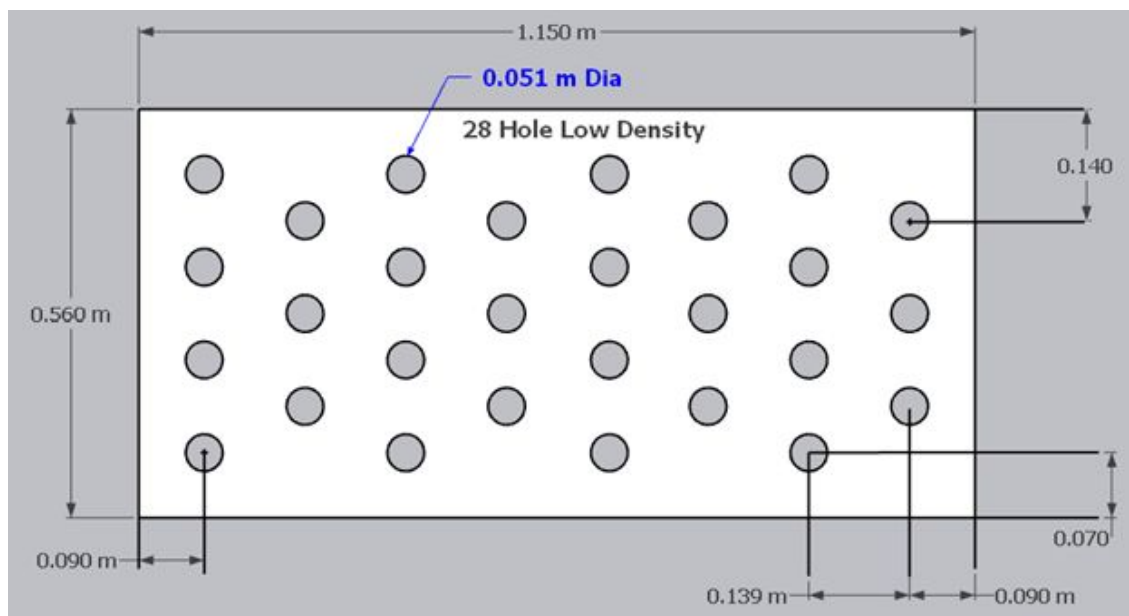

32 Hole Option 2

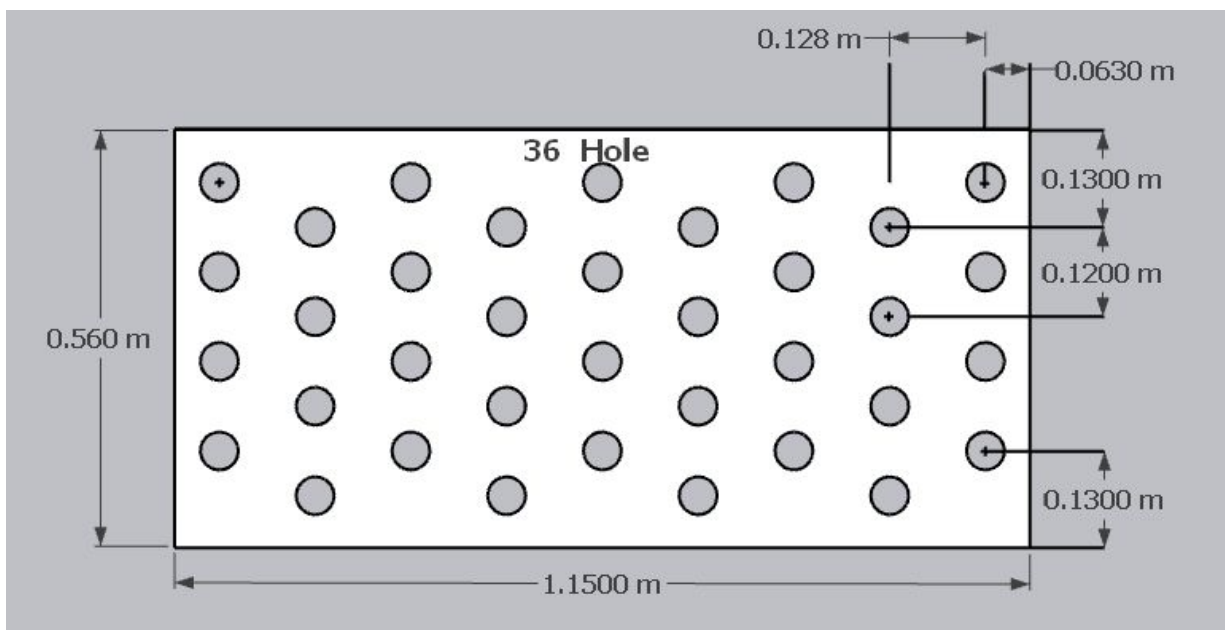
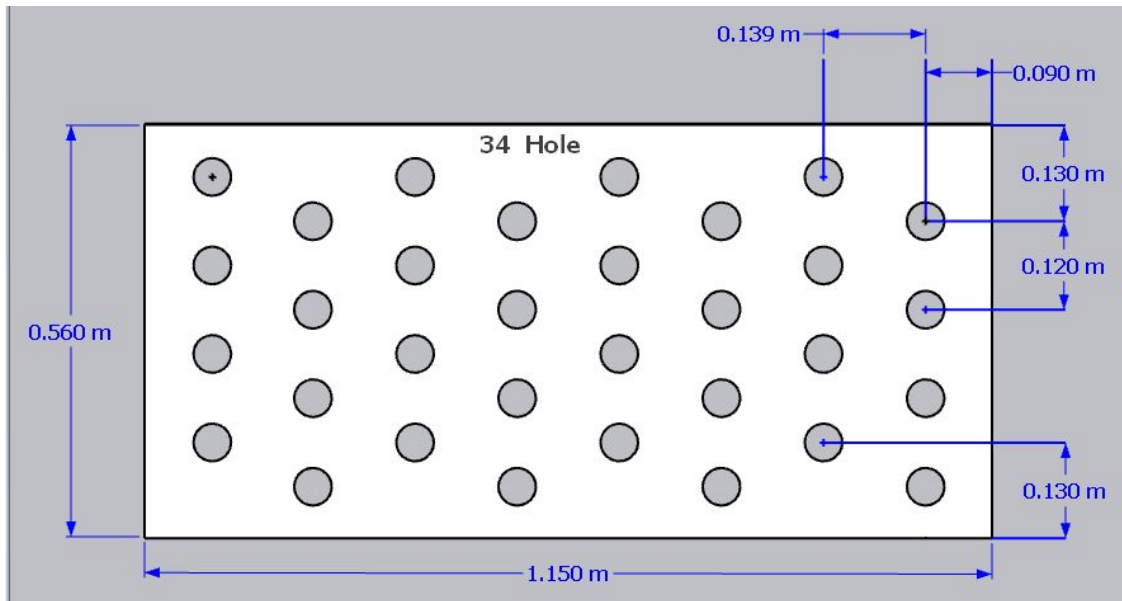

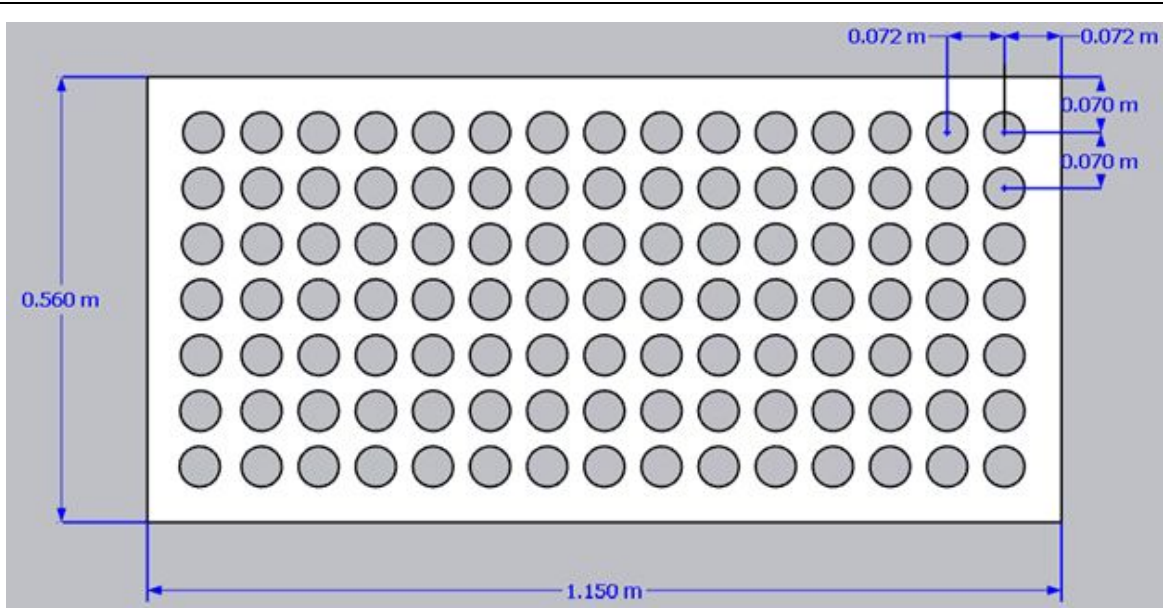

105 Hole High Density

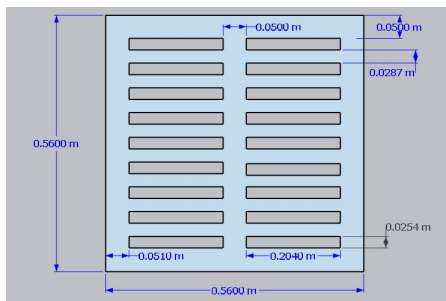

Another option if pre-made plugs are being used would be plugs in ½ raft float. Slots are tapered 2.5mm top and 2.3mm bottom

Water Piping Connection

Build Checklist

- Place pump into Sump tank
- Piping from Sump tank to Fish Tank
- Piping from Fish Tank to Sump
- Piping from Sump to Grow Beds
- Piping from Grow Beds to Sump

Specifications & Notes

- All the water pipe connections will be with 63mm piping.
- Depending on the exact layout of the system, distances, angles and requirements will need to be adjusted. Here are a few examples of the water connection
- For the fish tanks, the water should enter each tank such that it tends to cause a circulation of the water in the fish tank.
- Each fish tank should have its own flow regulation valve on the input.
- Each grow bed should have it's own flow regulation valve on the input.
- Water to the grow beds should enter the beds at the far end away from the sump.
- Piping to Grow beds can be trenched underground, laid on top of the floor, raised into the ceiling or mounted to the side wall.
- For the output from the Grow Beds to the Sump, If possible trench the lines just below the surface otherwise, drain lines may lay on the floor.
- There may be no more than two grow bed outlets linked to one input to the sump.

Sump to fish tank overview.

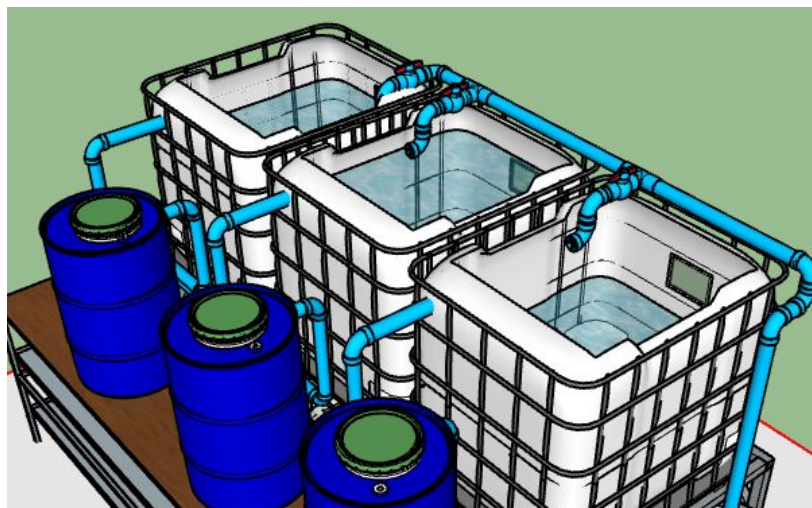

Fish Tank to Sump Overview

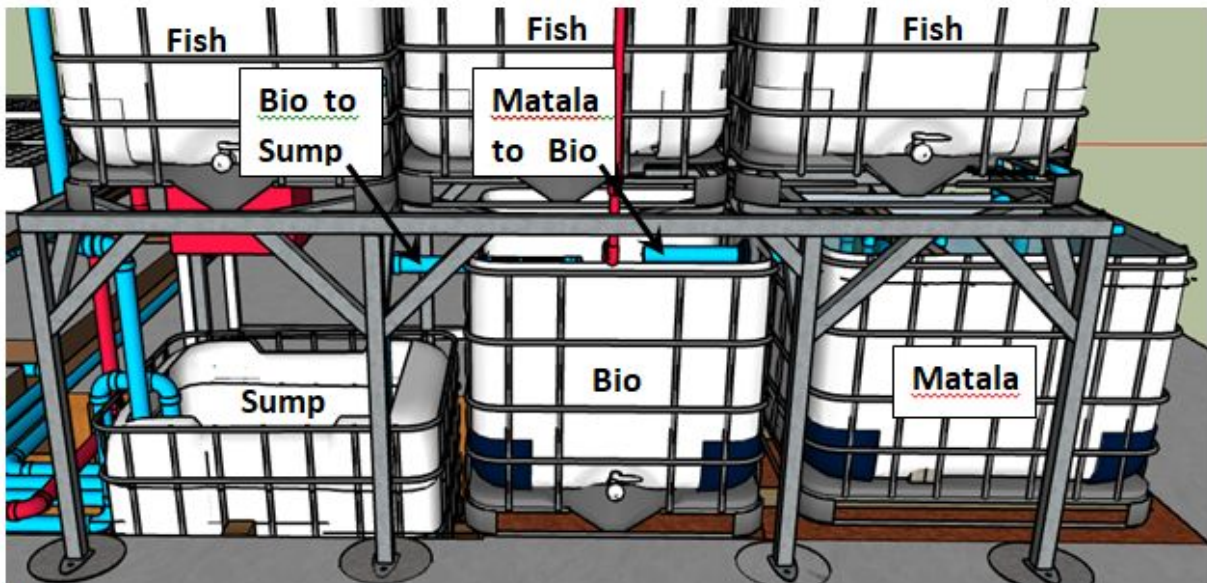
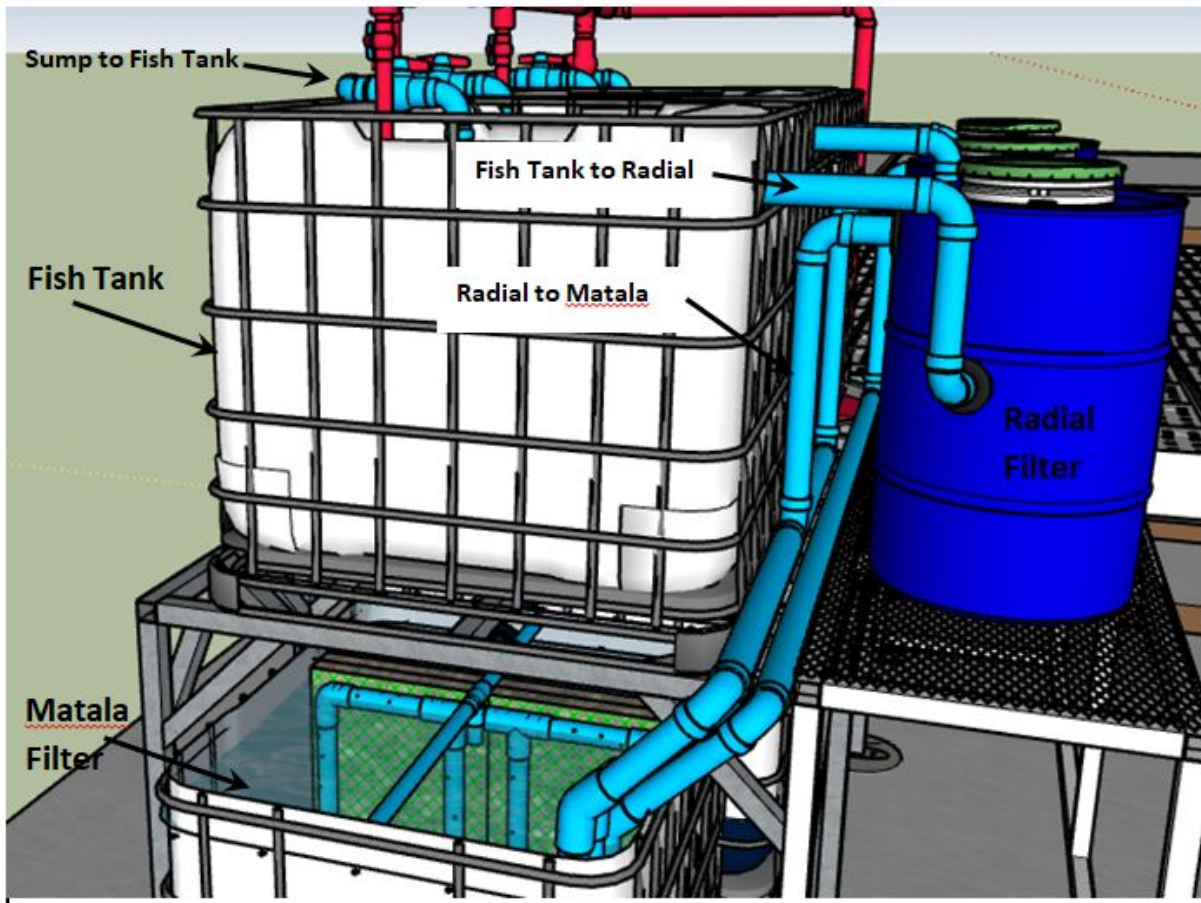

Sump to Grow Beds

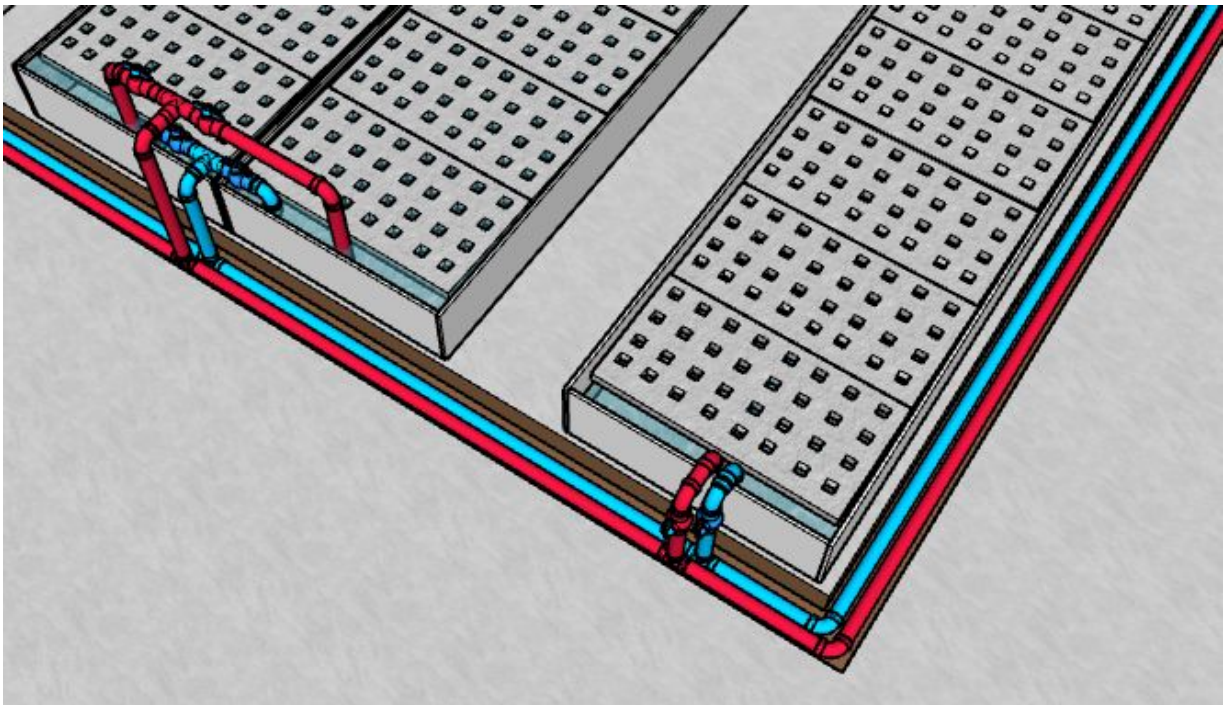
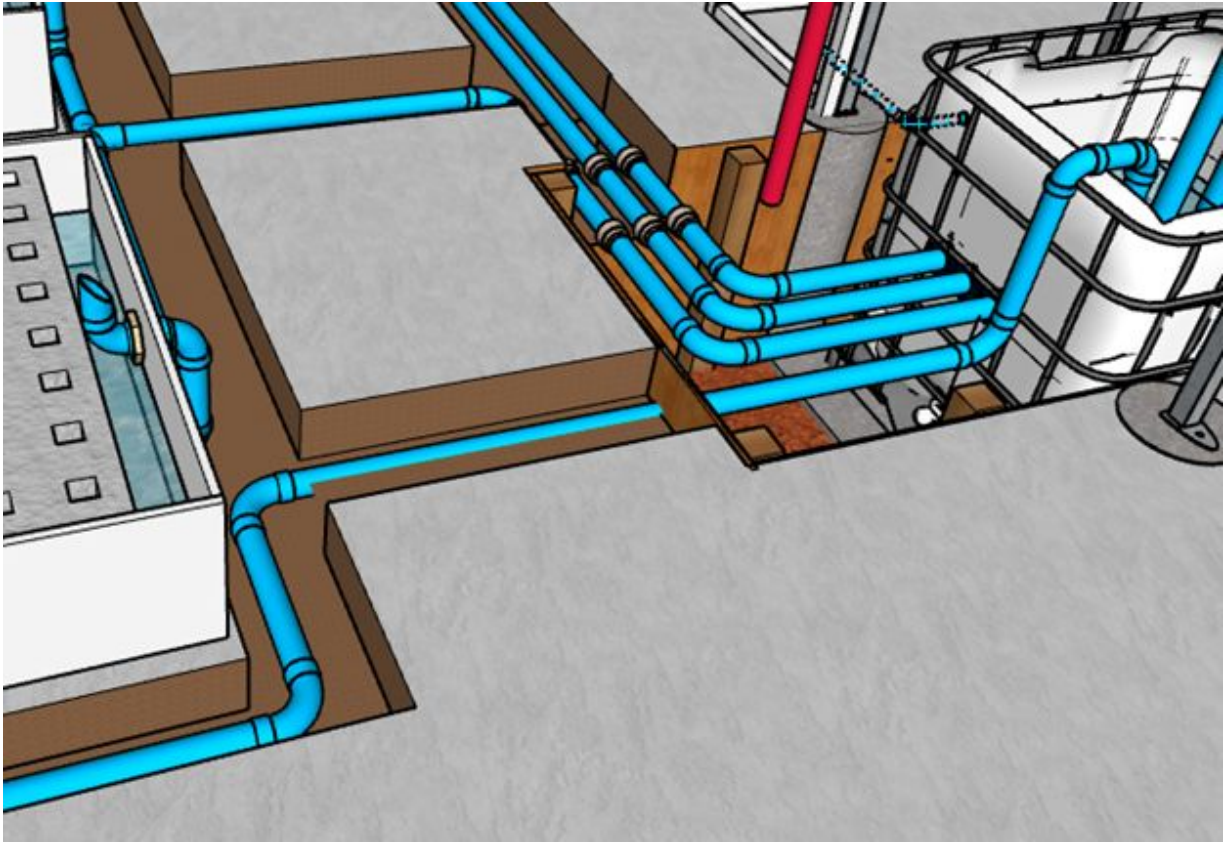

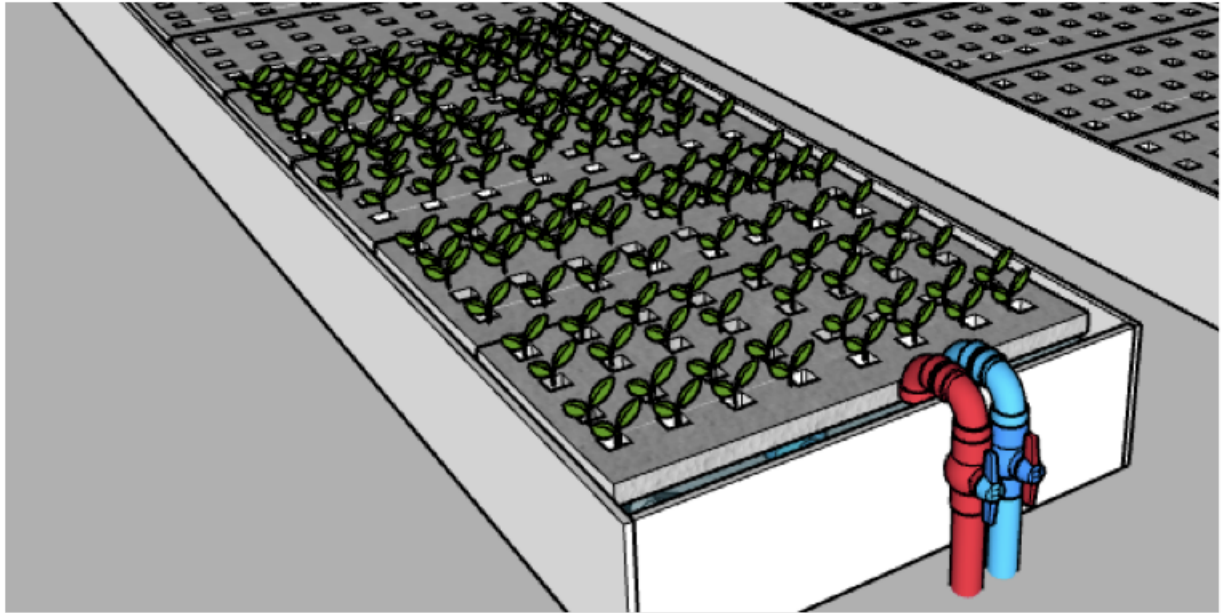

Grow Beds to Sump

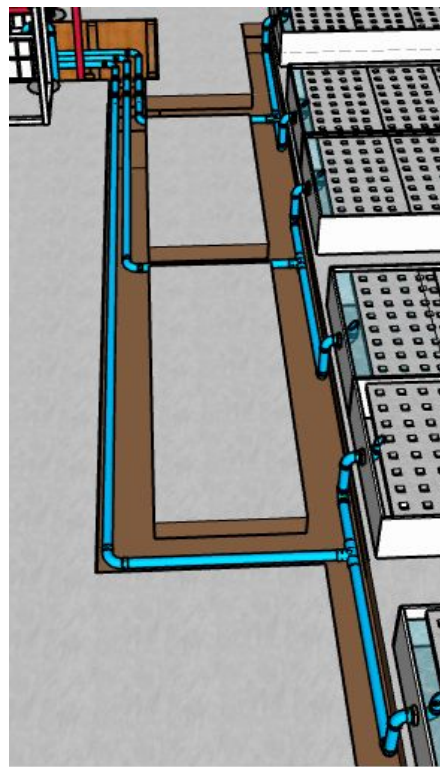

Air Piping Connection

Build Checklist

- Mount Air Pump
- Run Piping to Fish tanks and Filters
- Run Piping to Grow Beds
- Install air stones or tubing

Specifications & Notes

- The Air Pump may be mounted on the fish rack, the greenhouse structure or anywhere it is out of the way and secure.
- Each Fish Tank must have at least three air diffusers
- Air diffusers should be installed in both the matala and bio filter.
- Air diffusers may be installed into the grow beds as shown but also can be adjusted if parts are unavailable. Ensure air flow is active at minimum every meter of grow bed.
- Air regulator valves should be installed on every unit (fish tank, bio, grow bed...)
- An air pressure meter should be attached to the air line near the air pump. Reading the air pressure and noting any increase in air pressure indicates the air diffusion elements are becoming restrictive and may need to be changed

Air Pump Mounted with Pressure Meter

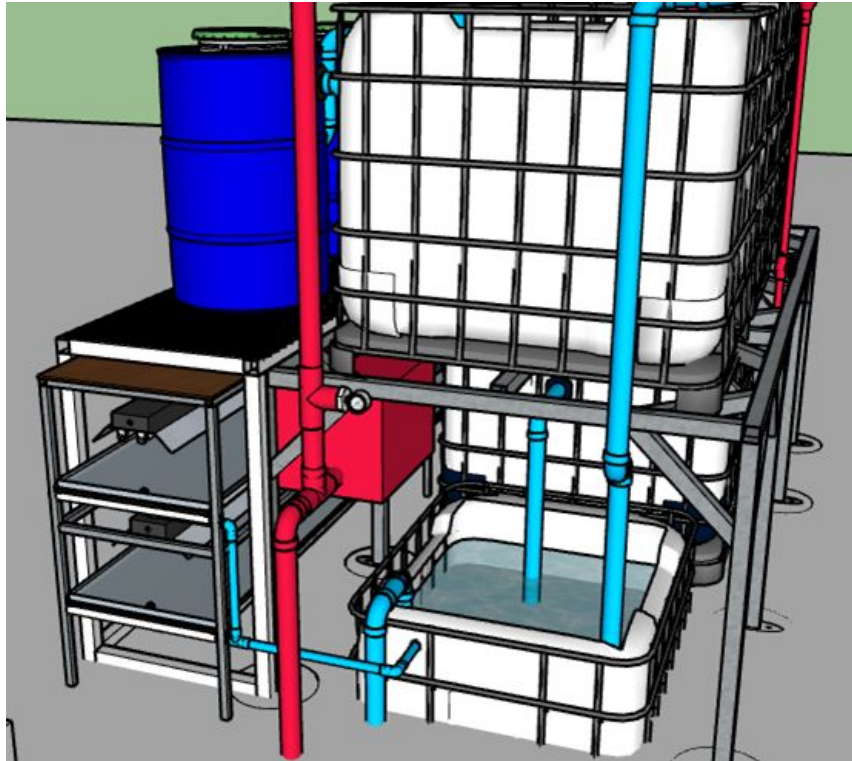

Fish Tank Diffusers

- 40mm PVC pipe
- 12.5mm flex hose
- 3 Air Stones
- 2 40mm end caps
- 1 40mm Ball valve
- 1 40 mm 90 deg Tee
- 3 12.5mm threaded nipples

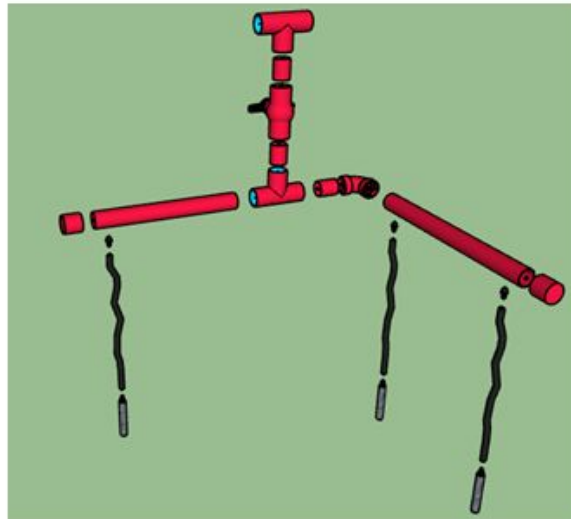

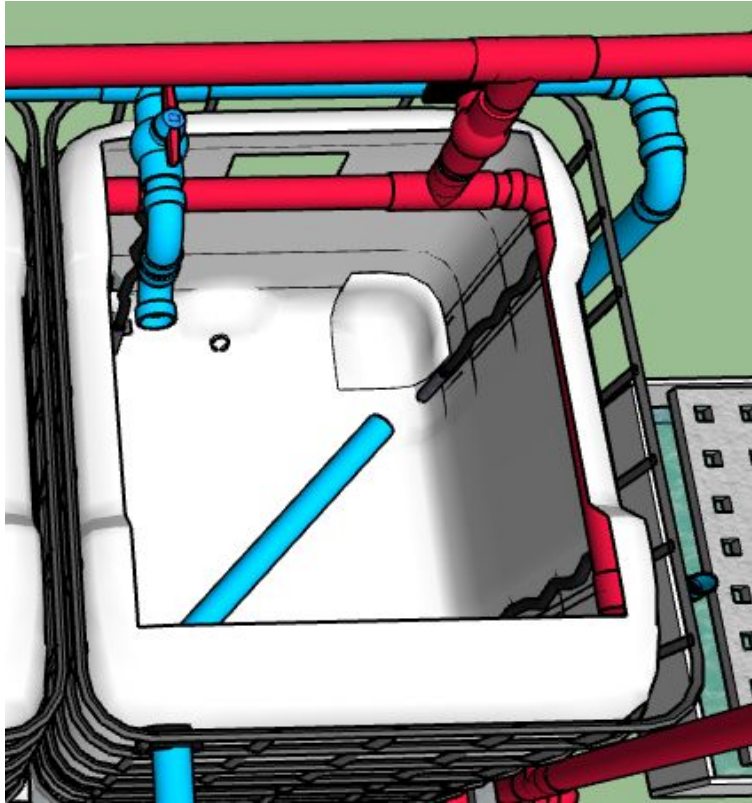

Bio Tank Diffusers

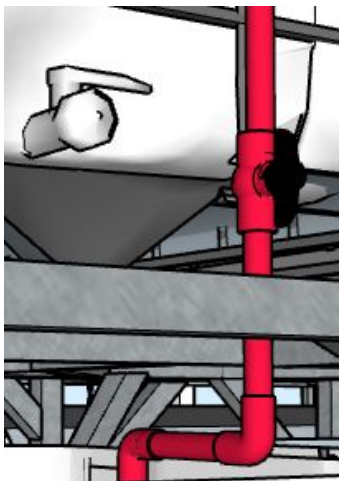

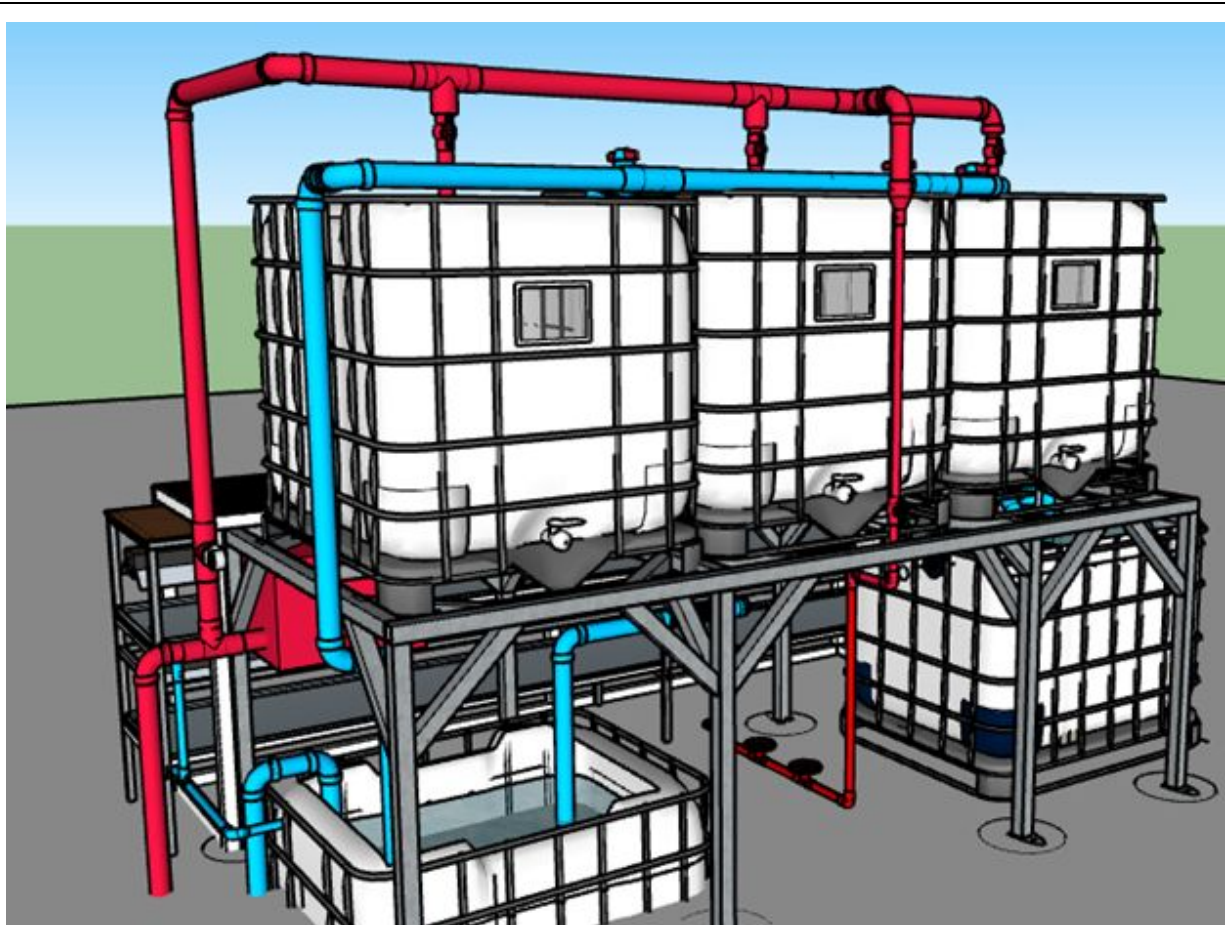

Bio tank omitted for clarity

Grow Bed Diffusers 8 per grow bed

Air stone with hold down made from:

- 40 mm tube 0.15m long with holes drilled in it.
- 2 40mm end caps
- 2 Pea Gravel to fill tube
- Zip Ties to hold weight to air stone
- Nipple to connect distribution tubing to air supply line
- 0.45 m Distribution tubing
- Air stone or air distribution bubbler of your choosing.

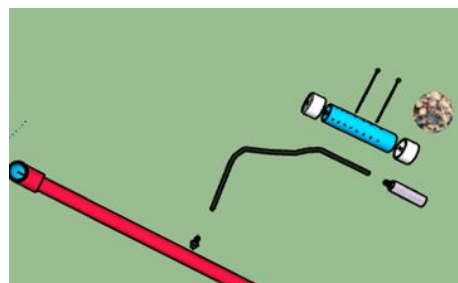

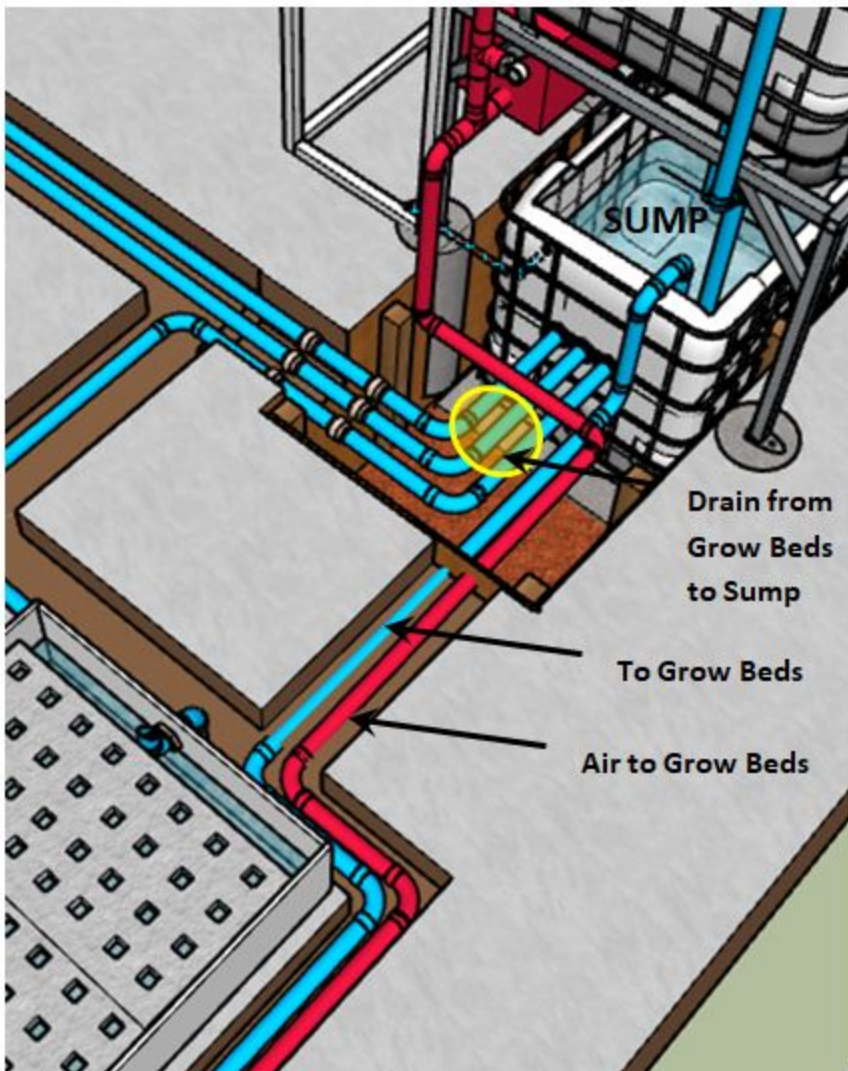
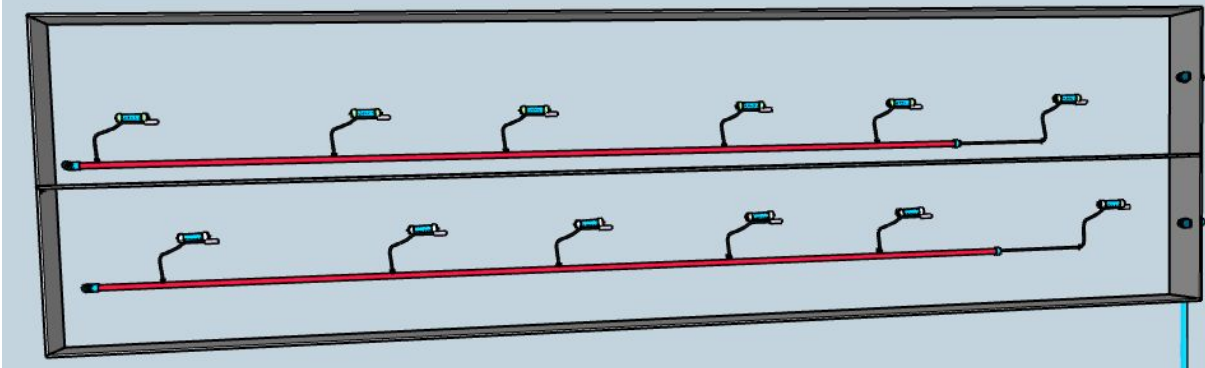

Water: Adding and Adjusting Flow

Build Checklist

- Fill Fish tanks until they overflow into filters then sump.
- Ensure there are no leaks in outflow pipes from fish tanks to sump
- Fill Grow beds until they overflow into sump
- Ensure there are no leaks in outflow pipes from grow beds to sump
- Fill Sump and Turn on pump
- Ensure inflow piping to all locations does not leak
- Adjust valves to match water flow specifications
- Allow water to run and observe

Specifications & Notes

- As leaks are identified, repair and continue to test
- Grow bed output pipes may be tilted side to side to adjust water height
- Remember, adjusting one valve will slightly change input to the other locations
- Total water required is approximately 24,100 liters.

Location	Volume (lt)	Waterflow (lt/hour)
Fish Tank - A	800	1000
Fish Tank - B	800	1000
Fish Tank - C	800	1000
Radial Tank - A	200	1000
Radial Tank - B	200	1000
Radial Tank - C	200	1000
Matala Filter	700	3000
Bio Filter	600	3000
Sump Tank	500	
Grow Bed 1	3,300	830
Grow Bed 2	3,300	830
Grow Bed 3	3,300	830
Grow Bed 4	3,300	830
Grow Bed 5	3,300	830
Grow Bed 6	3,300	830

Finished System

