



FOR FULL IOM,  
SCAN BELOW



# Aquavar<sup>®</sup> IPC

QUICK START-UP GUIDE FOR ADVANCED IPC

**INDEX**

Safety and Instructions .....	3
Basic Electrical Connections .....	4
Input and Motor Wiring .....	5
Control Wiring (Single and Multi-Pump).....	6
Multi-Pump Connections .....	7
Single Pump Programming .....	11
Multi-Pump Programming .....	14
Performing No Flow Power Calibration .....	17
Support Contact Information .....	24

## Aquavar IPC Start-Up Genie

### SAFETY AND INSTRUCTIONS

#### OVERVIEW

This guide provides a quick reference for installing the Technologic Intelligent Pump Controller.

**NOTE:** This guide does not provide safety, detailed installation or operational instructions. Refer to the IM318 Aquavar Intelligent Pump Controller Installation, Operation, and Maintenance (IOM) Manual (current version) for complete information.



#### WARNING

- **High Voltage** Failure to comply could result in death or serious injury.
- **Discharge Time** Failure to wait the specified time after power has been removed before performing service or repair could result in death or serious injury.

Frequency converters contain DC-link capacitors that can remain charged even when the frequency converter is not powered. To avoid electrical hazards, stop motor and disconnect:

- AC mains
- Any permanent magnet type motors
- Any remote DC-link power supplies, including battery backups, ups and DC-link connections to other frequency converters.

Wait for the capacitors to discharge completely before performing any service or repair work. Refer to the following table for wait times:

Voltage (V)	Power range		Minimum wait time (min)
	hp	kW	
200-240	1.5-5	1.1-3.7	4
200-240	7.5-60	5.5-45	15
380-480	1.5-10	1.1-7.5	4
380-480	15-125	11-90	15
380-480	150-350	90-315	20
380-480	450-600	315-450	40
525-690	1.5-10	1.1-7.5	4
525-690	1.5-10	1.1-7.5	7
525-690	15-125	11-90	15
525-690	75-350	55-315	20
525-690	350-600	315-450	30

High voltage may be present even when the warning LED indicator lights are off.

- **Leakage Current Hazard** Failure to ground the drive properly could result in death or serious injury.
- **Unintended Start** Failure to comply could result in death, serious injury, equipment, or property damage.
- **Unintended Start. Windmilling!** Failure to follow the instructions could result a risk of personal injury and equipment damage.
- Only use original spare parts to replace any worn or faulty components. The use of unsuitable spare parts may cause malfunctions, damage, and injuries as well as void the guarantee.

- This product can expose you to chemicals including Lead, which is known to the State of California to cause cancer and birth defects or other reproductive harm. For more information go to: [www.P65Warnings.ca.gov](http://www.P65Warnings.ca.gov).
- **Equipment Hazard** Failure to follow the guidelines could result in death or serious injury.
- **Internal Failure Hazard** Failure to follow the guidelines could result in serious injury.



#### CAUTION

Before using the Genie, set DI18 to Stop (terminal 18 open) to prevent the unit from starting the motor. Keep terminal 18 open to avoid an unintended motor rotation. Apply the Start signal to the controller only when pump operation is desired.

#### PREPARE FOR INSTALLATION



#### WARNING! Installation must be performed by a qualified technician.

- **Suitable Environment** - Ensure installation is indoors and the site temperature range is 0°C (32°F) to 40°C (104°F).
- Ensure properly sized safety devices are installed in the system such as pressure relief valves, compression tanks, pressure controls, temperature controls and flow controls.
- Ensure proper guards are installed when the system has potential to operate at extreme temperatures and/or pressures.

#### UNPACK THE UNIT

Remove all packing materials from the product. Inspect the product to determine if any parts have been damaged or are missing. Contact your sales representative if anything is out of order.

#### PREPARE THE MOUNTING LOCATION

- Ensure adequate supports are utilized to handle the weight of the system, piping and fluid.
- Ensure the suction and discharge pipes are supported independently by use of pipe hangers near the pump.
- Ensure there is adequate space around the unit to ensure proper cooling and allow for maintenance and service.

#### MOUNT THE UNIT

- Ensure the unit is properly lifted according to the pump Installation, Operation and Maintenance manual.
- Ensure all flange bolts are adequately torqued.
- For vertically mounted installations with the motor and controller in the horizontal position, ensure that adequate support for the motor and controller is provided.
- Refer to chapter 4 Mechanical Installations in the IM318 Aquavar Intelligent Pump Controller IOM for details of installations.

## Aquavar IPC Start-Up Genie

### INSTALL WIRING



#### Electrical Hazard. Dangerous voltage.

Ensure all input power disconnects and circuit breakers are locked in the off position prior to installing the input power wiring.

**NOTE:** External fusing is required for units without a built in fused disconnect.



#### Electrical Hazard

Ensure power wiring and fusing is installed according to NEC/CEC, state, local or municipal codes.



Remove the front cover to gain access to the power and control wiring terminals. Connect conduit runs from the disconnect or service panel to the drive and route the power wires through the conduit.

Refer to chapter 5 Electrical Installation and chapter 10 Technical Specifications in the IM318 Aquavar Intelligent Pump Controller (current version) for details on wiring and routing.

### BASIC ELECTRICAL CONNECTION

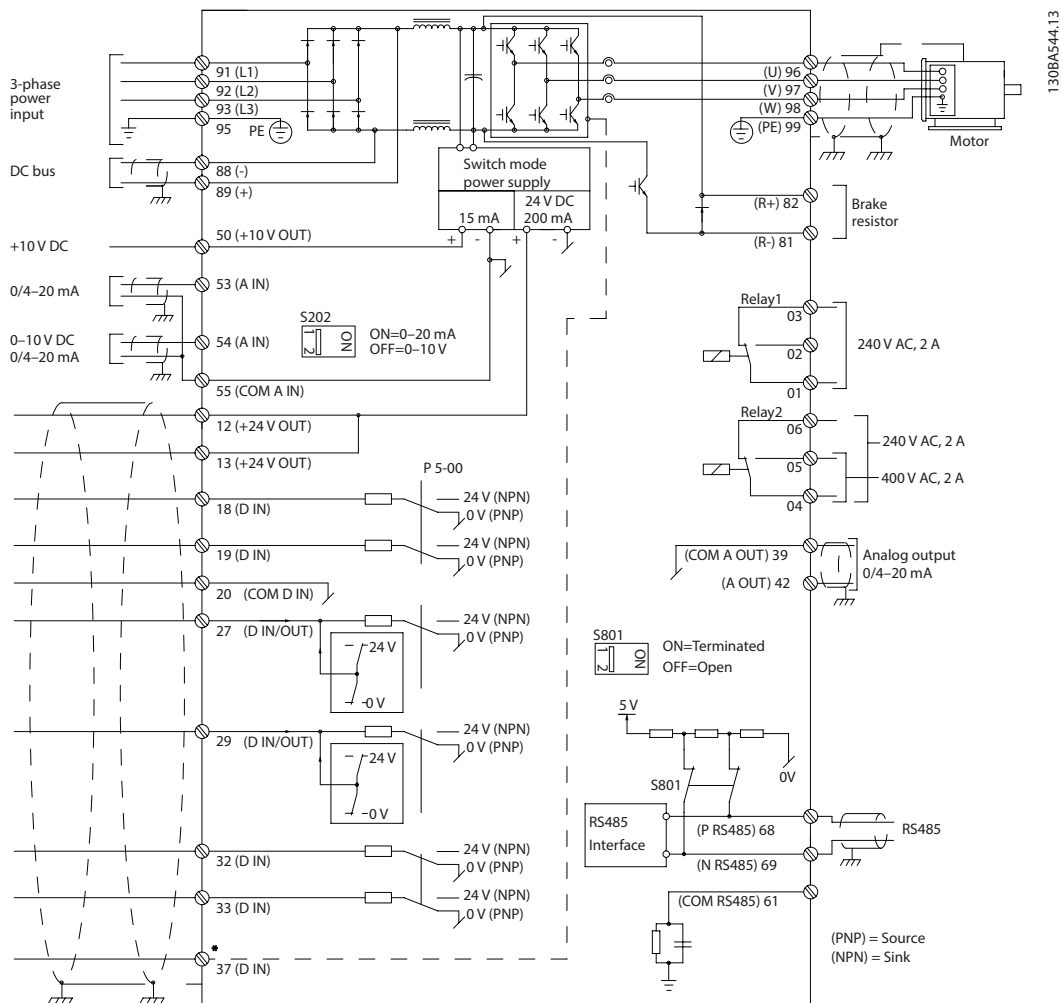

## Aquavar IPC Start-Up Genie

### INPUT (MAINS) WIRING 3-PHASE:

Connect 3-phase AC input power wiring to terminals L1, L2, L3 and ground the cable.

#### Input Terminals

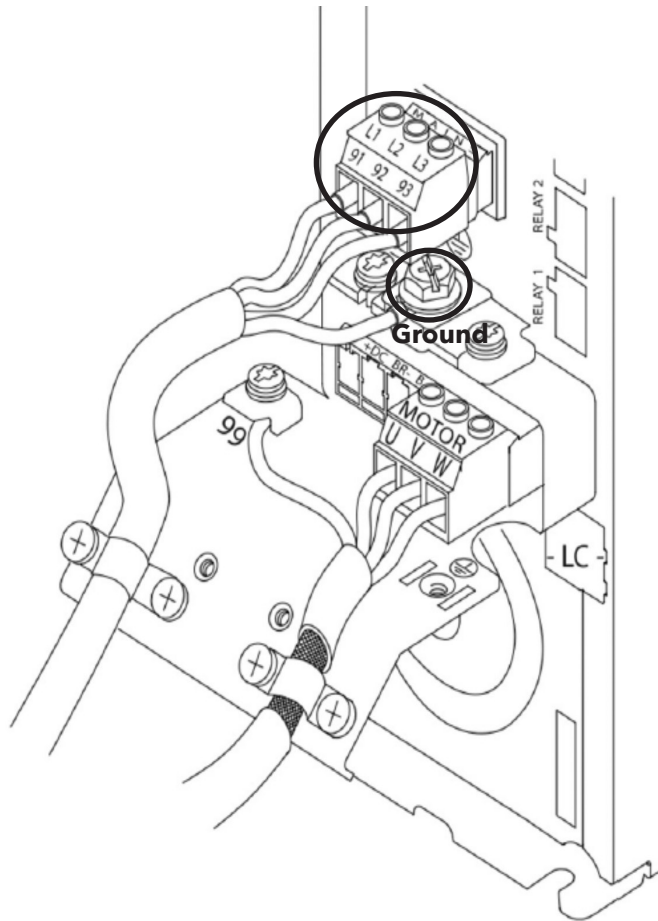

### OUTPUT WIRING TO MOTORS:

Connect output motor wires to terminal block labeled U, V, W and ground the cable.

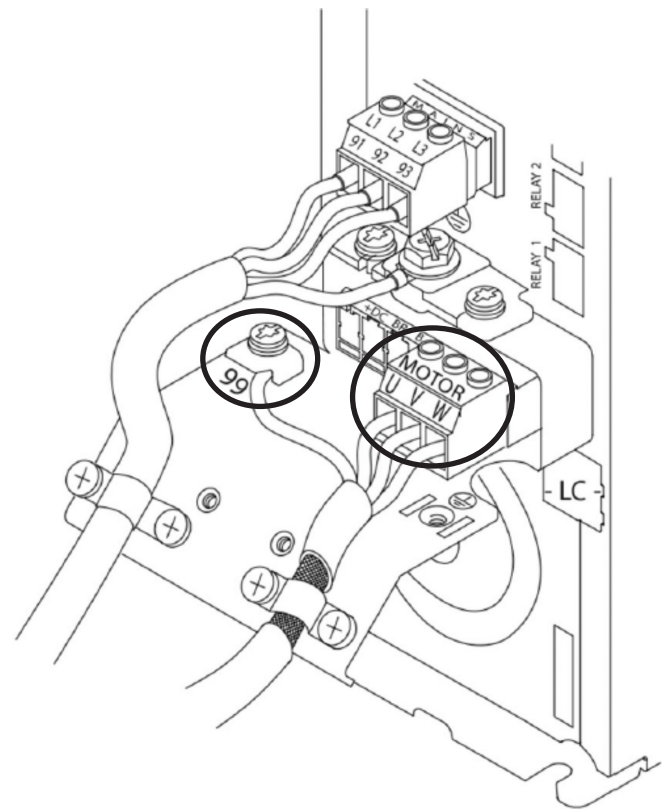

### SINGLE PHASE INPUT DRIVES:

Connect single phase power wiring to L1, L2 and ground the cable.

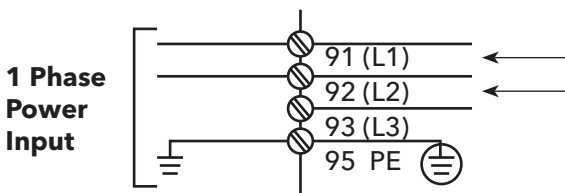

Check IOM for specific frame size considerations

## SINGLE AND MULTI-PUMP CONTROL WIRING

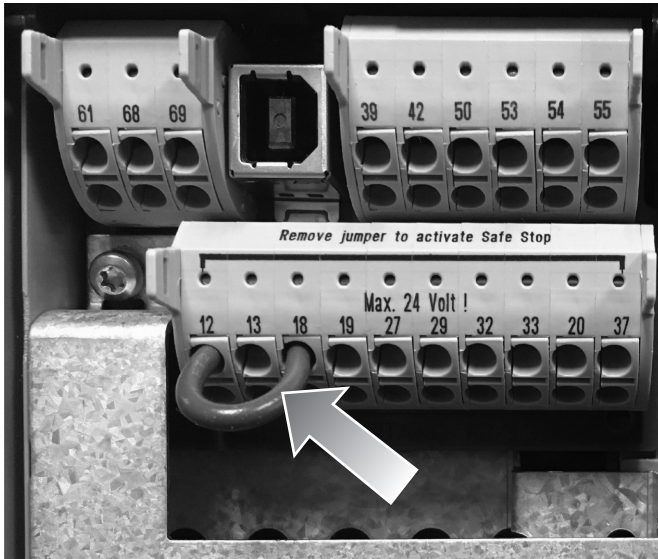

Install Jumper wires on:

- ✓ Terminal 12 and 18

The IPC requires a start command on terminal 18. To apply a start signal connect a jumper wire between terminals 18 (DI 18, parameter 5-10) and 12 (24V dc). A start command is given to the controller when terminal 18 is connected to 24V.

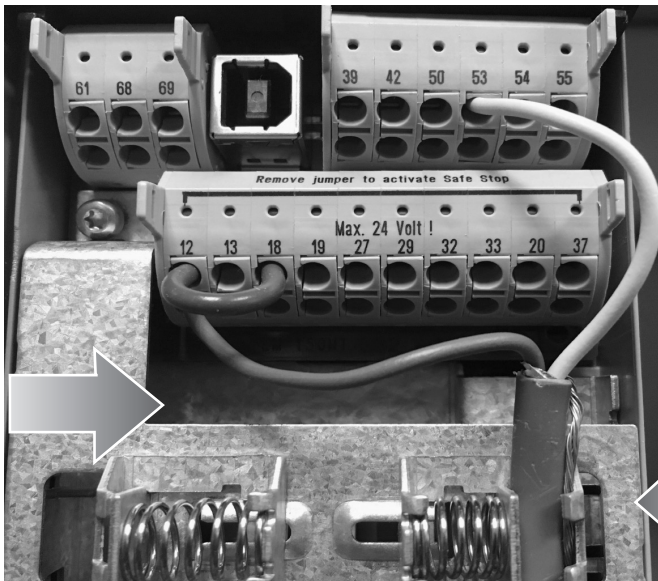

Install Transducer cable on:

- ✓ Brown on terminal 12 (24V)
- ✓ White on terminal 53 (4-20MA)
- ✓ Place ground shield between spring clip and shielded cable.

## Aquavar IPC Start-Up Genie

### MULTI-PUMP CONNECTIONS

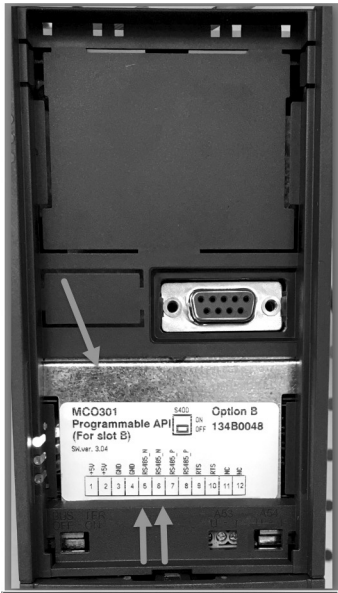

Connect communication wires to the bottom of this card



Carefully remove the plastic cover by unlocking the tab on the top of the drive and releasing.

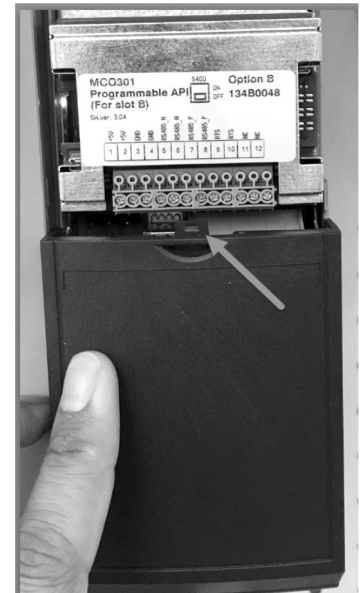

Carefully remove bottom cover by unlocking tab

### Connect Wires



Terminal #5 to Terminal #5

Terminal #7 to Terminal #7

If using more than two controllers, follow the same wiring instructions for the additional drive.

Refer to the IOM for additional multi-control wiring configurations.

Re-install covers and keypad and begin commissioning

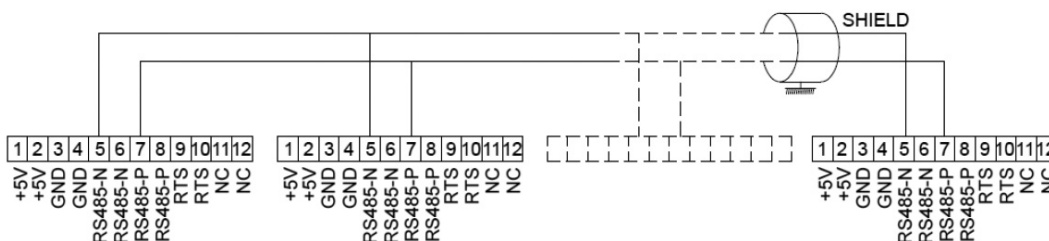

### COMMISSIONING STEPS

1. Power on drive(s)
2. Complete Programming.



Select Quick Menu

Select Parameter 04  
"Start-Up Genie"

You are now able to start the Start-Up  
Genie

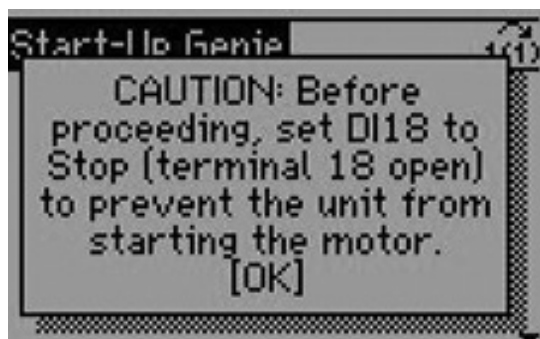

Set DI18 to Stop (terminal 18 open)





For Regional Settings Select North America or International



Select English US as Language and proceed with the down arrow

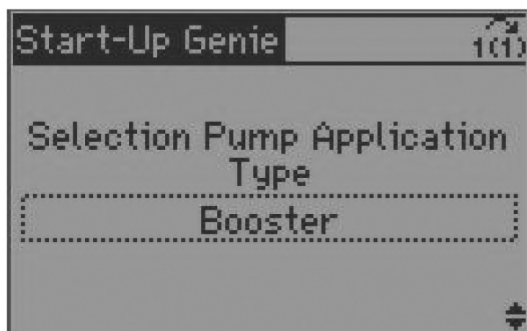

Select Booster for Application type



Select Motor Horsepower

Select Motor Voltage

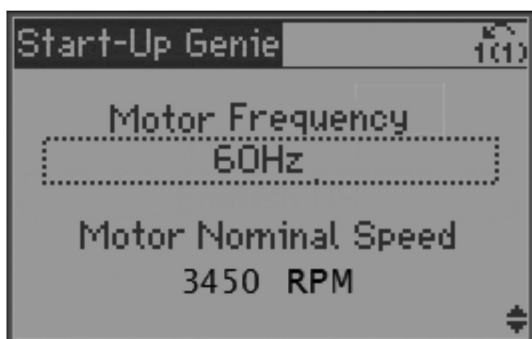

Select Motor Frequency

Select Motor Nominal Speed

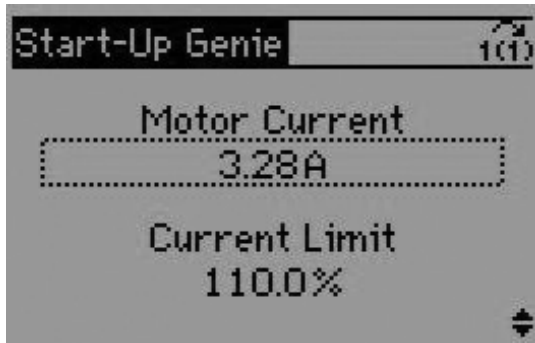

- ✓ Input Motor Current

Example:

SFA is 3.61, FLA is 3.28

Current Limit:  $3.61/3.28 = 1.10$

- ✓ Input Current Limit - SFA/FLA

Carry over the decimal 2 places to the right to ensure your Current Limit percentage = 110%

**For Submersible motors we input SFA and use current limit at 100%**

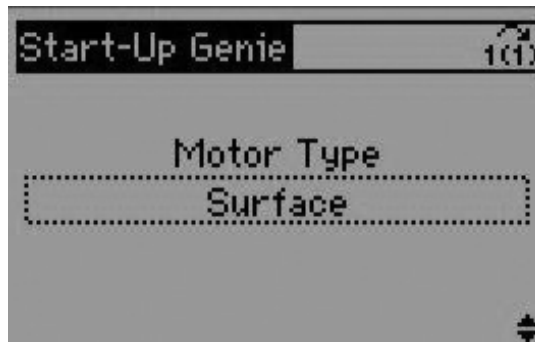

Select Motor Type



Select Sleep Frequency Low Limit

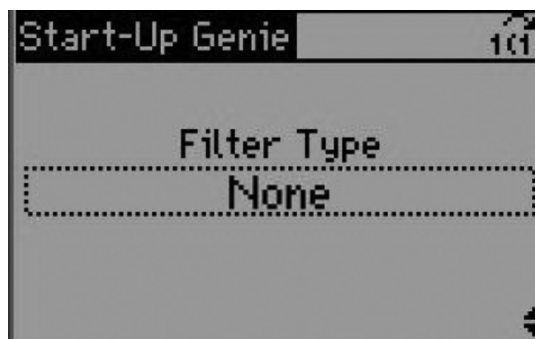

Select Filter Type

- None for no filter
- Reactor-Line Load Reactor (KLR Type)
- Dv/Dt (for V1K Type)
- Sinewave for sinewave

(Please refer to the IOM for further instructions)

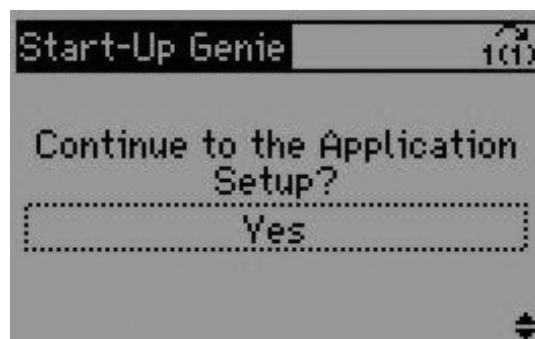

Select Yes to Continue to the Application Setup

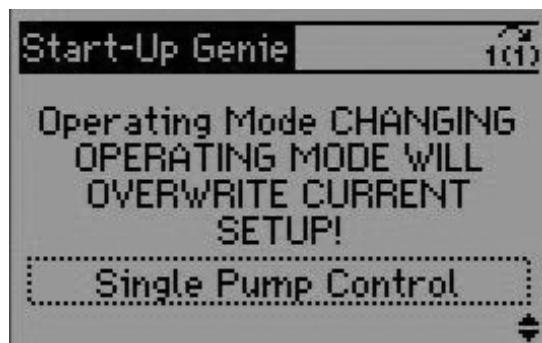

Select either Single Pump or Multi-Pump Control. Follow the programming for single pump application below.

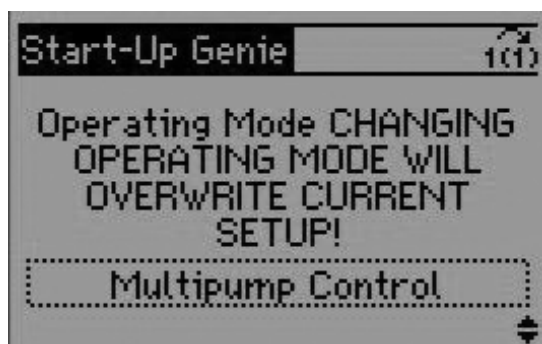

For Multi-Pump Programming, continue to page 14.

### FOR SINGLE PUMP PROGRAMMING



Select Constant Pressure for Application type

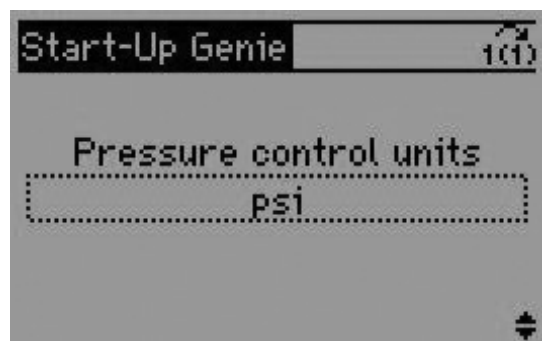

Select PSI for pressure control units

### FOR SINGLE PUMP PROGRAMMING

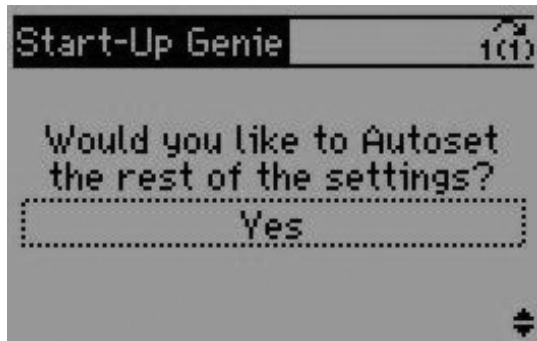

### Select Ramp Time

Fast: 5 sec accelerate, 3 sec decelerate.

Medium: 10 sec accelerate, 5 sec decelerate.

Slow: 20 sec accelerate, 10 sec decelerate.

Select Yes to Autoset the rest of the settings.

For Simplex configuration, here are the parameters that will get autoset:

Autoset Configuration	Constant Pressure
Transducer Max Feedback	300 [unit]
Transducer Type	4-20mA
Feedback 1 Source	AI 53
PID Performance	Normal
Sleep Mode	Enabled
Sleep Frequency	30 Hz
Restart Difference	10 [unit]
No Water/Loss of Prime Fault	Enabled
No Water/Loss of Prime Restart Time	10 min.

Select Setpoint 1

### FOR SINGLE PUMP PROGRAMMING

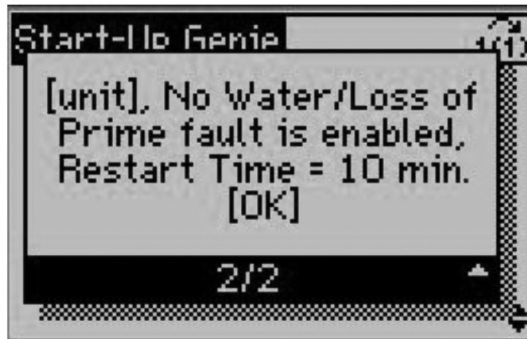
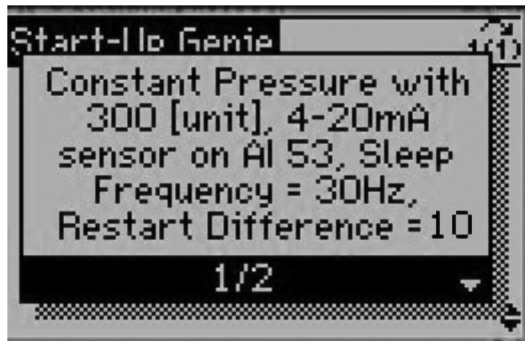

Proceed with the down arrow. Verify that Pressure Transducer is 300 PSI, you are wired in on Analog Input 53, that your sleep frequency is 30 Hz, and your restart difference is 10 [unit], the No Water loss of prime fault is enabled, and your restart time is 10 Minutes.



Check Pump and Motor Rotation by selecting Hand On. If motor is running backwards, power down drive, wait five minutes, and rotate motor wires from the drive. Once rotation is verified, select Off.

Select Auto On. Verify Unit cycles into sleep mode at desired PSI.

**Now perform no flow power calibration on page 17.**

## MULTI-PUMP PROGRAMMING

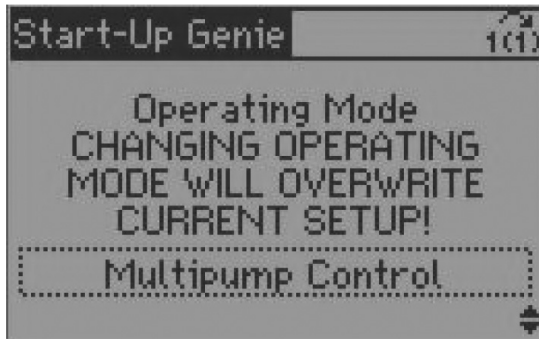

Select Multipump control



Select Multi Master Multi Control

**Note:** Other multi pump configurations are described in the IOM



Select Pump Address for each pump

For each, use a unique address: 1, 2, 3, or 4

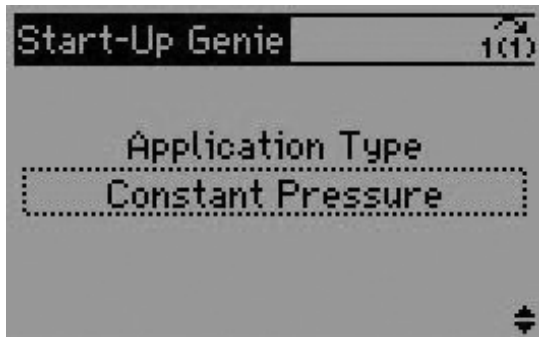

Select Constant Pressure for Application Type

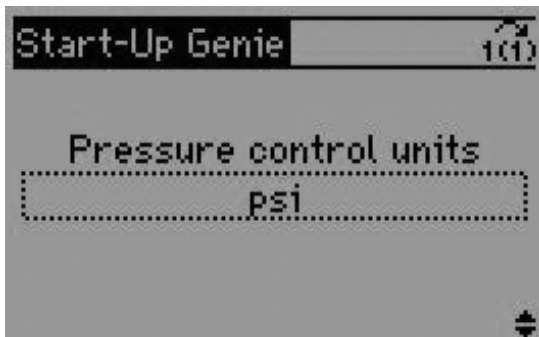

✓ Select psi for Pressure control units

### MULTI-PUMP PROGRAMMING



- ✓ Select Ramp Time

Fast: 5 sec accelerate, 3 sec decelerate.

Medium: 10 sec accelerate, 5 sec decelerate.

Slow: 20 sec accelerate, 10 sec decelerate.

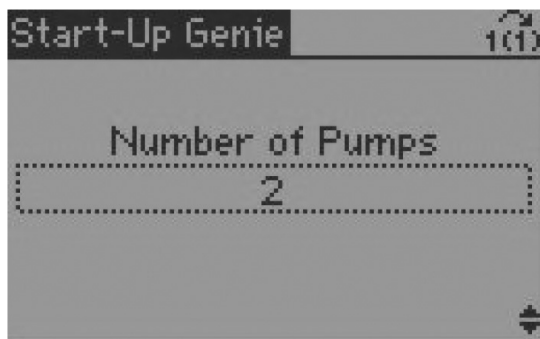

Select Number of Pumps

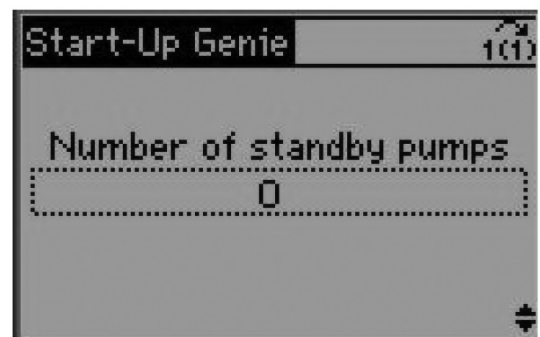

Select Number of Standby Pumps

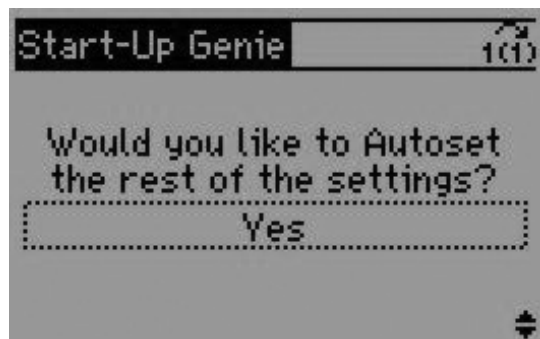

Select Yes to Autoset the rest of the settings.



- ✓ Select Set point PSI

### MULTI-PUMP PROGRAMMING

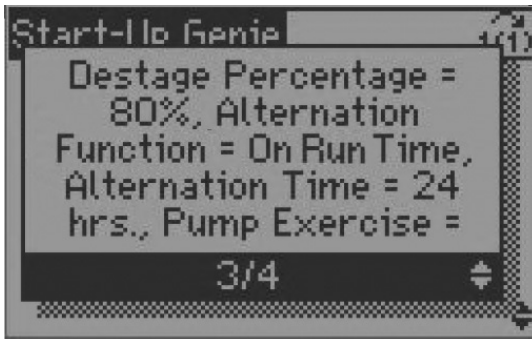
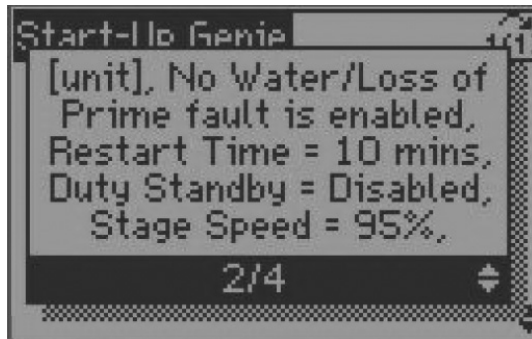
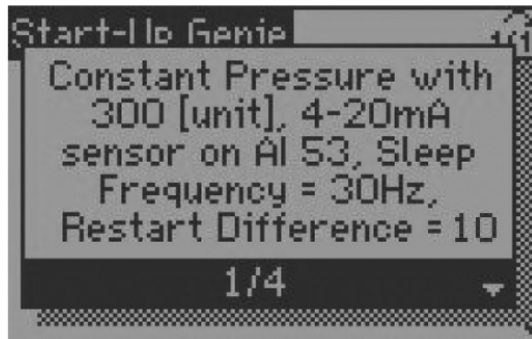

For Multi-Control configuration here are the parameters that will get autoset:

Autoset Configuration	Constant Pressure
Transducer Max Feedback	300 [unit]
Transducer Type	4-20mA
Feedback 1 Source	AI 53
PID Performance	Normal
Sleep Mode	Enabled
Sleep Frequency	30 Hz
Restart Difference	10 [unit]
No Water/Loss of Prime Fault	Enabled
No Water/Loss of Prime Restart Time	Enabled
Duty Standby	Disabled
Stage Speed	95%
Destage Percentage	80%
Alternation Function	On Run Time
Alternation Time	24 Hrs
Pump Exercise	Disabled

Acknowledge Auto Set Settings by pressing the down arrow and cycling through each of the four screens.

For further Multi-Pump Setups, Feedback Setup, Pump Protection Setup, Flow Compensation, Pipe Fill Setup, please refer to the IOM.

Select OK to verify Genie is completed.



### NO FLOW POWER CALIBRATION



The No Flow Power Calibration Setup provides the method to program the no flow power curve in to the controller

- In order to detect a no flow condition for the various pump(s), the no flow power curve needs to be programmed in to the drive



Select Quick Menu

Select 04 Start-Up Genie



Change Setup Selection to Pump Protection.

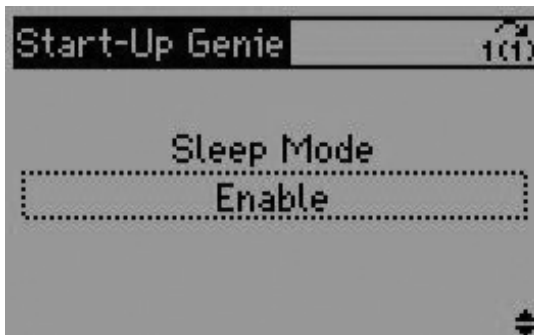

Select Enable for sleep mode.

### NO FLOW POWER CALIBRATION

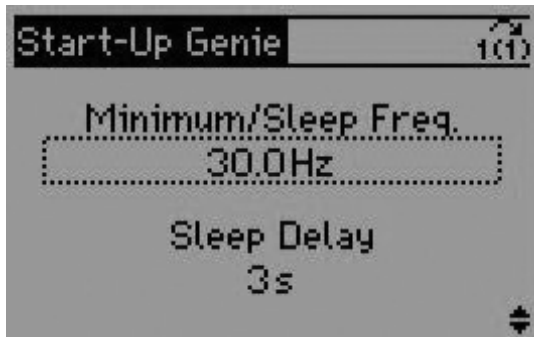

Select 30 Hz for Sleep Frequency, 3 Seconds for Sleep Delay.



Select 10 for Restart difference.

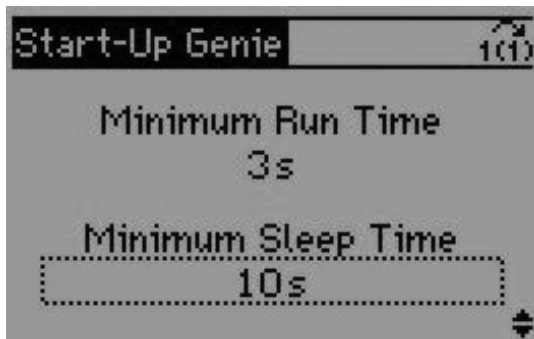

Select 3 Seconds for Minimum Run Time

Select 10 Seconds for Minimum Sleep Time.

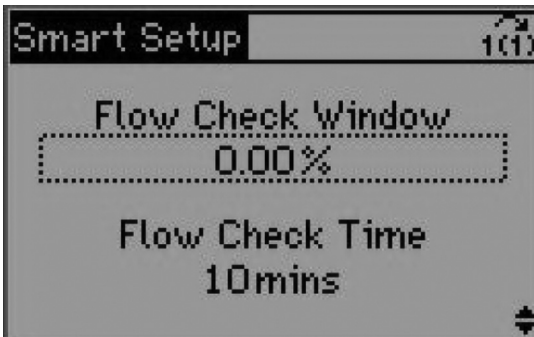

Select 0.0 % for Flow Check Window

Select 10 Mins for Flow Check Time

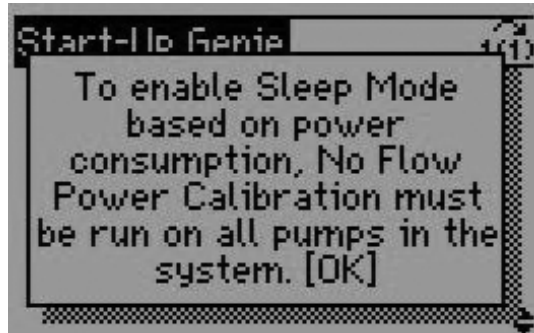

Acknowledge that you are enabling sleep mode based on power consumption and proceed by pushing the down arrow.

### NO FLOW POWER CALIBRATION

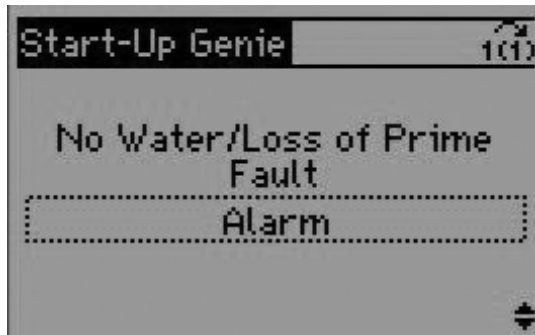

Select Alarm for No Water Loss of Prime Fault

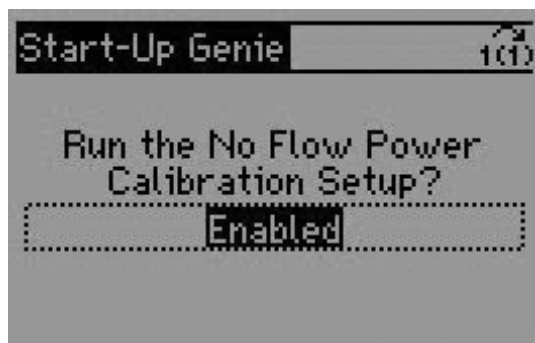

Select Enable for No Flow Power Calibration

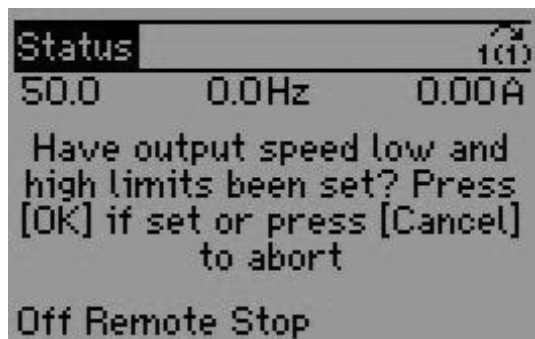

Follow all on-screen instructions carefully.

**WARNING:** The No Flow Power Calibration Process requires the pump to be operated at no flow. This can produce high pressure within the system. Ensure the system piping and components are designed to withstand the suction pressure plus shutoff head pressure produced by the pump prior to starting the calibration process.



Close outlet valve before starting.

The drive will now run through steps 1-5.

### NO FLOW POWER CALIBRATION

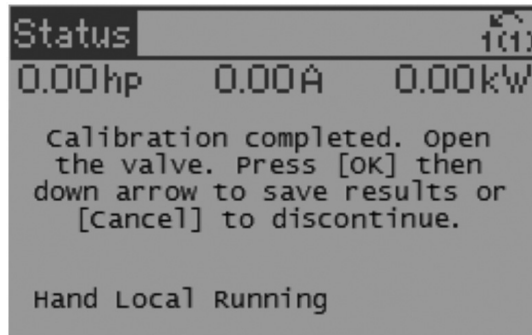

Once the calibration is completed, select OK and the down arrow to proceed.

Repeat for all drives if you are in multi-control.

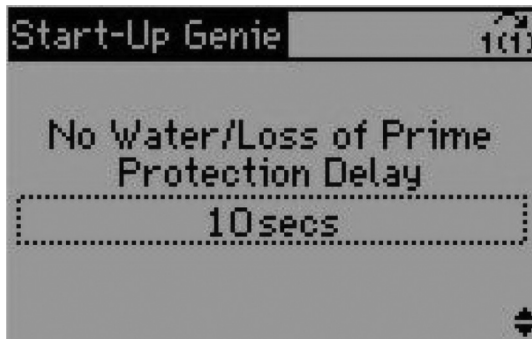

Select 10 Seconds for No Water Loss of Prime Protection Delay

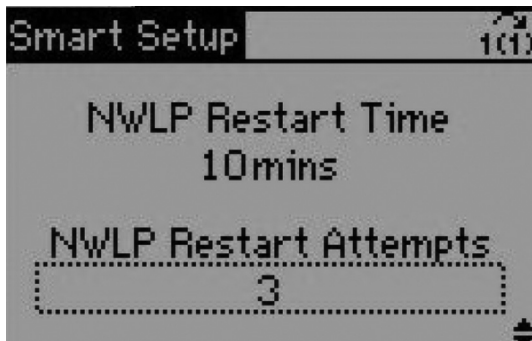

Select 10 Mins for NWLP Restart Time

Select 3 for NWLP Restsrt Attempts

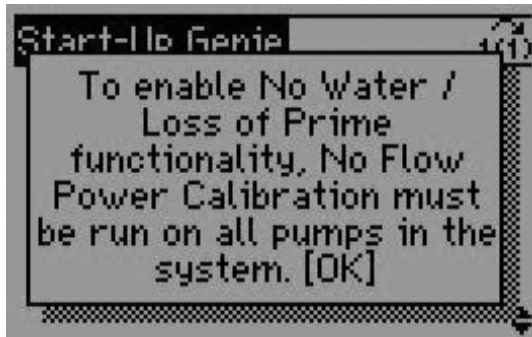

Proceed with the down arrow acknowledging that you are enabling your loss of prime functionality.

Select OK

### NO FLOW POWER CALIBRATION

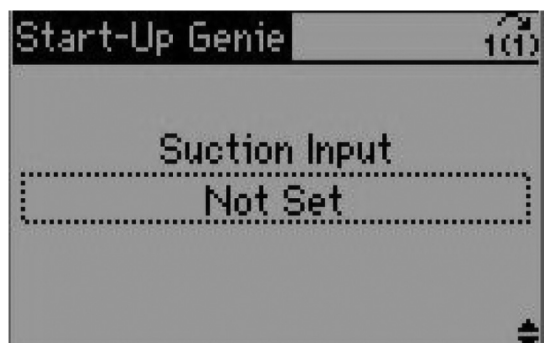

Select Not Set for Suction Input

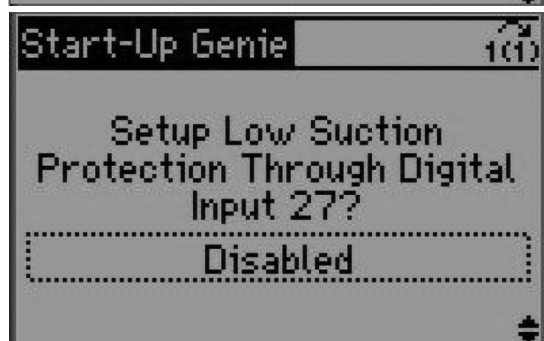

Select Disabled for Digital input 27



Select Disabled for Digital input 29



Select manual Reset Alarm for Under Pressure Function

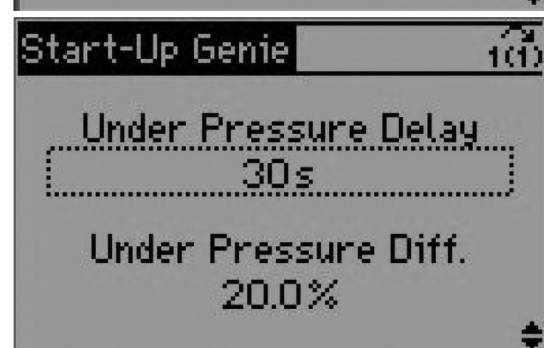

Select 30 Seconds for Under Pressure Delay and 20.0% for Under pressure Difference

### NO FLOW POWER CALIBRATION

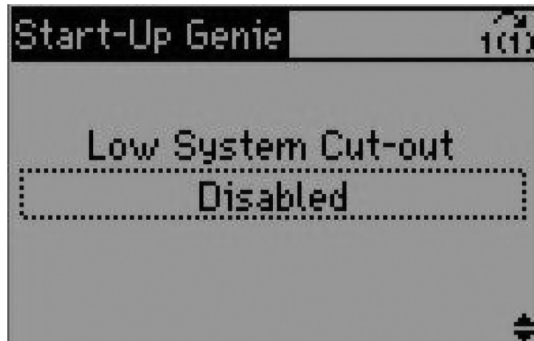

Select Disabled For Low System Cut-out



Select Disabled for High System fault

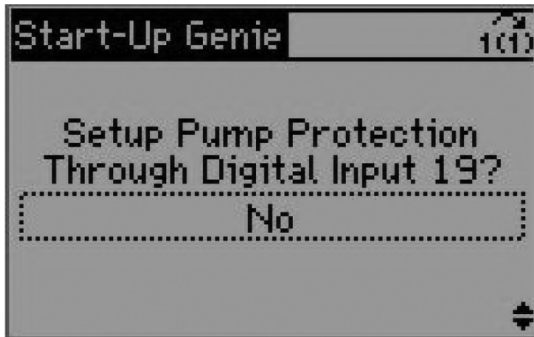

Select No for Digital Input 19

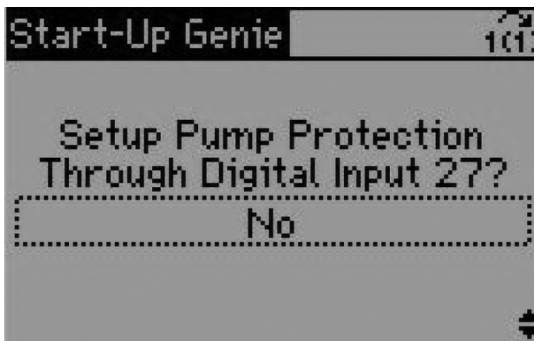

Select No for Digital input 27

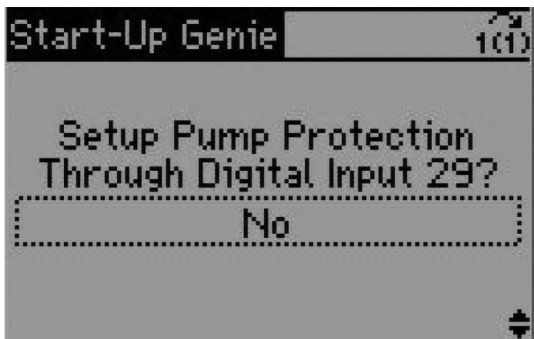

Select No for Digital Input 29

### NO FLOW POWER CALIBRATION



0 Seconds for Priming delay

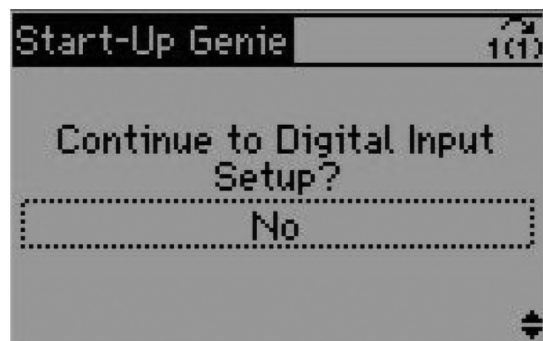

Select No for Continuing Digital Input Setup

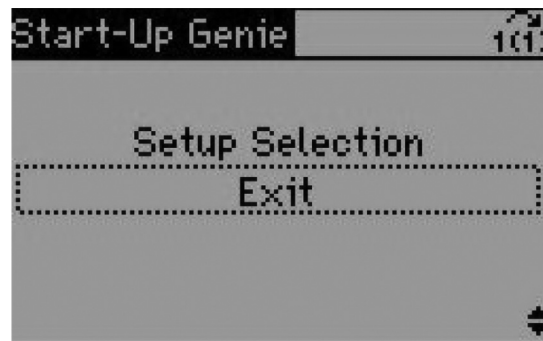

Change Setup Selection to Exit, hit OK and Down key



Press OK

**To setup the INTELLIGENT PUMP CONTROLLER TO RUN IN SPEED CONTROL, refer to (IM295)**

**For troubleshooting issues, refer to AQUAVAR IPC Q&A (AQIPCQA)**

## VFD/CONTROLS TECHNICAL SUPPORT

### Controls Technical Hotline 866-673-0445

Alexander Pytlak (Seneca Falls, NY)  
Alexander.Pytlak@xyleminc.com  
315-239-2314 office

Scott McDonnell (Anaheim, Ca)  
scott.mcdonnell@xyleminc.com  
714-397-4950 cell

Ryan VanNederynen (Seneca Falls, NY)  
ryan.vannederynen@xyleminc.com  
315-239-7041 office

Felix Briceno (Seneca Falls, NY)  
felix.briceno@xyleminc.com  
315-239-2328 office

Matt Renn (Fresno, CA)  
matt.renn@xyleminc.com  
559-265-4737 office



**Xylem Inc.**  
2881 East Bayard Street Ext., Suite A,  
Seneca Falls, NY 13148  
Phone: (866) 673-0445 Fax: (888) 322-5877  
[www.xylem.com/centripro](http://www.xylem.com/centripro)

CentriPro is a trademark of Xylem Inc. or one of its subsidiaries.  
© 2019 Xylem Inc. IM311 Rev. 1 August 2019

