



ARCHITECTURAL CATALOG



MORTISE LOCKSETS

p. 1



CYLINDRICAL LOCKSETS

p. 8



TUBULAR LOCKSETS

p. 14



LIFE SAFETY LOCKSETS

p. 17



IQUE SERIES ACCESS CONTROL

p. 22



LOCDOWN™ SERIES

p. 24



ARCHITECH™ WIRELESS ACCESS CONTROL

p. 26



X-IT™ EXIT DEVICES

p. 31



CYLINDER & HI-SECURITY

p. 36



INTRODUCTION

Marks USA Architectural Guide was created to give a more in depth description about products suitable for installation in School Systems, Housing Authorities, Hospitals, Commercial Buildings, etc. Contained within this guide is information about our Nova Series Mortise Locksets, the Protector Series Mortise Locksets, Commercial Grade Mortise Locksets and Deadlocks, Survivor Series Cylindrical Leversets, Defender Series Deadbolts & Deadlatches, our Custom Lockset Division, Institutional Life Safety Locksets, Hospital Push/Pull Paddlesets, the i-Qwik Electronic Access Control Series, Biometric Fingerprint Reader with Cylindrical Leverset, Door Closers, Exit Devices, Hinges and HI-SECURITY™ Cylinders. The guide assists the institutional user by informing the reader of lockset features which will satisfy the requirements of institutional facilities for both design and maintenance.

TABLE OF CONTENTS

Mortise Locksets	1-7	LocDown™ Series	24-25
NOVA Series 5 & 55 Grade 1 Mortise Locksets	1	LA318GJ	25
Protector Series BE101 & LA118 Grade 1 Mortise Locksets	2	ArchTech™ Series	26-30
Series 7 & 9 Commercial Grade Mortise Locksets; Series 31, 2 & 3 Mortise Deadlocks	3	Standalone, Networked, Enterprise	26
Mortise & Tubular Lock Trim	4-5	Standalone Keyless Access System	27
Mortise Lockset Functions	6-7	Trilogy Network Gen.2 Gateways & Expanders	28
Cylindrical Locksets	8-13	Trim Options / How To Order	29
Survivor Series Grades 1 & 2 Cylindrical Leversets	8	Select Standard Mortise & Tubular Lock Trim Options	30
Clutch System	9	X-it Exit Devices	31-35
Super Strength Retractor	9	Series M9900 Exit Device - Rim Mount	31
Long Life Lever Support Springs	9	Series M9900 VR Exit Device	31
Strength & Life	9	Series M9900 Exterior Trim	32
Quick Installation	9	Series M195 Exit Device Trim	33
Easy Installation	10	Series M8800 Narrow Stile Exit Device	33
Uses Most Available Cylinders (Tailpieces: Standard & IC Core)	10	Electric Latch Retraction	34
Cylinders	10	Electrified Mortise Exit Device	34
ADA • Grades 1 & 2 • Made in U.S.A.	10	Exit Alarm	34
Survivor Series Grade 1 REX & Electrified Leversets	11	Electric Frame Actuator	35
175 Grade 2 Economy Series Cylindrical Leversets	12	Electric Dogging	35
Cylindrical Knob/Lever Functions	13	Delayed Egress	35
Tubular Deadbolts & Cylindrical Cartridge Deadlatches	14-15	HI-SECURITY™ & Security-Mate™ Cylinders	36-44
Defender Series Tubular Deadbolts & Cylindrical Cartridge Deadlatches	14	What Makes Marks HI-SECURITY™ Cylinders Unique?	36
Unique Features	15	Cylinder Configuration	36
Protective Steel Shutters	15	Marks Security-Mate™ Cylinders	37
Simple Fast Assembly	15	Marks USA HI-SECURITY™ Key Control Management Package	38
One Cylinder Fits All	15	Service Equipment	38
Easy Retrofit Deadbolt	15	Small Format Interchangeable Core (SFIC)	39
Custom Lockset Division	16	Sidebar & Security Finger Pins	39
About Marks USA Custom Lockset Division	16	Security Finger Pin Replacement Procedure	39
Institutional Life Safety Locksets	17-20	Another Key Control Option	40
SS55 Series Institutional Life Safety Grade 1 Mortise Locksets - Knobs	17	Operation & Hardware Installation	40
SS19 Series Institutional Life Safety Grade 1 Mortise Locksets - Levers	18	Compatibility	40
SS19 Series Institutional Life Safety Grade 1 Cylindrical Locksets - Levers	19	Key Blank Overview	41
SS55 Series Institutional Life Safety Grade 1 Cylindrical Locksets - Knobs and Mortise Deadlocks ..	20	Key Specifications	41
Hospital Locksets	21	Pin Specifications	42
PD Series Grade 1 Mortise & Cylindrical Push/Pull Paddlesets	21	Combining & Capping Procedures	42
Electronic Access Control	22-23	Marks USA HI-SECURITY™ Cams & Tailpieces	43
i-Qwik LITE Series Electronic Access Control	22	Marks USA HI-SECURITY™ Retro-Fit Key-In-Knob Tailpieces	43
i-Qwik Series Rim Exit Device Stand Alone Access Control, Adapter Plates	23	Marks USA HI-SECURITY™ Retro-Fit Key-In-Knob Tailpieces (cont'd.)	44

Marks USA Antimicrobial Finish - Peace of mind for your hardware application when protected against GERMS and MOLD using Stericoat AM. Marks USA antimicrobial finish is recommended for hospitals, assisted living facilities, schools and childcare facilities. **Use Code - AM**

***Lifetime Mechanical Limited Warranty:** MARKS USA warrants that its products are free from defects in materials and workmanship. This warranty is limited to the lifetime of the door on which our lock is installed. In the event our product does not conform to this warranty, MARKS USA will repair or replace the product free of charge. This warranty does not cover defects or damage arising from improper installation, lack of or improper maintenance, improper storage, shipping and handling, ordinary wear and tear, misuse, abuse, accident, unauthorized service, or use with unauthorized non-MARKS products or parts. We reserve the right to make changes in materials, components or manufacturing methods. Liability under all warranties expressed or implied is limited to replacement of the defective goods. This warranty does not cover nor provide for the reimbursement or payment of incidental or consequential damages. Additionally, the company will not warrant ANSI A156.2 Grade 2 lever product installed in educational facilities and student housing.

2 Year Electronic Limited Warranty: MARKS USA warrants to the original purchaser that its products are free from defects in materials and workmanship so long as they occupy the premises. In the event our product does not conform to this warranty, MARKS USA will repair or replace the product free of charge at its sole discretion. This warranty does not cover defects or damage arising from improper installation, lack of or improper maintenance, improper storage, shipping and handling, improper application or specification, ordinary wear and tear, misuse, abuse, accident, improper voltage, unauthorized service, or use with unauthorized non-MARKS products or parts. We reserve the right to make changes in materials, components or manufacturing methods. Liability under all warranties expressed or implied is limited to replacement of the defective goods. This warranty does not cover nor provide for the reimbursement or payment of incidental or consequential damages or any shipping charges related to exercising of this warranty.

Lifetime Finish Limited Warranty: MARKS USA finishes with the suffix "E" indicate finishes which have a "PVD" coating. Locksets with the "3E" finish will be warranted to the original user against tarnishing as long as the user occupies the residential premises upon which the lockset was originally installed. Locksets with this finish, used in commercial applications will be limited to two years. This warranty does not cover scratches, abrasion, abused or misused products. Upon return of a defective product to Marks USA, we will, at our sole discretion, either replace the product or refund the purchase price in exchange for the product. Due to climatic conditions, chemical or abrasive actions, other finishes are excluded from this warranty. This warranty does not cover nor provide for the reimbursement or payment of incidental or consequential damages arising from the sale of the product.

NOVA SERIES 5 & 55

MORTISE LOCKSETS ANSI 156.13 GRADE 1

NOVA SERIES 5 & 55 MORTISE LOCKSETS

Our Nova Series Mortise Locksets represent years of development into world class BHMA Certified mortise locksets and carry the Marks Lifetime Mechanical Warranty. The Nova Series is available with a variety of different knobs, levers, roses and plates as well as custom capabilities with 32 functions in popular finishes. Whether your application is a single style single function lockset or an entire complex with multiples and varieties, the Nova Series has the form, fit and competitive price to complete your project.

- Nova Series Grade 1 Mortise Locksets are **BHMA** Certified
- Thru-bolted trim for proper alignment and ease of installation
- Self adjusting spindles • Independent lever support springs
- *Lifetime Mechanical Warranty*

AUTO-REVERSING MORTISE LOCKSET NOW AVAILABLE!

EASILY REVERSIBLE
WITHOUT REMOVING
THE COVER OR
INTERNAL PARTS

patent pending

Electrified Models Excluded

MARKS # 5 & 55	FUNCTION	ANSI #	FINISH GROUPS
KEYED SINGLE CYLINDER, NO DEADBOLT			
D	OFFICE / VESTIBULE		3, 10, 10B, 32, 32D
DW	VESTIBULE		
E	OFFICE	F04	
EW	STOREROOM	F07	
J	CLASSROOM	F05	
JM, JR	HOSPITAL (HOLDBACK)	F06	
GL	INST. PRIVACY	F26	
EL	ELECTRICALLY LOCKED		
EU	ELECTRICALLY UNLOCKED		
KEYED SINGLE CYLINDER, WITH DEADBOLT			
A	ENTRANCE	F08, F10	
B	ENTRANCE	F21	
F	DORMITORY	F12	
FS	DORMITORY		
FW	DORMITORY	F13	
FD	APARTMENT	F20	
H	HOTEL	F15	
LH	SPEC. PRIVACY		
KEYED DOUBLE CYLINDER, NO DEADBOLT			
G	ENTRANCE	F09	
GC	INTRUDER LATCHBOLT	F32	
GG	CLASSROOM SECURITY		
GR	CLASSROOM SECURITY w/HOLDBACK		
WW	INSTITUTION	F30	
KEYED DOUBLE CYLINDER, WITH DEADBOLT			
AC	ENTRANCE	F35	
C	STOREROOM	F14	
FC	INTRUDER DEADBOLT	F34	
FA	DORMITORY	F11	
FX	DORMITORY	F33	
KEYLESS			
N	PASSAGE	F01	
L	BATHROOM	F02	
LF	PRIVACY	F19	
LJ	PRIVACY	F22	
EX	EXIT	F31	

STANDARD FEATURES

5 Series (2-3/4" backset); 55 Series (2-1/2" backset)

- Lock Front:** Adjustable bevel steel backplate 1-1/4" x 8" x 7/64" thick stainless steel. Cover plate 1/16" thick.
- Deadbolt:** Stainless steel with hardened roll pins, 1" throw.
- Latch:** Solid stainless steel with antifriction latch lever, 3/4" throw (reversible).
- Auxiliary Deadlatch:** 1/2" throw (reversible).
- Hubs:** Steel, 9/32" on diamond, 5/16" on square with security separator. Independent exterior and interior lever support springs.
- Lever Support Springs:** Lever support springs with 5/16" Hubs
- Hub Follower:** (to lock hub) steel 1/8" thick.
- Hub Stop:** (to limit lever travel) steel 1/8" thick.
- Case:** Stamped steel 3/32" thick, zinc dichromate finish.

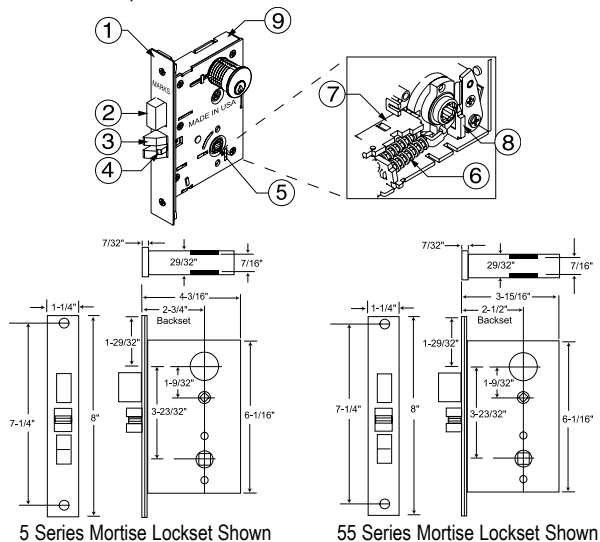

*** Standard & HI-SECURITY™ IC Core Models:**
Interchangeable Core models for 6 or 7 pin cores (not included).
Accepts: Marks, Marks HI-SECURITY™, Medeco®, KeyMark™, Falcon, Schlage® small format & Best®. **IC Core Tailpieces ARE Included.**

NOVA SERIES GRADE 1 MORTISE LOCKSETS

PROTECTOR SERIES

MAXIMUM SECURITY MORTISE LOCKSETS ANSI 156.13 GRADE 1

PROTECTOR SERIES

All Marks USA Protector Series mortise locksets feature an "Override Guard" which is designed to result in spindle failure when torque of over 550 foot lbs. is applied. The lockset remains locked and when spindle is replaced, the lockset is fully operational. Protector Series locksets have a lifetime mechanical warranty, meet or exceed all operational and security tests of ANSI A156.13-2002 for Series 1000, Grade 1. Protector Series Locksets are UL listed, 3-hour fire rated and meet ADA requirements.

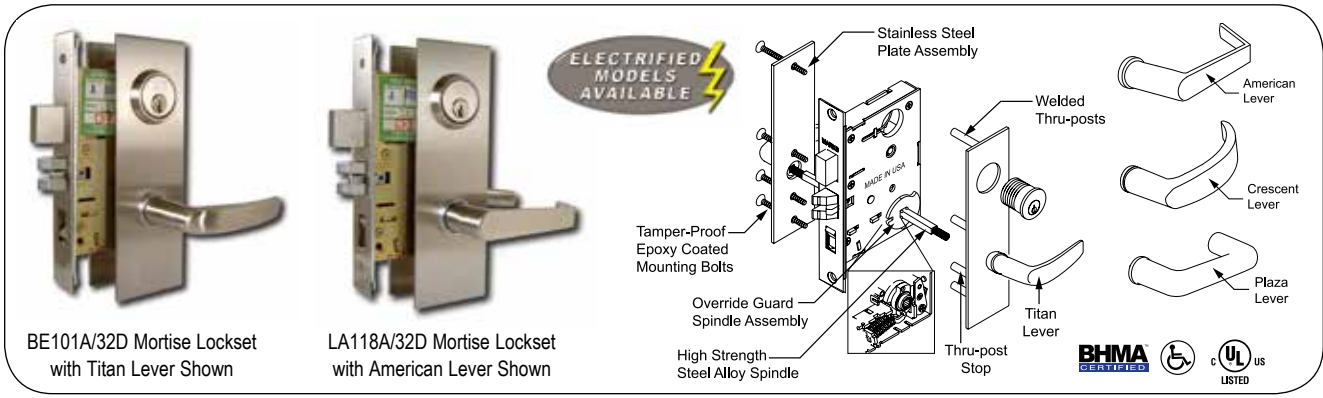

MARKS #	FUNCTION	ANSI #	FINISH GROUPS❖	MARKS #	FUNCTION	ANSI #	FINISH GROUPS❖	
BE101 & LA118				BE101 & LA118				
KEYED SINGLE CYLINDER, NO DEADBOLT				KEYED DOUBLE CYLINDER, NO DEADBOLT				
D	OFFICE VESTIBULE		3, 10, 10B, 32D	G	ENTRANCE	F09	3, 10, 10B, 32D	
DW	VESTIBULE			GC	INTRUDER LATCHBOLT	F32		
E	OFFICE	F04		WW	INSTITUTION	F30		
EW	STOREROOM	F07		KEYED DOUBLE CYLINDER, WITH DEADBOLT				
GL	INST. PRIVACY	F26		AC	ENTRANCE	F35		
J	CLASSROOM	F05		C	STOREROOM	F14		
JM, JR	HOSPITAL (HOLDBACK)	F06		FC	INTRUDER DEADBOLT	F34		
EL	ELECTRICALLY LOCKED			FA	DORMITORY	F11		
EU	ELECTRICALLY UNLOCKED			FX	DORMITORY	F33		
KEYED SINGLE CYLINDER, WITH DEADBOLT				KEYLESS				
A	ENTRANCE	F08, F10	N	PASSAGE	F01	3, 10, 10B, 32D		
B	ENTRANCE	F21	L	BATHROOM	F02			
F	DORMITORY	F12	LF	PRIVACY	F19			
FS	DORMITORY		LJ	PRIVACY	F22			
FW	DORMITORY	F13	EX	EXIT	F31			
FD	APARTMENT	F20	DUMMY TRIM					
H	HOTEL	F15	DI, DO	DUMMY TRIM INSIDE/OUTSIDE				
LH	SPEC. PRIVACY		DT	DUMMY TRIM				

❖ Additional Finishes, Consult Factory.

STANDARD FEATURES

Performance Specifications:

Life Test: 1,500,000 cycles minimum.

Exterior and Interior Trim Specifications:

Brushed stainless steel plate assemblies with machined lever bearings.
Screwless stainless steel levers assembled to plate with hardened snap rings.
(Levers cannot be removed without disassembling trim plates from inside.)

Additional trim designs are available with override guard lock protection, Consult factory.

Exterior: 4 welded thru-posts. Center posts pass through lock body, automatically aligning trim 8-1/2" x 2-3/4" x 1/8" thick

Interior: 4 stainless steel, tamper-proof mounting bolts connecting inside plate, 8-1/2" x 2-3/4" x 1/8" thick

Cylinder: 1-1/8" long solid brass, 6 pin with 2 keys

Strike: 4-7/8" x 1-1/4" x 3/32" thick, 5/8" curved lip
Conforms to ANSI spec., A115.1

Door Thickness: 1-3/4" standard. Extended range available
Screwless Lever Choices: American, Crescent, Plaza & Titan

Lock Specifications: 5 Series (2-3/4" Backset)

NOVA SERIES GRADE 1 MORTISE LOCKSETS ARE BHMA CERTIFIED

Lock Front: Adjustable bevel steel backplate 1-1/4" x 8" x 7/64" thick;

Cover plate 1/16" thick with tamper-proof screws

Deadbolt: Stainless steel with hardened roll pins, 1" throw

Latch: Solid stainless steel with antifriction latch lever, 3/4" throw (reversible)

Aux. Deadlatch: 1/2" throw (reversible)

Case: Stamped steel 1/16" thick

Hubs: Steel, 5/16" on square w/security separator, 9/32" on diamond;
Independent exterior and interior lever support springs

Hub Lock Arm: Steel 1/8" thick (to lock hub)

Exterior Lever Override Guard Integral cam spindle/spring assembly engages hub lock arm, case hardened steel, 1/8" thick.

Interior Lever Override Guard Integral cam spindle/spring assembly prevents interior lever override, case hardened steel, 1/8" thick

❖ **Standard & HI-SECURITY™ IC Core Models:** Interchangeable Core models for 6 or 7 pin cores (not included). **Accepts:** Marks, Marks HI-SECURITY™, Medeco®, KeyMark™, Falcon, Schlage® small format & Best®. **IC Core Tailpieces ARE Included.**



COMMERCIAL GRADE

SERIES 7 & 9 MORTISE LOCKSETS & SERIES 31, 2 & 3 MORTISE DEADLOCKS

COMMERCIAL GRADE MORTISE LOCKSETS SERIES 7 & 9

Marks 7 & 9 Series Mortise Locksets feature a high pressure cast Zamac body with a baked enamel finish to resist corrosion, cast alloy 1" throw deadbolt for strength, and a flexible face plate that may be installed flat or with a 3 degree bevel. The 7 & 9 Series are available with a variety of different knobs, levers, roses and plates making these efficient mortise locksets a great choice for commercial applications when grade 1 fire rated locksets are not required.



7NY10/3 Mortise Lockset with New Yorker Plate & Round Knob Shown

9NY10/26 Mortise Lockset with New Yorker Plate & Round Knob Shown

MARKS # 7 & 9	FUNCTION	ANSI #	FINISH GROUPS	
KEYED SINGLE CYLINDER, NO DEADBOLT				
D	OFFICE / VESTIBULE		3, 10, 10B, 32, 32D	
DW	VESTIBULE			
KEYED SINGLE CYLINDER, WITH DEADBOLT				
A	ENTRANCE	F08, F10		
B	ENTRANCE	F21		
F	DORMITORY	F12		
FS	DORMITORY			
FW	DORMITORY	F13		
KEYED DOUBLE CYLINDER, WITH DEADBOLT				
AC	ENTRANCE	F35		
C	STOREROOM	F14		
FA	DORMITORY	F11		
FX	DORMITORY	F33		
KEYLESS				
N	PASSAGE	F01		
L	BATHROOM	F02		
LF	PRIVACY	F19		

* Standard & HI-SECURITY™ IC Core Models: Interchangeable Core models for 6 or 7 pin cores (not included). Accepts: Marks, Marks HI-SECURITY™, Medeco®, KeyMark™, Falcon, Schlage® small format & Best®. IC Core Tailpieces ARE Included.

STANDARD FEATURES

Series 7:

- Backset: 2-3/4"
- Bolt throw: Cast alloy full 1" throw
- Latch throw: 5/8" (anti-friction)
- Case: High pressure cast Zamac, baked enamel finish
- Front: 1-1/4" x 8", Flat or 3° bevel
- Hubs: 9/32" on square steel with security separator

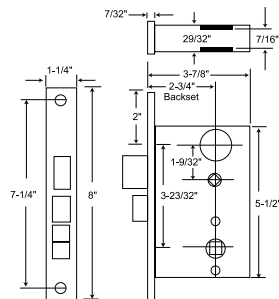

Series 9:

- Backset: 2-1/2"
- Bolt throw: Cast alloy full 1" throw
- Latch throw: Solid brass 1/2" throw, reversible
- Case: High pressure cast Zamac, baked enamel finish
- Front: 1-1/16" x 7-5/8", Flat or 3° bevel
- Hubs: 9/32" on square steel with security separator

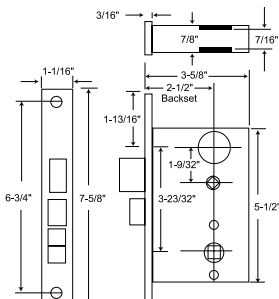

MORTISE DEADLOCKS SERIES 31, 2 & 3



Series 31 Mortise Deadlock

Series 2 Mortise Deadlock

Series 3 Mortise Deadlock

MARKS # 31, 2 & 3	FUNCTION	ANSI #	FINISH GROUPS
—	LOCK ONLY	—	3, 3E, 10, 10B, 26, 26D, 32, 32D
K	CYLINDER x TURNPIECE	E06072	
L	COMMUNICATING SINGLE CYL.	E06082	
M	DOUBLE CYLINDER	E06062	
S	CLASSROOM (Specify Handing)	E06092	
X	TURNPIECE ONLY		

* Standard & HI-SECURITY™ IC Core Models: Interchangeable Core models for 6 or 7 pin cores (not included). Accepts: Marks, Marks HI-SECURITY™, Medeco®, KeyMark™, Falcon, Schlage® small format & Best®. IC Core Tailpieces ARE Included.

STANDARD FEATURES

Series 31 BHMA Certified:

- Backset: 2-3/4"
- Bolt throw: 1" stainless steel with hardened roll pins
- Case: Stamped Steel
- Front: 1-1/16" x 4-5/8" adjustable bevel
- Cylinder: Solid brass cylinder, 6-pin, "C" keyway, 2 keys
- Strike: #4035 Included

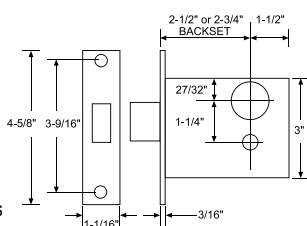

Series 2 & 3:

- Backset: Series 2: 2-1/2"; Series 3: 2-3/4"
- Bolt throw: 1"
- Case: High pressure cast
- Front: 1-1/16" x 4-5/8" flat or 3° bevel
- Cylinder: Solid brass cylinder, 6-pin, "C" keyway, 2 keys
- Strike: #4035 Included

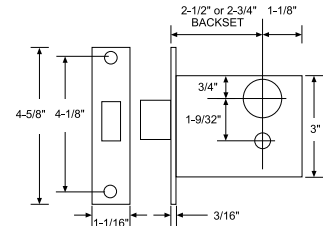

MORTISE & TUBULAR LOCK TRIM

NOTE: ROSES ALSO AVAILABLE IN 2-1/4" DIAMETER

TRIM

Marks USA offers a great many designs of knobs, levers, turnpieces and pull handles in both brass and stainless steel. Locksets using these designs need minimum orders and may require longer delivery time since they are not normally stocked. At this time, there are more than 300+ designs available and more are being added constantly. We also offer designs made to customers individual specifications.



ROSE RR

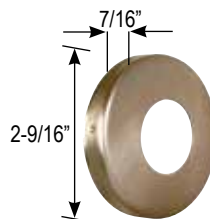

ROSE RW

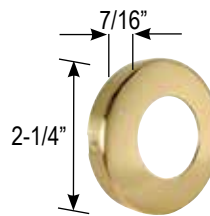

ROSE RS

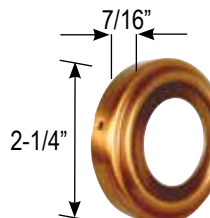

ROSE RQ

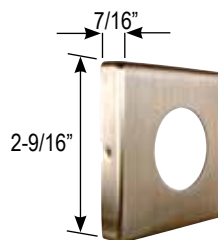

ROSE RX



ROUND 10

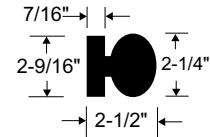

BALL 20/30

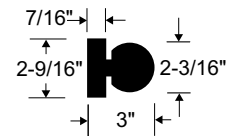

ECLIPSE 60

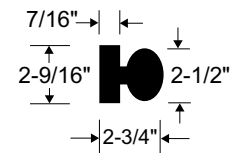

MONACO 57

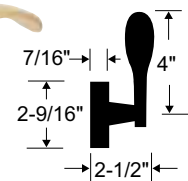

DAYTON 83

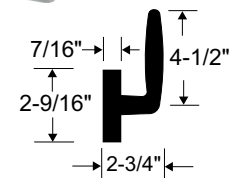

MORTISE & TUBULAR LOCK TRIM

MORTISE & TUBULAR LOCK TRIM

NOTE: ROSES ALSO AVAILABLE IN 2-1/4" DIAMETER

TRIM

Marks USA offers a great many designs of knobs, levers, turnpieces and pull handles in both brass and stainless steel. Locksets using these designs need minimum orders and may require longer delivery time since they are not normally stocked. At this time, there are more than 300+ designs available and more are being added constantly. We also offer designs made to customers individual specifications.

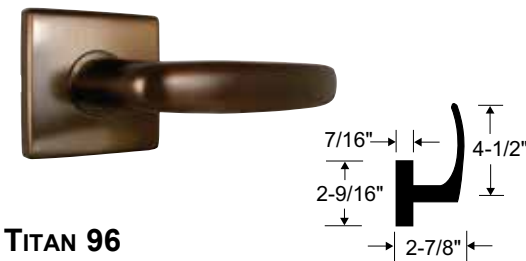
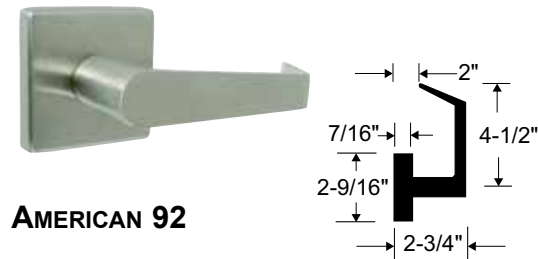
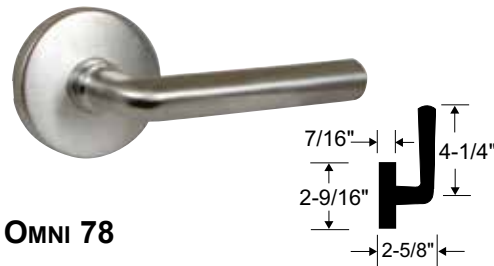
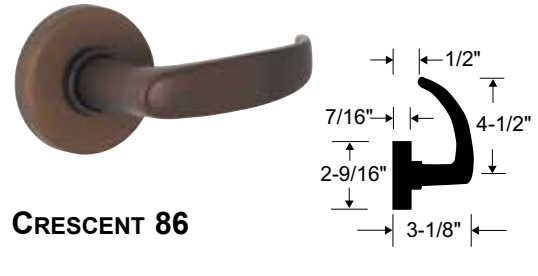
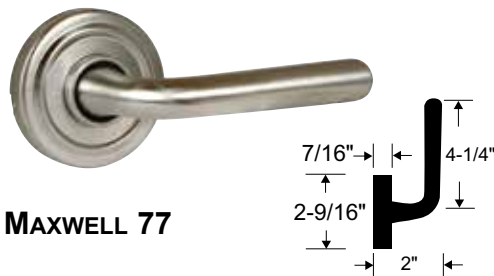
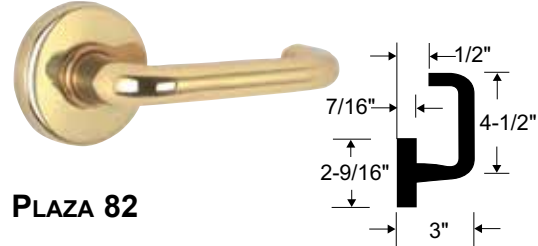
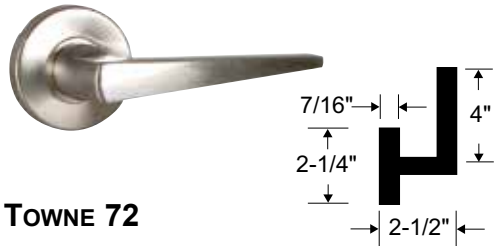







































MORTISE & TUBULAR LOCK TRIM

MORTISE LOCKSET FUNCTIONS

ANSI 156.13 GRADE 1

MORTISE LOCKSET FUNCTIONS

MORTISE LOCKSET FUNCTIONS

SINGLE CYLINDER FUNCTIONS					SINGLE CYLINDER FUNCTIONS				
ANSI #	Cam	Strike	Marks	Function	ANSI #	Cam	Strike	Marks	Function
F04: OFFICE Latch by knob/lever either side except when outside knob/lever locked by stop-button in front; then by key outside. Auxiliary latch deadlocks latch. Inside always open.			I/S	O/S E	F20: APARTMENT Latch by knob/lever either side except when outside locked by stop-button or projected deadbolt. Latch deadlocked by auxiliary latch or deadbolt. Deadbolt and latch by key outside. Deadbolt by turnpiece inside. Inside knob/lever retracts latch & deadbolt simultaneously, leaving outside locked.			I/S	O/S FD
F05: CLASSROOM Latch by knob/lever either side except when outside knob/lever locked by key. When locked, latch bolt retracted by key. Inside always open. Auxiliary latch deadlocks latch.				J	F21: ENTRANCE Latch by knob/lever either side. Deadbolt by key outside, turnpiece inside. Deadbolt deadlocks latch.				B
F06: HOLDBACK "A" Latch by knob/lever either side except when outside knob/lever locked or unlocked by key. Auxiliary latch deadlocks latch. Inside always open. Inside knob/lever unlocks outside lever. Latch bolt can be locked in retracted position by locking inside hub. Can be used with blank outside trim.				JM	F26: INSTITUTIONAL PRIVACY Latch by knob/lever either side except when outside knob/lever locked by inside thumbturn. Latch deadlocked by auxiliary latch. Key outside opens latch. When outside locked, inside knob/lever retracts latch, automatically unlocking outside knob/lever.	 			GL
F06: HOLDBACK "B" Latch by knob/lever either side except when outside knob/lever locked or unlocked by key. Auxiliary latch deadlocks latch. Inside always open. Inside knob/lever will not unlock outside knob/lever. Latch bolt can be locked in retracted position by locking outside hub. Can not be used with blank outside trim.				JR	OFFICE VESTIBULE: Latch by knob/lever either side except when outside knob/lever locked by stop-button in front; then by key outside.				D
F07: STOREROOM Latch by knob/lever inside, key outside. Outside knob/lever always rigid. Auxiliary latch deadlocks latch. Inside always open.				EW	VESTIBULE: Latch by knob/lever inside, key outside. Outside knob/lever always rigid.				DW
F08, F10: ENTRANCE Latch by knob/lever either side except when outside locked by stop-button; then by key outside, knob/lever inside. Deadbolt by key outside, turnpiece inside. Deadbolt deadlocks latch.				A	DORMITORY: Latch by knob/lever inside. Outside knob/lever always rigid. Deadbolt and latch by key outside. Deadbolt by turnpiece inside. When deadbolt is projected, latch is deadlocked. Inside knob/lever retracts latch and deadbolt simultaneously.				FS
F12: DORMITORY Latch by knob/lever either side except when outside knob/lever locked by stop-button or projected deadbolt. Deadbolt by turnpiece inside. Inside knob/lever retracts latch and deadbolt simultaneously, leaving outside locked. Deadbolt deadlocks latch.				F	SPECIAL PRIVACY: Inside knob/lever always free, outside rigid. Latch by knob/lever inside, key outside. Deadbolt by turnpiece inside, emergency release outside. Inside knob/lever retracts deadbolt and latch simultaneously. Auxiliary latch deadlocks latch.				LH
F13: DORMITORY Latch by knob/lever either side except when projected deadbolt locks outside knob/lever and deadlocks latch. Deadbolt and latch by key outside. Deadbolt by turnpiece inside. Inside knob/lever retracts latch and deadbolt simultaneously, automatically unlocking outside knob/lever.				FW	STOREROOM: Latch by thumbpiece inside. Key outside.				DN
F15: HOTEL Inside knob/lever always free, outside rigid. Latch by knob/lever inside, key outside. (When deadbolt projected by turnpiece all keys are shut out except emergency key). Inside knob/lever retracts deadbolt and latch simultaneously. Auxiliary latch or deadbolt deadlocks latch. Indicator available.				H	STOREROOM: Latch by thumbpiece or knob/lever inside. Key outside. Auxiliary latch deadlocks latch.				EN
ELECTRIFIED FUNCTIONS					ELECTRIFIED FUNCTIONS				
					ELECTRICALLY LOCKED (Fail Safe): Outside always locked electrically. Open by key outside, switch or loss of power. Auxiliary latch deadlocks latch. Inside always open.				EL
					ELECTRICALLY UNLOCKED (Fail Secure): Outside always locked until unlocked by key or electrically energized. Auxiliary latch deadlocks latch. Inside always open.				EU

MORTISE LOCKSET FUNCTIONS

ANSI 156.13 GRADE 1

MORTISE LOCKSET FUNCTIONS

DOUBLE CYLINDER FUNCTIONS				NON-KEYED FUNCTIONS			
ANSI #	Cam	Strike	Marks Function	ANSI #	Strike	Marks Function	
F09: ENTRANCE Latch by knob/lever either side except when outside knob/lever locked by key inside, latch retracted by key outside. Outside remains locked. Auxiliary latch deadlocks latch.	 I/S 		I/S O/S G	F01: PASSAGE Latch by knob/lever either side.		I/S O/S N	
F11: DORMITORY Latch by knob/lever either side except when outside knob/lever locked by stop-button or projected deadbolt. Deadbolt by key either side. Inside knob/lever retracts latch and deadbolt simultaneously leaving outside locked. Deadbolt deadlocks latch.	 I/S 		 FA	F02: BATHROOM* Latch by knob/lever either side. Deadbolt by turnpiece inside. Deadbolt deadlocks latch. To unlock from outside, remove emergency button, insert emergency key in access hole and turn. Optional coinkey assembly available.		 L	
F14: STOREROOM Latch by knob/lever either side. Deadbolt by key either side. Deadbolt deadlocks latch.	 I/S 		 C	F19: PRIVACY* Latch by knob/lever either side except when projected deadbolt locks outside knob/lever and deadlocks latch. Deadbolt by turnpiece inside. Inside knob/lever retracts latch and deadbolt simultaneously, automatically unlocking outside knob/lever. To unlock from outside, remove emergency button, insert emergency key in access hole and turn. Optional coinkey assembly available.		 LF	
F24: APARTMENT HANDLE Latch by thumbpiece either side except when outside is locked by key inside. When outside is locked, latch retracted by key outside or thumbpiece inside. Auxiliary latch deadlocks latch.	 I/S 		 G	F22: PRIVACY Latch by knob/lever either side except when outside knob/lever is locked by inside turnpiece. Turning inside knob/lever or closing door unlocks outside lever. To unlock from outside, remove emergency button, insert emergency key in access hole and turn. Optional coin key assembly available.		 LJ	
F25: STOREROOM "B" Body Latch by thumbpiece either side. Deadbolt by key either side.	 I/S 		 C	F31: EXIT Latch by knob/lever inside, non-removable blank trim or no trim outside. Auxiliary latch deadlocks latch.		 EX	
F25: STOREROOM Latch by thumbpiece either side except when outside thumbpiece locked by stop-button in front; then by key outside. Deadbolt by key both sides. Deadbolt deadlocks latch.	 I/S 		 SO	DEADBOLT FUNCTIONS			
F30: INSTITUTION Both knob/levers rigid. Auxiliary latch deadlocks latch. Latch by key either side.	 I/S 		 WW	F16: DEADLOCK Deadbolt by key either side.	 I/S 	 T	
F32: INTRUDER LATCH BOLT Latch by knob/lever either side except when outside knob/lever is locked from inside or outside by key. Latch operated by key from inside or outside. Auxiliary latch, deadlocks latch. Inside always open.	 I/S 		 GC	F17: DEADLOCK Deadbolt by key outside and turnpiece inside.		 P	
CLASSROOM SECURITY Latch bolt retracted by knob/lever from either side unless outside is locked by key from either side. Auxiliary latch deadlocks latch bolt when door is locked. Inside knob/lever is always free for immediate egress.	 I/S 		 GG	F18: DEADLOCK Deadbolt by key one side only.		 S	
CLASSROOM SECURITY w/HOLDBACK Latch bolt retracted by knob/lever from either side unless outside is locked by key from either side. When locked, latch bolt retracted by key outside or knob/lever inside. Auxiliary latch deadlocks latch bolt when door is locked. Depress inside knob/lever and turn key 360° for holdback feature. Inside knob/lever always free for immediate egress.	 I/S 		 GR	F29: DEADLOCK Deadbolt by key outside. Inside turnpiece will retract but will not project deadbolt.		 SC	
F33: DORMITORY Latch by knob/lever either side except when projected deadbolt locks outside knob/lever and deadlocks latch. Deadbolt and latch by key either side. Inside knob/lever retracts latch and deadbolt simultaneously, automatically unlocking outside knob/lever.	 I/S 		 FX	DEADLOCK FUNCTIONS			
F33: DORMITORY Latch by knob/lever either side except when projected deadbolt locks outside knob/lever and deadlocks latch. Deadbolt and latch by key either side. Inside knob/lever retracts latch and deadbolt simultaneously, automatically unlocking outside knob/lever.	 I/S 		 FC	E06072: CYLINDER BY TURNPIECE Deadbolt by inside turnpiece or outside key.		 K	
F35: STORE DOOR Latch by knob/lever either side except when outside knob/lever locked by stop-button in front; then by key outside. Deadbolt by key either side. Deadbolt deadlocks latch.	 I/S 		 AC	E06082: COMMUNICATING SINGLE CYLINDER* Deadbolt by key from one side only.		 L	
				E06062: DOUBLE CYLINDER Deadbolt by key either side.		 M	
				E06092: CLASSROOM Deadbolt by outside key. Turnpiece will retract but not project deadbolt.		 S	
				TURNPIECE Deadbolt by inside turnpiece.		 X	
				*PRIVACY INDICATOR AVAILABLE			

MORTISE LOCKSET FUNCTIONS

SURVIVOR SERIES

CYLINDRICAL LEVERSETS ANSI 156.2 GRADES 1 & 2

SURVIVOR SERIES

Marks USA Survivor Series locksets are the most durable cylindrical lever locksets. The series is offered in four lever styles, conventional cylinder, IC core for "Best" size cores and Schlage® as well as others. The Survivor Series locksets are backed by Marks lifetime mechanical warranty. All functions are available in six standard finishes, are UL Listed for 3-hour fire rating, and satisfy ADA requirements.

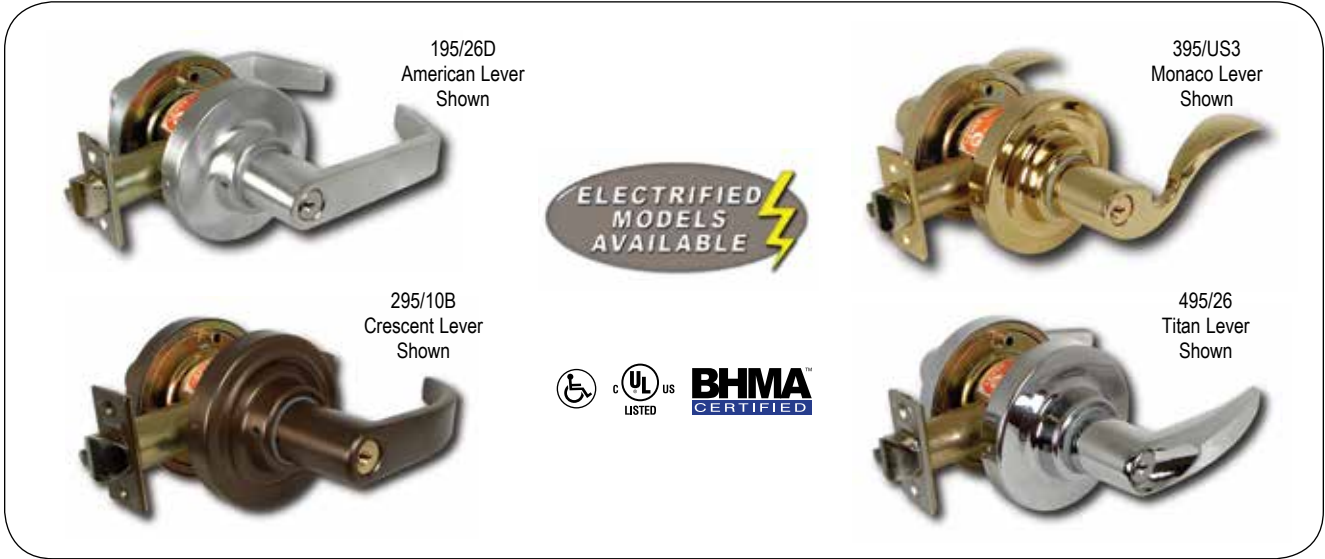

MARKS GRADE 1 #195, 295, 395, 495		MARKS GRADE 2 #175, 275, 375, 475		DESCRIPTION	ANSI #	FINISH GROUPS
COMM. CYL.	IC CORE CYL.* 395 Not Available IC Core	COMM. CYL.	IC CORE CYL.* 375 Not Available IC Core			
N	—	N	—	PASSAGE	F75	3, 4, 10, 10B, 26, 26D
L	—	L	—	PRIVACY	F76	
LK	—	—	—	PRIVACY	F76 MOD.	
P	—	P	—	PATIO	F77	
DC	RDC	DC	RDC	COMMUNICATING	F80	
A	RA	A	RA	ENTRY	F81	
B	RB	B	RB	ENTRY	F82A	
AB	RAB	AB	RAB	ENTRANCE	F109	
AQ	—	AQ	—	EXIT	F83	
S	RS	S	RS	CLASSROOM	F84	
F	RF	F	RF	STOREROOM	F86	
DW	RDW	DW	RDW	INSTITUTION	F87	
DA	RDA	DA	RDA	VESTIBULE	F88	
FQ	—	FQ	—	EXIT	F89	
T	RT	T	RT	CORRIDOR	F90	
TK	RTK	—	—	HOSPITAL/PRIVACY	F90 MOD.	
GB	RGB	—	—	STORE DOOR	F91	
BS	RBS	BS	RBS	SERVICE STATION LOCK	F92	
H	—	H	—	HOTEL	F93	
DB	RDB	—	—	CLASSROOM INTRUDER	F110	
DO	—	DO	—	DUMMY TRIM OUTSIDE	—	
DT	—	DT	—	FULL DUMMY TRIM	—	
NB	—	NB	—	COMMERCIAL PASSAGE	F111	
FB	RFB	FB	RFB	COMMERCIAL STOREROOM	F112	
SB	RSB	SB	RSB	COMMERCIAL CLASSROOM	F113	
FEL	RFEL	—	—	ELECTRICALLY LOCKED	—	
FEU	RFEU	—	—	ELECTRICALLY UNLOCKED	—	

STANDARD FEATURES

- Backset: 2-3/4"; 2-3/8"; 3-3/4" & 5" Optional
- Levers: Solid cast Zamac; w/ 1/2" return (Except 395, 495, 375 & 475)
- Door thickness: 1-5/8" - 1-7/8"; 1-3/8" doors use K1904 spacer.
- Cylinder: MARKS "C" keyway, 6 pin w/ 2 keys
- UL Listed, 3 hour fire rated

95 Series:

- Latch #1834, Front: 1-1/8" x 2-1/4"; Throw: 9/16"; Stainless steel nose
- Roses: Thru-bolted, 3-7/16" dia., spring loaded 2-#10 thru-bolts
- Strike: #1135, 4-7/8" ASA curved lip strike

75 Series:

- Latch #1134, Front: 1-1/8" x 2-1/4"; Throw: 1/2"; Stainless steel nose
- Roses: Thru-bolted, 3-1/4" dia., spring loaded 2-#10 thru-bolts
- Strike: #1136, 2-3/4" "T" strike

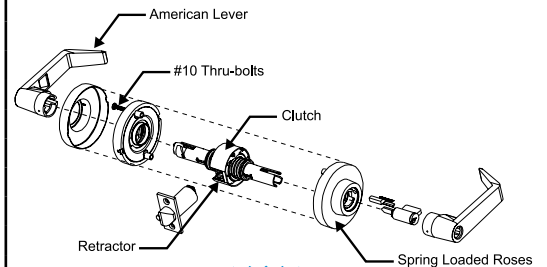

GRADE 1
95 SERIES LEVERSETS TESTED TO
TWICE BHMA CYCLES

* Standard & HI-SECURITY™ IC Core Models: Interchangeable Core models for 6 or 7 pin cores (not included).
 Accepts: Marks, Marks HI-SECURITY™, Medeco®, KeyMark™, Falcon, Schlage® small format & Best®. IC Core Tailpieces ARE Included.

SURVIVOR SERIES CYLINDRICAL LEVERSETS

SURVIVOR SERIES

CYLINDRICAL LEVERSETS ANSI 156.2 GRADES 1 & 2

CLUTCH SYSTEM

When locked, the Survivor's clutch disengages the outside lever allowing it to turn freely without opening the latch. This reduces the torque applied to the outside lever. Other locksets with RIGID levers are prone to failure because of excessive torque.

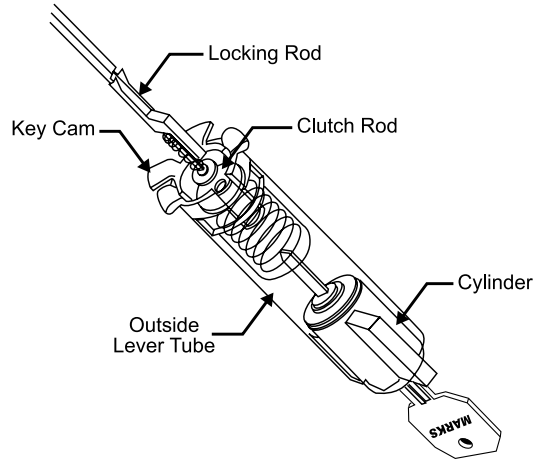

SUPER STRENGTH RETRACTOR

The Survivor's retractor is cast stainless steel with bronze roller bearings for ultra-high strength, smooth operation & long life.

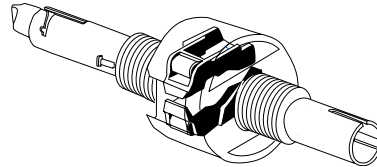

LONG LIFE LEVER SUPPORT SPRINGS

Each Survivor rose contains it's own proprietary high strength lever support spring.

Twice BHMA continuous cycles,
NO LEVER DROOP...EVER!

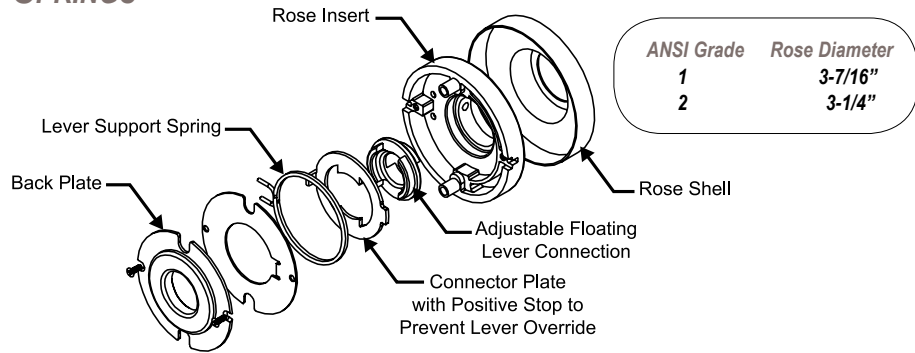

STRENGTH & LIFE

SURVIVOR:

- Withstands torque of 1800 inch-pounds; over twice ANSI/BHMA (1996) test value
- Life tested over twice BHMA cycles; Fully operational after these tests
- Thru-bolting with #10 epoxy coated bolts assures vibration-proof mounting
- Only two thru-bolts for easy installation
- Breakaway handles (*American & Crescent design*) protect against excessive abuse

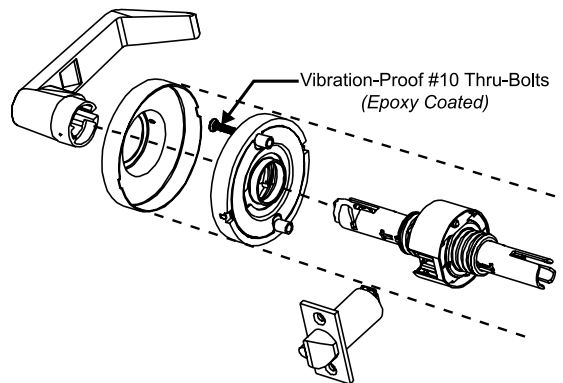

QUICK INSTALLATION

- The Survivor easily adjusts for door thickness
- 1-5/8" - 1-7/8" without the use of spacer plates or special tools
- Adjustment is made by merely rotating outside rose
- Spacer plates are available for 1-3/8" doors with K1904 spacer rings
- Extend to 2-1/4" door thickness with D7 option

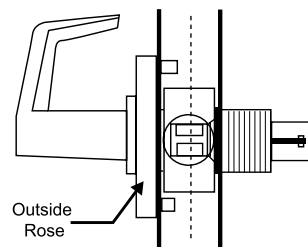

SURVIVOR SERIES

CYLINDRICAL LEVERSETS ANSI 156.2 GRADES 1 & 2

EASY INSTALLATION

Survivor door preparation is simplified with the fast and accurate, easy to use J295 installation tool. One side is for the 2-3/4" backset, the other for the 2-3/8" backset. For use with either wood or metal doors.

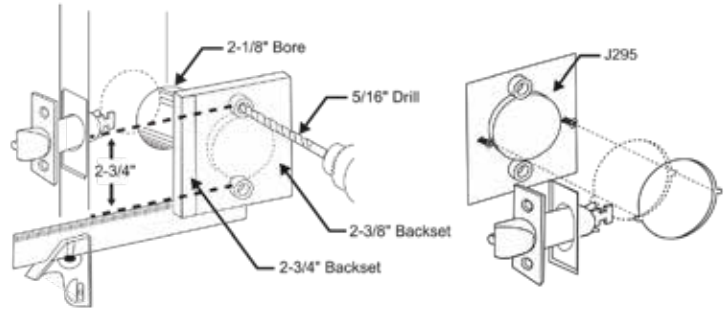

USES MOST AVAILABLE CYLINDERS

Our locksets accept many other OEM standard, HI-SECURITY™ and IC Core cylinders using MARKS adapter tailpieces.

Cylindrical Lock Tailpieces

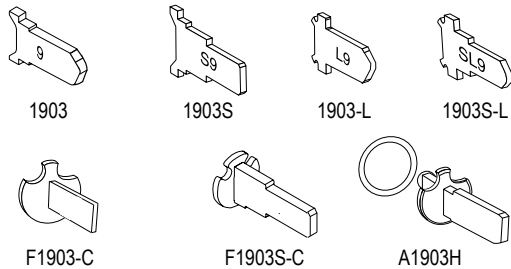

Cylindrical IC Core Tailpieces

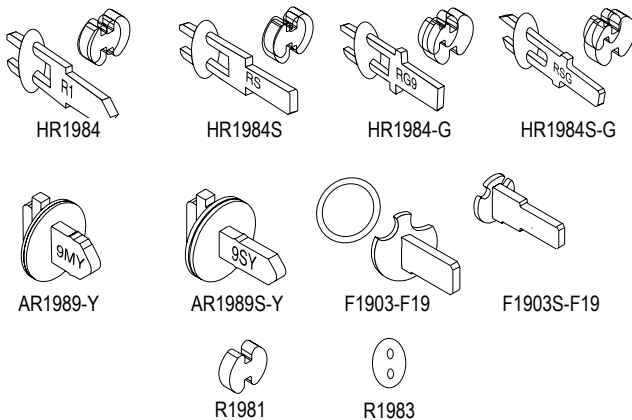

CYLINDRICAL LOCK TAILPIECES		
PART #	FUNCTION	CYLINDER
1903	AB, B, DA (ext.), DW, F, FEL, FEU	MARKS 1982
1903S	S, DA (int.), DB, DC, SB, T	
1903-L	AB, B, DA (ext.), DW, F, FEL, FEU	Arrow PK 100C, Ilco 705, Lori 1539, Sargent 13-3266, Abloy, ASSA 65673, 65691
1903S-L	S, DA (int.), DB, DC, SB, T	
F1903-C	AB, B, DA (ext.), DW, F, FEL, FEU	Schlage 23-001, Primus, Corbin-Russwin 2000-034
F1903S-C	S, DA (int.), DB, DC, SB, T	
A1903H	H	Marks 1982H, Schlage 23-014
IC CORE TAILPIECES		
HR1984	AB, B, DA (ext.), DW, F, FEU, FEL	6 or 7 pin Marks, KSP, Best®, Falcon, Medeco®, Keymark™, Sargent®, Schlage® Small Format
HR1984S	S, DA (int.), DB, DC, SB, T	
HR1984-G	AB, B, DA (ext.), DW, F, FEU, FEL	6 or 7 pin Corbin
HR1984S-G	S, DA (int.), DB, DC, SB, T	
AR1989-Y	AB, B, DA (ext.), DW, F, FEU, FEL	6 or 7 pin Yale
AR1989S-Y	S, DA (int.), DB, DC, SB, T	Medeco®
AR1999-M	AB, B, DA (ext.), DW, F, FEU, FEL	
AR1999S-M	S, DA (int.), DB, DC, SB, T	6 pin Schlage® Large Format
F1903-F19	AB, DW, F	
F1903S-F19	S, DA, DB, DC, SB, T	
R1981	Spacer	
R1983	Security Disc	

CYLINDERS

The Grade 1 Survivor is supplied with 6 pin cylinders in MARKS "C" keyway with 2 nickel-silver keys.

The Grade 2 Survivor is supplied with 5 pin cylinders in MARKS "C" keyway with 2 brass keys.

Grade 1 and Grade 2 are also available in 6 or 7 pin IC Core models for Best®, Corbin-Russwin, Medeco®, "Keymark™", Schlage® & Yale sizes.

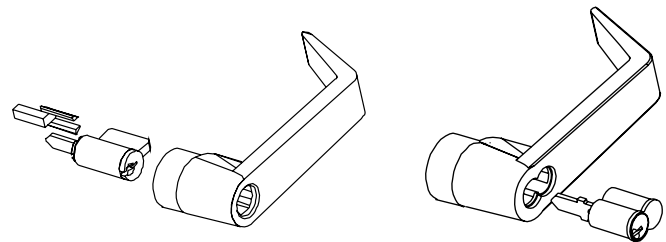

ADA • GRADES 1 & 2 • MEETS BY AMERICA

- American & Crescent style levers returning to within 1/2" of door surface
- Decorative "Monaco" style lever
- Satisfies all Federal ADA and State Disability requirements
- ANSI/BHMA specification 156.2 (1996) Series 4000, Grade 1 & 2
- UL Listed for 3 hour fire rating

SURVIVOR SERIES

REX & ELECTRIFIED LEVERSETS LEVERSETS

ANSI 156.2 GRADES 1 & 2



SURVIVOR WITH REQUEST TO EXIT

Our Grade 1 Electrified Survivor Series locksets featuring "The Clutch" are available for operation as either electrically locked or unlocked. When locked, the Survivor's clutch disengages the outside lever allowing it to turn freely without opening the latch. The Grade 1 Survivor Series Cylindrical Leverset incorporates a *Request to EXIT* switch in both the Electrified (FEL & FEU) and Storeroom functions. Activating the inside lever for egress initiates the built-in REX output, providing a momentary signal for the access control REX input for alarm shunt during egress with all the features of the Survivor Electrified Lockset

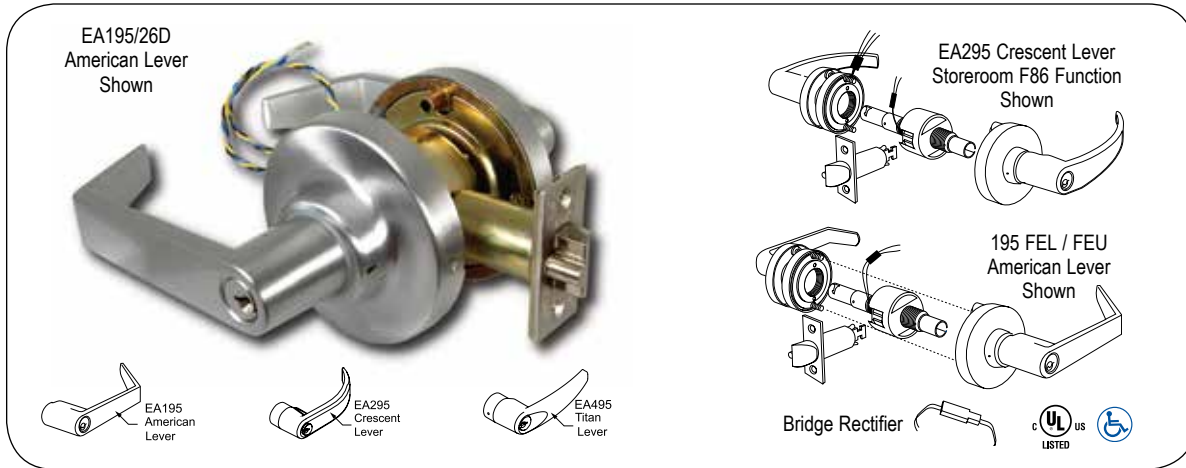

MARKS # EA195, EA295, EA395, EA495 REX LEVERSETS		FUNCTION	ANSI #	DESCRIPTION	FINISH GROUPS
CONVENTIONAL CORE	IC CORE*				
F	RF	STOREROOM	F86	Latch by lever inside. Outside lever always locked.	3, 4, 10, 10B, 26, 26D
FEL	RFEL	ELECTRICALLY LOCKED	—	Outside always locked electrically. Open by key outside, switch or loss of power. Latch by lever inside.	
FEU	RFEU	ELECTRICALLY UNLOCKED	—	Outside always locked until unlocked by key or electrically energized. Latch by lever inside.	

MARKS # 195, 295, 395, 495 ELECTRIFIED LEVERSETS		FUNCTION	DESCRIPTION	FINISH GROUPS
CONVENTIONAL CORE	IC CORE*			
FEL	RFEL	ELECTRICALLY LOCKED	Outside always locked electrically. Open by key outside, switch or loss of power. Deadlocking latch by lever inside. Lever only.	3, 4, 10, 10B, 26, 26D
FEU	RFEU	ELECTRICALLY UNLOCKED	Outside always locked until unlocked by key or electrically energized. Deadlocking latch by lever inside. Lever only.	

STANDARD FEATURES

- Backset: 2-3/4"; 2-3/8", 3-3/4" & 5" Optional
- Latch #1834, Front: 1-1/8" x 2-1/4"; Throw: 9/16"; Stainless steel nose
- Levers: Solid cast Zamac w/ 1/2" return
- Rose: Thru-bolted, 3-7/16" dia., spring loaded 2-#10 thru-bolts
- Strike: #1135, 4-7/8" ASA curved lip
- Door thickness: 1-5/8" to 1-7/8" (For 1-3/8" door use K1704 spacer.)
- Cylinder: MARKS "C" keyway, 6 pin w/ 2 keys or IC Core housing
- Electrified functions - 100% duty cycle, 24V/AC supplied with bridge rectifier; 24V/DC, .21 Amps
- 12V/DC Optional, Contact factory for additional options
- Request to Exit Switch: Single pole, double throw, 3 amp, 125 AC, wired either normally open or normally closed (**REX Switch is not standard on electrified leverset**)
- Features "The Clutch" for trouble free service
- UL Listed, 3 hour fire rated

*Standard & HI-SECURITY™ IC Core Models:
Interchangeable Core models for 6 or 7 pin cores (not included).
Accepts: Marks, Marks HI-SECURITY™, Medeco®, KeyMark™, Falcon,
Schlage® small format & Best®. IC Core Tailpieces ARE Included.

SURVIVOR SERIES CYLINDRICAL LEVERSETS

175 ECONOMY SERIES

CYLINDRICAL LEVERSETS ANSI 156.2 GRADE 2

175 ECONOMY SERIES

Marks USA New 175 Grade 2 Economy Series gives you the performance and quality of a Grade 1 lockset at a Grade 2 price. Perfect for commercial applications in Office Buildings, Schools, Universities, Hospitals and much more. This series is offered in conventional cylinder, IC core for "Best" size cores, Medeco®, Corbin and Schlage® as well as others. All functions are available in two standard finishes, are UL Listed for 3-hour fire rating, satisfy ADA requirements and are backed by Marks lifetime mechanical warranty.



175 SERIES CYLINDRICAL LEVERSETS

MARKS # 175		FUNCTION	ANSI #	FINISH GROUPS
COMM. CYL.	IC CORE CYL.*			
N	—	PASSAGE	F75	26D, 10B
L	—	PRIVACY	F76	
P	—	PATIO	F77	
DC	RDC	COMMUNICATING	F80	
AB	RAB	ENTRY	F109	
AQ	—	EXIT	F83	
S	RS	CLASSROOM	F84	
F	RF	STOREROOM	F86	
DW	RDW	INSTITUTION	F87	
DA	RDA	VESTIBULE	F88	
FQ	—	EXIT	F89	
T	RT	CORRIDOR	F90	
BS	RBS	SERVICE STATION LOCK	F92	
DO	—	DUMMY TRIM OUTSIDE	—	
DT	—	FULL DUMMY TRIM	—	
NB	—	COMMUNICATING PASSAGE	F111	
FB	RFB	COMMUNICATING STOREROOM	F112	
SB	RSB	COMMUNICATING CLASSROOM	F113	

LEVERS ARE PACKED 6 PER CASE
 • IC Core Models: Tailpieces included, core not included

STANDARD FEATURES

- Backset: 2-3/4"
- Latch #1134, Front: 1-1/8" x 2-1/4"
- Levers: Solid cast Zamac; w/ 1/2" return
- Roses: Thru-bolted, spring loaded 2-#10 thru-bolts (Inside rose cover included)
- Strike: #1145/32D
- Door thickness: 1-5/8" to 1-7/8"
- Cylinder: MARKS "C" keyway, 6 pin w/ 2 keys

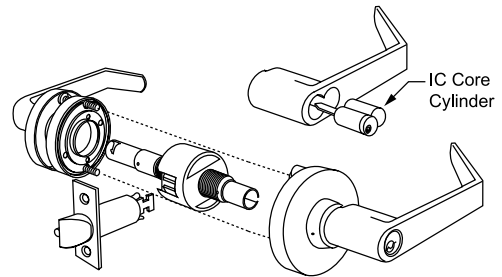

*** Standard & HI-SECURITY™ IC Core Models:**
 Interchangeable Core models for 6 or 7 pin cores (not included).
Accepts: Marks, Marks HI-SECURITY™, Medeco®, KeyMark™, Falcon, Schlage® small format & Best®. **IC Core Tailpieces ARE Included.**















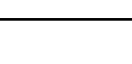
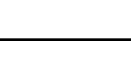



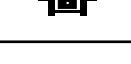



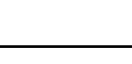
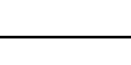

CYLINDRICAL KNOB/LEVER FUNCTIONS

ANSI 156.2 GRADES 1 & 2

CYLINDRICAL LEVER FUNCTIONS

CYLINDRICAL KNOB/LEVER FUNCTIONS

ANSI # CODE	Marks Function		ANSI # CODE	Marks Function	
	I/S	O/S		I/S	O/S
F75 PASSAGE: Latch by knob/lever either side.		N	F90 (MOD.) HOSPITAL/PRIVACY: Deadlocking latch by knob/lever either side unless outside locked by knob/lever or inside push-button. Unlock by turn-knob, turning inside knob/lever or closing door.		TK
F76 PRIVACY: Latch by knob/lever either side unless outside knob/lever locked by push-button from inside. Outside unlocks by turning inside knob/lever, outside emergency turn or closing door.		L	F91 STORE DOOR (95 Series Leverset ONLY): Deadlocking latch by knob/lever either side except when both knob/levers are locked by key from either side.		GB
F76 (MOD.) HOSPITAL/PRIVACY: Latch by knob/lever either side unless outside knob/lever locked by push-button from inside. Outside unlocks by turning inside knob/lever, outside emergency turn-knob or closing door.		LK	F92 SERVICE STATION LOCK: Deadlocking latch by knob/lever either side unless outside locked by key or inside push-button. Unlock by key, turning inside knob/lever or closing door, except when slotted push-button is turned in locked position. Inside knob/lever always opens latch.		BS
F77 PATIO: Deadlocking latch by knob/lever either side unless outside knob/lever locked by push-button inside. Unlocks by turning inside knob/lever or closing door.		P	F93 HOTEL: Deadlocking latch by knob/lever inside. Outside knob/lever always locked. Inside push-button projects indicator on cylinder face shutting out all keys except emergency key. Turning inside knob/lever or closing door releases push-button.		H
F80 COMMUNICATING: Key both sides. Locks or unlocks either knob/lever independent of the other. Deadlocking latch.		DC	F109 ENTRY: Outside locked by pushing turn-button inside. Key outside opens lock. Rotating inside knob/lever releases button and outside knob/lever. By pushing and turning inside button, outside knob/lever remains locked. Deadlocking latch.		AB
F81 ENTRY: Deadlocking latch bolt by knob/lever either side except when outside locked by turn-button inside. When outside locked, key outside or knob/lever inside opens lock. Turn-button operated manually.		A	F110 CLASSROOM INTRUDER: Deadlocking latch by knob/lever either side, except when outside locked by key inside. Key outside locks or unlocks outside. Inside always open		DB
F82A ENTRY: Deadlocking latch by knob/lever either side. Outside locked by push-button inside. When outside locked by push-button inside, key opens lock, unlocks push-button. Inside knob/lever always opens latch. Closing door does not release push-button.		B	DUMMY TRIM: Outside only, rigid.		DO
F83 EXIT: Deadlocking latch by knob/lever either side except when outside locked by turn-button inside. Inside knob/lever always opens latch. Turn-button operated manually.		AQ	DUMMY TRIM: Both sides, rigid.		DT
F84 CLASSROOM: Deadlocking latch by knob/lever inside. Outside knob/lever locked or unlocked by key.		S	F111 COMMUNICATING PASSAGE: Blank outside. Deadlocking latch by knob/lever inside.		NB
F86 STOREROOM: Deadlocking latch by knob/lever inside, key outside. Outside knob/lever always locked.		F	F112 COMMUNICATING STOREROOM: Blank outside. Deadlocking latch by key only. Knob/lever always locked.		FB
F87 INSTITUTION: Both knob/levers always locked. Deadlocking latch by key both sides.		DW	F113 COMMUNICATING CLASSROOM: Blank outside. Inside knob/lever locked or unlocked by key. Deadlocking latch.		SB
F88 VESTIBULE: Deadlocking latch by knob/lever either side, except when outside knob/lever locked by key inside. Key outside retracts deadlocking latch. Inside always open.		DA	ELECTRICALLY LOCKED - FEL: <i>(Fail Safe)</i> Outside always locked electrically. Open by key outside, switch or loss of power. Deadlocking latch by lever inside. Lever only.		FEL
F89 EXIT: Deadlocking latch by knob/lever inside. Outside always locked.		FQ	ELECTRICALLY UNLOCKED - FEU: <i>(Fail Secure)</i> Outside always locked until unlocked by key or electrically energized. Deadlocking latch by lever inside. Lever only.		FEU
F90 CORRIDOR: Deadlocking latch by knob/lever either side unless outside locked by key or inside push-button. Unlock by key, turning inside knob/lever or closing door.		T			

DEFENDER SERIES

TUBULAR DEADBOLTS & CYLINDRICAL CARTRIDGE DEADLATCHES

DEFENDER SERIES DEADBOLTS & DEADLATCHES

In addition to our tubular style deadbolts, Marks USA has now developed a cylindrical cartridge deadlatch (145 Series). The result is an easy to install deadlocking latch with a stainless steel nose and 9/16" throw. The Defender series are available in both conventional as well as IC core cylinder models.



130M/32D Tubular Deadbolt Shown

MARKS # 130		DESCRIPTION	ANSI #	FINISH GROUPS
COMMERCIAL CYLINDER	IC CORE CYLINDER*			
K	RK	CYLINDER x TURNPIECE	E0151	3, 10, 10B, 26D, 32, 32D
L	RL	COMMUNICATING SINGLE CYL	E0161	
M	RM	DOUBLE CYLINDER	E0141	
S	RS	CLASSROOM	E0171	
X	—	TURNPIECE x BLANK PLATE	E0191	

STANDARD FEATURES

- Bolt: 1" throw
- Unitized assemblies for 2-1/8" bore
- Strike: #1335, 2-3/4" x 1-1/8" strike
- Door thickness: 1-5/8" to 1-7/8"
- Cylinder: MARKS "C" keyway, 6 pin w/ 2 keys
- 2-3/8" Backset
- Latch: 1" x 2-1/4" front

*** Standard & HI-SECURITY™ IC Core Models:**
Interchangeable Core models for 6 or 7 pin cores (not included).
Accepts: Marks, Medeco KeyMark™, Falcon & Best®.
IC Core Tailpieces ARE Included.



145K/32D Cylindrical Cartridge Deadlatch Shown

MARKS # 145		DESCRIPTION	ANSI #	FINISH GROUPS
COMMERCIAL CYLINDER	IC CORE CYLINDER*			
K	RK	CYLINDER x TURNPIECE	E0121	3, 10, 10B, 26D, 32, 32D
L	RL	COMMUNICATING SINGLE CYL	E0131	
M	RM	DOUBLE CYLINDER	E0111	
X	—	TURNPIECE x BLANK PLATE	—	
KL	RKL	CYLINDER BY LEVER	—	

STANDARD FEATURES

- Series 1 cylindrical cartridge
- Latch: Grade 1, 9/16" throw
- 2-3/4" Backset
- Unitized assemblies for 2-1/8" bore
- Strike: #1136, 2-3/4" strike
- Door thickness: 1-3/8" to 2-3/8"
- Cylinder: MARKS "C" keyway, 6 pin w/ 2 keys
- Latch: 1-1/8" x 2-1/4" front
- UL Listed, 3 hour fire rated

*** Standard & HI-SECURITY™ IC Core Models:**
Interchangeable Core models for 6 or 7 pin cores (not included).
Accepts: Marks, Medeco KeyMark™, Falcon & Best®.
IC Core Tailpieces ARE Included.

DEFENDER SERIES

TUBULAR DEADBOLTS & CYLINDRICAL CARTRIDGE DEADLATCHES

DEFENDER SERIES UNIQUE FEATURES

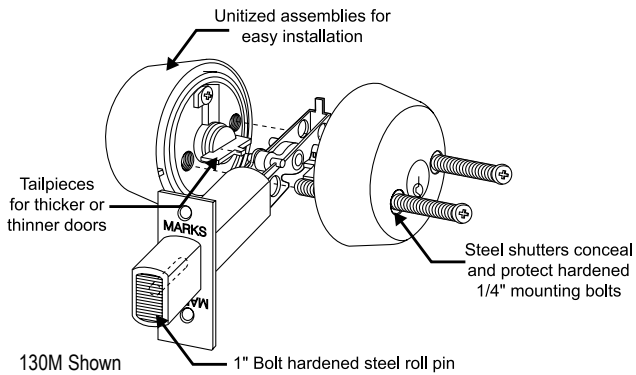

PROTECTIVE STEEL SHUTTERS

The Defender's steel shutters on the interior assembly conceal and protect the two hardened 1/4" mounting bolts which thru-bolt through the latch assembly.

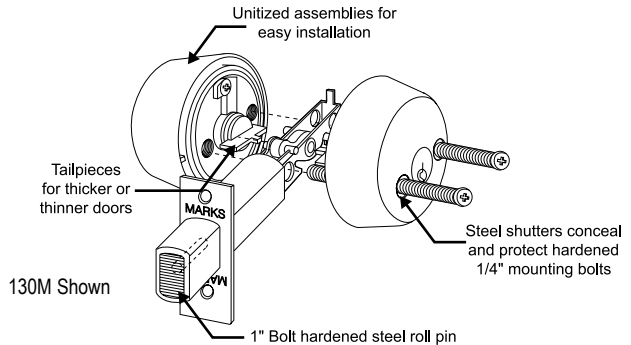

SIMPLE FAST ASSEMBLY

- Defender is designed for quick easy installation
- One piece assemblies
- Unitized exterior and interior trim assemblies have no loose components
- Tailpiece orientation and latch positioning, **required on other deadbolts**, is unnecessary
- Trim and latch are fully reversible and can be assembled randomly

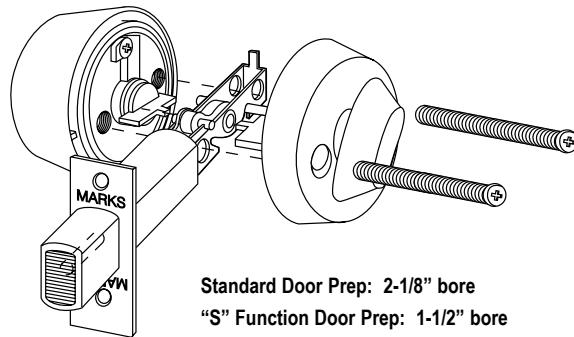

ONE CYLINDER FITS ALL

The Defender utilizes standard key-in-knob cylinders; same as MARKS cylindrical locksets. This important feature eliminates extra inventory of special cylinders making the key-in-knob cylinder inventory more versatile.

- Provides access to largest variety of keyways
- Models also available for 6 or 7 pin IC cores (Best™ size)



EASY RETROFIT DEADBOLT

- Fits standard 2-1/8" diameter door prep
- The Defender offers a choice of tailpieces for MARKS & other OEM cylinders
- Fits 1-1/4" to 2-1/4" thick doors (Normally supplied for 1-3/4" door)
- Marks USA adapter tailpieces available for OEM conventional & IC Core cylinders

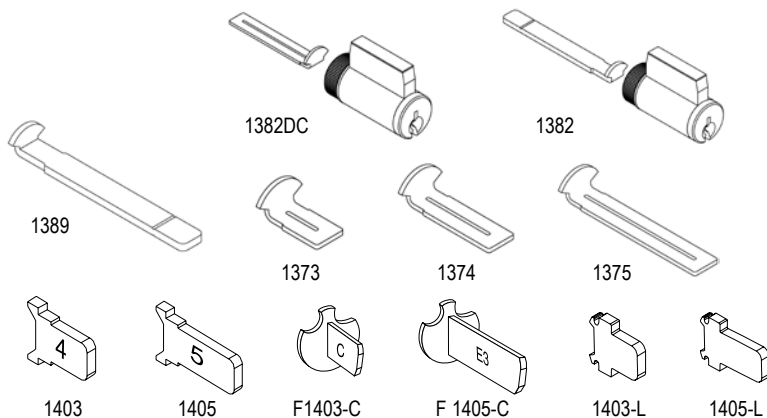

PART #	TAILPIECES FOR 130 DEADBOLTS	
DOUBLE CYLINDER		
1373	1-5/16" to 1-3/8"	MARKS 1382DC
1374	1-5/8" to 2"	
1375	2-1/8" to 2-3/8"	
SINGLE CYLINDER		
1389	1-3/4" to 2-1/4"	MARKS 1382
TAILPIECES FOR 145 DEADLATCHES		
1403	1-5/8" to 1-7/8"	MARKS TAILPIECE
1405	2" to 2-1/4"	
F1403-C	1-5/8" to 1-7/8"	SCHLAGE® TAILPIECE
F1405-C	2" to 2-1/4"	
1403-L	1-5/8" to 1-7/8"	LORI / ILCO TAILPIECES
1405-L	2" to 2-1/4"	

DEFENDER SERIES DEADBOLTS & DEADLATCHES

CUSTOM LOCKSET DIVISION

WE MAKE LOCKSETS TO SUIT YOUR NEEDS

About Marks USA

MARKS USA was established in 1977 to serve a growing demand for a mortise lock manufacturing company who would satisfy the needs of an expanding market. Since then, the product line has grown to include residential and commercial locksets to meet and exceed the most stringent UL and BHMA/ANSI specifications. In 1989, the *Custom Lockset Division* was created to accommodate customers with special requirements of either lock function or design. Custom locksets have been developed for municipal and commercial applications as shown. These are various custom locksets developed to accommodate our customers needs. This is only a sampling of our solutions. We at the *Custom Lockset Division* welcome the opportunity to respond to special applications requiring a custom engineered lock product. We look forward to the challenge.

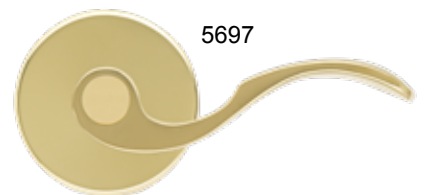
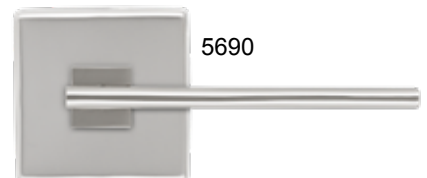

CUSTOM LOCKSET DIVISION

SS55 SERIES - KNOBS

INSTITUTIONAL LIFE SAFETY MORTISE LOCKSETS

LifeSaver™ SERIES INSTITUTIONAL LIFE SAFETY LOCKSETS

Marks USA Custom Lock Division has developed ANSI Grade 1 Institutional Life Safety Locksets to address Managed Liability, Accident Prevention, Life Safety and Security in Behavioral Health Care Institutions. The shape and construction of the SS55 & SS19 Series locksets are designed to restrict the attachment of lines, laces, etc. to door knobs and levers. In addition, with the knobs/levers recessed into the rosettes, the chance of capturing a line between the knob/lever and rosette is substantially eliminated.

MARKS # 5 & 55 SS55		FUNCTION	ANSI #	FINISH GROUPS
COMM. CYL.	IC CORE CYL.*			
KEYED SINGLE CYLINDER, NO DEADBOLT				
D	RD	OFFICE VEST.		
DW	RDW	VESTIBULE		
E	RE	OFFICE	F04	
EW	REW	STOREROOM	F07	
J	RJ	CLASSROOM	F05	
JM, JR	RJM, RJR	HOSPITAL	F06	
GL	RGL	INSTITUTIONAL PRIVACY	F26	
EL	REL	ELECTRICALLY LOCKED		
EU	REU	ELECTRICALLY UNLOCKED		
KEYED SINGLE CYLINDER, WITH DEADBOLT				
A	RA	ENTRANCE	F08, F10	
B	RB	ENTRANCE	F21	
F	RF	DORMITORY	F12	
FS	RFS	DORMITORY		
FW	RFW	DORMITORY	F13	
FD	RFD	APARTMENT	F20	
H	RH	HOTEL	F15	
LH	RLH	SPECIAL PRIVACY		
KEYED DOUBLE CYLINDER, NO DEADBOLT				
G	RG	APARTMENT	F09	
GC	RGC	INTRUDER LATCHBOLT	F32	
GG	RGG	CLASSROOM SECURITY		
GR	RGR	CLASSROOM SECURITY w/HOLDBACK		
WW	RWW	INSTITUTIONAL	F30	
KEYED DOUBLE CYLINDER, WITH DEADBOLT				
AC	RAC	ENTRANCE	F35	
C	RC	STOREROOM	F14	
FC	RFC	INTRUDER DEADBOLT	F34	
FA	RFA	DORMITORY	F11	
FX	RFX	DORMITORY	F33	
KEYLESS				
N	—	PASSAGE	F01	
L	—	BATHROOM	F02	
LF	—	PRIVACY	F19	
LJ	—	PRIVACY	F22	
EX	—	EXIT	F31	
DUMMY TRIM				
DI	—	DUMMY TRIM INSIDE		
DO	—	DUMMY TRIM OUTSIDE		
DT	—	FULLY DUMMY		

32D

* Standard & HI-SECURITY™ IC Core Models: Interchangeable Core models for 6 or 7 pin cores (not included). **Accepts:** Marks, Marks HI-SECURITY™, Medeco®, KeyMark™, Falcon, Schlage® small format & Best®. **IC Core Tailpieces ARE Included.**



Antimicrobial Finish Available
Option Code: AM



STANDARD FEATURES

PERFORMANCE SPECIFICATIONS

Life Test: 1,500,000 cycles minimum.

ANSI Test: Meets or exceeds all operational and security tests of ANSI specifications A156.13-2005 for series 5000, Grade 1.

Fire Test: UL Listed, 3 hour fire rated.

TRIM SPECIFICATIONS

Exterior & Interior Trim:

- Solid stainless steel interior and exterior tapered knobs recessed into thru-bolted roses
- Specially designed finger indented safety knobs with recessed grip and ergonomically designed integral grooved turn knob for elderly and handicapped access (Patent #D587556)
- Needle bearings ensure smoothness of operation

Cylinder: Solid brass cylinders with solid brushed chrome security collars. Optional HI-SECURITY™ available.

Strike: 4-7/8" curved lip stainless steel w/tamperproof screws.

Door Thickness: 1-3/4" standard. Extended range available.

Door Prep: ANSI A115.1 lock face cutout, with 2-1/8" through hole for knob/rose assembly.

Backset: 5 Series: 2-3/4" standard, 55 Series: 2-1/2" optional

Lock Front: Adjustable bevel steel backplate 1-1/4" x 8" x 7/64" thick. Cover plate 1/16" thick with tamper proof screws.

Latch: Solid stainless steel with antifriction latch lever, 3/4" throw (reversible).

Aux. Deadlatch: 1/2" throw, (reversible).

Case: Stamped steel 3/32" thick, zinc dichromate finish.

Hubs: Steel, 9/32" on diamond, 5/16" on square with security separator.

Hub Lock Arm: (to lock hub) Steel 1/8" thick.

Spindles: Independent spring-loaded spindles.

INSTITUTIONAL LIFE SAFETY LOCKSETS

SS19 SERIES - LEVERS

INSTITUTIONAL LIFE SAFETY MORTISE LOCKSETS

Standard Features

Performance Specifications

Life Test: 1,500,000 cycles minimum.

Trim Specifications

Exterior & Interior Trim:

- Solid stainless steel interior and exterior tapered levers recessed into thru-bolted roses
- Specially ergonomically designed integral grooved turn knob for elderly and handicapped access (*Patent D#587556*) on some functions.
- Needle bearings ensure smoothness of operation
- Clutch

Cylinder: Solid stainless steel cylinders with solid stainless steel security collars; Optional HI-SECURITY™ cylinders available

Strike: 4-7/8" curved lip stainless steel w/tamperproof screws

Door Thickness: 1-3/4" standard; Extended range available

Door Prep: ANSI A115.1 lock face cutout, with 2-1/8" through hole for knob/rose assembly

Backset: 5 Series: 2-3/4" standard, 55 Series: 2-1/2" optional

Lock Front: Adjustable bevel steel backplate 1-1/4" x 8" x 7/64" thick, Cover plate 1/16" thick with tamper proof screws

Latch: Solid stainless steel with antifriction latch lever, 3/4" throw (reversible)

Aux. Deadlatch: 1/2" throw, (reversible)

Case: Stamped steel 3/32" thick, zinc dichromate finish

Hubs: Steel, 9/32" on diamond, 5/16" on square w/security separator

Hub Lock Arm: (to lock hub) Steel 1/8" thick

Spindles: Independent spring-loaded spindles



5SS19F/32D
Shown

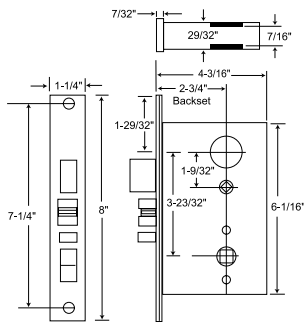
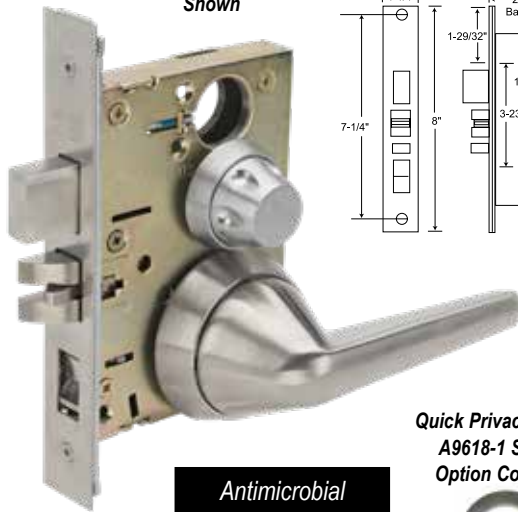

Quick Privacy Access
A9618-1 Shown;
Option Code A25



*Antimicrobial
Finish Available
Option Code: AM*

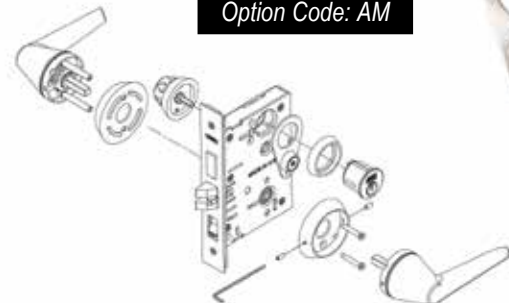

**CODE:
G1 & G3
For IC Core
Option**

MARKS #		FUNCTION	ANSI #	SERIES SS19 5 & 55	
COMM. CYL.				FINISH GROUPS	
KEYED SINGLE CYLINDER, NO DEADBOLT					
D		OFFICE VEST.			
DW		VESTIBULE			
E		OFFICE	F04		
EW		STOREROOM	F07		
J		CLASSROOM	F05		
JM, JR		HOSPITAL	F06		
GL		INSTITUTIONAL PRIVACY	F26		
EL		ELECTRICALLY LOCKED			
EU		ELECTRICALLY UNLOCKED			
KEYED SINGLE CYLINDER, WITH DEADBOLT					
A		ENTRANCE	F08, F10		
B		ENTRANCE	F21		
F		DORMITORY	F12		
FS		DORMITORY			
FW		DORMITORY	F13		
FD		APARTMENT	F20		
H		HOTEL	F15		
LH		SPECIAL PRIVACY			
KEYED DOUBLE CYLINDER, NO DEADBOLT					
G		APARTMENT	F09	32D	
GC		INTRUDER LATCHBOLT	F32		
GG		CLASSROOM SECURITY			
GR		CLASSRM. SEC. w/HOLDBACK			
WW		INSTITUTIONAL	F30		
KEYED DOUBLE CYLINDER, WITH DEADBOLT					
AC		ENTRANCE	F35		
C		STOREROOM	F14		
FC		INTRUDER DEADBOLT	F34		
FA		DORMITORY	F11		
FX		DORMITORY	F33		
KEYLESS					
N		PASSAGE	F01		
L		BATHROOM	F02		
LF		PRIVACY	F19		
LJ		PRIVACY	F22		
EX		EXIT	F31		
DUMMY TRIM					
DI		DUMMY TRIM INSIDE			
DO		DUMMY TRIM OUTSIDE			
DT		FULLY DUMMY			

*** Standard & HI-SECURITY™ IC Core Models:**

Interchangeable Core models for 6 or 7 pin cores (not included). **Accepts:** Marks, Marks HI-SECURITY™, Medeco®, KeyMark™, Falcon, Schlage® small format & Best®

IC Core Tailpieces ARE INCLUDED. WHEN ORDERING IC CORE CYLINDER, ADD THE PREFIX "R" TO THE PART NUMBER ie: 5SS55RA/32D

Function "LJ" F22:

ANSI F22 Latch by lever either side except when outside lever is locked by inside turnpiece. Turning inside lever or closing door unlocks outside lever. To unlock from outside, remove emergency button, insert emergency key in access hole and turn. Optional coin key assembly available.

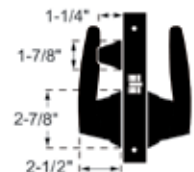

LIFETIME MECHANICAL WARRANTY • FINISHES ARE EXCLUDED FROM THIS WARRANTY



195SS SERIES - LEVERS

INSTITUTIONAL LIFE SAFETY CYLINDRICAL LOCKSETS¹

MARKS #		DESCRIPTION	ANSI #	FINISH GROUPS
COMM. CYL.	IC CORE CYL.*			
N	—	PASSAGE	F75	32D
L	—	PRIVACY	F76	
LK	—	PRIVACY	F76 MOD.	
P	—	PATIO	F77	
DC	RDC	COMMUNICATING	F80	
A	RA	ENTRY	F81	
B	RB	ENTRY	F82A	
AB	RAB	ENTRANCE	F109	
AQ	—	EXIT	F83	
S	RS	CLASSROOM	F84	
F	RF	STOREROOM	F86	
DW	RDW	INSTITUTION	F87	
DA	RDA	VESTIBULE	F88	
FQ	—	EXIT	F89	
T	RT	CORRIDOR	F90	
TK	RTK	HOSPITAL/PRIV.	F90 MOD.	
GB	RGB	STORE DOOR	F91	
BS	RBS	SVC. STATION LOCK	F92	
H	—	HOTEL	F93	
DO	—	DUMMY TRIM OUTSIDE	—	
DT	—	FULL DUMMY TRIM	—	
NB	—	COMM. PASSAGE	F111	
FB	RFB	COMM. STOREROOM	F112	
SB	RSB	COMM. CLASSROOM	F113	

PACKED 6 PER CASE

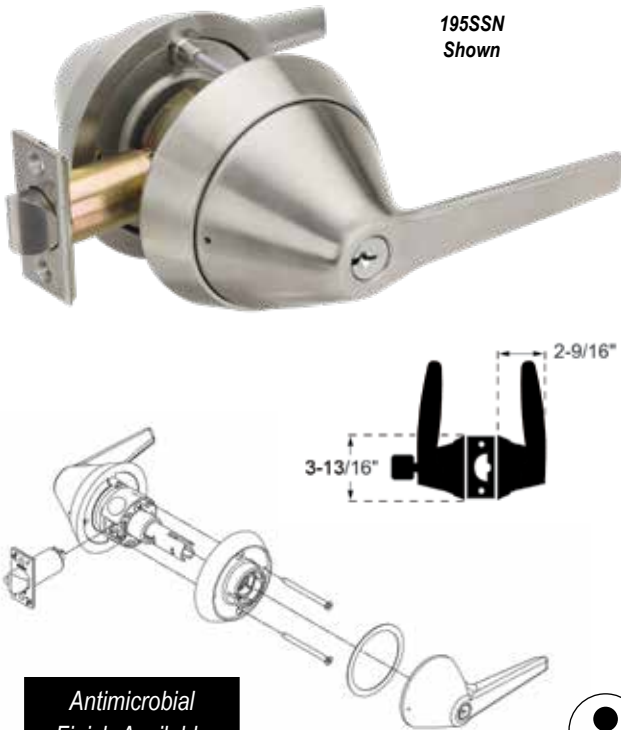
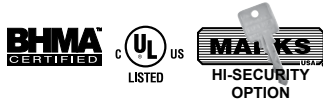

195SSN
Shown

Antimicrobial
Finish Available
Option Code: AM



Standard Features

- ANSI-A156.2 Grade 1, UL listed 3 Hr. Fire Rating
- Backset: 2-3/4" Standard, 2-3/8", 3-3/4", 5" Available
- Latch #1834, stainless steel nose
- Levers: Solid cast stainless steel
- Roses: Thru-bolted, spring loaded, #10 thru-bolts
- Strike: #1135, 4-7/8" ASA curved lip strike
- Door thickness: 1-5/8" to 1-7/8"
- Cylinder: MARKS "C" keyway, 6 pin w/ 2 keys
- Stainless steel retractor
- Clutch

OPTIONS	CODE	OPTIONS	CODE
For 2" doors	D1	Sargent conventional cylinder	F8
For 2-1/4" doors	D2	Corbin conventional cylinder	F9
Over 2-1/4" - 4" thickness	D9	Corbin 6 pin IC core	F12
2-3/8" backset, 1" x 2-1/4" face	E6	Yale 6 pin IC core	F14
2-3/4" backset, 3/4" throw, Gr. 1	E8	Sargent IC core	F20
5" backset, 9/16" throw, Gr. 1	E9		
3-3/4" backset, 9/16" throw, Gr. 1	E10		
Less cylinder	G3		
2-3/4" "T" strike	S3		

* Standard & HI-SECURITY™ IC Core Models:

Interchangeable Core models for 6 or 7 pin cores (not included). **Accepts:** Marks, Marks HI-SECURITY™, Medeco®, KeyMark™, Falcon, Schlage® small format & Best®
IC Core Tailpieces ARE Included. WHEN ORDERING IC CORE CYLINDER, ADD THE PREFIX "R" TO THE PART NUMBER ie: 5SS55RA/32D

INSTITUTIONAL LIFE SAFETY LOCKSETS



LIFETIME MECHANICAL WARRANTY • FINISHES ARE EXCLUDED FROM THIS WARRANTY

SS55 SERIES

INSTITUTIONAL LIFE SAFETY CYLINDRICAL LOCKSETS ANSI 156.2 GRADE 1 & MORTISE DEADLOCKS ANSI 156.5 GRADE 1

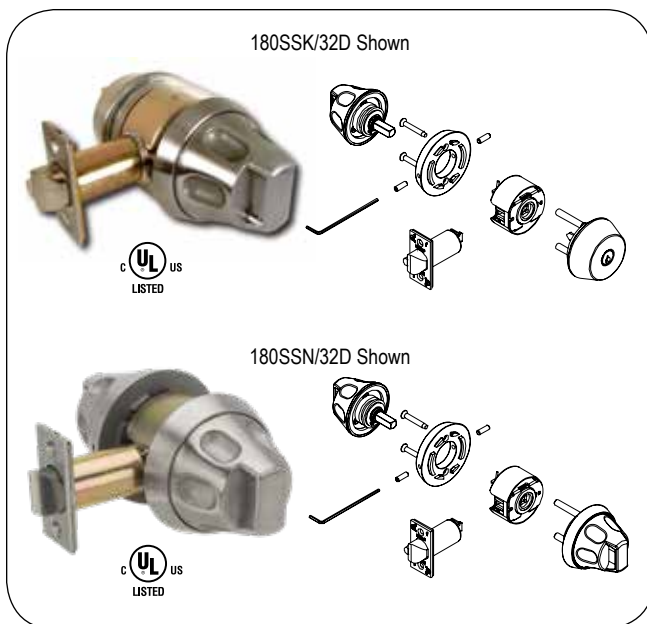

STANDARD FEATURES

PERFORMANCE SPECIFICATIONS

- Life Test:** 1,500,000 cycles minimum.
- ANSI Test:** Meets or exceeds all operational and security tests of ANSI specifications A156.2-2003 for series 1000, Grade 1.
- Fire Test:** UL Listed, 3 hour fire rated.

TRIM SPECIFICATIONS

Exterior & Interior Trim:

- Solid stainless steel interior and exterior tapered knobs recessed into thru-bolted roses
- Specially designed finger indented safety knobs with recessed grip and ergonomically designed integral grooved turn knob for elderly and handicapped access (Patent #D587556).
- Needle bearings ensure smoothness of operation

1SS55K Cylindrical Deadlatch Lockset: ANSI E0121 Cylinder x Knob

Latch by knob inside, key outside.

- Strike:** #1136, 2-3/4" "T" strike; #1135 4-7/8" ASA strike optional
- Door Prep:** ANSI 115.2
- Latch:** ANSI 156.2, Grade 1, 3 Hour fire rated
- Door Thickness:** 1-3/4"
- Backset:** 2-3/4" Backset; 3-3/4" and 5" backsets also available
- Latch Face:** 1-1/8" x 2-1/4" with tamper proof screws
- Cylinder:** Solid brass cylinder, 6-pin, "C" keyway; Optional HI-SECURITY™ cylinders available

1SS55N Cylindrical Lockset: ANSI F75 Passage

Latch by knob either side, always open.

- Strike:** #1136, 2-3/4" "T" strike
- Door Prep:** ANSI 115.2
- Latch:** ANSI 156.2, Grade 1, 3 Hour fire rated
- Backset:** 2-3/4" backset standard, 2-3/8" backset optional; 3-3/4" and 5" backsets also available
- Latch Face:** 1-1/8" x 2-1/4" with tamper proof screws
- Latch Throw:** 9/16"

MARKS # 1 SS55		FUNCTION	ANSI #	FINISH GROUPS
COMM. CYLINDER	IC CORE CYLINDER*			
KEYED SINGLE CYLINDER, WITH DEADBOLT				
K	RK	CYLINDER x KNOB	E0121	32D
KEYLESS				
N	—	PASSAGE	F75	

* Standard & HI-SECURITY™ IC Core Models: Interchangeable Core models for 6 or 7 pin cores (not included). **Accepts:** Marks, Marks HI-SECURITY™, Medeco®, KeyMark™, Falcon, Schlage® small format & Best®. **IC Core Tailpieces ARE Included.**

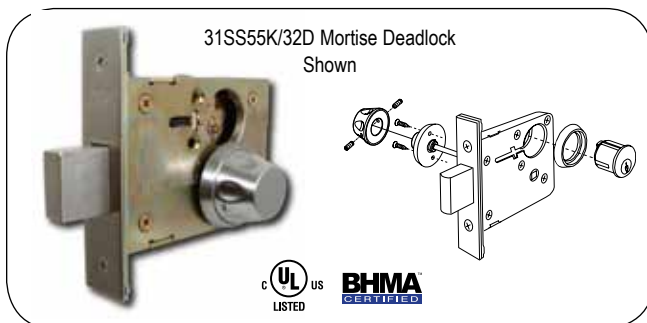

STANDARD FEATURES

PERFORMANCE SPECIFICATIONS

- Life Test:** 1,500,000 cycles minimum.
- ANSI Test:** Meets or exceeds all operational and security tests of ANSI A156.5-2001 for series 31, Grade 1.
- Fire Test:** UL Listed, 3 hour fire rated.

TRIM SPECIFICATIONS

Interior Trim:

Solid stainless steel interior trim including finger indented safety knobs which recess into solid brass through-bolted roses.

Series 31 Deadlock Specifications ANSI E06071 Cylinder x Turnpiece

Deadbolt by outside key. Interior safety knob will retract but not project deadbolt.

- Backset:** 2-3/4"
- Strike:** #4035 1-1/8" x 3-1/8" standard, #3135 4-7/8" x 1-1/4" optional
- Bolt Throw:** 1" Stainless steel with hardened roll pins
- Case:** Stamped steel
- Front:** 1-1/16" x 4-5/8" adjustable bevel
- Cylinder:** Solid brass cylinder, 6-pin, "C" keyway. Optional HI-SECURITY™ cylinders available.

MARKS # 31SS55		FUNCTION	ANSI #	FINISH GROUPS
COMM. CYLINDER	IC CORE CYLINDER*			
KEYED SINGLE CYLINDER, WITH DEADBOLT				
K	RK	CYLINDER x KNOB	E06071	32D
S	RS	CLASSROOM	E06091	

* Standard & HI-SECURITY™ IC Core Models: Interchangeable Core models for 6 or 7 pin cores (not included). **Accepts:** Marks, Marks HI-SECURITY™, Medeco®, KeyMark™, Falcon, Schlage® small format & Best®. **IC Core Tailpieces ARE Included.**

PD SERIES HOSPITAL LOCKSETS

CYLINDRICAL & MORTISE PUSH/PULL PADDLESETS

CYLINDRICAL ANSI 156.2 GRADE 1 & MORTISE ANSI 156.13 GRADE 1

PD SERIES HOSPITAL LOCKSETS

Our unique cylindrical and mortise hospital push/pull paddlesets feature universal assemblies where you can choose to install handles to point two-up or two-down or one-up and one-down. No handing needed. Marks USA design innovation also produced an improved short angle design meaning easier hands free push/pull for the user. Great retrofit, superior for new construction!

MARKS # 1 PD	FUNCTION	ANSI #	FINISH GROUPS
KEYLESS			32D
N	PASSAGE	F75	

MARKS # 5 & 55 PD	FUNCTION	ANSI #	FINISH GROUPS
KEYED SINGLE CYLINDER, NO DEADBOLT			
D	OFFICE VEST.		
DW	VESTIBULE		
E	OFFICE	F04	
EW	STOREROOM	F07	
J	CLASSROOM	F05	
JM, JR	HOSPITAL	F06	
GL	INSTITUTIONAL PRIVACY	F26	
EL	ELECTRICALLY LOCKED		
EU	ELECTRICALLY UNLOCKED		

KEYED SINGLE CYLINDER, WITH DEADBOLT			
A	ENTRANCE	F08, F10	
B	ENTRANCE	F21	
F	DORMITORY	F12	
FS	DORMITORY		
FW	DORMITORY	F13	
FD	APARTMENT	F20	
H	HOTEL	F15	
LH	SPECIAL PRIVACY		

KEYED DOUBLE CYLINDER, NO DEADBOLT			
G	APARTMENT	F09	32D
GC	INTRUDER LATCHBOLT	F32	
GG	CLASSROOM SECURITY		
GR	CLASSROOM SECURITY w/HOLDBACK		
WW	INSTITUTIONAL	F30	

KEYED DOUBLE CYLINDER, WITH DEADBOLT			
AC	ENTRANCE	F35	
C	STOREROOM	F14	
FC	INTRUDER DEADBOLT	F34	
FA	DORMITORY	F11	
FX	DORMITORY	F33	

KEYLESS			
N	PASSAGE	F01	
L	BATHROOM	F02	
LF	PRIVACY	F19	
LJ	PRIVACY	F22	
EX	EXIT	F31	

DUMMY TRIM			
DI	DUMMY TRIM INSIDE		
DO	DUMMY TRIM OUTSIDE		
DT	FULLY DUMMY		

* Standard & HI-SECURITY™ IC Core Models: Interchangeable Core models for 6 or 7 pin cores (not included). Accepts: Marks, Marks HI-SECURITY™, Medeco®, KeyMark™, Falcon, Schlage® small format & Best®. IC Core Tailpieces ARE Included.

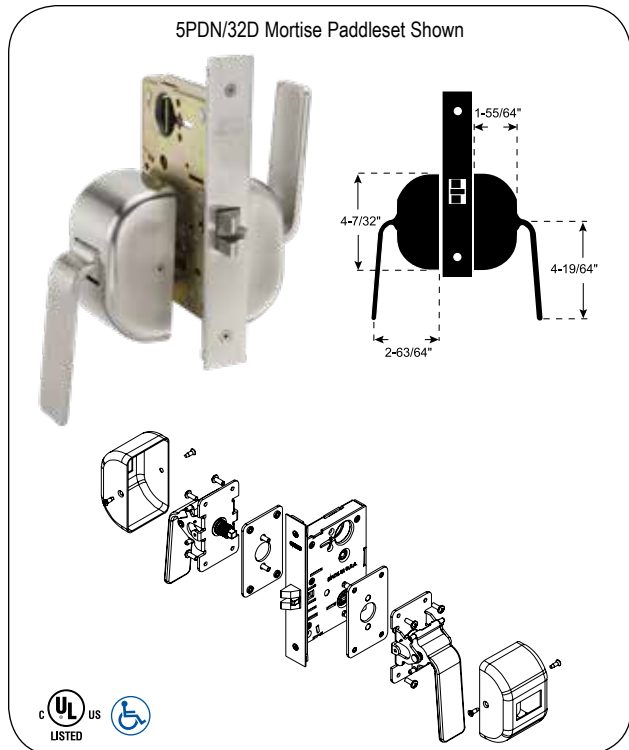
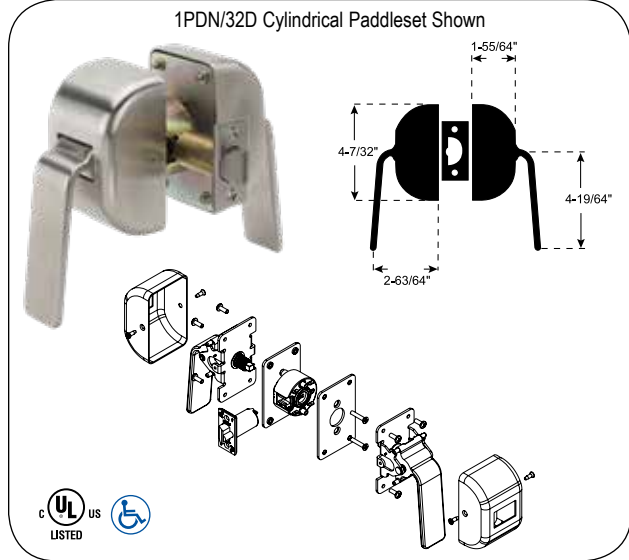

STANDARD FEATURES

Cylindrical:

- Backset: 2-3/4" standard, 2-3/8", 3-3/4" and 5" optional
- Strike: #1136, 2-3/4" "T" strike; #1135 4-7/8" ASA strike optional
- Government standard #161

Mortise:

- Backset: 5 Series 2-3/4", 55 Series 2-1/2"
- Strike: #9035, 4-7/8" ASA curved lip strike

- Door Thickness: 1-3/4", self adjusting for thicker doors
- ANSI-A156.2, Grade 1
- Lead lining and engraving available
- ADA Compliant • Non-Handed
- Functional, modern design with variable mounting positions
- Standard 32D finish, consult factory for available finishes
- Easily reversible configuration for push or pull styles

I-QWIK LITE ELECTRONIC ACCESS CONTROL

NO-NONSENSE ACCESS CONTROL RIGHT OUT OF THE BOX!



IQ1LITE Cylindrical Model Shown;
19 Black Powder Coat finish with
26D Satin Chrome Plated American Levers

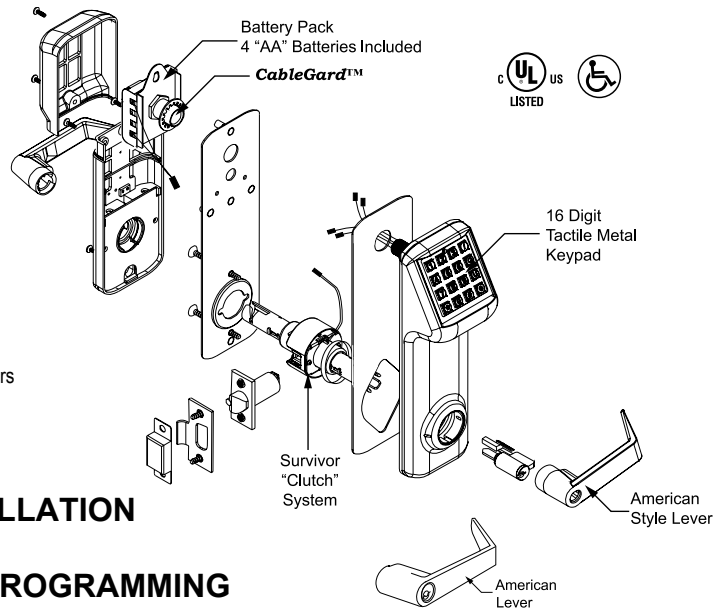

iqwIK INSTALLATION

iqwIK PROGRAMMING

MARKS #		LOCKSET TYPE	# OF USERS	FINISH GROUPS	
For Finish 19	For Finish 26D				
IQ1LITE	IQ1L/26D	Cylindrical Lockset	160	19: Black Powder Coat with 26D Satin Chrome Plated American Levers	26D: Satin Chrome Plated
IQ2LITE	IQ2L/26D	Mortise Lockset			
IQ7LITE	IQ7L/26D	Rim Exit Device Interface <i>Adapter plates operate most manufacturers Rim Exit Devices Adapter plates for Mounting Exit Devices are sold separately, see page 21.</i>			

I-QWIK LITE STANDARD FEATURES

- CableGard™ protects wires for easy installation
- Standard ANSI door prep with one additional hole
- Pre-programmed code
- Keypad programmable
- 160 User codes
- Temporary user codes
- Passage mode
- Pin only mode
- Double code entry for maximum security
- Two wire remote release
- 16 Digit tactile metal keypad
- Weatherproof standard
- Audible & visible entry indicator
- Audible low battery alert
- 4 "AA" batteries, 95,000 operations
- Easy installation

LOCKSET SPECIFICATIONS

IQ1 LITE CYLINDRICAL LOCKSET

Door Thickness: 1-3/4" standard
For thicker doors, Consult factory

Handing: Non-handed

Key Override: Marks "C" keyway, 6 pin w/2 keys, IC Core optional

Lock Body: Cylindrical "Survivor" featuring the "Clutch" for trouble free service

Latch: Grade 2, 2-3/4" backset, 1/2" throw, 3 Hour UL fire rated

Strike Plate: 4-7/8" ASA strike

IQ2 LITE MORTISE LOCKSET

Door Thickness: 1-3/4" standard
For thicker doors, Consult factory

Handing: Field reversible

Key Override: 1-1/8" Mortise cylinder, 6 pin w/2 keys

Lock Body: Grade 1, Series 5, 2-3/4" backset, 3/4" anti-friction latch, 3 Hour UL fire rating

Auxiliary Latch: 1/2" throw

Bolt Throw: 1" (Optional deadbolt functions - Consult factory)

Clutch: The "Clutch" for trouble free service

Strike Plate: 4-7/8" ASA standard

IQ7 LITE RIM EXIT DEVICE INTERFACE

Door Thickness: 1-3/4" standard
For thicker doors, Consult factory

Handing: Non-handed

Key Override: 1-1/8" Mortise cylinder, 6 pin w/2 keys

Clutch: The "Clutch" for trouble free service

Adapter plates operate most manufacturers Rim Exit Devices. Adapter plates for Mounting Exit Devices are sold separately, see page 21.

LIFETIME MECHANICAL WARRANTY; 2 YEAR ELECTRONIC WARRANTY • FINISHES ARE EXCLUDED FROM THIS WARRANTY

I-QWIK SERIES ELECTRONIC ACCESS CONTROL

RIM EXIT DEVICE STAND ALONE ACCESS CONTROL

THE NEW
I-QWIK LINE



IQ7DATA/26D Rim Exit Device Interface Model Shown

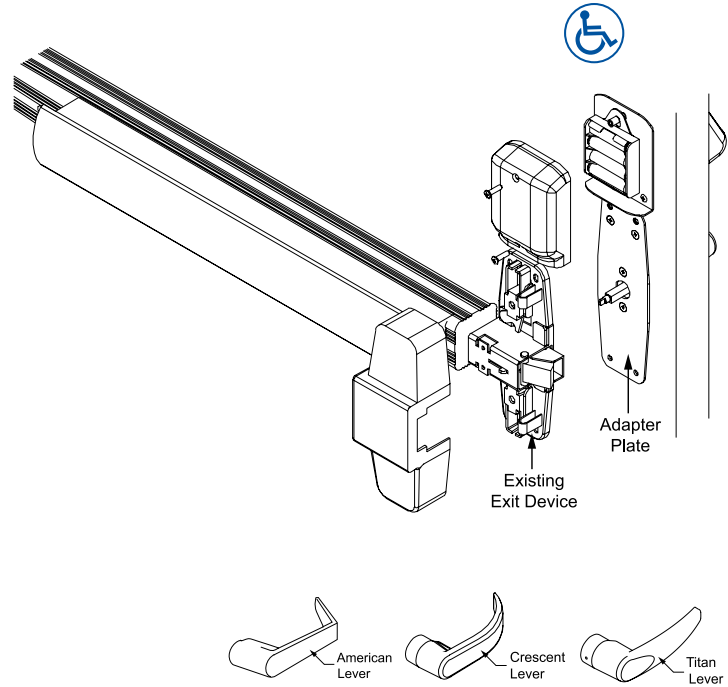

MARKS #		LOCKSET TYPE	FINISH GROUPS	
For Finish 19	For Finish 26D			
IQ7LITE	IQ7L/26D	Rim Exit Device Interface <i>Adapter plates operate most manufacturers Rim Exit Devices Adapter plates for Mounting Exit Devices are sold separately, see below.</i>	19: Black Powder Coat with 26D Satin Chrome Plated American Levers	26D: Satin Chrome Plated

STANDARD FEATURES

- For the IQ7 LITE standard features and lockset specifications, see page 18.
- Additional finishes, consult factory

ADAPTER PLATES

Rim exit device interface with a choice of adapter plates to fit most rim exit devices (*available separately*) are listed below:

DESCRIPTION	PART #
M9900 - Von Duprin 99 Rim Adapter Plate/Detex Advantex 10 Series Rim Adapter Plate	E7071
Precision 1100 Rim Adapter Plate	E7072
Yale 7100 Rim Adapter Plate/Corbin ED5200 Rim Adapter Plate	E7073
Dorma 9300 Rim Adapter Plate	E7074
Sargent 8800 Rim Adapter Plate/Arrow 3800 Rim Adapter Plate	E7075
Precision 21 Rim Adapter Plate/Precision 2100 Rim Adapter Plate**	E7076
Von Duprin 88 - Special Order, Consult Factory	E7077
Monarch 18R Exit Device Adapter Plate	E7078

**** MUST USE PRECISION #BP21 BACKPLATE**

LIFETIME MECHANICAL WARRANTY; 2 YEAR ELECTRONIC WARRANTY • FINISHES ARE EXCLUDED FROM THIS WARRANTY





FOR ADDED SAFETY IN AN EMERGENCY, TEACHERS CAN LOCK THEIR CLASSROOM DOORS FROM THE INSIDE WITH THE LOC-DOWN™ SERIES CLASSROOM LOCKS BY MARKS USA.

LocDown™ SERIES FOR EVERY EDUCATIONAL BUILDING AND DOOR

Typical Classroom function cylindrical locksets are designed to be locked or unlocked from the exterior, with the interior always in an open position. The new Loc-Down™ Classroom Intruder Lockset by MARKS USA, is designed to be locked or unlocked from the exterior, always open on the interior, but allows in emergency life safety situations, the teacher to secure the classroom without stepping into the hallway to lock the outside handle. For More on our K-12/ Campus Security Solutions also visit www.savischool.com



LOCDOWN™

<p>F110 Classroom Intruder Deadlocking latch by knob/lever either side; except when outside locked by key inside. Key outside locks or unlocks outside; inside always open</p>		<p>DB</p>
<p>F32 Intruder Latch Bolt Latch by knob/lever either side except when outside knob/lever is locked from inside or outside by key. Auxiliary latch deadlocks latch bolt when door is locked. Inside knob/lever is always free from immediate egress. Latch operated by key from inside or outside.</p>		<p>GC</p>
<p>Classroom Security Latch by knob/lever either side except when outside knob/lever is locked from inside or outside by key. Auxiliary latch deadlocks latch bolt when door is locked. Inside knob/lever is always free for immediate egress.</p>		<p>GC</p>
<p>Classroom Security w/ Holdback Latch bolt retracted by knob/lever from either side unless outside is locked by key from either side. When locked, latch bolt retracted by key outside or knob/lever inside. Auxiliary latch deadlocks latch bolt when door is locked. Depress inside knob/lever and turn key 360° for holdback feature. Inside knob/lever always free for immediate egress.</p>		<p>GR</p>

AVAILABLE IN ALL LEVER AND ESCUTCHEN TRIM

- At the first sign of trouble outside, lock down a classroom instantly
- Faculty & students remain safely within classroom, no need to open door
- The interior lever is capable of retracting the latch at any time
- Available as cylindrical locks with cylindrical function F110 or as mortise locks with mortise function F32
- Double-cylinder cylindrical lockset built to ANSI/BHMA Grade 1 specs
- Can be ordered with levers that meet the ADA, Life Safety and local jurisdiction codes
- Mortise locks meet or exceed ANSI/BHMA 156.13 Grade 1 specifications
- Easy Retro-Fit Installation

LEVERS AVAILABLE TO ACCEPT FOLLOWING OEM

CYLINDERS:

Yale Conventional, Sargent Conventional, Corbin Conventional, Corbin 6 Pin IC Core, Corbin 7 Pin IC Core, Yale 6 Pin IC Core, Yale 7 Pin IC Core, Schlage 6 Pin IC Core, Sargent IC Core, Medeco IC Core Large Format, BEST, Falcon SFIC

FOR ADDED SAFETY IN AN EMERGENCY, TEACHERS CAN LOCK THEIR CLASSROOM DOORS FROM THE INSIDE WITH THE LOC-DOWN™ SERIES CLASSROOM LOCKS BY MARKS USA.

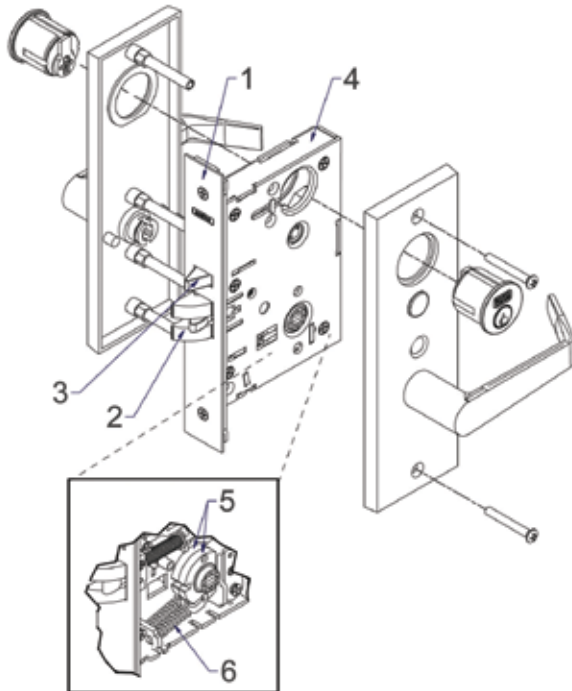

Standard Features

Performance Specifications:

Life Test 1,500,000 cycles, minimum

Strength Test: 530 inch lbs. torque on exterior lever. When applied, lockset remains locked. (Torque of over 550 inch lbs. will cause spindle failure. However, lockset remains locked once spindle is replaced, lockset is fully operational.)

ANSI Test Certified to meet or exceed all operational and security tests of ANSI/BHMA A156.13-2012 for series 1000, Grade 1.

Fire Test: UL listed, 3 hour fire rated; Meets ADA requirements.

Function Specifications: LA318GJ Classroom Intruder:

Latch by lever either side except when outside lever is locked from inside or outside by key. When locked, exterior key will retract latchbolt. Outside key locks or unlocks exterior lever. Inside key is single acting in one direction and will lock exterior lever only; will not unlock exterior lever. Auxiliary latch deadlocks latch. Inside always free for egress

Trim: Cast satin stainless steel escutcheon 8-1/2"x2-3/4"x7/16". Recess in escutcheon to accept cylinder with rotating cylinder ring. Cast screwless satin stainless steel lever handles to within 1/2" from face of door secured to escutcheon plate with hardened steel retainer ring. Lever handle, with spring-loaded torque sensitive 5/16" spindle. Integral torque override preventer recessed into escutcheon plate. Spindle will yield if excessive torque applied, preventing any damage to lock body.

Exterior: Two 1/4" diameter threaded thru posts.
Two 1/4" diameter center posts pass thru lock body, automatically aligning trim.

Interior: Two #10-32 phillips head stainless steel mounting thru bolts. Escutcheon with "LOCK" and directional arrow engraved and black filled near cylinder location. Occupancy indicator recessed into escutcheon plate. Indicator window to display unlocked (green day-glo) and LocDown™ (red day-glo) positions

Cylinders: Two 1-1/8", 6-pin solid brass with 2101 cam int., 2105 cam ext., with two keys. Outside cylinder rotates in both directions. Inside cylinder rotates in one direction only. Cams supplied to accommodate Corbin™, Sargent™ and Schlage™ cylinders.

Strike: 4-7/8" X 1-1/4" X 3/32" thick, 5/8" curved lip. Conforms to ANSI spec. 115.1.

Door Thickness: 1-3/4"

Lock Body: 5 series "GJ" function double cylinder lock. Lock handing completely reversible without opening lock case

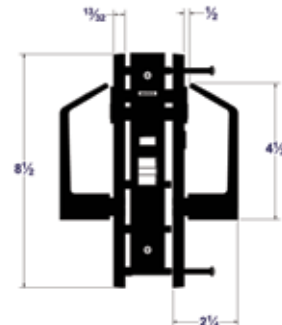

LOCDOWN™

ArchiTech™ SERIES: *STANDALONE, NETWORKED, ENTERPRISE*

ArchiTech™ Series Network Locks are an ideal access control solution; elegantly blending advanced wireless access control convenience within any décor, in an attractive, infinitely customizable designer locking form factor, in choice of trims and finishes. Ideal for educational, commercial office or multi-dwelling residential settings, these stylish, durable locks, leveraging proven Networkx access control technology, offer a choice of ID credential technology, and can be used to control access a door at a time; across a wireless network; or as an integral part of a new or existing enterprise security system—spanning a few, or thousands of doors, in one building, a campus or multiple sites around the world.



Mortised-in Electronics





Surface mount models



Cylindrical

Performance Overview

- **All Applications and Doors** - Cylindrical and Mortise models for wood and metal doors, for new and existing applications, with wireless surface mount or mortised-in electronics and batteries.
- **Customize To Match Any Aesthetic Look, For Every Décor** - Over 300 locks, levers, roses and finishes to choose from, durable ANSI/BHMA Grade 1 hardware over 300 locks, levers, roses and finishes.
- **Future-Proof Multi-Technology Access ID Credentials Replace Cumbersome Keys** – HID® Prox, Mag Stripe, Smart Cards, PIV, keyfobs and remote buttons. Also new Smartphone Access & iLock App with Bluetooth LE.
- **Emergency Lock-Down** option via lock, button, keyfob or server (where networked). (Global Unlock via server too.)
- **Proven, Low Maintenance, Wireless Installation And Unsurpassed Battery-Life with Advanced Power-Saver circuit**, with years of use in even high-traffic areas, using off-the-shelf AA batteries.
- **Flexible System Programming** Locally using a USB Gateway or remotely across a wireless network (using free Alarm Lock DL-WINDOWS Windows- based software) or integrated on an enterprise class IT environment, in realtime, using LENEL.
- **Networking Choices** – Choose 802.11 or Ethernet network, with wireless encrypted bi-directional gateways, in which many locks communicate to a single gateway, or use a wireless RF USB Gateway equivalent. For entry door applications and the like, used in conjunction with strikes and mags, use with Networkx NetPanels. Or, use as a single-door control, as part of the IT-Network environment, with Continental Access CA3000 or Lenel OnGuard® Integrated Access Control & Video Security Platforms.

STANDARD CONFIGURATIONS



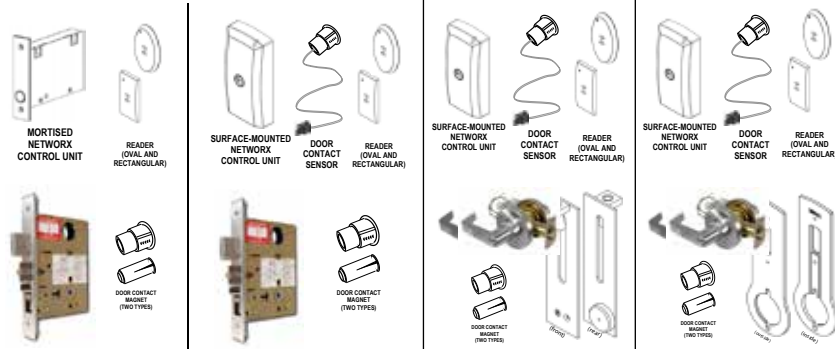

Standalone Specifications

- ArchiTech Series combine attractive, durable Grade 1 locksets with proven wireless Networkx access control technology in one aesthetically - pleasing standalone access control and locking package.
- Ideal for all discriminating applications, from high-rise residences or offices to universities, anywhere keyless access control would be welcome and convenient
- Support for a variety of access control credentials from ID cards and badges, e.g., prox., mag stripe and smart cards, to several keyfob styles.
- Ultra décor-compatible, there are unlimited combinations of 300+ architectural trims, lever or knob designs trims & finishes, for an entirely custom look – all durable ANSI/BHMA Grade 1.
- Flexible for any application and door, wood or metal, the standalone, self-contained system is wireless and can be surface mounted or recessed within the door.
- Low maintenance, the durable system is also powered by 4 off-the-shelf AA Batteries – with unsurpassed long-battery life for up to 3 to 4 years using advanced Power-Saver circuit.
- Readily networked for future requirements

FEATURES:



Shown with mortised-in electronics and batteries

- 5000 Users, 500 Scheduled Events & 40,000 Event Audit Trail
- Surface-Mount or Mortised-in Electronics and Battery Pack
- Lock available in Mortise and Cylindrical versions
- Real Time Clock
- Uses 4 AA Batteries – 3 year battery life, typ. using advanced Power-Saver circuit.
- Operated via access card, keyfob or bluetooth enabled iLock® App.
- DL-Windows Software for programming Or in enterprise network, in real time, use with Continental Access® CA3000, CA4K®, or Lenel OnGuard® Integrated Access Control & Video Security Platforms
- USB Radio Gateway Method or Via Networkx Gateways (Ethernet, 802.11 or POE)
- Manual Card Enrollment Option for Quick Installation
- Wireless programming range: up to 100 ft.
- ANSI / BHMA Grade 1 Certified, UL Listed 3 Hours
- Auto-Deadbolt option for automatic keyless locking of deadbolt upon exiting, ideal for residential applications
- Includes standard lever rose hardware design
- Compatible with all 300+ optional architectural trim / lever or knob designs
- Stainless steel latch, 2-3/4" backset
- Auto-Reverse lock body tested to 6 million cycles
- Lock Body - Self cleaning long life motor
- Door closure monitor / electronic deadbolt monitor
- Key override standard or high-security
- Optional integrated door position indicator switch

DESIGNER WIRELESS ACCESS CONTROL PLATFORM



SERIES: TRILOGY NETWORKX GEN.2 GATEWAYS & EXPANDERS



AL-IME2 Gen. 2 Gateway
The Trilogy Networkx AL Generation Gateway, interfaces Networkx locks with a PC network via a hardwire Ethernet connection. It is very similar in function to the original hardwired Networkx Gateway

Modules, but is enhanced with additional extended potential range, supporting up to seven (7) Expanders (model AL-IME2-EXP Expanders). Each Expander can extend the AL-IME2 Gateway's coverage area by approximately 100 feet. Also both Gen. 2 Gateways and matching Expanders have a new modern styling, and three LED indicators, blending into any décor.



AL-IME2-POE Gen. 2 Gateway
The Trilogy Networkx AL-IME2-POE (Power Over Ethernet) Hardwired Gateway interfaces Networkx locks with a PC network with hardwire Power-Over-Ethernet. It is very similar in function to the original hardwired Networkx Gateway Modules, but is enhanced with alternative power, and additional extended potential range, supporting up to seven (7) Expanders (model AL-IME2-EXP Expanders).



AL-IM2-80211 Gen. 2 802.11 Gateway
Similar to model above, but this 802.11 Gateway Module includes a bi-directional radio, and interfaces Networkx locks with a PC network with hardwire Ethernet and wireless 802.11. It is very similar in function to the original 802.11 Networkx Gateway Modules, but is enhanced with additional extended potential range, supporting up to seven (7) Expanders (model AL-IME2-EXP Expanders). Each Expander can

extend the AL-IM2-80211 Gateway's coverage area by approximately 100 feet.



AL-IME2-EXP Expander
Trilogy® Networkx™ Expander extends the coverage area of a Gen 2 Series Gateways to Trilogy Networkx Locks within a PC network, allowing greater distances for the placement of up to a maximum rated capacity of 63 Networkx locks per Version 2 Gateway.



AL-IME2-PIE Plug-in Expander
The Trilogy® Networkx™ Plug-In Expander extends the coverage area of a Generation 2 Series AL-IME2 Gateway to Trilogy Networkx Locks within a PC network, allowing greater .2 802.11 distances for the placement of up to a maximum rated capacity of 63 networkx locks per Version 2 Gateway.

Use the iLock® App to unlock your Networkx ArchiTech™ Series Door Lock in seconds!



Introducing iLock®, the easy smart-phone mobile solution for unlocking your Trilogy®Networkx™ or ArchiTech™ Series Designer Access Control Locks from any smart device without the need to carry cumbersome ID cards or keys. Password protected access is secure through the use of Bluetooth LE and proprietary encryption. Additionally, an optional feature can be utilized, requiring a password for each unlock request.

The Key is Your Smartphone & More Secure Technology

Any Smart Device can be the Access Key: Much more than an ID card displayed on your smartphone, for your security, ArchiTech & its iLock™ App



are wirelessly linked together, each supplying its portion of stored encrypted data to provide secure access without a key, fuss or worry, ensuring user identities. A unique combination of convenience and cloneproof peace of mind, the ArchiTech platform uses universally-compatible Bluetooth LE™ technology, so they can use any smart device to unlock ArchiTech on your door(s); and do so from afar, at a comfortable, customizable range of up to 30 feet away. For even greater security users

can add an optional passcode, entered on their phone App. Coming soon: emailable digital eKeys for guests or service temporary access, too.

iLock App is available from both iTunes and the Google Play Store



STANDARD MODEL ORDERING. INFINITE CUSTOM MODELS ALSO AVAILABLE, CALL FOR ORDERING ASSISTANCE

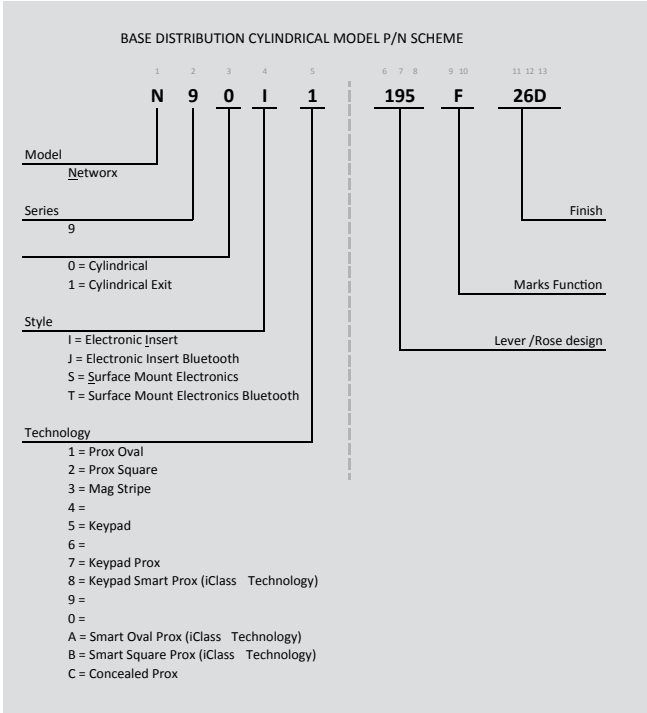
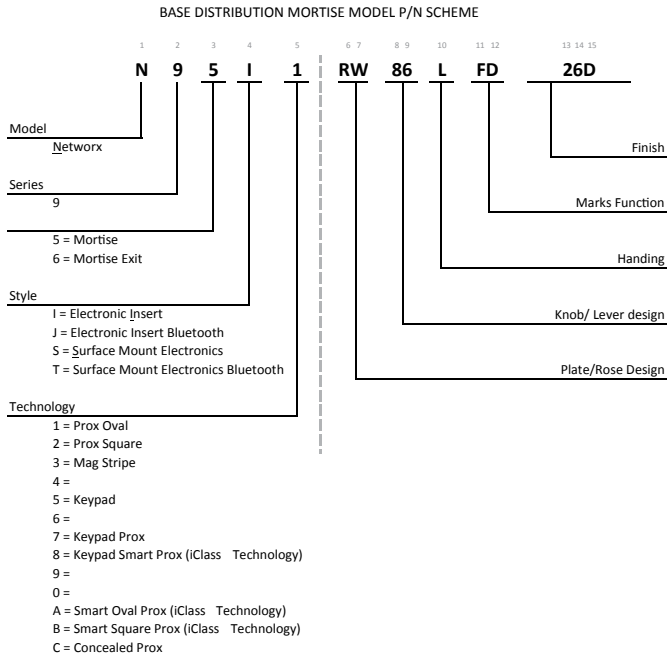

Make a custom look all your own: Limitless selection of Grade 1 Trims & Finishes

Select Standard Mortise & Tubular Lock Trim & Rose Options:

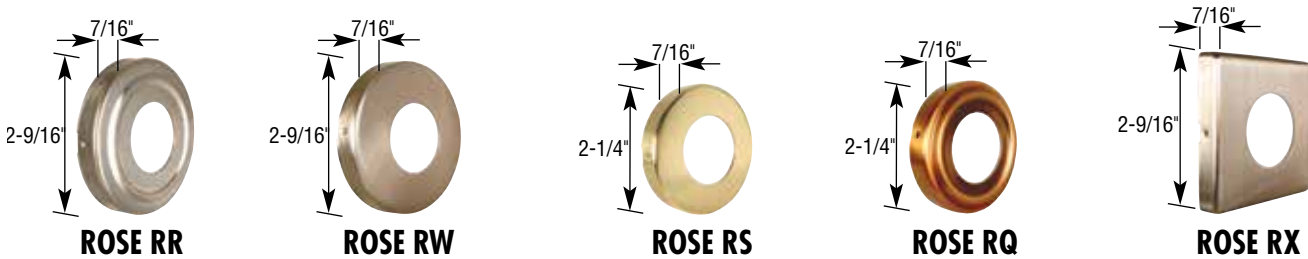

Architech™ *SELECT STANDARD MORTISE & TUBULAR LOCK TRIM OPTIONS*



ROUND 10

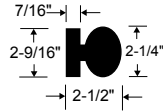

STANHOPE 5644

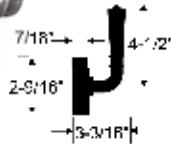

PLAZA 82

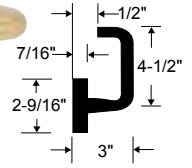

BALL 20/30

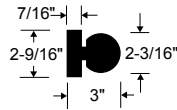

MONACO 57

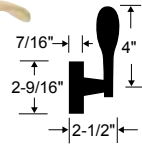

DAYTON 83

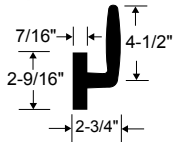

ECLIPSE 60

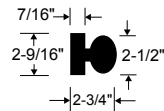

TOWNE 72

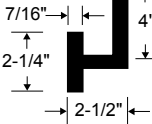

CRESCENT 86

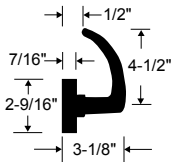

MAXWELL 77

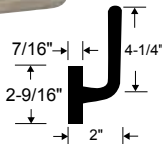

AMERICAN 92

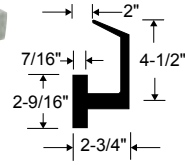

OMNI 78

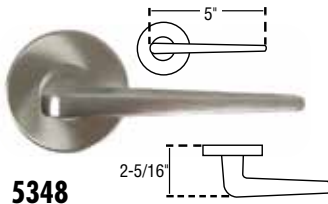
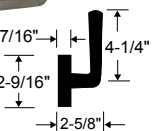

5348

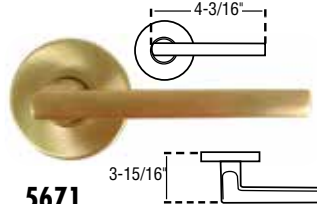
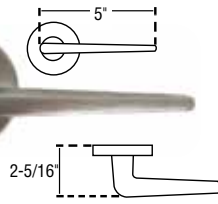

5671

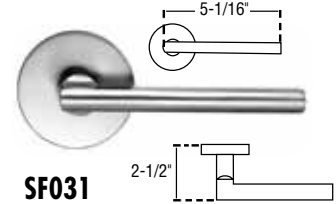
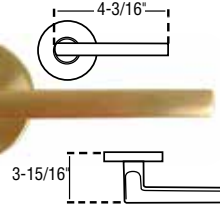

SF031

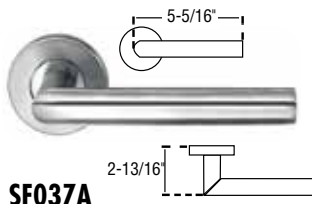
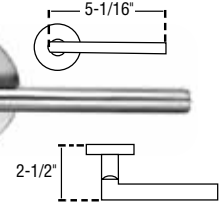

SF037A

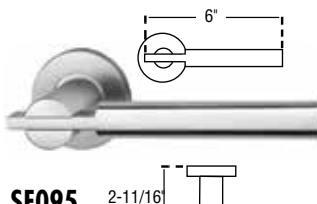
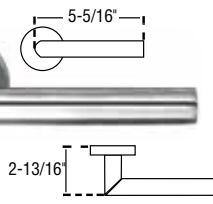

SF095

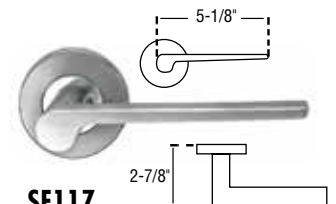
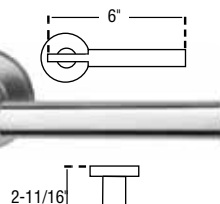

SF117

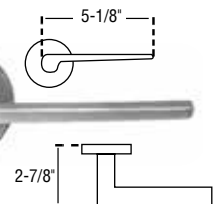

SERIES M9900 - EXIT DEVICE

RIM MOUNT



MARKS #	FUNCTION
M9900	Rim Panic
M9900F	Fire Rated Rim Panic
M9900 - 48	Rim Panic - 48"
M9900F - 48	Fire Rated Rim Panic - 48"

OPTIONS	
M9900	33" LENGTH FOR 36" DOOR
M9900 - 48"	42" LENGTH FOR 48" DOOR

SPECIFICATIONS
<ul style="list-style-type: none"> • Doors: 1-3/4" thick standard. • End cover: Flush mounted beveled "Panic Protector" design. • Strike: Roller strike. • Rail Assembly: Extruded Aluminum, 32D finish. • Dead latch Bolt: Stainless Steel 3/4" throw. • Dead latch Bolt: Stainless Steel 5/8". • Dogging feature: Allen Key (M9900) • UL listed: For "Panic Hardware" and Fire Rated Model 3 hour fire doors up to 38" x 86". • ANSI: ANSI 156.3 (2001), requirements for Grade 1. • 3 Hour Fire Rating • Finish: 32D

<ul style="list-style-type: none"> • EXTRUSION HEAVY GAGE, 32D FINISH • PANIC PROTECTOR™ END CAP • LIFETIME MECHANICAL WARRANTY • EASY INSTALLATION, ECONOMICAL

SERIES M9900 VR - EXIT DEVICE

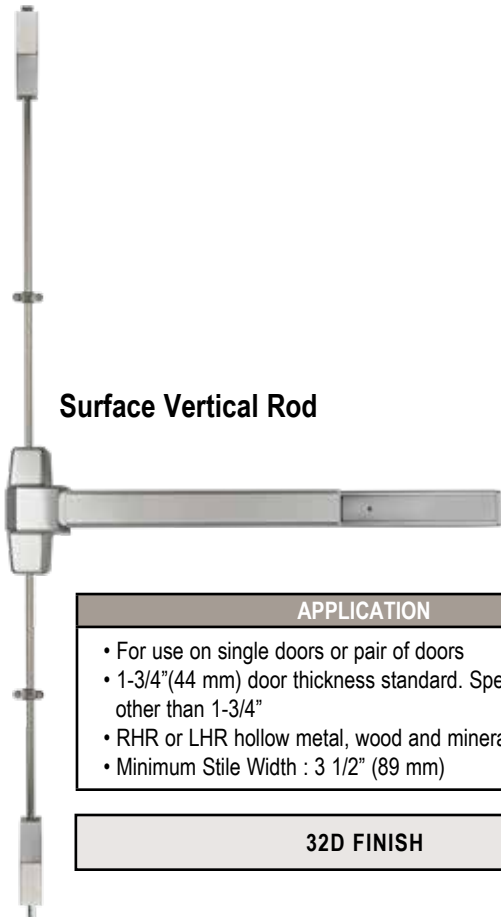

Surface Vertical Rod







MARKS #	FUNCTION
M9900 VR	Rim Panic Vertical Rod
M9900F VR	Fire Rated Rim Panic Vertical Rod
M9900 - 48 VR	Rim Panic Vertical Rod - 48"
M9900F - 48 VR	Fire Rated Rim Panic Vertical Rod - 48"

SPECIFICATIONS
<p>Device Head Cover: Zinc alloy or stainless steel Chassis: Steel, plated Mechanism Housing: Extruded aluminum Push Bar Base: Extruded aluminum Touch Plate: Stainless steel End Cap: Stainless steel Top Latch: Stainless steel 37/64" (14.8mm) Top Strike: Included Bottom Latch: Stainless steel 37/64" (14.8mm) Bottom Strike: Included Latch Case Covers: Steel, stainless steel or brass Vertical Rods: Aluminum tube Hand: Non-handed Mounting: Machine screws standard. Sex bolts optional. Order "SNB" for wood or unreinforced metal doors Dogging: Allen-type key furnished Finish: 32D Outside Trim: Order separately Standard height: For 7'0" doors UL Listed: ANSI/BHMA Grade1 Panic Exit Hardware, 3-Hour Fire Rating</p>

APPLICATION
<ul style="list-style-type: none"> • For use on single doors or pair of doors • 1-3/4"(44 mm) door thickness standard. Specify thickness other than 1-3/4" • RHR or LHR hollow metal, wood and mineral core doors • Minimum Stile Width : 3 1/2" (89 mm)

32D FINISH

SERIES M9900 - EXTERIOR TRIM

M411	Lever/Rose	Rim Panic Vandal Pull
	 M195F	 MVP/32D
MES600A	Cylindrical Dogging Kit - 32D	Rim Panic Vandal Pull w/ cylinder hole
	 M9901 M9902	 MVPCC/32D (cylinder not included)





MARKS #	FUNCTION
M411	Finger Pill - no cylinder
MESC600A	Lever / Escutcheon Trim Entry
MESC600F	Lever / Escutcheon Trim Storeroom
MESC600N	Lever / Escutcheon Trim Passage
MESC600DT	Lever / Escutcheon Trim Dummy Trim
M9901	36 inch Panic Device Dogging Kit
M9902	48 inch Panic Device Dogging Kit
MVR8	Vertical Rod 8 ft extension - Code 8
MVR10	Vertical Rod 10 ft extension - Code 10
MVRB	Vertical Rod - Bottom Rod
MVP/32D	Rim Panic Vandal Pull
MVPCC/32D	Rim Panic Vandal Pull w/ cylinder hole

ENTRY LEVER TRIM
<ul style="list-style-type: none"> Standard Marks "C" Keyway KNK cylinder for panic device. Cylinder locks or unlocks lever, rigid when locked; when unlocked retracts latch bolt. Marks 26D Finish / Standard 1-3/4" Door Thickness IC Prep Code G1, Less Cylinder G3
Escutcheon Lever Design
<ul style="list-style-type: none"> Thru bolt design Non Handed design. Easily field reversible. Marks 32D Finish / Standard 1-3/4" Door Thickness Standard Marks "C" Keyway 1-1/4" Mortise cylinder with special cam IC Prep Code G1 Less Cylinder G3



EXIT DEVICES

CAMS & TAILPIECES

MORTISE CYLINDER CAMS

M9907		MESC600A
M9908		MESC600F
M9909		MESC600A IC CORE HOUSING
M9910		MESC600A IC CORE HOUSING

KNK CYLINDER TAILPIECES

M9903		MLHL650A - CLIP ON
F1903.SCH		MLHL650F - SCREW CAP
M9984		MLHL650A or F - IC CORE 627 PIN

SERIES M195 - EXIT DEVICE TRIM

Specifications	
Levers:	Solid cast Zamac, with 1/2" return (except 395 & 495)
Roses:	Thru-bolted, 3-7/16" spring loaded Roses
Door Thickness:	1-5/8" - 1-7/8"
Clutch:	Standard
Chassis:	Aluminum
Cylinder:	MARKS "C" keyway, 6 pin w/ 2 keys IC Core model - Core not included
<i>Lifetime Mechanical Warranty</i>	

MARKS #	Trim
M195S/295/395/495	MLHL650S
M195F/295/395/495	MLHL650F
M195N/295/395/495	MLHL650N
M195DT/295/395/495	MLHL650DT

OPTIONS	CODE
Yale Conventional	F7
Sargent conventional cylinder	F8
Corbin conventional cylinder	F9
Corbin 6 pin IC core	F12
Corbin 7 pin IC core	F13
Yale 6 pin IC core	F14
Yale 7 pin IC core	F15
Schlage 6 pin IC core	F19
Sargent IC core	F20
Medeco IC core large format	F21
Less Cylinder	G3

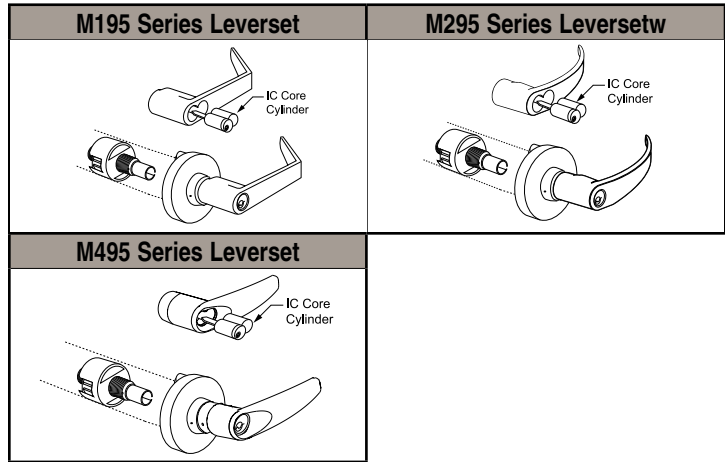

★ **Standard & HI-SECURITY™ IC Core Models:** Interchangeable Core models for 6 or 7 pin cores (not included). **Accepts:** Marks, Marks HI-SECURITY™, Medeco®, KeyMark™, Falcon, Schlage® small format & Best®. **IC Core Tailpieces ARE Included.**

SERIES M8800 - NARROW STILE EXIT DEVICE



MARKS #	FUNCTION
M8800	Rim Panic
M8800 - 48	Rim Panic - 48"

SPECIFICATIONS	
Specification:	Conforms to ANSI BHMA A156.3 Grade 1 Exit Device Requirement Standard ANSI/UL305 Standard for Safety for Panic Hardware 2013 California Building Code Sec. 11B-309.4
For Doors:	(Please specify when ordering non standard size doors) Thickness: Standard 1 3/4", may fit with door thickness up to 2" Width: Standard 36" or 48", may fit door width 30"-48"
Mounting:	Furnished Standard with Wood and Machine Screws
Head Cover:	Zinc Alloy
Chassis:	Aluminum
Rail Assembly:	Heavy Gauge extruded aluminum with stainless steel on top of touch bar
End Cap:	Zinc Alloy
Hand:	Non-handed
Latch Bolt:	Stainless Steel, 3/4" (18mm) throw
Strike:	Roller Strike (Stainless Steel)
Dogging:	Allen Key (equipped on panic rate devices only)
Finish:	32D: Satin Stainless Steel Finish 10B: Oil Rubbed Bronze Finish
Dimension:	Touch bar height from finished floor: 41" (1041mm) from center of touch bar Touch Bar Projection: Neutral: 3 5/16" (84mm) Depressed: 2 19/32" (66mm) Head Cover: LxWxH: 206mm x 76mm x 71mm Device Length: 34 5/8" (88cm) for 36" door width 46 5/8" (118.5 cm) for 48" door width

EXIT DEVICES

ELECTRIC LATCH RETRACTION

with simultaneous dogging



Rim Mount, Vertical Rod & Mortise



MARKS #	DESCRIPTION
HEAVY DUTY	
M9900ER	Electric Latch Retraction
M9900ERP	Electric Latch Retraction w 602 Power Supply

ER Electric Latch Retraction with simultaneous dogging
For: M9900
Example: M9900/32D-ER
Operation: Momentary or maintained latch bolt and push pad retraction
 Automatic re-triggering of latch retraction
Voltage: 24VDC @ 450 mA activation, 180 mA continuous
602RF 1 Amp power supply (1 EMC max)
632RF 2 Amp power supply (2 EMC max)
EMC 2-station sequencer required for automatic doors only.
Monitoring Available Latch status and REX output available

EXIT ALARM



Door sign included, Bar sign optional

Rim Mount, Vertical Rod & Mortise

NARROW VERSION AVAILABLE



EA Exit Alarm, 9V battery powered
EB Exit Alarm, 12-24V AC/DC input, 9V battery backup
For: M9900, M9900VR
Example: M9900/32D-EA

- 100 dB alarm; visual and audible On/Off status:
 Armed - green LED blinks every 4 seconds,
 Alarm mode - red LED, Bypass - no LED
- Remote status output
- 15 or 60 second arming delay
- 2 modes: Continuous alarm with manual key reset; Automatic re-arm 2 minutes after door closes with any manual key reset before 2 minutes.

- Options:**
- Push pad sign
 - 6, 10 & 20 minutes alarm; 1 or 5 second re-arm delay
 - Remote access control, arm, disarm inputs
 - REX and latch status outputs

MARKS #	DESCRIPTION
HEAVY DUTY	
M9900EA	Exit Alarm 9VDC
M9900EB	Exit Alarm 9VDC w 12/24 AC/DC Input

ELECTRIC FRAME ACTUATOR

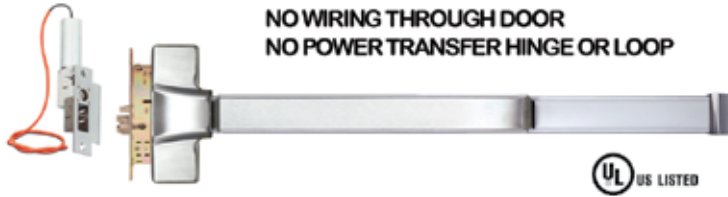

EFA Hitower Pro Frame Actuator Controlled Fire Exit Device

Features include failsafe operation and unlocks by access control, power loss or signal from fire command center. Door stays latched even when unlocked. All wiring is maintained in the strike jamb. Complies with national building and fire codes

Specify Handing and Voltage: 24VDC, 24VAC, 115VAC

Monitoring Available

MARKS #	DESCRIPTION
HEAVY DUTY	
M9900EFA	HiTower Pro Fram Actuator Controller Fire Exit

ELECTRIC DOGGING



DG Electric Dogging (failsecure) M9100, M9900, M9900VR, M9300

Example: M9900/32D-DG

When energized by optional built-in or remote switch manual, depressing the pushpad, causes the pushpad and latch to remain retracted (unlocked) providing push-pull door operation. When de-energized or signaled by a fire alarm, the pushpad and latch are released.

Voltage: 170/100 mA @ 12/24VDC

Monitoring Available: Latch status and REX output available

MARKS #	DESCRIPTION
HEAVY DUTY	
M9900DG	Electric Dogging, Fail Secure
M9900DGP	Electric Dogging, Fail Secure w 602 Power Supply

DELAYED EGRESS



Rim Mount, Vertical Rod & Mortise

DE Wall mount delayed egress controller with keypad and electrified exit device, M9900

Example: M9900F/32D-DE

DEK Keypad controller with redundant key switch capable of all keypad control features

602RF 1 Amp power supply

- User PIN codes may be assigned to 1, 2 or all control functions. Reset, sustained bypass and momentary bypass (RES)
- Audible alarm voice release time, warning or safety message
- Visual display countdown, locked/unlocked, egress executed
- 15 or 30 second exit delay, 1 or 2 second nuisance delay 2 minutes

Monitoring Available: Latch status available

MARKS #	DESCRIPTION
HEAVY DUTY	
M9900DE	Delayed Egress
M9900KDE	Delayed Egress w Keyswitch
M9900DEP	Delayed Egress w 602 Power Supply
M9900KDEP	Delayed Egress w Keyswitch W 602 Power Supply
M9900VRDE	Delayed Egress
M9900VRKDE	Delayed Egress w Keyswitch
M9900VRDEP	Delayed Egress w 602 Power Supply
M9900VRKDEP	Delayed Egress w Keyswitch W 602 Power Supply

HI-SECURITY™ CYLINDERS

HI-SECURITY™ CYLINDERS & SECURITY-MATE™ CYLINDERS

WHAT MAKES MARKS HI-SECURITY™ CYLINDERS UNIQUE?

Marks USA patented HI-SECURITY™ cylinders offer a secondary mechanical locking mechanism that creates resistance to bump and picking attacks. In addition, the design supports a corresponding configuration on the key blank called a “security wave” (shown below) that supports prevention of unauthorized duplication of keys. The locking principal is adaptable to standard cylinders and large and small format interchangeable cores. Marks USA HI-SECURITY™ keyways and security waves are of proprietary origination. The distribution of key blanks is factory controlled. Multiple keyways and security codes are available. Assignment is by geographic or customer category type. The Marks USA HI-SECURITY™ pick and bump resistance features are designed with added security in mind for cylinders, cores and key blanks. In addition, patents provide legal protection for patent infringement against those who attempt to produce or manufacture key blanks or cylinders. Marks USA will aggressively defend its patent rights!



CYLINDER CONFIGURATION

Marks HI-SECURITY™ cylinders are manufactured of brass bar stock. Cylinders are available in a variety of models. In standard construction, there are 1-1/8", 1-1/4", 1-3/8", 1-1/2", and 1-3/4" mortise cylinders. There are a variety of 1" and 1-1/8" combination mortise/rim cylinders, key-in-knob, large format interchangeable specifically for Medeco®, Schlage® locks and Best® type small format interchangeable core models in 6 and 7 pin lengths. Standard and large format cylinders may be ordered with the UL 437 HI-SECURITY™ option for greater drill resistance, Non-UL with the same pick and bump protection and in Security-Mate™ (A standard pin tumbler only cylinder without HI-SECURITY™ features, but matching the same key blank; shown on page 26). SFIC is currently available in Non-UL model only at this time. There are a variety of keying options available. “Zero-bitted” cylinders are shipped standard with either a factory default security code or are supplied with a specific customer security code. The common pin tumbler section of the cylinder has springs, driver pins and accommodates a key blank cut to zero in all positions.



HI-SECURITY™ CYLINDERS

HI-SECURITY™ CYLINDERS & SECURITY-MATE™ CYLINDERS

MARKS SECURITY-MATE™ CYLINDERS

Marks USA Security-Mate™ Cylinders are intended to complement Marks HI-SECURITY™ Cylinder applications. Cylinders may be integrated into a Marks HI-SECURITY™ key system. Driven by dealer and consumer demand for a more economic cylinder solution for interior doors such as closets, where less security is needed but the convenience of carrying a single key is desired, Security-Mate™ is a natural addition to the product line. Security-Mate™ Cylinders are made of quality bar brass with precision tolerances, made in five or six pin configuration and available in Mortise, Mortise-rim Combo and Key-in-Knob cylinder configurations. Only Marks patented HI-SECURITY™ keys will operate the Security-Mate™ Cylinder.



MARKS USA HI-SECURITY™ KEY CONTROL MANAGEMENT PACKAGE

- 1. A Unique Registered, Securely Designed Scalable System:** A custom security solution is defined after careful consideration of your people, operational and safety requirements. A quality system plan allows for expansion, eliminating obsolescence and costly replacement as much as possible.
- 2. A “Standard” Written Key Control Policy:** Once you have a registered system, implementation is a critical key to maintaining a secure system. We highly recommend a standard template. We also recommend you issue the *Company Key Control Policy* when you issue new keys to every employee.

- 3. Documented Patented Key Control Technology:** Patented lock and key technology is assurance your investment will provide the highest rate of return. Patents protect you from unauthorized key duplication by preventing the manufacturing of key blanks.

BEWARE: “DO NOT DUPLICATE” OR SIMILAR WARNING STAMPED ON A KEY IS SIMPLY NOT ENOUGH PROTECTION!

- 4. Record keeping & Capability of Audit:** Each registered system cut key must have unique identification stamped on the bow, (numbers, letters or symbols). In your “Key Log”, record each key holder with the unique identification number found on the key. Each employee should sign for the key issued with the date noted for the record. Every key is identified as to each cylinder it will operate. This knowledge eliminates risk and when keys are found, it is easy to identify the key holder.



Key Control Management Package Available:

All the documents you need to set up and manage your HI-SECURITY™ Key System!

- 5. Process for Retrieving Keys When People Leave the Business:** Accounting for all the keys in the system eliminates the need and cost to re-key. By having people sign for the key when issued, and sign out upon return of the key, you are able to take inventory of all cut and assigned keys and assess risk...If you can account for all of the keys in the system, you simply re-issue an existing key number to a new user.

HI-SECURITY™ CYLINDERS

HI-SECURITY™ CYLINDERS & SECURITY-MATE™ CYLINDERS

SERVICE EQUIPMENT

Standard pin kits for standard cylinder construction are used, however Marks USA does make available specialty pins such as mushroom and hardened steel pins to add security. The plug size is the industry standard .050.

Key Depths	Bottom Pins	Spacing
0 = .335	0 = .165	1 = .246
1 = .320	1 = .180	2 = .402
2 = .305	2 = .195	3 = .558
3 = .290	3 = .210	4 = .714
4 = .275	4 = .225	5 = .870
5 = .260	5 = .240	6 = 1.026
6 = .245	6 = .255	
7 = .230	7 = .270	
8 = .215	8 = .285	
9 = .200	9 = .300	

Standard key cutting equipment for either originating a new key by code or duplicating an existing key may be used. An HPC Code Card (HSC387) is available. In addition technical data for cutting keys on ITL, Framon, etc. is also available. Soon a Pro-Lock Blue Punch will be made available. Standard cylinder keys are measured from the shoulder stop. From the shoulder to the center of the first cut the measurement is .246 and .0156 from 1-2, 2-3, 3-4, 4-5, 5-6.



These four cylinders will key up with standard pin tumblers



Medeco® Large Format IC Core



Marks Mortise & Mortise/Rim Combo Cylinder



Marks USA Key-In-Knob Cylinder



Schlage® Large Format IC Core

There is a special holding fixture that makes assembly of key-in-knob cylinders easier. Insert plug into the fixture, rotate plug to the "bottoms up" position, then begin inserting security finger pins. Insert pins by color code, sizes 1 through 4, then insert key (note there is not a shear line so pins will appear to be below the plug surface). Security finger pins are "position pins". Insert two springs, and sidebar...if the sidebar depresses allowing rotation of the plug, you are ready to rotate the plug 180° and load the traditional pin tumblers. Driver Pins may include mushroom and or hardened steel designs, however they are not necessary for operation, but enhance attempts to pick and bump.





Insert pins from bottom of plug

Plug with key, security finger pins and sidebar assembled. Insert loaded plug into the housing. You can either preload the housing using a following tool or remove the individual threaded retainer screws and load the bottom pins, drivers and springs from the top, the final step, inserting and tightening the individual threaded allen-wrench driven retainer screws.

NOTE: Use a 5 Pin key blank for 1" Mortise cylinder and use a 6 Pin key blank for 1-1/8" Mortise cylinder and up.



Plug with INCORRECT alignment (A visual test)



Plug with CORRECT alignment (A visual test)

HI-SECURITY™ CYLINDERS

HI-SECURITY™ CYLINDERS & SECURITY-MATE™ CYLINDERS

Small Format Interchangeable Core (SFIC)

EXPLODED VIEW

Marks USA Small Format Interchangeable Core (SFIC):

The cylinder plug within the SFIC contains four security finger pins. These non-spring loaded security finger pins along with random mushroom top pins make the Marks USA HI-SECURITY™ Cylinder virtually ***pick, drill and bump resistant***.

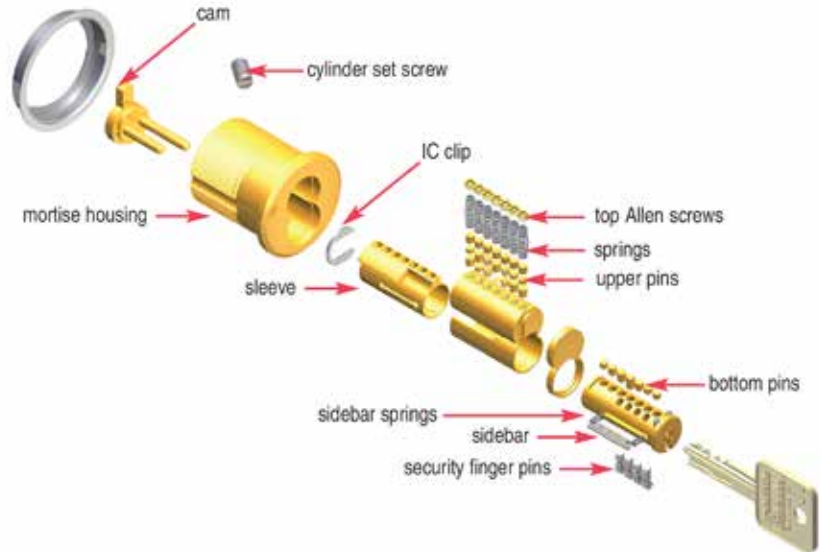

SIDEBAR & SECURITY FINGER PINS

Sidebar & Security Finger Pin Cautions

SFIC cores are equipped with four security finger pins due to the presence of the sidebar mechanism. Disassembly of the SFIC core is not recommended. If for some reason disassembly must be done, there are several cautions...First, the **Security finger pins will fall out if the key is not inserted**. Second, the **sidebar and springs will fall out if not held in place**. Third, the sidebar can be rotated, like the hands of a clock from right to left, **but do not reverse the sidebar...the sidebar is tapered on one side and flat on the other...if you reverse the sidebar, with flat side out, you lose the core, it locks in place**.



There are two springs that push outwardly against the security sidebar. Once the plug is removed from the shell, use caution as the sidebar and springs are free to fall from the plug. Here are the most important factors to consider if removing the plug from its shell:

1. **The four sidebar security finger pins are held in place ONLY if the key is in the plug.** If the key is removed when the plug has also been removed, the security finger pins will fall out from the bottom of the plug. Replacement and realignment may be done visually.

Security Finger Pin Replacement Procedure

If the security finger pins fall out of the plug, you can reinsert them. Keeping in mind that each pin has a specific location, replace the first security finger pin (your choice) and insert key. Make sure visually that the "open space" is visible in the sidebar area when the key is inserted. If a horizontal bar appears anywhere in the sidebar space, that particular security finger pin belongs in one of the other positions. Remove the key and let the security finger pin fall out the bottom, being ready to catch it. Continue placing that pin in another slot until the security wave of the key matches the security finger pin. Continue this process until the four pins align so the sidebar can be retracted. This should take a minimal amount of time.

2. The sidebar and its two springs will fall out if they are not held in place with the thumb and/or fingers.
3. **CAUTION:** The sidebar can be rotated (like the hands of a clock) 180° with no adverse effect. **However, it CANNOT be flipped 180°degrees (away from you).** If this is done, when the plug is reassembled, the core will remain in a permanent locked position and the plug cannot be removed. Thus, the core will have to be discarded as it will remain inoperable and can no longer be used. The reason is the tapered end is designed to rotate within the cylinder housing as it adapts to the circular contour. The squared edge that fits securely inside the slot of the security finger pin is not conducive to the same motion!

HI-SECURITY™ Cylinders & Security-Mate™ Cylinders

HI-SECURITY™ CYLINDERS

HI-SECURITY™ CYLINDERS & SECURITY-MATE™ CYLINDERS

ANOTHER KEY CONTROL OPTION

The Marks USA HI-SECURITY™ SFIC provides another keying advantage with its sidebar technology. Since a 7 pin key can be used to access both 7 pin and 6 pin cores of the same keyway, an alternative method of key control can be utilized. With minor shifting of the security finger pin arrangement (and discarding the security finger pin to the far right), 6 pin cores can be coordinated to work in conjunction with a 7 pin Marks key. Within a 6 pin core, a 7 pin key, with the example security wave of 1312 can operate the 6 pin core with security finger pin modifications. Because the 7 pin key will not be able to be fully inserted into a 6 pin core (of the same keyway), only the first three security finger pins will be used to operate the core - in this example it is 131. However, the security finger pins must be shifted in order from left to right within the plug to the following pattern: x131 (the x represents an empty security finger pin position).

Key Control Alternative

Using a 7 pin Marks USA HI-SECURITY™ SFIC in a 6 pin Marks USA HI-SECURITY™ SFIC (same keyway)

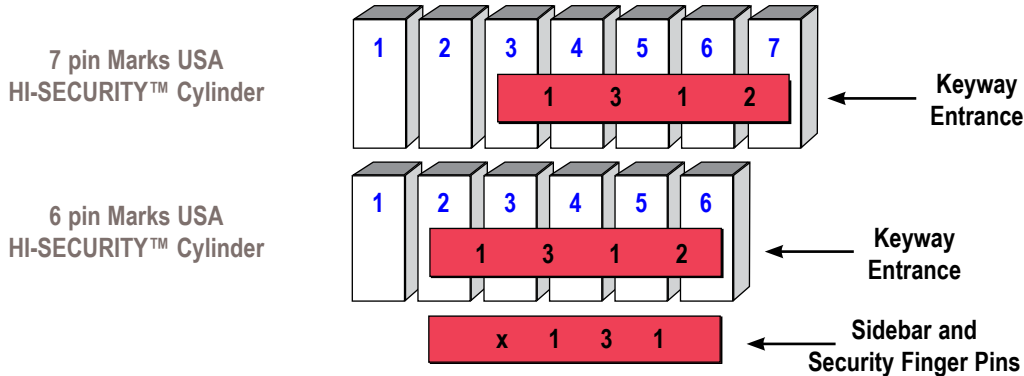

Adjusted security finger pin arrangement in the 6 pin core to allow the 7 pin Marks USA HI-SECURITY™ Key to operate it (same keyway) *x = Empty Position*

OPERATION & HARDWARE INSTALLATION

The Marks USA HI-SECURITY™ SFIC operates similarly to that of any standard small format core. Installing the Marks USA HI-SECURITY™ SFIC into existing other manufacturer SFIC hardware, the following two exceptions should be noted:

- When installing the Marks USA HI-SECURITY™ SFIC into an existing mortise housing, the left throw pin must be sheared in order to accommodate the security sidebar. This can be easily accomplished with the *Shear Tool* (# HSICT) available from Marks USA.

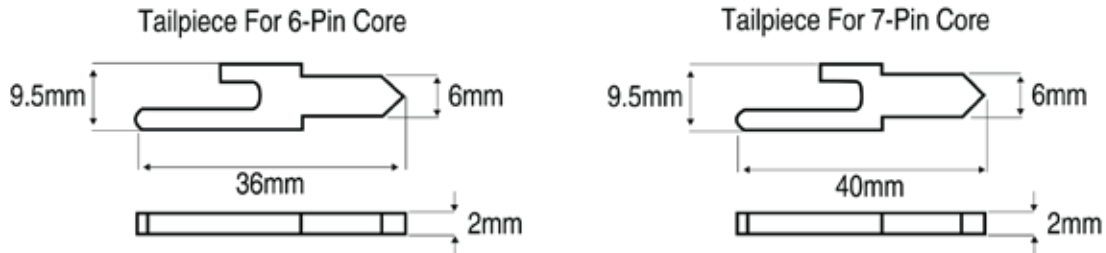

- When installing the Marks USA HI-SECURITY™ SFIC into a leverset, use the correct Marks tailpiece that matches the pin configuration of the core (6 pin or 7 pin).
- Kits available for HI-SECURITY™ IC Core Tailpieces: HR1984-HS for use with Marks Functions AB, B, DA (ext.), DW, F, FEU & FEL. HR1984S-HS for use with Marks Functions S, DA (int.), DB, DC, SB, T & TS. (See grid on page 9)

NOTE: One of the two throw pins must be sheared in order to accommodate the security sidebar. See the above illustrations.

COMPATIBILITY

The Marks USA HI-SECURITY™ Core can be used similarly as with any other SFIC with one exception: When using the Marks USA HI-SECURITY™ SFIC core in a pre-existing IC mortise housing, **one of the two throw pins must be sheared in order to accommodate the security sidebar.** This is the throw pin that aligns with the security sidebar. The Shear Tool can easily accomplish this task. It has been carefully designed to remove a small piece of the throw pin so that the core will fit properly into its mortise housing. This tool can be utilized when installing a 6 or 7 pin Marks USA HI-SECURITY™ core into its respective housing. The shear tool is quick and easy to use. Insert the brass "figure 8" drill guide into the cylinder housing cavity, tighten the allen head screw to secure one leg of the throw member to eliminate chattering, then insert drill cut through to stop. Loosen allen screw and remove. Insert SFIC.



HI-SECURITY™ CYLINDERS

HI-SECURITY™ CYLINDERS & SECURITY-MATE™ CYLINDERS

KEY BLANK OVERVIEW

Key Blank Orientation: It is generally accepted that SFIC key blanks are originated and gauged from the tip stop. This is true with Marks HI-SECURITY™!

Originating/Duplicating Marks USA HI-SECURITY™ Keys: Keys can be originated on standard key code cutting equipment. In addition, keys can be duplicated on any standard key duplicating machine. There exists an HPC card for those using HPC code card machines. The DSD for the HPC Blue Shark can be entered manually, using the Shoulder Stop reference. Since the security waves are factory controlled, the top biting is all that is necessary to duplicate or originate keys.

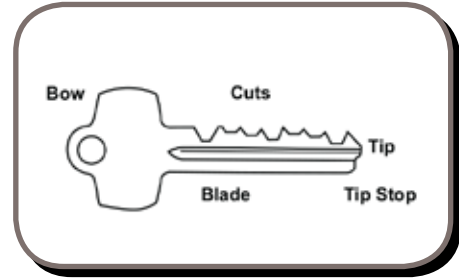

Ordering Key Blanks: Distribution of key blanks is carefully managed by authorized distributors. Within the standard product line, Marks USA HI-SECURITY™ technology offers over 900 Security Wave configurations for each keyway. Participating HI-SECURITY™ Wholesale Distributors have access to a common national security wave as well as several unique Dealer or End User based security waves. Any locksmith or institution that meets required quantities may purchase an exclusive Security Wave.

Key System Management:

A blank signature card with a random number is provided with each cylinder and may be used to file systems, identify authorized signatures and system registry for future use.

Key Blanks Lengths:

There is one key blank available for the Marks USA HI-SECURITY™ SFIC to accommodate both 6 and 7 pin cores. One note, the Marks USA HI-SECURITY™ key blank has shoulders on the tip stop key. (shown right)



KEY SPECIFICATIONS

Marks USA HI-SECURITY™ SFIC Key Spacing & Depth Specifications

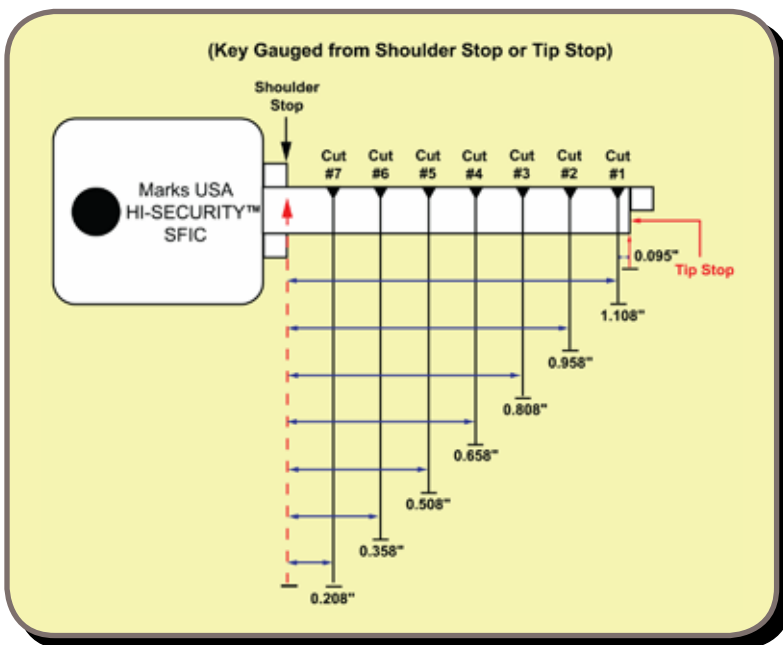

Cut Depth	Bottom Pin Length	Code
.3187	.1100.....	0
.3062	.1225.....	1
.2937	.1350.....	2
.2812	.1475.....	3
.2687	.1600.....	4
.2562	.1725.....	5
.2437	.1850.....	6
.2312	.1975.....	7
.2187	.2100.....	8
.2062	.2225.....	9
A2 Pin Increment = .0125"		
Pin Stack Total = .397"		
Coded Stack Length = 23		
Spacing of Cuts = .150"		
Root of Cut = .054"		
Angle of Cut = 90°		
Pin Diameter = .108"		

HI-SECURITY™ CYLINDERS

HI-SECURITY™ CYLINDERS & SECURITY-MATE™ CYLINDERS

PIN SPECIFICATIONS for the Marks USA HI-SECURITY™ SFIC

PIN SPECIFICATIONS:

Most SFIC systems follow the A2 System of pin depths created by BEST® Lock Company. It is by far the most common. The A4 System of pin depths is used especially when large numbers of key combinations are required. The A2 and A4 Systems are listed here. When ordering combined Marks USA HI-SECURITY™ cores from the factory, the A2 System is standard, and is the factory default when no pin increment system is specified.

A2 SFIC Pin Specification Chart

Two-Step Master Keying System - .0125" Increments

Key Depth	Bottom Pin Length	Coded Number
.3187	.1100	0
.3062	.1225	1
.2937	.1350	2
.2812	.1475	3
.2687	.1600	4
.2562	.1725	5
.2437	.1850	6
.2312	.1975	7
.2187	.2100	8
.2062	.2225	9

Wafer Pin Length	Coded Number	Wafer Pin Length	Coded Number
.0250	2	.1375	11
.0375	3	.1500	12
.0500	4	.1625	13
.0625	5	.1750	14
.0750	6	.1875	15
.0875	7	.2000	16
.1000	8	.2125	17
.1125	9	.2250	18
.1250	10	.2375	19

Pin Stack Total: = .397
Coded Stack Length: 23
Cut: TIP to BOW
Decoding: Subtract; 13 minus Code of Top Pin
Multiplier: Top Pin Length x 80 = Coded Length (rounded)
Root of Cut: .054
Angle of Cut: 90°
Pin Diameter: .108
Spacing (TIP to BOW from center of cut):
From Tip Stop, each cut:
#1 = .088
#2 = .238
#3 = .388
#4 = .538
#5 = .688
#6 = .838
#7 = .988

A4 SFIC Pin Specification Chart

Two-Step Master Keying System - .0121" Increments

Key Depth	Bottom Pin Length	Coded Number
.318	.110	0
.297	.131	1
.276	.152	2
.255	.173	3
.234	.194	4
.213	.215	5

Wafer Pin Length	Coded Number
.021	1
.042	2
.063	3
.084	4
.105	5
.126	6
.147	7
.168	8
.189	9
.210	10
.231	11

Pin Stack Total: = .404
Coded Stack Length: 14
Cut: TIP to BOW
Decoding: Subtract; 8 minus Code of Top Pin
Multiplier: Top Pin Length x 48 = Coded Length (rounded)
Root of Cut: .054
Angle of Cut: 90°
Pin Diameter: .108
Spacing (TIP to BOW from center of cut):
From Tip Stop, each cut:
#1 = .088
#2 = .238
#3 = .388
#4 = .538
#5 = .688
#6 = .838
#7 = .988



COMBINATING & CAPPING PROCEDURES

Combining (Pinning) the Marks USA HI-SECURITY™ SFIC is no different than other small format cores. It is assumed that you have the biting lists and pin segments for each chamber of every core. If you do not, you must secure this information or construct a system via mathematical calculations, slide charts, computer software or another appropriate source.



The basic combining procedure is as follows:

1. Use your Ejector Pin (or Downie Pin) and line up the shear lines in the empty core. Keep the aligning tool in place in the last chamber.
2. Insert the Bottom Pin in Chamber #1 after placing core loading block or on suitable device.
3. Insert the Master Pin or Control Pin next, depending on the keying structure. If the next pin is a small wafer, hold the core in your hand and tilt slightly to the side, watching the pin as it is placed so that it does not fall into the hole and turn sideways.
4. Insert the Top Pin.
5. Check that each pin has fallen to its lowest level in the chamber and is situated flat. Use Ejector tool to push down to even out the stack.
6. It is recommended you test each core with all keys or with finger atop chambers with springs inserted.
7. Place core into holder and secure each individual chamber with allen screws as seen in the image below.



HI-SECURITY™ CYLINDERS



HI-SECURITY™ CYLINDERS & SECURITY-MATE™ CYLINDERS

MARKS USA HI-SECURITY™ CAMS & TAILPIECES

MORTISE CYLINDER CAMS		
PART #	DESCRIPTION	
 2101HS	Straight Cam	
 2102HS	Clover Cam	
 2103HS	G - Cam	
 2104HS	Adams Rite Cam	
 2105HS	J - Cam	

Schlage® LARGE FORMAT IC CORE HOUSING CAMS		
PART #	DESCRIPTION	
 R2101-C	Straight Cam	
 R2102-C	Clover Cam	
 R2103-C	G - Cam	
 R2104-C	Adams Rite Cam	
 R2105-C	J - Cam	

CYLINDRICAL TAIL PIECES		
PART #	FUNCTIONS	
 F1903-C	AB, B, DA (ext.), DW, F, FEU & FEL	
 F1903S-C	S, DA (int.), DB, DC, SB, T, TS	

CYLINDRICAL IC CORE TAIL PIECES		
PART #	FUNCTIONS	
 HR1984-HS	AB, B, DA (ext.), DW, F, FEU, FEL	
 HR1984S-HS	S, DA (int.), DB, DC, SB, T, TS	

MARKS USA HI-SECURITY™ RETRO-FIT Key-In-Knob Tailpieces

The Marks USA HI-SECURITY™ Key-In-Knob Cylinder is assembled with the standard Marks tailpiece F1903-C as seen in the below photo.



HI-SECURITY™ Cylinders & Security-Mate™ Cylinders

HI-SECURITY™ CYLINDERS

HI-SECURITY™ CYLINDERS & SECURITY-MATE™ CYLINDERS

MARKS USA HI-SECURITY™ RETRO-FIT Key-In-Knob Tailpieces (cont'd.)

The NEW Marks USA HI-SECURITY™ RETRO-FIT Key-In-Knob Tailpiece Kit # K1103 is used with Marks USA HI-SECURITY™ Key-In-Knob Cylinders, thus enabling retrofit to a variety of key-in-knob or deadbolt lock cylinders using the screw cap retainer. The spacer creates appropriate space for replacement tailpieces to fit securely and operate smoothly when the cylinder is fully assembled.



Tailpieces used with the Marks USA HI-SECURITY™ Key-In-Knob Cylinders for key-in-knob or key-in-lever locksets include the F1903-C for Marks AB, B, DA (ext.), DW, F, FEU & FEL functions; The F1903S-C for Marks S, DA (int.), DB, DC, SB, T & TS functions.

The three new tailpieces (shown right) retrofit a variety of other locksets. Spacer 1360-F19 is included as well providing for smooth operation and secure fastening when accommodating replacement tailpieces.

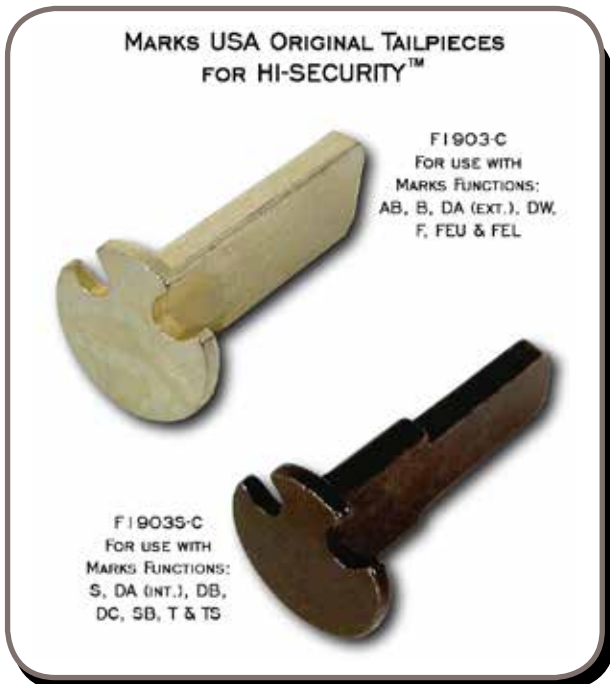

Marks USA original tailpieces (shown left) for use with the 10, 70, 80 & 95 Lines are constructed as a single piece, unlike many replacements that are two pieces.



MARKS USA

Distributed By:



*MARKS USA is a manufacturer of
BHMA certified locksets.*

Marks USA • 365 Bayview Ave. • Amityville, NY • 11701
800-645-9445 • Fax: 631-225-6136
salesinfo@marksusa.com • www.marksusa.com