

# Assemble Instruction of Geeetech Acrylic Prusa I3 pro B

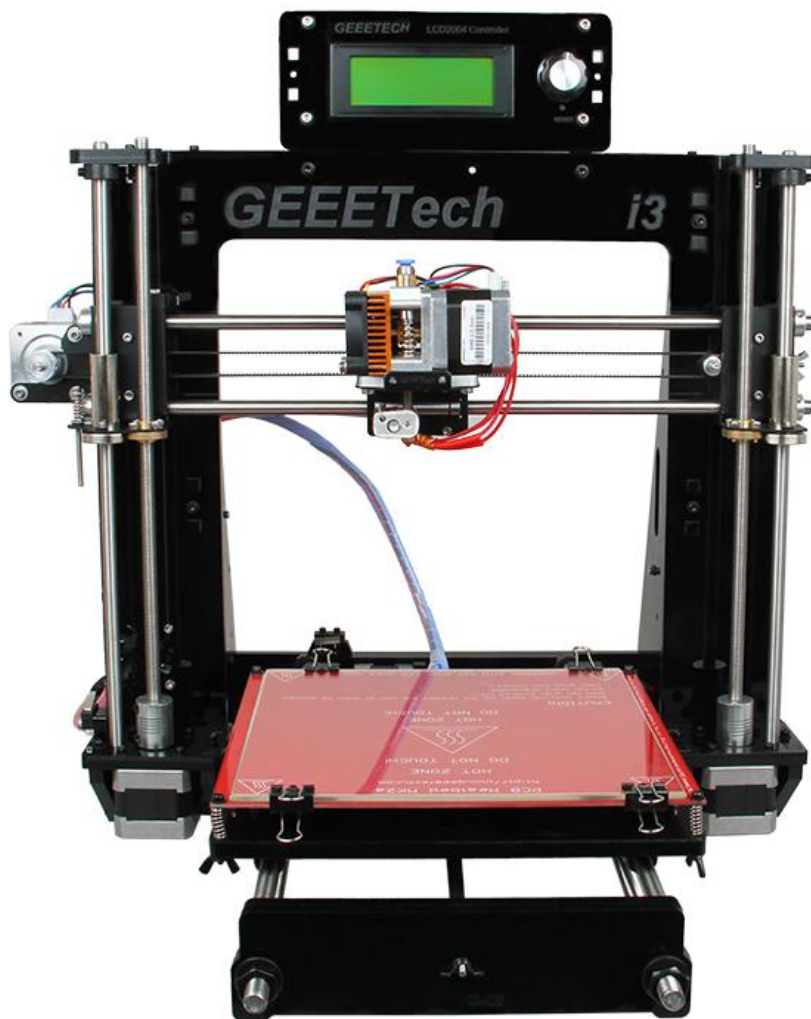

Version 04-11-2016

## **Safety Instructions**

Building the printer will require a certain amount of physical dexterity, common sense and a thorough understanding of what you are doing. We have provided this detailed instruction to help you assemble it easily.

However ultimately we cannot be responsible for your health and safety whilst building or operating the printer, with that in mind be sure you are confident with what you are doing prior to commencing with building or buying. Read the entire manual to enable you to make an informed decision.

Building and operating involves electricity, so all necessary precautions should be taken and adhered to, the printer runs on 12V supplied by a certified power supply, so you shouldn't ever have to get involved with anything over 12V but bear in mind there can still be high currents involved and even at 12V they shouldn't be taken lightly.

High temperatures are involved with 3D Printing, the Extrusion nozzle of the hot end can run about 230 °C, the heated bed runs 110 °C and the molten plastic extruded will initially be at around 200 °C, so special care and attention should be made when handling these parts of the printer during operation.

We wouldn't recommend leaving your printer running unattended, or at least until you are confident to do so. We cannot be held responsible for any loss, damage, threat, hurt or other negligent result from either building or using the printer.

## **Preparation**

1. Unpack the kit and check if all parts are in the box and check the condition of each part, there might be some damage during shipping. To help you with this, there is BOM in the box and each bag was labeled with part number.
2. Contact our customer service immediately by email or through the website if you find any missing or damaged parts. And on the bottom of the BOM, there is a signature of reviewer, please take a picture of it and attach the picture in your mail.
3. Read through each chapter of these instructions to gain an over-all idea of what is involved and how long it might take, before starting on the work described.
4. Before you start, you can put all the part in order to save your time especially those screws and nuts. Do not mix them up.
5. Ensure you have the necessary skills to carry out the work, or enlist the help of someone who does.
6. Work on a big firm table or bench in a clean dry well-lit area.
7. This kit contains tiny parts; please keep them away from kids under 3.
8. Ask for help if you run into any problems - our contact details are on the website and we will always do our best to resolve any problems encountered.

## 1 Unfold the box and check the package

Unfold the package and take all the parts out to check the condition of the items. As you can see, all the parts are packed very carefully.

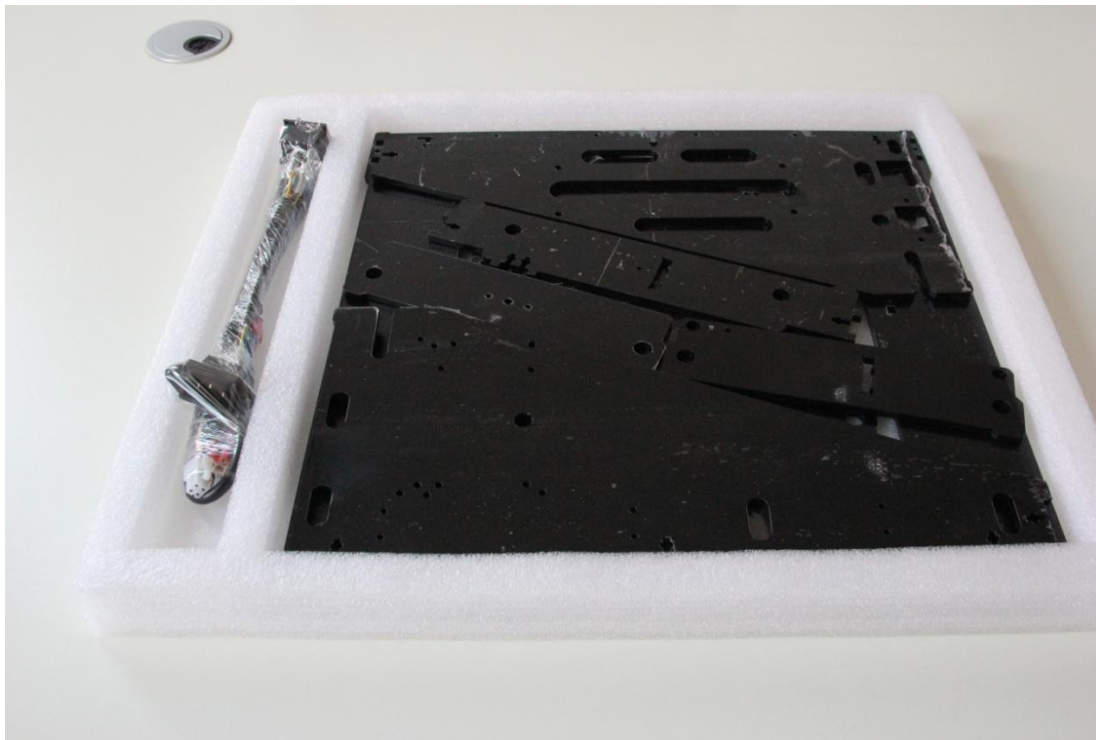

- All the acrylic plate has been etched with part ID and the plate is covered with a sheet of Kraft paper, you need to tear them off.

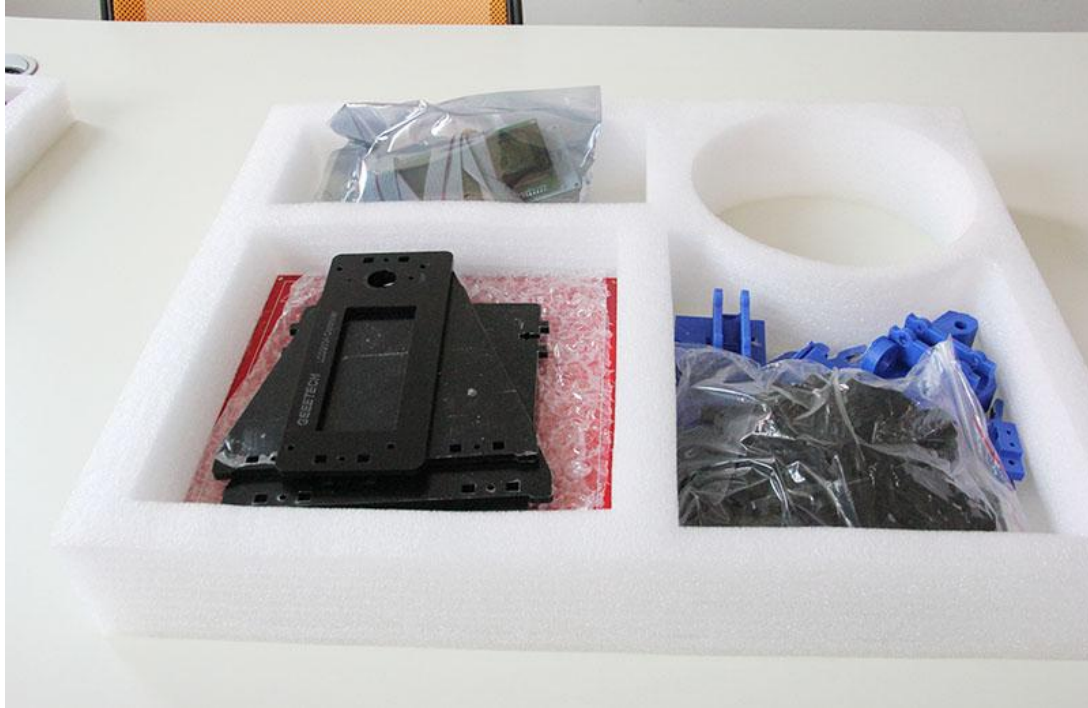





**Tips:**

1. Before assembly, you are advised to put all the parts, especially the screws and nuts in order, which will save you a lot of time looking for the required parts.
2. The part ID is corresponding to the number labeled on the bag of every part. Some parts may not have label, you can refer to the pictures on the package list.

**2 Assemble the rods of a Y axis**

[Watch the video](#)

Step1. Assemble the 2 threaded rods.

Required parts	Required number	Part ID	Pic
M10 threaded rod	2	NO.5	
Y plate connecting plate	2	NO.A14	
M10 spring washer	6	NO.19	
M10 washer	8	NO.9	
M10 nut	8	NO.13	

Thread the nuts and washers into the two M10 threaded rods separately. The order should be:

- 1) Thread the Y plate connecting plate A14 in the middle.
- 2) Thread the M10 washer > M8 spring washer >M10 nut > M10 nut > M10 washer

on the left

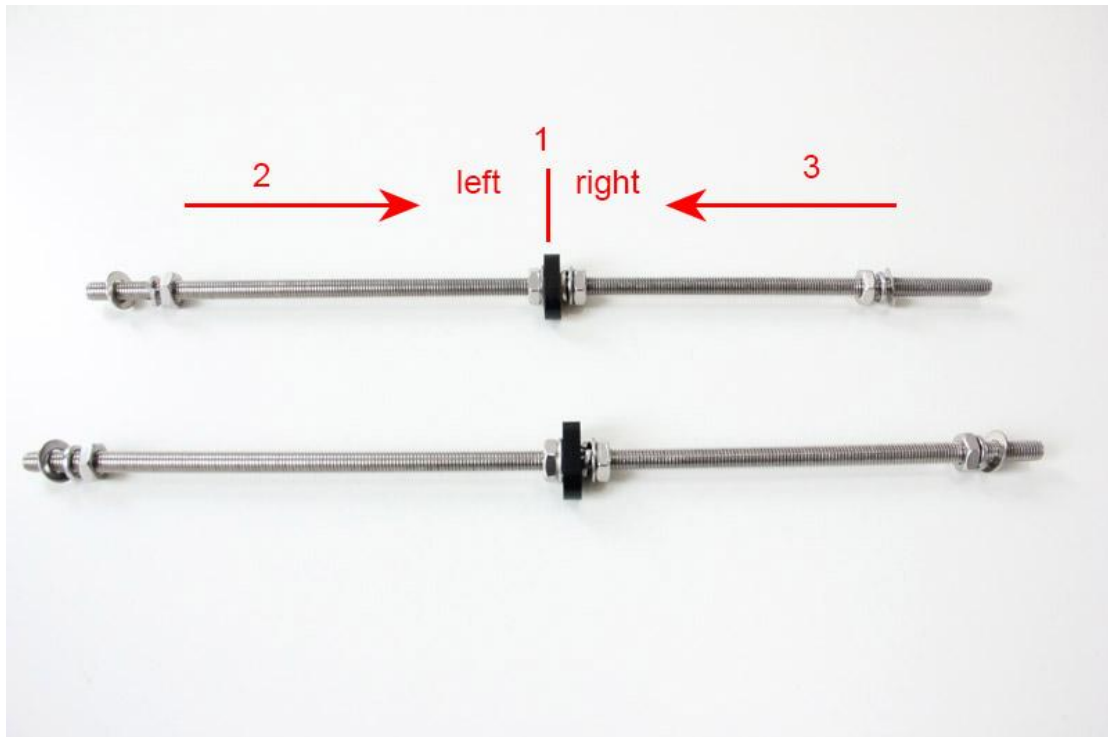

3) Thread the M10 washer < M8 spring washer < M10 nut < M10 nut < M8 spring washer < M10 washer on the right

4) repeat the above steps for another threaded rod.

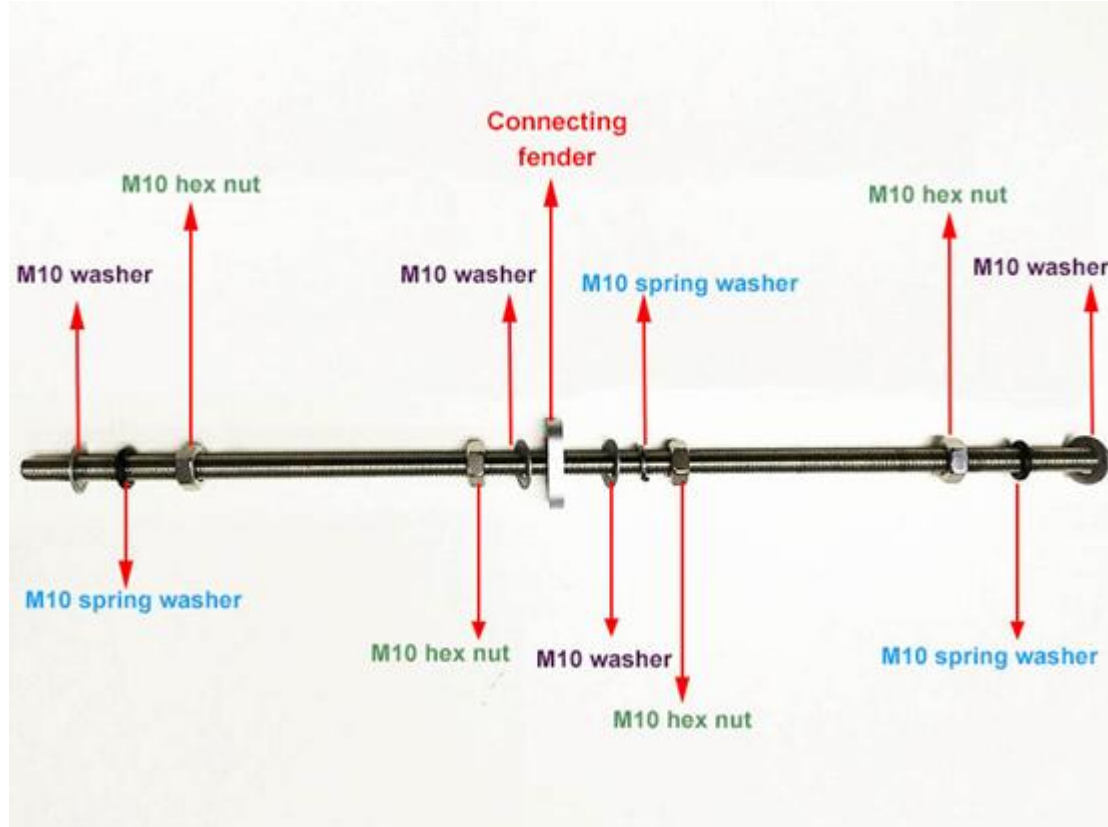



Step2. Assemble the 2 smooth rods

Required parts	Required number	Part ID	Pic
M8 smooth rod	3	NO.3	
LM8UU Linear bearings	4	NO.36	

Take out the 410mm smooth rod

Slide 2 Linear bearings on each smooth rod. Before you slide the bearings please make sure they are clean.









### **3 Attach the front and rear support plates**

[Watch the video](#)

For some of the kit, the locking rings are the silver color, which will not affect the assembly here, but in some steps, for the X axis, there is difference, please pay attention to the note.

Required parts	Required number	Part ID	Pic
Acrylic plate( front)	2	NO. A9, A 10	
Acrylic plate( rear)	2	NO. A 11, A 12	
M10 washer	4	NO.9	
M10 nut	4	NO.13	
locking ring	2	NO.20	

Step1.Slide the **locking ring** on the smooth rods, thread the rods into the acrylic plate; adjust the length so that the smooth rods fit snugly between the front and rear piece.

Step2. Screw up the rods and plate with M10 nut and M10 washer.

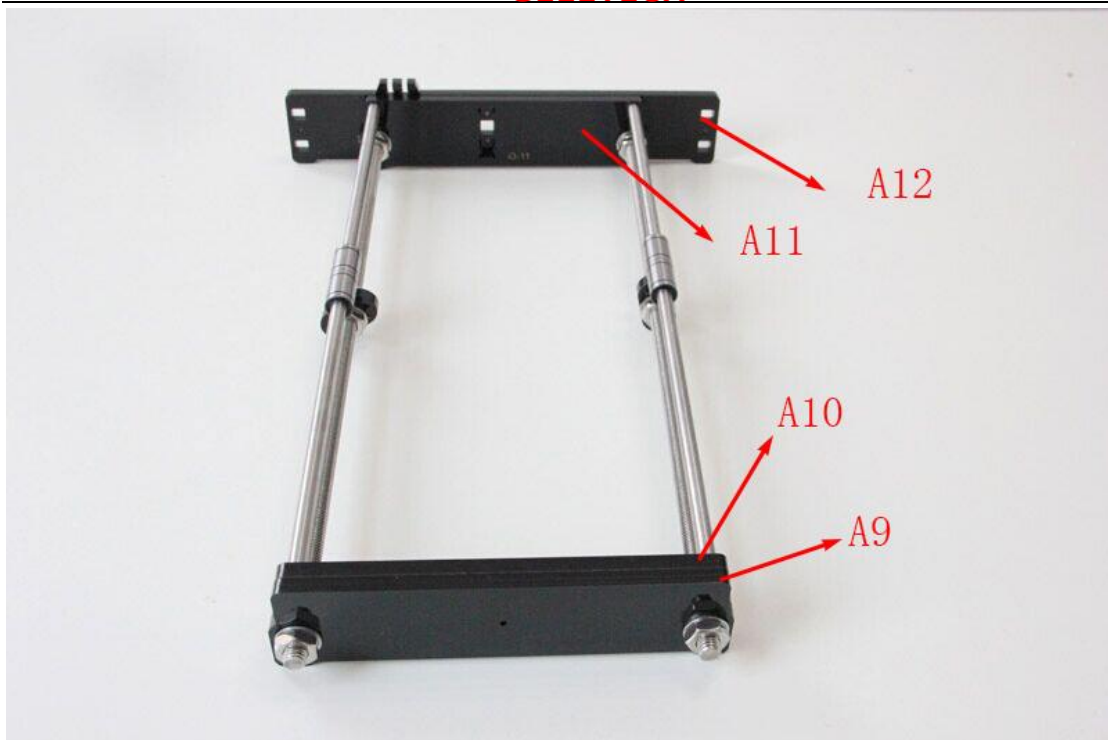







\* **Tips:** Try to keep the rods parallel and the four acrylic pieces parallel. The Y-axis must be a rectangle, that is the rods on both side should be parallel, so is the front and back plate. Otherwise it will cause obstruction for the belt later. You can use a Digital Caliper to measure.

\***Note:** As we re-designed the rear plate, there are two more holes on A12, in this case, you need to use the screw locking ring to fix the smooth rod.

#### 4 Assemble the Y idler

[Watch the video](#)

Required parts	Required number	Part ID	Pic
Ball bearing	2	NO.46	

bearing holder	1	NO.41	
Driven wheel	1	No.45	
M3 x 20 screw	1	NO.28	
M3 wing nut	1	NO.16	
M4 x25 screw	1	NO.33	
M4 lock nut	1	NO.15	

Step1. Thread the M3 x 20mm screw through the bearing holder.

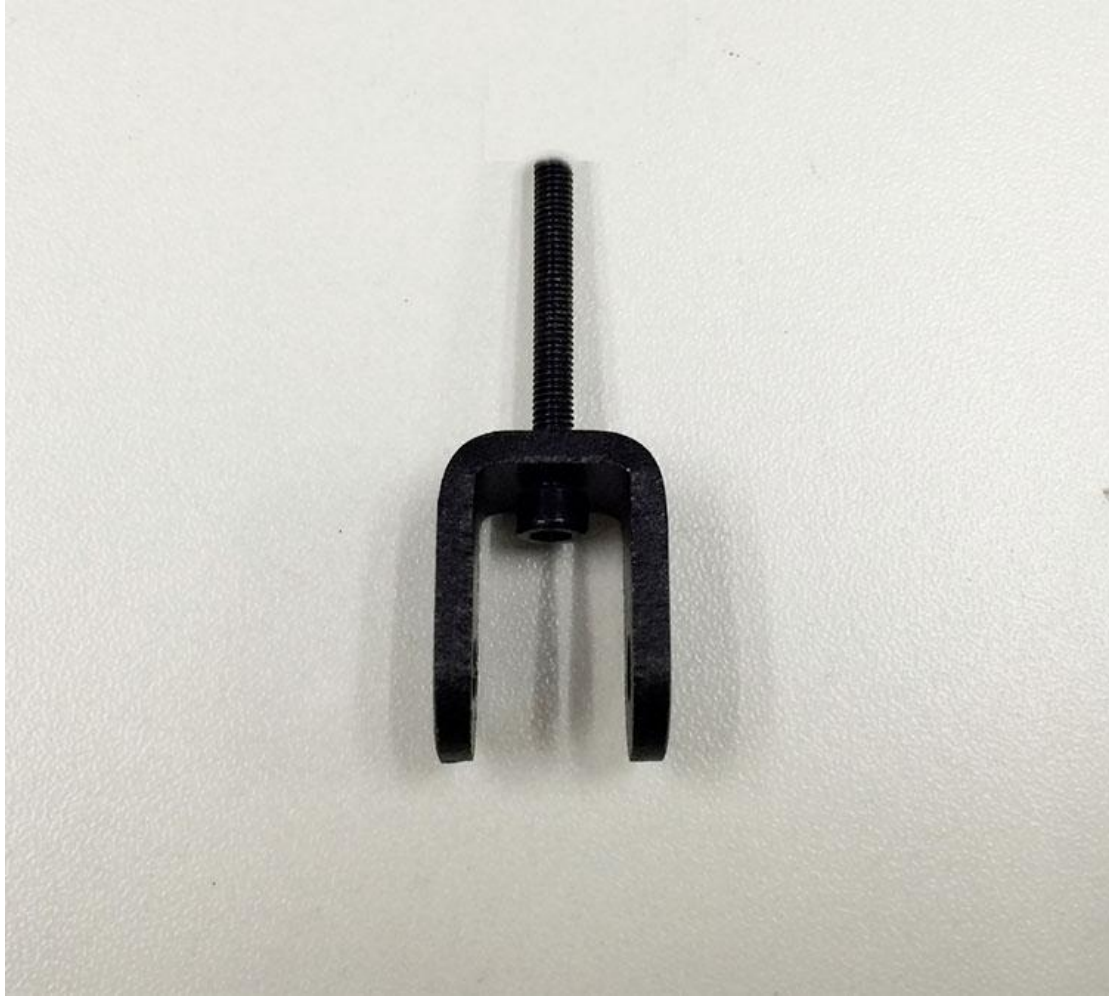

Step2. Insert the two MR84zz ball bearings into both ends of the driving wheel.

For your convenience, this step is already finished by us.

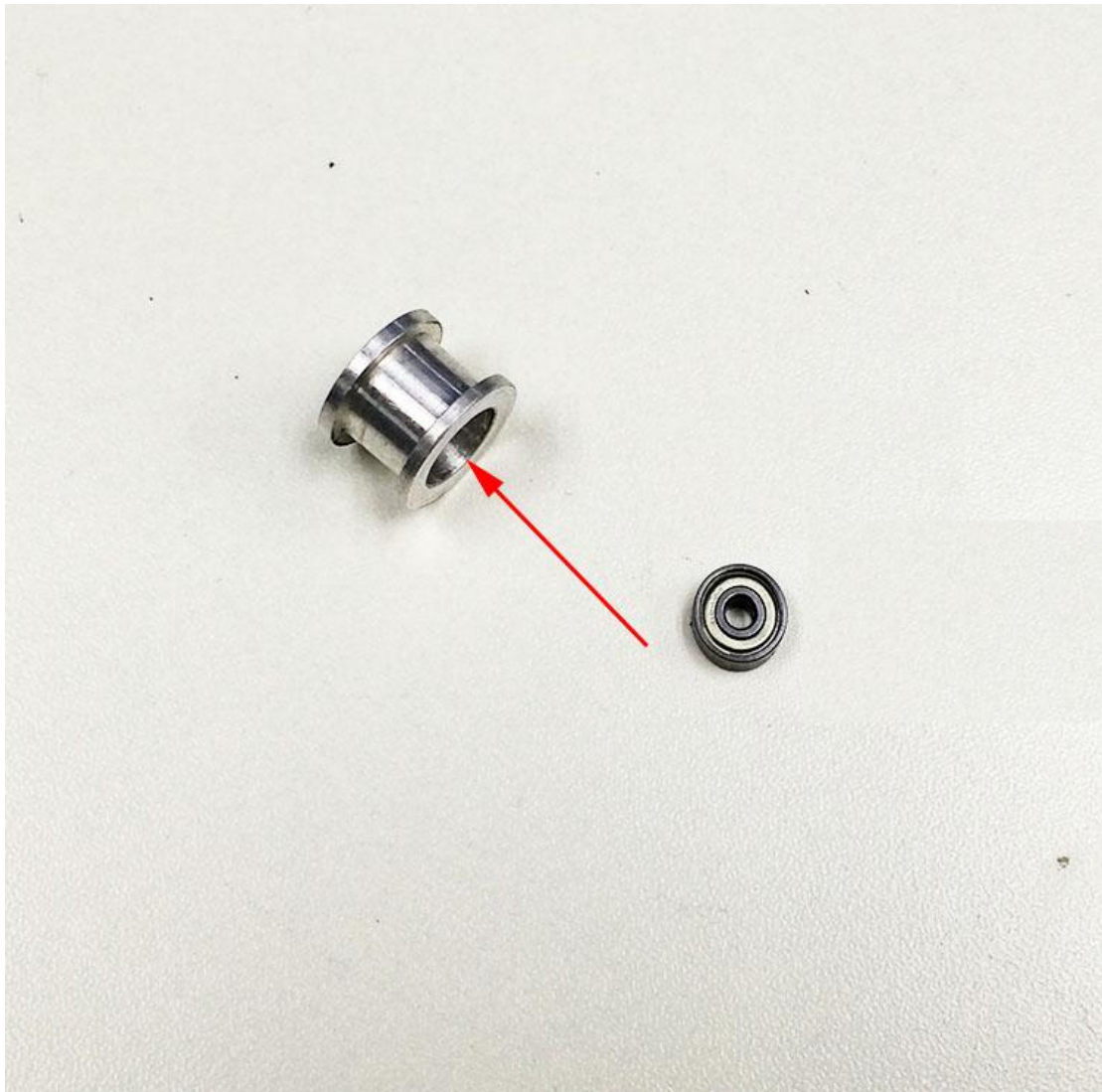



Step3. Put the M4 x25 screw and M4 washer through the driving wheel. Lock the other end with a M4 lock nut. You may need a wrench to tighten locking nut.









\*Do not screw it too tight, you should leave enough room for the wheel to turn freely.

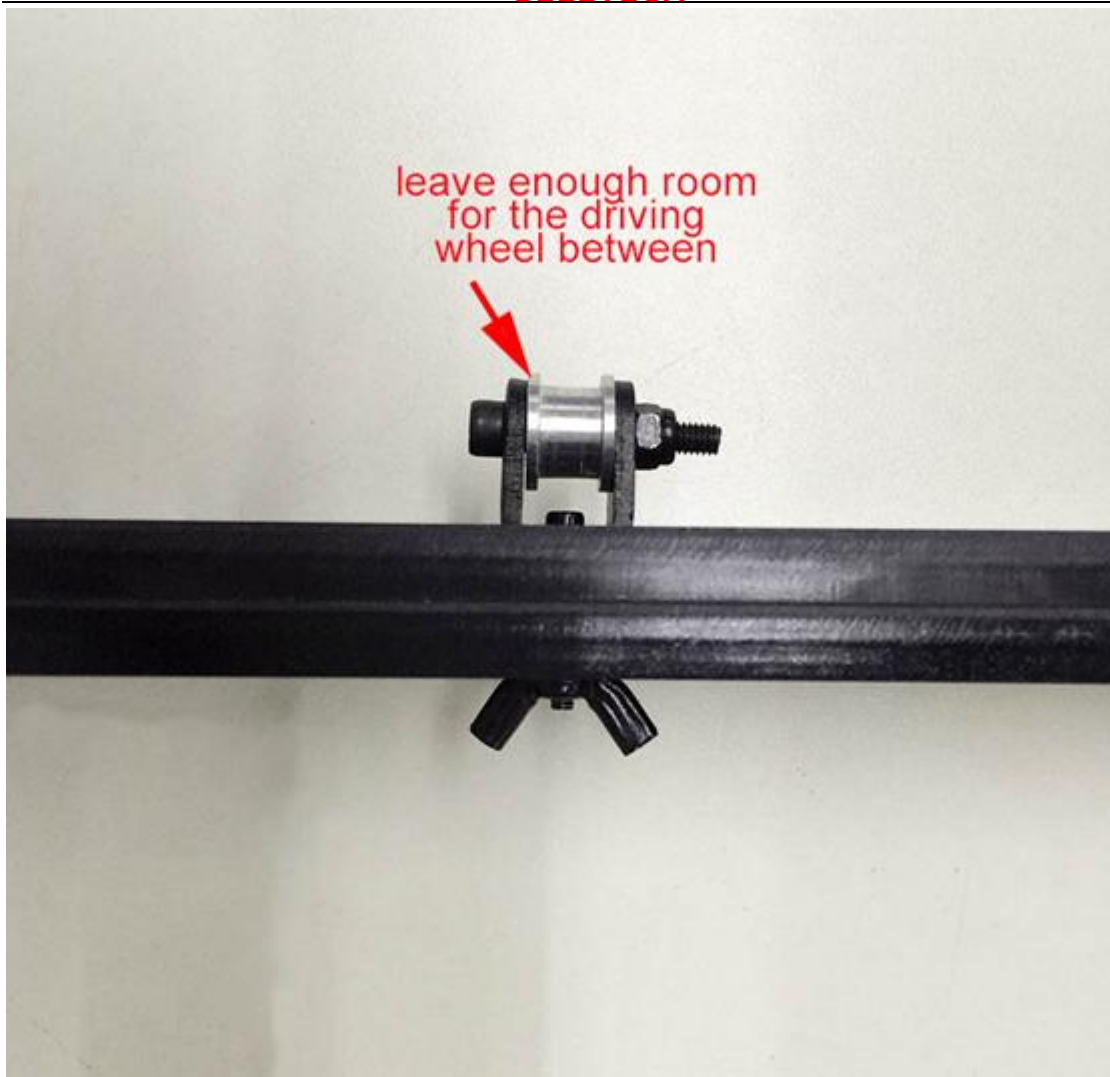



Step4. Mount the assembled bearing holder onto the front support plates from inside to outside. And screw it with a wing nut.



### 5 Mount the Y motor

[Watch the video](#)

Required parts	Required number	Part ID	Pic
Y motor fix plate	1	NO. A13	

Stepper motor	1	NO.62	
Pulley	1	NO.44	
M3 x 12 screw	3	NO.26	
M3 x 20 screw	2	NO.28	
M3 square nut	2	NO.17	

Note: In some picture, the pulley is a bit different but it won't affect your assembly.

Step1. Mount the pulley on the motor shaft, one of the screws should be screwed on the flat side of the shaft. Screw it as tight as possible.

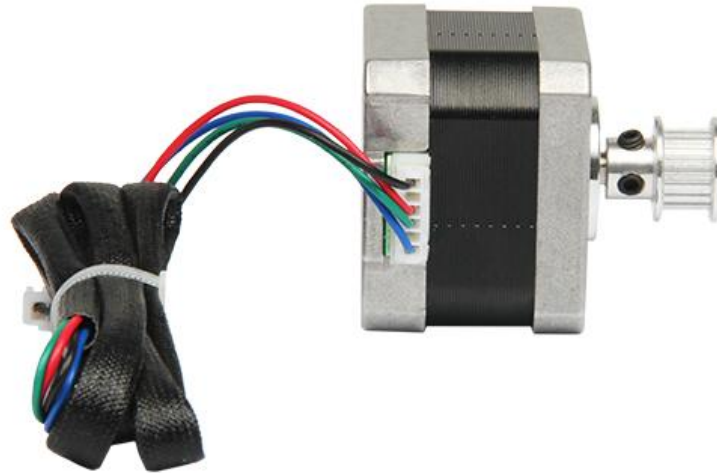

Step2. Then screw the motor on the Y motor holder with 3 M3 x 12 screws and M3 washers.

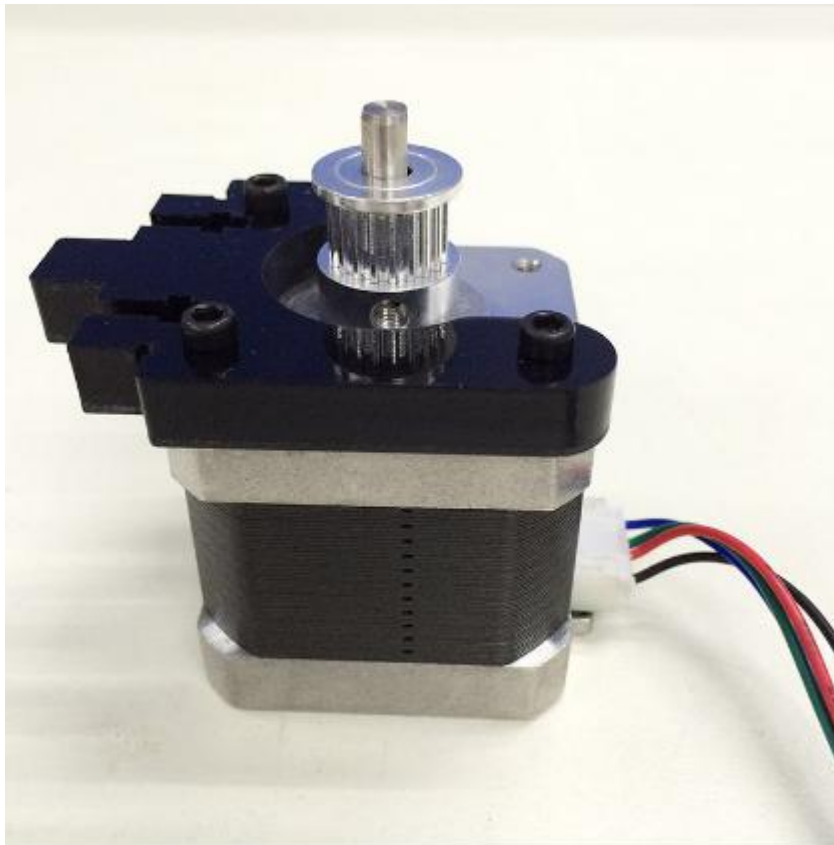

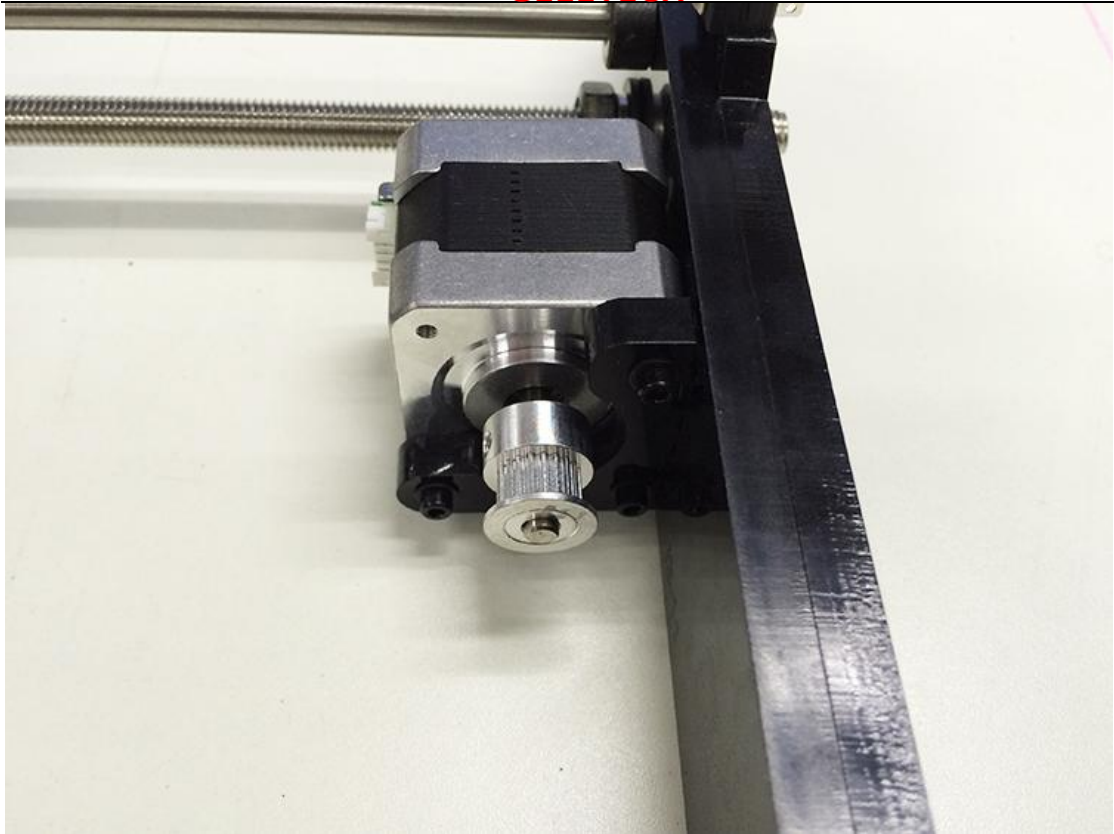

Step3. Push the Y Motor holder tab into the square hole in Rear -Outside Plate and Rear - Inside Plate. You may need to use a little force, but be careful not to break or crack any of the Acrylic pieces.

Secure the Y Motor holder with 2 **M3x20mm** screws, M3 Washers and M3 Square Nuts.



## 6 Build the printing platform

[Watch the video](#)

Required parts	Required number	Part ID	Pic
Y platform support	1	NO.A15	
Y bearing block	4	NO.A16	

Belt mount	1	NO.42	
Nylon tie	4	NO.66	
M3 x 10 screw	2	NO.25	
M3 x 20 screw	8	NO.28	
M3 nut	8	NO.11	

Step1. Mount the belt mount on the bottom side of the platform with 2 M3 x 10 screws.

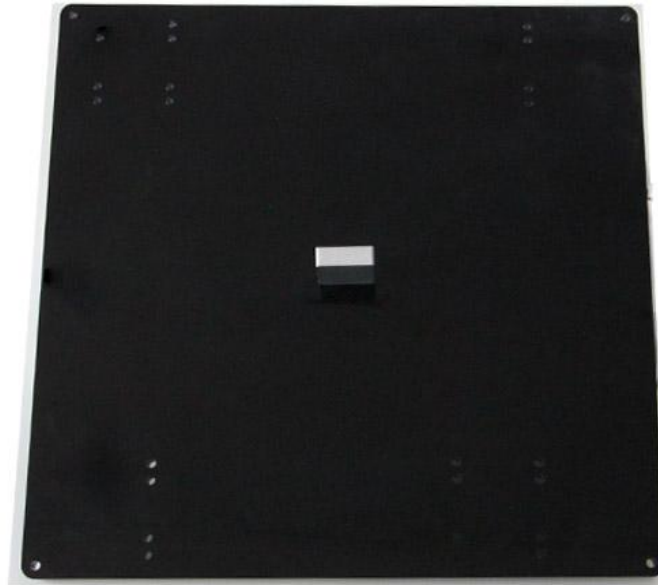

Step2. Mount the 4 bearing blocks on the platform with M3 x 20 screws on the same side with the belt-mount. Screw with M3 nuts.



Step3. Get the build platform plate zip-tied to the 4 linear bearings of Y- Axis.

**\*The belt-mount and the fenders are under the platform.**





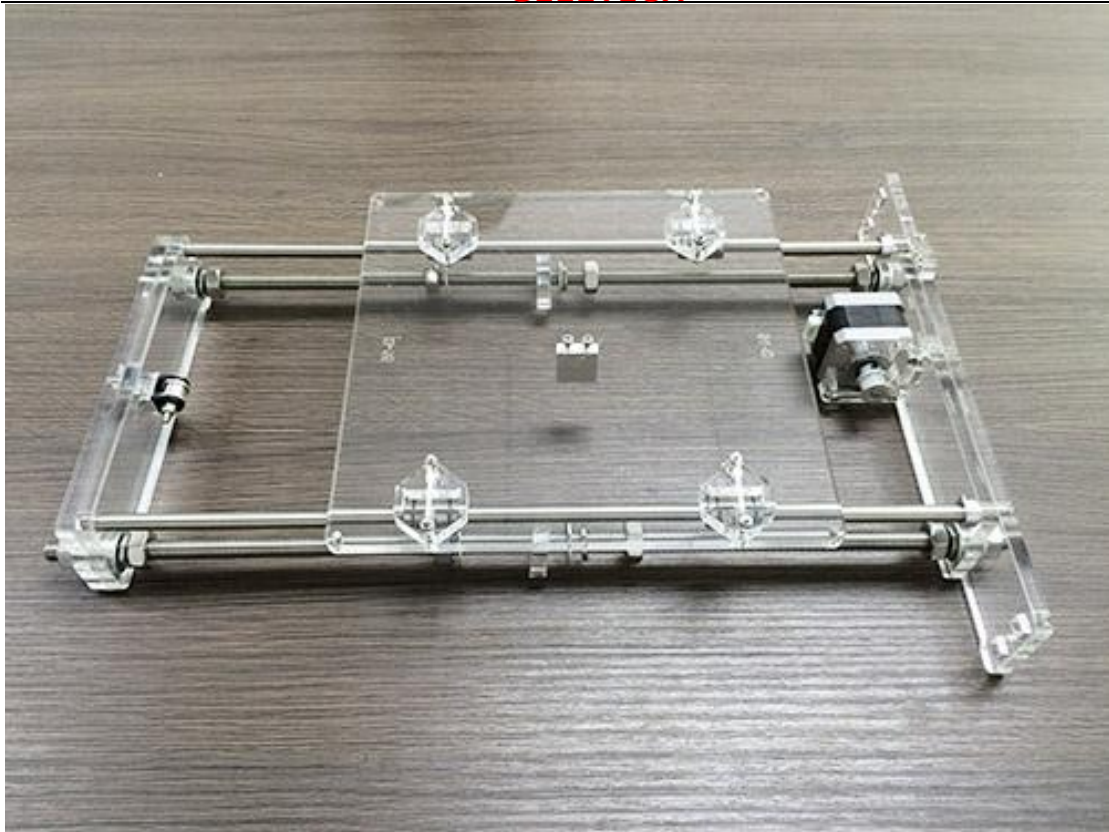



## 7 Mount the Y –axis belt

[Watch the video](#)

Required parts	Required number	Part ID	Pic
Timing belt	1	NO.39	
M3 x 10 screw	2	NO.25	
M3 washer	2	NO.7	

Step1. Drill a hole on one end of the belt (the hole can be as the diameter of the M3 screw, leave enough margin )

Step2. Fix the belt on one side of the belt -mount with a M3 x 10 screw and washer.

Step3. Thread the belt around the driven wheel on the motor and the Y idler.

Step4. Drill a hole on the other end of the belt and fix it on the belt -mount with a M3 x 10 screw and M3 washer.

**\*Tips:**

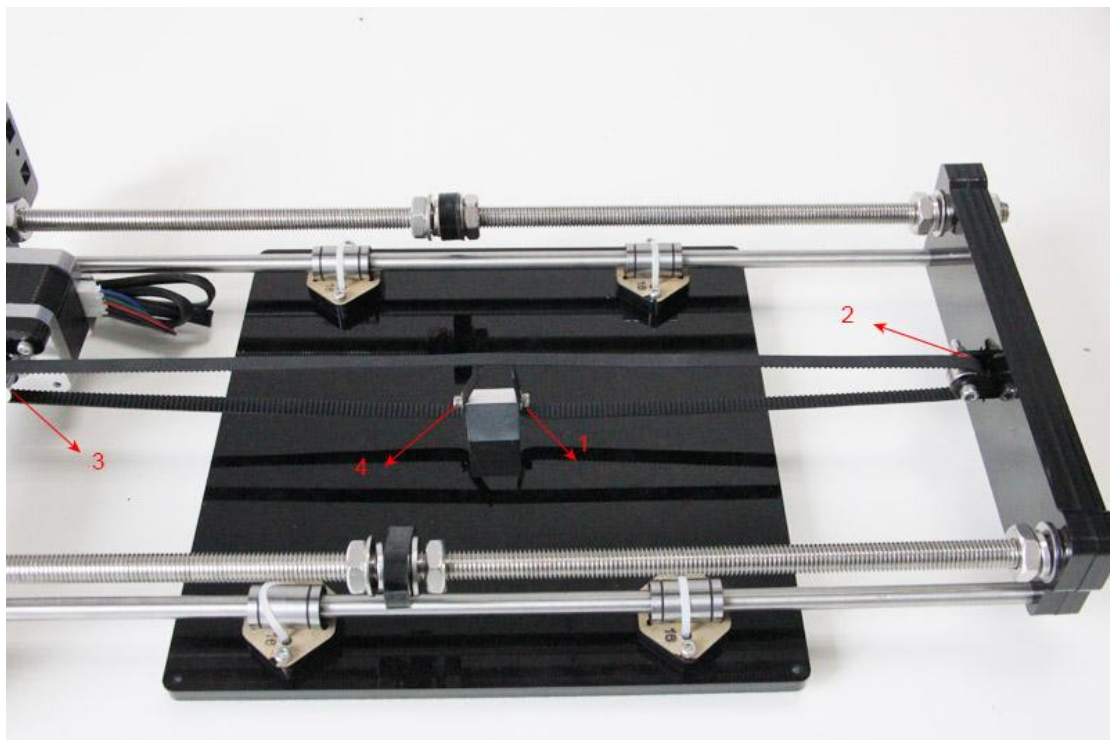

1. before you drill your second hole, make sure to pull belt tightly to make sure to find proper placement of hole for a tight belt, if it is too loose, it will hinder the move of the print platform.

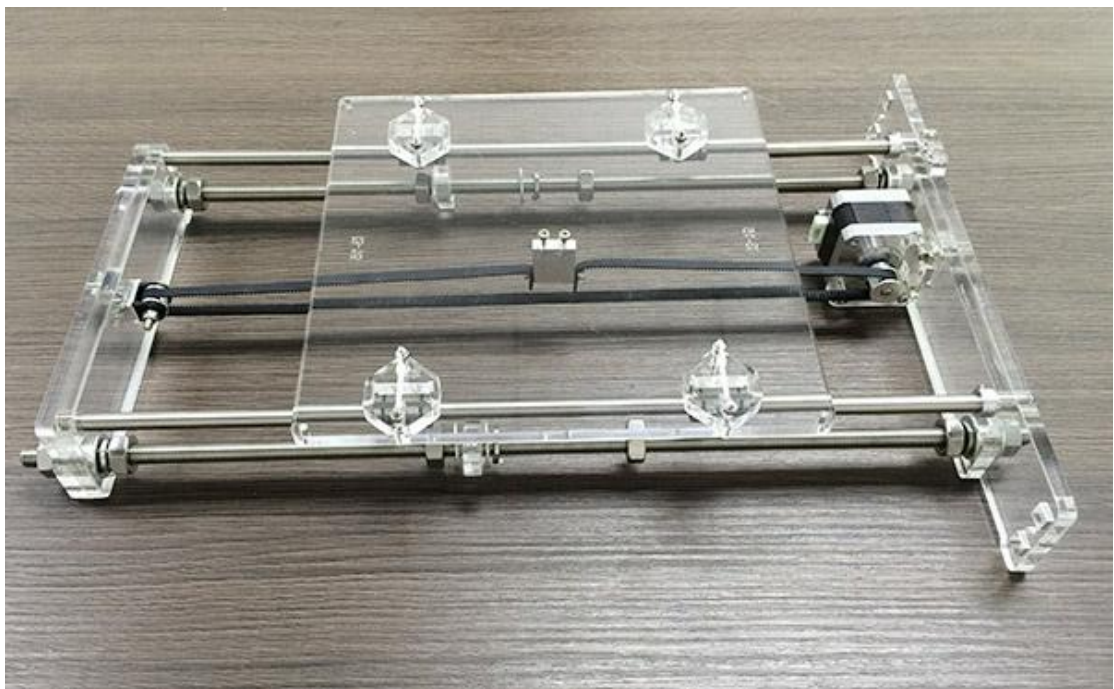
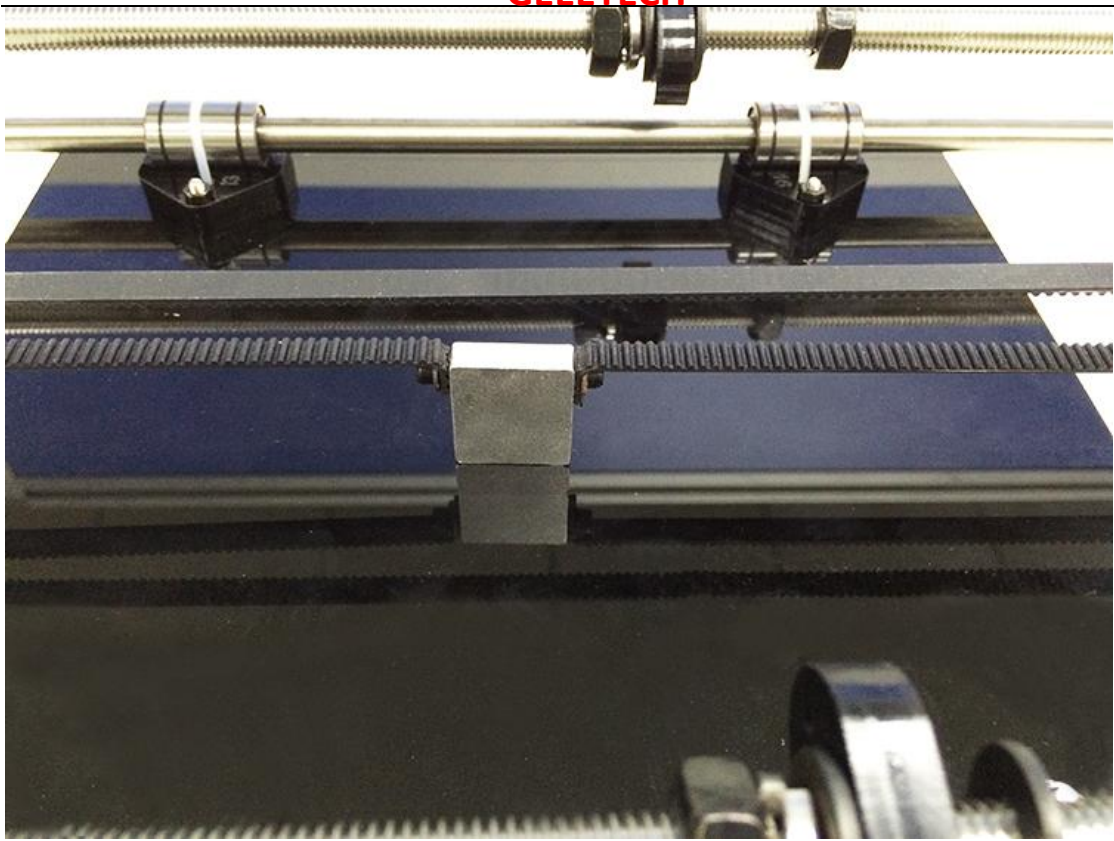



**8 mount the End stop of Y-axis**

[Watch the video](#)

Required parts	Required number	Part ID	Pic
End stop	1	NO.56	
M2.5 x 16 screw	2	NO.22	
M2.5 Hex nut	2	NO.10	



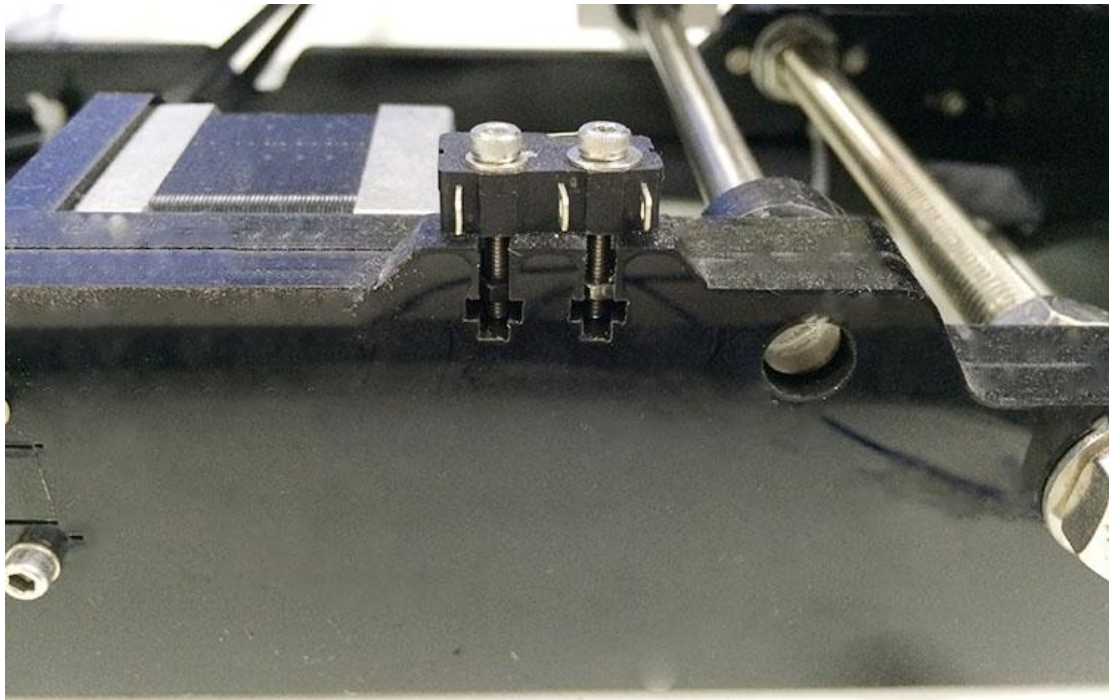

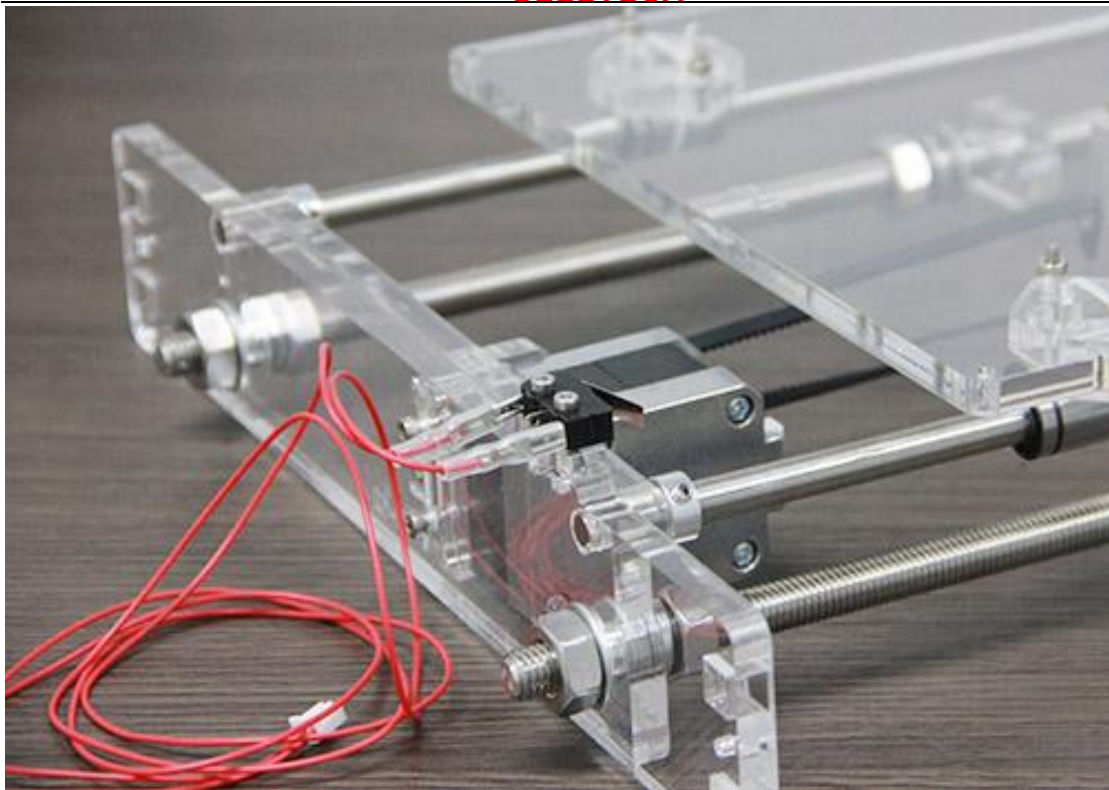
Mount the end stop on the rear support plate of Y axis with M2.5 X 16 screw and M2.5 Hex nut.





**9 Assemble the right and left side panel**

[Watch the video](#)

Required parts	Required number	Part ID	Pic
XZ frame	1	NO.A1	
Acrylic left frame	1	NO.A2	
Acrylic right frame	1	NO.A3	
M3 x 16 screw	6	NO.27	

M3 square nut	6	NO.17	

Step1. Screw up the X-Z frame and the side panel with M3 x 16 screws and M3 square nuts.

If the holes not fit, please use the file to trim it.





**10 Mount the fan**

[Watch the video](#)

Required parts	Required number	Part ID	Pic
----------------	-----------------	---------	-----



Fan	1	NO.53	
M3 x 30 screw	4	NO.29	
M3 locknut	4	NO.14	



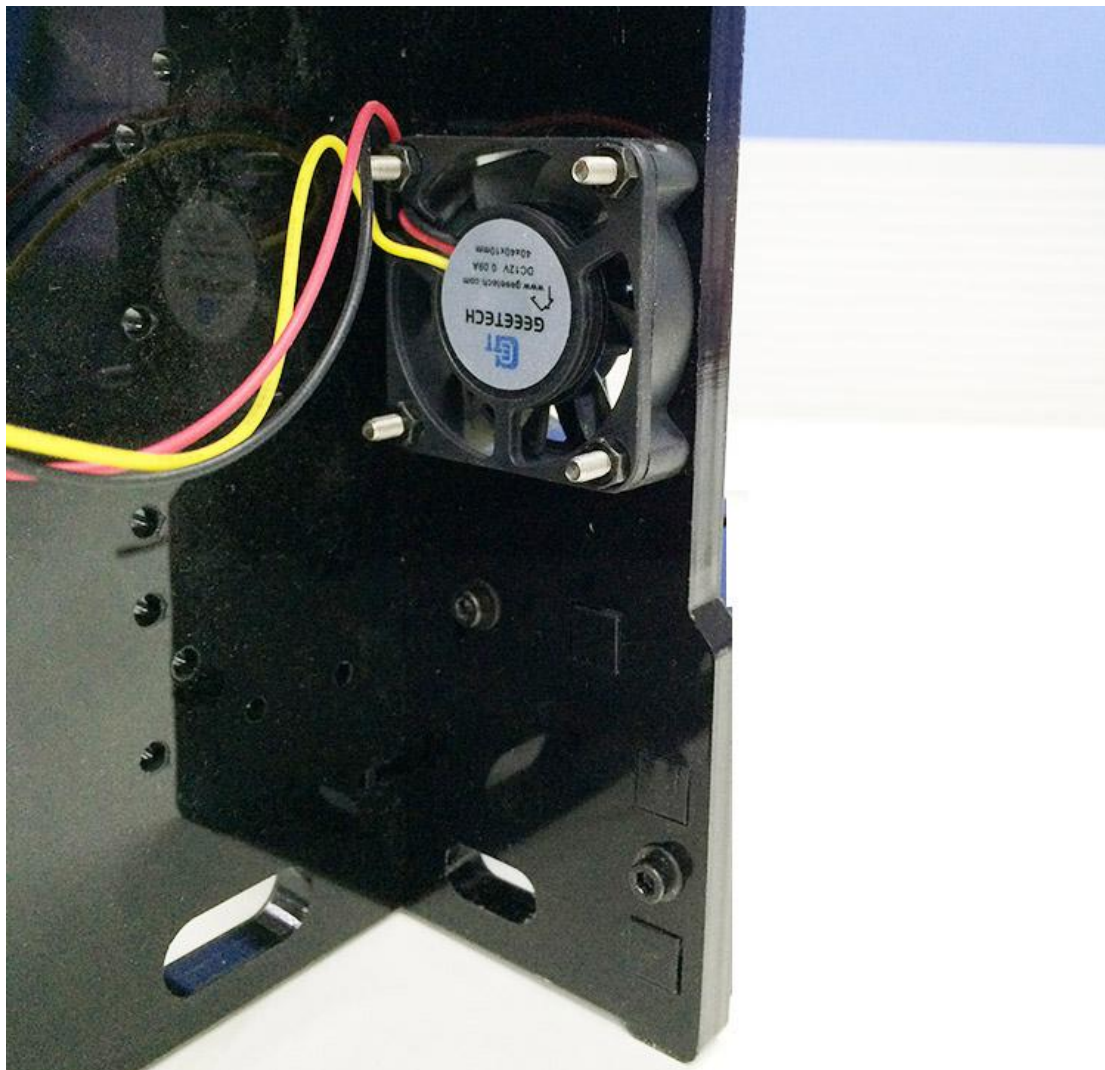

Fix the fan on the left side of the frame with 4 M3 x 30 screw and lock nut. Mind the direction of the wires. (Please pay attention to the direction of the fan)

If you don't want to use the lock nut you can use hex nut.

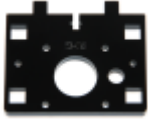

### 11 Assemble the Z-axis bottom mount

[Watch the video](#)

Required parts	Required number	Part ID	Pic
Z Motor fixed plate	1	NO.A4	
Z Motor fixed plate	1	NO.A5	
Z Motor support plate	3	NO.A6	
Z Motor support plate	1	NO. A7	
M3 x 16 screw	10	NO.27	
M3 square nut	10	NO.17	

Step1. It would be easier to mount the A4/A5 to A6 and A7 first, and then mount the assembled part to A1.

Step2.Screw up the acrylic plates with M3 x 16 screws and M3 square nuts.



\*The right and left bottom mount are different; Please look at the following picture.

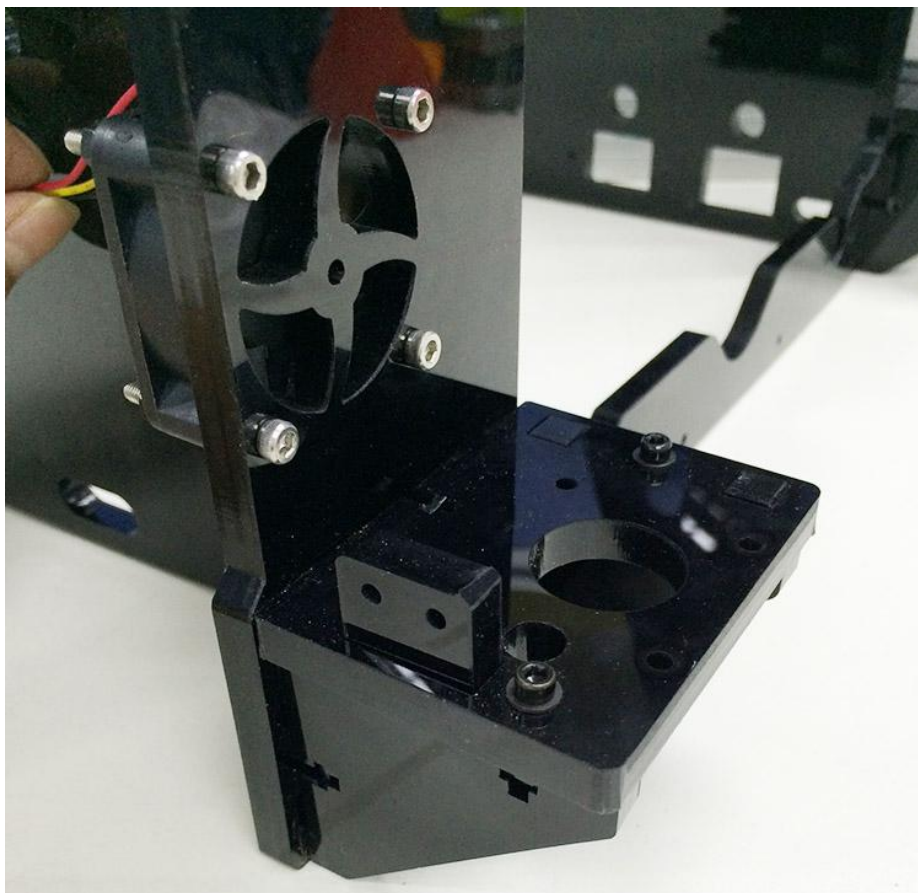



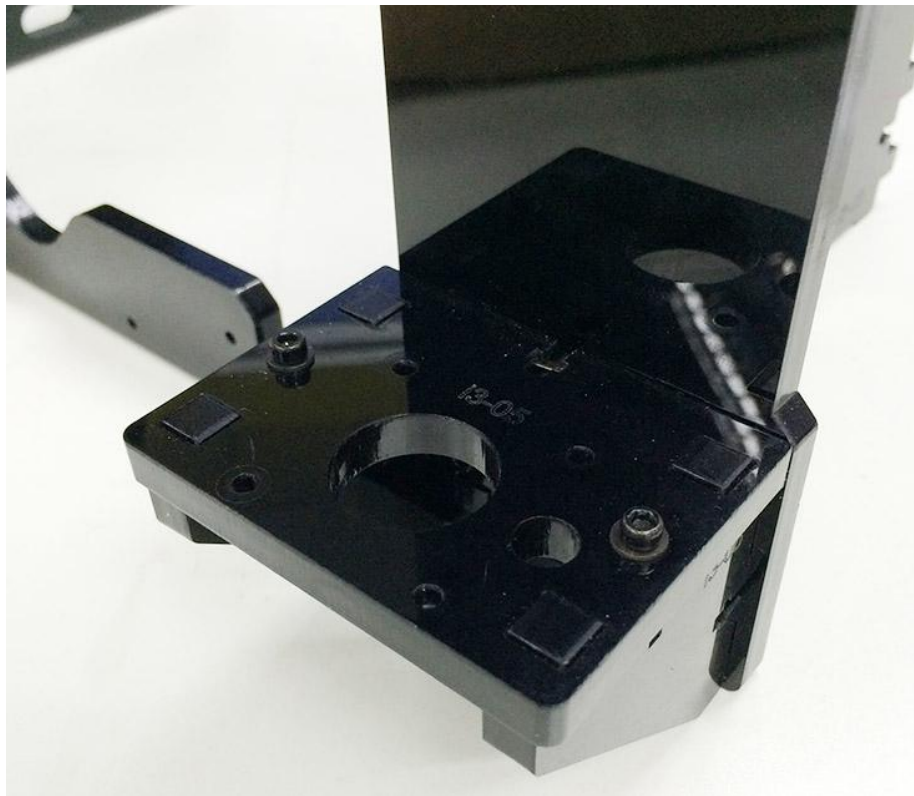

left



right

## 12 Assemble Y - Z axis

[Watch the video](#)

Required parts	Required number	Part ID	Pic
M3 x 16 screw	2	NO.27	
M3 x 20 screw	4	NO.28	
M3 nut	4	NO.11	
M3 square nut	2	NO.17	

Step1. Put the Y axis between the main frame.



Step2. Screw up the main frame to the acrylic fender with 4 M3 x 20 screws. And screw up the M10 nuts.



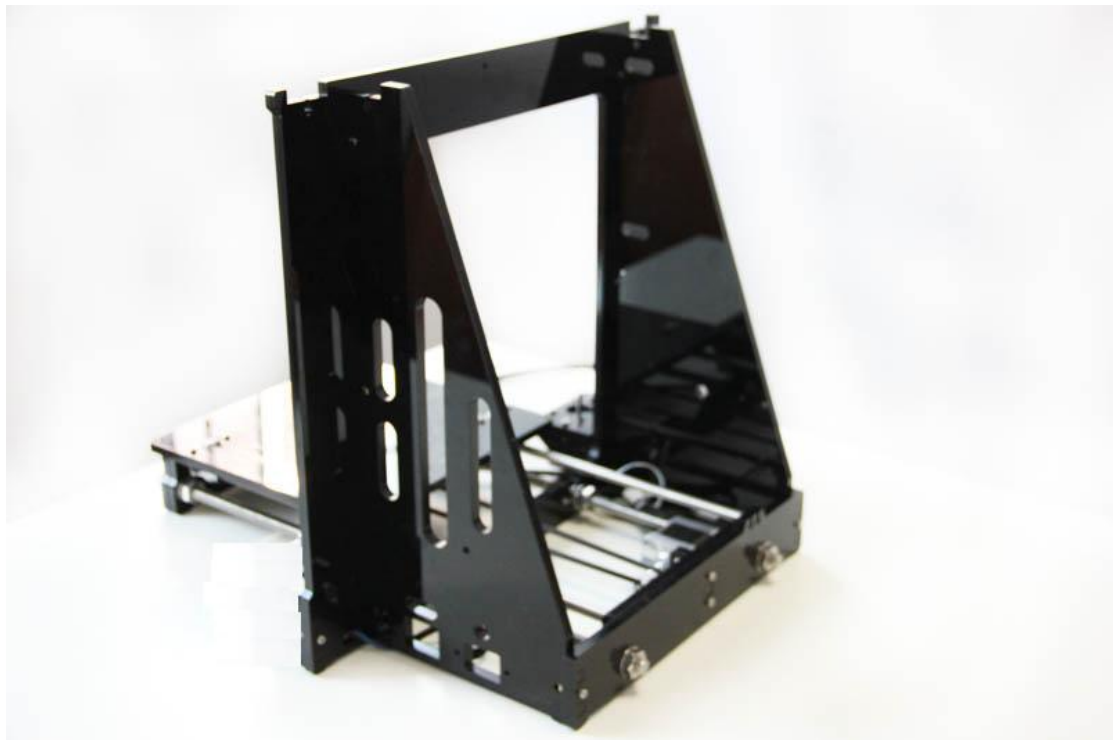

Step3. Screw up the Y axis rear plate and the side panel with M3 x16mm screws and M3 square nuts.



13 Mount Z-axis End stop

[Watch the video](#)

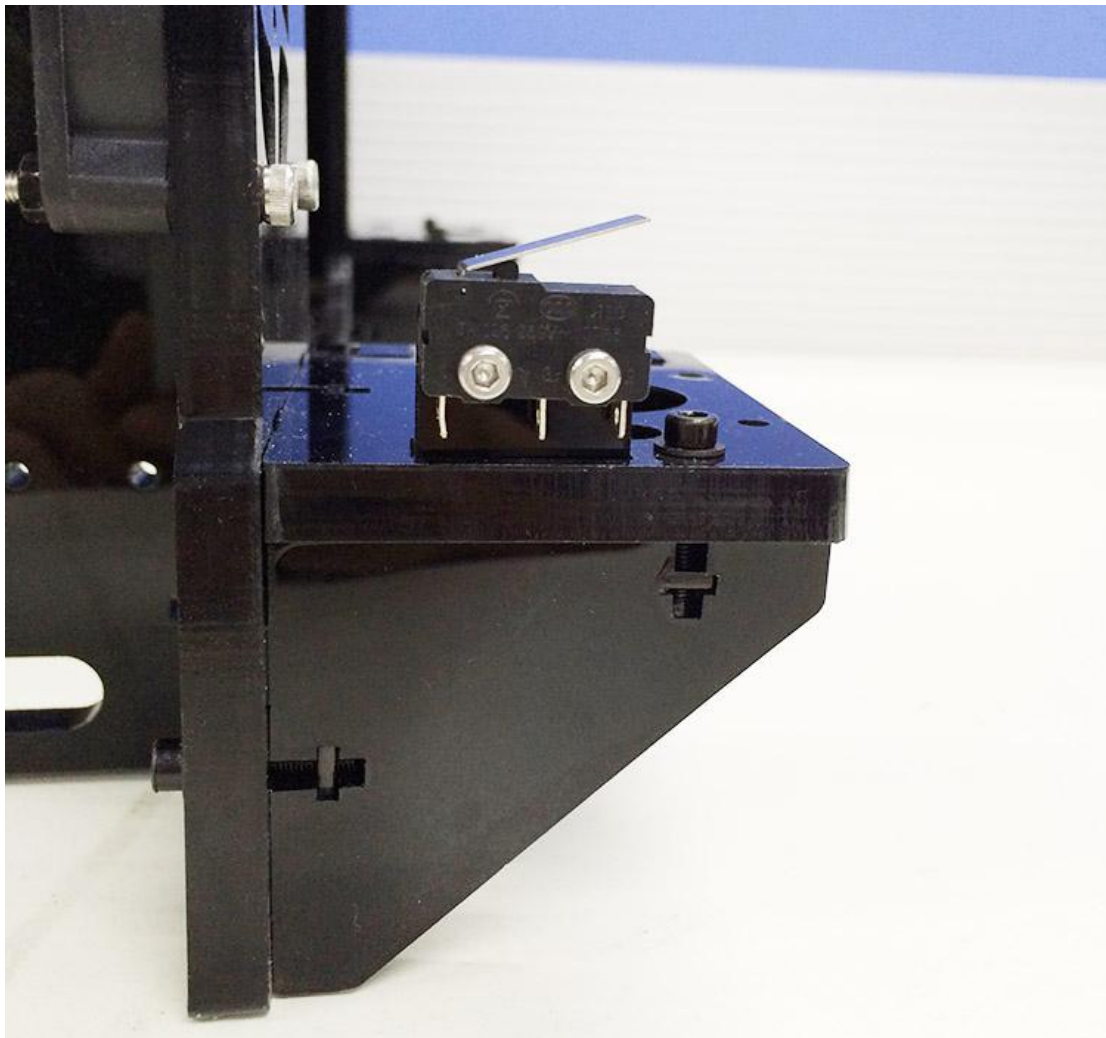

Required parts	Required number	Part ID	Pic
End stop	1	NO.56	
M 2.5 X 16 screw	2	NO.22	
M 2.5 nut	2	NO.10	

Mount the endstop on the outside of A7 with M2.5 x 16mm screw and M2.5 hex nut.



14 Assemble the 2 Z motors

[Watch the video](#)

Required parts	Required number	Part ID	Pic
Stepper Motor	2	NO.62	
M3 x 12screw	8	NO.26	

Step1.Thread the wires of the motors through the holes

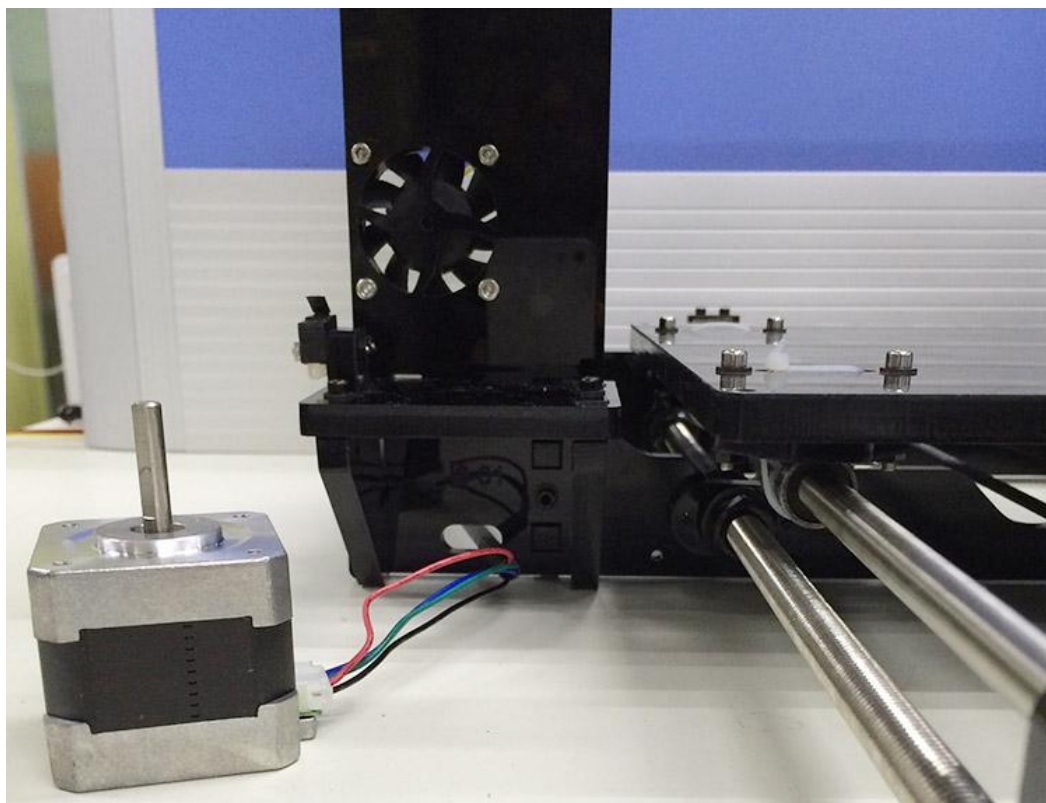

Step2. Screw up the motors with 4 M3 x 12 screws.

Do the same with the other Z motor.



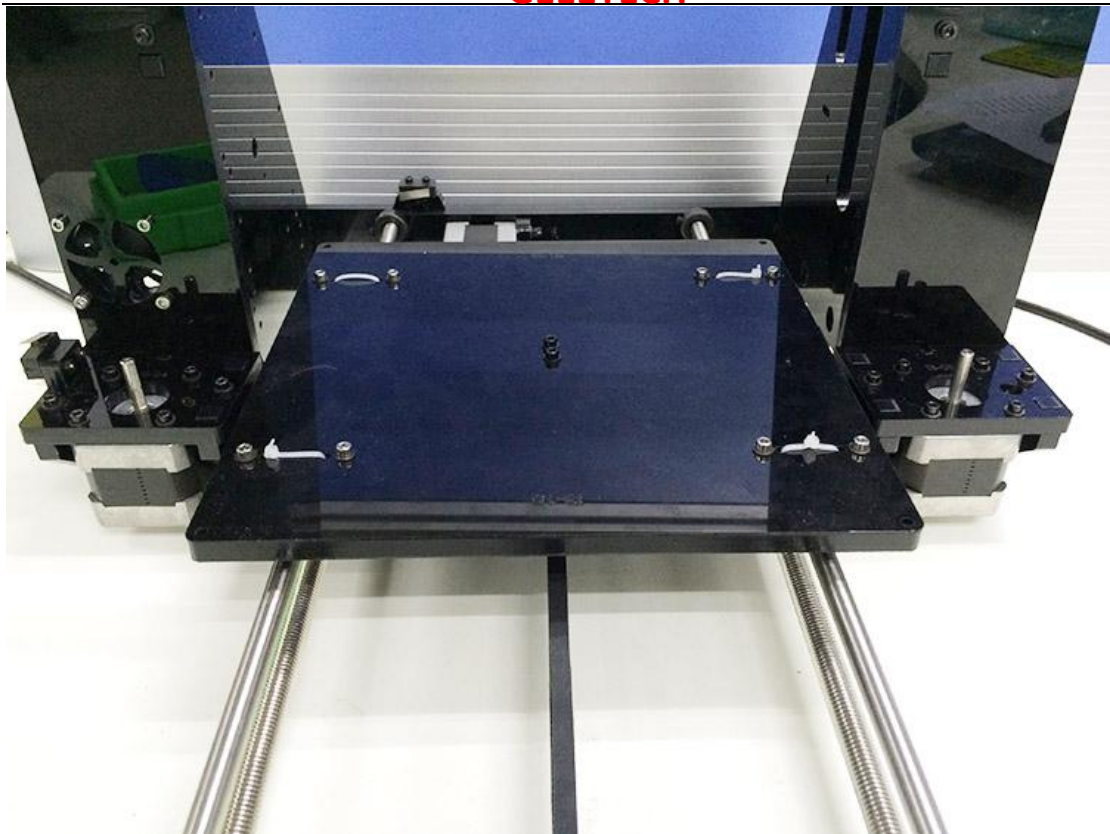

**15 Assemble the coupling.**

[Watch the video](#)

Required parts	Required number	Part ID	Pic
Couplings	2	NO.43	

Step1. Fix the two couplings on both of the motor shaft.

Please note:



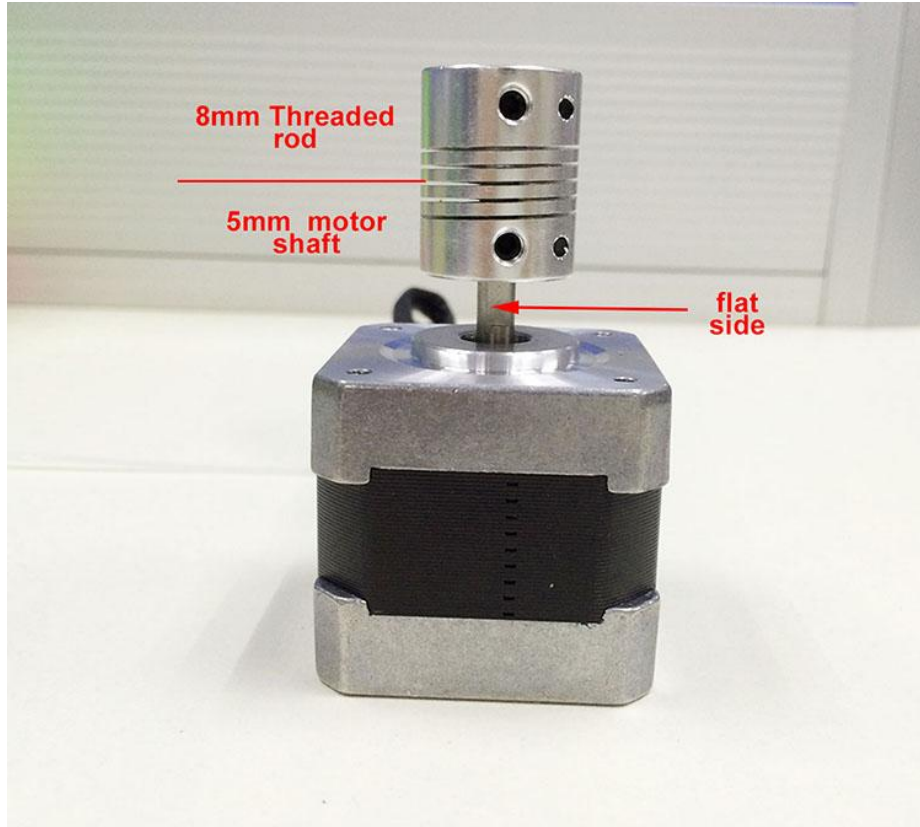

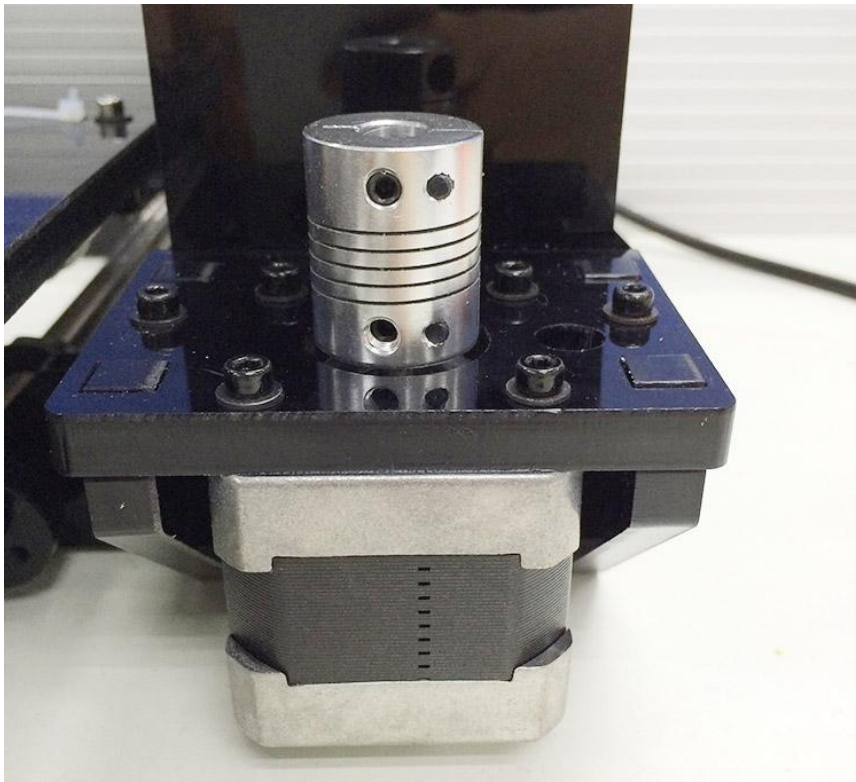
1. The opening of both end, one is 5mm, another is 8mm, connect the 5mm hole to the motor shaft.
2. Screw the small bolt of the 5mm part on the **upper part of the flat side** of the motor shaft tightly.







16 Attach he heated bed.

[Watch the video](#)

Required parts	Required number	Part ID	Pic
Heat bed set	1	NO.59	
M3 x35 screw	4	NO.30	
M3 washer	12	NO.7	
Spring	4	NO.35	

clamp	4	NO.48	
Wing nut	4	NO.16	
Borosilicate glass	1	NO.60	

\*All our heated bed is pre-soldered or attached before shipping; you can attach the bed directly here.

Mount the heat bed on the platform with 4 M3 x35 screws and wing nuts with springs in between. Clamp the heat bed and the glass sheet.

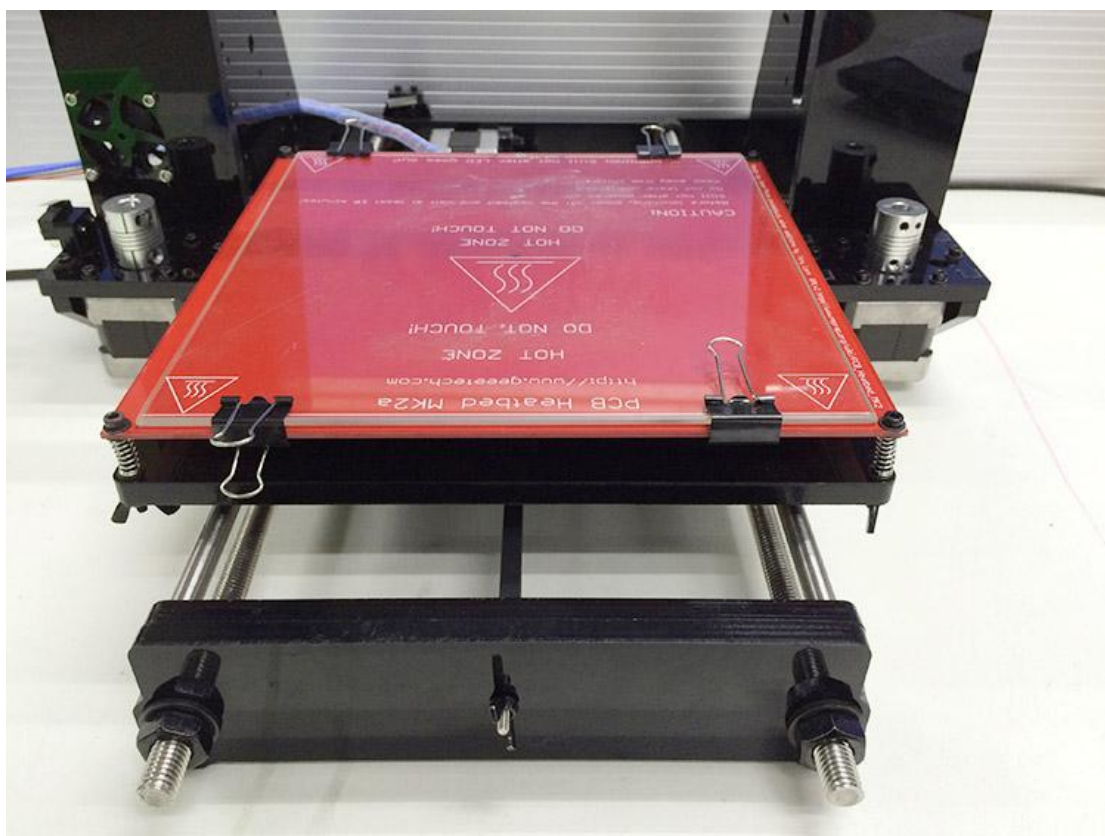

\*the soldered side is better to be attached downwards.

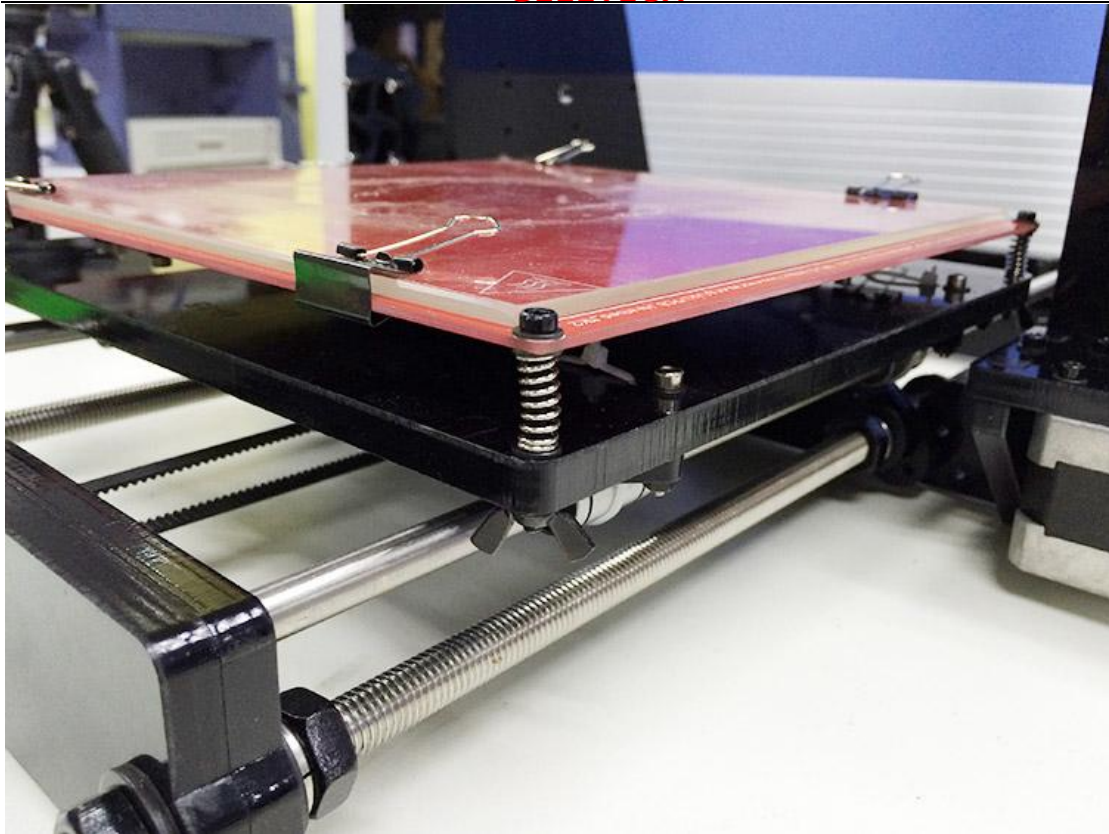







**17 Mount the X-axis motor end**

[Watch the video](#)

Part name	Part ID	Required number	pic
Z-axis nut	No.18	1	
X-axis motor end	No.M1	1	
Linear Bearing LMH8LUU	No. 38	1	

M3 x 30 screw	No.29	1	
M3 x 6mm screw	No. 23	8	
M3 washer	No. 7	2	
Spring	No. 35	1	

Step1. Mount the Z nut on the X-axis left end from bottom to up, fix with M3 x 6mm screws.

Step2. Mount the linear bearing on X-axis motor end from bottom to up. Fix it up with M3 x 6mm screws.



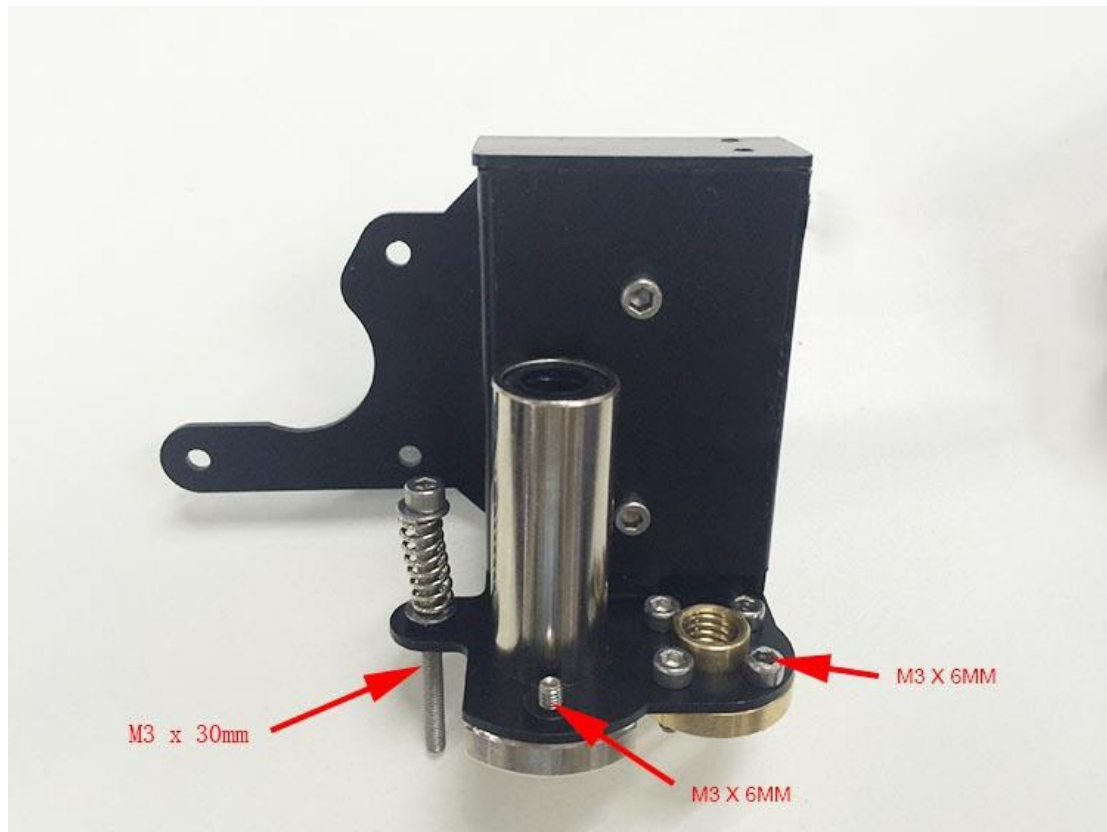

**Mount the endstop trigger**

1. Thread a M3 washer> spring> M3 washer in order to the M3x30mm screw.
2. Thread half of the M3x30mm screw into the screw hole.



**Mount the X motor**

Part name	Part ID	Required number	pic
M3 x 6 mm screw	No. 23	3	
Stepper motor	No.62	1	
Pulley	No.44	1	

Note: In some of the picture, the pulley is a bit different but it won't affect your assembly.

Step1. Mount the pulley on the motor shaft. Screw it on the flat side.

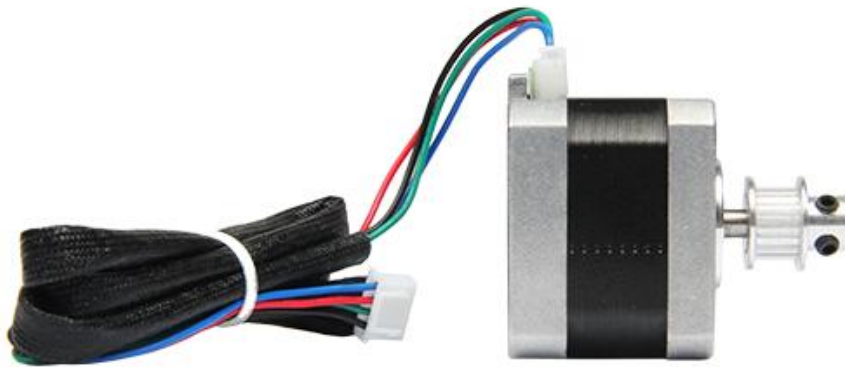



Step2. Mount the stepper motor on the motor end with 3 M3 x 6 mm screw.





Mount the endstop

Part name	Part ID	Required number	pic
M2.5 x 8 mm screw	No. 21	2	
End stop	No.56	1	



Mount the endstop on the top of X-axis motor end with M2.5 x 8mm screws





**18 Assemble X axis idler end**

[Watch the video](#)

Part name	Part ID	Required number	pic
Z-axis nut	No.18	1	
X-axis idle end	No.M2	1	
Linear Bearing LMH8LUU	No. 38	1	

M3 x 6mm screw	No. 23	8	
----------------	--------	---	---

Step1. Mount the Z axis nut on the bottom of X-axis right end with 4 M3 x 6mm screws.

Step2. Mount the linear bearing on X-axis motor end from bottom to up. Fix it up with M3 x 6mm screws.



## 19 Assemble the extruder carriage

[Watch the video](#)

Part name	Part ID	Required number	pic
X Carriage	No.M3	1	
Bearing Bracket	No.M4	4	
Extruder holder	No.M5	1	
Linear Bearing LM8LUU	No.37	2	
Belt bracket	No.51	1	
M3x6mm screw	No. 23	8	
M3x12mm screw	No. 26	2	
M4x6mm screw	No. 32	2	
M3 nut	No.11	2	

Step1. Fix the 4 Bearing Brackets on the back of the X Carriage loosely with M3x6mm screws.



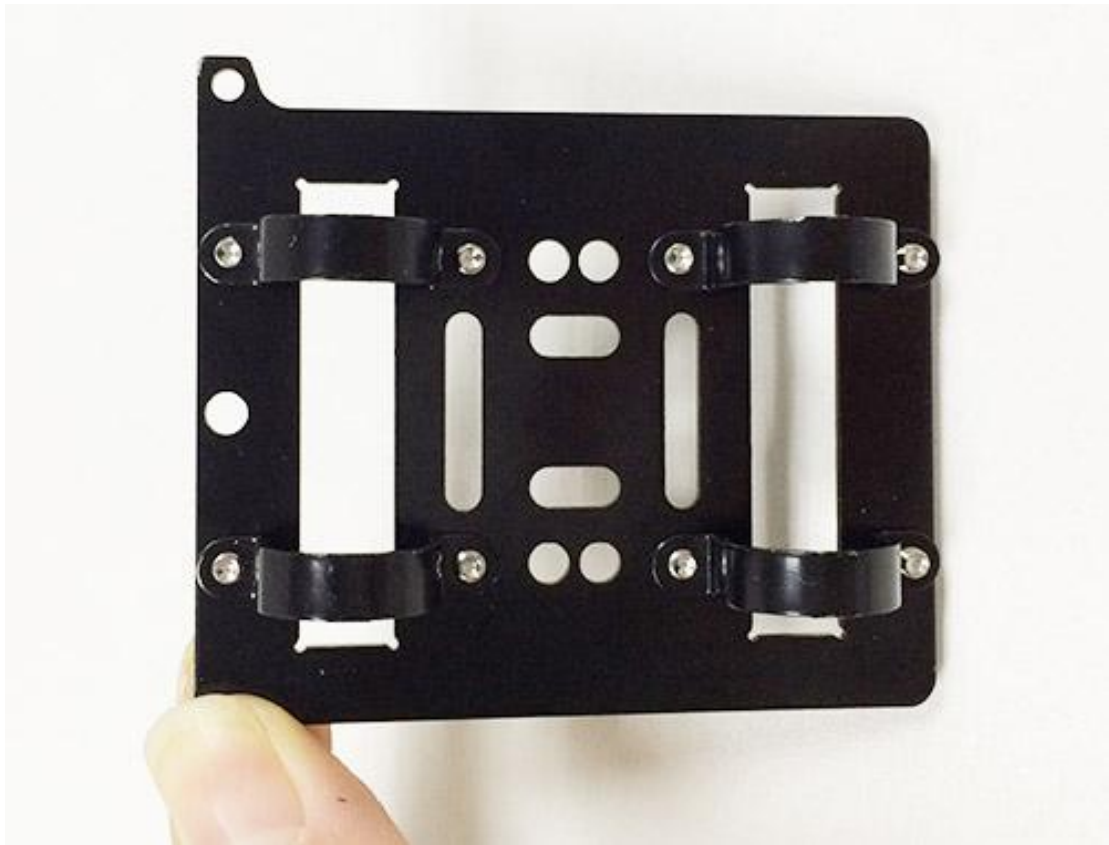

Insert the linear bearing into the slot and screw the bracket tightly.



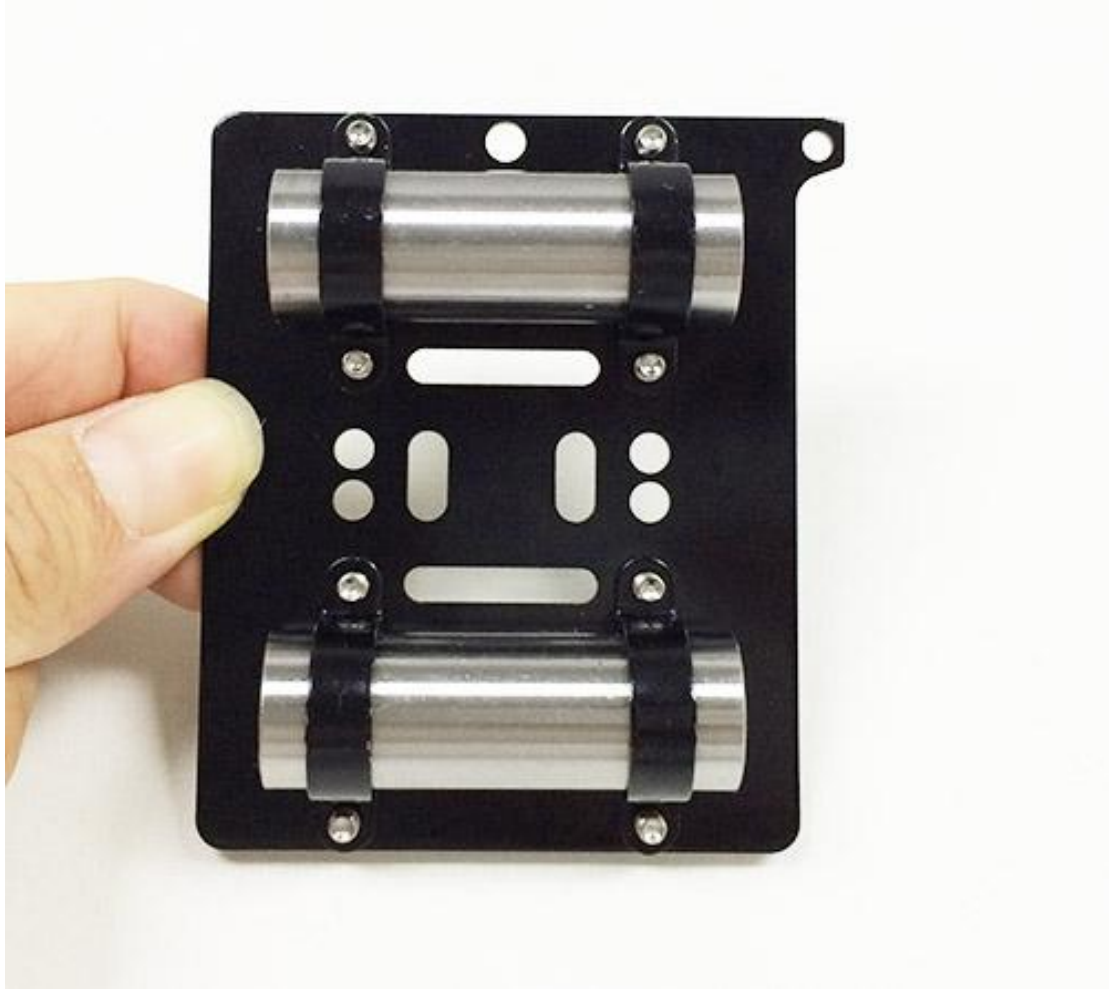

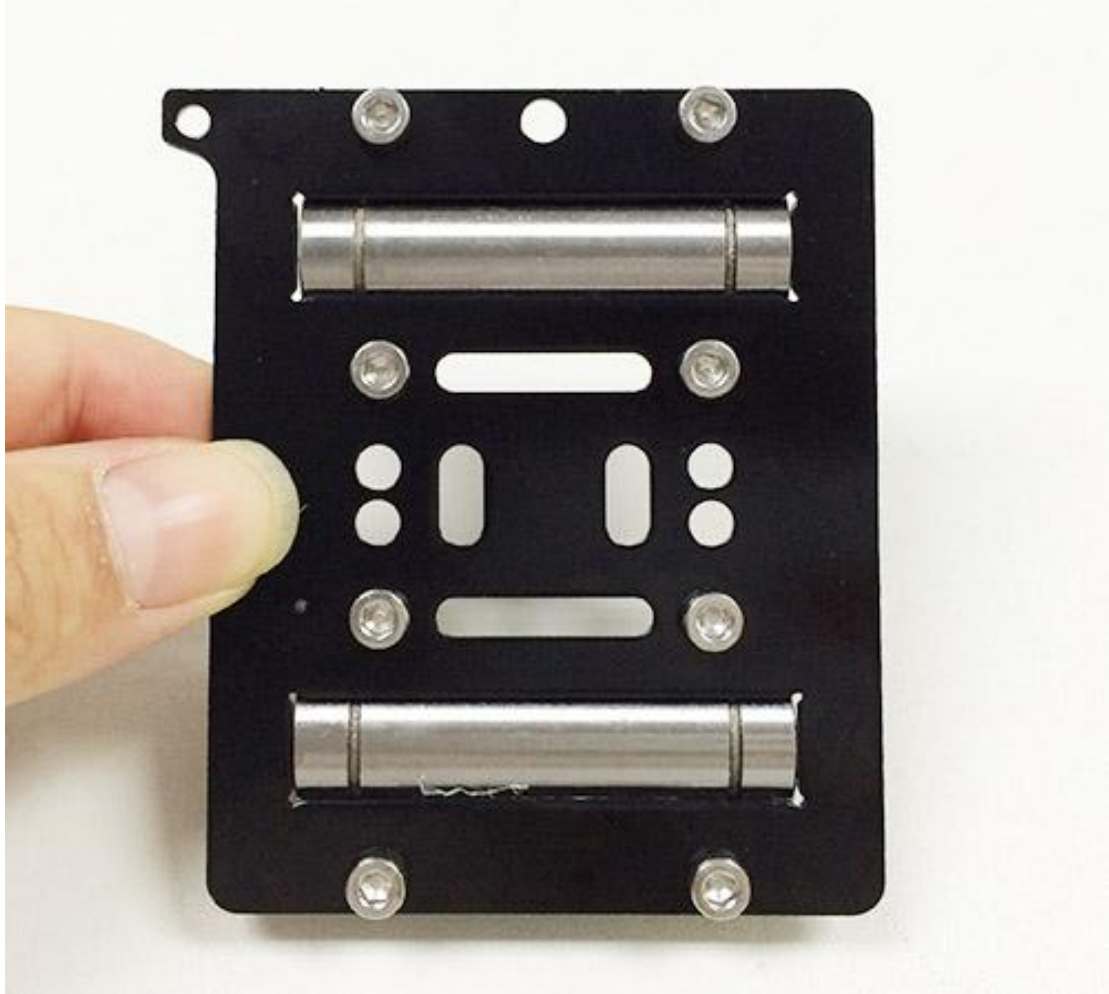

Please notice the front and back of the plate.

Step2. Fix the belt bracket on the back of the carriage with 2 M3x 12mm screws and M3 hex nuts.

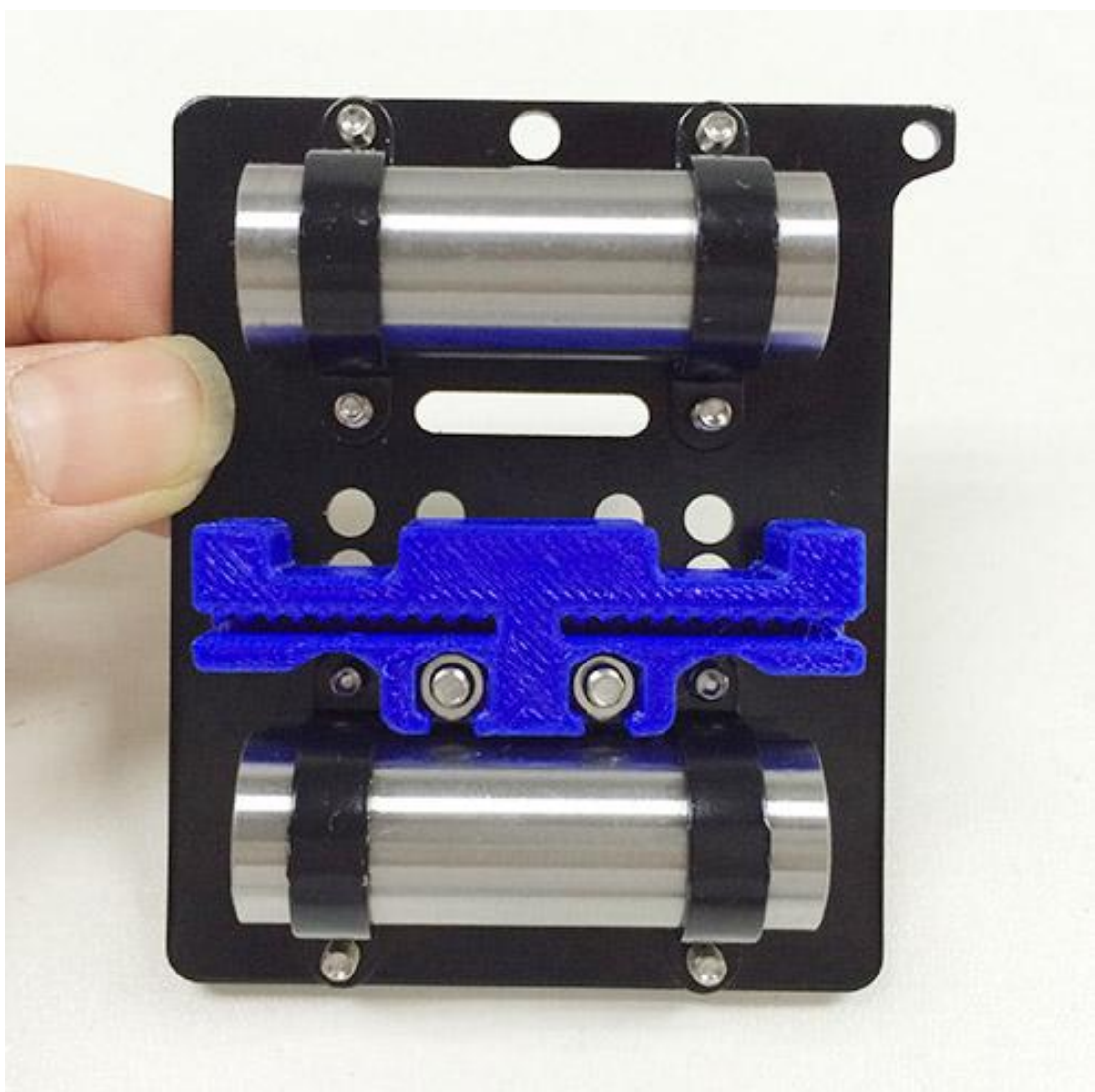

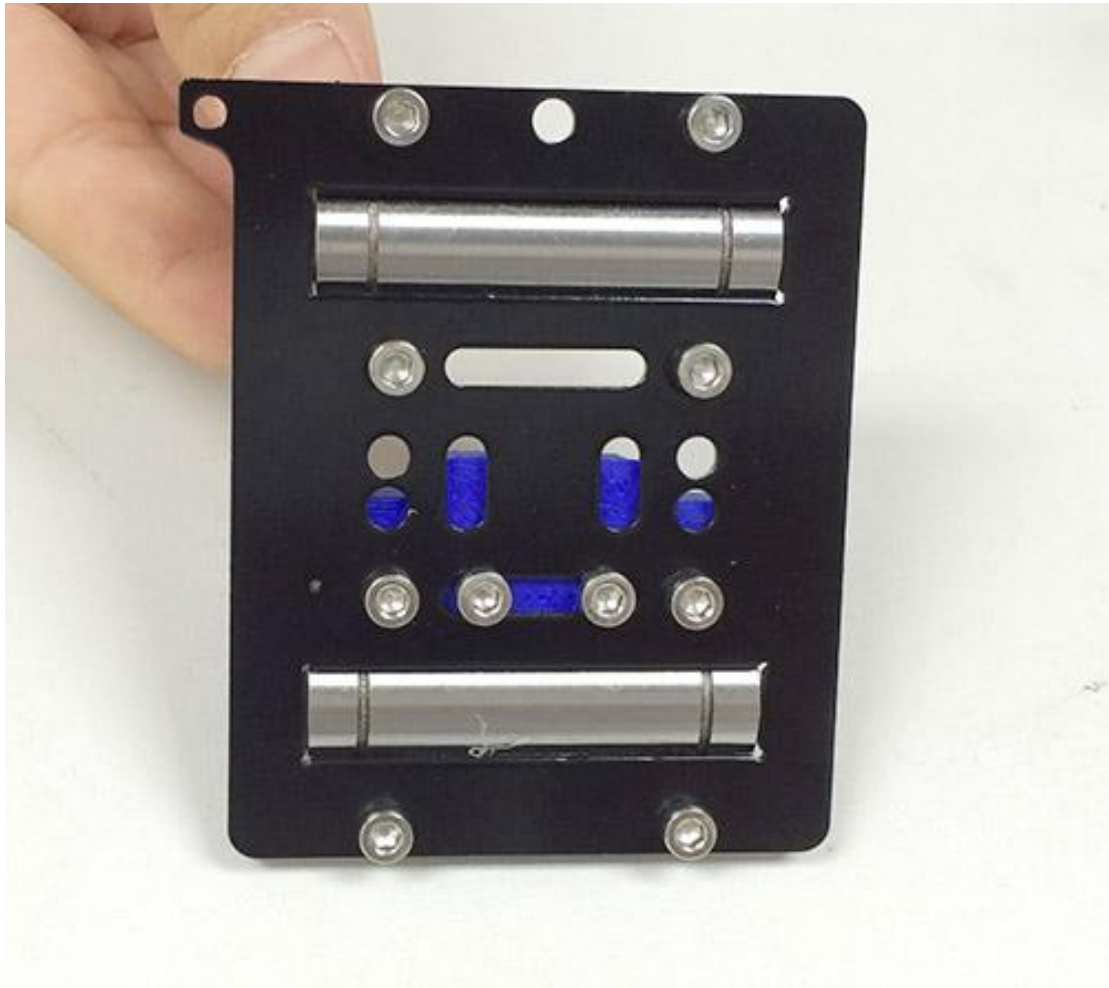

Step3. Fix the extruder holder on the front side of the X carriage using M4x6mm screws.











## 20 Assemble the X&Z axis

[Watch the video](#)

Part name	Part ID	Required number	pic
L300mm threaded rod	No.4	2	
L322mm smooth rod	No.1	2	

L390mm smooth rod	No.2	2	
locking ring	No.20	4	

Step1. Thread the L300 threaded rod to the nut of both end of X axis.

Keep both end of X axis at the same place of the rod, you are advised to measure the distance of the both side so that they are at the same level when you put them up.



Step2. Plug the threaded rod on the X motor end to the left coupling on the left bottom of the Z axis. Then thread the 320mm smooth rod into the linear bearing.



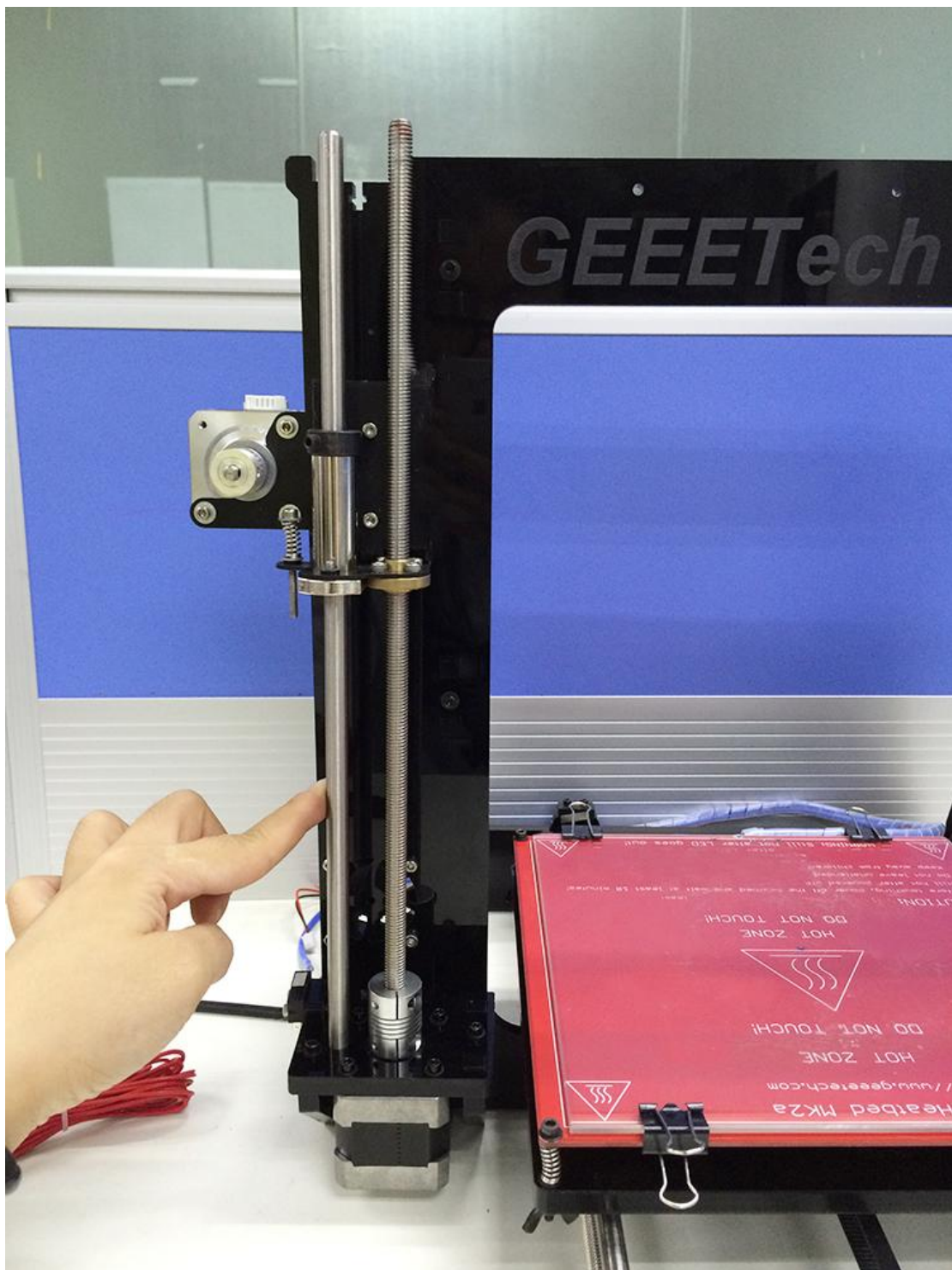

Step3. Thread the L390mm smooth rod into the X motor end > thread the extruder carriage on the two rods.

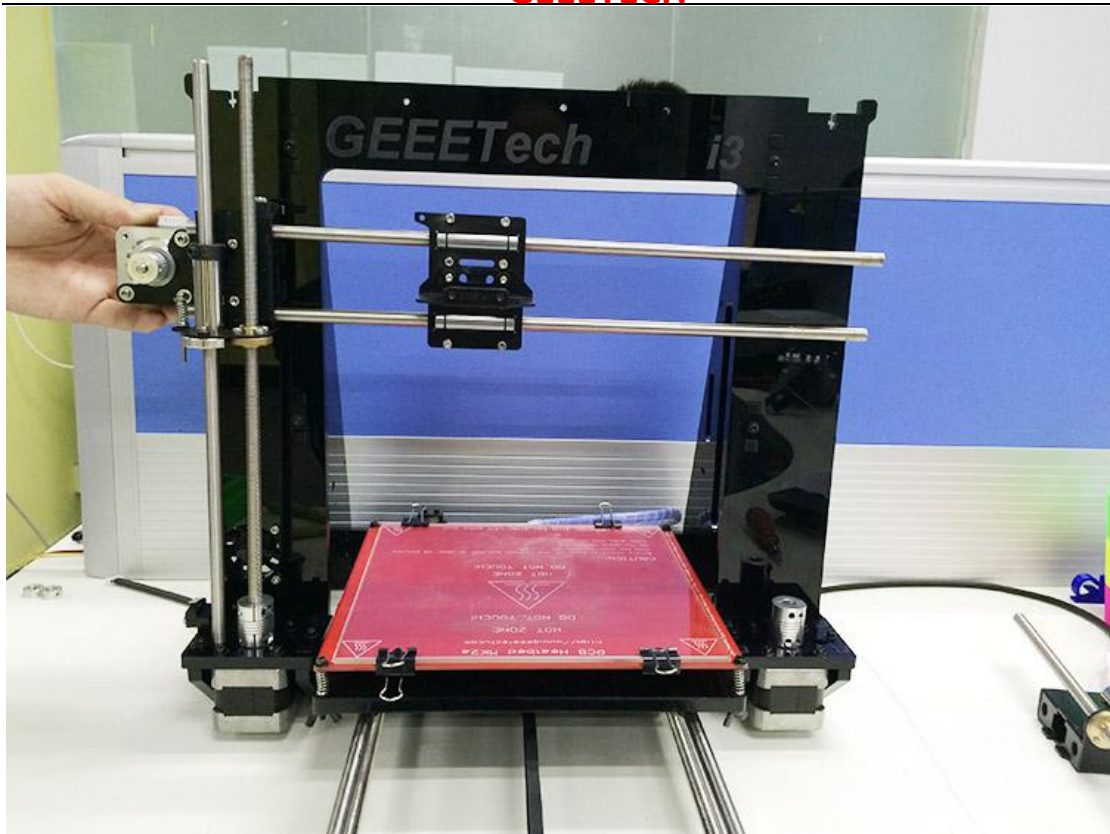

Step4. Thread the two X axis smooth rods into the hole of X idler end. Plug the vertical threaded rod into the coupling on the right bottom of the Z axis. Then thread the 320mm smooth rod into the linear bearing.

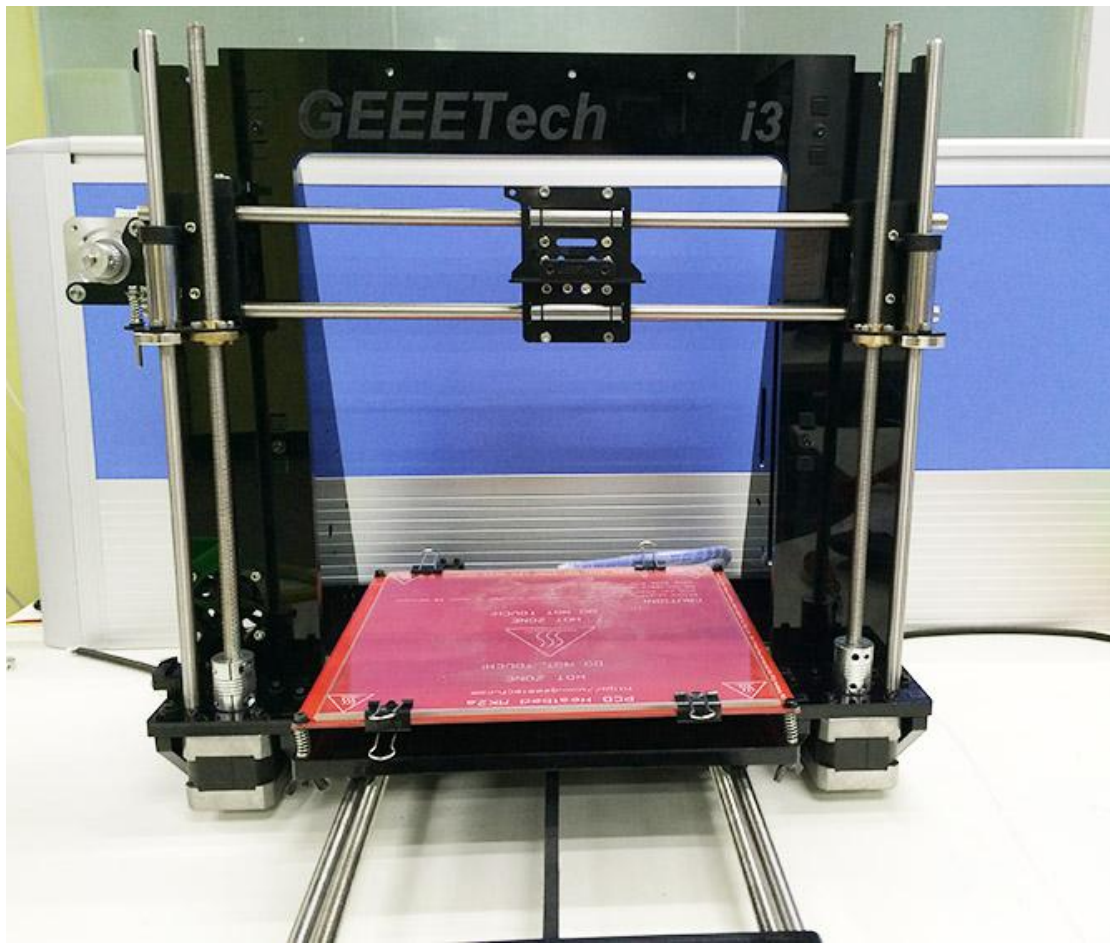

Note: the smooth rods and the threaded rod of Z axis are **vertical** and the X axis is **horizontal**, which is very important, or it will hinder the move of the Z axis.

Step5. Fix the locking rings on the end of the rod if you got the silver rings.

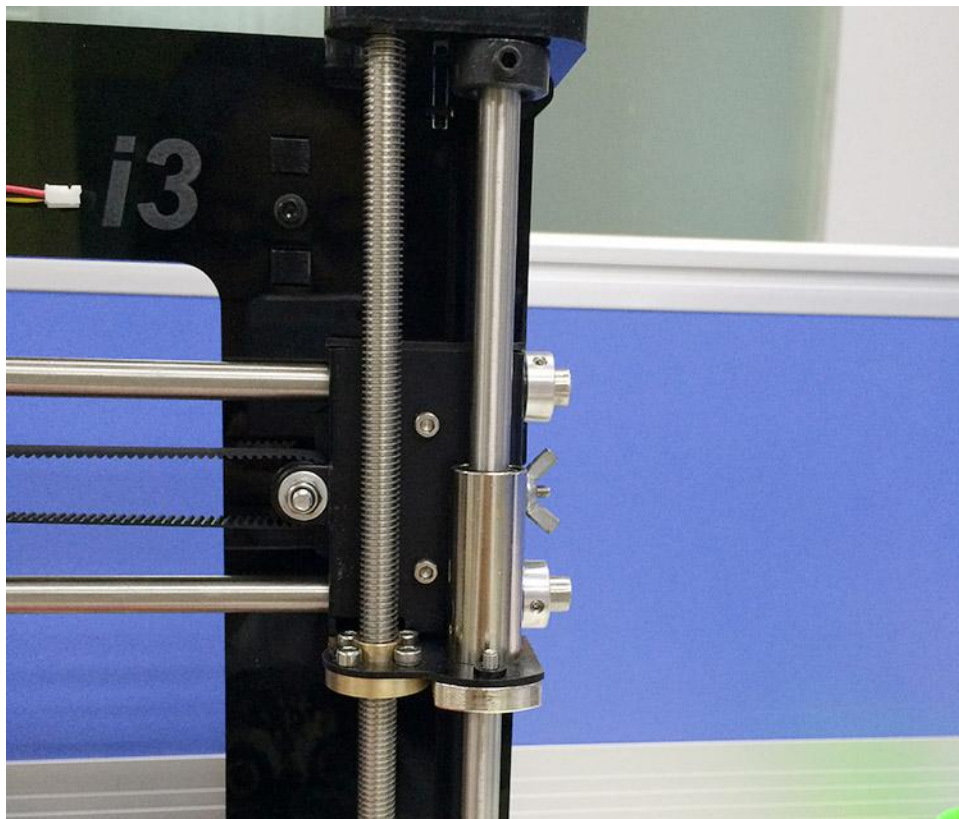
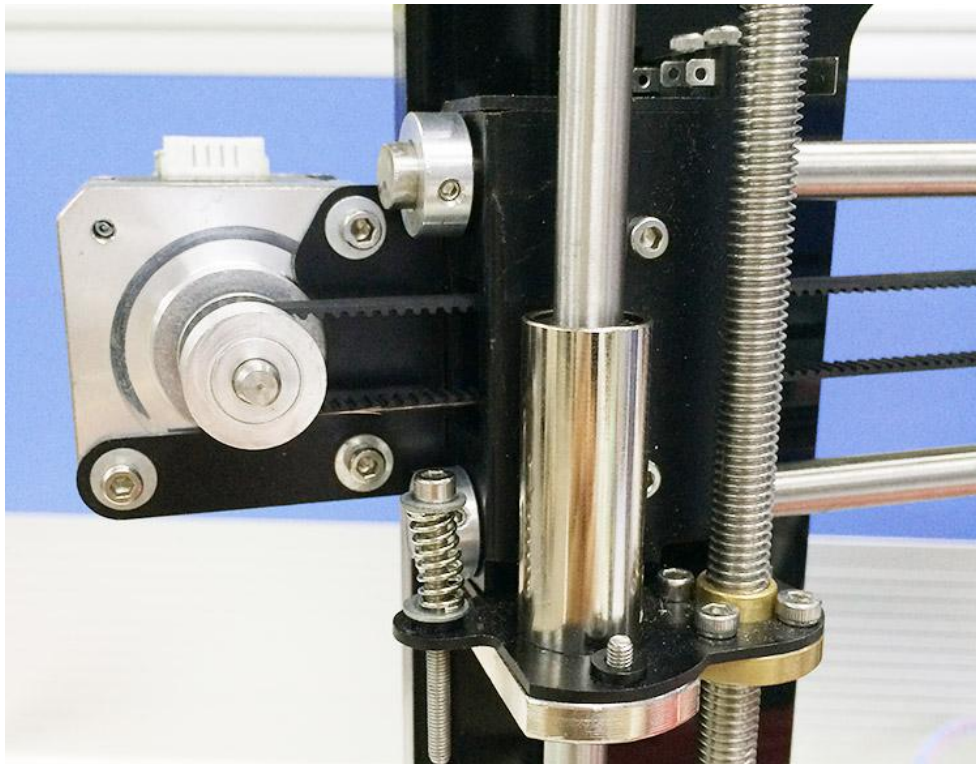



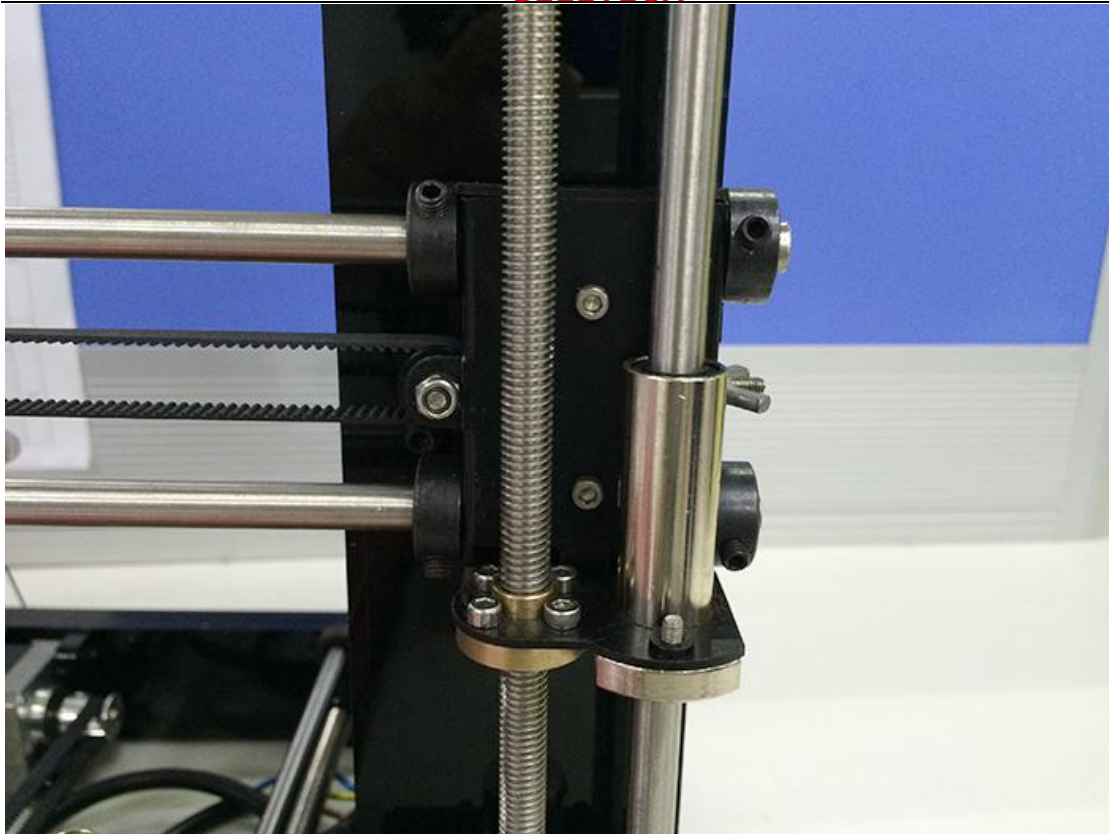

NOTE: If you got the black lock ring (No.20), you need to fix all the 4 locking rings on the right end, as shown on the following picture.



## 21 Assemble the Z axis top mount

[Watch the video](#)

Part name	Part ID	Required number	pic
Z top mount	No.A8	2	
M3 x 16mm screw	No.27	4	
M3 Square nut	No.17	4	
locking ring	No.20	2	

M3 washer	No. 7	6	
-----------	-------	---	---

Step1. Put the locking ring on the two smooth rods separately.

Step2. Add the Z top mount (No.A8) to the top of A1. Slowly rotate the rods into the holes, or add some lubricants on the rods. Do not force it, or u will break the acrylic piece.

Step3. Screw it up with M3 x 16mm screw and M3 Square nut.

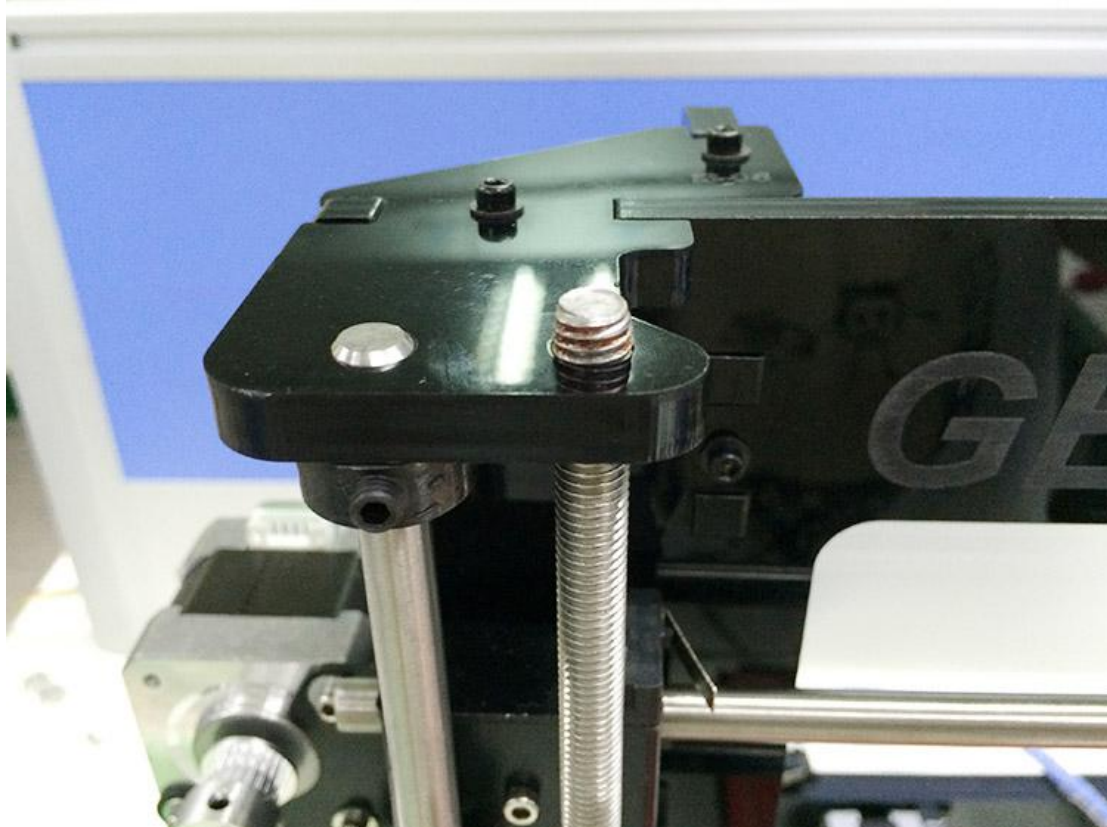

Step4. Screw up the locking ring on smooth rods.

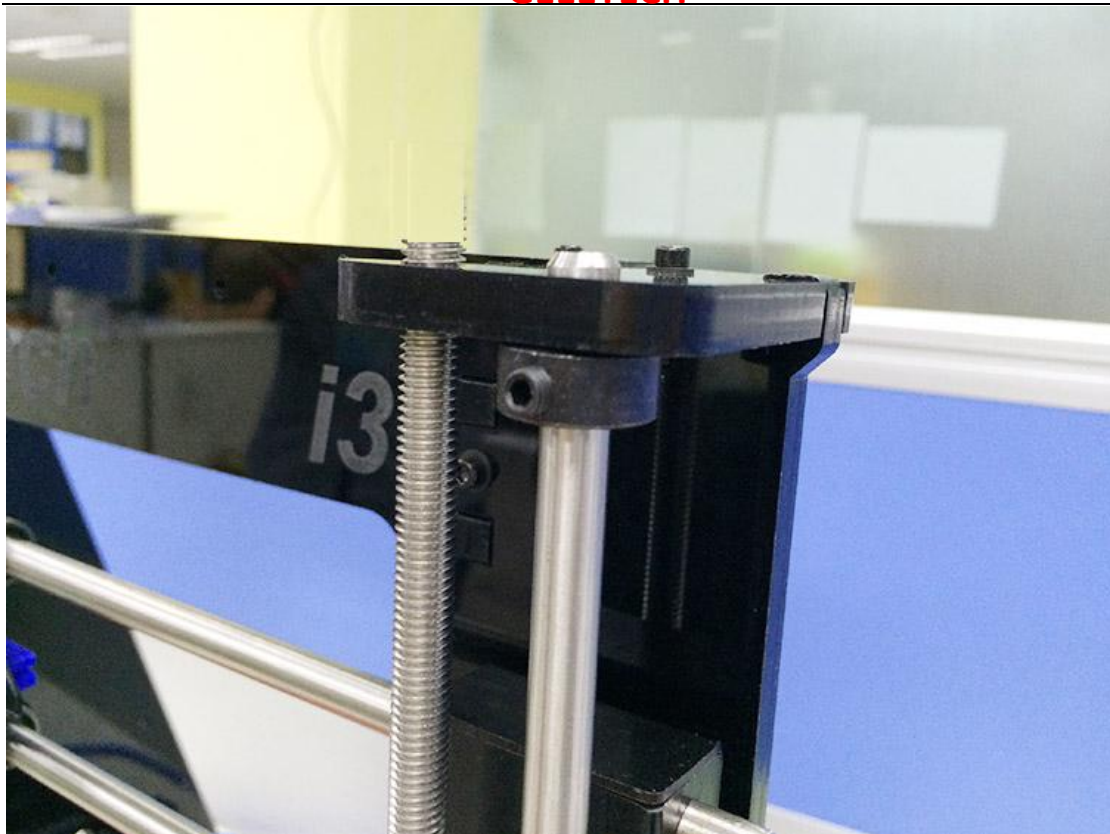



## 22 Mount the extruder

[Watch the video](#)

Required parts	Required Number	Part ID	Pic
MK8 extruder	1	NO.63	
M4 x 6mm screw	2	NO.32	
M4 washer	2	NO.8	

Step1. Mount the assembled extruder on the extruder holder. Use 2 M4 x 6 mm screws and M4 washers to fix.

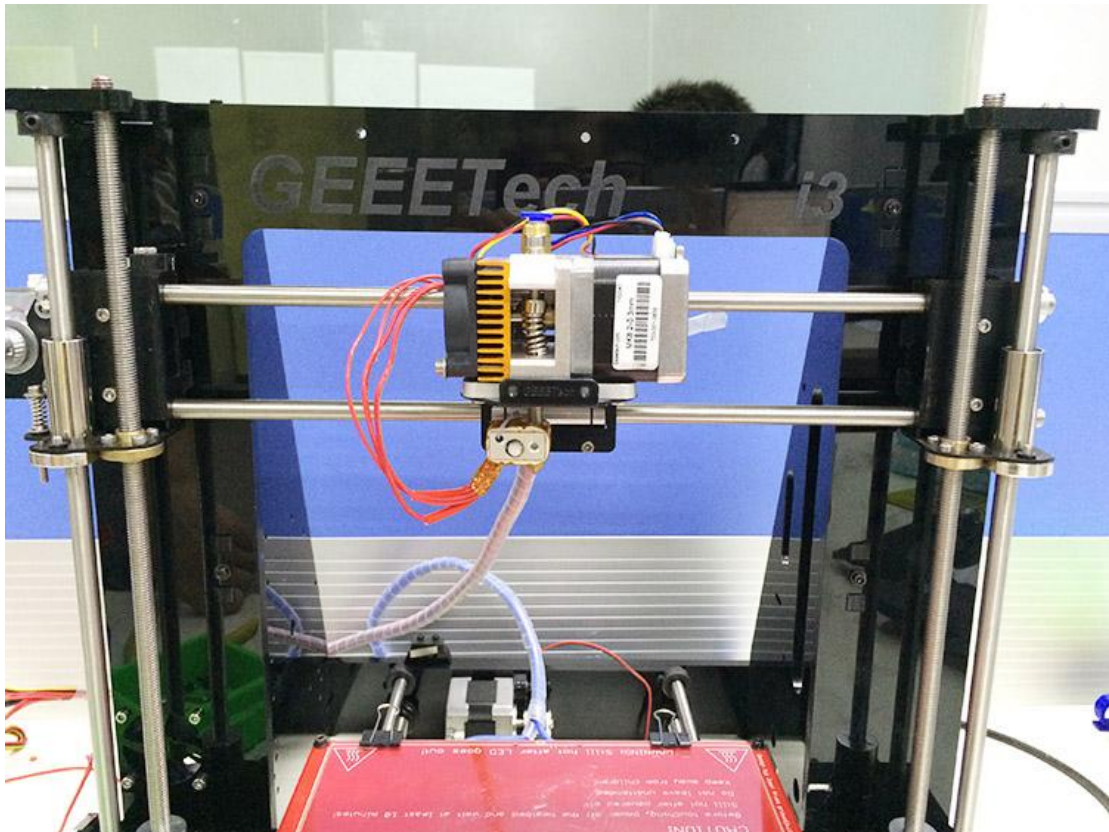
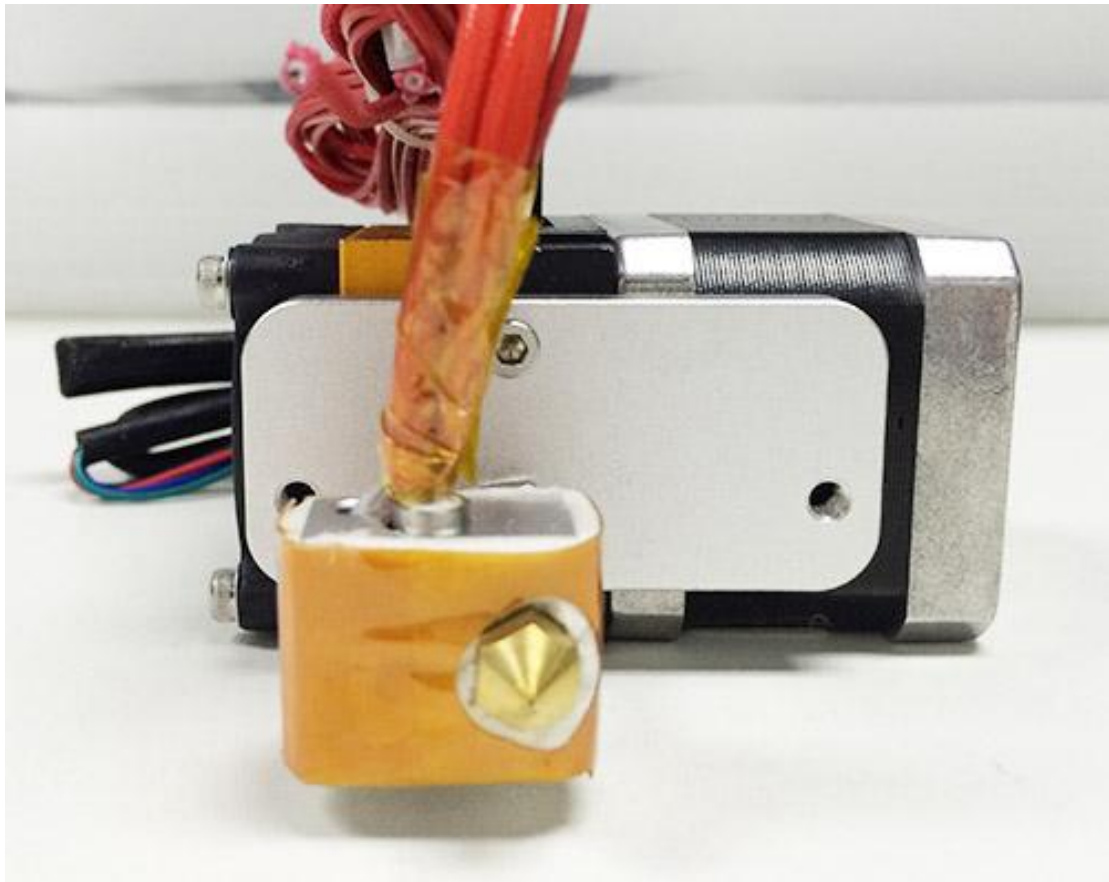











## 23 X belt driven wheel

[Watch the video](#)

This video is just for referring, you need to use M3 x40mm screw.

Part name	Part ID	Required number	pic
Driven wheel holder	No.41	1	
Driven wheel	No.45	1	
MR84zz Ball Bearing	No.46	2	
M3 x40mm screw	No.31	1	
M4 x 25mm screw	No.33	1	
M3 washer	No.7	1	
M4 washer	No.8	1	
M4 lock nut	No.15	1	
wing nut	No.16	1	

Step1. Thread the M3 x 40 screw and M3 washer through the Driven wheel holder .

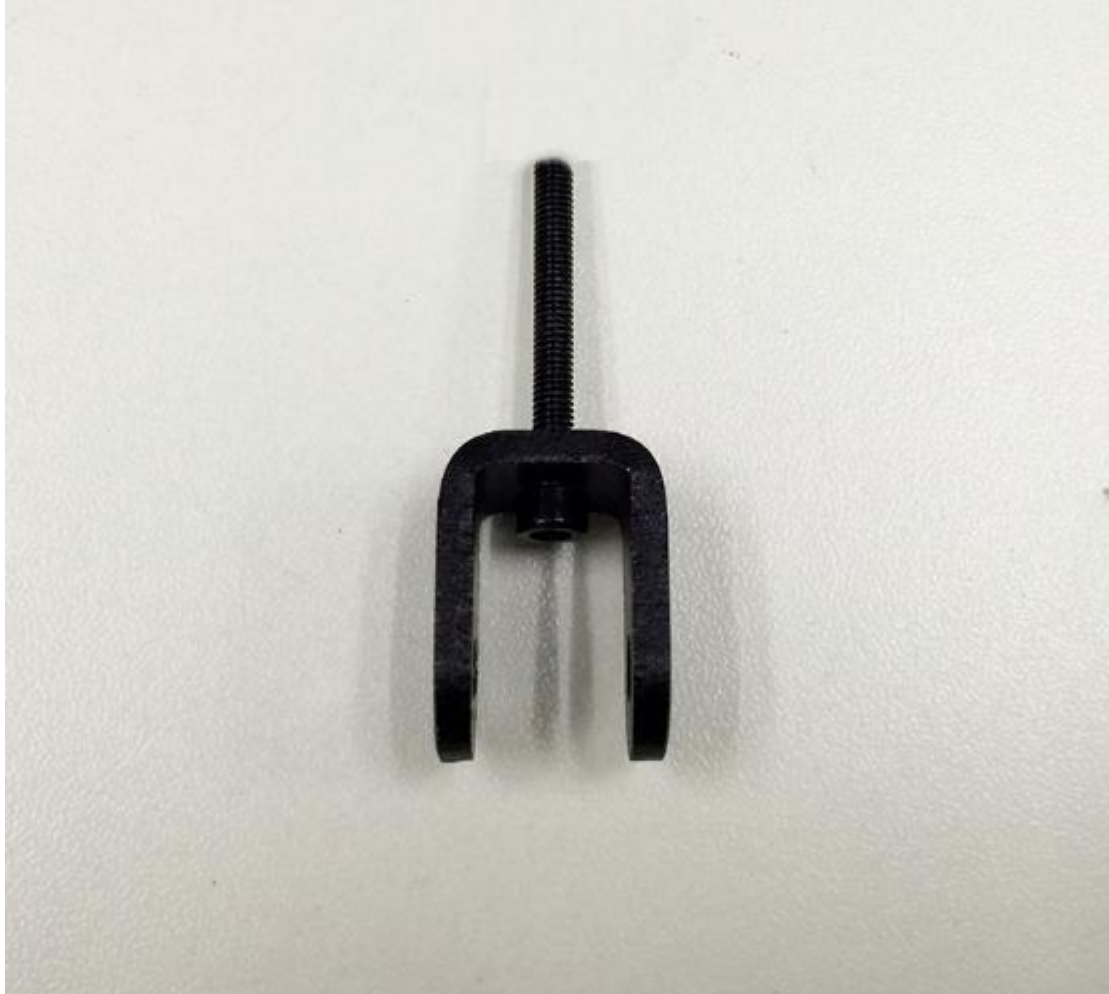

Step2. Insert the two MR84zz ball bearings into both ends of the driving wheel. For your convenience, this step is already finished by us.



Step3. Put the M4 x25 screw and M4 washer through the driving wheel. Lock the other end with a M4 lock nut. You may need a wrench to tighten locking nut.





\*Do not screw it too tight, you should leave enough room for the wheel to turn freely.

## 24 Add the X axis belt

[Watch the video](#)

Part name	Part ID	Required number	pic
Timing belt	No.40	1	

Step1. Insert one end of the belt in the groove. Pay attention to the tooth mesh of the belt and the groove.

Step2. Thread another end of the belt through the X motor end around the pulley.

Step3. Thread the belt through the belt driven wheel and put the driving wheel into the X idler end, lock it with a wing nut.

Step4. Insert another end of the belt into the groove. Cut the spare part. Be sure of the length of the belt.

Step5. Taut the belt and tighten the wing nut on the idle end.

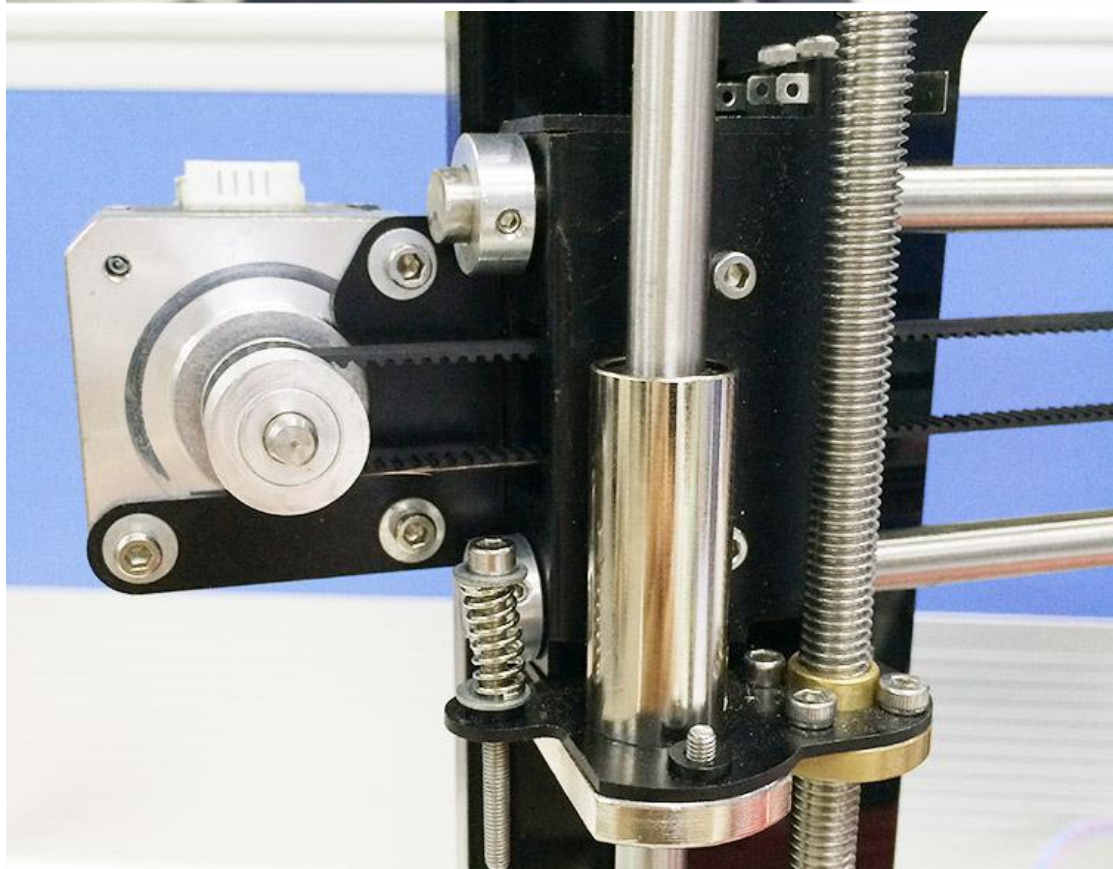
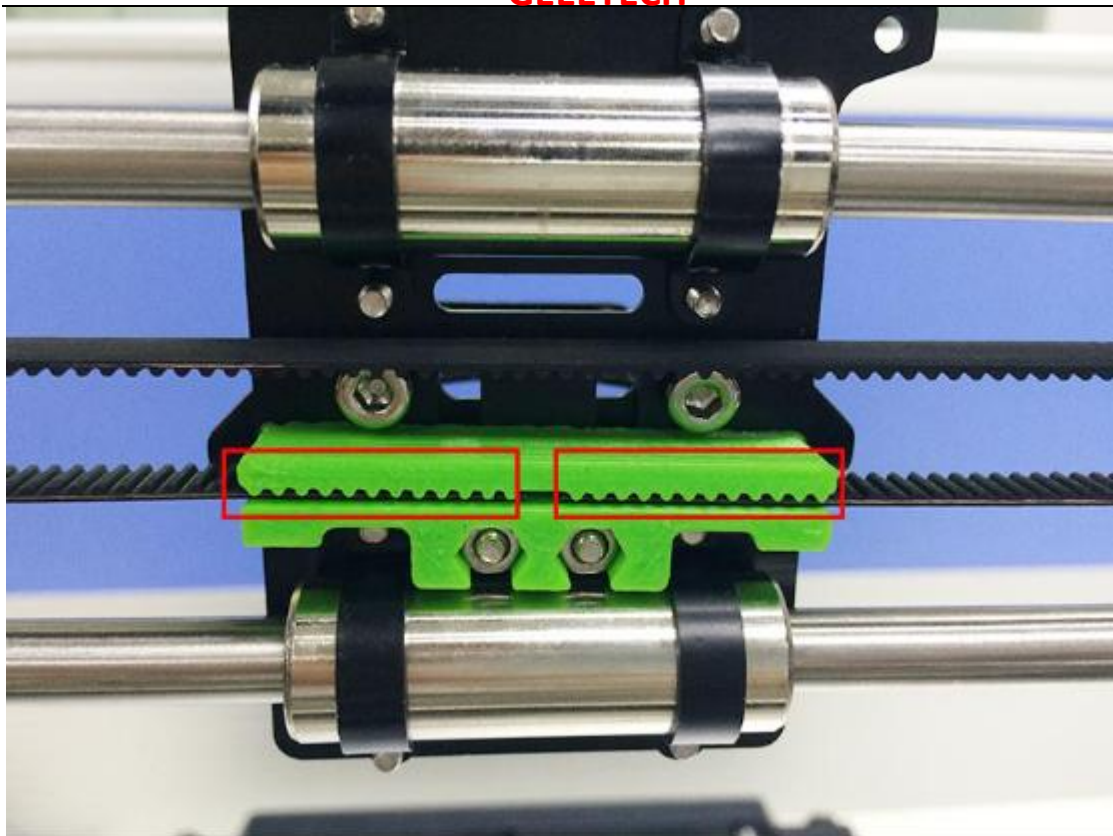

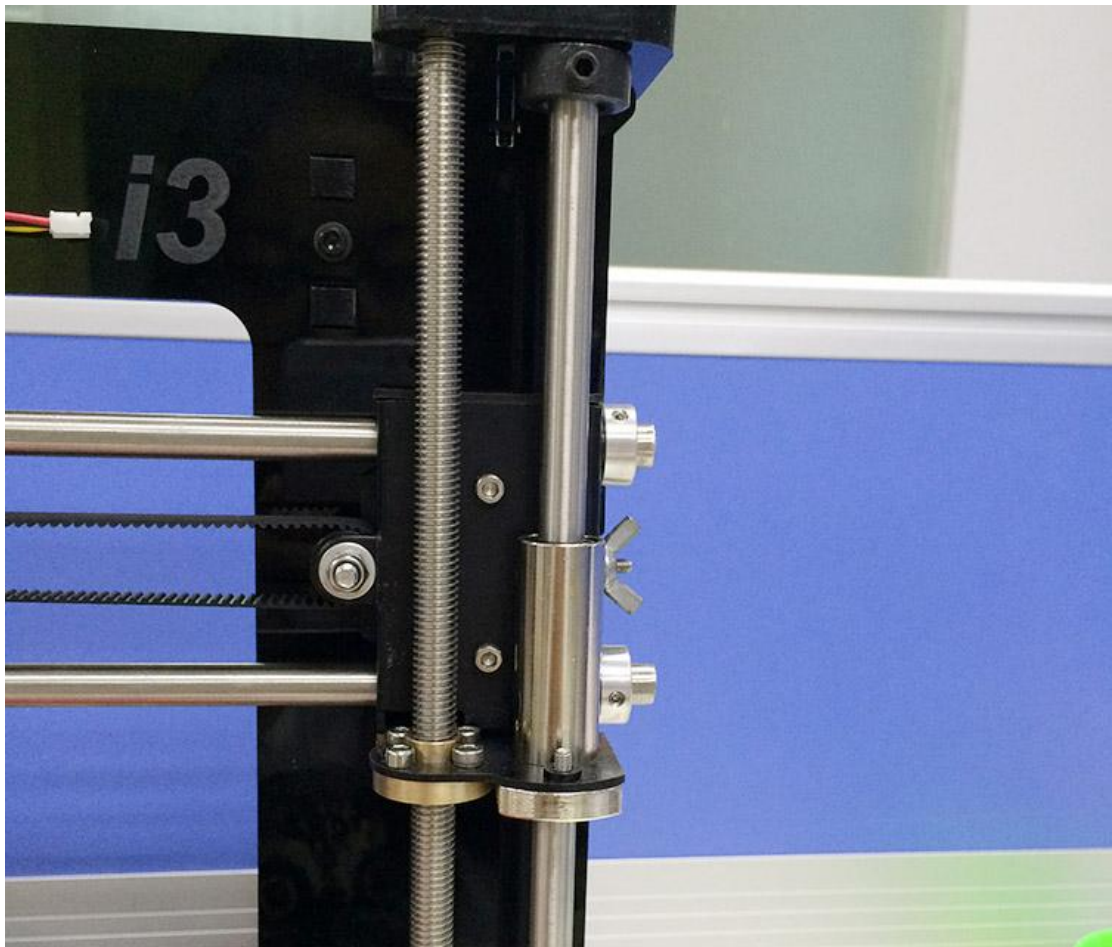
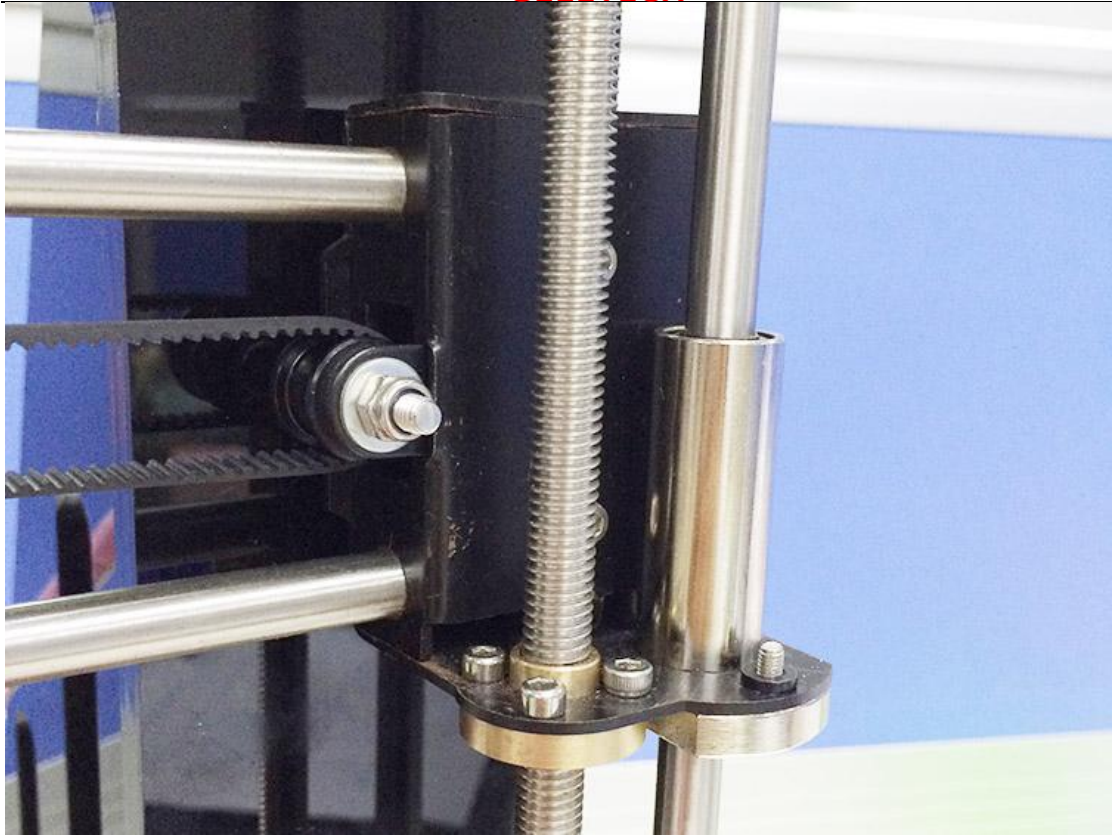

\*Note the direction of the driven wheel, the side with bolt head should be towards the A1, or it will scratch the acrylic plate.

## 25 Mount the LCD panel frame

[Watch the video](#)

Required parts	Required number	Part ID	Pic
LCD 2004	1	NO.65	
LCD frame	1	NO.A18	
LCD frame holder	2	NO.A19	
Acrylic spacer	4	NO.A17	
M3 x 20 screw	6	NO.28	
M3 nut	4	NO.11	
Knob	1	NO.52	

Step1. Cover the LCD frame to the LCD panel.

Step2. Use a M3 x 20 screw to connect the spacer> LCD frame holder >the LCD frame and the LCD 2004 in order, fix with M3 nut.





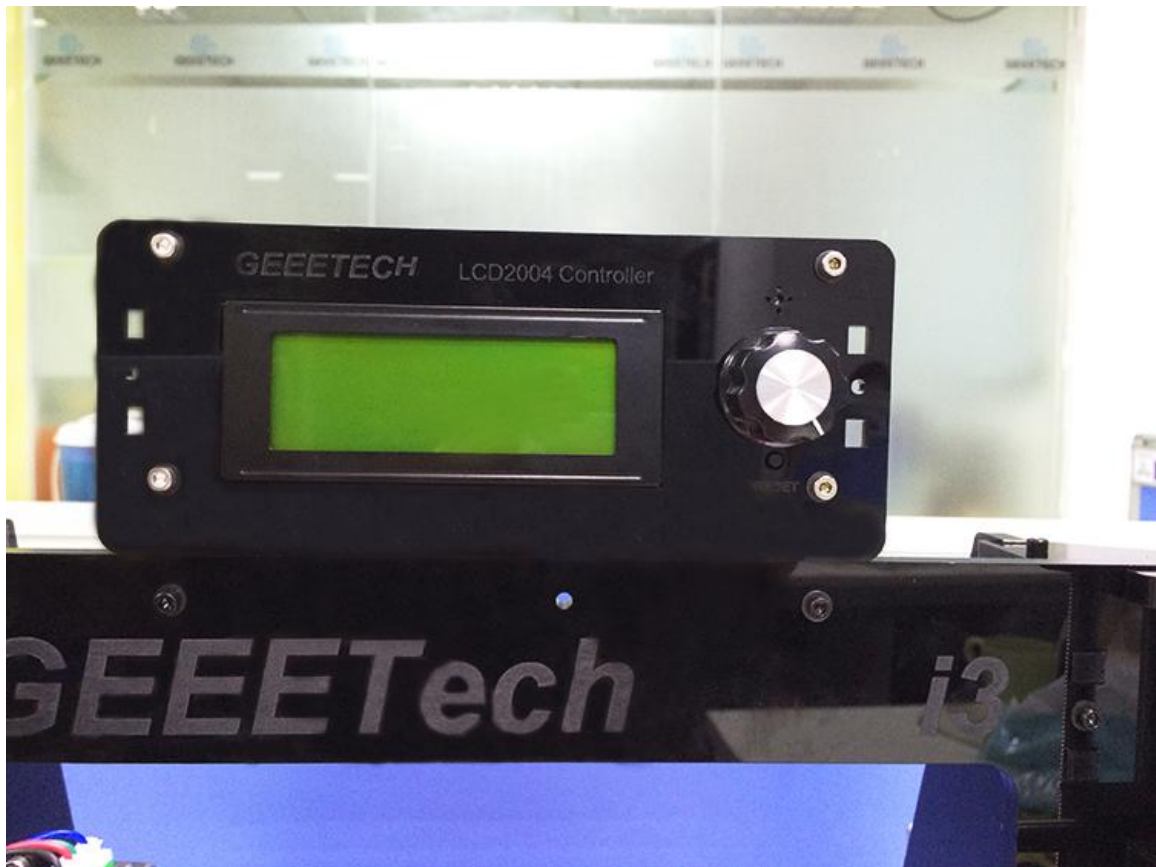
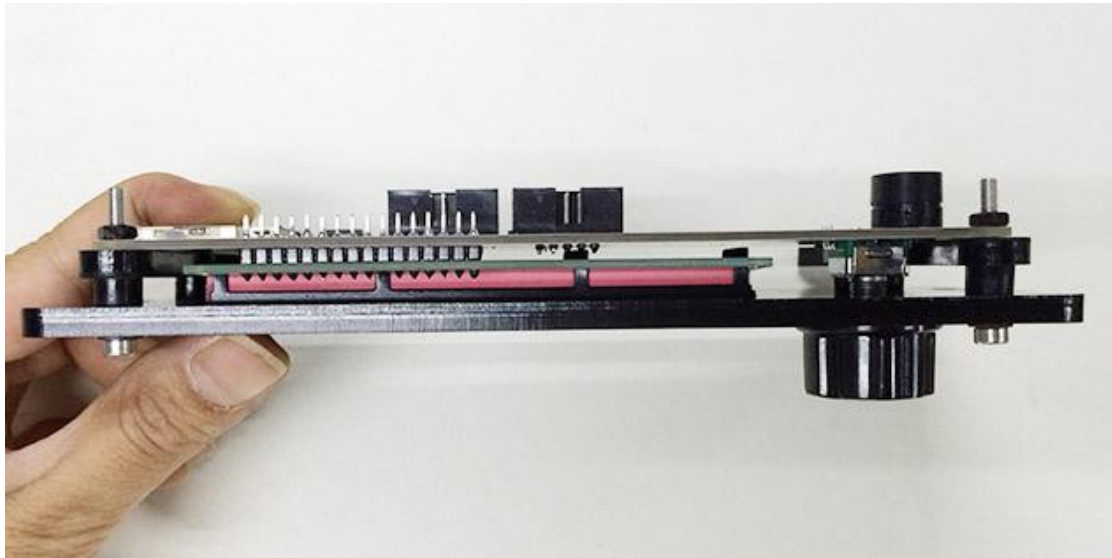







## 26. Mount the PSU

[Watch the video](#)

Required parts	Required number	Part ID	Pic
Power supply	1	NO.61	
M3 x 10 screw	3	NO.25	
M3 x 16 bolt	2	NO.34	
M3 nut	2	NO.11	
3D Power cable	1	NO.57	
Power Cable	1	NO.58	

Step1. Take off the wires connected to the socket; before you do, please take a photo of the wire connection, in case you connect them wrongly later.

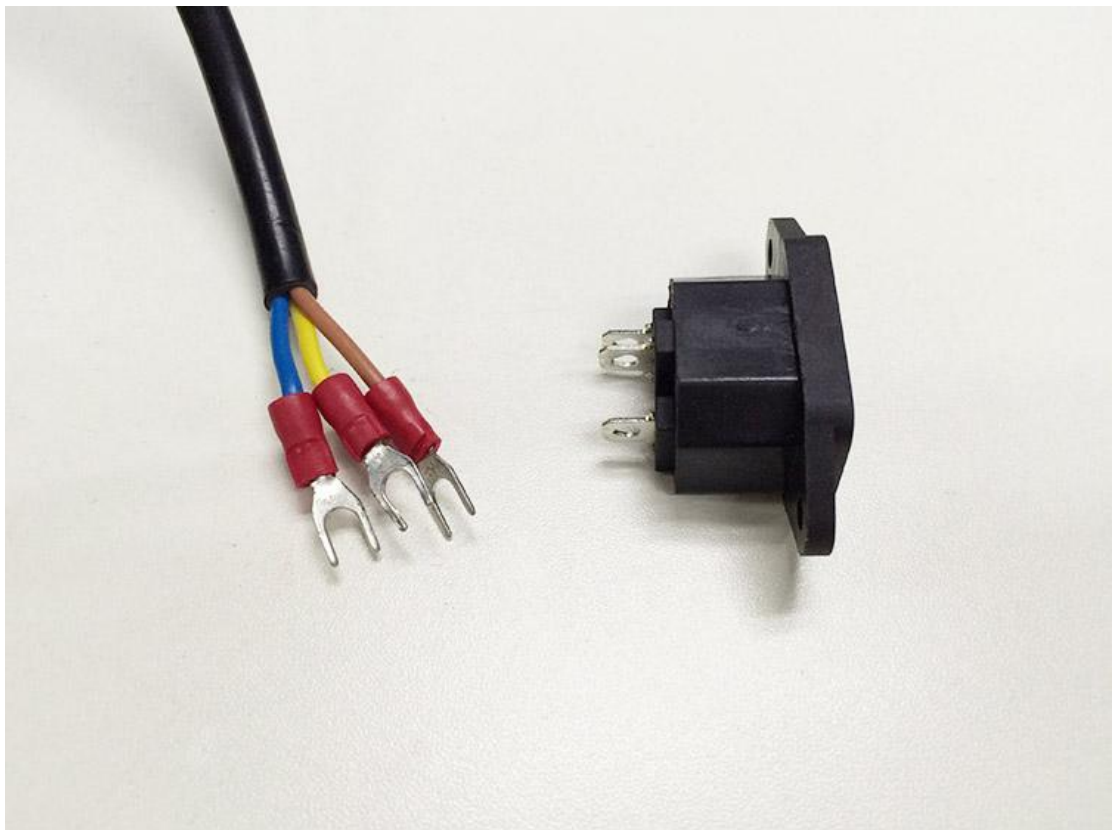
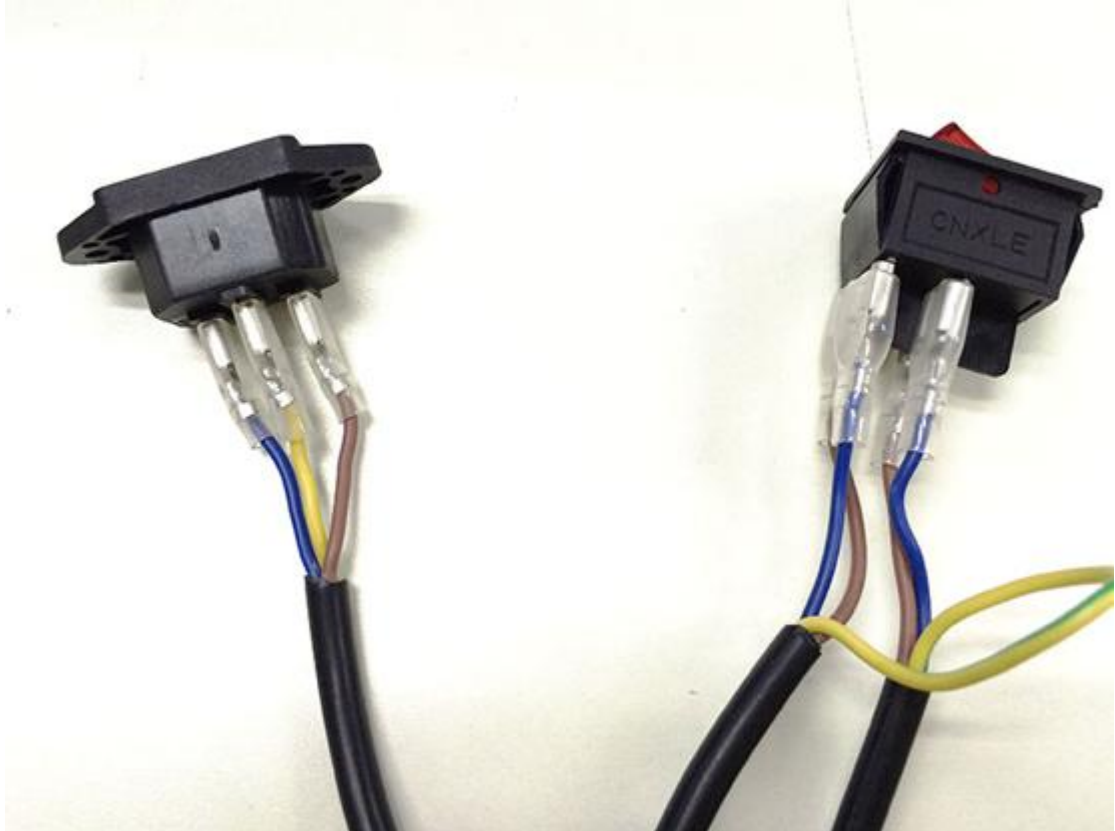

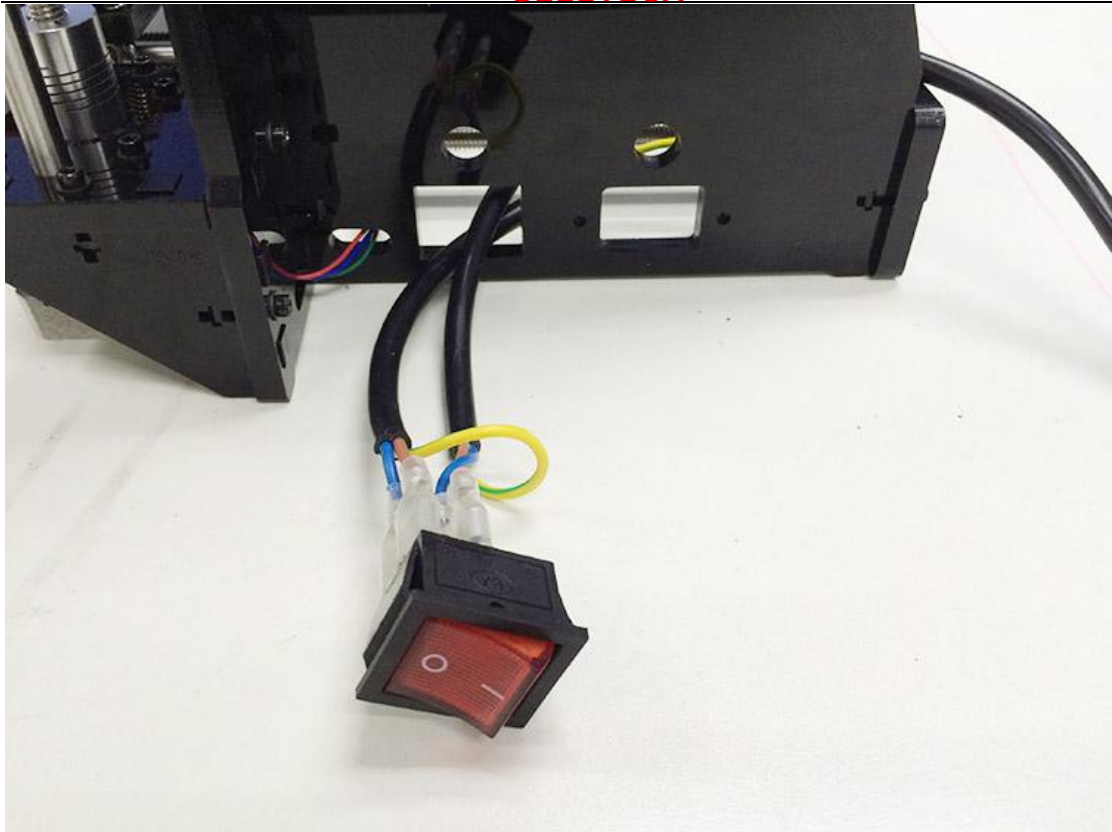

Step2. Mount the socket on the bottom of the right side panel with 2 M3 x 16 Hex Counter- sunk-head screws and M3 hex nut.



Step3. Thread the wires out.

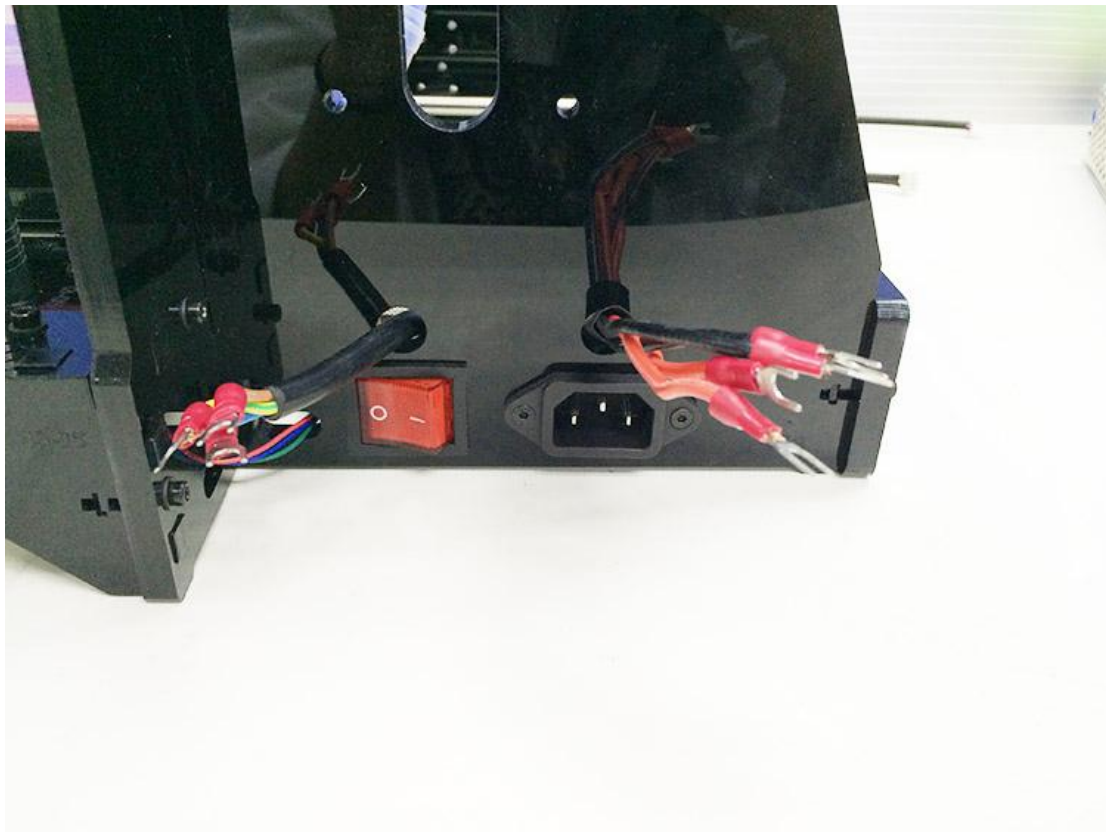

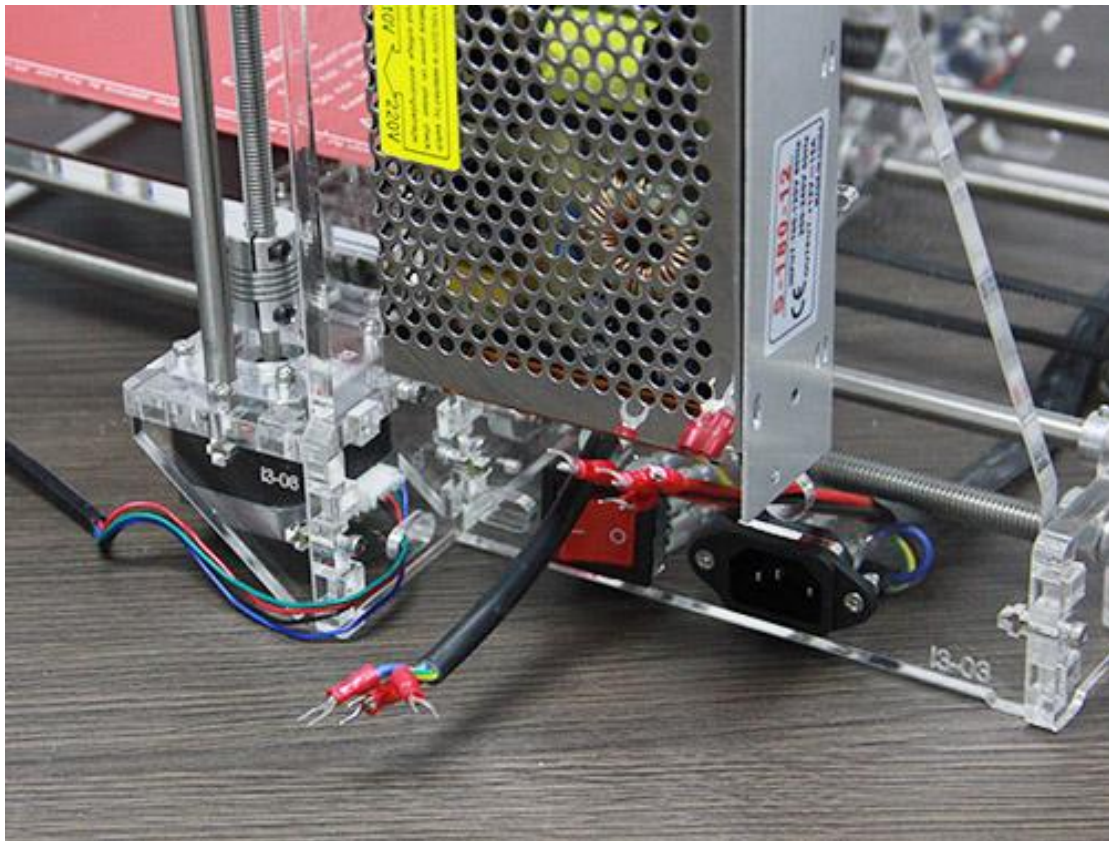

Step3. Mount the PSU (Power supply unit) on the right side panel with 3 M3 x 10 screws.

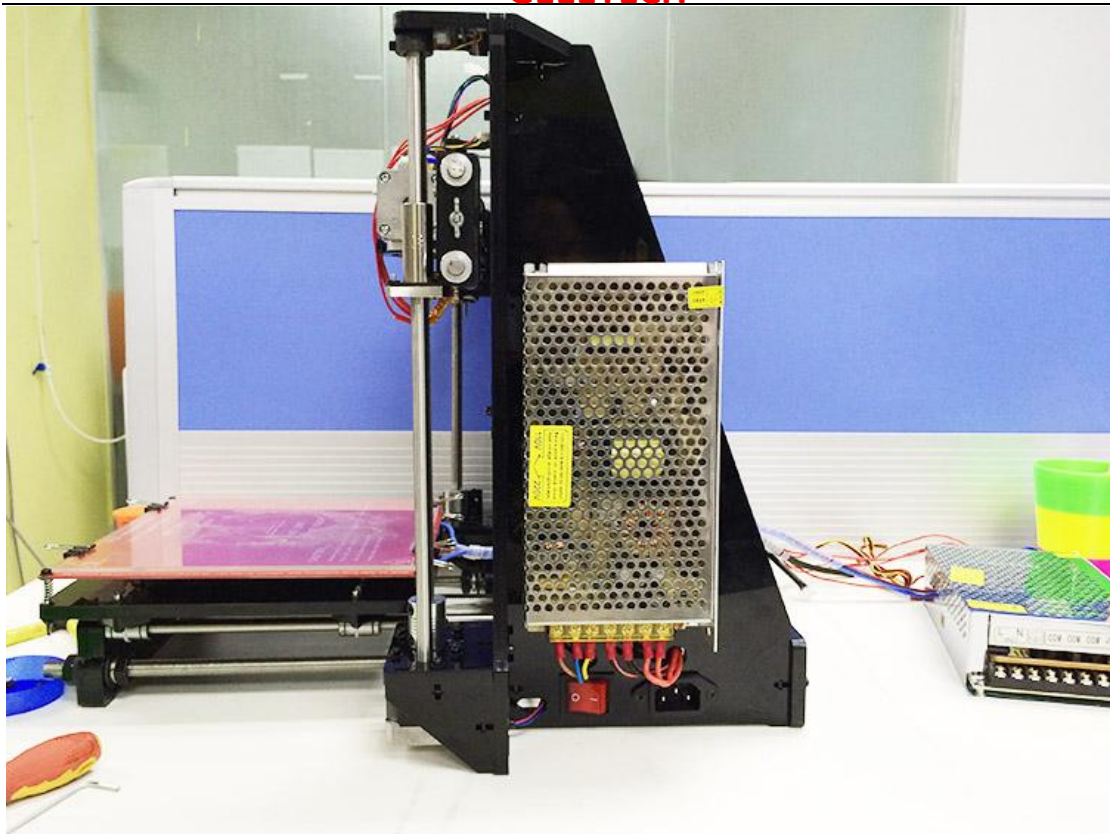

Step5. Now we can connect the wires to the PSU.

1) Mind the color of the wires. The wrong connection of the wire will cause serious damage to the PSU and even to the control board of the printer.

As you can see, there are 7 wires and 7 screws in total.

Note the correspondence between the color of wires and the connector.

**Brown-----L**

**Blue -----N**

**Yellow----- GND**

**Red ----- ++ V**

**Black-----COM**



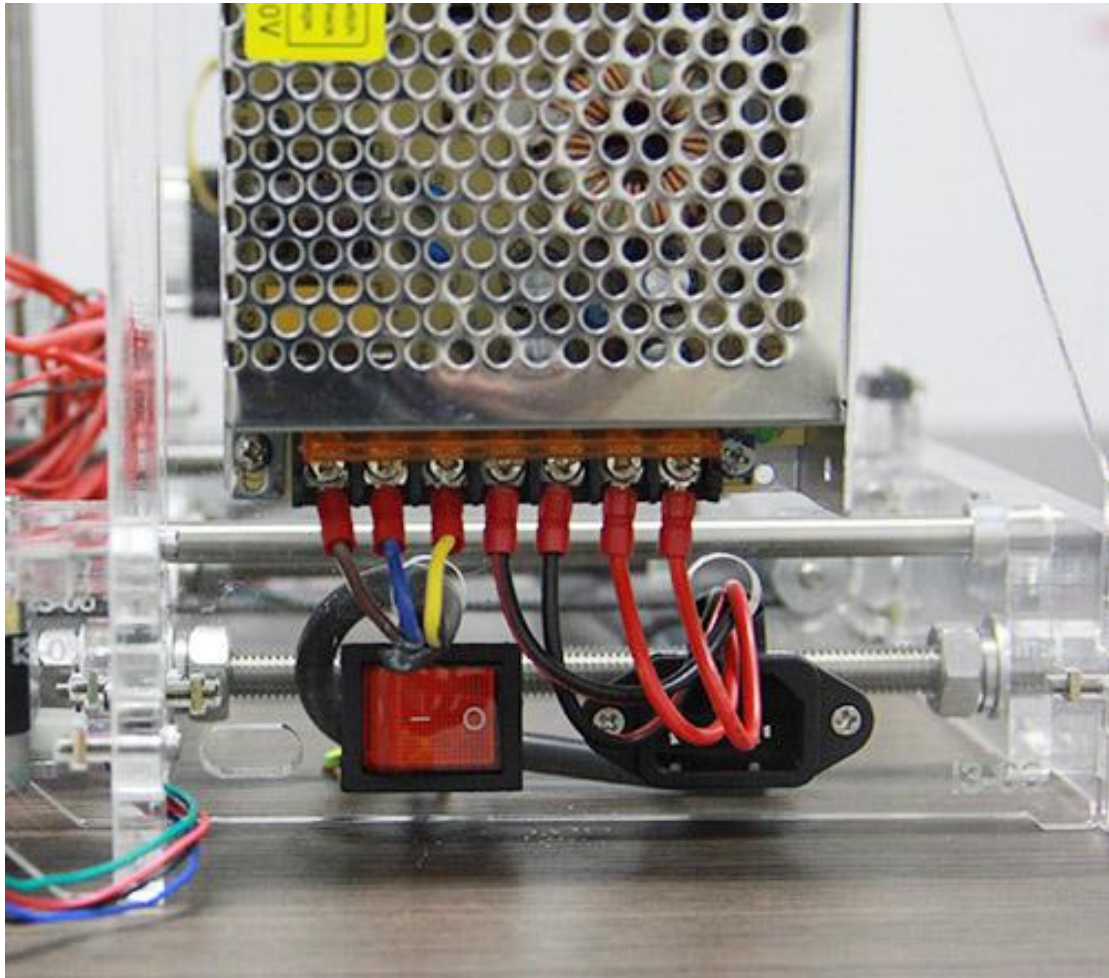



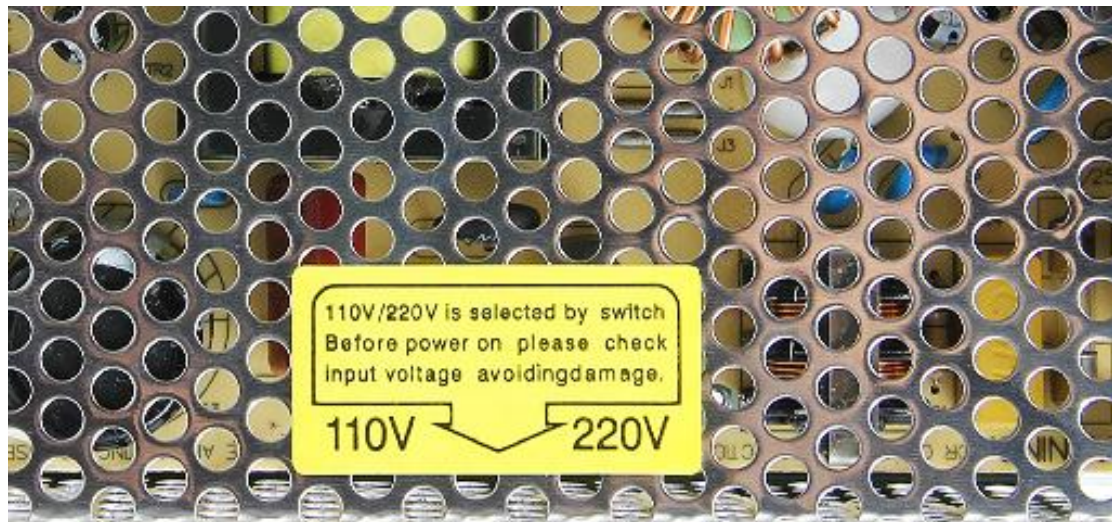

2) Pay attention to the switch on the right side of the PSU, there are two options of voltage: 110 V and 220V, choose according the standard in your country. As shown in the following picture. Remove the yellow paper; you can use some hard sticks to reach the switch.

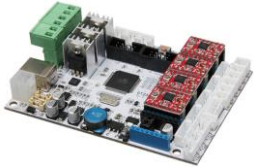

**Close the cover of the connector in case any electric shock.**

## 27. Mount the control board

[Watch the video](#)

Part name	Part ID	Required number	pic
Control board kit	No.64	1	
Sticker	No.50	1	
Heat sink	No.49	1	
Spacer	No.47	4	
M3 x 12 mm screw	No.26	4	

Step1. Cut the sticker into small pieces.

Step2. Past the heat sink onto the chip of the A4988 drivers (on the main board) . The sticker is double sided adhesive.

Step3. Insert the spacer into the holes of the board from back to front, Mount the board kit on the left side panel with 4 M3 x 12mm screws and M3 washers on the side panel.

Note the direction of the board; the green connectors are downwards to get enough heat dissipation from the fan.

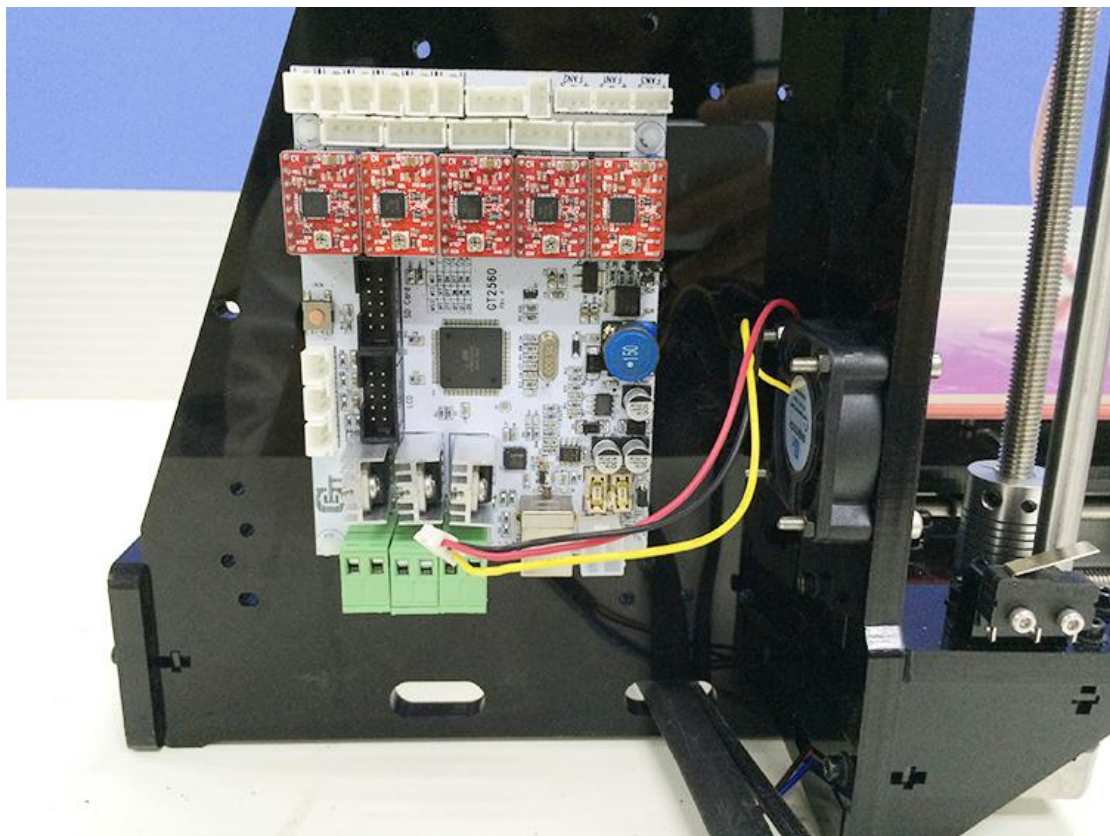

## 28 Wiring

### GT2560

Before you start wiring, please take a look at the wiring schematics.

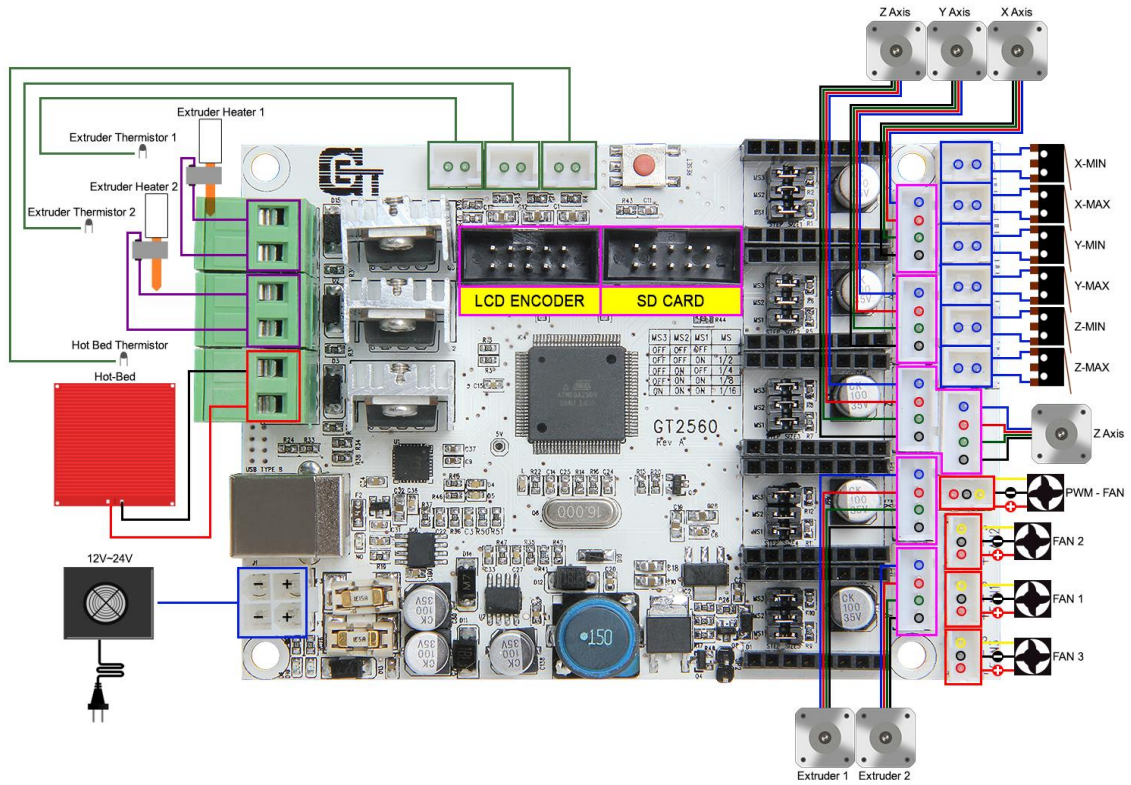

You can see original picture [here](#).

Step1. The subdivision of stepper motor can be setup by jumper cap, plug all the jumper caps (For A4988)

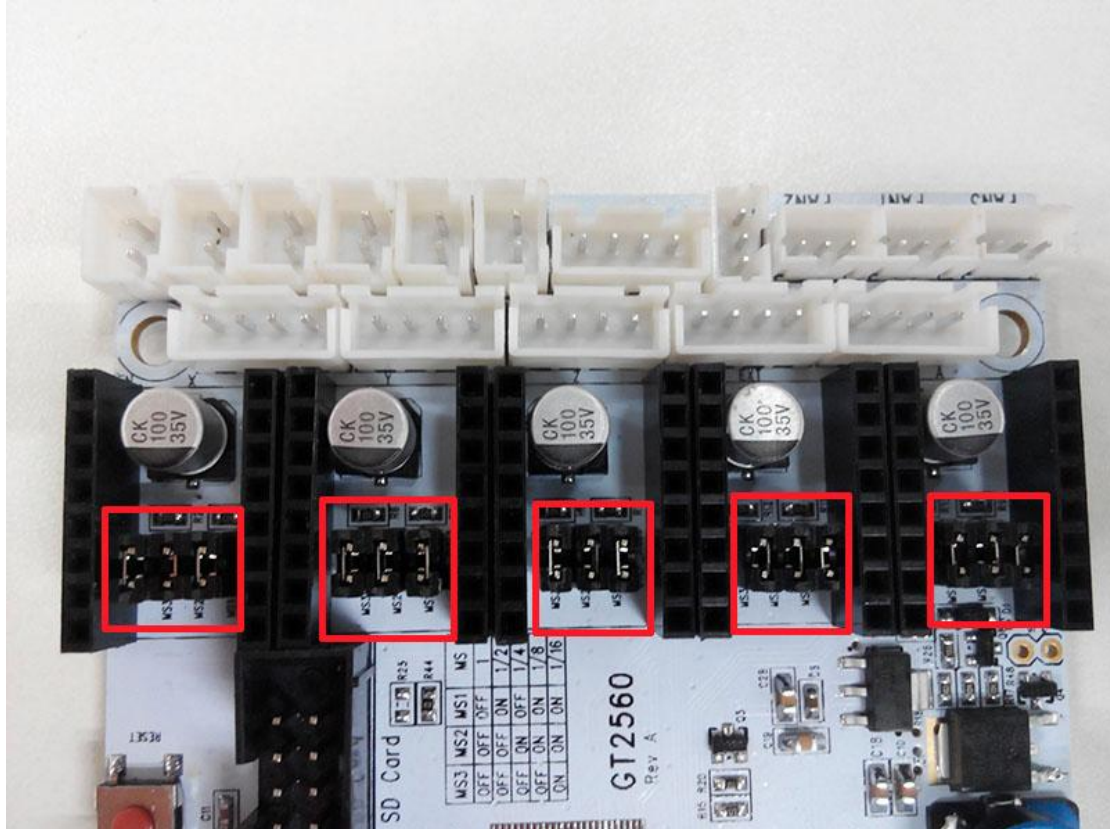

If you are using DRV8825 instead of A4988, the jumper caps should be changed as follow:

Note please, as your printer is single extruder, you will not use the extruder 2.

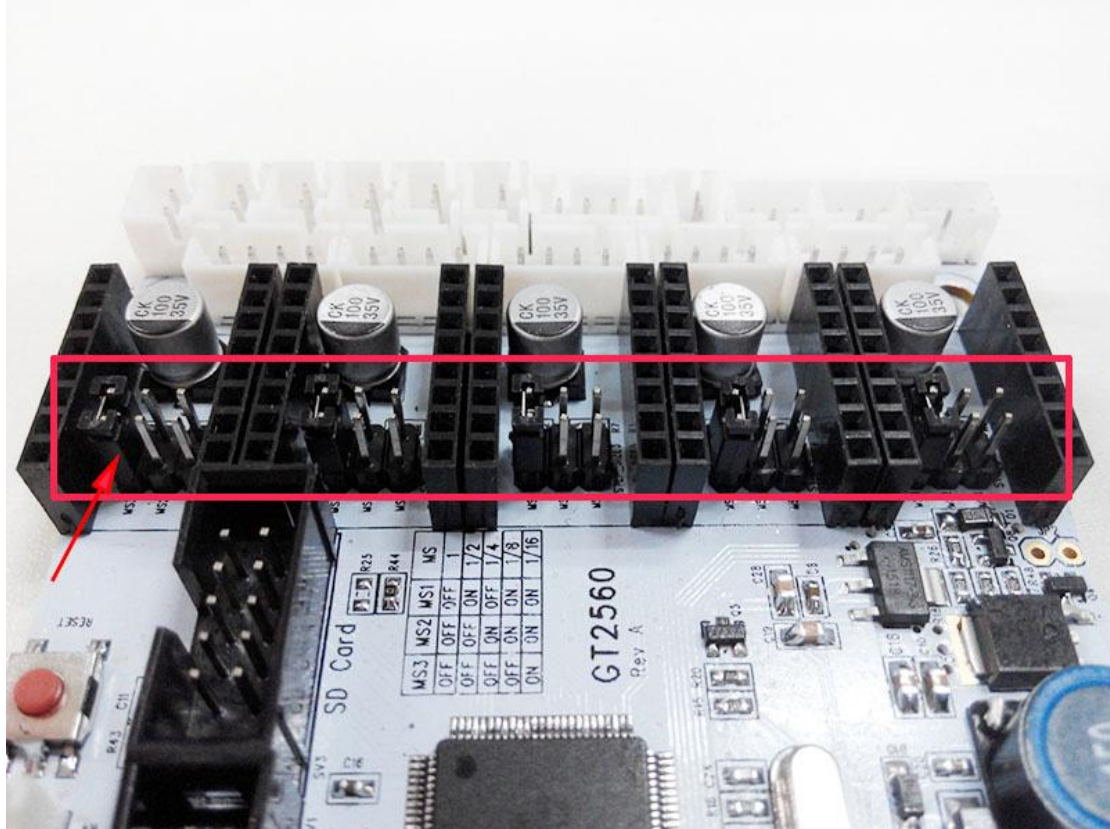

Step2. Plug the 4 A4988 into the stepper motor driver slot. Mind the directions of A4988.

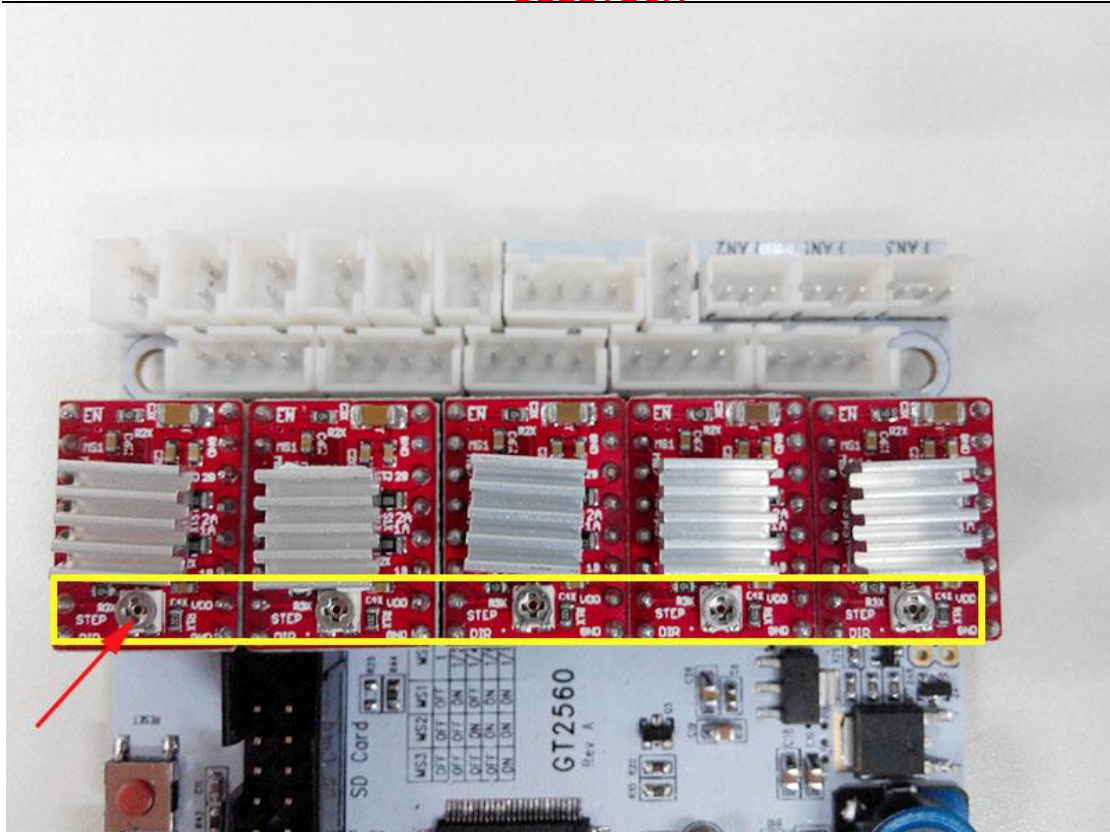

If you are using DRV8825 instead of A4988, The correct connections are as follow:

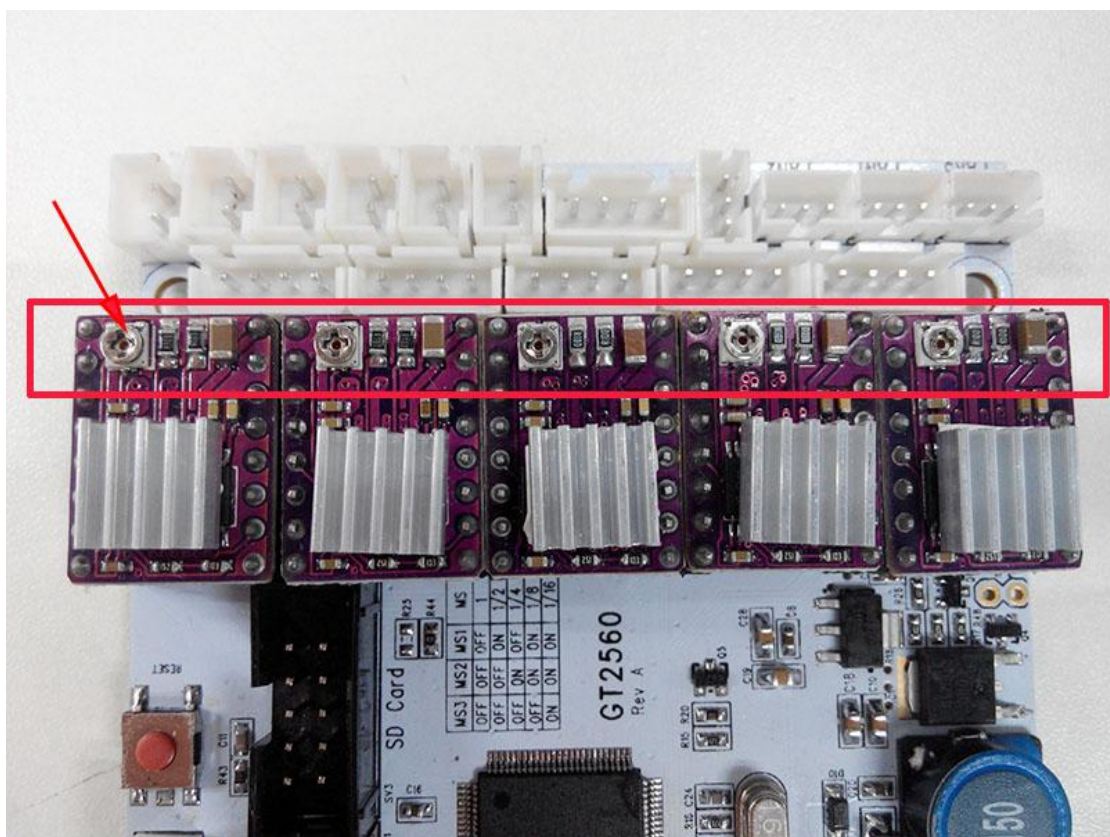

For your convenience, the above two steps is finished by us. you can skip them.

Step3. Connect wires for motors.

1) Connect wires for X-axis motor.

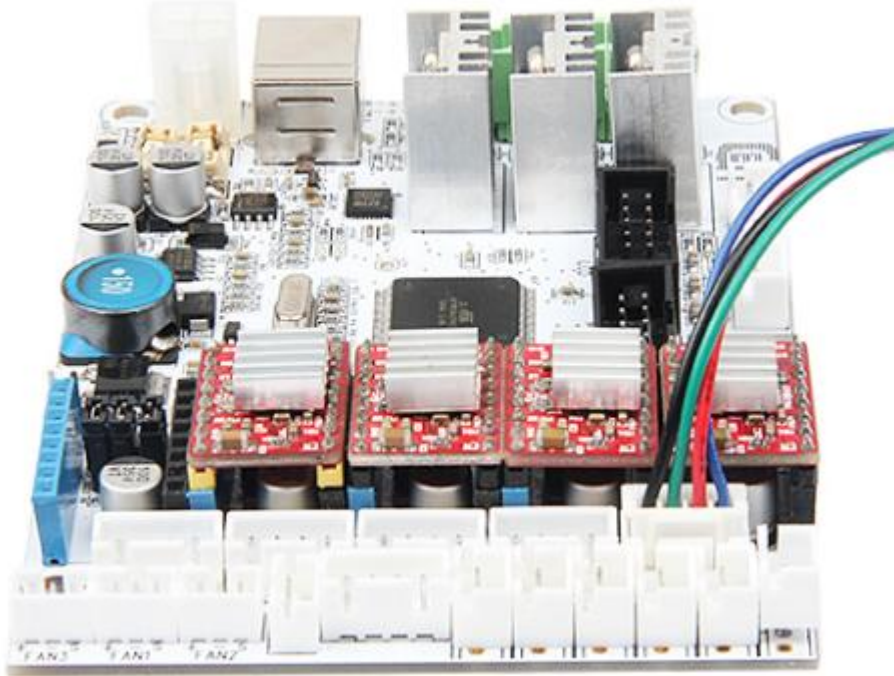

2) Connect wires for Y-axis motor.

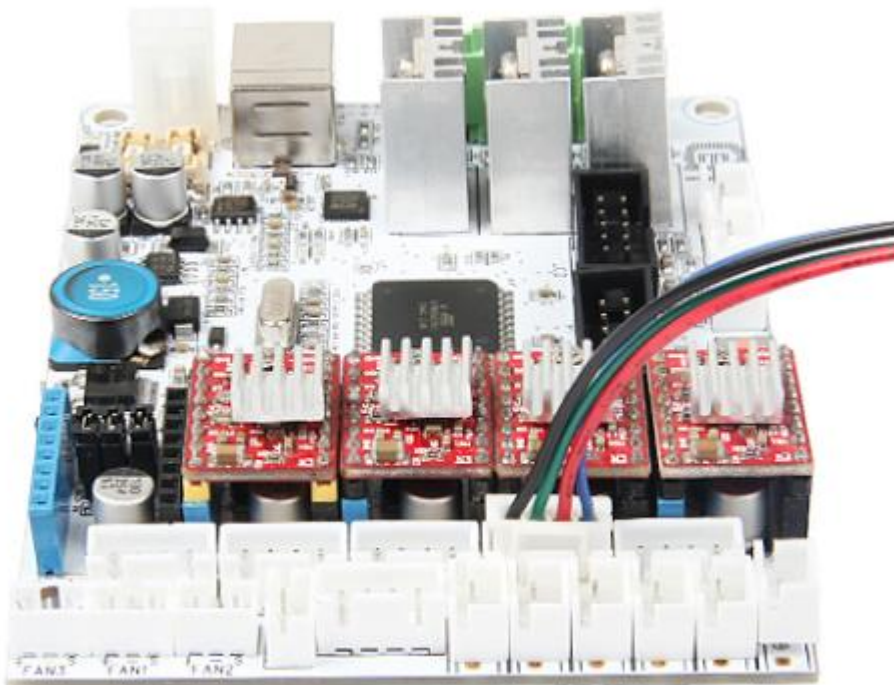



3) Connect wires for 2 Z-axis motors.

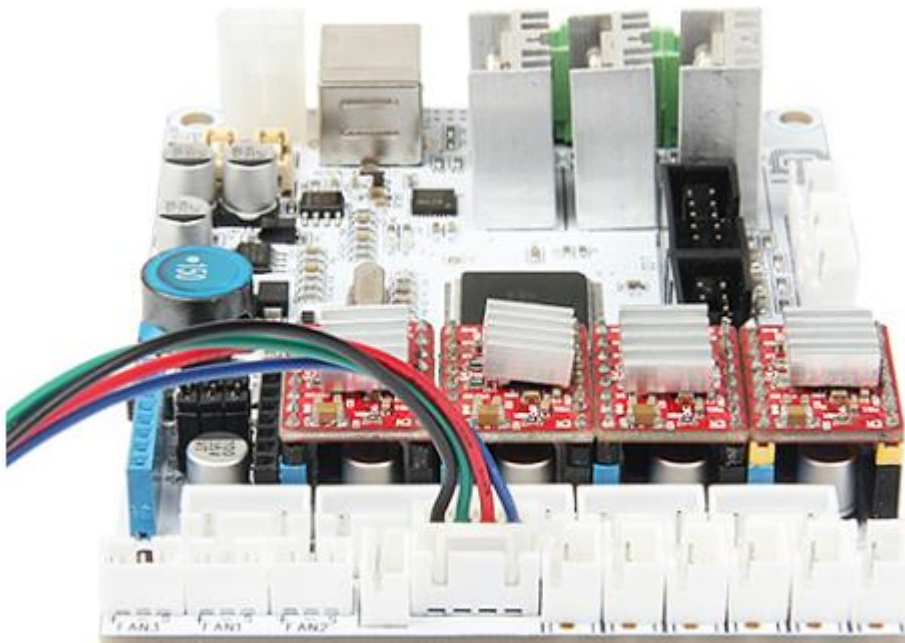
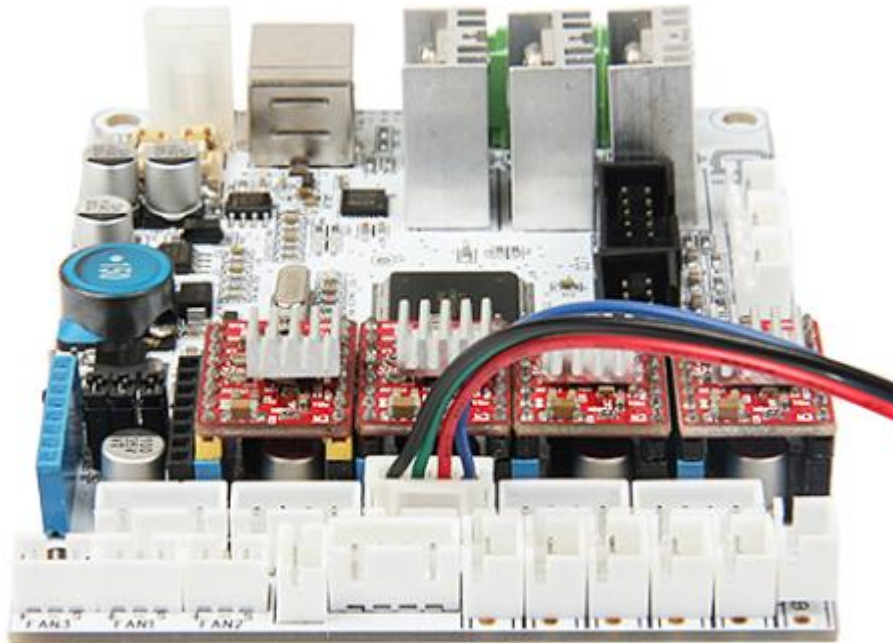

4) Connect Extruder motors.

You can connect the extruder to either of the motor slot.

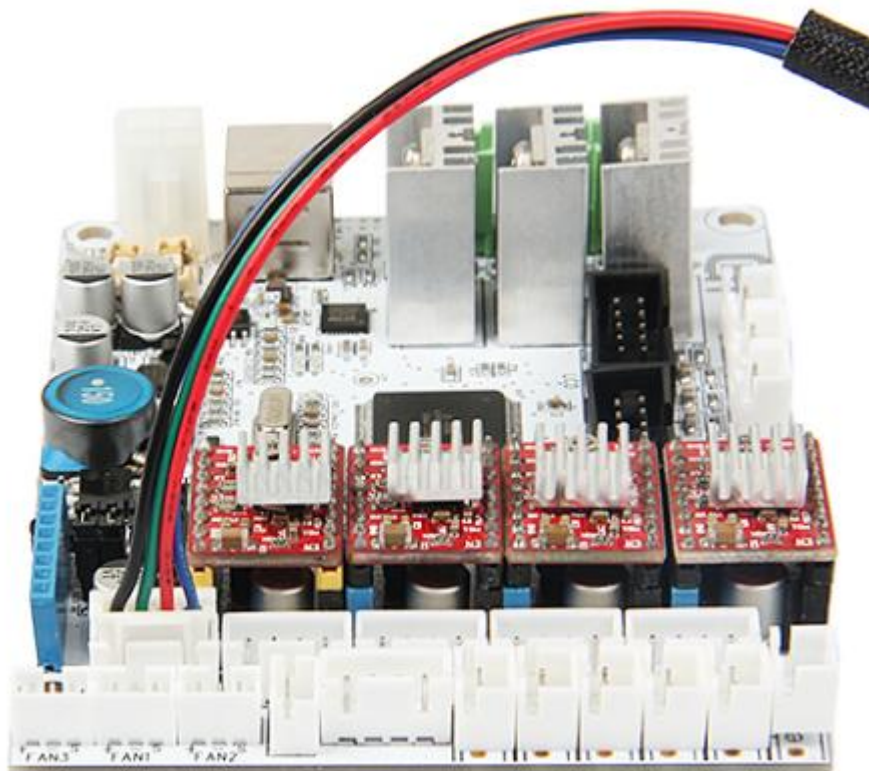
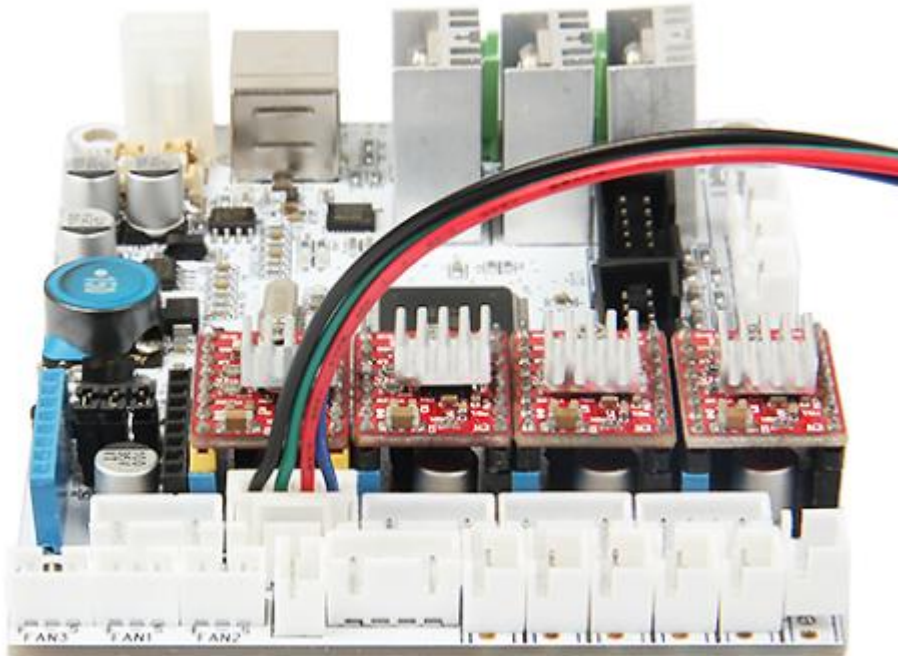

**Step4. Connect heating wires.**

Loosed the screws in the green terminal and put the red wires into the slot and screw it up. \* There is no “+” and “-“for heating wires

- 1) Connect heating wires for heatbed.

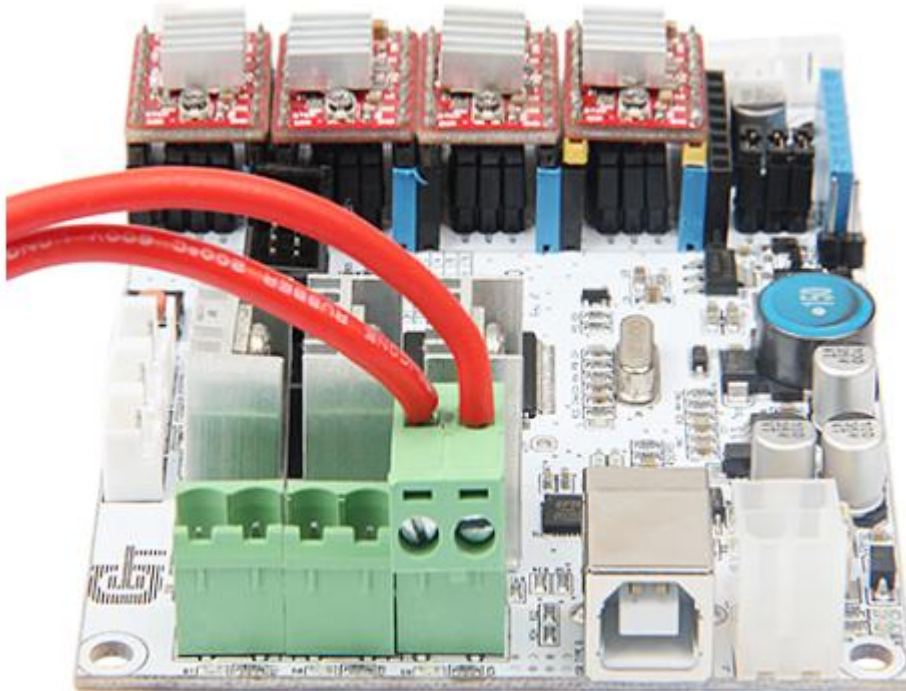

- 2) Connect heating wires for extruder 1.

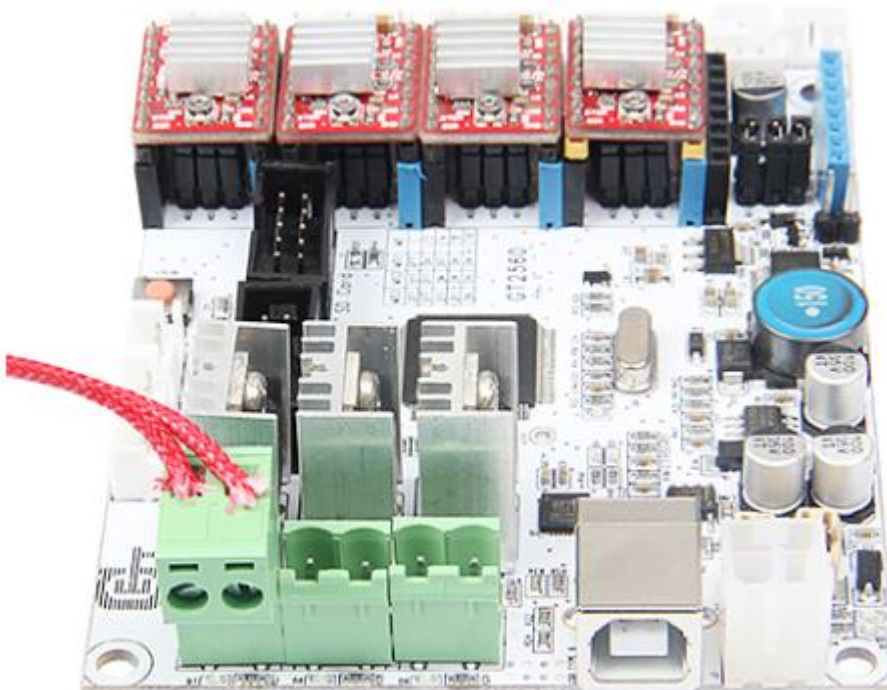

- 3) Connect heating wires for extruder 2.

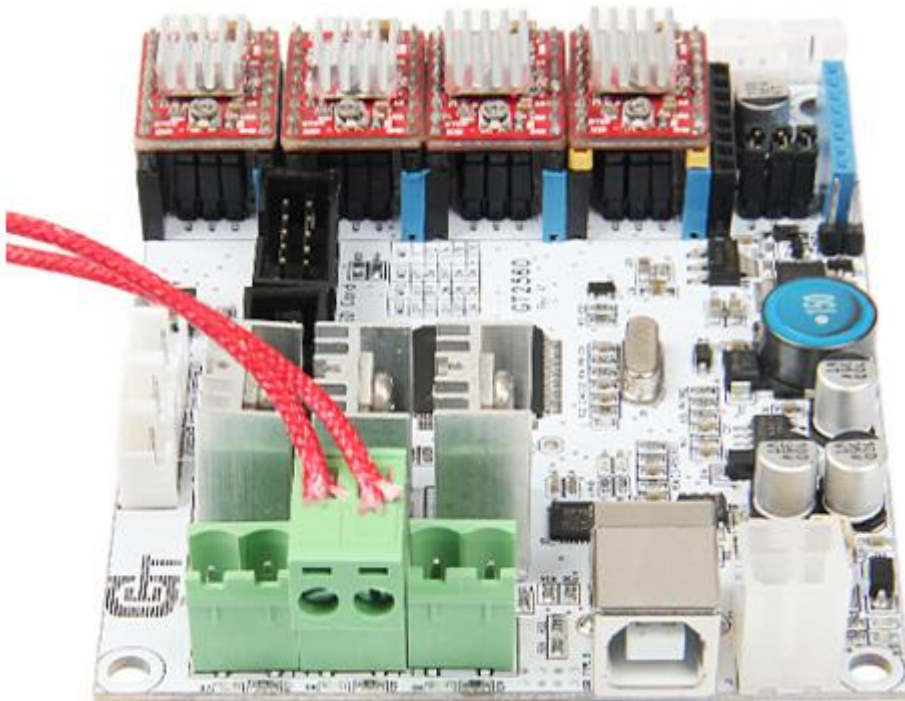

**Step4. Connect wires for thermistor.**

- 1) Connect wires for thermistor of heated.

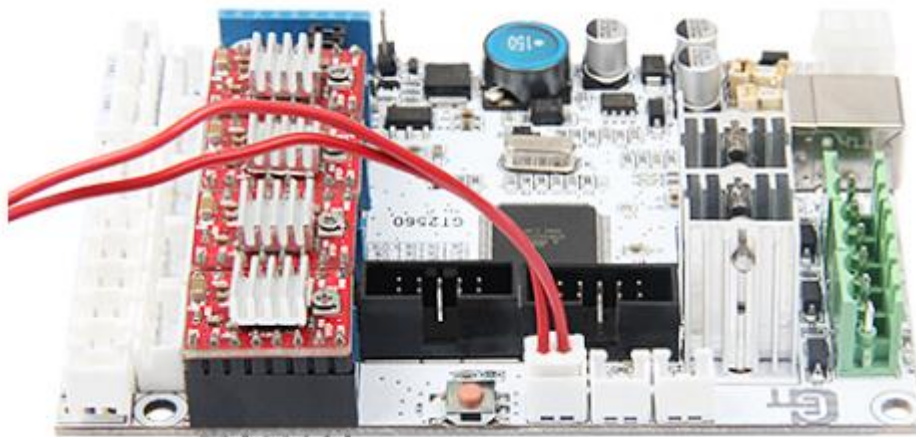

- 2) Connect wires for thermistor of extruder 1.

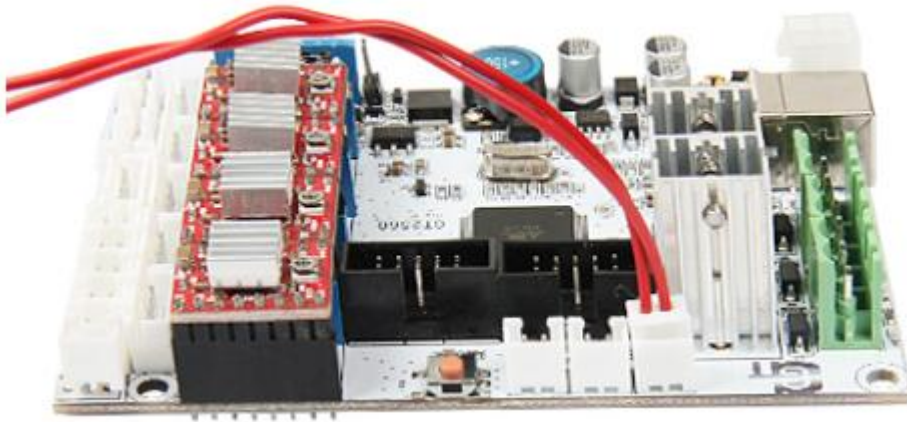

3) Connect wires for thermistor of extruder 2.

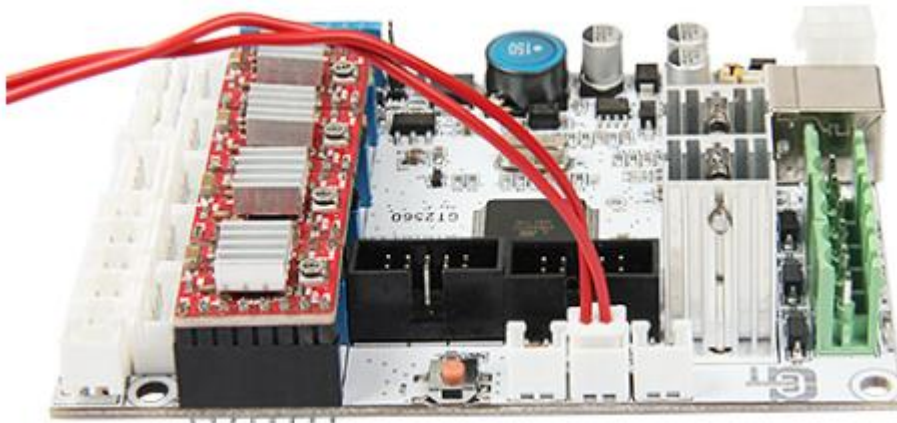

**Step5. Connect wires for endstop.** \* There is no “+” and “-“for endstop

1) Connect wires for endstop of X-axis at X-Min.

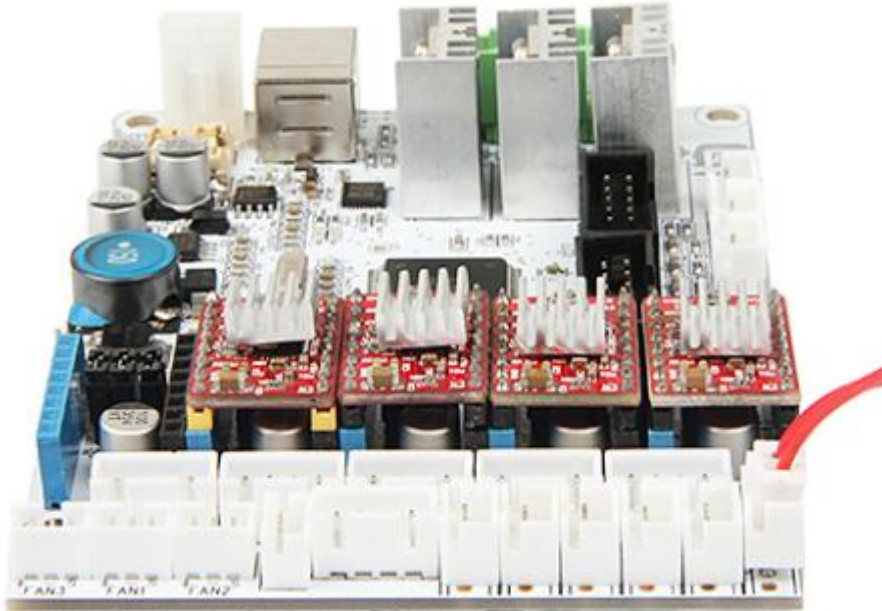

2) Connect wires for endstop of Y-axis at Y-Min.

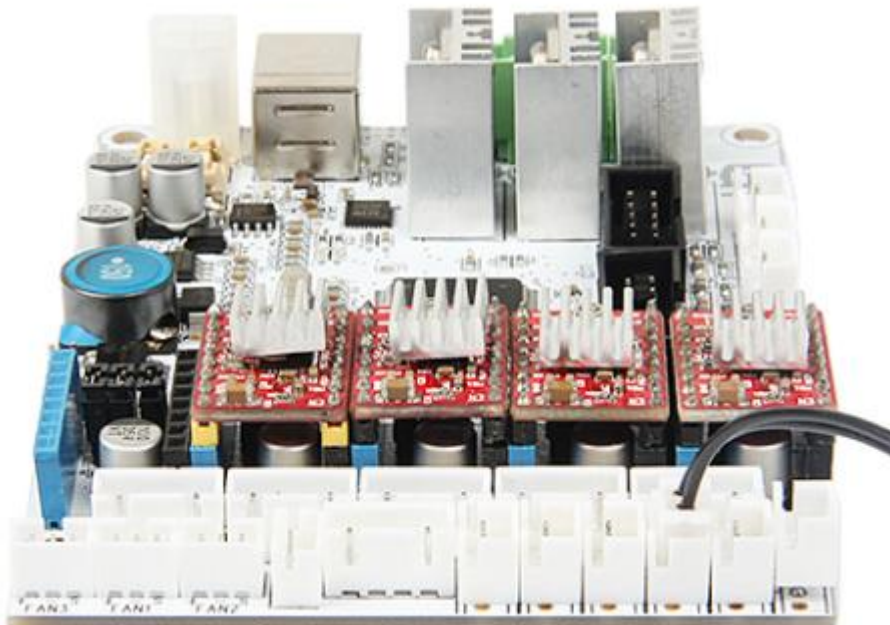

3) Connect wires for endstop of Z-axis at Z-Min.

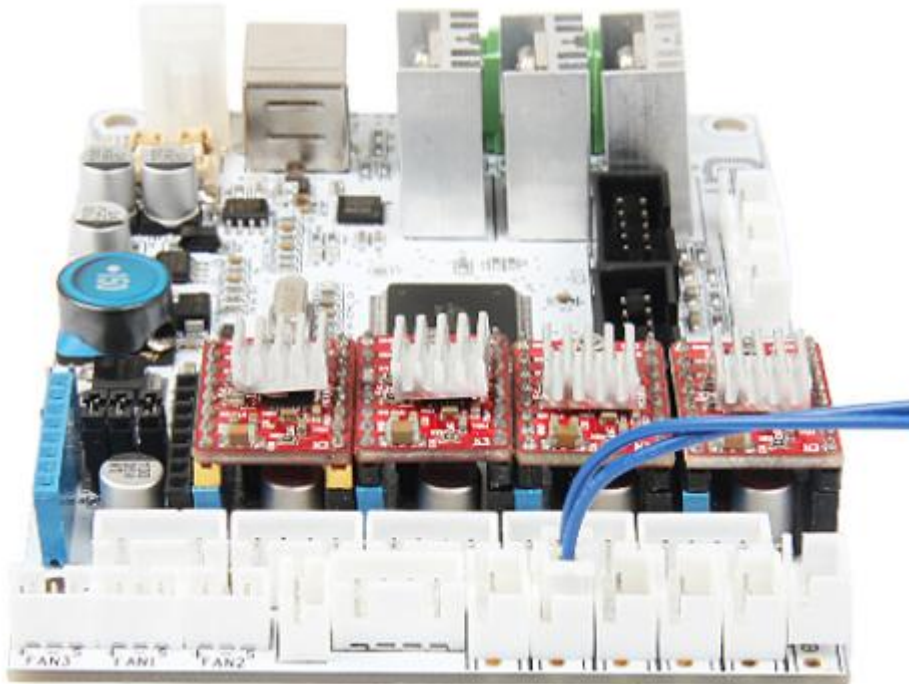

**Step6. Connect wires for Fan.**

- 1) Connect fan for control board at FAN3.

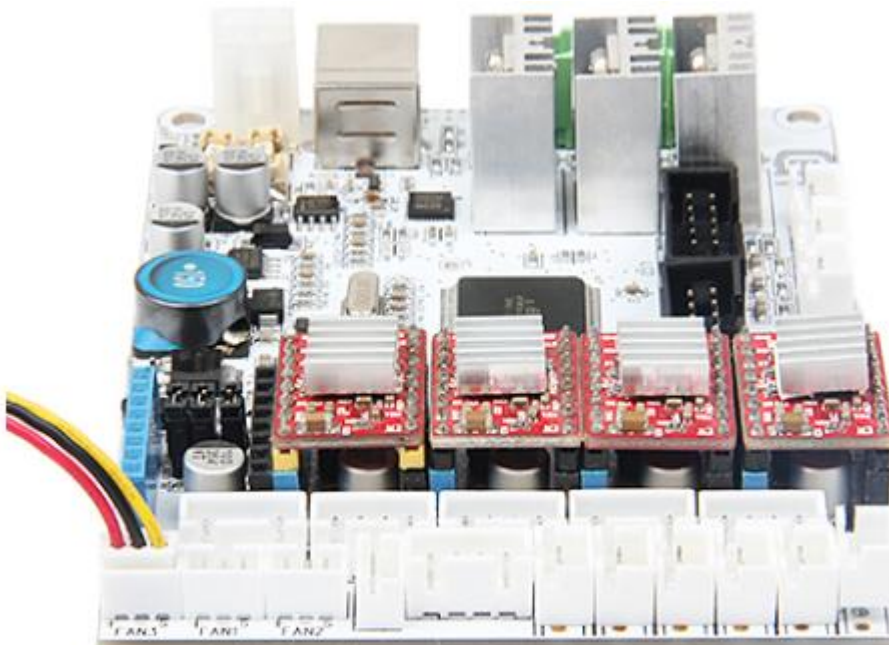

- 2) Connect fan for extruder at FAN1.

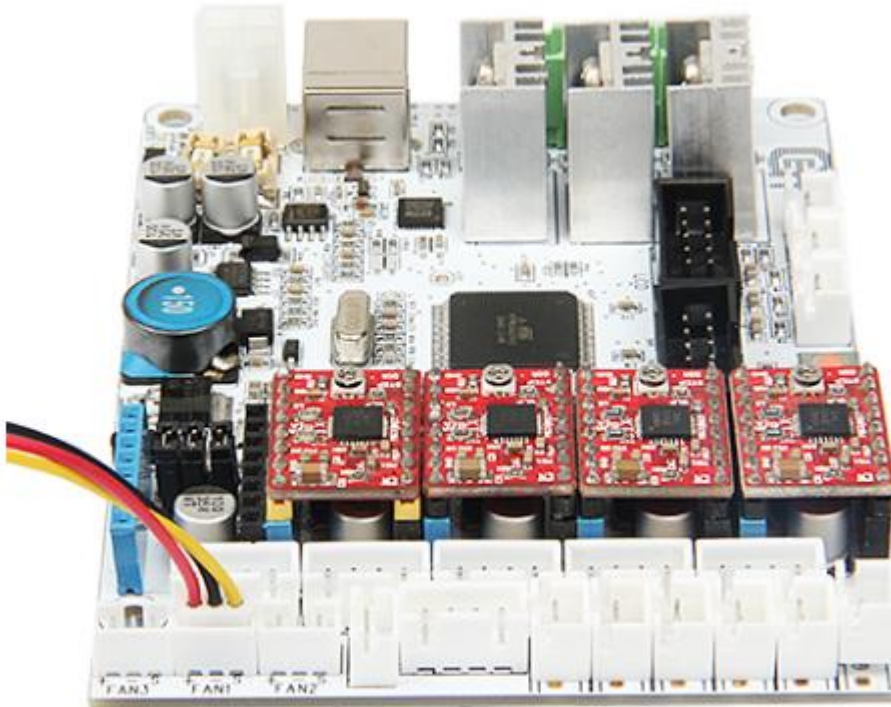

**Step7. Connect wires for LCD panel.**

There are two cables, one is for LCD encoder, the other is for SD card, do not connect them reversed.

EXP1 to LCD

EXP2 to SD card

BTW, do you see the small screw above the SD card reader, if the text in of the LCD phases in an out or there is only blocks on the screen, you can adjust this screw to recovery it.



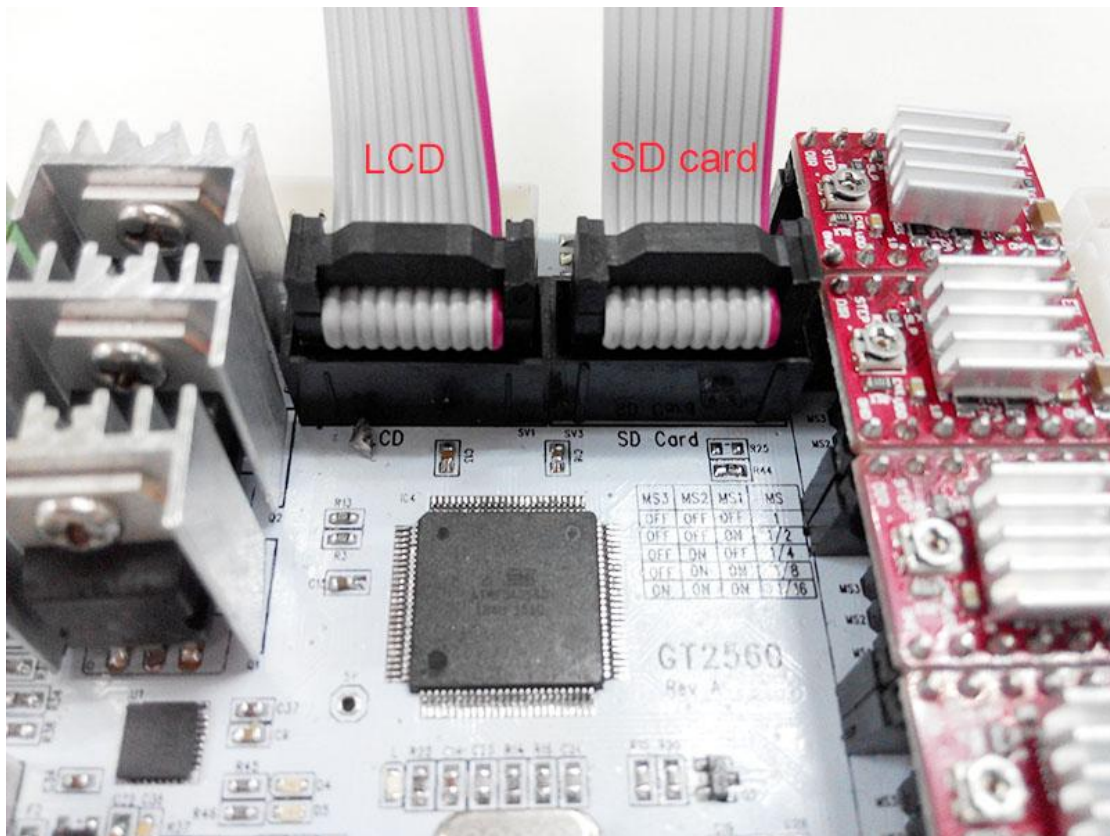
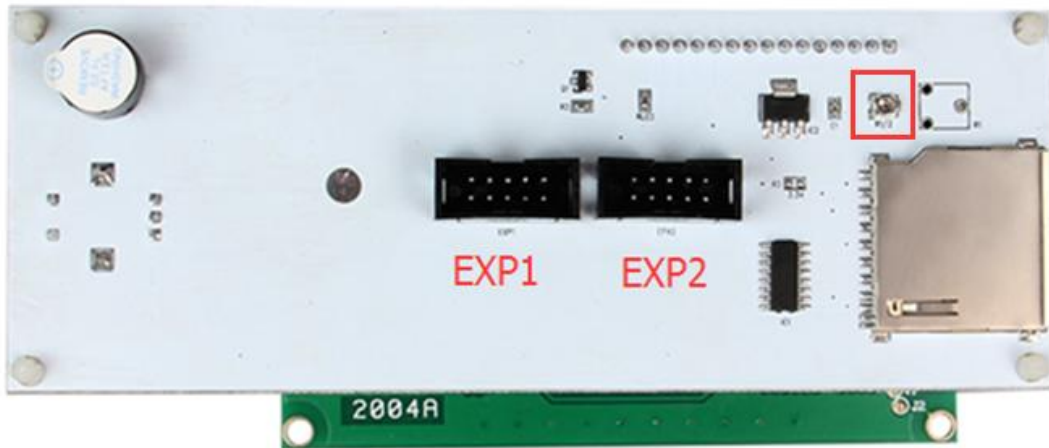

**Step8. Connect wires for power input.**

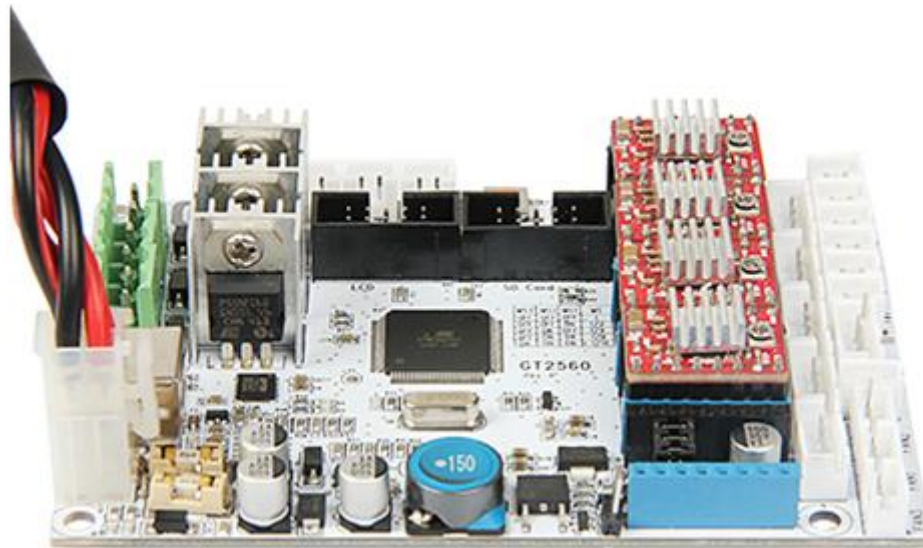





That is all for the wiring of GT2560.

### 29 Tidy out the wires.

Use the wire coil to tie put those wires together. There are holes on the acrylic plates for the wires, you can arrange them as you like.

### 30 Mount the filament spool.

Required parts	Required number	Part ID	Pic
Filament side panel			
M3 x 16 screw	4	NO.27	
M3 square nut	4	NO.17	

PVC tube	2		
----------	---	--	---



The whole printer assembly work is already done.

### **31 Tips**

Before even attempting the first print it is vital that the printer is correctly calibrated. Skipping or rushing this step will result in frustration and failed prints later, so it is important to take the time to make sure the machine is correctly set up.

Each machine may have its own calibration procedure and this manual will not attempt to cover all the variations. Instead here is a list of key points that should be

addressed.

- Frame is stable and correctly aligned.
- Rods are correctly aligned
- Belts are taut.
- Driving wheel turns smoothly
- Bed is level in relation to the path of the extruder.
- Filament rolls freely from the spool, without causing too much tension on the extruder.
- Current for stepper motors is set to the correct level.
- Wires are correctly connected
- Couplings and pulleys are fixed tightly

Firmware settings are correct including: axis movement speeds and acceleration; temperature control; end-stops; motor directions.

Extruder is calibrated in the firmware with the correct steps per mm of filament.

The point regarding the extruder step rate is vital. Slic3r expects that the machine will accurately produce a set amount of filament when told to do so. Too much will result in blobs and other imperfections in the print, too little will result in gaps and poor inter-layer adhesion. For how to set up the printer, please visit:

To know how to set up, please refer to the user manual.