



ASSEMBLY HARDWARE



G* GRASS®

ASSEMBLY HARDWARE

Installation and assembly hardware for professional efficiency

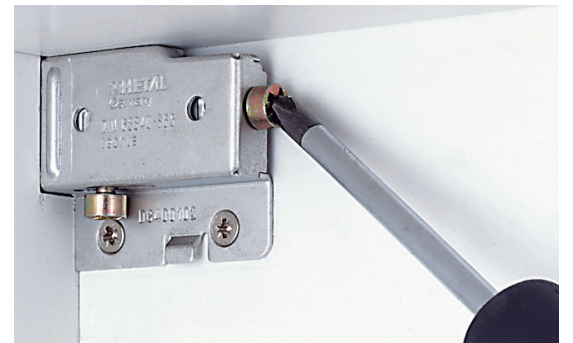

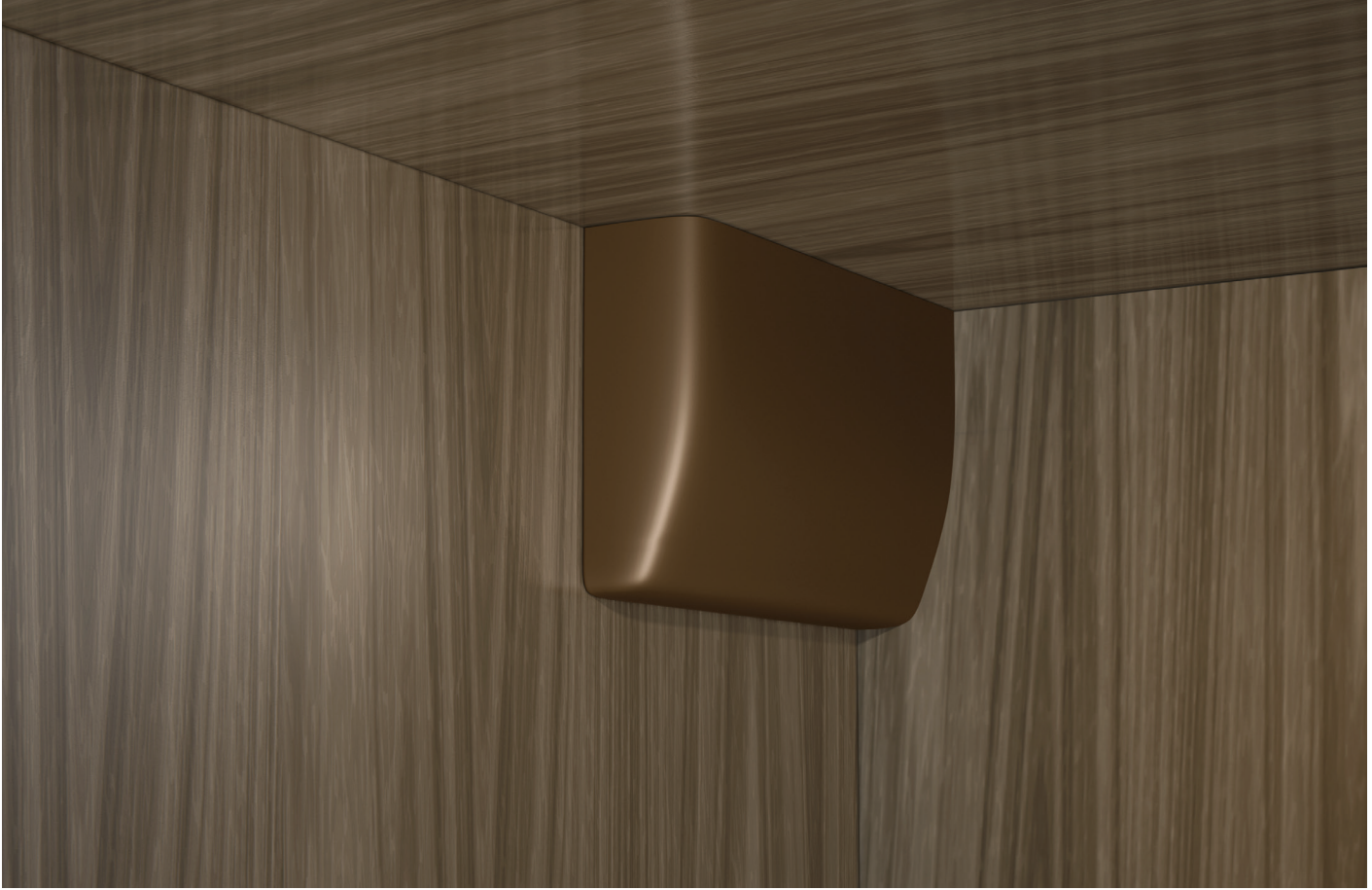

Installation and assembly aids for all product families -
designed to suit our customer's needs.

Whether you want to insert a hinge or assemble
a drawer - Grass machinery offers the most
economical solution.

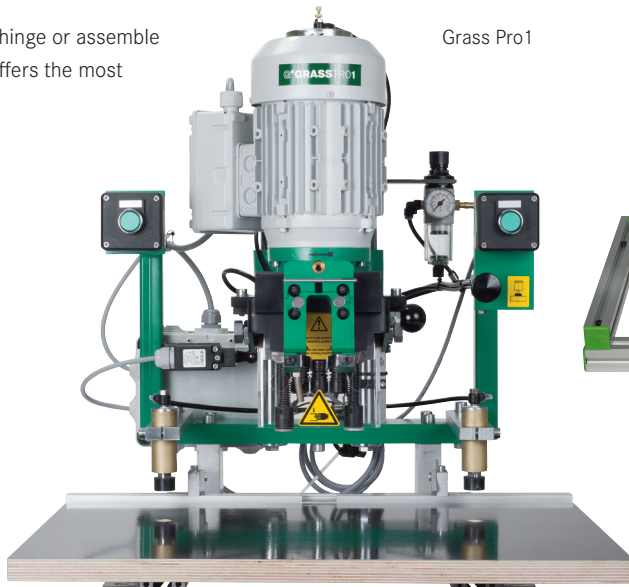



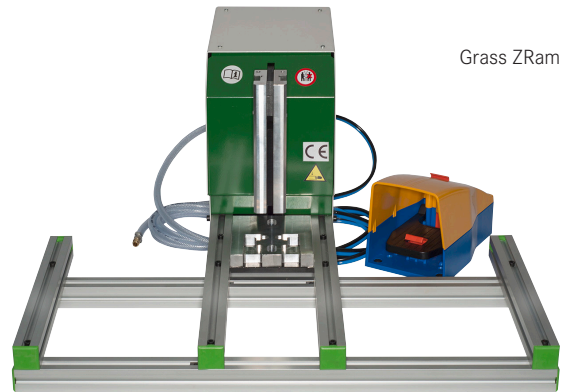





Grass Pro1

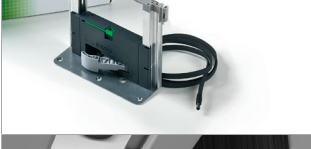

Grass ZRam

Table of Content

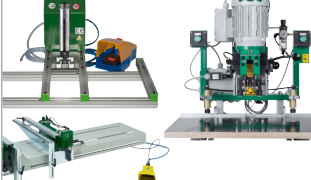
	Description		Page
	<p>Cabinet Suspension System</p> <ul style="list-style-type: none"> • All steel suspension system • Carrying capacity - 286 lb 		4
	<p>UniSoft</p> <ul style="list-style-type: none"> • For all face frame overlay cabinets • For full overlay frameless cabinets 		6
	<p>Tipmatic</p> <ul style="list-style-type: none"> • For use with free swinging hinges • For handle free doors 		7
	<p>Soft-close Damper</p> <ul style="list-style-type: none"> • For Zargen and Integra Slides • Easy to mount 		8
	<p>Sensomatic</p> <ul style="list-style-type: none"> • For Vionaro and Dynapro • Automatic drawer opening 		8
	<p>Accessories</p> <ul style="list-style-type: none"> • Door protectors • Alignment aids 		9
	<p>Shelf Supports and Bumpers</p> <ul style="list-style-type: none"> • Supports made from steel and plastic • Various styles of plastic bumpers 		10
	<p>Screws and Dowels</p> <ul style="list-style-type: none"> • Euro and wood screws • Dowels for hinges and slides 		11
	<p>Assembly aids</p> <ul style="list-style-type: none"> • For Elite Plus • For Vionaro • For TEC 		12
	<p>Machinery</p> <ul style="list-style-type: none"> • Grass PRO1 for 45mm boring • Grass PRO1 and ZRam for Zargen and Zbox • Grass PRO1 and Tecmator for Vionaro 		13

Cabinet Suspension System

Suspension rail, brackets, and covers



- All steel suspension system
- Carrying capacity - 286 lb
- Plastic covers available
- Precision height, depth, and side adjustments for brackets
- Self-centering suspension rail - 16" center to center

Suspension Rail, Covers

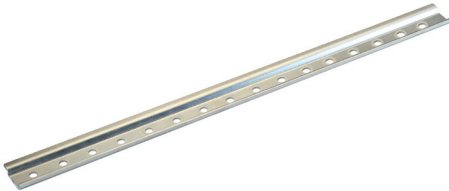

Description	Length	Material/Color	Item No.	PU
Rail	2438mm (96")	Steel	499.831.00.1719	25
Cover	2438mm (96")	Plastic, almond	499.831.00.0153	50
Cover	2438mm (96")	Plastic, brown	499.831.00.0158	50
Cover	2438mm (96")	Plastic, white	499.831.00.0174	50

Suspension Bracket with Cover Cap

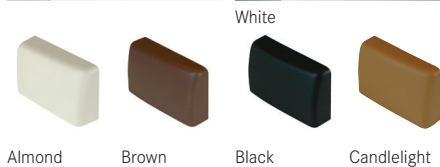
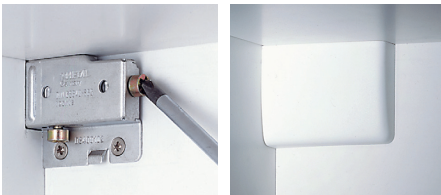

Description	Material/Color	Item No. Left	Item No. Right	PU
Bracket	Steel	F155145067 233	F155145068 233	200
Cover	Plastic, white	F155145038 133	F155145039 133	200
Cover	Plastic, almond	F155145062 133	F155145066 133	200
Cover	Plastic, brown	F155145060 133	F155145064 133	200
Cover	Plastic, black	F155145061 133	F155145065 133	200
Cover	Plastic, candlelight	F155145059 133	F155145063 133	200

Assembly Screw



Description	Material/Color	Item No.	PU
6.3 x 16mm panhead screw	Steel	499.390.62.6115	5000

PU - Packaging unit

Suspension Rail Installation

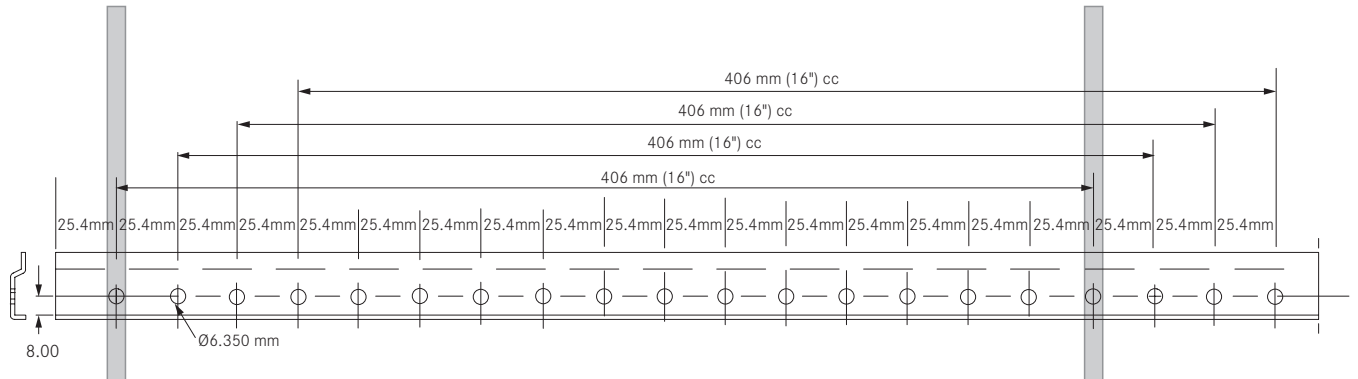

Suspension System Installation

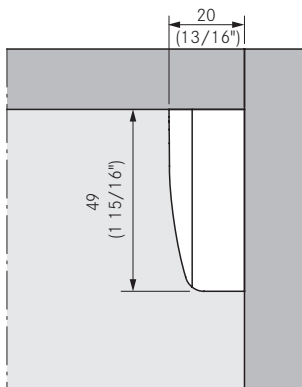

Fixture for closet

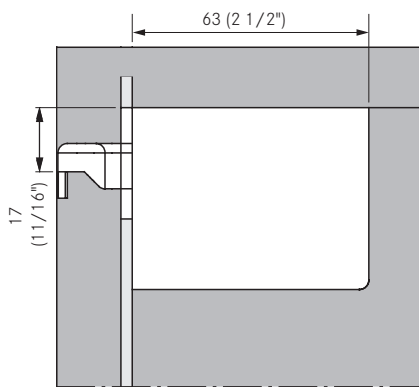

Fixture for cabinet

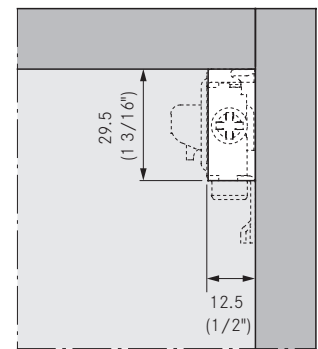

Adjustment

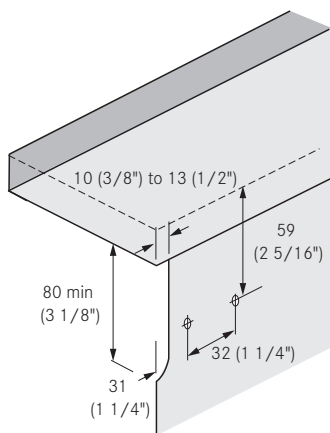

Suspension rail adjustment range:

- Downwards 10mm (3/8")
- Upwards 8mm (5/16")
- To the rear 7mm (1/4")
- To the front 7mm (1/4")
- To the left 9mm (11/32")
- To the right 9mm (11/32")

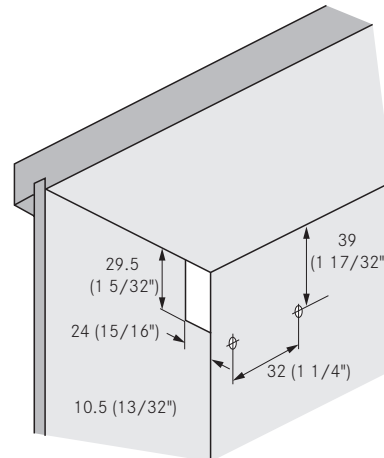

Suspension rail adjustment range:

- Downwards 10mm (3/8")
- Upwards 8mm (5/16")
- To the rear 7mm (1/4")
- To the front 7mm (1/4")
- To the left 9mm (11/32")
- To the right 9mm (11/32")

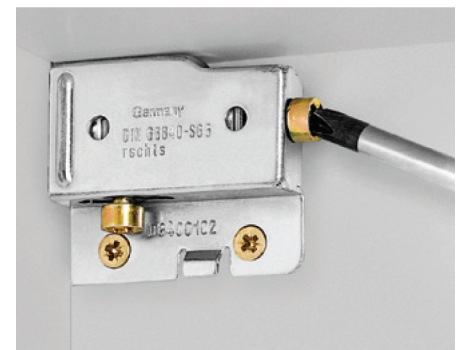

Soft-close for doors



- Works for face frame cabinets on all door overlays
- Works for frameless cabinets on full overlay doors
- Brushed nickel look blends in well with hinge finish
- Non-handed with a low profile design
- Manually adjustable to desired closing speed
- Mounts independently from the hinge in the upper corner of the cabinet
- Instantly allows the cabinet door to close quietly and smoothly
- Scratch protector and front bumper with cushion for a quiet close

UniSoft Adapter



Description	Material	Item No.	PU
UniSoft, Polybag	Plastic, chrome	18971-37	1
UniSoft, Polybag Bulk	Plastic, chrome	18971-40	25
UniSoft, Bulk	Plastic, chrome	18971-14	250

Includes #6 x 3/4 Pan head screw

Installation Mounting Position Adjustment

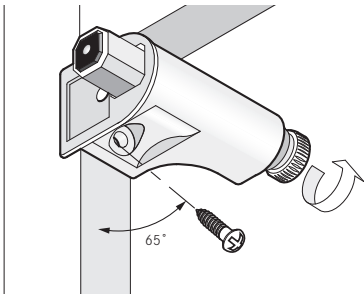

Use a 65° angle for best base results. Pilot drill 2.3mm (Ø3/32") and 1/4" deep for a #6 x 3/4" Pan head screw recommended. Mount in upper corner on hinge side.

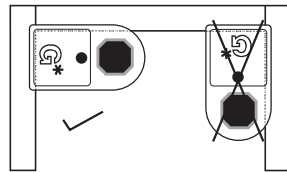

IMPORTANT The installation of our cabinetry hardware must comply with the Grass instructions that are stated on this catalog page.

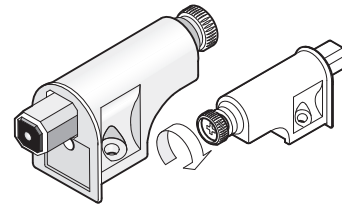

Turn adjustment screw to move damper in and out. Adjust in for heavier doors or out for light doors. Use Phillips or Pozidrive screwdriver or adjust manually.

Dimensions UniSoft per Door

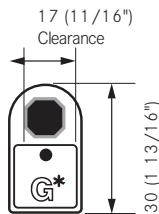
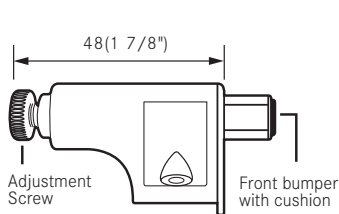

Use one UniSoft for most applications. For heavier doors use two or more. Trial mount recommended.

UniSoft Hinges

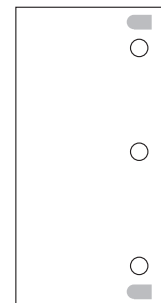
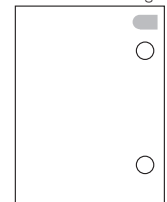

PU - Packaging unit

For handle-free wooden doors



- Gently tapping the front causes the doors to open to a convenient angle
- Use with Tiomos Tipmatic Plus or with Nexis and Tiomos free-swinging hinges
- Large magnet catch range – holds door closed securely
- Gap adjustment from 2.5 to 5.5mm with integrated, self-locking and tool-free depth adjustment feature
- Mount on the front side of the cabinet or with an adapter plate

Tipmatic Pin



- Incl. Tipmatic mechanism:
 - Stick on strike plate
 - Screw on strike plate
- Hole drilled from the front
- Plastic RAL 7036, platinum grey

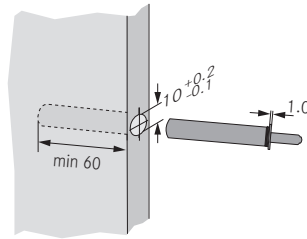

For Drilling

Item No.	PU
68873-06	25

Adapter Plate for Line Boring



- Suitable for line boring 28 and 37mm
- Attach with Euro screws (6.3 x 13.5)
- Plastic RAL 7035, light grey

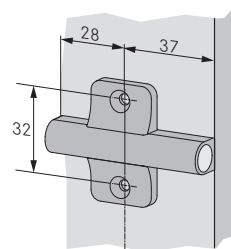

For Euro Screws

Item No.	PU
63310-40	25

Face Frame or Standard Adapter Plate



- Quick upgrade installation
- Attach with wood screws (3.5 x 13)
- Plastic RAL 7035, light grey

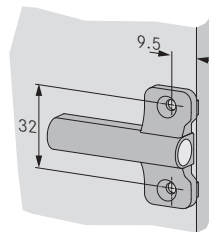

For Wood Screws

Item No.	PU
63311-40	25

Linear Adapter Plate



- Design solution – also suitable for inset door applications
- Attach with wood screws (3.5 x 13)
- Plastic RAL 7035, light grey

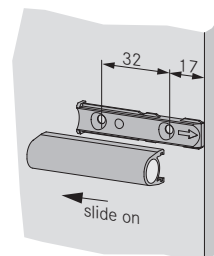

For Wood Screws

Item No.	PU
63309-40	25

Soft-close Damper Set

Zargen and Integra

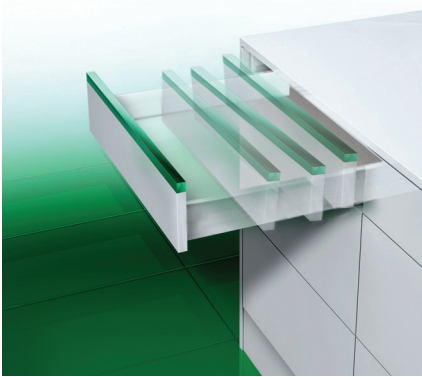

- Add-on damper creates a smooth soft-close action
- Liquid closing mechanism for improved performance
- Three options for various load capacities
- Actuator design allows for flush mounting
- Set includes: damper and actuator unit

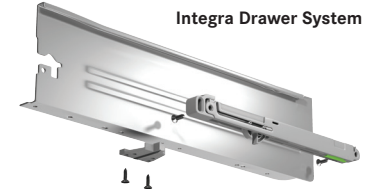
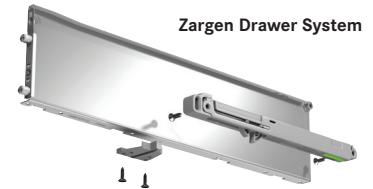

Damper set does not include drawer box

Soft-close Damper

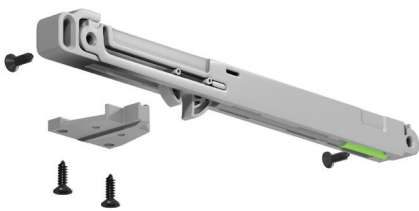

Description	Load Capacity	Item No.	PU
15 kg Damper set	33 lb	02564-11	140
30 kg Damper set	66 lb	02572-11	140
70 kg Damper set	154 lb	02565-11	140

Note: Damper sets do not include screws.

Sensomatic

For Dynapro and Vionaro

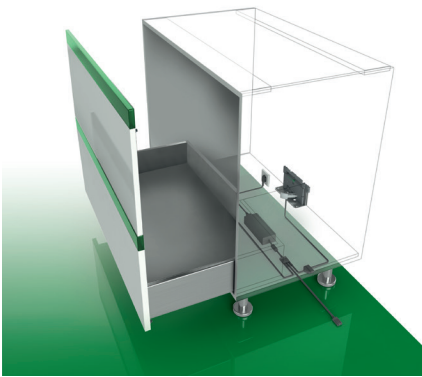

- Sensomatic works with any Dynapro or Vionaro drawer system
- Activated by a light touch anywhere on the drawer front
- One drive unit for cabinet widths up to 47" (1200 mm)
- Full extension for maximum access to drawer contents
- Soft-closing action pulls the drawer closed

Sensomatic Kit



Set consists of:

- 1 - Opening unit
- 1 - Base frame
- 1 - Power supply unit
- 1 - Power cord
- 4 - Front Bumpers

(F121100294223)

Description	Item No.	PU
Sensomatic Kit	F121100697201	1

PU - Packaging unit

Cover Caps



Hole covers for 35mm cup drillings

Description	Item No.	PU
35mm cover cap, white	22227-42	100
35mm cover cap, almond	22228-42	100
35mm cover cap, brown	22229-42	100

Drawer Front Adjuster

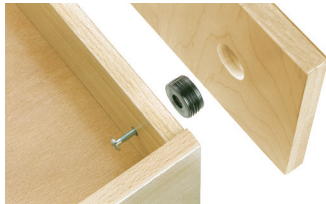

For precise drawer front alignment

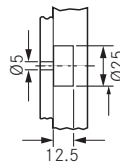

Description	Item No.	PU
Plastic, black	351.002.01.2662	200

Includes 4 x 22mm screw

Door Protectors for Pull-outs



Protects door when insets are pulled out. Attached to the bottom of the pull-out.



Description	Item No.	PU
6197 Protector, left	88094-09	100
6197 Protector, right	88095-09	100

Door/Drawer Protector

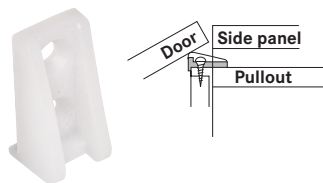

Attaches to side of wooden pull-out. Designed for inset pull-out trays for frame or frameless cabinetry.

Description	Item No.	PU
Door/drawer protector	13096-43	500

Inset Bracket Set



- For face frame inset applications with Dynapro
- Works with all inset applications
- Bracket mounts behind the face frame, minimum 12.7mm (1/2") frame offset required
- Slide attaches easily with one screw
- Includes guide markings for proper setback



Description	Item No.	PU
Inset bracket set	13901-37	1
Inset bracket set	13901-08	50

Polybag set consists of:

- 2 - Universal Inset Bracket ABS Brown
- 2 - 8 X 32 Tapped Insert for Inset bracket
- 4 - #7 X 2" mounting screws
- 2 - #8 - 32 X 1/2" Machine Screw FHP
- 1 - Instructions

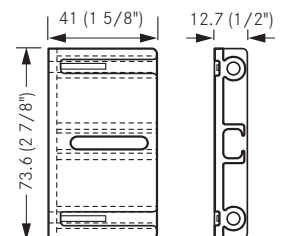

Assembly Hardware

Shelf Supports



Description	Item No.	PU
Plastic, clear, with steel pin	499.582.50.0050	5000
Metal spoon, nickel plated	499.582.50.2050	2000
Shelf support 7006/9.5, nickel	517.206.64.1015	2500
Shelf support 7035, nickel	517.206.61.0015	2500
H-802 plastic, square, clear	00036-43	500

Bumper Pads

Bumper Pads, Self-adhesive



Description	Height	Diameter	Item No.	PU
Bumper pad, clear	2.5mm	10mm	63407-99	288
Bumper pad, clear	2.5mm	10mm	63407-47	7200

AirSoft Bumper Pads, Self-adhesive



Description	Height	Diameter	Item No.	PU
AirSoft Bumper pad, clear	5mm	12.7mm	63481-43	500
AirSoft Bumper pad, clear	5mm	12.7mm	63483-30	5000

Bumper Pads, Self-adhesive



Description	Height	Diameter	Item No.	PU
Bumper pad, clear	1.5mm	7mm	630.000.03.0750	1088
Bumper pad, clear	2mm	10mm	630.000.03.1050	1050
Bumper pad, clear	4mm	12mm	630.000.02.1250	5000

Bumper Pads, Self-adhesive



Description	Height	Diameter	Item No.	PU
Bumper pad, clear	3mm	12.7mm	31002-43	500
Bumper pad, clear	1.5mm	12.7mm	31004-43	500

Door Stop



Description	Item No.	PU
H-950 door stop, clear	00068-43	500

PU - Packaging unit

Screws and Dowels

Euro Screw, Nickel-plated

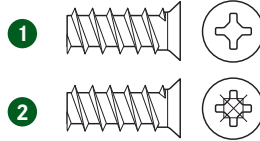

Description	Item No.	PU
1 13mm Euro Screw (1/2")	81015-43	500
18mm Euro Screw (11/16")	83000-43	500
7.5mm Euro Screw (5/16")	83001-43	500
2 Euro Screw 11mm (7/16") Pozi	499.360.61.1015	500
Euro Screw 13mm (1/2") Pozi	499.360.61.3015	500

Wood Screw, Nickel-plated

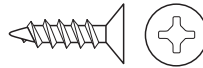

Description	Item No.	PU
#6 x 1/2" FHP, NI	81014-43	500
#6 x 5/8" FHP, NI	81001-43	500
#6 x 3/4" FHP, NI	81003-43	500
#6 x 1" FHP, NI	81004-43	500

Wood Screw, Nickel-plated

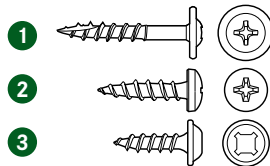

Description	Item No.	PU
1 #8 x 1 1/8" Truss Head	81012-43	500
2 #10 x 3/4" PHP	81007-43	500
3 #8 x 5/8" Quad Round	81017-43	500

Dowels, Plastic

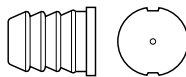

Description		Item No.	PU
Dowel, TEC Hinge	8mm	00102-43	500
Spax screw for TEC Hinge Dowel		02445-43	500
Dowel, Nexis	8mm	522.000.31.9750	500
Dowel, Tiomos	8mm	F072135773247	1000
Dowel, VZ Hinge Cup	8mm	04885-43	500
Dowel, Zargen / ZBox	10mm	05853-42	100
Dowel and screw set Zargen	10mm	12768-37	1
Dowel, base plate	10mm	05404-43	500
Dowel, pilaster dowel	8mm x 16mm	00395-43	500

Pozidrive Screwdriver



#2 Pozidrive screwdriver for hinges

Description	Item No.	PU
Pozidrive screwdriver	98000-01	1
Pozidrive screwdriver	98000-08	50

PU - Packaging unit

Assembly Aids

Drilling Template for Elite Plus and Maxcess



- Use to precisely bore holes in the drawer back
- Use with a standard 1/4" (6mm) drill bit and stop collar
- For use with Maxcess and Elite Plus

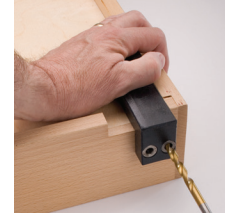

Left Side Drilling

Right Side Drilling

Description	Item No.	PU
Drilling template	02511-01	1

Punching Tool for Vionaro Front Stabilizer



Description	Item No.	PU
Front stabilizer punching tool	F146116216299	1

Vionaro Front Adapter Tool



Description	Item No.	PU
Vionaro front adapter tool	F146116213299	1

Punching Tool for Vionaro Bottom Spike



Description	Item No.	PU
Bottom spike punching tool	F146116217299	1

Hand Insertion Tool for TEC



Description	Item No.	PU
TEC Hand insertion tool	03987-01	1

Centering Drill Bit Ø 2.5mm



The GRASS centering drill bit is used for pre-drilling countersink wood screws, Ø 2.5mm

Description	Item No.	PU
Centering drill bit	35692-01	1

PU - Packaging unit

Grass PRO1 drilling and insertion machine for 45mm boring pattern

Grass PRO1 for Hinge Drilling



- Depth stop can be adjusted to material thickness
- Functional design
- Easy, fast and efficient operation
- Easy maintenance
- 45mm boring pattern

Description	Item No.	PU
220v single phase pneumatic	94559-01	1
220v three phase pneumatic	94560-01	1
110v single phase pneumatic	94561-01	1



Description	Item No.	PU
Extension fence 300mm to 1250mm	88612-01	1

Drill Bits

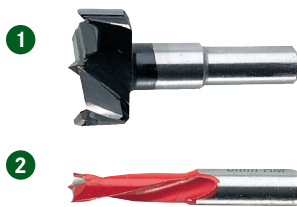

Description	Direction	Item No.	PU
1 35mm bit	RH	00077-01	1
2 8mm bit	LH	00160-01	1
American Bit Set for Hinge Drilling		00213-01	1

Set consists of:

- 1 - 35mm bit, RH
- 2 - 8mm bit, LH

Fence Stops

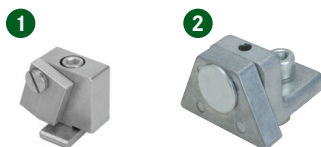

Description	Item No.	PU
1 Additional fence stop	949.200.21.0000	1
2 Additional fence stop, large	949.200.21.0100	1

Insertion Dies

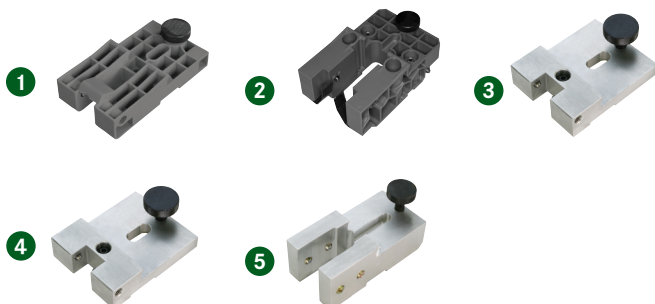

Description	Item No.	PU
1 Tiomos 110°/120°	F146101310201	1
2 Universal die for Tiomos 110°/120°/160°	F146101308201	1
3 TEC Die for all cup styles	92617	1
4 Nexis 110°/125°	04216-01	1
5 Nexis 170°	04218-01	1

PU - Packaging unit

Machinery

Grass PRO1 and ZRam for Zargen & ZBox Assembly

Grass PRO1 for Zargen and ZBox



- Depth stop can be adjusted to material thickness
- Functional design
- Easy, fast and efficient operation
- Easy maintenance
- 3 spindle gear box

Description	Item No.	PU
220v single phase pneumatic	80131	1
220v three phase pneumatic	80132	1
110v single phase pneumatic	80068	1



Description	Item No.	PU
Extension fence 300mm to 1250mm	88612-01	1

Zargen & ZBox Conversion Kit

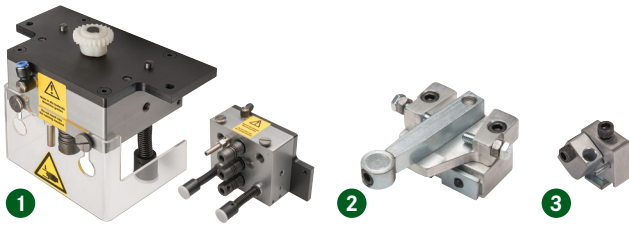

Description	Item No.	PU
1 PRO1 Gear box	80151	1
2 PRO1 Side-to-side Stop	80153	1
3 PRO1 13mm Fence Stop	80152	1
4 PRO1 Kit (gear box, fence and side stops)	80154	1

Bits

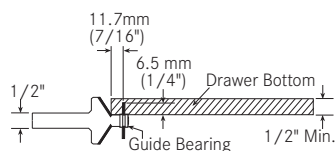
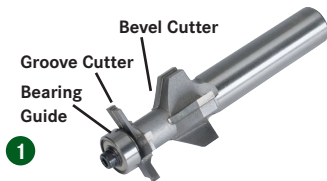

This bit is designed for grooving and beveling the drawer bottoms for the lipped version of the ZBox and Zargen drawer slide. The bit comes only with a 1/2" shank.



Two 00222-01 bits are needed for the Zargen & ZBox Grass PRO1 setup.

Description	Item No.	PU
1 Router bit	00197-01	1
2 10mm Carbide counter sink drill bit, LH	00222-01	1

ZRam

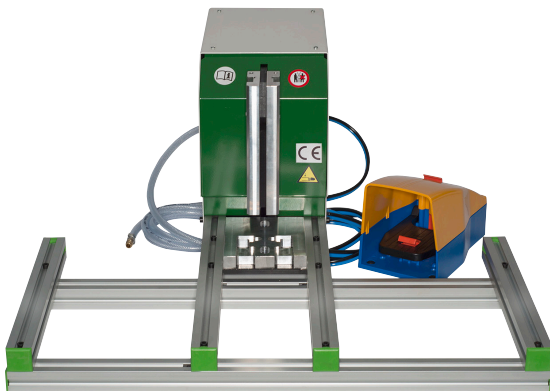

- Designed for semi-automated assembly of ZBox and Zargen slides
- Operated by a foot pedal – air required
- No adjustment required when using various heights or when switching slide types
- Economical solution for drawer assembly

Description	Item No.	PU
ZRam	93250-01	1
ZRam Retrofit Kit	69401	1

PU - Packaging unit

Machinery & Assembly Aids

Grass PRO1 and Tecmator for Vionaro

Grass PRO1 for Vionaro



- Depth stop can be adjusted to material thickness
- Functional design
- Easy, fast and efficient operation
- Easy maintenance
- 3 spindle gear box

Description	Item No.	PU
220v single phase pneumatic	80063	1
220v three phase pneumatic	80064	1
110v single phase pneumatic	80065	1



Description	Item No.	PU
Extension fence 300mm to 1250mm	88612-01	1

Drill Bits

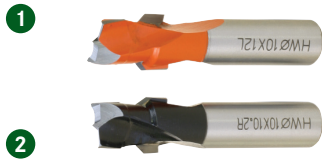

Description	Direction	Item No.	PU
1 10mm Carbide counter sink bit	LH	00222-01	1
2 10mm Carbide counter sink bit	RH	00229-01	1

Insertion Die



Description	Item No.	PU
Vionaro insertion die	30683-01	1

Tecmator

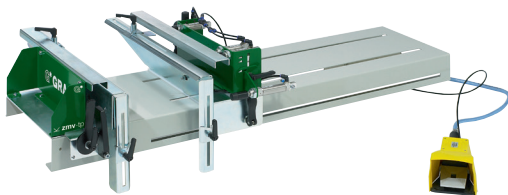

Note: Product lead time approximately 14 weeks

- Pneumatic table-top device for Vionaro
- The ZMV-TP can be used to assemble drawers for external cabinet widths of up to 1200mm
- Easy and straightforward handling
- Sturdy construction
- For small series production
- Pneumatic control system
- High performance

Description	Item No.	PU
Tecmator ZMV-TP2 1200	F146116212299	1



GRASS America Inc.
1202 NC Highway 66 South
Kernersville, NC 27284

Phone: 1-800-334-3512
Fax: 1-800-525-8406

Website: www.grassusa.com
E-mail: info@grassusa.com

GRASS Canada Inc.
10 Newgale Gate, Unit 7
Toronto, ON M1X 1C5

Phone: 1-800-461-4975
Fax: 1-416-335-5907

Internet: www.grasscanada.com
E-Mail: info@grasscanada.com



www.grassusa.com